



FCC TEST REPORT (15.407)

REPORT NO.: RF130328E02-1

MODEL NO.: TEW-751DR

FCC ID: XU8TEW751DR2

RECEIVED: Mar. 28, 2013

TESTED: Apr. 08 to 11, 2013

ISSUED: June 06, 2013

APPLICANT: TRENDnet, Inc

ADDRESS: 20675 Manhattan Place, Torrance, CA
90501 U.S.A.

ISSUED BY: Bureau Veritas Consumer Products Services
(H.K.) Ltd., Taoyuan Branch Hsin Chu Laboratory

LAB ADDRESS : No. 81-1, Lu Liao Keng, 9th Ling, Wu Lung Tsuen,
Chiung Lin Hsiang, Hsin Chu Hsien 307, Taiwan,
R.O.C.

TEST LOCATION (1): No. 81-1, Lu Liao Keng, 9th Ling, Wu Lung Tsuen,
Chiung Lin Hsiang, Hsin Chu Hsien 307, Taiwan,
R.O.C.

TEST LOCATION (2): No. 49, Ln. 206, Wende Rd., Shangshan Tsuen,
Chiung Lin Hsiang, Hsin Chu Hsien 307, Taiwan,
R.O.C.

This report should not be used by the client to claim product certification, approval, or endorsement by TAF or any government agencies.



This report is for your exclusive use. Any copying or replication of this report to or for any other person or entity, or use of our name or trademark, is permitted only with our prior written permission. This report sets forth our findings solely with respect to the test samples identified herein. The results set forth in this report are not indicative or representative of the quality or characteristics of the lot from which a test sample was taken or any similar or identical product unless specifically and expressly noted. Our report includes all of the tests requested by you and the results thereof based upon the information that you provided to us. You have 60 days from date of issuance of this report to notify us of any material error or omission caused by our negligence, provided, however, that such notice shall be in writing and shall specifically address the issue you wish to raise. A failure to raise such issue within the prescribed time shall constitute your unqualified acceptance of the completeness of this report, the tests conducted and the correctness of the report contents. Unless specific mention, the uncertainty of measurement has been explicitly taken into account to declare the compliance or non-compliance to the specification



A D T

Table of Contents

RELEASE CONTROL RECORD.....	4
1. CERTIFICATION.....	5
2. SUMMARY OF TEST RESULTS.....	6
2.1 MEASUREMENT UNCERTAINTY	7
3. GENERAL INFORMATION	8
3.1 GENERAL DESCRIPTION OF EUT.....	8
3.2 DESCRIPTION OF TEST MODES.....	11
3.2.1 TEST MODE APPLICABILITY AND TESTED CHANNEL DETAIL	12
3.3 GENERAL DESCRIPTION OF APPLIED STANDARDS	14
3.4 DUTY CYCLE OF TEST SIGNAL.....	15
3.5 DESCRIPTION OF SUPPORT UNITS.....	16
3.6 CONFIGURATION OF SYSTEM UNDER TEST	17
4. TEST TYPES AND RESULTS.....	18
4.1 CONDUCTED EMISSION MEASUREMENT	18
4.1.1 LIMITS OF CONDUCTED EMISSION MEASUREMENT.....	18
4.1.2 TEST INSTRUMENTS	18
4.1.3 TEST PROCEDURES.....	19
4.1.4 DEVIATION FROM TEST STANDARD	19
4.1.5 TEST SETUP	19
4.1.6 EUT OPERATING CONDITIONS.....	20
4.1.7 TEST RESULTS.....	21
4.2 RADIATED EMISSION AND BANDEDGE MEASUREMENT.....	25
4.2.1 LIMITS OF RADIATED EMISSION AND BANDEDGE MEASUREMENT	25
4.2.2 LIMITS OF UNWANTED EMISSION OUT OF THE RESTRICTED BANDS.....	25
4.2.3 TEST INSTRUMENTS	26
4.2.4 TEST PROCEDURES.....	27
4.2.5 DEVIATION FROM TEST STANDARD	27
4.2.6 TEST SETUP	28
4.2.7 EUT OPERATING CONDITION	28
4.2.8 TEST RESULTS.....	29
4.3 TRANSMIT POWER MEASUREMENT.....	38
4.3.1 LIMITS OF TRANSMIT POWER MEASUREMENT	38
4.3.2 TEST INSTRUMENTS	38
4.3.3 TEST PROCEDURE	39
4.3.4 DEVIATION FROM TEST STANDARD	39
4.3.5 TEST SETUP	39
4.3.6 EUT OPERATING CONDITIONS.....	40
4.3.7 TEST RESULTS.....	41
4.4 PEAK POWER SPECTRAL DENSITY MEASUREMENT	43
4.4.1 LIMITS OF PEAK POWER SPECTRAL DENSITY MEASUREMENT	43
4.4.2 TEST INSTRUMENTS	43
4.4.3 TEST PROCEDURES.....	43
4.4.4 DEVIATION FROM TEST STANDARD	43



A D T

4.4.5	TEST SETUP	43
4.4.6	EUT OPERATING CONDITIONS	44
4.4.7	TEST RESULTS	45
4.5	PEAK POWER EXCURSION MEASUREMENT	46
4.5.1	LIMITS OF PEAK POWER EXCURSION MEASUREMENT	46
4.5.2	TEST INSTRUMENTS	46
4.5.3	TEST PROCEDURE	46
4.5.4	DEVIATION FROM TEST STANDARD	46
4.5.5	TEST SETUP	46
4.5.6	EUT OPERATING CONDITIONS	46
4.5.7	TEST RESULTS	47
4.6	FREQUENCY STABILITY	48
4.6.1	LIMITS OF FREQUENCY STABILITY MEASUREMENT	48
4.6.2	TEST INSTRUMENTS	48
4.6.3	TEST PROCEDURE	48
4.6.4	DEVIATION FROM TEST STANDARD	49
4.6.5	TEST SETUP	49
4.6.6	EUT OPERATING CONDITION	49
4.6.7	TEST RESULTS	50
5.	PHOTOGRAPHS OF THE TEST CONFIGURATION.....	51
6.	INFORMATION ON THE TESTING LABORATORIES	52
7.	APPENDIX A - MODIFICATIONS RECORDERS FOR ENGINEERING CHANGES TO THE EUT BY THE LAB	53



A D T

RELEASE CONTROL RECORD

ISSUE NO.	REASON FOR CHANGE	DATE ISSUED
RF130328E02-1	Original release	June 06, 2013



A D T

1. CERTIFICATION

PRODUCT: N600 Dual Band Wireless Router
BRAND NAME: TRENDnet
MODEL NO.: TEW-751DR
TEST SAMPLE: ENGINEERING SAMPLE
APPLICANT: TRENDnet, Inc
TESTED: Apr. 08 to 11, 2013
STANDARDS: FCC Part 15, Subpart E (Section 15.407)
ANSI C63.10-2009

The above equipment (Model: TEW-751DR) has been tested by **Bureau Veritas Consumer Products Services (H.K.) Ltd., Taoyuan Branch**, and found compliance with the requirement of the above standards. The test record, data evaluation & Equipment Under Test (EUT) configurations represented herein are true and accurate accounts of the measurements of the sample's EMC characteristics under the conditions specified in this report.

PREPARED BY :  , **DATE:** June 06, 2013
(Elsie Hsu, Specialist)

APPROVED BY :  , **DATE:** June 06, 2013
(May Chen, Manager)



A D T

2. SUMMARY OF TEST RESULTS

The EUT has been tested according to the following specifications:

For 5GHz, 5150~5250MHz

APPLIED STANDARD: FCC PART 15, SUBPART E (SECTION 15.407)			
STANDARD SECTION	TEST TYPE	RESULT	REMARK
15.407(b)(6)	AC Power Conducted Emission	PASS	Meet the requirement of limit. Minimum passing margin is -8.02dB at 4.65625MHz
15.407(b/1/2/3) (b)(5)	Spurious Emissions	PASS	Meet the requirement of limit. Minimum passing margin is -0.7dB at 5150.00MHz.
15.407(a/1/2/3)	Transmit Power	PASS	Meet the requirement of limit.
15.407(a)(6)	Peak Power Excursion	PASS	Meet the requirement of limit.
15.407(a/1/2/3)	Peak Power Spectral Density	PASS	Meet the requirement of limit.
15.407(g)	Frequency Stability	PASS	Meet the requirement of limit.
15.203	Antenna Requirement	PASS	Antenna connectors is I-PEX not a standard connector.

NOTE: The EUT was operating in 2.400 ~ 2.4835GHz, 5.15~5.25GHz and 5.725~5.850GHz frequencies band. This report was recorded the RF parameters including 5.15~5.25GHz. For the 2.400 ~ 2.4835GHz and 5.725~5.850GHz RF parameters was recorded in another test report.



A D T

2.1 MEASUREMENT UNCERTAINTY

Where relevant, the following measurement uncertainty levels have been estimated for tests performed on the EUT as specified in CISPR 16-4-2:

This uncertainty represents an expanded uncertainty expressed at approximately the 95% confidence level using a coverage factor of $k=2$.

Measurement	Value
Conducted emissions	2.98 dB
Radiated emissions (30MHz-1GHz)	5.59 dB
Radiated emissions (1GHz -6GHz)	3.73 dB
Radiated emissions (6GHz -18GHz)	3.90 dB
Radiated emissions (18GHz -40GHz)	4.11 dB



A D T

3. GENERAL INFORMATION

3.1 GENERAL DESCRIPTION OF EUT

PRODUCT	N600 Dual Band Wireless Router
MODEL NO.	TEW-751DR
POWER SUPPLY	DC 12V from power adapter
MODULATION TYPE	CCK, DQPSK, DBPSK for DSSS 64QAM, 16QAM, QPSK, BPSK for OFDM
MODULATION TECHNOLOGY	DSSS,OFDM
TRANSFER RATE	802.11b: up to 11Mbps 802.11a / g: up to 54Mbps 802.11n: up to 300Mbps
OPERATING FREQUENCY	For 15.407 802.11a/n: 5.18 ~ 5.24GHz
	For 15.247 802.11b/g/n: 2.412 ~ 2.462GHz 802.11a/n: 5.745 ~ 5.825GHz
NUMBER OF CHANNEL	For 15.407 4 for 802.11a, 802.11n (HT20) 2 for 802.11n (HT40)
	For 15.247 (2.4GHz) 11 for 802.11b, 802.11g, 802.11n (HT20) 7 for 802.11n (HT40)
	For 15.247 (5GHz) 5 for 802.11a, 802.11n (HT20) 2 for 802.11n (HT40)



MAXIMUM OUTPUT POWER	<p>For 15.407 802.11a: 37.931mW 802.11n (HT20): 30.729mW 802.11n (HT40): 43.860mW</p> <p>For 15.247 (2.4GHz) 802.11b: 188.799mW 802.11g: 268.534mW 802.11n (HT20): 475.999mW 802.11n (HT40): 274.533mW</p> <p>For 15.247 (5GHz) 802.11a: 359.749mW 802.11n (HT20): 700.492mW 802.11n (HT40): 654.822mW</p>
ANTENNA TYPE	Please see NOTE
DATA CABLE	NA
I/O PORTS	Refer to user's manual
ASSOCIATED DEVICES	Adapter x 1

NOTE:

1. The EUT must be supplied with a power adapter and following two different model names could be chosen:

No.	Brand	Model No.	Spec.
1	LEI	MU12AB120100-A1	Input: 100-240V, 0.4A, 50-60Hz Output: 12V, 1A DC output cable(1.2m, unshielded)
2	AMIGO	AMS9-1201000FC2	Input: 100-240V, 0.5A, 50-60Hz Output: 12V, 1A DC output cable(1.2m, unshielded)

2. The EUT was pre-tested for radiated test under following test modes:

Pre-test Mode	Power
Mode A	With adapter 1
Mode B	With adapter 2

From the above modes, the worst radiated test was found in **Mode B**. Therefore only the test data of the mode was recorded in this report.



A D T

3. The antennas provided to the EUT, please refer to the following table:

For 2.4GHz								
Transmitter Circuit	Brand	Model name	Gain (dBi) Include cable loss	Antenna Type	Connector	Frequency range (MHz to MHz)	Cable Loss (dB)	Cable Length (cm)
Chain (0)	NA	NA	0.02	printing	NA	2400~2500	NA	NA
Chain (1)	NA	NA	1.12	printing	NA	2400~2500	NA	NA
For 5GHz								
Transmitter Circuit	Brand	Model name	Gain (dBi) Include cable loss	Antenna Type	Connector	Frequency range (MHz to MHz)	Cable Loss (dB)	Cable Length (cm)
Chain (0)	MAG.LAYERS	PCA-2010-5G0C1-A8	4.86	FR4 assembly	I-PEX	5150~5850	0.21	6.35
Chain (1)	MAG.LAYERS	PCA-2010-5G0C1-A7	4.55	FR4 assembly	I-PEX	5150~5850	0.26	7.75

Note: For 802.11abg mode will fix transmission on Chain (0).

4. The EUT incorporates a MIMO function without beam forming.

MODULATION MODE	TX/RX FUNCTION
802.11a	1TX/1RX
802.11b	1TX/1RX
802.11g	1TX/1RX
802.11n (HT20)	2TX/2RX
802.11n (HT40)	2TX/2RX

- Spurious emission of the simultaneous operation (2.4GHz & 5GHz) has been evaluated and no non-compliance was found.
- When the EUT operating in 802.11n, the software operation, which is defined by manufacturer, MCS (Modulation and Coding Schemes) from 0 to 15.
- The above EUT information was declared by the manufacturer and for more detailed features description, please refer to the manufacturer's specifications or User's Manual.



A D T

3.2 DESCRIPTION OF TEST MODES

Operated in 5150 ~ 5250MHz band:

4 channels are provided for 802.11a, 802.11n (HT20):

CHANNEL	FREQUENCY
36	5180 MHz
40	5200 MHz
44	5220 MHz
48	5240 MHz

2 channels are provided for 802.11n (HT40):

CHANNEL	FREQUENCY
38	5190 MHz
46	5230 MHz

3.2.1 TEST MODE APPLICABILITY AND TESTED CHANNEL DETAIL

EUT CONFIGURE MODE	APPLICABLE TO				DESCRIPTION
	PLC	RE < 1G	RE ≥ 1G	APCM	
1	√	√	√	√	With power adapter 2
2	√	-	-	-	With power adapter 1

Where **PLC**: Power Line Conducted Emission **RE < 1G**: Radiated Emission below 1GHz
RE ≥ 1G: Radiated Emission above 1GHz **APCM**: Antenna Port Conducted Measurement

POWER LINE CONDUCTED EMISSION TEST:

- Pre-Scan has been conducted to determine the worst-case mode from all possible combinations between available modulations, data rates and antenna ports (if EUT with antenna diversity architecture).
- Following channel(s) was (were) selected for the final test as listed below.

MODE	AVAILABLE CHANNEL	TESTED CHANNEL	MODULATION TECHNOLOGY	MODULATION TYPE	DATA RATE (MBPS)
802.11a	36 to 48	48	OFDM	BPSK	6

RADIATED EMISSION TEST (BELOW 1 GHz):

- Pre-Scan has been conducted to determine the worst-case mode from all possible combinations between available modulations, data rates and antenna ports (if EUT with antenna diversity architecture).
- Following channel(s) was (were) selected for the final test as listed below.

MODE	AVAILABLE CHANNEL	TESTED CHANNEL	MODULATION TECHNOLOGY	MODULATION TYPE	DATA RATE (Mbps)
802.11a	36 to 48	48	OFDM	BPSK	6

RADIATED EMISSION TEST (ABOVE 1 GHz):

- Pre-Scan has been conducted to determine the worst-case mode from all possible combinations between available modulations, data rates and antenna ports (if EUT with antenna diversity architecture).
- Following channel(s) was (were) selected for the final test as listed below.

MODE	AVAILABLE CHANNEL	TESTED CHANNEL	MODULATION TECHNOLOGY	MODULATION TYPE	DATA RATE (Mbps)
802.11a	36 to 48	36, 40, 48	OFDM	BPSK	6
802.11n (HT20)	36 to 48	36, 40, 48	OFDM	BPSK	6.5
802.11n (HT40)	38 to 46	38, 46	OFDM	BPSK	13.5

ANTENNA PORT CONDUCTED MEASUREMENT:

- Pre-Scan has been conducted to determine the worst-case mode from all possible combinations between available modulations, data rates and antenna ports (if EUT with antenna diversity architecture).
- Following channel(s) was (were) selected for the final test as listed below.

MODE	AVAILABLE CHANNEL	TESTED CHANNEL	MODULATION TECHNOLOGY	MODULATION TYPE	DATA RATE (Mbps)
802.11a	36 to 48	36, 40, 48	OFDM	BPSK	6
802.11n (HT20)	36 to 48	36, 40, 48	OFDM	BPSK	6.5
802.11n (HT40)	38 to 46	38, 46	OFDM	BPSK	13.5

TEST CONDITION:

APPLICABLE TO	ENVIRONMENTAL CONDITIONS	INPUT POWER	TESTED BY
PLC	24deg. C, 66%RH	120Vac, 60Hz	Gavin Peng
RE<1G	24deg. C, 67%RH	120Vac, 60Hz	Robert Cheng
RE ³ 1G	25deg. C, 69%RH	120Vac, 60Hz	Robert Cheng
APCM	25deg. C, 60%RH	120Vac, 60Hz	James Chan

3.3 GENERAL DESCRIPTION OF APPLIED STANDARDS

The EUT is a RF product. According to the specifications of the manufacturer, it must comply with the requirements of the following standards:

FCC Part 15, Subpart E (15.407)

789033 D01 General UNII Test Procedures v01 r03

662911 D01 Multiple Transmitter Output v01 r02

ANSI C63.10-2009

All test items have been performed and recorded as per the above standards.

Note: The EUT has been verified to comply with the requirements of FCC Part 15, Subpart B, Class B (DoC). The test report has been issued separately.



A D T

3.4 DUTY CYCLE OF TEST SIGNAL

Duty cycle of test signal is 100 %, duty factor is not required.

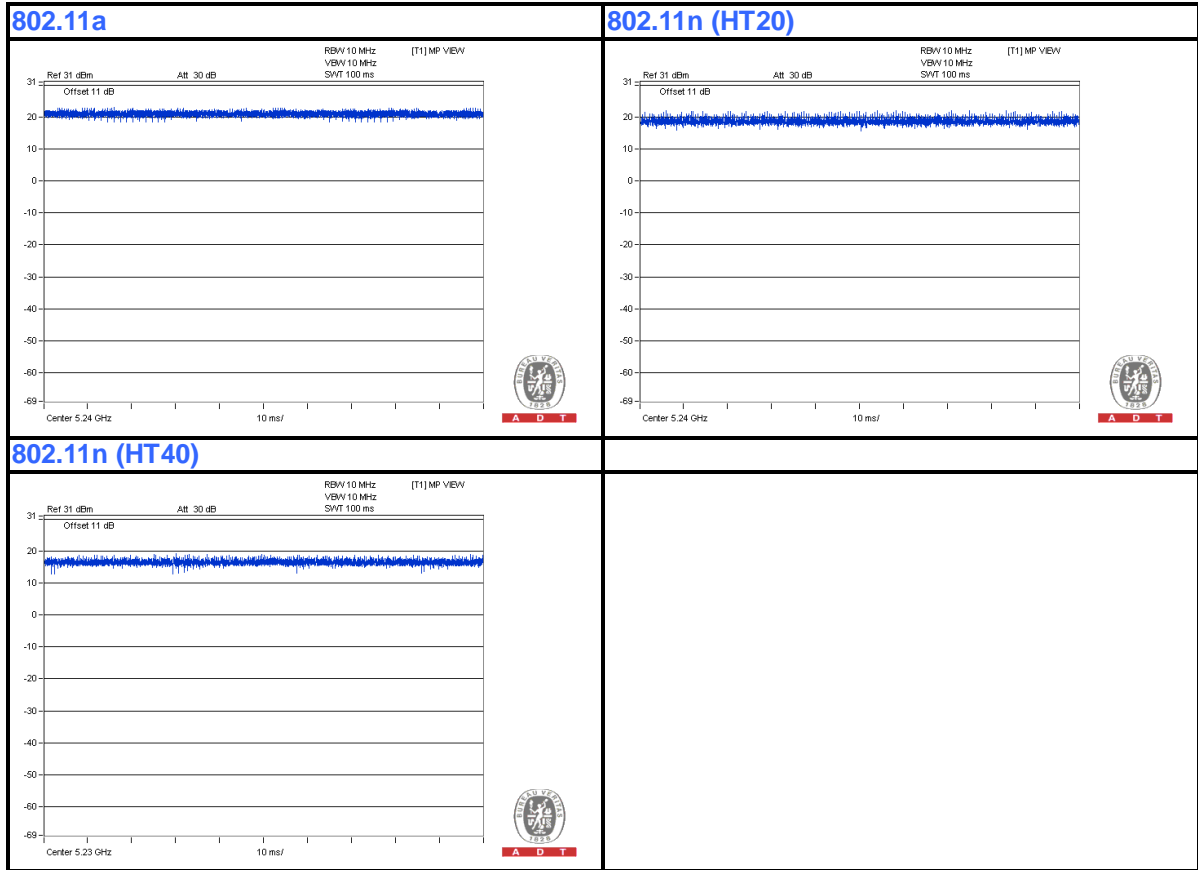



A D T

3.5 DESCRIPTION OF SUPPORT UNITS

The EUT has been tested as an independent unit together with other necessary accessories or support units. The following support units or accessories were used to form a representative test configuration during the tests.

NO.	PRODUCT	BRAND	MODEL NO.	SERIAL NO.	FCC ID
1	NOTEBOOK COMPUTER	DELL	PP32LA	FSLB32S	FCC DoC
2	NOTEBOOK COMPUTER	DELL	PP32LA	GSLB32S	FCC DoC
3	HUB	ZyXEL	ES-116P	S060H02000215	FCC DoC

NO.	SIGNAL CABLE DESCRIPTION OF THE ABOVE SUPPORT UNITS
1	UTP cable (10m)
2	UTP cable (10m)
3	UTP cable (10m)

NOTE: All power cords of the above support units are non shielded (1.8m).

3.6 CONFIGURATION OF SYSTEM UNDER TEST

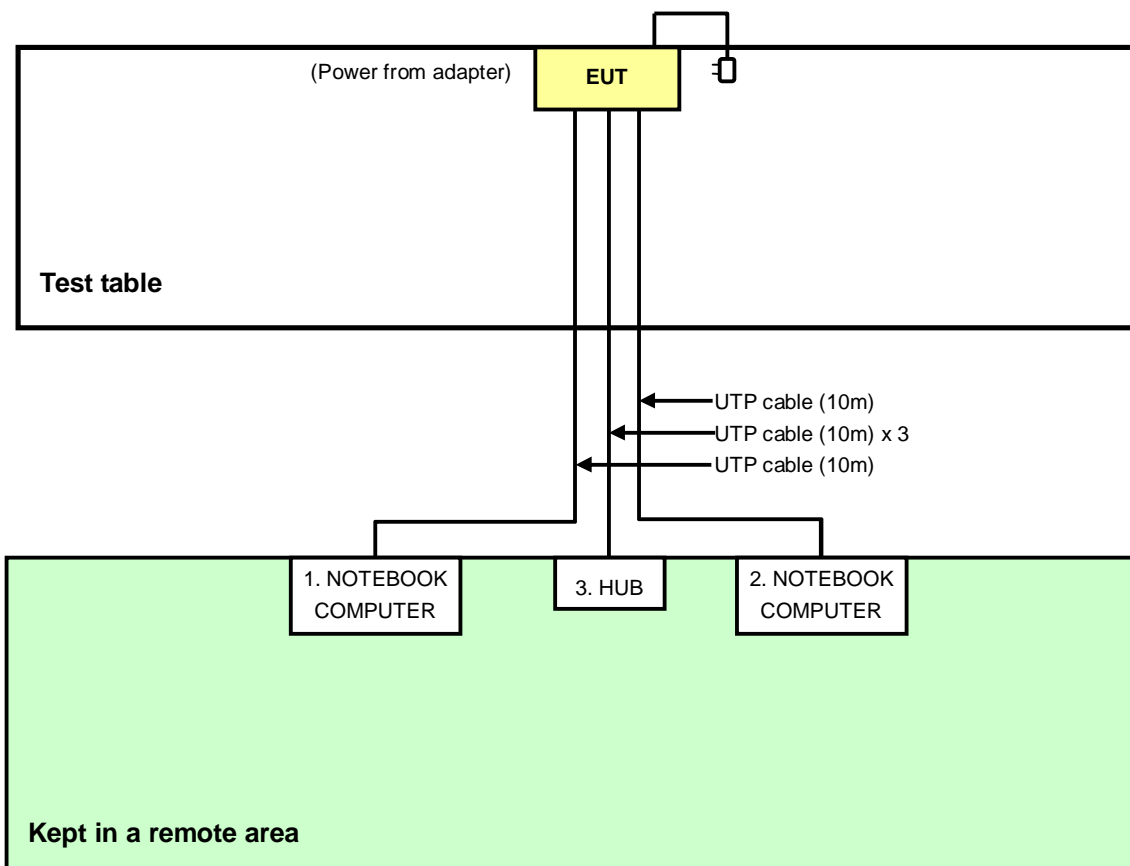



A D T

4. TEST TYPES AND RESULTS

4.1 CONDUCTED EMISSION MEASUREMENT

4.1.1 LIMITS OF CONDUCTED EMISSION MEASUREMENT

FREQUENCY OF EMISSION (MHz)	CONDUCTED LIMIT (dB μ V)	
	Quasi-peak	Average
0.15-0.5	66 to 56	56 to 46
0.5-5	56	46
5-30	60	50

- NOTE:**
1. The lower limit shall apply at the transition frequencies.
 2. The limit decreases in line with the logarithm of the frequency in the range of 0.15 to 0.50 MHz.

4.1.2 TEST INSTRUMENTS

DESCRIPTION & MANUFACTURER	MODEL NO.	SERIAL NO.	CALIBRATED DATE	CALIBRATED UNTIL
Test Receiver ROHDE & SCHWARZ	ESCS 30	100287	Feb. 28, 2013	Feb. 27, 2014
Line-Impedance Stabilization Network (for EUT) SCHWARZBECK	NSLK 8127	8127-523	Sep. 19, 2012	Sep. 20, 2013
Line-Impedance Stabilization Network (for Peripheral) ROHDE & SCHWARZ	ESH3-Z5	848773/004	Oct. 29, 2012	Oct. 28, 2013
RF Cable (JYEBAO)	5DFB	COACAB-002	Aug. 05, 2012	Aug. 04, 2013
50 ohms Terminator	50	3	Oct. 23, 2012	Oct. 22, 2013
Software ADT	BV ADT_Cond_V7.3.7 .3	NA	NA	NA

Note:

1. The calibration interval of the above test instruments is 12 months and the calibrations are traceable to NML/ROC and NIST/USA.
2. The test was performed in Shielded Room No. A.
3. The VCCI Con A Registration No. is C-817.
4. Tested Date: Apr. 08, 2013

4.1.3 TEST PROCEDURES

- a. The EUT was placed 0.4 meters from the conducting wall of the shielded room with EUT being connected to the power mains through a line impedance stabilization network (LISN). Other support units were connected to the power mains through another LISN.
- b. The two LISNs provide 50 ohm/ 50uH of coupling impedance for the measuring instrument.
- c. Both lines of the power mains connected to the EUT were checked for maximum conducted interference.
- d. The frequency range from 150kHz to 30MHz was searched. Emission level under (Limit – 20dB) was not recorded.

NOTE:

1. The resolution bandwidth of test receiver is 9kHz for Quasi-peak detection (QP) & Average detection (AV).

4.1.4 DEVIATION FROM TEST STANDARD

No deviation

4.1.5 TEST SETUP

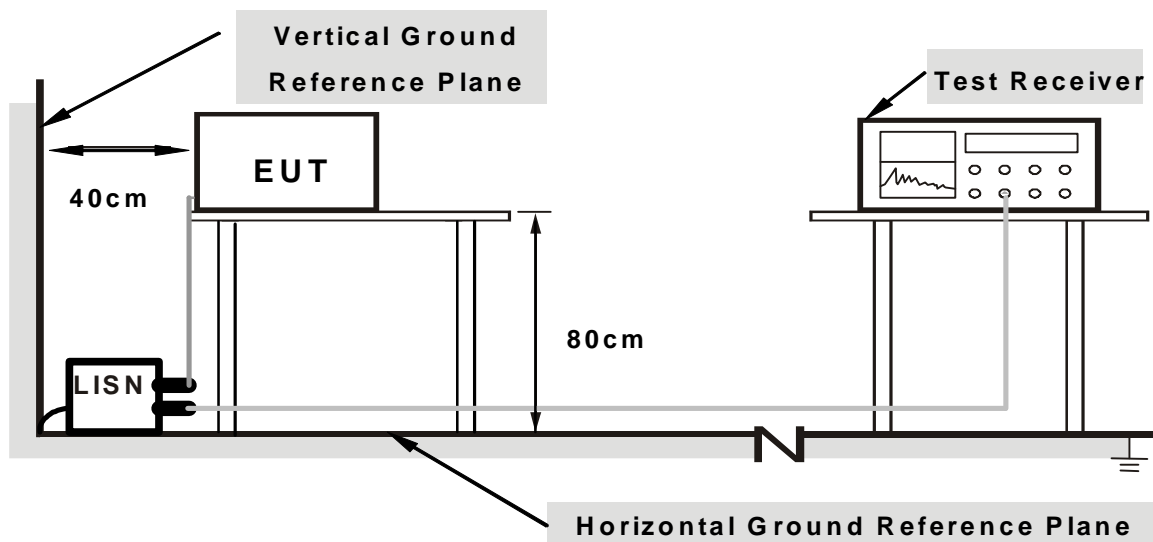

Note: 1.Support units were connected to second LISN.

For the actual test configuration, please refer to the related item – Photographs of the Test Configuration.



A D T

4.1.6 EUT OPERATING CONDITIONS

1. Turn on the power of EUT.
2. The communication partner run test program “MT7620QA.exe” to enable EUT under transmission/receiving condition continuously at specific channel frequency.

4.1.7 TEST RESULTS (MODE 1)

PHASE	Line (L)	DETECTOR FUNCTION	Quasi-Peak (QP) / Average (AV)
-------	----------	-------------------	--------------------------------

No	Freq. [MHz]	Corr. Factor (dB)	Reading Value [dB (uV)]		Emission Level [dB (uV)]		Limit [dB (uV)]		Margin (dB)	
			Q.P.	AV.	Q.P.	AV.	Q.P.	AV.	Q.P.	AV.
	1	0.15781	0.10	49.04	38.39	49.14	38.49	65.58	55.58	-16.44
2	0.18125	0.10	45.73	24.10	45.83	24.20	64.43	54.43	-18.59	-30.22
3	0.21641	0.11	45.38	33.02	45.49	33.13	62.96	52.96	-17.46	-19.82
4	0.26328	0.13	42.99	30.55	43.12	30.68	61.33	51.33	-18.21	-20.65
5	0.34141	0.15	40.91	16.14	41.06	16.29	59.17	49.17	-18.11	-32.88
6	0.40000	0.16	36.55	14.57	36.71	14.73	57.85	47.85	-21.14	-33.12
7	0.51328	0.16	38.40	15.29	38.56	15.45	56.00	46.00	-17.44	-30.55
8	0.61094	0.17	33.48	13.77	33.65	13.94	56.00	46.00	-22.35	-32.06
9	0.73594	0.17	34.01	13.93	34.18	14.10	56.00	46.00	-21.82	-31.90
10	2.93750	0.27	40.24	26.85	40.51	27.12	56.00	46.00	-15.49	-18.88
11	3.34375	0.29	36.57	21.97	36.86	22.26	56.00	46.00	-19.14	-23.74

REMARKS:

1. Q.P. and AV. are abbreviations of quasi-peak and average individually.
2. The emission levels of other frequencies were very low against the limit.
3. Margin value = Emission level - Limit value
4. Correction factor = Insertion loss + Cable loss
5. Emission Level = Correction Factor + Reading Value.

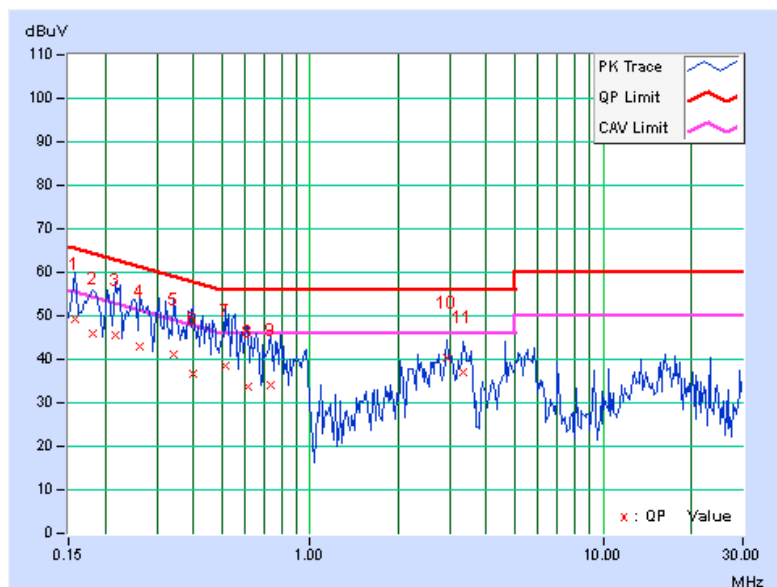

PHASE	Neutral (N)	DETECTOR FUNCTION	Quasi-Peak (QP) / Average (AV)
--------------	-------------	--------------------------	--------------------------------

No	Freq. [MHz]	Corr. Factor (dB)	Reading Value [dB (uV)]		Emission Level [dB (uV)]		Limit [dB (uV)]		Margin (dB)	
			Q.P.	AV.	Q.P.	AV.	Q.P.	AV.	Q.P.	AV.
	1	0.15781	0.15	46.36	37.09	46.51	37.24	65.58	55.58	-19.07
2	0.17344	0.15	46.85	25.41	47.00	25.56	64.79	54.79	-17.80	-29.24
3	0.23203	0.16	45.22	22.38	45.38	22.54	62.38	52.38	-17.00	-29.84
4	0.34141	0.18	39.94	13.97	40.12	14.15	59.17	49.17	-19.05	-35.02
5	0.37266	0.18	38.92	20.19	39.10	20.37	58.44	48.44	-19.34	-28.07
6	0.41953	0.19	37.83	25.10	38.02	25.29	57.46	47.46	-19.44	-22.17
7	0.46641	0.19	35.30	18.15	35.49	18.34	56.58	46.58	-21.08	-28.23
8	0.54844	0.20	36.55	11.77	36.75	11.97	56.00	46.00	-19.25	-34.03
9	0.75156	0.21	30.24	9.14	30.45	9.35	56.00	46.00	-25.55	-36.65

REMARKS:

1. Q.P. and AV. are abbreviations of quasi-peak and average individually.
2. The emission levels of other frequencies were very low against the limit.
3. Margin value = Emission level - Limit value
4. Correction factor = Insertion loss + Cable loss
5. Emission Level = Correction Factor + Reading Value.

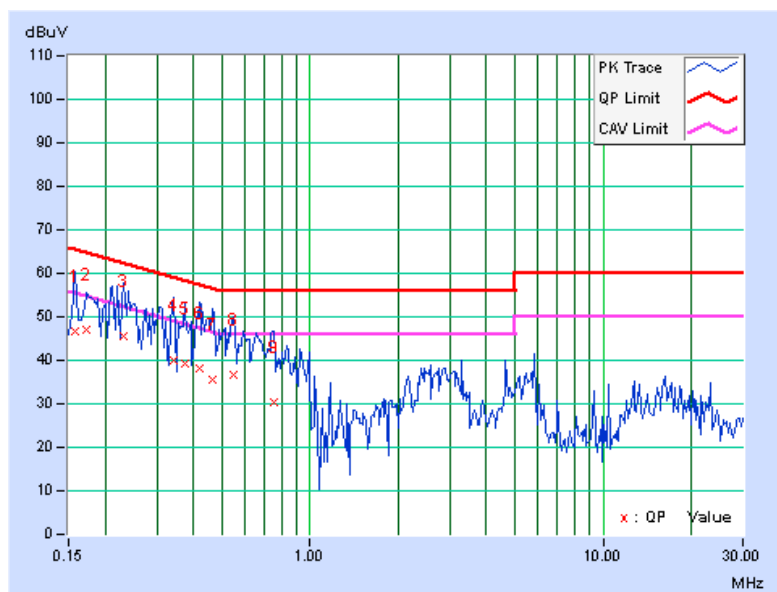

4.1.8 TEST RESULTS (MODE 2)

PHASE	Line (L)	DETECTOR FUNCTION	Quasi-Peak (QP) / Average (AV)
-------	----------	-------------------	--------------------------------

No	Freq. [MHz]	Corr. Factor (dB)	Reading Value [dB (uV)]		Emission Level [dB (uV)]		Limit [dB (uV)]		Margin (dB)	
			Q.P.	AV.	Q.P.	AV.	Q.P.	AV.	Q.P.	AV.
	1	0.18516	0.11	46.89	26.37	47.00	26.48	64.25	54.25	-17.26
2	0.24766	0.12	36.47	18.92	36.59	19.04	61.84	51.84	-25.24	-32.79
3	0.38047	0.16	33.37	24.54	33.53	24.70	58.27	48.27	-24.74	-23.57
4	0.44297	0.16	30.57	19.67	30.73	19.83	57.01	47.01	-26.27	-27.17
5	0.63828	0.17	27.00	10.87	27.17	11.04	56.00	46.00	-28.83	-34.96
6	4.65625	0.35	41.72	37.63	42.07	37.98	56.00	46.00	-13.93	-8.02

REMARKS:

1. Q.P. and AV. are abbreviations of quasi-peak and average individually.
2. The emission levels of other frequencies were very low against the limit.
3. Margin value = Emission level - Limit value
4. Correction factor = Insertion loss + Cable loss
5. Emission Level = Correction Factor + Reading Value.

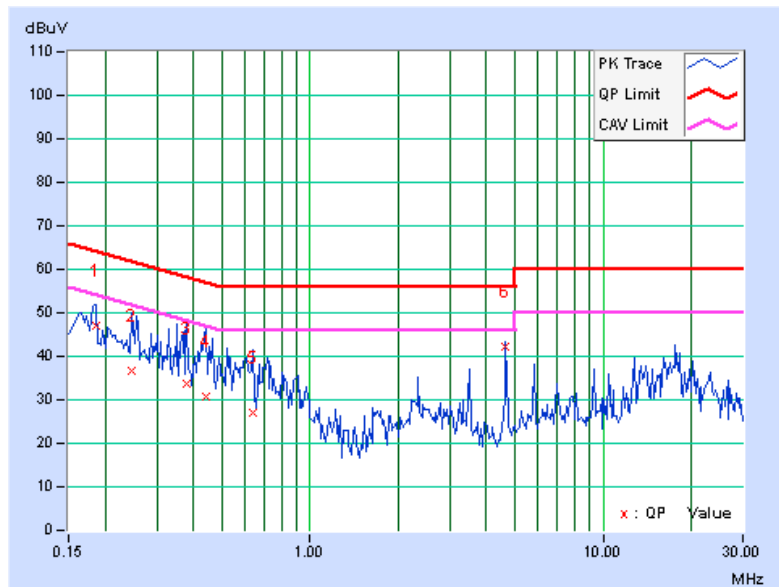

PHASE	Neutral (N)	DETECTOR FUNCTION	Quasi-Peak (QP) / Average (AV)
--------------	-------------	--------------------------	--------------------------------

No	Freq. [MHz]	Corr. Factor (dB)	Reading Value [dB (uV)]		Emission Level [dB (uV)]		Limit [dB (uV)]		Margin (dB)	
			Q.P.	AV.	Q.P.	AV.	Q.P.	AV.	Q.P.	AV.
	1	0.16506	0.15	47.00	40.44	47.15	40.59	65.21	55.21	-18.06
2	0.18906	0.15	43.81	29.64	43.96	29.79	64.08	54.08	-20.12	-24.29
3	0.21206	0.15	41.02	27.65	41.17	27.80	63.12	53.12	-21.95	-25.32
4	0.27869	0.17	39.29	27.90	39.46	28.07	60.85	50.85	-21.40	-22.79
5	0.39219	0.19	40.49	25.09	40.68	25.28	58.02	48.02	-17.34	-22.74
6	0.45859	0.19	39.21	16.26	39.40	16.45	56.72	46.72	-17.32	-30.27
7	0.59141	0.20	37.23	15.81	37.43	16.01	56.00	46.00	-18.57	-29.99

REMARKS:

1. Q.P. and AV. are abbreviations of quasi-peak and average individually.
2. The emission levels of other frequencies were very low against the limit.
3. Margin value = Emission level - Limit value
4. Correction factor = Insertion loss + Cable loss
5. Emission Level = Correction Factor + Reading Value.

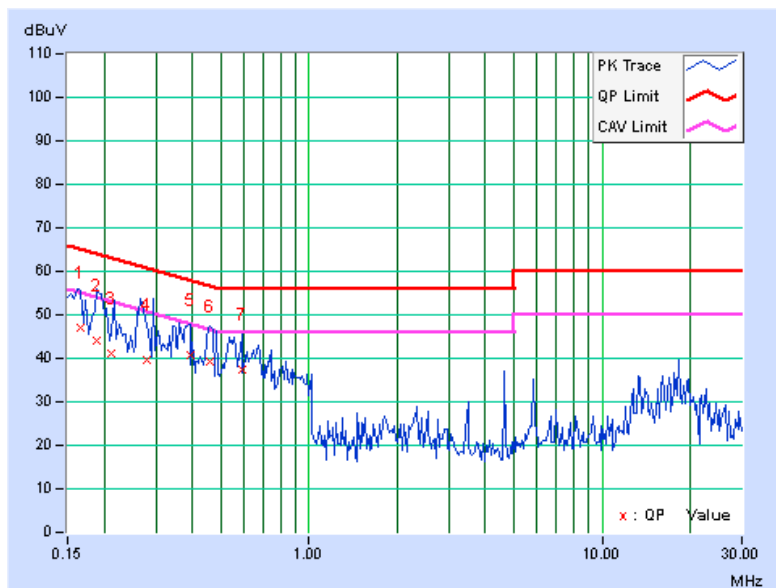



A D T

4.2 RADIATED EMISSION AND BANDEDGE MEASUREMENT

4.2.1 LIMITS OF RADIATED EMISSION AND BANDEDGE MEASUREMENT

Radiated emissions which fall in the restricted bands must comply with the radiated emission limits specified as below table:

Frequencies (MHz)	Field strength (microvolts/meter)	Measurement distance (meters)
0.009-0.490	2400/F(kHz)	300
0.490-1.705	24000/F(kHz)	30
1.705-30.0	30	30
30-88	100	3
88-216	150	3
216-960	200	3
Above 960	500	3

NOTE:

1. The lower limit shall apply at the transition frequencies.
2. Emission level (dBuV/m) = 20 log Emission level (uV/m).
3. For frequencies above 1000MHz, the field strength limits are based on average detector, however, the peak field strength of any emission shall not exceed the maximum permitted average limits, specified above by more than 20dB under any condition of modulation.

4.2.2 LIMITS OF UNWANTED EMISSION OUT OF THE RESTRICTED BANDS

APPLICABLE TO	LIMIT	
√	FIELD STRENGTH AT 3m (dBμV/m)	
	PK	AV
	74	54
-	EIRP LIMIT (dBm)	EQUIVALENT FIELD STRENGTH AT 3m (dBμV/m)
	PK	PK
	-27	68.3

NOTE:

1. The following formula is used to convert the equipment isotropic radiated power (eirp) to field strength:

$$E = \frac{1000000\sqrt{30P}}{3} \mu\text{V/m, where P is the eirp (Watts).}$$



A D T

4.2.3 TEST INSTRUMENTS

DESCRIPTION & MANUFACTURER	MODEL NO.	SERIAL NO.	CALIBRATED DATE	CALIBRATED UNTIL
Spectrum Analyzer Agilent	E4446A	MY48250253	Sep. 03, 2012	Sep. 02, 2013
MXE EMI Receiver Agilent	N9038A	MY51210105	Jan. 29,2013	Jan. 28,2014
Pre-Amplifier Mini-Circuits	ZFL-1000VH2 B	AMP-ZFL-03	Nov. 14, 2012	Nov. 13, 2013
Pre-Amplifier Agilent	8449B	3008A02578	June 26, 2012	June 25, 2013
Pre-Amplifier SPACEK LABS	SLKKa-48-6	9K16	Nov. 14, 2012	Nov. 13, 2013
Trilog Broadband Antenna SCHWARZBECK	VULB 9168	9168-360	Mar. 19, 2013	Mar. 18, 2014
Horn_Antenna AISi	AIH.8018	0000320091110	Nov. 19, 2012	Nov. 18, 2013
Horn_Antenna SCHWARZBECK	BBHA 9170	9170-424	Oct. 12, 2012	Oct. 11, 2013
RF Cable	NA	RF104-201 RF104-203 RF104-204	Dec. 25, 2012	Dec. 24, 2013
RF Cable	NA	CHGCAB_001	Oct. 06, 2012	Oct. 05, 2013
Software	ADT_Radiated _V8.7.05	NA	NA	NA
Antenna Tower & Turn Table CT	NA	NA	NA	NA

Note:

1. The calibration interval of the above test instruments is 12 months and the calibrations are traceable to NML/ROC and NIST/USA.
2. The horn antenna, preamplifier (model: 8449B) are used only for the measurement of emission frequency above 1GHz if tested.
- 3 The test was performed in 966 Chamber No. G.
4. The FCC Site Registration No. is 966073.
- 5 The VCCI Site Registration No. is G-137.
- 6 The CANADA Site Registration No. is IC 7450H-2.
- 7 Tested Date: Apr. 10 to 11, 2013

4.2.4 TEST PROCEDURES

- a. The EUT was placed on the top of a rotating table 0.8 meters above the ground at 3 meter chamber room for test. The table was rotated 360 degrees to determine the position of the highest radiation.
- b. The EUT was set 3 meters away from the interference-receiving antenna, which was mounted on the top of a variable-height antenna tower.
- c. The height of antenna is varied from one meter to four meters above the ground to determine the maximum value of the field strength. Both horizontal and vertical polarizations of the antenna are set to make the measurement.
- d. For each suspected emission, the EUT was arranged to its worst case and then the antenna was tuned to heights from 1 meter to 4 meters and the rotatable table was turned from 0 degrees to 360 degrees to find the maximum reading.
- e. The test-receiver system was set to quasi-peak detect function and specified bandwidth with maximum hold mode when the test frequency is below 1 GHz.
- f. The test-receiver system was set to peak and average detect function and specified bandwidth with maximum hold mode when the test frequency is above 1 GHz. If the peak reading value also meets average limit, measurement with the average detector is unnecessary.

NOTE:

1. The resolution bandwidth and video bandwidth of test receiver/spectrum analyzer is 120kHz for Quasi-peak detection (QP) at frequency below 1GHz.
2. The resolution bandwidth of test receiver/spectrum analyzer is 1 MHz and the video bandwidth is 3 MHz for Peak detection (PK) at frequency above 1GHz.
3. The resolution bandwidth of test receiver/spectrum analyzer is 1 MHz and the video bandwidth is 10 Hz for Average detection (AV) at frequency above 1GHz.
4. All modes of operation were investigated and the worst-case emissions are reported.

4.2.5 DEVIATION FROM TEST STANDARD

No deviation

4.2.6 TEST SETUP

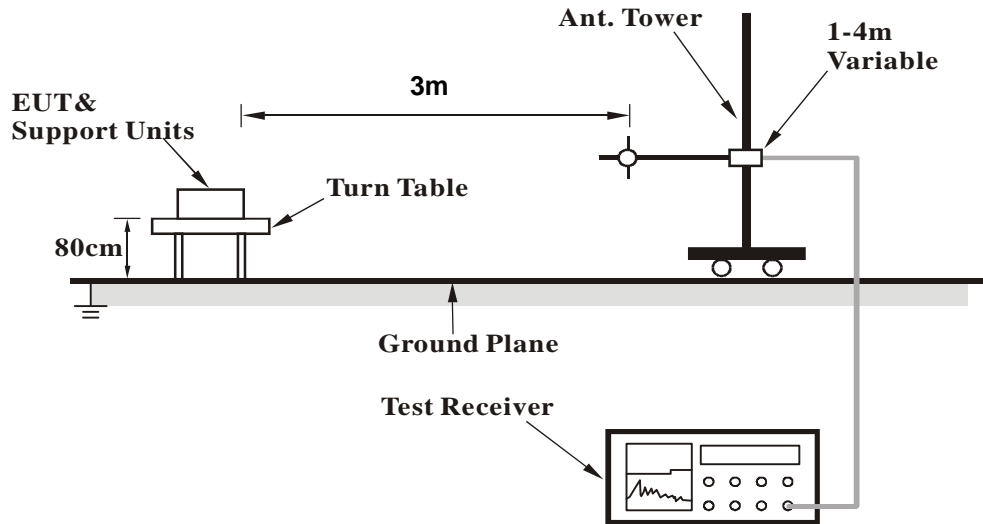

For the actual test configuration, please refer to the related item – Photographs of the Test Configuration.

4.2.7 EUT OPERATING CONDITION

Same as 4.1.6



A D T

4.2.8 TEST RESULTS

BELOW 1GHz WORST-CASE DATA

802.11a

CHANNEL	TX Channel 48	DETECTOR FUNCTION	Quasi-Peak (QP)
FREQUENCY RANGE	Below 1GHz		

ANTENNA POLARITY & TEST DISTANCE: HORIZONTAL AT 3 M

NO.	FREQ. (MHz)	EMISSION LEVEL (dBuV/m)	LIMIT (dBuV/m)	MARGIN (dB)	ANTENNA HEIGHT (m)	TABLE ANGLE (Degree)	RAW VALUE (dBuV)	CORRECTION FACTOR (dB/m)
1	104.74	30.3 QP	43.5	-13.2	1.50 H	360	47.66	-17.33
2	148.10	33.9 QP	43.5	-9.6	2.00 H	64	47.75	-13.85
3	579.99	30.5 QP	46.0	-15.5	1.00 H	360	36.62	-6.14
4	625.00	34.1 QP	46.0	-11.9	1.00 H	360	38.95	-4.84
5	676.70	34.4 QP	46.0	-11.6	1.00 H	360	38.71	-4.32
6	750.03	32.6 QP	46.0	-13.4	1.00 H	45	35.09	-2.45

ANTENNA POLARITY & TEST DISTANCE: VERTICAL AT 3 M

NO.	FREQ. (MHz)	EMISSION LEVEL (dBuV/m)	LIMIT (dBuV/m)	MARGIN (dB)	ANTENNA HEIGHT (m)	TABLE ANGLE (Degree)	RAW VALUE (dBuV)	CORRECTION FACTOR (dB/m)
1	77.19	30.0 QP	40.0	-10.0	1.00 V	301	47.79	-17.75
2	483.43	30.5 QP	46.0	-15.5	1.00 V	327	38.76	-8.23
3	531.64	35.3 QP	46.0	-10.7	1.00 V	252	42.66	-7.40
4	579.99	33.3 QP	46.0	-12.7	2.00 V	360	39.47	-6.14
5	628.30	36.4 QP	46.0	-9.6	1.50 V	311	41.22	-4.84
6	676.60	32.7 QP	46.0	-13.4	1.50 V	257	36.97	-4.32

REMARKS:

1. Emission level (dBuV/m) = Raw Value (dBuV) + Correction Factor (dB/m).
2. Correction Factor (dB/m) = Antenna Factor (dB/m) + Cable Factor (dB).
3. The other emission levels were very low against the limit.
4. Margin value = Emission level – Limit value.



ABOVE 1GHz DATA

802.11a

CHANNEL	TX Channel 36	DETECTOR FUNCTION	Peak (PK)
FREQUENCY RANGE	1GHz ~ 40GHz		Average (AV)

ANTENNA POLARITY & TEST DISTANCE: HORIZONTAL AT 3 M

NO.	FREQ. (MHz)	EMISSION LEVEL (dBuV/m)	LIMIT (dBuV/m)	MARGIN (dB)	ANTENNA HEIGHT (m)	TABLE ANGLE (Degree)	RAW VALUE (dBuV)	CORRECTION FACTOR (dB/m)
1	5145.00	48.4 PK	74.0	-25.6	1.23 H	95	7.87	40.53
2	5145.00	37.4 AV	54.0	-16.6	1.23 H	95	-3.13	40.53
3	*5180.00	97.9 PK			1.00 H	152	57.22	40.68
4	*5180.00	89.0 AV			1.00 H	152	48.32	40.68
5	#10360.00	60.6 PK	74.0	-13.4	1.30 H	301	12.78	47.82
6	#10360.00	48.5 AV	54.0	-5.5	1.30 H	301	0.68	47.82
7	15540.00	64.0 PK	74.0	-10.0	1.05 H	52	10.73	53.27
8	15540.00	52.1 AV	54.0	-1.9	1.05 H	52	-1.17	53.27

ANTENNA POLARITY & TEST DISTANCE: VERTICAL AT 3 M

NO.	FREQ. (MHz)	EMISSION LEVEL (dBuV/m)	LIMIT (dBuV/m)	MARGIN (dB)	ANTENNA HEIGHT (m)	TABLE ANGLE (Degree)	RAW VALUE (dBuV)	CORRECTION FACTOR (dB/m)
1	5145.00	63.4 PK	74.0	-10.6	1.00 V	286	22.87	40.53
2	5145.00	52.4 AV	54.0	-1.6	1.00 V	286	11.87	40.53
3	*5180.00	113.0 PK			1.00 V	286	72.32	40.68
4	*5180.00	104.9 AV			1.00 V	286	64.22	40.68
5	#10360.00	61.3 PK	74.0	-12.7	1.31 V	283	13.48	47.82
6	#10360.00	49.2 AV	54.0	-4.8	1.31 V	283	1.38	47.82
7	15540.00	64.2 PK	74.0	-9.8	1.00 V	64	10.93	53.27
8	15540.00	52.4 AV	54.0	-1.6	1.00 V	64	-0.87	53.27

REMARKS:

1. Emission level (dBuV/m) = Raw Value (dBuV) + Correction Factor (dB/m).
2. Correction Factor (dB/m) = Antenna Factor (dB/m) + Cable Factor (dB).
3. The other emission levels were very low against the limit.
4. Margin value = Emission level – Limit value.
5. " * ": Fundamental frequency.
6. " # ": The radiated frequency is out of the restricted band.



A D T

CHANNEL	TX Channel 40	DETECTOR FUNCTION	Peak (PK)
FREQUENCY RANGE	1GHz ~ 40GHz		Average (AV)

ANTENNA POLARITY & TEST DISTANCE: HORIZONTAL AT 3 M

NO.	FREQ. (MHz)	EMISSION LEVEL (dBuV/m)	LIMIT (dBuV/m)	MARGIN (dB)	ANTENNA HEIGHT (m)	TABLE ANGLE (Degree)	RAW VALUE (dBuV)	CORRECTION FACTOR (dB/m)
1	5145.00	48.0 PK	74.0	-26.0	1.18 H	89	7.47	40.53
2	5145.00	37.2 AV	54.0	-16.8	1.18 H	89	-3.33	40.53
3	*5200.00	97.7 PK			1.21 H	61	56.93	40.77
4	*5200.00	89.4 AV			1.21 H	61	48.63	40.77
5	5350.00	44.5 PK	74.0	-29.5	1.23 H	97	3.35	41.15
6	5350.00	37.3 AV	54.0	-16.7	1.23 H	97	-3.85	41.15
7	#10400.00	61.0 PK	74.0	-13.0	1.29 H	292	13.64	47.36
8	#10400.00	49.2 AV	54.0	-4.8	1.29 H	292	1.84	47.36
9	15600.00	64.6 PK	74.0	-9.4	1.02 H	75	11.61	52.99
10	15600.00	52.6 AV	54.0	-1.4	1.02 H	75	-0.39	52.99

ANTENNA POLARITY & TEST DISTANCE: VERTICAL AT 3 M

NO.	FREQ. (MHz)	EMISSION LEVEL (dBuV/m)	LIMIT (dBuV/m)	MARGIN (dB)	ANTENNA HEIGHT (m)	TABLE ANGLE (Degree)	RAW VALUE (dBuV)	CORRECTION FACTOR (dB/m)
1	5145.00	63.0 PK	74.0	-11.0	1.00 V	285	22.47	40.53
2	5145.00	52.2 AV	54.0	-1.8	1.00 V	285	11.67	40.53
3	*5200.00	112.7 PK			1.00 V	285	71.93	40.77
4	*5200.00	104.4 AV			1.00 V	285	63.63	40.77
5	5350.00	59.5 PK	74.0	-14.5	1.00 V	285	18.35	41.15
6	5350.00	48.0 AV	54.0	-6.0	1.00 V	285	6.85	41.15
7	#10400.00	60.4 PK	74.0	-13.6	1.24 V	286	13.04	47.36
8	#10400.00	48.3 AV	54.0	-5.7	1.24 V	286	0.94	47.36
9	15600.00	63.9 PK	74.0	-10.1	1.06 V	73	10.91	52.99
10	15600.00	52.5 AV	54.0	-1.5	1.06 V	73	-0.49	52.99

REMARKS:

1. Emission level (dBuV/m) = Raw Value (dBuV) + Correction Factor (dB/m).
2. Correction Factor (dB/m) = Antenna Factor (dB/m) + Cable Factor (dB).
3. The other emission levels were very low against the limit.
4. Margin value = Emission level – Limit value.
5. " * ": Fundamental frequency.
6. " # ": The radiated frequency is out of the restricted band.



A D T

CHANNEL	TX Channel 48	DETECTOR FUNCTION	Peak (PK)
FREQUENCY RANGE	1GHz ~ 40GHz		Average (AV)

ANTENNA POLARITY & TEST DISTANCE: HORIZONTAL AT 3 M

NO.	FREQ. (MHz)	EMISSION LEVEL (dBuV/m)	LIMIT (dBuV/m)	MARGIN (dB)	ANTENNA HEIGHT (m)	TABLE ANGLE (Degree)	RAW VALUE (dBuV)	CORRECTION FACTOR (dB/m)
1	5150.00	48.7 PK	74.0	-25.3	1.27 H	87	8.15	40.55
2	5150.00	37.1 AV	54.0	-16.9	1.27 H	87	-3.45	40.55
3	*5240.00	101.1 PK			1.21 H	66	60.21	40.89
4	*5240.00	92.9 AV			1.21 H	66	52.01	40.89
5	5350.00	46.0 PK	74.0	-28.0	1.32 H	99	4.85	41.15
6	5350.00	37.6 AV	54.0	-16.4	1.32 H	99	-3.55	41.15
7	#10480.00	61.7 PK	74.0	-12.3	1.28 H	96	14.05	47.65
8	#10480.00	51.4 AV	54.0	-2.6	1.28 H	96	3.75	47.65
9	15720.00	64.1 PK	74.0	-9.9	1.00 H	63	11.51	52.59
10	15720.00	52.4 AV	54.0	-1.6	1.00 H	63	-0.19	52.59

ANTENNA POLARITY & TEST DISTANCE: VERTICAL AT 3 M

NO.	FREQ. (MHz)	EMISSION LEVEL (dBuV/m)	LIMIT (dBuV/m)	MARGIN (dB)	ANTENNA HEIGHT (m)	TABLE ANGLE (Degree)	RAW VALUE (dBuV)	CORRECTION FACTOR (dB/m)
1	5150.00	63.7 PK	74.0	-10.3	1.00 V	274	23.15	40.55
2	5150.00	52.1 AV	54.0	-1.9	1.00 V	274	11.55	40.55
3	*5240.00	116.1 PK			1.00 V	274	75.21	40.89
4	*5240.00	107.9 AV			1.00 V	274	67.01	40.89
5	5350.00	61.0 PK	74.0	-13.0	1.00 V	275	19.85	41.15
6	5350.00	49.3 AV	54.0	-4.7	1.00 V	275	8.15	41.15
7	#10480.00	61.5 PK	74.0	-12.5	1.21 V	79	13.85	47.65
8	#10480.00	50.9 AV	54.0	-3.1	1.21 V	79	3.25	47.65
9	15720.00	64.2 PK	74.0	-9.8	1.00 V	69	11.61	52.59
10	15720.00	52.4 AV	54.0	-1.6	1.00 V	69	-0.19	52.59

REMARKS:

1. Emission level (dBuV/m) = Raw Value (dBuV) + Correction Factor (dB/m).
2. Correction Factor (dB/m) = Antenna Factor (dB/m) + Cable Factor (dB).
3. The other emission levels were very low against the limit.
4. Margin value = Emission level – Limit value.
5. " * ": Fundamental frequency.
6. " # ": The radiated frequency is out of the restricted band.



A D T

802.11n (HT20)

CHANNEL	TX Channel 36	DETECTOR FUNCTION	Peak (PK)
FREQUENCY RANGE	1GHz ~ 40GHz		Average (AV)

ANTENNA POLARITY & TEST DISTANCE: HORIZONTAL AT 3 M

NO.	FREQ. (MHz)	EMISSION LEVEL (dBuV/m)	LIMIT (dBuV/m)	MARGIN (dB)	ANTENNA HEIGHT (m)	TABLE ANGLE (Degree)	RAW VALUE (dBuV)	CORRECTION FACTOR (dB/m)
1	5150.00	46.2 PK	74.0	-27.8	1.26 H	92	5.65	40.55
2	5150.00	37.5 AV	54.0	-16.5	1.26 H	92	-3.05	40.55
3	*5180.00	105.8 PK			1.00 H	181	65.12	40.68
4	*5180.00	99.3 AV			1.00 H	181	58.62	40.68
5	#10360.00	60.8 PK	74.0	-13.2	1.26 H	297	12.98	47.82
6	#10360.00	48.8 AV	54.0	-5.2	1.26 H	297	0.98	47.82
7	15540.00	63.9 PK	74.0	-10.1	1.01 H	65	10.63	53.27
8	15540.00	52.0 AV	54.0	-2.0	1.01 H	65	-1.27	53.27

ANTENNA POLARITY & TEST DISTANCE: VERTICAL AT 3 M

NO.	FREQ. (MHz)	EMISSION LEVEL (dBuV/m)	LIMIT (dBuV/m)	MARGIN (dB)	ANTENNA HEIGHT (m)	TABLE ANGLE (Degree)	RAW VALUE (dBuV)	CORRECTION FACTOR (dB/m)
1	5150.00	61.2 PK	74.0	-12.8	1.02 V	285	20.65	40.55
2	5150.00	52.5 AV	54.0	-1.5	1.02 V	285	11.95	40.55
3	*5180.00	110.5 PK			1.02 V	285	69.82	40.68
4	*5180.00	102.9 AV			1.02 V	285	62.22	40.68
5	#10360.00	60.6 PK	74.0	-13.4	1.21 V	286	12.78	47.82
6	#10360.00	48.4 AV	54.0	-5.6	1.21 V	286	0.58	47.82
7	15540.00	64.3 PK	74.0	-9.7	1.00 V	63	11.03	53.27
8	15540.00	52.7 AV	54.0	-1.3	1.00 V	63	-0.57	53.27

REMARKS:

1. Emission level (dBuV/m) = Raw Value (dBuV) + Correction Factor (dB/m).
2. Correction Factor (dB/m) = Antenna Factor (dB/m) + Cable Factor (dB).
3. The other emission levels were very low against the limit.
4. Margin value = Emission level – Limit value.
5. " * ": Fundamental frequency.
6. " # ": The radiated frequency is out of the restricted band.



A D T

CHANNEL	TX Channel 40	DETECTOR FUNCTION	Peak (PK)
FREQUENCY RANGE	1GHz ~ 40GHz		Average (AV)

ANTENNA POLARITY & TEST DISTANCE: HORIZONTAL AT 3 M

NO.	FREQ. (MHz)	EMISSION LEVEL (dBuV/m)	LIMIT (dBuV/m)	MARGIN (dB)	ANTENNA HEIGHT (m)	TABLE ANGLE (Degree)	RAW VALUE (dBuV)	CORRECTION FACTOR (dB/m)
1	5150.00	47.6 PK	74.0	-26.4	1.31 H	66	7.05	40.55
2	5150.00	36.9 AV	54.0	-17.1	1.31 H	66	-3.65	40.55
3	*5200.00	95.4 PK			1.32 H	108	54.63	40.77
4	*5200.00	87.9 AV			1.32 H	108	47.13	40.77
5	5350.00	45.6 PK	74.0	-28.4	1.32 H	83	4.45	41.15
6	5350.00	37.7 AV	54.0	-16.3	1.32 H	83	-3.45	41.15
7	#10400.00	61.1 PK	74.0	-12.9	1.30 H	311	13.74	47.36
8	#10400.00	49.1 AV	54.0	-4.9	1.30 H	311	1.74	47.36
9	15600.00	64.0 PK	74.0	-10.0	1.00 H	72	11.01	52.99
10	15600.00	52.4 AV	54.0	-1.6	1.00 H	72	-0.59	52.99

ANTENNA POLARITY & TEST DISTANCE: VERTICAL AT 3 M

NO.	FREQ. (MHz)	EMISSION LEVEL (dBuV/m)	LIMIT (dBuV/m)	MARGIN (dB)	ANTENNA HEIGHT (m)	TABLE ANGLE (Degree)	RAW VALUE (dBuV)	CORRECTION FACTOR (dB/m)
1	5150.00	62.6 PK	74.0	-11.4	1.00 V	285	22.05	40.55
2	5150.00	51.9 AV	54.0	-2.1	1.00 V	285	11.35	40.55
3	*5200.00	110.4 PK			1.00 V	285	69.63	40.77
4	*5200.00	102.9 AV			1.00 V	285	62.13	40.77
5	5350.00	60.6 PK	74.0	-13.4	1.03 V	297	19.45	41.15
6	5350.00	48.4 AV	54.0	-5.6	1.03 V	297	7.25	41.15
7	#10400.00	60.4 PK	74.0	-13.6	1.26 V	283	13.04	47.36
8	#10400.00	48.6 AV	54.0	-5.4	1.26 V	283	1.24	47.36
9	15600.00	63.8 PK	74.0	-10.2	1.00 V	59	10.81	52.99
10	15600.00	52.1 AV	54.0	-1.9	1.00 V	59	-0.89	52.99

REMARKS:

1. Emission level (dBuV/m) = Raw Value (dBuV) + Correction Factor (dB/m).
2. Correction Factor (dB/m) = Antenna Factor (dB/m) + Cable Factor (dB).
3. The other emission levels were very low against the limit.
4. Margin value = Emission level – Limit value.
5. " * ": Fundamental frequency.
6. " # ": The radiated frequency is out of the restricted band.



CHANNEL	TX Channel 48	DETECTOR FUNCTION	Peak (PK)
FREQUENCY RANGE	1GHz ~ 40GHz		Average (AV)

ANTENNA POLARITY & TEST DISTANCE: HORIZONTAL AT 3 M								
NO.	FREQ. (MHz)	EMISSION LEVEL (dBuV/m)	LIMIT (dBuV/m)	MARGIN (dB)	ANTENNA HEIGHT (m)	TABLE ANGLE (Degree)	RAW VALUE (dBuV)	CORRECTION FACTOR (dB/m)
1	*5240.00	95.6 PK			1.15 H	77	54.71	40.89
2	*5240.00	87.6 AV			1.15 H	77	46.71	40.89
3	5350.00	45.5 PK	74.0	-28.5	1.28 H	94	4.35	41.15
4	5350.00	37.4 AV	54.0	-16.6	1.28 H	94	-3.75	41.15
5	#10480.00	60.3 PK	74.0	-13.7	1.28 H	297	12.65	47.65
6	#10480.00	48.4 AV	54.0	-5.6	1.28 H	297	0.75	47.65
7	15720.00	63.7 PK	74.0	-10.3	1.00 H	67	11.11	52.59
8	15720.00	52.1 AV	54.0	-1.9	1.00 H	67	-0.49	52.59

ANTENNA POLARITY & TEST DISTANCE: VERTICAL AT 3 M								
NO.	FREQ. (MHz)	EMISSION LEVEL (dBuV/m)	LIMIT (dBuV/m)	MARGIN (dB)	ANTENNA HEIGHT (m)	TABLE ANGLE (Degree)	RAW VALUE (dBuV)	CORRECTION FACTOR (dB/m)
1	*5240.00	110.6 PK			1.00 V	284	69.71	40.89
2	*5240.00	102.6 AV			1.00 V	284	61.71	40.89
3	5350.00	60.5 PK	74.0	-13.5	1.00 V	284	19.35	41.15
4	5350.00	48.2 AV	54.0	-5.8	1.00 V	284	7.05	41.15
5	#10480.00	61.1 PK	74.0	-12.9	1.21 V	308	13.45	47.65
6	#10480.00	48.8 AV	54.0	-5.2	1.21 V	308	1.15	47.65
7	15720.00	63.9 PK	74.0	-10.1	1.00 V	67	11.31	52.59
8	15720.00	52.2 AV	54.0	-1.8	1.00 V	67	-0.39	52.59

REMARKS:

1. Emission level (dBuV/m) = Raw Value (dBuV) + Correction Factor (dB/m).
2. Correction Factor (dB/m) = Antenna Factor (dB/m) + Cable Factor (dB).
3. The other emission levels were very low against the limit.
4. Margin value = Emission level – Limit value.
5. " * ": Fundamental frequency.
6. " # ": The radiated frequency is out of the restricted band.



A D T

802.11n (HT40)

CHANNEL	TX Channel 38	DETECTOR FUNCTION	Peak (PK)
FREQUENCY RANGE	1GHz ~ 40GHz		Average (AV)

ANTENNA POLARITY & TEST DISTANCE: HORIZONTAL AT 3 M

NO.	FREQ. (MHz)	EMISSION LEVEL (dBuV/m)	LIMIT (dBuV/m)	MARGIN (dB)	ANTENNA HEIGHT (m)	TABLE ANGLE (Degree)	RAW VALUE (dBuV)	CORRECTION FACTOR (dB/m)
1	5150.00	51.6 PK	74.0	-22.4	1.16 H	102	11.05	40.55
2	5150.00	38.3 AV	54.0	-15.7	1.16 H	102	-2.25	40.55
3	*5190.00	91.6 PK			1.29 H	102	50.87	40.73
4	*5190.00	83.4 AV			1.29 H	102	42.67	40.73
5	#10380.00	60.5 PK	74.0	-13.5	1.30 H	299	12.91	47.59
6	#10380.00	48.3 AV	54.0	-5.7	1.30 H	299	0.71	47.59
7	15570.00	62.2 PK	74.0	-11.8	1.24 H	91	9.07	53.13
8	15570.00	51.5 AV	54.0	-2.5	1.24 H	91	-1.63	53.13

ANTENNA POLARITY & TEST DISTANCE: VERTICAL AT 3 M

NO.	FREQ. (MHz)	EMISSION LEVEL (dBuV/m)	LIMIT (dBuV/m)	MARGIN (dB)	ANTENNA HEIGHT (m)	TABLE ANGLE (Degree)	RAW VALUE (dBuV)	CORRECTION FACTOR (dB/m)
1	5150.00	66.6 PK	74.0	-7.4	1.00 V	285	26.05	40.55
2	5150.00	53.3 AV	54.0	-0.7	1.00 V	285	12.75	40.55
3	*5190.00	106.6 PK			1.00 V	285	65.87	40.73
4	*5190.00	98.4 AV			1.00 V	285	57.67	40.73
5	#10380.00	60.8 PK	74.0	-13.2	1.30 V	281	13.21	47.59
6	#10380.00	48.5 AV	54.0	-5.5	1.30 V	281	0.91	47.59
7	15570.00	61.0 PK	74.0	-13.0	1.25 V	80	7.87	53.13
8	15570.00	50.7 AV	54.0	-3.3	1.25 V	80	-2.43	53.13

REMARKS:

1. Emission level (dBuV/m) = Raw Value (dBuV) + Correction Factor (dB/m).
2. Correction Factor (dB/m) = Antenna Factor (dB/m) + Cable Factor (dB).
3. The other emission levels were very low against the limit.
4. Margin value = Emission level – Limit value.
5. " * ": Fundamental frequency.
6. " # ": The radiated frequency is out of the restricted band.



CHANNEL	TX Channel 46	DETECTOR FUNCTION	Peak (PK)
FREQUENCY RANGE	1GHz ~ 40GHz		Average (AV)

ANTENNA POLARITY & TEST DISTANCE: HORIZONTAL AT 3 M								
NO.	FREQ. (MHz)	EMISSION LEVEL (dBuV/m)	LIMIT (dBuV/m)	MARGIN (dB)	ANTENNA HEIGHT (m)	TABLE ANGLE (Degree)	RAW VALUE (dBuV)	CORRECTION FACTOR (dB/m)
1	*5230.00	93.4 PK			1.25 H	97	52.54	40.86
2	*5230.00	85.5 AV			1.25 H	97	44.64	40.86
3	5350.00	45.2 PK	74.0	-28.8	1.25 H	108	4.05	41.15
4	5350.00	37.0 AV	54.0	-17.0	1.25 H	108	-4.15	41.15
5	#10460.00	61.1 PK	74.0	-12.9	1.20 H	306	13.52	47.58
6	#10460.00	49.0 AV	54.0	-5.0	1.20 H	306	1.42	47.58
7	15690.00	61.5 PK	74.0	-12.5	1.19 H	98	8.86	52.64
8	15690.00	50.8 AV	54.0	-3.2	1.19 H	98	-1.84	52.64

ANTENNA POLARITY & TEST DISTANCE: VERTICAL AT 3 M								
NO.	FREQ. (MHz)	EMISSION LEVEL (dBuV/m)	LIMIT (dBuV/m)	MARGIN (dB)	ANTENNA HEIGHT (m)	TABLE ANGLE (Degree)	RAW VALUE (dBuV)	CORRECTION FACTOR (dB/m)
1	*5230.00	108.4 PK			1.00 V	285	67.54	40.86
2	*5230.00	100.5 AV			1.00 V	285	59.64	40.86
3	5350.00	60.2 PK	74.0	-13.8	1.00 V	285	19.05	41.15
4	5350.00	48.1 AV	54.0	-5.9	1.00 V	285	6.95	41.15
5	#10460.00	60.7 PK	74.0	-13.3	1.23 V	290	13.12	47.58
6	#10460.00	48.4 AV	54.0	-5.6	1.23 V	290	0.82	47.58
7	15690.00	62.2 PK	74.0	-11.8	1.22 V	103	9.56	52.64
8	15690.00	51.4 AV	54.0	-2.6	1.22 V	103	-1.24	52.64

REMARKS:

1. Emission level (dBuV/m) = Raw Value (dBuV) + Correction Factor (dB/m).
2. Correction Factor (dB/m) = Antenna Factor (dB/m) + Cable Factor (dB).
3. The other emission levels were very low against the limit.
4. Margin value = Emission level – Limit value.
5. " * ": Fundamental frequency.
6. " # ": The radiated frequency is out of the restricted band.



A D T

4.3 TRANSMIT POWER MEASUREMENT

4.3.1 LIMITS OF TRANSMIT POWER MEASUREMENT

Frequency Band	Limit
5.15 – 5.25GHz	The lesser of 50mW (17dBm) or 4dBm + 10logB
5.25 – 5.35GHz	The lesser of 250mW (24dBm) or 11dBm + 10logB
5.47 – 5.725GHz	The lesser of 250mW (24dBm) or 11dBm + 10logB
5.725 – 5.825GHz	The lesser of 1W (30dBm) or 17dBm + 10logB

NOTE: Where B is the 26dB emission bandwidth in MHz.

Per KDB 662911 D01 Multiple Transmitter Output v01r02 Method of conducted output power measurement on IEEE 802.11 devices,

- Array Gain = 0 dB (i.e., no array gain) for NANT ≤ 4;
- Array Gain = 0 dB (i.e., no array gain) for channel widths ≥ 40 MHz for any NANT;
- Array Gain = 5 log(NANT/NSS) dB or 3 dB, whichever is less for 20-MHz channel widths with NANT ≥ 5.

For power measurements on all other devices: Array Gain = 10 log(NANT/NSS) dB.

4.3.2 TEST INSTRUMENTS

FOR POWER OUTPUT MEASUREMENT

DESCRIPTION & MANUFACTURER	MODEL NO.	SERIAL NO.	CALIBRATED DATE	CALIBRATED UNTIL
Power Meter	ML2495A	0824006	May 10, 2012	May 09, 2013
Power Sensor	MA2411B	0738172	May 10, 2012	May 09, 2013

Note:

1. The calibration interval of the above test instruments is 12 months and the calibrations are traceable to NML/ROC and NIST/USA.
2. Tested date : Apr. 11, 2013

FOR 26dB OCCUPIED BANDWIDTH

DESCRIPTION & MANUFACTURER	MODEL NO.	SERIAL NO.	CALIBRATED DATE	CALIBRATED UNTIL
R&S Spectrum Analyzer	FSP40	100037	Nov. 01, 2012	Oct. 31, 2013

Note:

1. The calibration interval of the above test instruments is 12 months and the calibrations are traceable to NML/ROC and NIST/USA.
2. Tested date : Apr. 11, 2013

4.3.3 TEST PROCEDURE

FOR POWER OUTPUT MEASUREMENT

Method PM is used to perform output power measurement, trigger and gating function of wide band power meter is enabled to measure max output power of TX on burst. Duty factor is not added to measured value.

FOR 26dB OCCUPIED BANDWIDTH

- 1) Set RBW = approximately 1% of the emission bandwidth.
- 2) Set the VBW > RBW.
- 3) Detector = Peak.
- 4) Trace mode = max hold.
- 5) Measure the maximum width of the emission that is 26 dB down from the peak of the emission. Compare this with the RBW setting of the analyzer. Readjust RBW and repeat measurement as needed until the RBW/EBW ratio is approximately 1%.

4.3.4 DEVIATION FROM TEST STANDARD

No deviation

4.3.5 TEST SETUP

FOR POWER OUTPUT MEASUREMENT

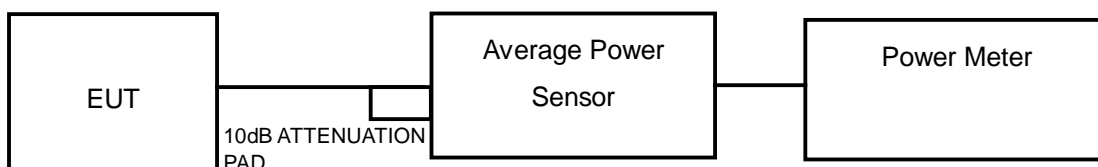

FOR 26dB OCCUPIED BANDWIDTH

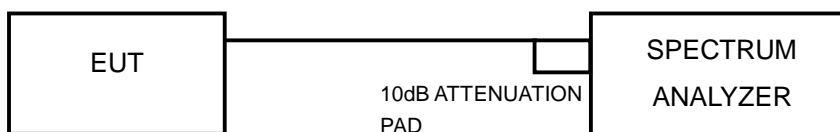

4.3.6 EUT OPERATING CONDITIONS

The software provided by client to enable the EUT under transmission condition continuously at specific channel frequencies individually.



A D T

4.3.7 TEST RESULTS

POWER OUTPUT:

802.11a

CHANNEL	CHANNEL FREQUENCY (MHz)	AVERAGE POWER (mW)	AVERAGE POWER (dBm)	POWER LIMIT (dBm)	PASS/FAIL
36	5180	36.644	15.64	17.00	PASS
40	5200	37.670	15.76	17.00	PASS
48	5240	37.931	15.79	17.00	PASS

802.11n (HT20)

CHAN.	CHAN. FREQ. (MHz)	AVERAGE POWER (dBm)		TOTAL POWER (mW)	TOTAL POWER (dBm)	POWER LIMIT (dBm)	PASS / FAIL
		CHAIN 0	CHAIN 1				
36	5180	11.91	11.82	30.729	14.88	17.00	PASS
40	5200	11.41	11.33	27.419	14.38	17.00	PASS
48	5240	11.65	11.45	28.586	14.56	17.00	PASS

802.11n (HT40)

CHAN.	CHAN. FREQ. (MHz)	AVERAGE POWER (dBm)		TOTAL POWER (mW)	TOTAL POWER (dBm)	POWER LIMIT (dBm)	PASS / FAIL
		CHAIN 0	CHAIN 1				
38	5190	13.32	13.33	43.006	16.34	17.00	PASS
46	5230	13.47	13.35	43.860	16.42	17.00	PASS



A D T

26dB OCCUPIED BANDWIDTH:

802.11a

CHANNEL	CHANNEL FREQUENCY (MHz)	26dBc BANDWIDTH (MHz)
36	5180	18.48
40	5200	18.59
48	5240	18.67

802.11n (HT20)

CHANNEL	CHANNEL FREQUENCY (MHz)	26dBc BANDWIDTH (MHz)	
		CHAIN 0	CHAIN 1
36	5180	19.27	19.26
40	5200	19.10	19.22
48	5240	19.21	19.29

802.11n (HT40)

CHANNEL	CHANNEL FREQUENCY (MHz)	26dBc BANDWIDTH (MHz)	
		CHAIN 0	CHAIN 1
38	5190	40.71	40.84
46	5230	40.61	40.69

4.4 PEAK POWER SPECTRAL DENSITY MEASUREMENT

4.4.1 LIMITS OF PEAK POWER SPECTRAL DENSITY MEASUREMENT

Frequency Band	Limit
5.15 ~ 5.25GHz	4dBm
5.25 ~ 5.35GHz	11dBm
5.47 – 5.725GHz	11dBm
5.725 ~ 5.825GHz	17dBm

4.4.2 TEST INSTRUMENTS

DESCRIPTION & MANUFACTURER	MODEL NO.	SERIAL NO.	CALIBRATED DATE	CALIBRATED UNTIL
R&S Spectrum Analyzer	FSP40	100037	Nov. 01, 2012	Oct. 31, 2013

Note:

1. The calibration interval of the above test instruments is 12 months and the calibrations are traceable to NML/ROC and NIST/USA.
2. Tested date : Apr. 11, 2013

4.4.3 TEST PROCEDURES

Using method SA-1

Set span to encompass the entire emission bandwidth (EBW) of the signal.

1. Set RBW = 30 KHz, Set VBW \geq 1 MHz, Detector = RMS
2. Set Channel power measure = 1MHz
3. Sweep time = auto, trigger set to “free run”.
4. Trace average at least 100 traces in power averaging mode.
5. Record the max value

4.4.4 DEVIATION FROM TEST STANDARD

No deviation

4.4.5 TEST SETUP

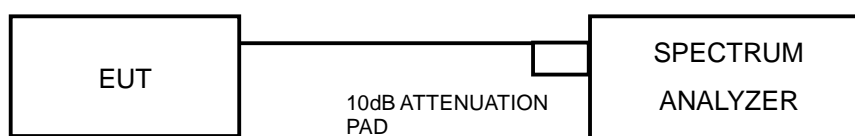



A D T

4.4.6 EUT OPERATING CONDITIONS

Same as 4.3.6



A D T

4.4.7 TEST RESULTS

802.11a

CHANNEL	FREQUENCY (MHz)	PSD (dBm)	MAXIMUM LIMIT (dBm)	PASS/FAIL
36	5180	3.62	4.00	PASS
40	5200	3.73	4.00	PASS
48	5240	3.48	4.00	PASS

802.11n (HT20)

CHANNEL	FREQUENCY (MHz)	PSD (dBm)		TOTAL POWER DENSITY (dBm)	MAX. LIMIT (dBm)	PASS/FAIL
		CHAIN 0	CHAIN 1			
36	5180	-1.44	-0.61	2.01	2.28	PASS
40	5200	-1.12	-1.47	1.72	2.28	PASS
48	5240	-1.93	-1.03	1.55	2.28	PASS

- NOTE:**
1. Method 1 of power density measurement of KDB 662911 is using for calculating total power density. Total power density is summing entire spectra across corresponding frequency bins on the various outputs by computer.
 2. Directional gain = $10 \log[(10^{G1/20} + 10^{G2/20})^2 / 2] = 7.72\text{dBi} > 6\text{dBi}$, so the power density limit shall be reduced to $4-(7.72-6) = 2.28\text{dBm}$.

802.11n (HT40)

CHANNEL	FREQUENCY (MHz)	PSD (dBm)		TOTAL POWER DENSITY (dBm)	MAX. LIMIT (dBm)	PASS/FAIL
		CHAIN 0	CHAIN 1			
38	5190	-3.12	-2.23	0.36	2.28	PASS
46	5230	-5.19	-1.35	0.15	2.28	PASS

- NOTE:**
1. Method 1 of power density measurement of KDB 662911 is using for calculating total power density. Total power density is summing entire spectra across corresponding frequency bins on the various outputs by computer.
 2. Directional gain = $10 \log[(10^{G1/20} + 10^{G2/20})^2 / 2] = 7.72\text{dBi} > 6\text{dBi}$, so the power density limit shall be reduced to $4-(7.72-6) = 2.28\text{dBm}$.

4.5 PEAK POWER EXCURSION MEASUREMENT

4.5.1 LIMITS OF PEAK POWER EXCURSION MEASUREMENT

Shall not exceed 13 dB

4.5.2 TEST INSTRUMENTS

DESCRIPTION & MANUFACTURER	MODEL NO.	SERIAL NO.	CALIBRATED DATE	CALIBRATED UNTIL
R&S Spectrum Analyzer	FSP40	100037	Nov. 01, 2012	Oct. 31, 2013

Note:

1. The calibration interval of the above test instruments is 12 months and the calibrations are traceable to NML/ROC and NIST/USA.
2. Tested date : Apr. 11, 2013

4.5.3 TEST PROCEDURE

1. Set RBW = 1 MHz, VBW \geq 3 MHz, Detector = peak.
2. Trace mode = max-hold. Allow the sweeps to continue until the trace stabilizes.
3. Use the peak search function to find the peak of the spectrum.
4. Measure the PPSD.
5. Compute the ratio of the maximum of the peak-max-hold spectrum to the PPSD.

4.5.4 DEVIATION FROM TEST STANDARD

No deviation

4.5.5 TEST SETUP

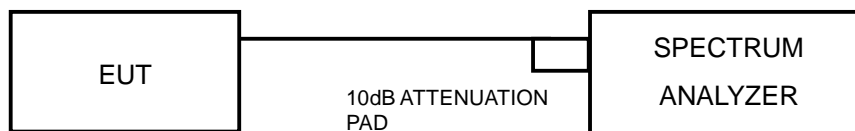

4.5.6 EUT OPERATING CONDITIONS

The software provided by client to enable the EUT under transmission condition continuously at specific channel frequencies individually.



A D T

4.5.7 TEST RESULTS

802.11a

CHANNEL	CHANNEL FREQUENCY (MHz)	PEAK VALUE (dBm)	PPSD (dBm)	PEAK EXCURSION (dB)	LIMIT (dB)	PASS/FAIL
36	5180	12.72	3.62	9.10	13	PASS
40	5200	12.88	3.73	9.15	13	PASS
48	5240	12.66	3.48	9.18	13	PASS

802.11n (HT20)

CHAN.	CHAN. FREQ. (MHz)	PEAK VALUE (dBm)		PPSD (dBm)		PEAK EXCURSION (dB)		LIMIT (dB)	PASS/FAIL
		CHAIN 0	CHAIN 1	CHAIN 0	CHAIN 1	CHAIN 0	CHAIN 1		
36	5180	6.87	7.59	-1.44	-0.61	8.31	8.20	13	PASS
40	5200	7.16	6.76	-1.12	-1.47	8.28	8.23	13	PASS
48	5240	6.41	7.18	-1.93	-1.03	8.34	8.21	13	PASS

802.11n (HT40)

CHAN.	CHAN. FREQ. (MHz)	PEAK VALUE (dBm)		PPSD (dBm)		PEAK EXCURSION (dB)		LIMIT (dB)	PASS/FAIL
		CHAIN 0	CHAIN 1	CHAIN 0	CHAIN 1	CHAIN 0	CHAIN 1		
38	5190	5.66	6.74	-3.12	-2.23	8.78	8.97	13	PASS
46	5230	4.64	6.83	-5.19	-1.35	9.83	8.18	13	PASS



A D T

4.6 FREQUENCY STABILITY

4.6.1 LIMITS OF FREQUENCY STABILITY MEASUREMENT

The frequency of the carrier signal shall be maintained within band of operation

4.6.2 TEST INSTRUMENTS

DESCRIPTION & MANUFACTURER	MODEL NO.	SERIAL NO.	CALIBRATED DATE	CALIBRATED UNTIL
R&S Spectrum Analyzer	FSP40	100037	Nov. 01, 2012	Oct. 31, 2013

Note:

1. The calibration interval of the above test instruments is 12 months and the calibrations are traceable to NML/ROC and NIST/USA.
2. Tested date : Apr. 11, 2013

4.6.3 TEST PROCEDURE

1. The EUT was placed inside the environmental test chamber and powered by nominal AC voltage.
2. Turn the EUT on and couple its output to a spectrum analyzer.
3. Turn the EUT off and set the chamber to the highest temperature specified.
4. Allow sufficient time (approximately 30 min) for the temperature of the chamber to stabilize, turn the EUT on and measure the operating frequency after 2, 5, and 10 minutes.
5. Repeat step 2 and 3 with the temperature chamber set to the lowest temperature.
6. The test chamber was allowed to stabilize at +20 degree C for a minimum of 30 minutes. The supply voltage was then adjusted on the EUT from 85% to 115% and the frequency record.

4.6.4 DEVIATION FROM TEST STANDARD

No deviation

4.6.5 TEST SETUP

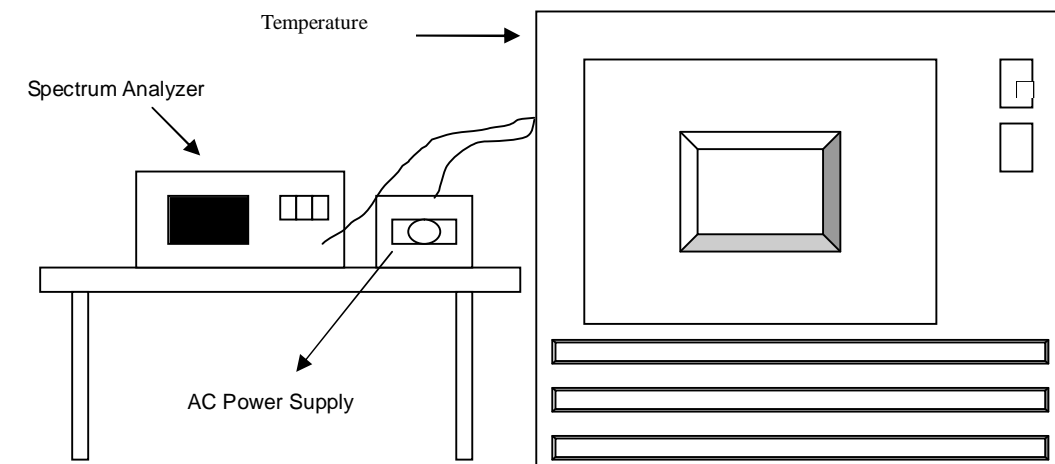

4.6.6 EUT OPERATING CONDITION

Set the EUT transmit at un-modulation mode to test frequency stability.



A D T

4.6.7 TEST RESULTS

FREQUENCY STABILITY VERSUS TEMP.									
OPERATING FREQUENCY: 5240MHz									
TEMP. (°C)	POWER SUPPLY (Vac)	0 MINUTE		2 MINUTE		5 MINUTE		10 MINUTE	
		Measured Frequency	Frequency Drift	Measured Frequency	Frequency Drift	Measured Frequency	Frequency Drift	Measured Frequency	Frequency Drift
		(MHz)	ppm	(MHz)	ppm	(MHz)	ppm	(MHz)	ppm
50	120	5239.9742	-4.9237	5239.9808	-3.6641	5239.9814	-3.5496	5239.9741	-4.9427
40	120	5240.022	4.1985	5240.023	4.3893	5240.0251	4.7901	5240.0256	4.8855
30	120	5239.9826	-3.3206	5239.9841	-3.0344	5239.9806	-3.7023	5239.9845	-2.9580
20	120	5239.9948	-0.9924	5240.0001	0.0191	5239.991	-1.7176	5240.0003	0.0573
10	120	5240.0074	1.4122	5240.0019	0.3626	5240.0061	1.1641	5240.0052	0.9924
0	120	5240.0133	2.5382	5240.0146	2.7863	5240.0173	3.3015	5240.0167	3.1870
-10	120	5240.0005	0.0954	5239.9946	-1.0305	5239.9947	-1.0115	5240.0015	0.2863
-20	120	5239.9823	-3.3779	5239.9822	-3.3969	5239.9782	-4.1603	5239.9789	-4.0267
-30	120	5240.0207	3.9504	5240.0182	3.4733	5240.0164	3.1298	5240.0194	3.7023

FREQUENCY STABILITY VERSUS VOLTAGE									
OPERATING FREQUENCY: 5240MHz									
TEMP. (°C)	POWER SUPPLY (Vac)	0 MINUTE		2 MINUTE		5 MINUTE		10 MINUTE	
		Measured Frequency	Frequency Drift	Measured Frequency	Frequency Drift	Measured Frequency	Frequency Drift	Measured Frequency	Frequency Drift
		(MHz)	ppm	(MHz)	ppm	(MHz)	ppm	(MHz)	ppm
20	138	5239.9947	-1.0115	5240.0006	0.1145	5239.9922	-1.4885	5240.0005	0.0954
	120	5239.9948	-0.9924	5240.0001	0.0191	5239.991	-1.7176	5240.0003	0.0573
	102	5239.9947	-1.0115	5239.9999	-0.0191	5239.9924	-1.4504	5240	0.0000



A D T

5. PHOTOGRAPHS OF THE TEST CONFIGURATION

Please refer to the attached file (Test Setup Photo).





6. INFORMATION ON THE TESTING LABORATORIES

We, Bureau Veritas Consumer Products Services (H.K.) Ltd., Taoyuan Branch, were founded in 1988 to provide our best service in EMC, Radio, Telecom and Safety consultation. Our laboratories are accredited and approved according to ISO/IEC 17025.

If you have any comments, please feel free to contact us at the following:

Linko EMC/RF Lab:

Tel: 886-2-26052180

Fax: 886-2-26052943

Hsin Chu EMC/RF Lab:

Tel: 886-3-5935343

Fax: 886-3-5935342

Hwa Ya EMC/RF/Safety/Telecom Lab:

Tel: 886-3-3183232

Fax: 886-3-3270892

Email: service.adt@tw.bureauveritas.com

Web Site: www.bureauveritas-adt.com

The address and road map of all our labs can be found in our web site also.



A D T

7.APPENDIX A - MODIFICATIONS RECORDERS FOR ENGINEERING CHANGES TO THE EUT BY THE LAB

No modifications were made to the EUT by the lab during the test.

--- END ---