



# FCC TEST REPORT (15.407)

**REPORT NO.:** RF111124C12-1

**MODEL NO.:** TEW-751DR

**FCC ID:** XU8TEW751DR

**RECEIVED:** Nov. 14, 2011

**TESTED:** Nov. 14 ~ Dec. 06, 2011

**ISSUED:** Dec. 09, 2011

**APPLICANT:** TRENDNET, Inc.

**ADDRESS:** 20675 Manhattan Place, Torrance, CA 90501,  
USA

**ISSUED BY:** Bureau Veritas Consumer Products Services  
(H.K.) Ltd., Taoyuan Branch

**LAB ADDRESS:** No. 47, 14th Ling, Chia Pau Vil., Lin Kou Dist.,  
New Taipei City, Taiwan ( R.O.C )

**TEST LOCATION:** No. 19, Hwa Ya 2nd Rd, Wen Hwa Tsuen, Kwei  
Shan Hsiang, Taoyuan Hsien 333, Taiwan, R.O.C.

This test report consists of 49 pages in total. It may be duplicated completely for legal use with the approval of the applicant. It should not be reproduced except in full, without the written approval of our laboratory. The client should not use it to claim product, certification, approval or endorsement by TAF or any government agency. The test results in the report only apply to the tested sample.



## TABLE OF CONTENTS

RELEASE CONTROL RECORD .....	4
1. CERTIFICATION .....	5
2. SUMMARY OF TEST RESULTS .....	6
2.1 MEASUREMENT UNCERTAINTY .....	6
3. GENERAL INFORMATION .....	7
3.1 GENERAL DESCRIPTION OF EUT .....	7
3.2 DESCRIPTION OF TEST MODES .....	8
3.2.1 CONFIGURATION OF SYSTEM UNDER TEST .....	9
3.2.2 TEST MODE APPLICABILITY AND TESTED CHANNEL DETAIL .....	10
3.3 GENERAL DESCRIPTION OF APPLIED STANDARDS .....	12
3.4 DESCRIPTION OF SUPPORT UNITS .....	12
4. TEST TYPES AND RESULTS .....	13
4.1 RADIATED EMISSION MEASUREMENT .....	13
4.1.1 LIMITS OF RADIATED EMISSION MEASUREMENT .....	13
4.1.2 LIMITS OF UNWANTED EMISSION OUT OF THE RESTRICTED BANDS .....	13
4.1.3 TEST INSTRUMENTS .....	14
4.1.4 TEST PROCEDURES .....	15
4.1.5 DEVIATION FROM TEST STANDARD .....	15
4.1.6 TEST SETUP .....	16
4.1.7 EUT OPERATING CONDITION .....	16
4.1.8 TEST RESULTS .....	17
4.2 CONDUCTED EMISSION MEASUREMENT .....	26
4.2.1 LIMITS OF CONDUCTED EMISSION MEASUREMENT .....	26
4.2.2 TEST INSTRUMENTS .....	26
4.2.3 TEST PROCEDURES .....	27
4.2.4 DEVIATION FROM TEST STANDARD .....	27
4.2.5 TEST SETUP .....	28
4.2.6 EUT OPERATING CONDITIONS .....	28
4.2.7 TEST RESULTS .....	29
4.3 PEAK TRANSMIT POWER MEASUREMENT .....	31
4.3.1 LIMITS OF PEAK TRANSMIT POWER MEASUREMENT .....	31
4.3.2 TEST SETUP .....	31
4.3.3 TEST INSTRUMENTS .....	31
4.3.4 TEST PROCEDURE .....	32
4.3.5 DEVIATION FROM TEST STANDARD .....	32



4.3.6	EUT OPERATING CONDITIONS .....	32
4.3.7	TEST RESULTS .....	33
4.4	PEAK POWER EXCURSION MEASUREMENT .....	35
4.4.1	LIMITS OF PEAK POWER EXCURSION MEASUREMENT.....	35
4.4.2	TEST SETUP .....	35
4.4.3	TEST INSTRUMENTS .....	35
4.4.4	TEST PROCEDURE .....	35
4.4.5	DEVIATION FROM TEST STANDARD .....	35
4.4.6	EUT OPERATING CONDITIONS.....	35
4.4.7	TEST RESULTS .....	36
4.5	PEAK POWER SPECTRAL DENSITY MEASUREMENT .....	42
4.5.1	LIMITS OF PEAK POWER SPECTRAL DENSITY MEASUREMENT.....	42
4.5.2	TEST SETUP .....	42
4.5.3	TEST INSTRUMENTS .....	42
4.5.4	TEST PROCEDURES .....	42
4.5.5	DEVIATION FROM TEST STANDARD .....	42
4.5.6	EUT OPERATING CONDITIONS.....	42
4.5.7	TEST RESULTS .....	43
4.6	FREQUENCY STABILITY .....	44
4.6.1	LIMITS OF FREQUENCY STABILITY MEASUREMENT .....	44
4.6.2	TEST SETUP .....	44
4.6.3	TEST INSTRUMENTS .....	44
4.6.4	TEST PROCEDURE .....	45
4.6.5	DEVIATION FROM TEST STANDARD .....	45
4.6.6	EUT OPERATING CONDITION .....	45
4.6.7	TEST RESULTS .....	46
5.	PHOTOGRAPHS OF THE TEST CONFIGURATION.....	47
6.	INFORMATION ON THE TESTING LABORATORIES .....	48
7.	APPENDIX A - MODIFICATIONS RECORDERS FOR ENGINEERING CHANGES TO THE EUT BY THE LAB.....	49



A D T

## RELEASE CONTROL RECORD

ISSUE NO.	REASON FOR CHANGE	DATE ISSUED
Original release	NA	Dec. 09, 2011



## 1. CERTIFICATION

**PRODUCT:** Wireless Router

**MODEL:** TEW-751DR

**BRAND:** TRENDnet

**APPLICANT:** TRENDNET, Inc.

**TESTED:** Nov. 14 ~ Dec. 06, 2011

**TEST SAMPLE:** ENGINEERING SAMPLE

**STANDARDS:** **FCC Part 15, Subpart E (Section 15.407)**

ANSI C63.4-2003

ANSI C63.10-2009

The above equipment (Model: TEW-751DR) has been tested by **Bureau Veritas Consumer Products Services (H.K.) Ltd., Taoyuan Branch**, and found compliance with the requirement of the above standards. The test record, data evaluation & Equipment Under Test (EUT) configurations represented herein are true and accurate accounts of the measurements of the sample's EMC characteristics under the conditions specified in this report.

PREPARED BY :  , DATE: Dec. 09, 2011  
Pettie Chen / Specialist

APPROVED BY :  , DATE: Dec. 09, 2011  
Gary Chang / Technical Manager

## 2. SUMMARY OF TEST RESULTS

The EUT has been tested according to the following specifications:

<b>APPLIED STANDARD: FCC PART 15, SUBPART E (SECTION 15.407)</b>			
<b>STANDARD SECTION</b>	<b>TEST TYPE AND LIMIT</b>	<b>RESULT</b>	<b>REMARK</b>
15.407(b)(5)	AC Power Conducted Emission	PASS	Meet the requirement of limit. Minimum passing margin is -13.50dB at 0.166MHz.
15.407(b)(1/2/3) (b)(5)	Radiated spurious emission	PASS	Meet the requirement of limit. Minimum passing margin is -1.1dB at 10360.00MHz.
15.407(a)(1/2/3)	Peak Transmit Power	PASS	Meet the requirement of limit.
15.407(a)(6)	Peak Power Excursion	PASS	Meet the requirement of limit.
15.407(a)(1/2/3)	Peak Power Spectral Density	PASS	Meet the requirement of limit.
15.407(g)	Frequency Stability	PASS	Meet the requirement of limit.
15.203	Antenna Requirement	PASS	Antenna connector is UFL not a standard connector.

### 2.1 MEASUREMENT UNCERTAINTY

Where relevant, the following measurement uncertainty levels have been estimated for tests performed on the EUT as specified in CISPR 16-4-2:

<b>MEASUREMENT</b>	<b>FREQUENCY</b>	<b>UNCERTAINTY</b>
Conducted emissions	150kHz~30MHz	2.44 dB
Radiated emissions	30MHz ~ 200MHz	2.93 dB
	200MHz ~1000MHz	2.95 dB
	1GHz ~ 18GHz	2.26 dB
	18GHz ~ 40GHz	1.94 dB

This uncertainty represents an expanded uncertainty expressed at approximately the 95% confidence level using a coverage factor of  $k = 2$ .

### 3. GENERAL INFORMATION

#### 3.1 GENERAL DESCRIPTION OF EUT

<b>EUT</b>	Wireless Router
<b>MODEL NO.</b>	TEW-751DR
<b>FCC ID</b>	XU8TEW751DR
<b>POWER SUPPLY</b>	12Vdc (adapter)
<b>MODULATION TYPE</b>	64QAM, 16QAM, QPSK, BPSK
<b>MODULATION TECHNOLOGY</b>	OFDM
<b>TRANSFER RATE</b>	802.11a: 54.0/ 48.0/ 36.0/ 24.0/ 18.0/ 12.0/ 9.0/ 6.0Mbps 802.11n: up to 300.0Mbps
<b>OPERATING FREQUENCY</b>	5180.0 ~ 5240.0MHz
<b>NUMBER OF CHANNEL</b>	4 for 802.11a, 802.11n (20MHz) 2 for 802.11n (40MHz)
<b>OUTPUT POWER</b>	40.8mW
<b>ANTENNA TYPE</b>	Dipole antenna with 2dBi gain
<b>ANTENNA CONNECTOR</b>	UFL
<b>DATA CABLE</b>	NA
<b>I/O PORTS</b>	Refer to user's manual
<b>ACCESSORY DEVICES</b>	Adapter

**NOTE:**

1. The frequency bands used in this EUT are listed as follows:

Frequency Band (MHz)	2412~2462	5180~5240	5745~5825
802.11b	√		
802.11g	√		
802.11a		√	√
802.11n (20MHz)	√	√	√
802.11n (40MHz)	√	√	√

2. The EUT incorporates a MIMO function. Physically, the EUT provides two completed transmitters and two receivers.

MODULATION MODE	TX FUNCTION
802.11b	1TX
802.11g	1TX
802.11a	1TX
802.11n (20MHz)	2TX
802.11n (40MHz)	2TX

3. The EUT is powered by the following adapter.

<b>BRAND:</b>	CWT
<b>MODEL:</b>	CAP012121 US
<b>INPUT:</b>	100-240Vac, 47-63Hz, 0.35A
<b>OUTPUT:</b>	12Vdc, 1.0A
<b>POWER LINE:</b>	1.1m non-shielded cable without core

4. The above EUT information is declared by the manufacturer and for more detailed features description, please refer to the manufacturer's specifications or User's Manual.

### 3.2 DESCRIPTION OF TEST MODES

4 channels are provided for 802.11a, 802.11n (20MHz):

CHANNEL	FREQUENCY	CHANNEL	FREQUENCY
36	5180MHz	44	5220MHz
40	5200MHz	48	5240MHz

2 channels are provided for 802.11n (40MHz):

CHANNEL	FREQUENCY	CHANNEL	FREQUENCY
38	5190MHz	46	5230MHz



### 3.2.1 CONFIGURATION OF SYSTEM UNDER TEST

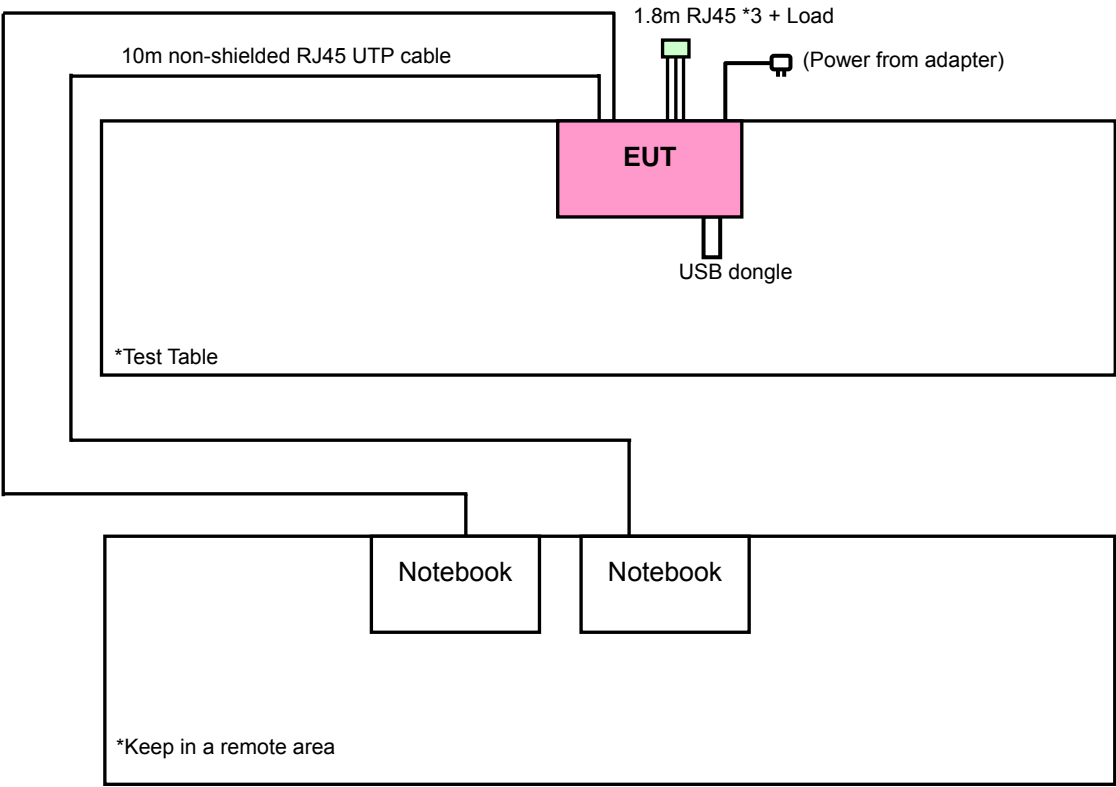

### 3.2.2 TEST MODE APPLICABILITY AND TESTED CHANNEL DETAIL

EUT CONFIGURE MODE	APPLICABLE TO				DESCRIPTION
	RE $\geq$ 1G	RE<1G	PLC	APCM	
-	√	√	√	√	-

Where **RE $\geq$ 1G**: Radiated Emission above 1GHz      **RE<1G**: Radiated Emission below 1GHz  
**PLC**: Power Line Conducted Emission      **APCM**: Antenna Port Conducted Measurement

#### RADIATED EMISSION TEST (ABOVE 1GHz):

- Pre-Scan has been conducted to determine the worst-case mode from all possible combinations between available modulations, data rates, XYZ axis and antenna ports (if EUT with antenna diversity architecture).
- Following channel(s) was (were) selected for the final test as listed below.

EUT CONFIGURE MODE	MODE	AVAILABLE CHANNEL	TESTED CHANNEL	MODULATION TECHNOLOGY	MODULATION TYPE	DATA RATE (Mbps)	AXIS
-	802.11a	36 to 48	36, 40, 48	OFDM	BPSK	6.0	Z
-	802.11n (20MHz)	36 to 48	36, 40, 48	OFDM	BPSK	7.2	Z
-	802.11n (40MHz)	38 to 46	38, 46	OFDM	BPSK	15.0	Z

#### RADIATED EMISSION TEST (BELOW 1GHz):

- Pre-Scan has been conducted to determine the worst-case mode from all possible combinations between available modulations, data rates, XYZ axis and antenna ports (if EUT with antenna diversity architecture).
- Following channel(s) was (were) selected for the final test as listed below.

EUT CONFIGURE MODE	MODE	AVAILABLE CHANNEL	TESTED CHANNEL	MODULATION TECHNOLOGY	MODULATION TYPE	DATA RATE (Mbps)	AXIS
-	802.11n (40MHz)	38 to 46	46	OFDM	BPSK	15.0	Z

#### POWER LINE CONDUCTED EMISSION TEST:

- Pre-Scan has been conducted to determine the worst-case mode from all possible combinations between available modulations, data rates and antenna ports (if EUT with antenna diversity architecture).
- Following channel(s) was (were) selected for the final test as listed below.

EUT CONFIGURE MODE	MODE	AVAILABLE CHANNEL	TESTED CHANNEL	MODULATION TECHNOLOGY	MODULATION TYPE	DATA RATE (Mbps)
-	802.11n (40MHz)	38 to 46	46	OFDM	BPSK	15.0

**BANDEDGE MEASUREMENT:**

- Pre-Scan has been conducted to determine the worst-case mode from all possible combinations between available modulations, data rates, XYZ axis and antenna ports (if EUT with antenna diversity architecture).
- Following channel(s) was (were) selected for the final test as listed below.

EUT CONFIGURE MODE	MODE	AVAILABLE CHANNEL	TESTED CHANNEL	MODULATION TECHNOLOGY	MODULATION TYPE	DATA RATE (Mbps)	AXIS
-	802.11a	36 to 48	36, 48	OFDM	BPSK	6.0	Z
-	802.11n (20MHz)	36 to 48	36, 48	OFDM	BPSK	7.2	Z
-	802.11n (40MHz)	38 to 46	38, 46	OFDM	BPSK	15.0	Z

**ANTENNA PORT CONDUCTED MEASUREMENT:**

- Pre-Scan has been conducted to determine the worst-case mode from all possible combinations between available modulations, data rates and antenna ports (if EUT with antenna diversity architecture).
- Following channel(s) was (were) selected for the final test as listed below.

EUT CONFIGURE MODE	MODE	AVAILABLE CHANNEL	TESTED CHANNEL	MODULATION TECHNOLOGY	MODULATION TYPE	DATA RATE (Mbps)
-	802.11a	36 to 48	36, 40, 48	OFDM	BPSK	6.0
-	802.11n (20MHz)	36 to 48	36, 40, 48	OFDM	BPSK	7.2
-	802.11n (40MHz)	38 to 46	38, 46	OFDM	BPSK	15.0

**TEST CONDITION:**

APPLICABLE TO	ENVIRONMENTAL CONDITIONS	INPUT POWER	TESTED BY
RE≥1G	25deg. C, 65%RH	120Vac, 60Hz	Sun Lin
RE<1G	25deg. C, 65%RH	120Vac, 60Hz	Sun Lin
PLC	25deg. C, 65%RH	120Vac, 60Hz	Anderson Hong
APCM	25deg. C, 68%RH	120Vac, 60Hz	Sun Lin

### 3.3 GENERAL DESCRIPTION OF APPLIED STANDARDS

The EUT is a RF Product. According to the specifications of the manufacturer, it must comply with the requirements of the following standards:

**FCC Part 15, Subpart E (15.407)**

**ANSI C63.4-2003**

**ANSI C63.10-2009**

All test items have been performed and recorded as per the above standards.

**NOTE:** The EUT is also considered as a kind of computer peripheral, because the connection to computer is necessary for typical use. It has been verified to comply with the requirements of FCC Part 15, Subpart B, Class B (DoC). The test report has been issued separately.

### 3.4 DESCRIPTION OF SUPPORT UNITS

The EUT has been tested as an independent unit together with other necessary accessories or support units. The following support units or accessories were used to form a representative test configuration during the tests.

NO.	PRODUCT	BRAND	MODEL NO.	SERIAL NO.	FCC ID
1	NOTEBOOK	DELL	D531	CN-0XM006-48643-81U-2786	QDS-BRCM1020
2	NOTEBOOK	DELL	D531	CN-0XM006-48643-81U-2973	QDS-BRCM1020
3	USB DONGLE	Transcend	V85	538455 4481	NA

NO.	SIGNAL CABLE DESCRIPTION OF THE ABOVE SUPPORT UNITS
1	10m RJ45 UTP cable without core.
2	10m RJ45 UTP cable without core.
3	NA

**NOTE:**

1. All power cords of the above support units are non-shielded (1.8m).
2. Item 1, 2 acted communication partners to transfer data.

## 4. TEST TYPES AND RESULTS

### 4.1 RADIATED EMISSION MEASUREMENT

#### 4.1.1 LIMITS OF RADIATED EMISSION MEASUREMENT

Emissions radiated outside of the specified bands, shall be according to the general radiated limits in 15.209 as following:

FREQUENCIES (MHz)	FIELD STRENGTH (microvolts/meter)	MEASUREMENT DISTANCE (meters)
0.009 ~ 0.490	2400/F(kHz)	300
0.490 ~ 1.705	24000/F(kHz)	30
1.705 ~ 30.0	30	30
30 ~ 88	100	3
88 ~ 216	150	3
216 ~ 960	200	3
Above 960	500	3

**NOTE:**

1. The lower limit shall apply at the transition frequencies.
2. Emission level (dBuV/m) = 20 log Emission level (uV/m).
3. As shown in 15.35(b), for frequencies above 1000MHz, the field strength limits are based on average detector, however, the peak field strength of any emission shall not exceed the maximum permitted average limits, specified above by more than 20dB under any condition of modulation.

#### 4.1.2 LIMITS OF UNWANTED EMISSION OUT OF THE RESTRICTED BANDS

FREQUENCIES (MHz)	EIRP LIMIT (dBm)	EQUIVALENT FIELD STRENGTH AT 3m (dBµV/m) *NOTE 3
	PK	PK
5150 ~ 5250	-27	68.3

**NOTE:** The following formula is used to convert the equipment isotropic radiated power (eirp) to field strength:

$$E = \frac{1000000\sqrt{30P}}{3} \mu\text{V/m, where P is the eirp (Watts).}$$



#### 4.1.3 TEST INSTRUMENTS

DESCRIPTION & MANUFACTURER	MODEL NO.	SERIAL NO.	DATE OF CALIBRATION	DUE DATE OF CALIBRATION
Test Receiver ROHDE & SCHWARZ	ESCI	100744	Apr. 19, 2011	Apr. 18, 2012
Spectrum Analyzer ROHDE & SCHWARZ	FSP40	100269	Jan. 06, 2011	Jan. 05, 2012
BILOG Antenna SCHWARZBECK	VULB9168	9168-156	Apr. 12, 2011	Apr. 11, 2012
HORN Antenna SCHWARZBECK	BBHA 9120 D	9120D-563	Sep. 06, 2011	Sep. 05, 2012
HORN Antenna SCHWARZBECK	BBHA 9170	BBHA9170243	Dec. 27, 2010	Dec. 26, 2011
Preamplifier Agilent	8449B	3008A01911	Oct. 29, 2011	Oct. 28, 2012
Preamplifier Agilent	8447D	2944A10638	Oct. 29, 2011	Oct. 28, 2012
RF signal cable HUBER+SUHNNER	SUCOFLEX 104	295013/4 283403/4	Aug. 19, 2011	Aug. 18, 2012
RF signal cable Worken	8D-FB	Cable-HYCH9-01	Aug. 13, 2011	Aug. 12, 2012
Software	ADT_Radiated_ V7.6.15.9.2	NA	NA	NA
Antenna Tower EMCO	2070/2080	512.835.4684	NA	NA
Turn Table EMCO	2087-2.03	NA	NA	NA
Antenna Tower & Turn Table Controller EMCO	2090	NA	NA	NA
26GHz ~ 40GHz Amplifier	EM26400	815221	Oct. 29, 2011	Oct. 28, 2012
High Speed Peak Power Meter	ML2495A	0824011	Aug. 04, 2011	Aug. 03, 2012
Power Sensor	MA2411B	0738171	Aug. 04, 2011	Aug. 03, 2012

- NOTE:**
1. The calibration interval of the above test instruments is 12 months and the calibrations are traceable to NML/ROC and NIST/USA.
  2. The test was performed in HwaYa Chamber 9.
  3. The horn antenna and HP preamplifier (model: 8449B) are used only for the measurement of emission frequency above 1GHz if tested.
  4. The FCC Site Registration No. is 460141.
  5. The IC Site Registration No. is IC 7450F-4.

#### 4.1.4 TEST PROCEDURES

- a. The EUT was placed on the top of a rotating table 0.8 meters above the ground at a 3 meter semi-anechoic chamber. The table was rotated 360 degrees to determine the position of the highest radiation.
- b. The EUT was set 3 meters away from the interference-receiving antenna, which was mounted on the top of a variable-height antenna tower.
- c. The antenna is a broadband antenna, and its height is varied from one meter to four meters above the ground to determine the maximum value of the field strength. Both horizontal and vertical polarizations of the antenna are set to make the measurement.
- d. For each suspected emission, the EUT was arranged to its worst case and then the antenna was tuned to heights from 1 meter to 4 meters and the rotatable table was turned from 0 degrees to 360 degrees to find the maximum reading.
- e. The test-receiver system was set to Peak Detect Function and Specified Bandwidth with Maximum Hold Mode.
- f. If the emission level of the EUT in peak mode was 10dB lower than the limit specified, then testing could be stopped and the peak values of the EUT would be reported. Otherwise the emissions that did not have 10dB margin would be re-tested one by one using peak, quasi-peak or average method as specified and then reported in a data sheet.

**NOTE:**

1. The resolution bandwidth and video bandwidth of test receiver/spectrum analyzer is 120kHz for Peak detection (PK) and Quasi-peak detection (QP) at frequency below 1GHz.
2. The resolution bandwidth of test receiver/spectrum analyzer is 1MHz and video bandwidth is 3MHz for Peak detection at frequency above 1GHz.
3. The resolution bandwidth of test receiver/spectrum analyzer is 1MHz and the video bandwidth is 1kHz for Average detection (AV) at frequency above 1GHz.
4. All modes of operation were investigated and the worst-case emissions are reported.

#### 4.1.5 DEVIATION FROM TEST STANDARD

No deviation.

#### 4.1.6 TEST SETUP

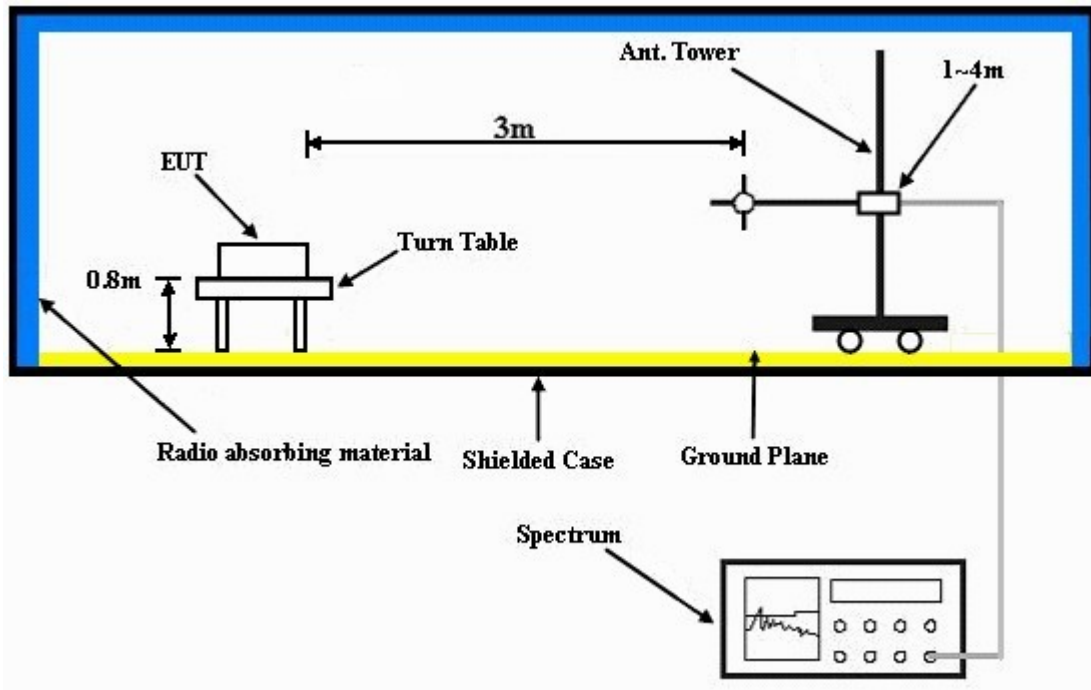

For the actual test configuration, please refer to the attached file (Test Setup Photo).

#### 4.1.7 EUT OPERATING CONDITION

- a. Placed the EUT on the testing table.
- b. Prepared notebooks to act as communication partner and placed it outside of testing area.
- c. The communication partner connected with EUT via a RJ45 cable and run a test program (provided by manufacturer) to enable EUT under transmission condition continuously at specific channel frequency.
- d. The communication partner sent data to EUT by command "PING".
- e. The communication partner read and wrote with the USB dongle via EUT.



## 4.1.8 TEST RESULTS

### 802.11a

EUT TEST CONDITION		MEASUREMENT DETAIL	
CHANNEL	Channel 36	FREQUENCY RANGE	1 ~ 40GHz
INPUT POWER (SYSTEM)	120Vac, 60 Hz	DETECTOR FUNCTION	Peak (PK) Average (AV)
ENVIRONMENTAL CONDITIONS	25deg. C, 65%RH	TESTED BY	Sun Lin

ANTENNA POLARITY & TEST DISTANCE: HORIZONTAL AT 3 M								
NO.	FREQ. (MHz)	EMISSION LEVEL (dBuV/m)	LIMIT (dBuV/m)	MARGIN (dB)	ANTENNA HEIGHT (m)	TABLE ANGLE (Degree)	RAW VALUE (dBuV)	CORRECTION FACTOR (dB/m)
1	5150.00	49.6 PK	74.0	-24.4	1.07 H	87	11.20	38.40
2	5150.00	35.1 AV	54.0	-18.9	1.07 H	87	-3.30	38.40
3	*5180.00	99.1 PK			1.07 H	87	60.70	38.40
4	*5180.00	90.0 AV			1.07 H	87	51.60	38.40
5	#10360.00	67.2 PK	68.3	-1.1	1.34 H	355	18.90	48.30
6	15540.00	67.4 PK	74.0	-6.6	1.00 H	31	17.70	49.70
7	15540.00	49.2 AV	54.0	-4.8	1.00 H	31	-0.50	49.70
ANTENNA POLARITY & TEST DISTANCE: VERTICAL AT 3 M								
NO.	FREQ. (MHz)	EMISSION LEVEL (dBuV/m)	LIMIT (dBuV/m)	MARGIN (dB)	ANTENNA HEIGHT (m)	TABLE ANGLE (Degree)	RAW VALUE (dBuV)	CORRECTION FACTOR (dB/m)
1	5150.00	58.5 PK	74.0	-15.5	1.52 V	231	20.10	38.40
2	5150.00	42.6 AV	54.0	-11.4	1.52 V	231	4.20	38.40
3	*5180.00	106.4 PK			1.39 V	227	68.00	38.40
4	*5180.00	96.8 AV			1.39 V	227	58.40	38.40
5	#10360.00	66.8 PK	68.3	-1.5	1.21 V	160	18.50	48.30
6	15540.00	64.1 PK	74.0	-9.9	1.48 V	178	14.40	49.70
7	15540.00	47.9 AV	54.0	-6.1	1.48 V	178	-1.80	49.70

- REMARKS:**
1. Emission level (dBuV/m) = Raw Value (dBuV) + Correction Factor (dB/m).
  2. Correction Factor (dB/m) = Antenna Factor (dB/m) + Cable Factor (dB).
  3. The other emission levels were very low against the limit.
  4. Margin value = Emission level – Limit value.
  5. “ \* “: Fundamental frequency.
  6. “#”:The radiated frequency is out the restricted band.



EUT TEST CONDITION		MEASUREMENT DETAIL	
CHANNEL	Channel 40	FREQUENCY RANGE	1 ~ 40GHz
INPUT POWER (SYSTEM)	120Vac, 60 Hz	DETECTOR FUNCTION	Peak (PK) Average (AV)
ENVIRONMENTAL CONDITIONS	25deg. C, 65%RH	TESTED BY	Sun Lin

ANTENNA POLARITY & TEST DISTANCE: HORIZONTAL AT 3 M								
NO.	FREQ. (MHz)	EMISSION LEVEL (dBuV/m)	LIMIT (dBuV/m)	MARGIN (dB)	ANTENNA HEIGHT (m)	TABLE ANGLE (Degree)	RAW VALUE (dBuV)	CORRECTION FACTOR (dB/m)
1	5150.00	45.9 PK	74.0	-28.1	1.20 H	90	7.50	38.40
2	5150.00	33.2 AV	54.0	-20.8	1.20 H	90	-5.20	38.40
3	*5200.00	98.6 PK			1.20 H	90	60.20	38.40
4	*5200.00	89.5 AV			1.20 H	90	51.10	38.40
5	#10400.00	67.1 PK	68.3	-1.2	1.34 H	338	18.70	48.40
6	15600.00	67.6 PK	74.0	-6.4	1.00 H	33	18.10	49.50
7	15600.00	49.6 AV	54.0	-4.4	1.00 H	33	0.10	49.50
ANTENNA POLARITY & TEST DISTANCE: VERTICAL AT 3 M								
NO.	FREQ. (MHz)	EMISSION LEVEL (dBuV/m)	LIMIT (dBuV/m)	MARGIN (dB)	ANTENNA HEIGHT (m)	TABLE ANGLE (Degree)	RAW VALUE (dBuV)	CORRECTION FACTOR (dB/m)
1	5150.00	51.0 PK	74.0	-23.0	1.00 V	349	12.60	38.40
2	5150.00	37.7 AV	54.0	-16.3	1.00 V	349	-0.70	38.40
3	*5200.00	106.2 PK			1.00 V	349	67.80	38.40
4	*5200.00	96.8 AV			1.00 V	349	58.40	38.40
5	#10400.00	65.6 PK	68.3	-2.7	1.11 V	345	17.20	48.40
6	15600.00	64.8 PK	74.0	-9.2	1.15 V	348	15.30	49.50
7	15600.00	48.0 AV	54.0	-6.0	1.15 V	348	-1.50	49.50

- REMARKS:**
1. Emission level (dBuV/m) = Raw Value (dBuV) + Correction Factor (dB/m).
  2. Correction Factor (dB/m) = Antenna Factor (dB/m) + Cable Factor (dB).
  3. The other emission levels were very low against the limit.
  4. Margin value = Emission level – Limit value.
  5. “ \* “: Fundamental frequency.
  6. “#”:The radiated frequency is out the restricted band.



A D T

EUT TEST CONDITION		MEASUREMENT DETAIL	
CHANNEL	Channel 48	FREQUENCY RANGE	1 ~ 40GHz
INPUT POWER (SYSTEM)	120Vac, 60 Hz	DETECTOR FUNCTION	Peak (PK) Average (AV)
ENVIRONMENTAL CONDITIONS	25deg. C, 65%RH	TESTED BY	Sun Lin

ANTENNA POLARITY & TEST DISTANCE: HORIZONTAL AT 3 M								
NO.	FREQ. (MHz)	EMISSION LEVEL (dBuV/m)	LIMIT (dBuV/m)	MARGIN (dB)	ANTENNA HEIGHT (m)	TABLE ANGLE (Degree)	RAW VALUE (dBuV)	CORRECTION FACTOR (dB/m)
1	*5240.00	98.1 PK			1.06 H	88	59.60	38.50
2	*5240.00	88.8 AV			1.06 H	88	50.30	38.50
3	5350.00	46.7 PK	74.0	-27.3	1.06 H	88	8.00	38.70
4	5350.00	32.9 AV	54.0	-21.1	1.06 H	88	-5.80	38.70
5	#10480.00	67.0 PK	68.3	-1.3	1.31 H	351	18.50	48.50
6	15720.00	67.7 PK	74.0	-6.3	1.00 H	32	18.50	49.20
7	15720.00	49.3 AV	54.0	-4.7	1.00 H	32	0.10	49.20
ANTENNA POLARITY & TEST DISTANCE: VERTICAL AT 3 M								
NO.	FREQ. (MHz)	EMISSION LEVEL (dBuV/m)	LIMIT (dBuV/m)	MARGIN (dB)	ANTENNA HEIGHT (m)	TABLE ANGLE (Degree)	RAW VALUE (dBuV)	CORRECTION FACTOR (dB/m)
1	*5240.00	105.7 PK			1.20 V	54	67.20	38.50
2	*5240.00	96.5 AV			1.20 V	54	58.00	38.50
3	5350.00	49.6 PK	74.0	-24.4	1.20 V	238	10.90	38.70
4	5350.00	37.3 AV	54.0	-16.7	1.20 V	238	-1.40	38.70
5	#10480.00	66.9 PK	68.3	-1.4	1.35 V	161	18.40	48.50
6	15720.00	60.5 PK	74.0	-13.5	1.20 V	159	11.30	49.20
7	15720.00	46.7 AV	54.0	-7.3	1.20 V	159	-2.50	49.20

- REMARKS:**
1. Emission level (dBuV/m) = Raw Value (dBuV) + Correction Factor (dB/m).
  2. Correction Factor (dB/m) = Antenna Factor (dB/m) + Cable Factor (dB).
  3. The other emission levels were very low against the limit.
  4. Margin value = Emission level – Limit value.
  5. “ \* “: Fundamental frequency.
  6. “#”:The radiated frequency is out the restricted band.

### 802.11n (20MHz)

EUT TEST CONDITION		MEASUREMENT DETAIL	
CHANNEL	Channel 36	FREQUENCY RANGE	1 ~ 40GHz
INPUT POWER (SYSTEM)	120Vac, 60 Hz	DETECTOR FUNCTION	Peak (PK) Average (AV)
ENVIRONMENTAL CONDITIONS	25deg. C, 65%RH	TESTED BY	Sun Lin

ANTENNA POLARITY & TEST DISTANCE: HORIZONTAL AT 3 M								
NO.	FREQ. (MHz)	EMISSION LEVEL (dBuV/m)	LIMIT (dBuV/m)	MARGIN (dB)	ANTENNA HEIGHT (m)	TABLE ANGLE (Degree)	RAW VALUE (dBuV)	CORRECTION FACTOR (dB/m)
1	5150.00	45.4 PK	74.0	-28.6	1.08 H	2	7.00	38.40
2	5150.00	34.2 AV	54.0	-19.8	1.08 H	2	-4.20	38.40
3	*5180.00	100.0 PK			1.08 H	2	61.60	38.40
4	*5180.00	88.2 AV			1.08 H	2	49.80	38.40
5	#10360.00	67.0 PK	68.3	-1.3	1.35 H	1	18.70	48.30
6	15540.00	63.3 PK	74.0	-10.7	1.00 H	33	13.60	49.70
7	15540.00	48.1 AV	54.0	-5.9	1.00 H	33	-1.60	49.70
ANTENNA POLARITY & TEST DISTANCE: VERTICAL AT 3 M								
NO.	FREQ. (MHz)	EMISSION LEVEL (dBuV/m)	LIMIT (dBuV/m)	MARGIN (dB)	ANTENNA HEIGHT (m)	TABLE ANGLE (Degree)	RAW VALUE (dBuV)	CORRECTION FACTOR (dB/m)
1	5150.00	55.4 PK	74.0	-18.6	1.39 V	237	17.00	38.40
2	5150.00	42.4 AV	54.0	-11.6	1.39 V	237	4.00	38.40
3	*5180.00	110.7 PK			1.39 V	234	72.30	38.40
4	*5180.00	99.0 AV			1.39 V	234	60.60	38.40
5	#10360.00	67.1 PK	68.3	-1.2	1.12 V	186	18.80	48.30
6	15540.00	60.7 PK	74.0	-13.3	1.31 V	219	11.00	49.70
7	15540.00	47.3 AV	54.0	-6.7	1.31 V	219	-2.40	49.70

- REMARKS:**
1. Emission level (dBuV/m) = Raw Value (dBuV) + Correction Factor (dB/m).
  2. Correction Factor (dB/m) = Antenna Factor (dB/m) + Cable Factor (dB).
  3. The other emission levels were very low against the limit.
  4. Margin value = Emission level – Limit value.
  5. “ \* “: Fundamental frequency.
  6. “#”:The radiated frequency is out the restricted band.



A D T

EUT TEST CONDITION		MEASUREMENT DETAIL	
CHANNEL	Channel 40	FREQUENCY RANGE	1 ~ 40GHz
INPUT POWER (SYSTEM)	120Vac, 60 Hz	DETECTOR FUNCTION	Peak (PK) Average (AV)
ENVIRONMENTAL CONDITIONS	25deg. C, 65%RH	TESTED BY	Sun Lin

ANTENNA POLARITY & TEST DISTANCE: HORIZONTAL AT 3 M								
NO.	FREQ. (MHz)	EMISSION LEVEL (dBuV/m)	LIMIT (dBuV/m)	MARGIN (dB)	ANTENNA HEIGHT (m)	TABLE ANGLE (Degree)	RAW VALUE (dBuV)	CORRECTION FACTOR (dB/m)
1	5150.00	45.4 PK	74.0	-28.6	1.09 H	1	7.00	38.40
2	5150.00	33.7 AV	54.0	-20.3	1.09 H	1	-4.70	38.40
3	*5200.00	99.6 PK			1.09 H	1	61.20	38.40
4	*5200.00	87.8 AV			1.09 H	1	49.40	38.40
5	#10400.00	66.8 PK	68.3	-1.5	1.40 H	2	18.40	48.40
ANTENNA POLARITY & TEST DISTANCE: VERTICAL AT 3 M								
NO.	FREQ. (MHz)	EMISSION LEVEL (dBuV/m)	LIMIT (dBuV/m)	MARGIN (dB)	ANTENNA HEIGHT (m)	TABLE ANGLE (Degree)	RAW VALUE (dBuV)	CORRECTION FACTOR (dB/m)
1	5150.00	53.5 PK	74.0	-20.5	1.18 V	346	15.10	38.40
2	5150.00	39.4 AV	54.0	-14.6	1.18 V	346	1.00	38.40
3	*5200.00	110.5 PK			1.18 V	346	72.10	38.40
4	*5200.00	98.9 AV			1.18 V	346	60.50	38.40
5	#10400.00	67.1 PK	68.3	-1.2	1.17 V	35	18.70	48.40

- REMARKS:**
1. Emission level (dBuV/m) = Raw Value (dBuV) + Correction Factor (dB/m).
  2. Correction Factor (dB/m) = Antenna Factor (dB/m) + Cable Factor (dB).
  3. The other emission levels were very low against the limit.
  4. Margin value = Emission level – Limit value.
  5. “ \* “: Fundamental frequency.
  6. “#”:The radiated frequency is out the restricted band.



A D T

EUT TEST CONDITION		MEASUREMENT DETAIL	
CHANNEL	Channel 48	FREQUENCY RANGE	1 ~ 40GHz
INPUT POWER (SYSTEM)	120Vac, 60 Hz	DETECTOR FUNCTION	Peak (PK) Average (AV)
ENVIRONMENTAL CONDITIONS	25deg. C, 65%RH	TESTED BY	Sun Lin

ANTENNA POLARITY & TEST DISTANCE: HORIZONTAL AT 3 M								
NO.	FREQ. (MHz)	EMISSION LEVEL (dBuV/m)	LIMIT (dBuV/m)	MARGIN (dB)	ANTENNA HEIGHT (m)	TABLE ANGLE (Degree)	RAW VALUE (dBuV)	CORRECTION FACTOR (dB/m)
1	*5240.00	99.1 PK			1.08 H	0	60.60	38.50
2	*5240.00	87.2 AV			1.08 H	0	48.70	38.50
3	5350.00	46.5 PK	74.0	-27.5	1.08 H	0	7.80	38.70
4	5350.00	33.2 AV	54.0	-20.8	1.08 H	0	-5.50	38.70
5	#10480.00	66.9 PK	68.3	-1.4	1.36 H	51	18.40	48.50
ANTENNA POLARITY & TEST DISTANCE: VERTICAL AT 3 M								
NO.	FREQ. (MHz)	EMISSION LEVEL (dBuV/m)	LIMIT (dBuV/m)	MARGIN (dB)	ANTENNA HEIGHT (m)	TABLE ANGLE (Degree)	RAW VALUE (dBuV)	CORRECTION FACTOR (dB/m)
1	*5240.00	110.1 PK			1.24 V	234	71.60	38.50
2	*5240.00	98.2 AV			1.24 V	234	59.70	38.50
3	5350.00	53.7 PK	74.0	-20.3	1.24 V	228	15.00	38.70
4	5350.00	40.8 AV	54.0	-13.2	1.24 V	228	2.10	38.70
5	#10480.00	66.9 PK	68.3	-1.4	1.02 V	189	18.40	48.50

- REMARKS:**
1. Emission level (dBuV/m) = Raw Value (dBuV) + Correction Factor (dB/m).
  2. Correction Factor (dB/m) = Antenna Factor (dB/m) + Cable Factor (dB).
  3. The other emission levels were very low against the limit.
  4. Margin value = Emission level – Limit value.
  5. “ \* “: Fundamental frequency.
  6. “#”:The radiated frequency is out the restricted band.

### 802.11n (40MHz)

EUT TEST CONDITION		MEASUREMENT DETAIL	
CHANNEL	Channel 38	FREQUENCY RANGE	1 ~ 40GHz
INPUT POWER (SYSTEM)	120Vac, 60 Hz	DETECTOR FUNCTION	Peak (PK) Average (AV)
ENVIRONMENTAL CONDITIONS	25deg. C, 65%RH	TESTED BY	Sun Lin

ANTENNA POLARITY & TEST DISTANCE: HORIZONTAL AT 3 M								
NO.	FREQ. (MHz)	EMISSION LEVEL (dBuV/m)	LIMIT (dBuV/m)	MARGIN (dB)	ANTENNA HEIGHT (m)	TABLE ANGLE (Degree)	RAW VALUE (dBuV)	CORRECTION FACTOR (dB/m)
1	5150.00	52.5 PK	74.0	-21.5	1.04 H	249	14.10	38.40
2	5150.00	37.2 AV	54.0	-16.8	1.04 H	249	-1.20	38.40
3	*5190.00	97.1 PK			1.04 H	249	58.70	38.40
4	*5190.00	84.7 AV			1.04 H	249	46.30	38.40
5	#10380.00	65.7 PK	68.3	-2.6	1.27 H	40	17.40	48.30
ANTENNA POLARITY & TEST DISTANCE: VERTICAL AT 3 M								
NO.	FREQ. (MHz)	EMISSION LEVEL (dBuV/m)	LIMIT (dBuV/m)	MARGIN (dB)	ANTENNA HEIGHT (m)	TABLE ANGLE (Degree)	RAW VALUE (dBuV)	CORRECTION FACTOR (dB/m)
1	5150.00	64.3 PK	74.0	-9.7	1.51 V	235	25.90	38.40
2	5150.00	49.4 AV	54.0	-4.6	1.51 V	235	11.00	38.40
3	*5190.00	107.8 PK			1.27 V	236	69.40	38.40
4	*5190.00	97.1 AV			1.27 V	236	58.70	38.40
5	#10380.00	66.2 PK	68.3	-2.1	1.90 V	157	17.90	48.30

- REMARKS:**
1. Emission level (dBuV/m) = Raw Value (dBuV) + Correction Factor (dB/m).
  2. Correction Factor (dB/m) = Antenna Factor (dB/m) + Cable Factor (dB).
  3. The other emission levels were very low against the limit.
  4. Margin value = Emission level – Limit value.
  5. “ \* “: Fundamental frequency.
  6. “#”: The radiated frequency is out the restricted band.



A D T

EUT TEST CONDITION		MEASUREMENT DETAIL	
CHANNEL	Channel 46	FREQUENCY RANGE	1 ~ 40GHz
INPUT POWER (SYSTEM)	120Vac, 60 Hz	DETECTOR FUNCTION	Peak (PK) Average (AV)
ENVIRONMENTAL CONDITIONS	25deg. C, 65%RH	TESTED BY	Sun Lin

ANTENNA POLARITY & TEST DISTANCE: HORIZONTAL AT 3 M								
NO.	FREQ. (MHz)	EMISSION LEVEL (dBuV/m)	LIMIT (dBuV/m)	MARGIN (dB)	ANTENNA HEIGHT (m)	TABLE ANGLE (Degree)	RAW VALUE (dBuV)	CORRECTION FACTOR (dB/m)
1	*5230.00	98.8 PK			1.13 H	249	60.30	38.50
2	*5230.00	87.8 AV			1.13 H	249	49.30	38.50
3	5350.00	45.1 PK	74.0	-28.9	1.13 H	249	6.40	38.70
4	5350.00	32.6 AV	54.0	-21.4	1.13 H	249	-6.10	38.70
5	#10460.00	66.5 PK	68.3	-1.8	1.27 H	40	18.00	48.50
ANTENNA POLARITY & TEST DISTANCE: VERTICAL AT 3 M								
NO.	FREQ. (MHz)	EMISSION LEVEL (dBuV/m)	LIMIT (dBuV/m)	MARGIN (dB)	ANTENNA HEIGHT (m)	TABLE ANGLE (Degree)	RAW VALUE (dBuV)	CORRECTION FACTOR (dB/m)
1	*5230.00	107.2 PK			1.25 V	237	68.70	38.50
2	*5230.00	96.5 AV			1.25 V	237	58.00	38.50
3	5350.00	50.7 PK	74.0	-23.3	1.15 V	236	12.00	38.70
4	5350.00	39.9 AV	54.0	-14.1	1.15 V	236	1.20	38.70
5	#10460.00	64.5 PK	68.3	-3.8	1.90 V	152	16.00	48.50

- REMARKS:**
1. Emission level (dBuV/m) = Raw Value (dBuV) + Correction Factor (dB/m).
  2. Correction Factor (dB/m) = Antenna Factor (dB/m) + Cable Factor (dB).
  3. The other emission levels were very low against the limit.
  4. Margin value = Emission level – Limit value.
  5. “ \* “: Fundamental frequency.
  6. “#”:The radiated frequency is out the restricted band.



**BELOW 1GHz WORST-CASE DATA : 802.11n (40MHz)**

EUT TEST CONDITION		MEASUREMENT DETAIL	
CHANNEL	Channel 46	FREQUENCY RANGE	Below 1000MHz
INPUT POWER (SYSTEM)	120Vac, 60 Hz	DETECTOR FUNCTION	Quasi-Peak
ENVIRONMENTAL CONDITIONS	25deg. C, 68%RH	TESTED BY	Sun Lin

ANTENNA POLARITY & TEST DISTANCE: HORIZONTAL AT 3 M								
NO.	FREQ. (MHz)	EMISSION LEVEL (dBuV/m)	LIMIT (dBuV/m)	MARGIN (dB)	ANTENNA HEIGHT (m)	TABLE ANGLE (Degree)	RAW VALUE (dBuV)	CORRECTION FACTOR (dB/m)
1	290.48	42.3 QP	46.0	-3.7	1.02 H	278	28.00	14.30
2	362.37	37.2 QP	46.0	-8.8	1.00 H	55	21.10	16.10
3	500.42	38.7 QP	46.0	-7.3	2.00 H	352	19.00	19.70
4	539.30	34.6 QP	46.0	-11.4	2.00 H	10	13.90	20.70
5	599.58	39.5 QP	46.0	-6.5	2.00 H	352	17.40	22.10
6	760.95	34.0 QP	46.0	-12.0	1.00 H	226	10.10	23.90
ANTENNA POLARITY & TEST DISTANCE: VERTICAL AT 3 M								
NO.	FREQ. (MHz)	EMISSION LEVEL (dBuV/m)	LIMIT (dBuV/m)	MARGIN (dB)	ANTENNA HEIGHT (m)	TABLE ANGLE (Degree)	RAW VALUE (dBuV)	CORRECTION FACTOR (dB/m)
1	39.62	34.4 QP	40.0	-5.6	1.25 V	304	21.70	12.70
2	287.59	42.8 QP	46.0	-3.2	2.01 V	35	28.60	14.20
3	420.70	35.2 QP	46.0	-10.8	1.50 V	118	17.70	17.50
4	479.03	34.9 QP	46.0	-11.1	1.00 V	10	15.80	19.10
5	500.42	34.8 QP	46.0	-11.2	2.00 V	43	15.10	19.70
6	599.58	40.0 QP	46.0	-6.0	2.00 V	25	17.90	22.10

- REMARKS:**
1. Emission level (dBuV/m) = Raw Value (dBuV) + Correction Factor (dB/m).
  2. Correction Factor (dB/m) = Antenna Factor (dB/m) + Cable Factor (dB).
  3. The other emission levels were very low against the limit.
  4. Margin value = Emission level – Limit value.

## 4.2 CONDUCTED EMISSION MEASUREMENT

### 4.2.1 LIMITS OF CONDUCTED EMISSION MEASUREMENT

FREQUENCY OF EMISSION (MHz)	CONDUCTED LIMIT (dB $\mu$ V)	
	Quasi-peak	Average
0.15 ~ 0.5	66 to 56	56 to 46
0.5 ~ 5	56	46
5 ~ 30	60	50

- NOTE:** 1. The lower limit shall apply at the transition frequencies.
2. The limit decreases in line with the logarithm of the frequency in the range of 0.15 to 0.50MHz.
3. All emanations from a class A/B digital device or system, including any network of conductors and apparatus connected thereto, shall not exceed the level of field strengths specified above.

### 4.2.2 TEST INSTRUMENTS

DESCRIPTION & MANUFACTURER	MODEL NO.	SERIAL NO.	DATE OF CALIBRATION	DUE DATE OF CALIBRATION
Test Receiver ROHDE & SCHWARZ	ESCS30	100291	Nov. 23, 2011	Nov. 22, 2012
RF signal cable Woken	5D-FB	Cable-HYC01-01	Dec. 30, 2010	Dec. 29, 2011
LISN ROHDE & SCHWARZ	ESH3-Z5	100312	Jul. 07, 2011	Jul. 06, 2012
LISN ROHDE & SCHWARZ	ESH2-Z5	100100	Jan. 06, 2011	Jan. 05, 2012
LISN ROHDE & SCHWARZ	ESH3-Z5	835239/001	Feb. 22, 2011	Feb. 21, 2012
V-LISN SCHWARZBECK	NNBL 8226-2	8226-142	Jun. 30, 2011	Jun. 29, 2012
LISN ROHDE & SCHWARZ	ENV216	100072	Jun. 10, 2011	Jun. 09, 2012
Software ADT	ADT_Cond_ V7.3.7	NA	NA	NA

- NOTE:** 1. The calibration interval of the above test instruments is 12 months and the calibrations are traceable to NML/ROC and NIST/USA.
2. The test was performed in HwaYa Shielded Room 1.
3. The VCCI Site Registration No. is C-2040.

#### 4.2.3 TEST PROCEDURES

- a. The EUT was placed 0.4 meters from the conducting wall of the shielded room with EUT being connected to the power mains through a line impedance stabilization network (LISN). Other support units were connected to the power mains through another LISN. The two LISNs provide 50 ohm/ 50uH of coupling impedance for the measuring instrument.
- b. Both lines of the power mains connected to the EUT were checked for maximum conducted interference.
- c. The frequency range from 150kHz to 30MHz was searched. Emission levels under (Limit - 20dB) was not recorded.

**NOTE:** All modes of operation were investigated and the worst-case emissions are reported.

#### 4.2.4 DEVIATION FROM TEST STANDARD

No deviation.

#### 4.2.5 TEST SETUP

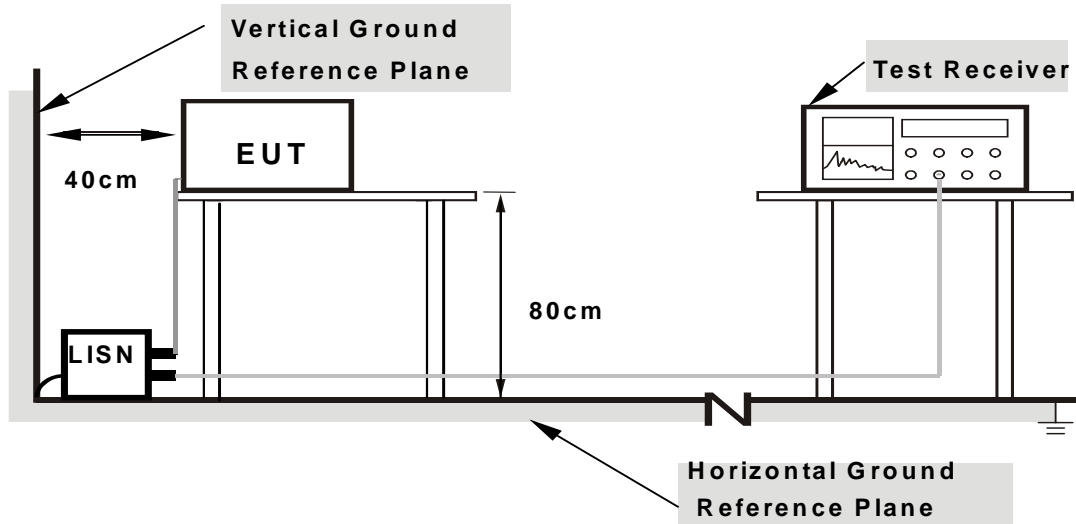

- Note:**
- 1.Support units were connected to second LISN.
  - 2.Both of LISNs (AMN) are 80 cm from EUT and at least 80 from other units and other metal planes

For the actual test configuration, please refer to the attached file (Test Setup Photo).

#### 4.2.6 EUT OPERATING CONDITIONS

Same as 4.1.6.

## 4.2.7 TEST RESULTS

### CONDUCTED WORST-CASE DATA : 802.11n (40MHz)

PHASE	Line 1	6dB BANDWIDTH	9kHz
-------	--------	---------------	------

No	Freq. [MHz]	Corr. Factor (dB)	Reading Value		Emission Level		Limit		Margin	
			[dB (uV)]		[dB (uV)]		[dB (uV)]		(dB)	
			Q.P.	AV.	Q.P.	AV.	Q.P.	AV.	Q.P.	AV.
1	0.162	0.12	48.33	39.46	48.45	39.58	65.38	55.38	-16.93	-15.80
2	0.173	0.12	48.30	33.90	48.42	34.02	64.79	54.79	-16.38	-20.78
3	0.541	0.13	41.56	24.98	41.69	25.11	56.00	46.00	-14.31	-20.89
4	0.814	0.15	33.32	17.01	33.47	17.16	56.00	46.00	-22.53	-28.84
5	6.594	0.46	21.75	9.67	22.21	10.13	60.00	50.00	-37.79	-39.87
6	8.086	0.55	21.21	10.04	21.76	10.59	60.00	50.00	-38.24	-39.41

- REMARKS:**
1. Q.P. and AV. are abbreviations of quasi-peak and average individually.
  2. "-": The Quasi-peak reading value also meets average limit and measurement with the average detector is unnecessary.
  3. The emission levels of other frequencies were very low against the limit.
  4. Margin value = Emission level - Limit value
  5. Correction factor = Insertion loss + Cable loss
  6. Emission Level = Correction Factor + Reading Value.

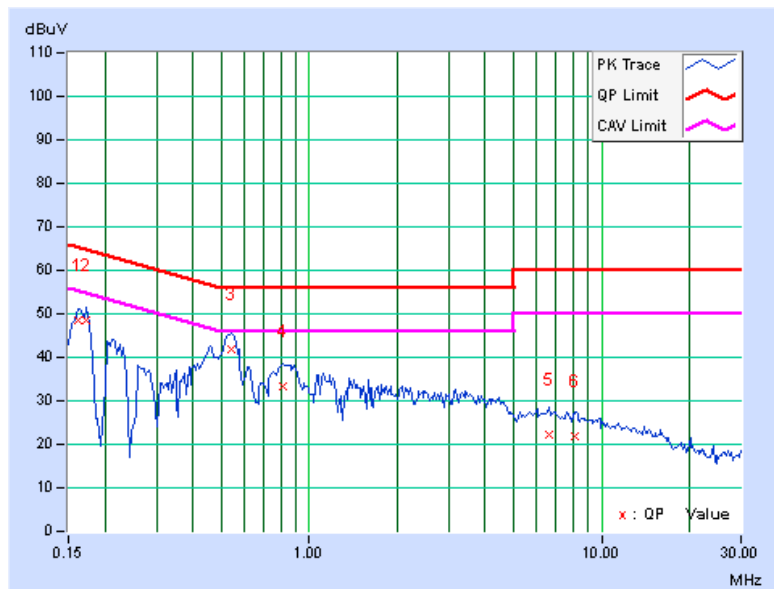

PHASE	Line 2	6dB BANDWIDTH	9kHz
-------	--------	---------------	------

No	Freq. [MHz]	Corr. Factor (dB)	Reading Value		Emission Level		Limit		Margin	
			[dB (uV)]		[dB (uV)]		[dB (uV)]		(dB)	
			Q.P.	AV.	Q.P.	AV.	Q.P.	AV.	Q.P.	AV.
1	0.158	0.13	51.12	32.78	51.25	32.91	65.58	55.58	-14.33	-22.67
<b>2</b>	<b>0.166</b>	<b>0.13</b>	<b>51.55</b>	<b>34.74</b>	<b>51.68</b>	<b>34.87</b>	<b>65.18</b>	<b>55.18</b>	<b>-13.50</b>	<b>-20.31</b>
3	0.541	0.15	37.32	22.38	37.47	22.53	56.00	46.00	-18.53	-23.47
4	1.125	0.18	27.00	13.41	27.18	13.59	56.00	46.00	-28.82	-32.41
5	6.926	0.46	18.62	9.83	19.08	10.29	60.00	50.00	-40.92	-39.71
6	15.328	0.76	17.07	5.64	17.83	6.40	60.00	50.00	-42.17	-43.60

- REMARKS:**
1. Q.P. and AV. are abbreviations of quasi-peak and average individually.
  2. "-": The Quasi-peak reading value also meets average limit and measurement with the average detector is unnecessary.
  3. The emission levels of other frequencies were very low against the limit.
  4. Margin value = Emission level - Limit value
  5. Correction factor = Insertion loss + Cable loss
  6. Emission Level = Correction Factor + Reading Value.

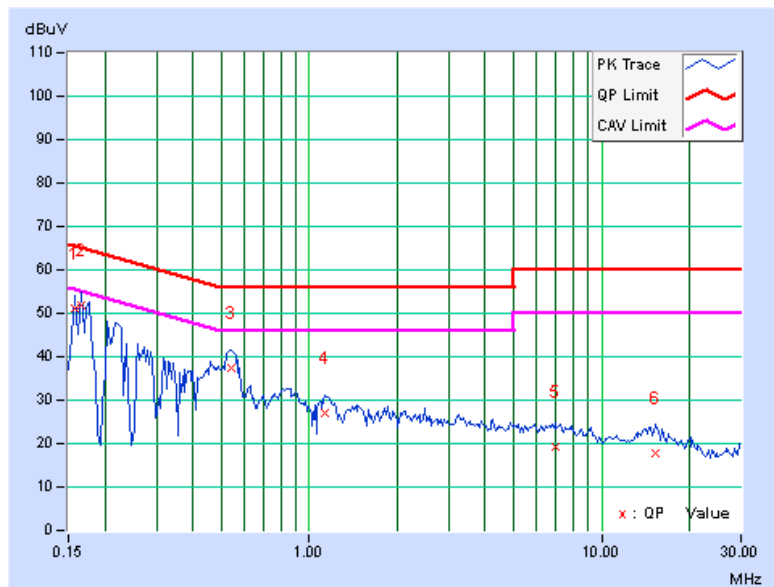

### 4.3 PEAK TRANSMIT POWER MEASUREMENT

#### 4.3.1 LIMITS OF PEAK TRANSMIT POWER MEASUREMENT

FREQUENCY BAND	LIMIT
5.15 ~ 5.25GHz	The lesser of 50mW (17dBm) or 4dBm + 10logB

**NOTE:** Where B is the 26dB emission bandwidth in MHz.

#### 4.3.2 TEST SETUP

##### FOR POWER OUTPUT MEASUREMENT

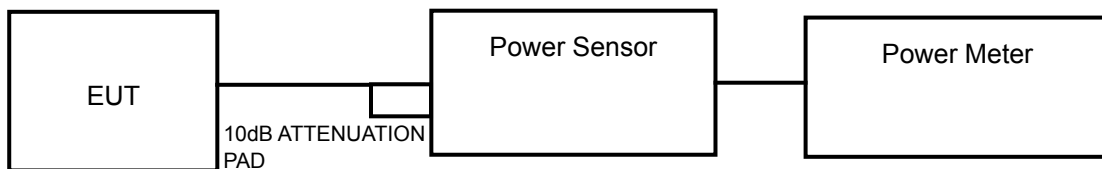

##### FOR 26dB BANDWIDTH

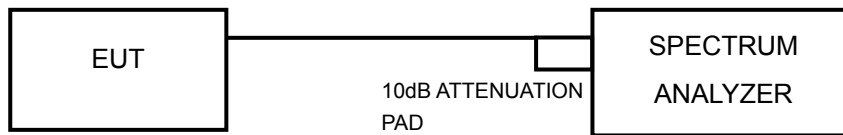

#### 4.3.3 TEST INSTRUMENTS

Refer to section 4.1.3 to get information of above instrument.

#### 4.3.4 TEST PROCEDURE

##### FOR AVERAGE POWER MEASUREMENT

A power sensor was used on the output port of the EUT. A power meter was used to read the response of the power sensor. Record the power level.

##### FOR 26dB BANDWIDTH

- 1) Set RBW = approximately 1% of the emission bandwidth.
- 2) Set the VBW > RBW.
- 3) Detector = Peak.
- 4) Trace mode = max hold.
- 5) Measure the maximum width of the emission that is 26 dB down from the peak of the emission. Compare this with the RBW setting of the analyzer. Readjust RBW and repeat measurement as needed until the RBW/EBW ratio is approximately 1%.

#### 4.3.5 DEVIATION FROM TEST STANDARD

No deviation.

#### 4.3.6 EUT OPERATING CONDITIONS

The software provided by client to enable the EUT under transmission condition continuously at specific channel frequencies individually.



#### 4.3.7 TEST RESULTS

##### POWER OUTPUT:

##### 802.11a

CHANNEL	CHANNEL FREQUENCY (MHz)	POWER OUTPUT (mW)	POWER OUTPUT (dBm)	POWER LIMIT (dBm)	PASS/FAIL
36	5180	20.0	13.0	17	PASS
40	5200	20.0	13.0	17	PASS
48	5240	20.0	13.0	17	PASS

##### 802.11n (20MHz)

CHAN.	CHAN. FREQ. (MHz)	POWER OUTPUT (dBm)		TOTAL POWER (mW)	TOTAL POWER (dBm)	POWER LIMIT (dBm)	PASS / FAIL
		CHAIN 0	CHAIN 1				
36	5180	12.0	11.8	30.9	14.9	17	PASS
40	5200	12.2	12.0	32.4	15.1	17	PASS
48	5240	12.0	12.0	31.6	15.0	17	PASS

##### 802.11n (40MHz)

CHAN.	CHAN. FREQ. (MHz)	POWER OUTPUT (dBm)		TOTAL POWER (mW)	TOTAL POWER (dBm)	POWER LIMIT (dBm)	PASS / FAIL
		CHAIN 0	CHAIN 1				
38	5190	13.1	13.1	40.7	16.1	17	PASS
46	5230	13.1	13.1	40.7	16.1	17	PASS



**26dB BANDWIDTH: 802.11a**

CHANNEL	CHANNEL FREQUENCY (MHz)	26dBc BANDWIDTH (MHz)	PASS / FAIL
36	5180	22.82	PASS
40	5200	22.95	PASS
48	5240	22.90	PASS

**802.11n (20MHz)**

CHANNEL	CHANNEL FREQUENCY (MHz)	26dBc BANDWIDTH (MHz)		PASS / FAIL
		CHAIN 0	CHAIN 1	
36	5180	23.21	22.84	PASS
40	5200	23.37	23.06	PASS
48	5240	23.29	22.87	PASS

**802.11n (40MHz)**

CHANNEL	CHANNEL FREQUENCY (MHz)	26dBc BANDWIDTH (MHz)		PASS / FAIL
		CHAIN 0	CHAIN 1	
38	5190	42.74	42.30	PASS
46	5230	42.61	42.04	PASS

## 4.4 PEAK POWER EXCURSION MEASUREMENT

### 4.4.1 LIMITS OF PEAK POWER EXCURSION MEASUREMENT

Shall not exceed 13 dB

### 4.4.2 TEST SETUP

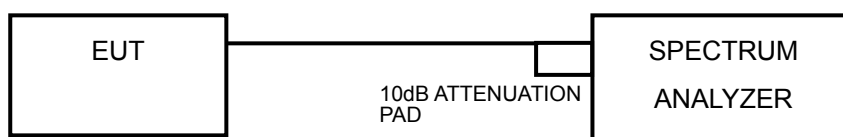

### 4.4.3 TEST INSTRUMENTS

Refer to section 4.1.3 to get information of above instrument.

### 4.4.4 TEST PROCEDURE

- 1) Set RBW = 1 MHz, VBW  $\leq$  3 MHz, Detector = peak.
- 2) Trace mode = max-hold. Allow the sweeps to continue until the trace stabilizes.
- 3) Use the peak search function to find the peak of the spectrum.
- 4) Measure the PPSD.
- 5) Compute the ratio of the maximum of the peak-max-hold spectrum to the PPSD.

### 4.4.5 DEVIATION FROM TEST STANDARD

No deviation.

### 4.4.6 EUT OPERATING CONDITIONS

Same as 4.2.6



A D T

#### 4.4.7 TEST RESULTS

##### 802.11a

CHANNEL	CHANNEL FREQUENCY (MHz)	PEAK VALUE (dBm)	PPSD (dBm)	PEAK POWER EXCURSION (dB)	PEAK to AVERAGE EXCURSION LIMIT (dB)	PASS/FAIL
36	5180	11.44	2.92	8.52	13	PASS
40	5200	10.46	1.98	8.48	13	PASS
48	5240	10.40	1.98	8.42	13	PASS



A D T

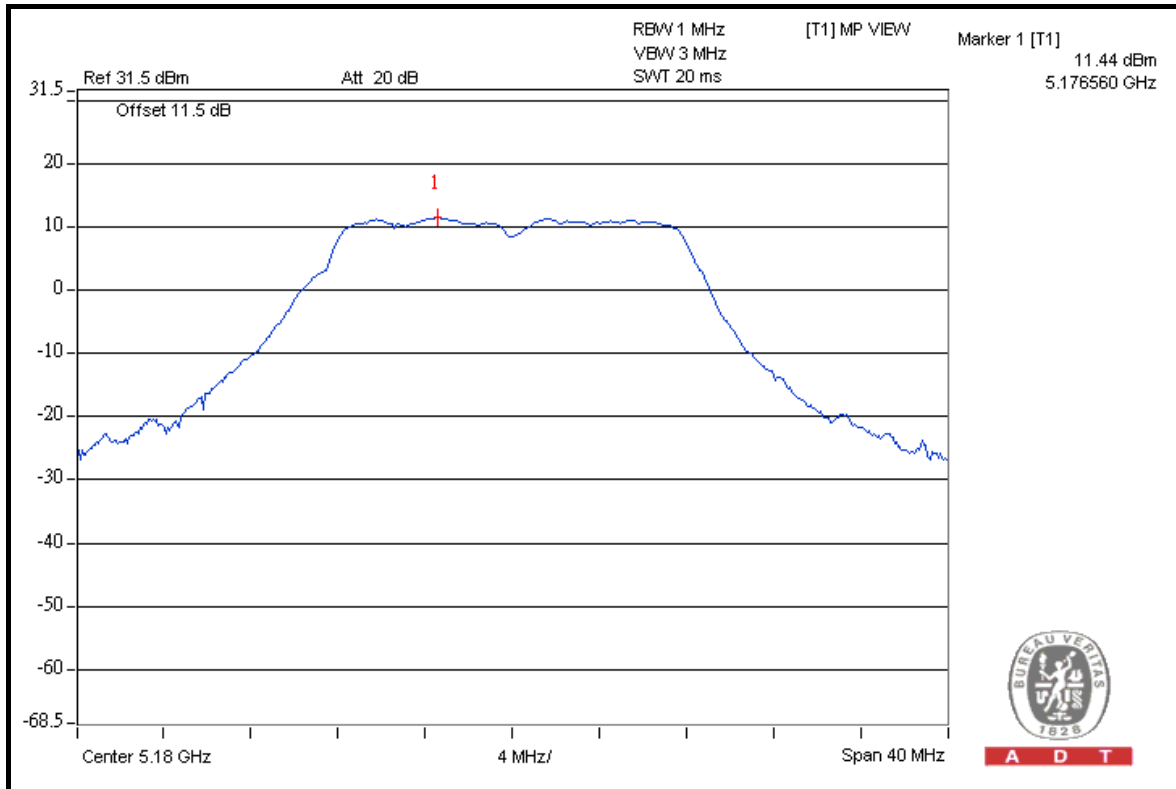

A D T

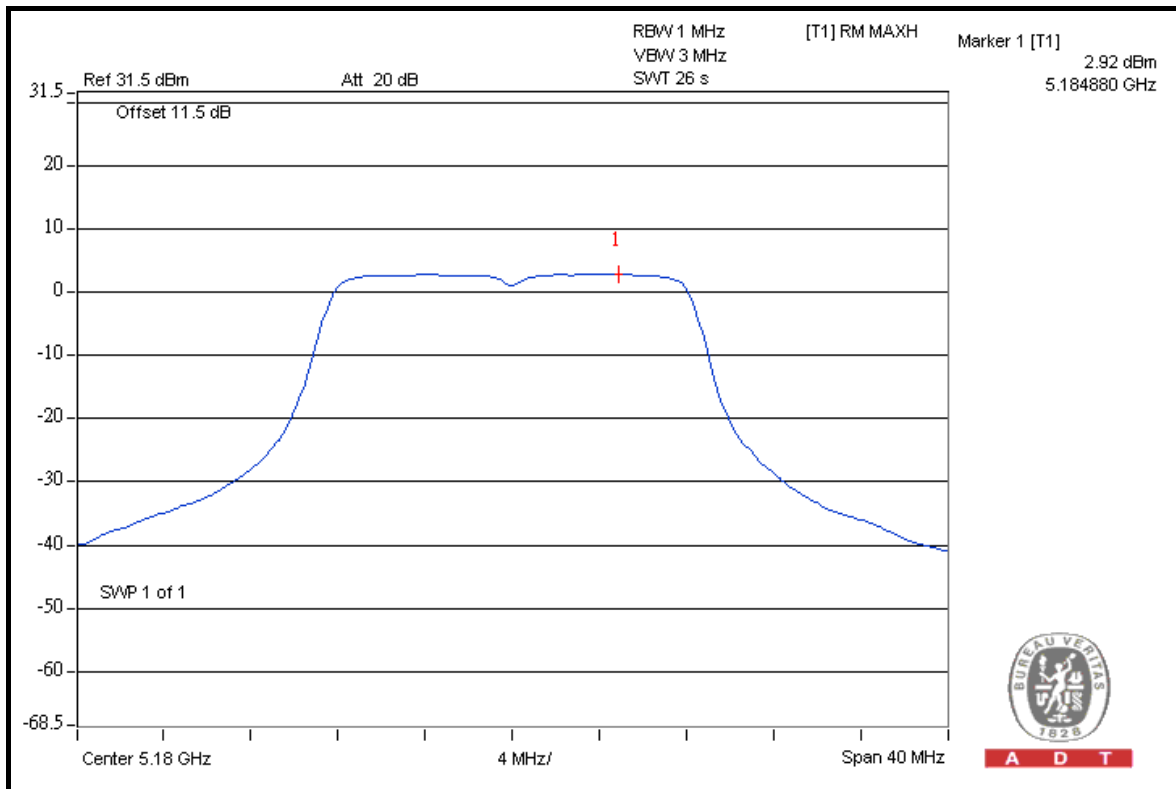

A D T



A D T

802.11n (20MHz)

TX chain	CHAN.	CHANNEL FREQUENCY (MHz)	PEAK VALUE (dBm)	PPSD (dBm)	PEAK POWER EXCURSION (dB)	PEAK to AVERAGE EXCURSION LIMIT (dB)	PASS /FAIL
0	36	5180	9.90	0.56	9.34	13	PASS
	40	5200	9.91	0.75	9.16	13	PASS
	48	5240	10.11	0.83	9.28	13	PASS
1	36	5180	10.54	0.40	10.14	13	PASS
	40	5200	10.97	0.66	10.31	13	PASS
	48	5240	10.70	0.42	10.28	13	PASS



A D T

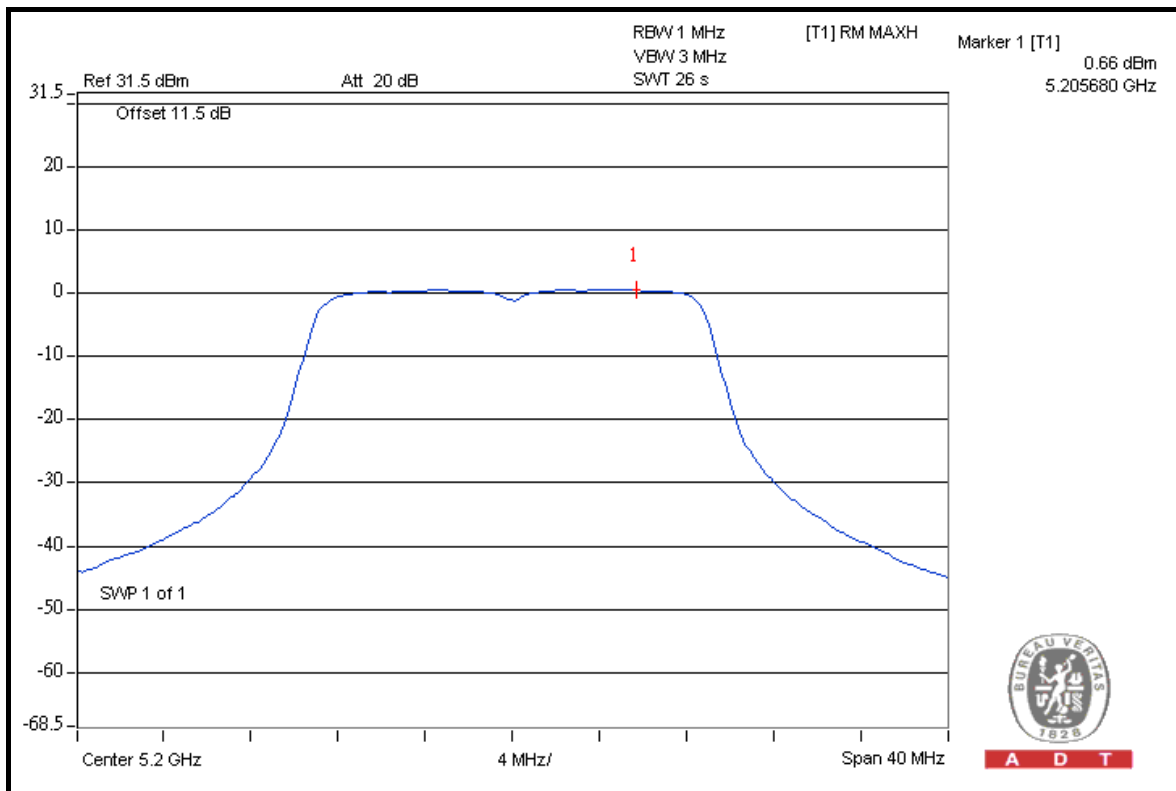
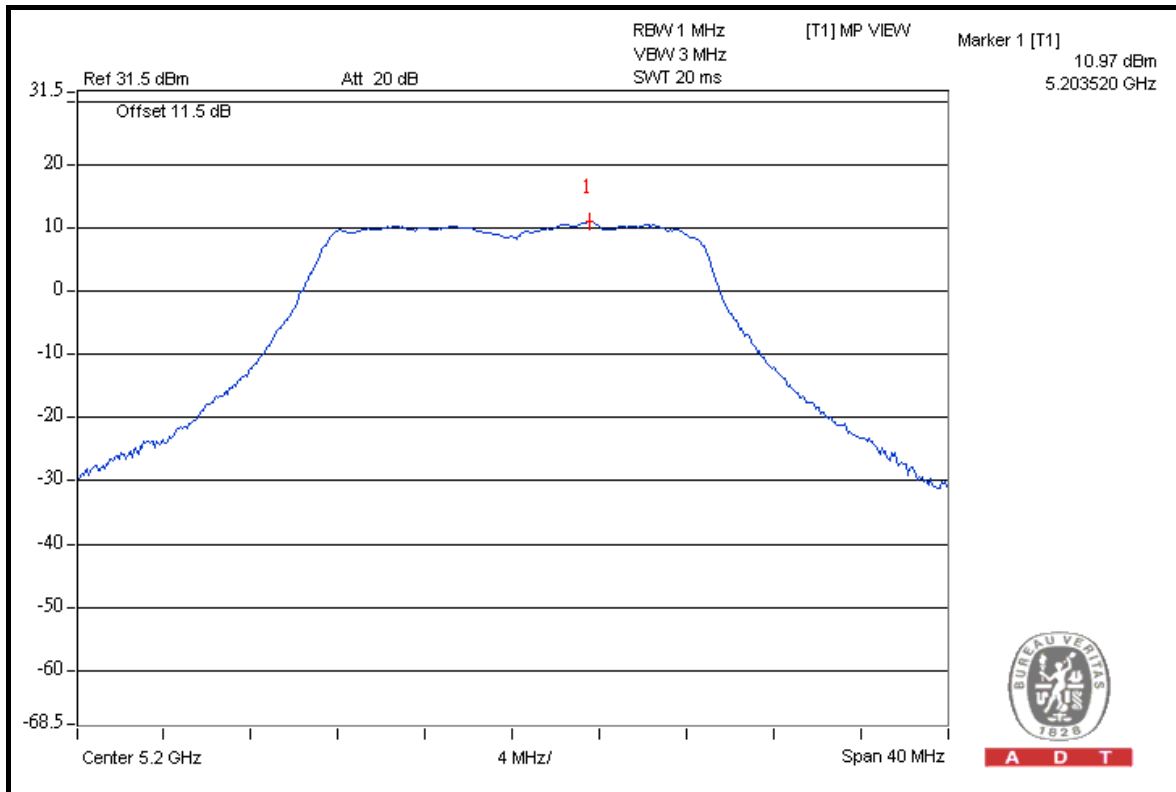



**802.11n (40MHz)**

<b>TX chain</b>	<b>CHAN.</b>	<b>CHANNEL FREQUENCY (MHz)</b>	<b>PEAK VALUE (dBm)</b>	<b>PPSD (dBm)</b>	<b>PEAK POWER EXCURSION (dB)</b>	<b>PEAK to AVERAGE EXCURSION LIMIT (dB)</b>	<b>PASS /FAIL</b>
0	38	5190	8.56	-1.36	9.92	13	PASS
	46	5230	8.34	-1.26	9.60	13	PASS
1	38	5190	9.61	-1.79	11.40	13	PASS
	46	5230	9.83	-1.62	11.45	13	PASS





A D T

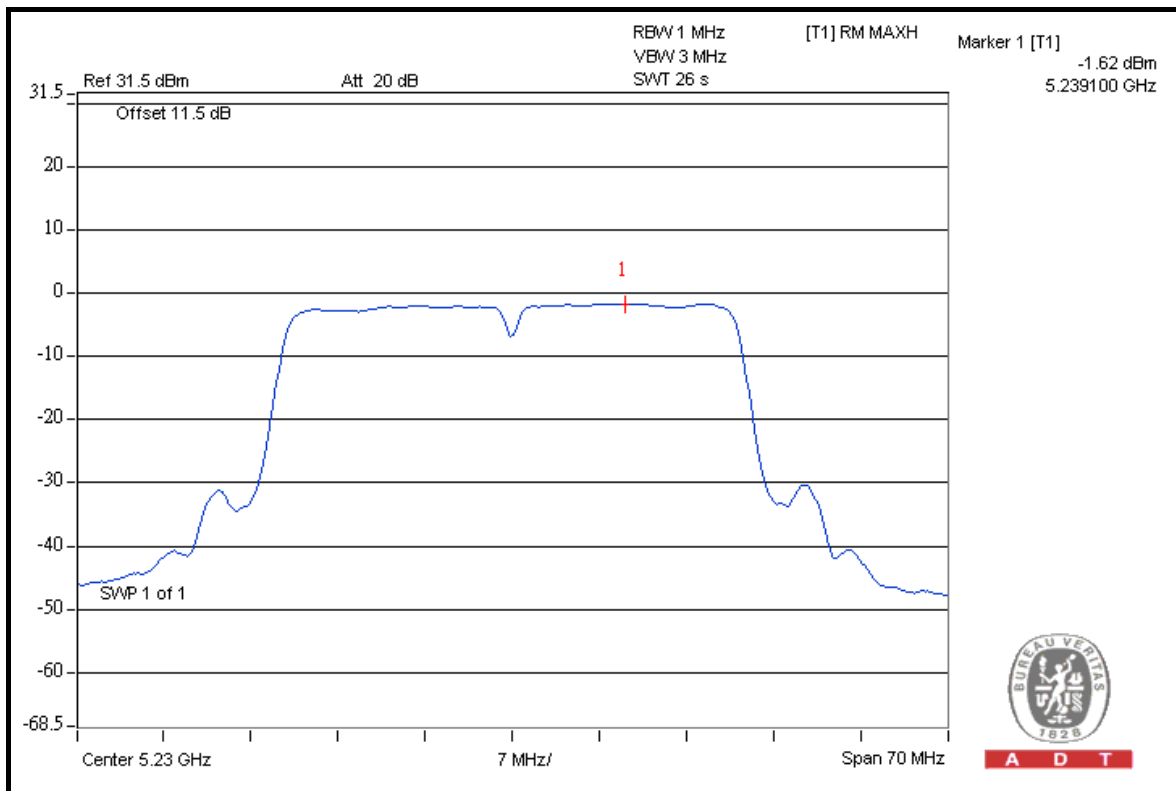
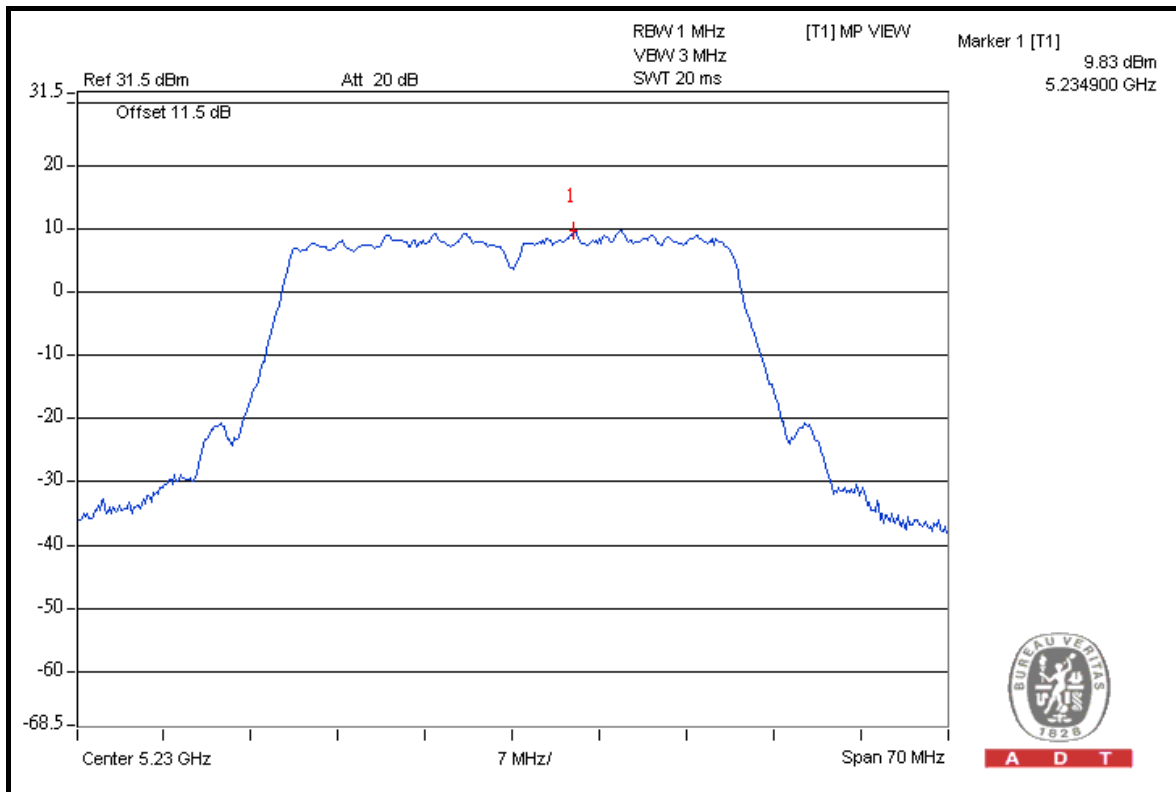

## 4.5 PEAK POWER SPECTRAL DENSITY MEASUREMENT

### 4.5.1 LIMITS OF PEAK POWER SPECTRAL DENSITY MEASUREMENT

FREQUENCY BAND	LIMIT(dBm)
5.15 ~ 5.25GHz	4
5.25 ~ 5.35GHz and 5.470 ~ 5.725GHz	11
5.725~5825GHz	17

### 4.5.2 TEST SETUP

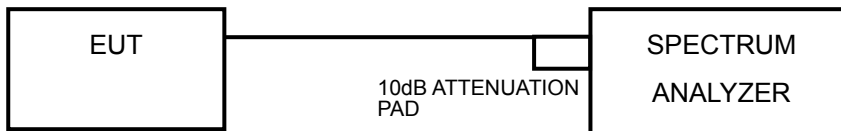

### 4.5.3 TEST INSTRUMENTS

Refer to section 4.1.3 to get information of above instrument.

### 4.5.4 TEST PROCEDURES

- 1) Set span to encompass the entire emission bandwidth (EBW) of the signal.
- 2) Set RBW = 1 MHz, Set VBW  $\geq$  3 MHz, Detector = RMS
- 3) Sweep time = auto, trigger set to "free run".
- 4) Trace average at least 100 traces in power averaging mode.

### 4.5.5 DEVIATION FROM TEST STANDARD

No deviation.

### 4.5.6 EUT OPERATING CONDITIONS

Same as 4.3.6.



#### 4.5.7 TEST RESULTS

##### 802.11a

CHANNEL	FREQUENCY (MHz)	PSD (dBm)	MAXIMUM LIMIT (dBm)	PASS/FAIL
36	5180	2.92	4	PASS
40	5220	1.98	4	PASS
48	5240	1.98	4	PASS

##### 802.11n (20MHz)

CHAIN	CHAN.	CHAN. FREQ. (MHz)	RF POWER LEVEL IN 3kHz BW (dBm)		TOTAL POWER DENSITY (dBm)	MAX. LIMIT (dBm)	PASS / FAIL
			MEASURED	10 log (N=2) dB			
0	36	5180	0.56	3.01	3.57	4	PASS
	40	5200	0.75	3.01	3.76	4	PASS
	48	5240	0.83	3.01	3.84	4	PASS
1	36	5180	0.40	3.01	3.41	4	PASS
	40	5200	0.66	3.01	3.67	4	PASS
	48	5240	0.42	3.01	3.43	4	PASS

##### 802.11n (40MHz)

CHAIN	CHAN.	CHAN. FREQ. (MHz)	RF POWER LEVEL IN 3kHz BW (dBm)		TOTAL POWER DENSITY (dBm)	MAX. LIMIT (dBm)	PASS / FAIL
			MEASURED	10 log (N=2) dB			
0	38	5190	-1.36	3.01	1.65	4	PASS
	46	5230	-1.26	3.01	1.75	4	PASS
1	38	5190	-1.79	3.01	1.22	4	PASS
	46	5230	-1.62	3.01	1.39	4	PASS

## 4.6 FREQUENCY STABILITY

### 4.6.1 LIMITS OF FREQUENCY STABILITY MEASUREMENT

The frequency of the carrier signal shall be maintained within band of operation

### 4.6.2 TEST SETUP

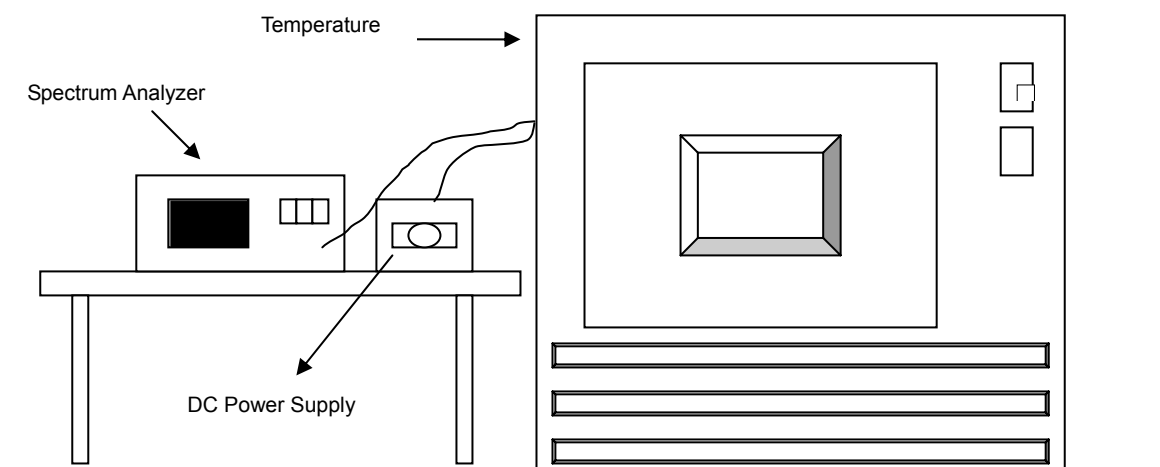

### 4.6.3 TEST INSTRUMENTS

Refer to section 4.1.3 to get information of above instrument.

#### 4.6.4 TEST PROCEDURE

- a. The EUT was placed inside the environmental test chamber and powered by nominal DC voltage.
- b. Turn the EUT on and couple its output to a spectrum analyzer.
- c. Turn the EUT off and set the chamber to the highest temperature specified.
- d. Allow sufficient time (approximately 30 min) for the temperature of the chamber to stabilize, turn the EUT on and measure the operating frequency after 2, 5, and 10 minutes.
- e. Repeat step 2 and 3 with the temperature chamber set to the lowest temperature.
- f. The test chamber was allowed to stabilize at +20 degree C for a minimum of 30 minutes. The supply voltage was then adjusted on the EUT from 85% to 115% and the frequency record.

#### 4.6.5 DEVIATION FROM TEST STANDARD

No deviation.

#### 4.6.6 EUT OPERATING CONDITION

Set the EUT transmit at un-modulation mode to test frequency stability.

#### 4.6.7 TEST RESULTS

FREQUENCY STABILITY VERSUS TEMP.									
OPERATING FREQUENCY: 5200MHz									
TEMP. (°C)	POWER SUPPLY (Vac)	0 MINUTE		2 MINUTE		5 MINUTE		10 MINUTE	
		Measured Frequency (MHz)	Frequency Drift (ppm)	Measured Frequency (MHz)	Frequency Drift (ppm)	Measured Frequency (MHz)	Frequency Drift (ppm)	Measured Frequency (MHz)	Frequency Drift (ppm)
55	110.0	5199.987693	-2.367	5199.987691	-2.367	5199.987999	-2.308	5199.987951	-2.317
50	110.0	5199.988786	-2.157	5199.988438	-2.223	5199.989074	-2.101	5199.988703	-2.173
40	110.0	5199.990642	-1.800	5199.990686	-1.791	5199.990062	-1.911	5199.990016	-1.920
30	110.0	5199.991200	-1.692	5199.991289	-1.675	5199.991373	-1.659	5199.991621	-1.611
20	110.0	5199.992230	-1.494	5199.992517	-1.439	5199.992343	-1.473	5199.992126	-1.514
10	110.0	5199.991528	-1.629	5199.991646	-1.607	5199.991122	-1.707	5199.991387	-1.656
0	110.0	5199.990390	-1.848	5199.990093	-1.905	5199.989909	-1.941	5199.989749	-1.971
-10	110.0	5199.988861	-2.142	5199.989312	-2.055	5199.989330	-2.052	5199.989322	-2.053
-20	110.0	5199.987704	-2.365	5199.987690	-2.367	5199.988183	-2.272	5199.987778	-2.350
-30	110.0	5199.988415	-2.228	5199.988438	-2.223	5199.988234	-2.263	5199.988269	-2.256

FREQUENCY STABILITY VERSUS VOLTAGE									
OPERATING FREQUENCY: 5200MHz									
TEMP. (°C)	POWER SUPPLY (Vac)	0 MINUTE		2 MINUTE		5 MINUTE		10 MINUTE	
		Measured Frequency (MHz)	Frequency Drift (ppm)	Measured Frequency (MHz)	Frequency Drift (ppm)	Measured Frequency (MHz)	Frequency Drift (ppm)	Measured Frequency (MHz)	Frequency Drift (ppm)
20	93.5	5199.991249	-1.683	5199.991269	-1.679	5199.991330	-1.667	5199.991013	-1.728
	110.0	5199.992230	-1.494	5199.992517	-1.439	5199.992343	-1.473	5199.992126	-1.514
	126.5	5199.991816	-1.574	5199.991782	-1.580	5199.991506	-1.633	5199.991787	-1.579

## 5. PHOTOGRAPHS OF THE TEST CONFIGURATION

Please refer to the attached file (Test Setup Photo).



## 6. INFORMATION ON THE TESTING LABORATORIES

We, Bureau Veritas Consumer Products Services (H.K.) Ltd., Taoyuan Branch, were founded in 1988 to provide our best service in EMC, Radio, Telecom and Safety consultation. Our laboratories are accredited and approved according to ISO/IEC 17025.

Copies of accreditation and authorization certificates of our laboratories obtained from approval agencies can be downloaded from our web site: [www.adt.com.tw/index.5.phtml](http://www.adt.com.tw/index.5.phtml).

If you have any comments, please feel free to contact us at the following:

**Linko EMC/RF Lab**

Tel: 886-2-26052180

Fax: 886-2-26051924

**Hsin Chu EMC/RF Lab**

Tel: 886-3-5935343

Fax: 886-3-5935342

**Hwa Ya EMC/RF/Safety/Telecom Lab**

Tel: 886-3-3183232

Fax: 886-3-3185050

**Email:** [service.adt@tw.bureauveritas.com](mailto:service.adt@tw.bureauveritas.com)

**Web Site:** [www.adt.com.tw](http://www.adt.com.tw)

The address and road map of all our labs can be found in our web site also.



## **7. APPENDIX A - MODIFICATIONS RECORDERS FOR ENGINEERING CHANGES TO THE EUT BY THE LAB**

No modifications were made to the EUT by the lab during the test.

**---END---**