



A D T

# FCC TEST REPORT (15.247)

**REPORT NO.:** RF111124C12  
**MODEL NO.:** TEW-751DR  
**FCC ID:** XU8TEW751DR  
**RECEIVED:** Nov. 14, 2011  
**TESTED:** Nov. 14 ~ Dec. 06, 2011  
**ISSUED:** Dec. 09, 2011

**APPLICANT:** TRENDNET, Inc.

**ADDRESS:** 20675 Manhattan Place, Torrance, CA 90501, USA

**ISSUED BY:** Bureau Veritas Consumer Products Services (H.K.)  
Ltd., Taoyuan Branch

**LAB ADDRESS:** No. 47, 14th Ling, Chia Pau Vil., Lin Kou Dist., New  
Taipei City, Taiwan ( R.O.C )

**TEST LOCATION:** No. 19, Hwa Ya 2nd Rd, Wen Hwa Tsuen, Kwei  
Shan Hsiang, Taoyuan Hsien 333, Taiwan, R.O.C.

This test report consists of 82 pages in total. It may be duplicated completely for legal use with the approval of the applicant. It should not be reproduced except in full, without the written approval of our laboratory. The client should not use it to claim product, certification, approval or endorsement by TAF or any government agency. The test results in the report only apply to the tested sample.





# TABLE OF CONTENTS

RELEASE CONTROL RECORD.....	5
1. CERTIFICATION .....	6
2. SUMMARY OF TEST RESULTS .....	7
2.1 MEASUREMENT UNCERTAINTY .....	7
3. GENERAL INFORMATION.....	8
3.1 GENERAL DESCRIPTION OF EUT .....	8
3.2 DESCRIPTION OF TEST MODES.....	10
3.2.1 CONFIGURATION OF SYSTEM UNDER TEST .....	11
3.2.2 TEST MODE APPLICABILITY AND TESTED CHANNEL DETAIL.....	12
3.3 GENERAL DESCRIPTION OF APPLIED STANDARDS .....	16
3.4 DESCRIPTION OF SUPPORT UNITS .....	16
4. TEST TYPES AND RESULTS (FOR 2.4GHz BAND).....	17
4.1 RADIATED EMISSION AND BANDEDGE MEASUREMENT.....	17
4.1.1 LIMITS OF RADIATED EMISSION AND BANDEDGE MEASUREMENT .....	17
4.1.2 TEST INSTRUMENTS.....	18
4.1.3 TEST PROCEDURES .....	19
4.1.4 DEVIATION FROM TEST STANDARD .....	19
4.1.5 TEST SETUP .....	20
4.1.6 EUT OPERATING CONDITIONS .....	20
4.1.7 TEST RESULTS .....	21
4.2 CONDUCTED EMISSION MEASUREMENT .....	34
4.2.1 LIMITS OF CONDUCTED EMISSION MEASUREMENT.....	34
4.2.2 TEST INSTRUMENTS.....	34
4.2.3 TEST PROCEDURES .....	35
4.2.4 DEVIATION FROM TEST STANDARD .....	35
4.2.5 TEST SETUP .....	36
4.2.6 EUT OPERATING CONDITIONS .....	36
4.2.7 TEST RESULTS .....	37
4.3 6dB BANDWIDTH MEASUREMENT .....	39
4.3.1 LIMITS OF 6dB BANDWIDTH MEASUREMENT .....	39
4.3.2 TEST SETUP .....	39
4.3.3 TEST INSTRUMENTS.....	39
4.3.4 TEST PROCEDURE .....	39
4.3.5 DEVIATION FROM TEST STANDARD .....	39
4.3.6 EUT OPERATING CONDITIONS .....	39
4.3.7 TEST RESULTS .....	40
4.4 CONDUCTED OUTPUT POWER .....	41
4.4.1 LIMITS OF CONDUCTED OUTPUT POWER MEASUREMENT .....	41
4.4.2 TEST SETUP .....	41
4.4.3 TEST INSTRUMENTS.....	41
4.4.4 TEST PROCEDURES .....	41
4.4.5 DEVIATION FROM TEST STANDARD .....	41
4.4.6 EUT OPERATING CONDITIONS .....	41
4.4.7 TEST RESULTS .....	42
4.5 POWER SPECTRAL DENSITY MEASUREMENT.....	43
4.5.1 LIMITS OF POWER SPECTRAL DENSITY MEASUREMENT .....	43
4.5.2 TEST SETUP .....	43
4.5.3 TEST INSTRUMENTS.....	43
4.5.4 TEST PROCEDURE .....	43



4.5.5	DEVIATION FROM TEST STANDARD .....	43
4.5.6	EUT OPERATING CONDITION .....	43
4.5.7	TEST RESULTS .....	44
4.6	CONDUCTED EMISSION MEASUREMENT .....	45
4.6.1	LIMITS OF BAND EDGES MEASUREMENT.....	45
4.6.2	TEST SETUP .....	45
4.6.3	TEST INSTRUMENTS.....	45
4.6.4	TEST PROCEDURE .....	45
4.6.5	DEVIATION FROM TEST STANDARD .....	46
4.6.6	EUT OPERATING CONDITION .....	46
4.6.7	TEST RESULTS .....	46
4.6.8	TEST RESULTS .....	47
5.	TEST TYPES AND RESULTS (FOR 5.0GHz BAND).....	51
5.1	RADIATED EMISSION AND BANDEDGE MEASUREMENT.....	51
5.1.1	LIMITS OF RADIATED EMISSION AND BANDEDGE MEASUREMENT .....	51
5.1.2	TEST INSTRUMENTS.....	52
5.1.3	TEST PROCEDURES .....	53
5.1.4	DEVIATION FROM TEST STANDARD .....	53
5.1.5	TEST SETUP .....	54
5.1.6	EUT OPERATING CONDITIONS .....	54
5.1.7	TEST RESULTS .....	55
5.2	CONDUCTED EMISSION MEASUREMENT .....	64
5.2.1	LIMITS OF CONDUCTED EMISSION MEASUREMENT.....	64
5.2.2	TEST INSTRUMENTS.....	64
5.2.3	TEST PROCEDURES .....	65
5.2.4	DEVIATION FROM TEST STANDARD .....	65
5.2.5	TEST SETUP .....	66
5.2.6	EUT OPERATING CONDITIONS .....	66
5.2.7	TEST RESULTS .....	67
5.3	6dB BANDWIDTH MEASUREMENT .....	69
5.3.1	LIMITS OF 6dB BANDWIDTH MEASUREMENT .....	69
5.3.2	TEST SETUP .....	69
5.3.3	TEST INSTRUMENTS.....	69
5.3.4	TEST PROCEDURE .....	69
5.3.5	DEVIATION FROM TEST STANDARD .....	69
5.3.6	EUT OPERATING CONDITIONS .....	69
5.3.7	TEST RESULTS .....	70
5.4	MAXIMUM OUTPUT POWER.....	71
5.4.1	LIMITS OF MAXIMUM OUTPUT POWER MEASUREMENT .....	71
5.4.2	TEST SETUP .....	71
5.4.3	INSTRUMENTS.....	71
5.4.4	TEST PROCEDURES .....	71
5.4.5	DEVIATION FROM TEST STANDARD .....	71
5.4.6	EUT OPERATING CONDITIONS .....	71
5.4.7	TEST RESULTS .....	72
5.5	POWER SPECTRAL DENSITY MEASUREMENT.....	73
5.5.1	LIMITS OF POWER SPECTRAL DENSITY MEASUREMENT .....	73
5.5.2	TEST SETUP .....	73
5.5.3	TEST INSTRUMENTS.....	73
5.5.4	TEST PROCEDURE .....	73
5.5.5	DEVIATION FROM TEST STANDARD .....	73
5.5.6	EUT OPERATING CONDITION .....	73
5.5.7	TEST RESULTS .....	74



**A D T**

5.6	CONDUCTED EMISSION MEASUREMENT .....	75
5.6.1	LIMITS OF BAND EDGES MEASUREMENT.....	75
5.6.2	TEST SETUP .....	75
5.6.3	TEST INSTRUMENTS.....	75
5.6.4	TEST PROCEDURE .....	75
5.6.5	DEVIATION FROM TEST STANDARD .....	76
5.6.6	EUT OPERATING CONDITION .....	76
5.6.7	TEST RESULTS .....	76
6.	PHOTOGRAPHS OF THE TEST CONFIGURATION.....	80
7.	INFORMATION ON THE TESTING LABORATORIES .....	81
8.	APPENDIX A - MODIFICATIONS RECORDERS FOR ENGINEERING CHANGES TO THE EUT BY THE LAB.....	82



A D T

## RELEASE CONTROL RECORD

ISSUE NO.	REASON FOR CHANGE	DATE ISSUED
Original release	NA	Dec. 09, 2011



A D T

## 1. CERTIFICATION

**PRODUCT:** Wireless Router

**MODEL:** TEW-751DR

**BRAND:** TRENDnet

**APPLICANT:** TRENDNET, Inc.

**TESTED:** Nov. 14 ~ Dec. 06, 2011

**TEST SAMPLE:** ENGINEERING SAMPLE

**STANDARDS:** **FCC Part 15, Subpart C (Section 15.247)**

ANSI C63.4-2003

ANSI C63.10-2009

The above equipment (Model: TEW-751DR) has been tested by **Bureau Veritas Consumer Products Services (H.K.) Ltd., Taoyuan Branch**, and found compliance with the requirement of the above standards. The test record, data evaluation & Equipment Under Test (EUT) configurations represented herein are true and accurate accounts of the measurements of the sample's EMC characteristics under the conditions specified in this report.

PREPARED BY :  , DATE: Dec. 09, 2011  
Pettie Chen / Specialist

APPROVED BY :  , DATE: Dec. 09, 2011  
Gary Chang / Technical Manager

## 2. SUMMARY OF TEST RESULTS

The EUT has been tested according to the following specifications:

<b>APPLIED STANDARD: FCC PART 15, SUBPART C (SECTION 15.247)</b>			
<b>STANDARD SECTION</b>	<b>TEST TYPE AND LIMIT</b>	<b>RESULT</b>	<b>REMARK</b>
15.207	AC Power Conducted Emission	PASS	Meet the requirement of limit. Minimum passing margin is -13.17dB at 0.172MHz.
15.247(d) 15.209	Radiated Emissions	PASS	Meet the requirement of limit. Minimum passing margin is -1.0dB at 4874MHz.
15.247(d)	Band Edge Measurement	PASS	Meet the requirement of limit.
15.247(a)(2)	6dB bandwidth	PASS	Meet the requirement of limit.
15.247(b)	Conducted power	PASS	Meet the requirement of limit.
15.247(e)	Power Spectral Density	PASS	Meet the requirement of limit.
15.203	Antenna Requirement	PASS	Antenna connector is UFL not a standard connector.

### 2.1 MEASUREMENT UNCERTAINTY

Where relevant, the following measurement uncertainty levels have been estimated for tests performed on the EUT as specified in CISPR 16-4-2:

<b>MEASUREMENT</b>	<b>FREQUENCY</b>	<b>UNCERTAINTY</b>
Conducted emissions	150kHz~30MHz	2.44 dB
Radiated emissions	30MHz ~ 200MHz	2.93 dB
	200MHz ~1000MHz	2.95 dB
	1GHz ~ 18GHz	2.26 dB
	18GHz ~ 40GHz	1.94 dB

This uncertainty represents an expanded uncertainty expressed at approximately the 95% confidence level using a coverage factor of  $k = 2$ .



### 3. GENERAL INFORMATION

#### 3.1 GENERAL DESCRIPTION OF EUT

<b>EUT</b>	Wireless Router
<b>MODEL NO.</b>	TEW-751DR
<b>FCC ID</b>	XU8TEW751DR
<b>POWER SUPPLY</b>	12Vdc (adapter)
<b>MODULATION TYPE</b>	CCK, DQPSK, DBPSK for DSSS 64QAM, 16QAM, QPSK, BPSK for OFDM
<b>MODULATION TECHNOLOGY</b>	DSSS, OFDM
<b>TRANSFER RATE</b>	802.11b: 11.0/ 5.5/ 2.0/ 1.0Mbps 802.11g: 54.0/ 48.0/ 36.0/ 24.0/ 18.0/ 12.0/ 9.0/ 6.0Mbps 802.11a: 54.0/ 48.0/ 36.0/ 24.0/ 18.0/ 12.0/ 9.0/ 6.0Mbps 802.11n: up to 300.0Mbps
<b>OPERATING FREQUENCY</b>	2.4GHz: 2412 ~ 2462MHz 5.0GHz: 5745 ~ 5825MHz
<b>NUMBER OF CHANNEL</b>	<b>2.4GHz:</b> 11 for 802.11b, 802.11g, 802.11n (20MHz) 7 for 802.11n (40MHz) <b>5.0GHz:</b> 5 for 802.11a, 802.11n (20MHz) 2 for 802.11n (40MHz)
<b>OUTPUT POWER</b>	352.7mW for 2412 ~ 2462MHz 295.9mW for 5745 ~ 5825MHz
<b>ANTENNA TYPE</b>	Dipole antenna with 2dBi gain
<b>ANTENNA CONNECTOR</b>	UFL
<b>DATA CABLE</b>	NA
<b>I/O PORTS</b>	Refer to user's manual
<b>ACCESSORY DEVICES</b>	Adapter

**NOTE:**

1. The frequency bands used in this EUT are listed as follows:

Frequency Band (MHz)	2412~2462	5180~5240	5745~5825
802.11b	√		
802.11g	√		
802.11a		√	√
802.11n (20MHz)	√	√	√
802.11n (40MHz)	√	√	√





2. The EUT incorporates a MIMO function. Physically, the EUT provides two completed transmitters and two receivers.

MODULATION MODE	TX FUNCTION
802.11b	1TX
802.11g	1TX
802.11a	1TX
802.11n (20MHz)	2TX
802.11n (40MHz)	2TX

3. The EUT is powered by the following adapter.

<b>BRAND:</b>	CWT
<b>MODEL:</b>	CAP012121 US
<b>INPUT:</b>	100-240Vac, 47-63Hz, 0.35A
<b>OUTPUT:</b>	12Vdc, 1.0A
<b>POWER LINE:</b>	1.1m non-shielded cable without core

4. The above EUT information is declared by the manufacturer and for more detailed features description, please refer to the manufacturer's specifications or User's Manual.

### 3.2 DESCRIPTION OF TEST MODES

#### FOR 2.4GHz:

11 channels are provided for 802.11b, 802.11g and 802.11n (20MHz):

CHANNEL	FREQUENCY	CHANNEL	FREQUENCY
1	2412MHz	7	2442MHz
2	2417MHz	8	2447MHz
3	2422MHz	9	2452MHz
4	2427MHz	10	2457MHz
5	2432MHz	11	2462MHz
6	2437MHz		

7 channels are provided for 802.11n (40MHz):

CHANNEL	FREQUENCY	CHANNEL	FREQUENCY
1	2422MHz	5	2442MHz
2	2427MHz	6	2447MHz
3	2432MHz	7	2452MHz
4	2437MHz		

#### FOR 5.0GHz (5745 ~ 5825MHz):

5 channels are provided for 802.11a, 802.11n (20MHz):

CHANNEL	FREQUENCY	CHANNEL	FREQUENCY
149	5745MHz	161	5805MHz
153	5765MHz	165	5825MHz
157	5785MHz		

2 channels are provided for 802.11n (40MHz):

CHANNEL	FREQUENCY	CHANNEL	FREQUENCY
151	5755MHz	159	5795MHz

### 3.2.1 CONFIGURATION OF SYSTEM UNDER TEST

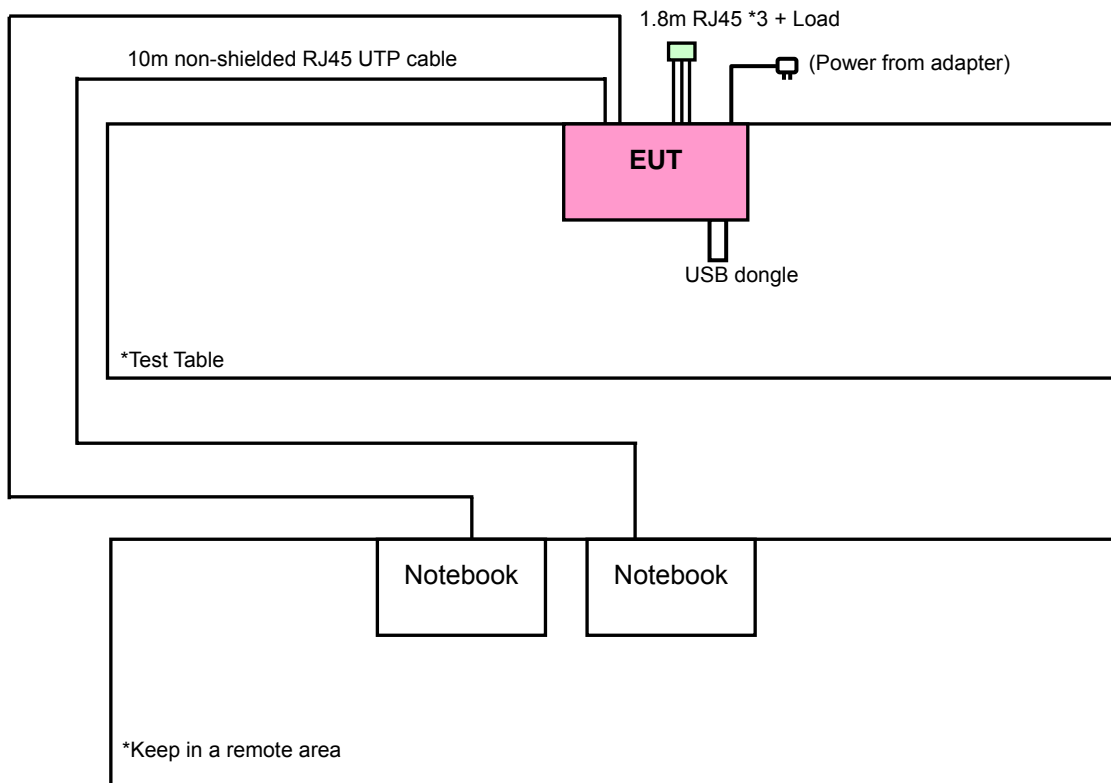

### 3.2.2 TEST MODE APPLICABILITY AND TESTED CHANNEL DETAIL

#### FOR 2.4GHz:

EUT CONFIGURE MODE	APPLICABLE TO				DESCRIPTION
	RE $\geq$ 1G	RE<1G	PLC	APCM	
-	√	√	√	√	-

Where **RE $\geq$ 1G**: Radiated Emission above 1GHz      **RE<1G**: Radiated Emission below 1GHz  
**PLC**: Power Line Conducted Emission      **APCM**: Antenna Port Conducted Measurement

#### RADIATED EMISSION TEST (ABOVE 1GHz):

- Pre-Scan has been conducted to determine the worst-case mode from all possible combinations between available modulations, XYZ axis and antenna ports (if EUT with antenna diversity architecture).
- Following channel(s) was (were) selected for the final test as listed below.

EUT CONFIGURE MODE	MODE	AVAILABLE CHANNEL	TESTED CHANNEL	MODULATION TECHNOLOGY	MODULATION TYPE	DATA RATE (Mbps)	AXIS
-	802.11b	1 to 11	1, 6, 11	DSSS	DBPSK	1.0	Z
-	802.11g	1 to 11	1, 6, 11	OFDM	BPSK	6.0	Z
-	802.11n (20MHz)	1 to 11	1, 6, 11	OFDM	BPSK	7.2	Z
-	802.11n (40MHz)	1 to 7	1, 4, 7	OFDM	BPSK	15.0	Z

#### RADIATED EMISSION TEST (BELOW 1GHz):

- Pre-Scan has been conducted to determine the worst-case mode from all possible combinations between available modulations , XYZ axis and antenna ports (if EUT with antenna diversity architecture).
- Following channel(s) was (were) selected for the final test as listed below.

EUT CONFIGURE MODE	MODE	AVAILABLE CHANNEL	TESTED CHANNEL	MODULATION TECHNOLOGY	MODULATION TYPE	DATA RATE (Mbps)	AXIS
-	802.11n (20MHz)	1 to 11	6	OFDM	BPSK	7.2	Z

#### POWER LINE CONDUCTED EMISSION TEST:

- Pre-Scan has been conducted to determine the worst-case mode from all possible combinations between available modulations, data rates and antenna ports (if EUT with antenna diversity architecture).
- Following channel(s) was (were) selected for the final test as listed below.

EUT CONFIGURE MODE	MODE	AVAILABLE CHANNEL	TESTED CHANNEL	MODULATION TECHNOLOGY	MODULATION TYPE	DATA RATE (Mbps)
-	802.11n (20MHz)	1 to 11	6	OFDM	BPSK	7.2



**BANDEDGE MEASUREMENT:**

- Pre-Scan has been conducted to determine the worst-case mode from all possible combinations between available modulations, data rates, XYZ axis and antenna ports (if EUT with antenna diversity architecture).
- Following channel(s) was (were) selected for the final test as listed below.

EUT CONFIGURE MODE	MODE	AVAILABLE CHANNEL	TESTED CHANNEL	MODULATION TECHNOLOGY	MODULATION TYPE	DATA RATE (Mbps)	AXIS
-	802.11b	1 to 11	1, 11	DSSS	DBPSK	1.0	Z
-	802.11g	1 to 11	1, 11	OFDM	BPSK	6.0	Z
-	802.11n (20MHz)	1 to 11	1, 11	OFDM	BPSK	7.2	Z
-	802.11n (40MHz)	1 to 7	1, 7	OFDM	BPSK	15.0	Z

**ANTENNA PORT CONDUCTED MEASUREMENT:**

- Pre-Scan has been conducted to determine the worst-case mode from all possible combinations between available modulations, data rates and antenna ports (if EUT with antenna diversity architecture).
- Following channel(s) was (were) selected for the final test as listed below.

EUT CONFIGURE MODE	MODE	AVAILABLE CHANNEL	TESTED CHANNEL	MODULATION TECHNOLOGY	MODULATION TYPE	DATA RATE (Mbps)
-	802.11b	1 to 11	1, 6, 11	DSSS	DBPSK	1.0
-	802.11g	1 to 11	1, 6, 11	OFDM	BPSK	6.0
-	802.11n (20MHz)	1 to 11	1, 6, 11	OFDM	BPSK	7.2
-	802.11n (40MHz)	1 to 7	1, 4, 7	OFDM	BPSK	15.0

**TEST CONDITION:**

APPLICABLE TO	ENVIRONMENTAL CONDITIONS	INPUT POWER	TESTED BY
RE≥1G	25deg. C, 65%RH	120Vac, 60Hz	Sun Lin
RE<1G	25deg. C, 65%RH	120Vac, 60Hz	Sun Lin
PLC	25deg. C, 65%RH	120Vac, 60Hz	Anderson Hong
APCM	25deg. C, 68%RH	120Vac, 60Hz	Sun Lin



A D T

**FOR 5.745 ~ 5.825GHz:**

EUT CONFIGURE MODE	APPLICABLE TO				DESCRIPTION
	RE≥1G	RE<1G	PLC	APCM	
-	√	√	√	√	-

Where **PLC:** Power Line Conducted Emission      **RE<1G:** Radiated Emission below 1GHz  
**RE≥1G:** Radiated Emission above 1GHz      **APCM:** Antenna Port Conducted Measurement

**RADIATED EMISSION TEST (ABOVE 1GHz):**

- Pre-Scan has been conducted to determine the worst-case mode from all possible combinations between available modulations, XYZ axis and antenna ports (if EUT with antenna diversity architecture).
- Following channel(s) was (were) selected for the final test as listed below.

EUT CONFIGURE MODE	MODE	AVAILABLE CHANNEL	TESTED CHANNEL	MODULATION TECHNOLOGY	MODULATION TYPE	DATA RATE (Mbps)	AXIS
-	802.11a	149 to 165	149, 157, 165	OFDM	BPSK	6.0	Z
-	802.11n (20MHz)	149 to 165	149, 157, 165	OFDM	BPSK	7.2	Z
-	802.11n (40MHz)	151 to 159	151, 159	OFDM	BPSK	15.0	Z

**RADIATED EMISSION TEST (BELOW 1GHz):**

- Pre-Scan has been conducted to determine the worst-case mode from all possible combinations between available modulations, XYZ axis and antenna ports (if EUT with antenna diversity architecture).
- Following channel(s) was (were) selected for the final test as listed below.

EUT CONFIGURE MODE	MODE	AVAILABLE CHANNEL	TESTED CHANNEL	MODULATION TECHNOLOGY	MODULATION TYPE	DATA RATE (Mbps)	AXIS
-	802.11n (20MHz)	149 to 165	165	OFDM	BPSK	7.2	Z

**POWER LINE CONDUCTED EMISSION TEST:**

- Pre-Scan has been conducted to determine the worst-case mode from all possible combinations between available modulations, data rates and antenna ports (if EUT with antenna diversity architecture).
- Following channel(s) was (were) selected for the final test as listed below.

EUT CONFIGURE MODE	MODE	AVAILABLE CHANNEL	TESTED CHANNEL	MODULATION TECHNOLOGY	MODULATION TYPE	DATA RATE (Mbps)
-	802.11n (20MHz)	149 to 165	165	OFDM	BPSK	7.2



**BANDEDGE MEASUREMENT:**

- Pre-Scan has been conducted to determine the worst-case mode from all possible combinations between available modulations, data rates, XYZ axis and antenna ports (if EUT with antenna diversity architecture).
- Following channel(s) was (were) selected for the final test as listed below.

EUT CONFIGURE MODE	MODE	AVAILABLE CHANNEL	TESTED CHANNEL	MODULATION TECHNOLOGY	MODULATION TYPE	DATA RATE (Mbps)	AXIS
-	802.11a	149 to 165	149, 165	OFDM	BPSK	6.0	Z
-	802.11n (20MHz)	149 to 165	149, 165	OFDM	BPSK	7.2	Z
-	802.11n (40MHz)	151 to 159	151, 159	OFDM	BPSK	15.0	Z

**ANTENNA PORT CONDUCTED MEASUREMENT:**

- Pre-Scan has been conducted to determine the worst-case mode from all possible combinations between available modulations, data rates and antenna ports (if EUT with antenna diversity architecture).
- Following channel(s) was (were) selected for the final test as listed below.

EUT CONFIGURE MODE	MODE	AVAILABLE CHANNEL	TESTED CHANNEL	MODULATION TECHNOLOGY	MODULATION TYPE	DATA RATE (Mbps)
-	802.11a	149 to 165	149, 157, 165	OFDM	BPSK	6.0
-	802.11n (20MHz)	149 to 165	149, 157, 165	OFDM	BPSK	7.2
-	802.11n (40MHz)	151 to 159	151, 159	OFDM	BPSK	15.0

**TEST CONDITION:**

APPLICABLE TO	ENVIRONMENTAL CONDITIONS	INPUT POWER	TESTED BY
RE≥1G	25deg. C, 65%RH	120Vac, 60Hz	Sun Lin
RE<1G	25deg. C, 65%RH	120Vac, 60Hz	Sun Lin
PLC	25deg. C, 65%RH	120Vac, 60Hz	Anderson Hong
APCM	25deg. C, 68%RH	120Vac, 60Hz	Sun Lin



A D T

### 3.3 GENERAL DESCRIPTION OF APPLIED STANDARDS

The EUT is a RF Product. According to the specifications of the manufacturer, it must comply with the requirements of the following standards:

**FCC Part 15, Subpart C (15.247)**

**ANSI C63.4-2003**

**ANSI C63.10-2009**

All test items have been performed and recorded as per the above standards.

**NOTE:** The EUT is also considered as a kind of computer peripheral, because the connection to computer is necessary for typical use. It has been verified to comply with the requirements of FCC Part 15, Subpart B, Class B (DoC). The test report has been issued separately.

### 3.4 DESCRIPTION OF SUPPORT UNITS

The EUT has been tested as an independent unit together with other necessary accessories or support units. The following support units or accessories were used to form a representative test configuration during the tests.

NO.	PRODUCT	BRAND	MODEL NO.	SERIAL NO.	FCC ID
1	NOTEBOOK	DELL	D531	CN-0XM006-48643-81U-2786	QDS-BRCM1020
2	NOTEBOOK	DELL	D531	CN-0XM006-48643-81U-2973	QDS-BRCM1020
3	USB DONGLE	Transcend	V85	538455 4481	NA

NO.	SIGNAL CABLE DESCRIPTION OF THE ABOVE SUPPORT UNITS
1	10m RJ45 UTP cable without core.
2	10m RJ45 UTP cable without core.
3	NA

**NOTE:**

1. All power cords of the above support units are non-shielded (1.8m).
2. Item 1, 2 acted communication partners to transfer data.





## 4. TEST TYPES AND RESULTS (FOR 2.4GHz BAND)

### 4.1 RADIATED EMISSION AND BANDEDGE MEASUREMENT

#### 4.1.1 LIMITS OF RADIATED EMISSION AND BANDEDGE MEASUREMENT

Radiated emissions which fall in the restricted bands, as defined in Section 15.205(a), must also comply with the radiated emission limits specified in Section 15.209(a). Other emissions shall be at least 20dB below the highest level of the desired power.

FREQUENCIES (MHz)	FIELD STRENGTH (microvolts/meter)	MEASUREMENT DISTANCE (meters)
0.009 ~ 0.490	2400/F(kHz)	300
0.490 ~ 1.705	24000/F(kHz)	30
1.705 ~ 30.0	30	30
30 ~ 88	100	3
88 ~ 216	150	3
216 ~ 960	200	3
Above 960	500	3

**NOTE:**

1. The lower limit shall apply at the transition frequencies.
2. Emission level (dBuV/m) = 20 log Emission level (uV/m).
3. As shown in 15.35(b), for frequencies above 1000MHz, the field strength limits are based on average detector, however, the peak field strength of any emission shall not exceed the maximum permitted average limits, specified above by more than 20dB under any condition of modulation.



A D T

#### 4.1.2 TEST INSTRUMENTS

DESCRIPTION & MANUFACTURER	MODEL NO.	SERIAL NO.	DATE OF CALIBRATION	DUE DATE OF CALIBRATION
Test Receiver ROHDE & SCHWARZ	ESCI	100744	Apr. 19, 2011	Apr. 18, 2012
Spectrum Analyzer ROHDE & SCHWARZ	FSP40	100269	Jan. 06, 2011	Jan. 05, 2012
BILOG Antenna SCHWARZBECK	VULB9168	9168-156	Apr. 12, 2011	Apr. 11, 2012
HORN Antenna SCHWARZBECK	BBHA 9120 D	9120D-563	Sep. 06, 2011	Sep. 05, 2012
HORN Antenna SCHWARZBECK	BBHA 9170	BBHA9170243	Dec. 27, 2010	Dec. 26, 2011
Preamplifier Agilent	8449B	3008A01911	Oct. 29, 2011	Oct. 28, 2012
Preamplifier Agilent	8447D	2944A10638	Oct. 29, 2011	Oct. 28, 2012
RF signal cable HUBER+SUHNNER	SUCOFLEX 104	295013/4 283403/4	Aug. 19, 2011	Aug. 18, 2012
RF signal cable Worken	8D-FB	Cable-HYCH9-01	Aug. 13, 2011	Aug. 12, 2012
Software	ADT_Radiated_ V7.6.15.9.2	NA	NA	NA
Antenna Tower EMCO	2070/2080	512.835.4684	NA	NA
Turn Table EMCO	2087-2.03	NA	NA	NA
Antenna Tower & Turn Table Controller EMCO	2090	NA	NA	NA
High Speed Peak Power Meter	ML2495A	0824011	Aug. 04, 2011	Aug. 03, 2012
Power Sensor	MA2411B	0738171	Aug. 04, 2011	Aug. 03, 2012

- NOTE:**
1. The calibration interval of the above test instruments is 12 months and the calibrations are traceable to NML/ROC and NIST/USA.
  2. The test was performed in HwaYa Chamber 9.
  3. The horn antenna and HP preamplifier (model: 8449B) are used only for the measurement of emission frequency above 1GHz if tested.
  4. The FCC Site Registration No. is 460141.
  5. The IC Site Registration No. is IC 7450F-4.



#### 4.1.3 TEST PROCEDURES

- a. The EUT was placed on the top of a rotating table 0.8 meters above the ground at a 3 meters semi-anechoic chamber. The table was rotated 360 degrees to determine the position of the highest radiation.
- b. The EUT was set 3 meters away from the interference-receiving antenna, which was mounted on the top of a variable-height antenna tower.
- c. The antenna is a broadband antenna, and its height is varied from one meter to four meters above the ground to determine the maximum value of the field strength. Both horizontal and vertical polarizations of the antenna are set to make the measurement.
- d. For each suspected emission, the EUT was arranged to its worst case and then the antenna was tuned to heights from 1 meter to 4 meters and the rotatable table was turned from 0 degrees to 360 degrees to find the maximum reading.
- e. The test-receiver system was set to Peak Detect Function and Specified Bandwidth with Maximum Hold Mode.
- f. If the emission level of the EUT in peak mode was lower than the limit specified, then testing could be stopped and the peak values of the EUT would be reported. Otherwise the emissions would be re-tested one by one using peak, quasi-peak or average method as specified and then reported in a data sheet.

**NOTE:**

1. The resolution bandwidth and video bandwidth of test receiver/spectrum analyzer is 120kHz for Quasi-peak detection at frequency below 1GHz.
2. The resolution bandwidth of test receiver/spectrum analyzer is 100kHz and video bandwidth is 300kHz for Peak detection at frequency above 1GHz.
3. The resolution bandwidth of test receiver/spectrum analyzer is 1MHz and the video bandwidth is 1kHz for Average detection (AV) at frequency above 1GHz.
4. All modes of operation were investigated and the worst-case emissions are reported.

#### 4.1.4 DEVIATION FROM TEST STANDARD

No deviation.

#### 4.1.5 TEST SETUP

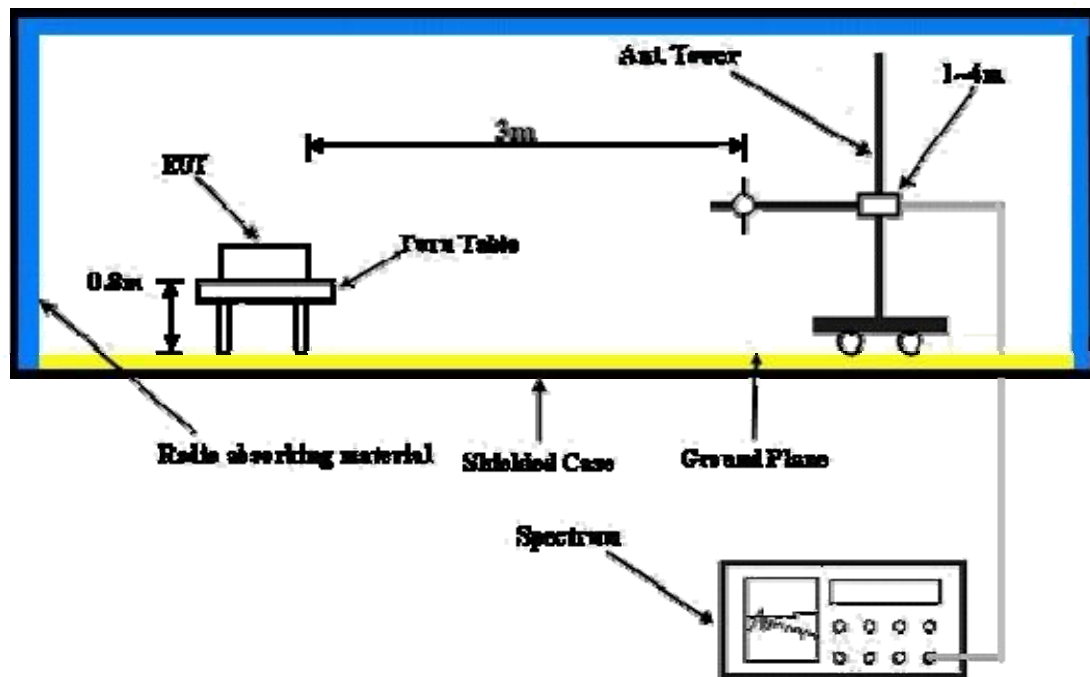

For the actual test configuration, please refer to the attached file (Test Setup Photo).

#### 4.1.6 EUT OPERATING CONDITIONS

- a. Placed the EUT on the testing table.
- b. Prepared notebooks to act as communication partner and placed it outside of testing area.
- c. The communication partner connected with EUT via a RJ45 cable and run a test program (provided by manufacturer) to enable EUT under transmission condition continuously at specific channel frequency.
- d. The communication partner sent data to EUT by command "PING".
- e. The communication partner read and wrote with the USB dongle via EUT.



A D T

### 4.1.7 TEST RESULTS

#### 802.11b

EUT TEST CONDITION		MEASUREMENT DETAIL	
CHANNEL	Channel 1	FREQUENCY RANGE	1 ~ 25GHz
INPUT POWER (SYSTEM)	120Vac, 60 Hz	DETECTOR FUNCTION	Peak (PK) Average (AV)
ENVIRONMENTAL CONDITIONS	25deg. C, 68%RH	TESTED BY	Sun Lin

ANTENNA POLARITY & TEST DISTANCE: HORIZONTAL AT 3 M								
NO.	FREQ. (MHz)	EMISSION LEVEL (dBuV/m)	LIMIT (dBuV/m)	MARGIN (dB)	ANTENNA HEIGHT (m)	TABLE ANGLE (Degree)	RAW VALUE (dBuV)	CORRECTION FACTOR (dB/m)
1	2390.00	58.1 PK	74.0	-15.9	1.00 H	2	26.60	31.50
2	2390.00	45.4 AV	54.0	-8.6	1.00 H	2	13.90	31.50
3	*2412.00	103.5 PK			1.00 H	2	71.90	31.60
4	*2412.00	99.5 AV			1.00 H	2	67.90	31.60
5	4824.00	54.8 PK	74.0	-19.2	1.00 H	169	17.10	37.70
6	4824.00	52.8 AV	54.0	-1.2	1.00 H	169	15.10	37.70
ANTENNA POLARITY & TEST DISTANCE: VERTICAL AT 3 M								
NO.	FREQ. (MHz)	EMISSION LEVEL (dBuV/m)	LIMIT (dBuV/m)	MARGIN (dB)	ANTENNA HEIGHT (m)	TABLE ANGLE (Degree)	RAW VALUE (dBuV)	CORRECTION FACTOR (dB/m)
1	2390.00	56.5 PK	74.0	-17.5	1.00 V	328	25.00	31.50
2	2390.00	46.7 AV	54.0	-7.3	1.00 V	328	15.20	31.50
3	*2412.00	106.2 PK			1.00 V	328	74.60	31.60
4	*2412.00	102.4 AV			1.00 V	328	70.80	31.60
5	4824.00	52.2 PK	74.0	-21.8	1.09 V	22	14.50	37.70
6	4824.00	48.4 AV	54.0	-5.6	1.09 V	22	10.70	37.70

- REMARKS:**
1. Emission level (dBuV/m) = Raw Value (dBuV) + Correction Factor (dB/m).
  2. Correction Factor (dB/m) = Antenna Factor (dB/m) + Cable Factor (dB).
  3. The other emission levels were very low against the limit.
  4. Margin value = Emission level – Limit value.
  5. “ \* ”: Fundamental frequency.



A D T

EUT TEST CONDITION		MEASUREMENT DETAIL	
CHANNEL	Channel 6	FREQUENCY RANGE	1 ~ 25GHz
INPUT POWER (SYSTEM)	120Vac, 60 Hz	DETECTOR FUNCTION	Peak (PK) Average (AV)
ENVIRONMENTAL CONDITIONS	25deg. C, 65%RH	TESTED BY	Sun Lin

ANTENNA POLARITY & TEST DISTANCE: HORIZONTAL AT 3 M								
NO.	FREQ. (MHz)	EMISSION LEVEL (dBuV/m)	LIMIT (dBuV/m)	MARGIN (dB)	ANTENNA HEIGHT (m)	TABLE ANGLE (Degree)	RAW VALUE (dBuV)	CORRECTION FACTOR (dB/m)
1	2390.00	38.5 PK	74.0	-35.5	1.53 H	4	7.00	31.50
2	2390.00	28.5 AV	54.0	-25.5	1.53 H	4	-3.00	31.50
3	*2437.00	102.6 PK			1.53 H	4	70.90	31.70
4	*2437.00	98.8 AV			1.53 H	4	67.10	31.70
5	4874.00	55.6 PK	74.0	-18.4	1.00 H	39	17.80	37.80
6	4874.00	53.0 AV	54.0	-1.0	1.00 H	39	15.20	37.80
ANTENNA POLARITY & TEST DISTANCE: VERTICAL AT 3 M								
NO.	FREQ. (MHz)	EMISSION LEVEL (dBuV/m)	LIMIT (dBuV/m)	MARGIN (dB)	ANTENNA HEIGHT (m)	TABLE ANGLE (Degree)	RAW VALUE (dBuV)	CORRECTION FACTOR (dB/m)
1	2390.00	49.4 PK	74.0	-24.6	1.00 V	181	17.90	31.50
2	2390.00	44.4 AV	54.0	-9.6	1.00 V	181	12.90	31.50
3	*2437.00	105.8 PK			1.00 V	181	74.10	31.70
4	*2437.00	102.0 AV			1.00 V	181	70.30	31.70
5	4874.00	51.8 PK	74.0	-22.2	1.09 V	22	14.00	37.80
6	4874.00	47.5 AV	54.0	-6.5	1.09 V	22	9.70	37.80

- REMARKS:**
1. Emission level (dBuV/m) = Raw Value (dBuV) + Correction Factor (dB/m).
  2. Correction Factor (dB/m) = Antenna Factor (dB/m) + Cable Factor (dB).
  3. The other emission levels were very low against the limit.
  4. Margin value = Emission level – Limit value.
  5. “ \* “: Fundamental frequency.



A D T

EUT TEST CONDITION		MEASUREMENT DETAIL	
CHANNEL	Channel 11	FREQUENCY RANGE	1 ~ 25GHz
INPUT POWER (SYSTEM)	120Vac, 60 Hz	DETECTOR FUNCTION	Peak (PK) Average (AV)
ENVIRONMENTAL CONDITIONS	25deg. C, 68%RH	TESTED BY	Sun Lin

ANTENNA POLARITY & TEST DISTANCE: HORIZONTAL AT 3 M								
NO.	FREQ. (MHz)	EMISSION LEVEL (dBuV/m)	LIMIT (dBuV/m)	MARGIN (dB)	ANTENNA HEIGHT (m)	TABLE ANGLE (Degree)	RAW VALUE (dBuV)	CORRECTION FACTOR (dB/m)
1	*2462.00	102.2 PK			1.00 H	2	70.40	31.80
2	*2462.00	98.4 AV			1.00 H	2	66.60	31.80
3	2483.50	60.8 PK	74.0	-13.2	1.00 H	2	28.90	31.90
4	2483.50	49.4 AV	54.0	-4.6	1.00 H	2	17.50	31.90
5	4924.00	55.5 PK	74.0	-18.5	1.00 H	171	17.60	37.90
6	4924.00	52.8 AV	54.0	-1.2	1.00 H	171	14.90	37.90
ANTENNA POLARITY & TEST DISTANCE: VERTICAL AT 3 M								
NO.	FREQ. (MHz)	EMISSION LEVEL (dBuV/m)	LIMIT (dBuV/m)	MARGIN (dB)	ANTENNA HEIGHT (m)	TABLE ANGLE (Degree)	RAW VALUE (dBuV)	CORRECTION FACTOR (dB/m)
1	*2462.00	105.3 PK			1.15 V	334	73.50	31.80
2	*2462.00	101.7 AV			1.15 V	334	69.90	31.80
3	2483.50	58.9 PK	74.0	-15.1	1.15 V	334	27.00	31.90
4	2483.50	49.7 AV	54.0	-4.3	1.15 V	334	17.80	31.90
5	4924.00	54.1 PK	74.0	-19.9	1.13 V	14	16.20	37.90
6	4924.00	48.0 AV	54.0	-6.0	1.13 V	14	10.10	37.90

- REMARKS:**
1. Emission level (dBuV/m) = Raw Value (dBuV) + Correction Factor (dB/m).
  2. Correction Factor (dB/m) = Antenna Factor (dB/m) + Cable Factor (dB).
  3. The other emission levels were very low against the limit.
  4. Margin value = Emission level – Limit value.
  5. “ \* “: Fundamental frequency.



A D T

802.11g

EUT TEST CONDITION		MEASUREMENT DETAIL	
CHANNEL	Channel 1	FREQUENCY RANGE	1 ~ 25GHz
INPUT POWER (SYSTEM)	120Vac, 60 Hz	DETECTOR FUNCTION	Peak (PK) Average (AV)
ENVIRONMENTAL CONDITIONS	25deg. C, 65%RH	TESTED BY	Sun Lin

ANTENNA POLARITY & TEST DISTANCE: HORIZONTAL AT 3 M								
NO.	FREQ. (MHz)	EMISSION LEVEL (dBuV/m)	LIMIT (dBuV/m)	MARGIN (dB)	ANTENNA HEIGHT (m)	TABLE ANGLE (Degree)	RAW VALUE (dBuV)	CORRECTION FACTOR (dB/m)
1	2390.00	59.3 PK	74.0	-14.7	1.55 H	3	27.80	31.50
2	2390.00	41.9 AV	54.0	-12.1	1.55 H	3	10.40	31.50
3	*2412.00	100.9 PK			1.55 H	3	69.30	31.60
4	*2412.00	91.6 AV			1.55 H	3	60.00	31.60
5	4824.00	52.8 PK	74.0	-21.2	1.00 H	38	15.10	37.70
6	4824.00	40.8 AV	54.0	-13.2	1.00 H	38	3.10	37.70
ANTENNA POLARITY & TEST DISTANCE: VERTICAL AT 3 M								
NO.	FREQ. (MHz)	EMISSION LEVEL (dBuV/m)	LIMIT (dBuV/m)	MARGIN (dB)	ANTENNA HEIGHT (m)	TABLE ANGLE (Degree)	RAW VALUE (dBuV)	CORRECTION FACTOR (dB/m)
1	2390.00	57.6 PK	74.0	-16.4	1.22 V	106	26.10	31.50
2	2390.00	46.5 AV	54.0	-7.5	1.22 V	106	15.00	31.50
3	*2412.00	106.0 PK			1.22 V	106	74.40	31.60
4	*2412.00	96.5 AV			1.22 V	106	64.90	31.60
5	4824.00	53.4 PK	74.0	-20.6	1.18 V	175	15.70	37.70
6	4824.00	39.7 AV	54.0	-14.3	1.18 V	175	2.00	37.70

- REMARKS:**
1. Emission level (dBuV/m) = Raw Value (dBuV) + Correction Factor (dB/m).
  2. Correction Factor (dB/m) = Antenna Factor (dB/m) + Cable Factor (dB).
  3. The other emission levels were very low against the limit.
  4. Margin value = Emission level – Limit value.
  5. “ \* “: Fundamental frequency.





A D T

EUT TEST CONDITION		MEASUREMENT DETAIL	
CHANNEL	Channel 6	FREQUENCY RANGE	1 ~ 25GHz
INPUT POWER (SYSTEM)	120Vac, 60 Hz	DETECTOR FUNCTION	Peak (PK) Average (AV)
ENVIRONMENTAL CONDITIONS	25deg. C, 65%RH	TESTED BY	Sun Lin

ANTENNA POLARITY & TEST DISTANCE: HORIZONTAL AT 3 M								
NO.	FREQ. (MHz)	EMISSION LEVEL (dBuV/m)	LIMIT (dBuV/m)	MARGIN (dB)	ANTENNA HEIGHT (m)	TABLE ANGLE (Degree)	RAW VALUE (dBuV)	CORRECTION FACTOR (dB/m)
1	2390.00	42.1 PK	74.0	-31.9	1.55 H	4	10.60	31.50
2	2390.00	31.8 AV	54.0	-22.2	1.55 H	4	0.30	31.50
3	*2437.00	100.6 PK			1.55 H	4	68.90	31.70
4	*2437.00	91.2 AV			1.55 H	4	59.50	31.70
5	4874.00	55.1 PK	74.0	-18.9	1.00 H	39	17.30	37.80
6	4874.00	41.3 AV	54.0	-12.7	1.00 H	39	3.50	37.80
ANTENNA POLARITY & TEST DISTANCE: VERTICAL AT 3 M								
NO.	FREQ. (MHz)	EMISSION LEVEL (dBuV/m)	LIMIT (dBuV/m)	MARGIN (dB)	ANTENNA HEIGHT (m)	TABLE ANGLE (Degree)	RAW VALUE (dBuV)	CORRECTION FACTOR (dB/m)
1	2390.00	46.8 PK	74.0	-27.2	1.00 V	328	15.30	31.50
2	2390.00	35.4 AV	54.0	-18.6	1.00 V	328	3.90	31.50
3	*2437.00	105.8 PK			1.00 V	328	74.10	31.70
4	*2437.00	96.2 AV			1.00 V	328	64.50	31.70
5	4874.00	49.9 PK	74.0	-24.1	1.09 V	21	12.10	37.80
6	4874.00	36.4 AV	54.0	-17.6	1.09 V	21	-1.40	37.80

- REMARKS:**
1. Emission level (dBuV/m) = Raw Value (dBuV) + Correction Factor (dB/m).
  2. Correction Factor (dB/m) = Antenna Factor (dB/m) + Cable Factor (dB).
  3. The other emission levels were very low against the limit.
  4. Margin value = Emission level – Limit value.
  5. “ \* “: Fundamental frequency.



A D T

EUT TEST CONDITION		MEASUREMENT DETAIL	
CHANNEL	Channel 11	FREQUENCY RANGE	1 ~ 25GHz
INPUT POWER (SYSTEM)	120Vac, 60 Hz	DETECTOR FUNCTION	Peak (PK) Average (AV)
ENVIRONMENTAL CONDITIONS	25deg. C, 65%RH	TESTED BY	Sun Lin

ANTENNA POLARITY & TEST DISTANCE: HORIZONTAL AT 3 M								
NO.	FREQ. (MHz)	EMISSION LEVEL (dBuV/m)	LIMIT (dBuV/m)	MARGIN (dB)	ANTENNA HEIGHT (m)	TABLE ANGLE (Degree)	RAW VALUE (dBuV)	CORRECTION FACTOR (dB/m)
1	*2462.00	100.2 PK			1.51 H	4	68.40	31.80
2	*2462.00	90.8 AV			1.51 H	4	59.00	31.80
3	2483.50	64.1 PK	74.0	-9.9	1.51 H	4	32.20	31.90
4	2483.50	48.5 AV	54.0	-5.5	1.51 H	4	16.60	31.90
5	4924.00	54.3 PK	74.0	-19.7	1.00 H	39	16.40	37.90
6	4924.00	40.3 AV	54.0	-13.7	1.00 H	39	2.40	37.90
ANTENNA POLARITY & TEST DISTANCE: VERTICAL AT 3 M								
NO.	FREQ. (MHz)	EMISSION LEVEL (dBuV/m)	LIMIT (dBuV/m)	MARGIN (dB)	ANTENNA HEIGHT (m)	TABLE ANGLE (Degree)	RAW VALUE (dBuV)	CORRECTION FACTOR (dB/m)
1	*2462.00	105.3 PK			1.00 V	211	73.50	31.80
2	*2462.00	95.7 AV			1.00 V	211	63.90	31.80
3	2483.50	69.5 PK	74.0	-4.5	1.02 V	211	37.60	31.90
4	2483.50	52.4 AV	54.0	-1.6	1.02 V	211	20.50	31.90
5	4924.00	53.5 PK	74.0	-20.5	1.02 V	209	15.60	37.90
6	4924.00	38.9 AV	54.0	-15.1	1.02 V	209	1.00	37.90

- REMARKS:**
1. Emission level (dBuV/m) = Raw Value (dBuV) + Correction Factor (dB/m).
  2. Correction Factor (dB/m) = Antenna Factor (dB/m) + Cable Factor (dB).
  3. The other emission levels were very low against the limit.
  4. Margin value = Emission level – Limit value.
  5. “ \* “: Fundamental frequency.



A D T

802.11n (20MHz)

EUT TEST CONDITION		MEASUREMENT DETAIL	
CHANNEL	Channel 1	FREQUENCY RANGE	1 ~ 25GHz
INPUT POWER (SYSTEM)	120Vac, 60 Hz	DETECTOR FUNCTION	Peak (PK) Average (AV)
ENVIRONMENTAL CONDITIONS	25deg. C, 65%RH	TESTED BY	Sun Lin

ANTENNA POLARITY & TEST DISTANCE: HORIZONTAL AT 3 M								
NO.	FREQ. (MHz)	EMISSION LEVEL (dBuV/m)	LIMIT (dBuV/m)	MARGIN (dB)	ANTENNA HEIGHT (m)	TABLE ANGLE (Degree)	RAW VALUE (dBuV)	CORRECTION FACTOR (dB/m)
1	2390.00	54.9 PK	74.0	-19.1	1.21 H	0	23.40	31.50
2	2390.00	41.0 AV	54.0	-13.0	1.21 H	0	9.50	31.50
3	*2412.00	105.1 PK			1.21 H	0	73.50	31.60
4	*2412.00	93.0 AV			1.21 H	0	61.40	31.60
5	4824.00	50.8 PK	74.0	-23.2	1.00 H	38	13.10	37.70
6	4824.00	39.4 AV	54.0	-14.6	1.00 H	38	1.70	37.70
ANTENNA POLARITY & TEST DISTANCE: VERTICAL AT 3 M								
NO.	FREQ. (MHz)	EMISSION LEVEL (dBuV/m)	LIMIT (dBuV/m)	MARGIN (dB)	ANTENNA HEIGHT (m)	TABLE ANGLE (Degree)	RAW VALUE (dBuV)	CORRECTION FACTOR (dB/m)
1	2390.00	62.3 PK	74.0	-11.7	1.04 V	192	30.80	31.50
2	2390.00	47.9 AV	54.0	-6.1	1.04 V	192	16.40	31.50
3	*2412.00	109.6 PK			1.04 V	192	78.00	31.60
4	*2412.00	98.5 AV			1.04 V	192	66.90	31.60
5	4824.00	46.4 PK	74.0	-27.6	1.18 V	176	8.70	37.70
6	4824.00	34.3 AV	54.0	-19.7	1.18 V	176	-3.40	37.70

- REMARKS:**
1. Emission level (dBuV/m) = Raw Value (dBuV) + Correction Factor (dB/m).
  2. Correction Factor (dB/m) = Antenna Factor (dB/m) + Cable Factor (dB).
  3. The other emission levels were very low against the limit.
  4. Margin value = Emission level – Limit value.
  5. “ \* “: Fundamental frequency.



A D T

EUT TEST CONDITION		MEASUREMENT DETAIL	
CHANNEL	Channel 6	FREQUENCY RANGE	1 ~ 25GHz
INPUT POWER (SYSTEM)	120Vac, 60 Hz	DETECTOR FUNCTION	Peak (PK) Average (AV)
ENVIRONMENTAL CONDITIONS	25deg. C, 65%RH	TESTED BY	Sun Lin

ANTENNA POLARITY & TEST DISTANCE: HORIZONTAL AT 3 M								
NO.	FREQ. (MHz)	EMISSION LEVEL (dBuV/m)	LIMIT (dBuV/m)	MARGIN (dB)	ANTENNA HEIGHT (m)	TABLE ANGLE (Degree)	RAW VALUE (dBuV)	CORRECTION FACTOR (dB/m)
1	2390.00	42.0 PK	74.0	-32.0	1.22 H	1	10.50	31.50
2	2390.00	31.6 AV	54.0	-22.4	1.22 H	1	0.10	31.50
3	*2437.00	104.8 PK			1.22 H	1	73.10	31.70
4	*2437.00	92.7 AV			1.22 H	1	61.00	31.70
5	4874.00	50.7 PK	74.0	-23.3	1.00 H	39	12.90	37.80
6	4874.00	39.7 AV	54.0	-14.3	1.00 H	39	1.90	37.80
ANTENNA POLARITY & TEST DISTANCE: VERTICAL AT 3 M								
NO.	FREQ. (MHz)	EMISSION LEVEL (dBuV/m)	LIMIT (dBuV/m)	MARGIN (dB)	ANTENNA HEIGHT (m)	TABLE ANGLE (Degree)	RAW VALUE (dBuV)	CORRECTION FACTOR (dB/m)
1	2390.00	49.4 PK	74.0	-24.6	1.00 V	191	17.90	31.50
2	2390.00	37.3 AV	54.0	-16.7	1.00 V	191	5.80	31.50
3	*2437.00	109.2 PK			1.00 V	191	77.50	31.70
4	*2437.00	98.2 AV			1.00 V	191	66.50	31.70
5	4874.00	48.4 PK	74.0	-25.6	1.08 V	24	10.60	37.80
6	4874.00	35.2 AV	54.0	-18.8	1.08 V	24	-2.60	37.80

- REMARKS:**
1. Emission level (dBuV/m) = Raw Value (dBuV) + Correction Factor (dB/m).
  2. Correction Factor (dB/m) = Antenna Factor (dB/m) + Cable Factor (dB).
  3. The other emission levels were very low against the limit.
  4. Margin value = Emission level – Limit value.
  5. “ \* ”: Fundamental frequency.



A D T

EUT TEST CONDITION		MEASUREMENT DETAIL	
CHANNEL	Channel 11	FREQUENCY RANGE	1 ~ 25GHz
INPUT POWER (SYSTEM)	120Vac, 60 Hz	DETECTOR FUNCTION	Peak (PK) Average (AV)
ENVIRONMENTAL CONDITIONS	25deg. C, 65%RH	TESTED BY	Sun Lin

ANTENNA POLARITY & TEST DISTANCE: HORIZONTAL AT 3 M								
NO.	FREQ. (MHz)	EMISSION LEVEL (dBuV/m)	LIMIT (dBuV/m)	MARGIN (dB)	ANTENNA HEIGHT (m)	TABLE ANGLE (Degree)	RAW VALUE (dBuV)	CORRECTION FACTOR (dB/m)
1	*2462.00	104.5 PK			1.18 H	0	72.70	31.80
2	*2462.00	92.3 AV			1.18 H	0	60.50	31.80
3	2483.50	57.3 PK	74.0	-16.7	1.18 H	0	25.40	31.90
4	2483.50	43.3 AV	54.0	-10.7	1.18 H	0	11.40	31.90
5	4924.00	50.6 PK	74.0	-23.4	1.00 H	39	12.70	37.90
6	4924.00	38.6 AV	54.0	-15.4	1.00 H	39	0.70	37.90
ANTENNA POLARITY & TEST DISTANCE: VERTICAL AT 3 M								
NO.	FREQ. (MHz)	EMISSION LEVEL (dBuV/m)	LIMIT (dBuV/m)	MARGIN (dB)	ANTENNA HEIGHT (m)	TABLE ANGLE (Degree)	RAW VALUE (dBuV)	CORRECTION FACTOR (dB/m)
1	*2462.00	108.7 PK			1.25 V	188	76.90	31.80
2	*2462.00	97.8 AV			1.25 V	188	66.00	31.80
3	2483.50	66.3 PK	74.0	-7.7	1.00 V	177	34.40	31.90
4	2483.50	52.0 AV	54.0	-2.0	1.00 V	177	20.10	31.90
5	4924.00	47.9 PK	74.0	-26.1	1.00 V	208	10.00	37.90
6	4924.00	35.7 AV	54.0	-18.3	1.00 V	208	-2.20	37.90

- REMARKS:**
1. Emission level (dBuV/m) = Raw Value (dBuV) + Correction Factor (dB/m).
  2. Correction Factor (dB/m) = Antenna Factor (dB/m) + Cable Factor (dB).
  3. The other emission levels were very low against the limit.
  4. Margin value = Emission level – Limit value.
  5. “ \* “: Fundamental frequency.



A D T

802.11n (40MHz)

EUT TEST CONDITION		MEASUREMENT DETAIL	
CHANNEL	Channel 1	FREQUENCY RANGE	1 ~ 25GHz
INPUT POWER (SYSTEM)	120Vac, 60 Hz	DETECTOR FUNCTION	Peak (PK) Average (AV)
ENVIRONMENTAL CONDITIONS	25deg. C, 65%RH	TESTED BY	Sun Lin

ANTENNA POLARITY & TEST DISTANCE: HORIZONTAL AT 3 M								
NO.	FREQ. (MHz)	EMISSION LEVEL (dBuV/m)	LIMIT (dBuV/m)	MARGIN (dB)	ANTENNA HEIGHT (m)	TABLE ANGLE (Degree)	RAW VALUE (dBuV)	CORRECTION FACTOR (dB/m)
1	2390.00	57.0 PK	74.0	-17.0	1.23 H	0	25.50	31.50
2	2390.00	44.0 AV	54.0	-10.0	1.23 H	0	12.50	31.50
3	*2422.00	101.7 PK			1.23 H	0	70.10	31.60
4	*2422.00	89.9 AV			1.23 H	0	58.30	31.60
5	4844.00	49.1 PK	74.0	-24.9	1.00 H	38	11.40	37.70
6	4844.00	38.3 AV	54.0	-15.7	1.00 H	38	0.60	37.70
ANTENNA POLARITY & TEST DISTANCE: VERTICAL AT 3 M								
NO.	FREQ. (MHz)	EMISSION LEVEL (dBuV/m)	LIMIT (dBuV/m)	MARGIN (dB)	ANTENNA HEIGHT (m)	TABLE ANGLE (Degree)	RAW VALUE (dBuV)	CORRECTION FACTOR (dB/m)
1	2390.00	61.5 PK	74.0	-12.5	1.04 V	197	30.00	31.50
2	2390.00	50.9 AV	54.0	-3.1	1.04 V	197	19.40	31.50
3	*2422.00	105.9 PK			1.04 V	197	74.30	31.60
4	*2422.00	95.1 AV			1.04 V	197	63.50	31.60
5	4844.00	45.4 PK	74.0	-28.6	1.02 V	208	7.70	37.70
6	4844.00	34.6 AV	54.0	-19.4	1.02 V	208	-3.10	37.70

- REMARKS:**
1. Emission level (dBuV/m) = Raw Value (dBuV) + Correction Factor (dB/m).
  2. Correction Factor (dB/m) = Antenna Factor (dB/m) + Cable Factor (dB).
  3. The other emission levels were very low against the limit.
  4. Margin value = Emission level – Limit value.
  5. “ \* “: Fundamental frequency.



A D T

EUT TEST CONDITION		MEASUREMENT DETAIL	
CHANNEL	Channel 4	FREQUENCY RANGE	1 ~ 25GHz
INPUT POWER (SYSTEM)	120Vac, 60 Hz	DETECTOR FUNCTION	Peak (PK) Average (AV)
ENVIRONMENTAL CONDITIONS	25deg. C, 65%RH	TESTED BY	Sun Lin

ANTENNA POLARITY & TEST DISTANCE: HORIZONTAL AT 3 M								
NO.	FREQ. (MHz)	EMISSION LEVEL (dBuV/m)	LIMIT (dBuV/m)	MARGIN (dB)	ANTENNA HEIGHT (m)	TABLE ANGLE (Degree)	RAW VALUE (dBuV)	CORRECTION FACTOR (dB/m)
1	2390.00	49.7 PK	74.0	-24.3	1.22 H	0	18.20	31.50
2	2390.00	37.6 AV	54.0	-16.4	1.22 H	0	6.10	31.50
3	*2437.00	101.2 PK			1.22 H	0	69.50	31.70
4	*2437.00	89.5 AV			1.22 H	0	57.80	31.70
5	4874.00	48.4 PK	74.0	-25.6	1.00 H	37	10.60	37.80
6	4874.00	37.2 AV	54.0	-16.8	1.00 H	37	-0.60	37.80
ANTENNA POLARITY & TEST DISTANCE: VERTICAL AT 3 M								
NO.	FREQ. (MHz)	EMISSION LEVEL (dBuV/m)	LIMIT (dBuV/m)	MARGIN (dB)	ANTENNA HEIGHT (m)	TABLE ANGLE (Degree)	RAW VALUE (dBuV)	CORRECTION FACTOR (dB/m)
1	2390.00	62.7 PK	74.0	-11.3	1.00 V	176	31.20	31.50
2	2390.00	50.0 AV	54.0	-4.0	1.00 V	176	18.50	31.50
3	*2437.00	105.6 PK			1.00 V	176	73.90	31.70
4	*2437.00	94.7 AV			1.00 V	176	63.00	31.70
5	4874.00	46.8 PK	74.0	-27.2	1.08 V	22	9.00	37.80
6	4874.00	34.9 AV	54.0	-19.1	1.08 V	22	-2.90	37.80

- REMARKS:**
1. Emission level (dBuV/m) = Raw Value (dBuV) + Correction Factor (dB/m).
  2. Correction Factor (dB/m) = Antenna Factor (dB/m) + Cable Factor (dB).
  3. The other emission levels were very low against the limit.
  4. Margin value = Emission level – Limit value.
  5. “ \* “: Fundamental frequency.



A D T

EUT TEST CONDITION		MEASUREMENT DETAIL	
CHANNEL	Channel 7	FREQUENCY RANGE	1 ~ 25GHz
INPUT POWER (SYSTEM)	120Vac, 60 Hz	DETECTOR FUNCTION	Peak (PK) Average (AV)
ENVIRONMENTAL CONDITIONS	25deg. C, 65%RH	TESTED BY	Sun Lin

ANTENNA POLARITY & TEST DISTANCE: HORIZONTAL AT 3 M								
NO.	FREQ. (MHz)	EMISSION LEVEL (dBuV/m)	LIMIT (dBuV/m)	MARGIN (dB)	ANTENNA HEIGHT (m)	TABLE ANGLE (Degree)	RAW VALUE (dBuV)	CORRECTION FACTOR (dB/m)
1	*2452.00	100.9 PK			1.20 H	0	69.10	31.80
2	*2452.00	89.1 AV			1.20 H	0	57.30	31.80
3	2483.50	56.4 PK	74.0	-17.6	1.20 H	0	24.50	31.90
4	2483.50	43.2 AV	54.0	-10.8	1.20 H	0	11.30	31.90
5	4904.00	48.7 PK	74.0	-25.3	1.00 H	37	10.90	37.80
6	4904.00	38.5 AV	54.0	-15.5	1.00 H	37	0.70	37.80
ANTENNA POLARITY & TEST DISTANCE: VERTICAL AT 3 M								
NO.	FREQ. (MHz)	EMISSION LEVEL (dBuV/m)	LIMIT (dBuV/m)	MARGIN (dB)	ANTENNA HEIGHT (m)	TABLE ANGLE (Degree)	RAW VALUE (dBuV)	CORRECTION FACTOR (dB/m)
1	*2452.00	104.9 PK			1.26 V	189	73.10	31.80
2	*2452.00	94.0 AV			1.26 V	189	62.20	31.80
3	2483.50	65.5 PK	74.0	-8.5	1.02 V	177	33.60	31.90
4	2483.50	52.5 AV	54.0	-1.5	1.02 V	177	20.60	31.90
5	4904.00	45.7 PK	74.0	-28.3	1.32 V	228	7.90	37.80
6	4904.00	34.5 AV	54.0	-19.5	1.32 V	228	-3.30	37.80

- REMARKS:**
1. Emission level (dBuV/m) = Raw Value (dBuV) + Correction Factor (dB/m).
  2. Correction Factor (dB/m) = Antenna Factor (dB/m) + Cable Factor (dB).
  3. The other emission levels were very low against the limit.
  4. Margin value = Emission level – Limit value.
  5. “ \* “: Fundamental frequency.





A D T

**BELOW 1GHz WORST-CASE DATA : 802.11g**

EUT TEST CONDITION		MEASUREMENT DETAIL	
CHANNEL	Channel 6	FREQUENCY RANGE	Below 1000MHz
INPUT POWER (SYSTEM)	120Vac, 60 Hz	DETECTOR FUNCTION	Quasi-Peak
ENVIRONMENTAL CONDITIONS	25deg. C, 68%RH	TESTED BY	Sun Lin

ANTENNA POLARITY & TEST DISTANCE: HORIZONTAL AT 3 M								
NO.	FREQ. (MHz)	EMISSION LEVEL (dBuV/m)	LIMIT (dBuV/m)	MARGIN (dB)	ANTENNA HEIGHT (m)	TABLE ANGLE (Degree)	RAW VALUE (dBuV)	CORRECTION FACTOR (dB/m)
1	125.17	30.0 QP	43.5	-13.5	2.00 H	103	18.00	12.00
2	288.67	42.4 QP	46.0	-3.6	1.00 H	79	28.20	14.20
3	362.37	37.2 QP	46.0	-8.8	1.50 H	49	21.10	16.10
4	500.42	38.3 QP	46.0	-7.7	2.00 H	4	18.60	19.70
5	599.58	38.3 QP	46.0	-7.7	1.25 H	349	16.20	22.10
6	659.85	33.3 QP	46.0	-12.7	1.00 H	1	10.50	22.80
ANTENNA POLARITY & TEST DISTANCE: VERTICAL AT 3 M								
NO.	FREQ. (MHz)	EMISSION LEVEL (dBuV/m)	LIMIT (dBuV/m)	MARGIN (dB)	ANTENNA HEIGHT (m)	TABLE ANGLE (Degree)	RAW VALUE (dBuV)	CORRECTION FACTOR (dB/m)
1	59.06	35.6 QP	40.0	-4.4	1.00 V	49	22.60	13.00
2	76.56	34.3 QP	40.0	-5.7	1.00 V	319	24.30	10.00
3	284.60	42.9 QP	46.0	-3.1	1.00 V	10	28.90	14.00
4	420.70	36.0 QP	46.0	-10.0	1.00 V	103	18.50	17.50
5	479.03	34.7 QP	46.0	-11.3	1.00 V	181	15.60	19.10
6	599.58	36.9 QP	46.0	-9.1	1.00 V	154	14.80	22.10

- REMARKS:**
1. Emission level (dBuV/m) = Raw Value (dBuV) + Correction Factor (dB/m).
  2. Correction Factor (dB/m) = Antenna Factor (dB/m) + Cable Factor (dB).
  3. The other emission levels were very low against the limit.
  4. Margin value = Emission level – Limit value.



A D T

## 4.2 CONDUCTED EMISSION MEASUREMENT

### 4.2.1 LIMITS OF CONDUCTED EMISSION MEASUREMENT

FREQUENCY OF EMISSION (MHz)	CONDUCTED LIMIT (dB $\mu$ V)	
	Quasi-peak	Average
0.15 ~ 0.5	66 to 56	56 to 46
0.5 ~ 5	56	46
5 ~ 30	60	50

- NOTE:** 1. The lower limit shall apply at the transition frequencies.  
2. The limit decreases in line with the logarithm of the frequency in the range of 0.15 to 0.50MHz.  
3. All emanations from a class A/B digital device or system, including any network of conductors and apparatus connected thereto, shall not exceed the level of field strengths specified above.

### 4.2.2 TEST INSTRUMENTS

DESCRIPTION & MANUFACTURER	MODEL NO.	SERIAL NO.	DATE OF CALIBRATION	DUE DATE OF CALIBRATION
Test Receiver ROHDE & SCHWARZ	ESCS30	100291	Nov. 23, 2011	Nov. 22, 2012
RF signal cable Woken	5D-FB	Cable-HYC01-01	Dec. 30, 2010	Dec. 29, 2011
LISN ROHDE & SCHWARZ	ESH3-Z5	100312	Jul. 07, 2011	Jul. 06, 2012
LISN ROHDE & SCHWARZ	ESH2-Z5	100100	Jan. 06, 2011	Jan. 05, 2012
LISN ROHDE & SCHWARZ	ESH3-Z5	835239/001	Feb. 22, 2011	Feb. 21, 2012
V-LISN SCHWARZBECK	NNBL 8226-2	8226-142	Jun. 30, 2011	Jun. 29, 2012
LISN ROHDE & SCHWARZ	ENV216	100072	Jun. 10, 2011	Jun. 09, 2012
Software ADT	ADT_Cond_ V7.3.7	NA	NA	NA

- NOTE:** 1. The calibration interval of the above test instruments is 12 months and the calibrations are traceable to NML/ROC and NIST/USA.  
2. The test was performed in HwaYa Shielded Room 1.  
3. The VCCI Site Registration No. is C-2040.



A D T

#### 4.2.3 TEST PROCEDURES

- a. The EUT was placed 0.4 meters from the conducting wall of the shielded room with EUT being connected to the power mains through a line impedance stabilization network (LISN). Other support units were connected to the power mains through another LISN. The two LISNs provide 50 ohm/ 50uH of coupling impedance for the measuring instrument.
- b. Both lines of the power mains connected to the EUT were checked for maximum conducted interference.
- c. The frequency range from 150kHz to 30MHz was searched. Emission levels under (Limit - 20dB) was not recorded.

**NOTE:** All modes of operation were investigated and the worst-case emissions are reported.

#### 4.2.4 DEVIATION FROM TEST STANDARD

No deviation.

#### 4.2.5 TEST SETUP

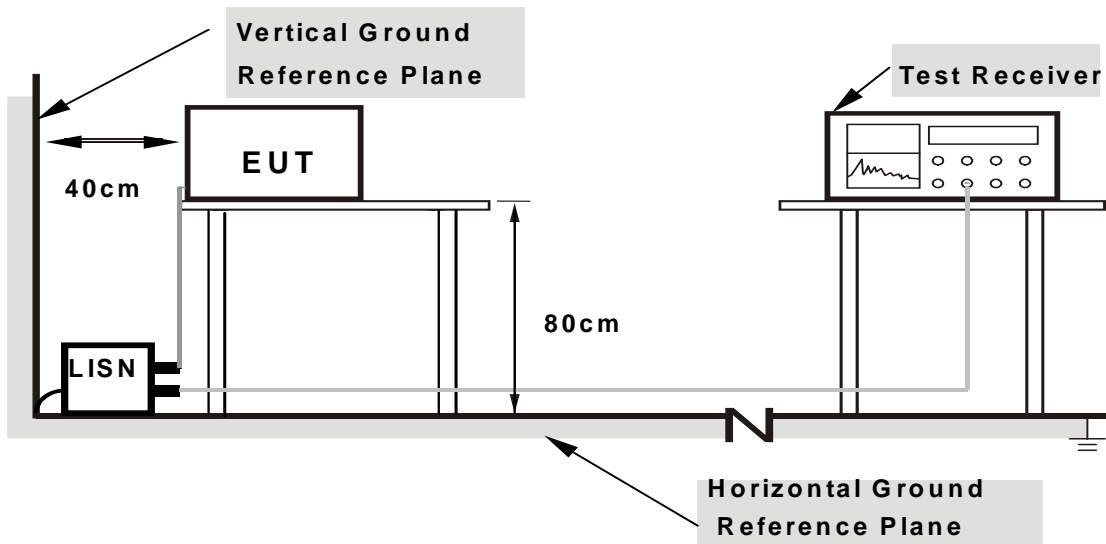

- Note:**
1. Support units were connected to second LISN.
  2. Both of LISNs (AMN) are 80 cm from EUT and at least 80 from other units and other metal planes

For the actual test configuration, please refer to the attached file (Test Setup Photo).

#### 4.2.6 EUT OPERATING CONDITIONS

Same as 4.1.6.

### 4.2.7 TEST RESULTS

**CONDUCTED WORST-CASE DATA : 802.11g**

PHASE	Line 1	6dB BANDWIDTH	9kHz
-------	--------	---------------	------

No	Freq. [MHz]	Corr. Factor (dB)	Reading Value		Emission Level		Limit		Margin	
			[dB (uV)]		[dB (uV)]		[dB (uV)]		(dB)	
			Q.P.	AV.	Q.P.	AV.	Q.P.	AV.	Q.P.	AV.
1	0.162	0.12	47.81	38.95	47.93	39.07	65.38	55.38	-17.45	-16.31
2	0.170	0.12	48.59	37.90	48.71	38.02	64.98	54.98	-16.28	-16.97
3	0.529	0.13	42.52	27.07	42.65	27.20	56.00	46.00	-13.35	-18.80
4	0.822	0.15	33.89	16.62	34.04	16.77	56.00	46.00	-21.96	-29.23
5	6.461	0.45	20.59	9.83	21.04	10.28	60.00	50.00	-38.96	-39.72
6	7.980	0.54	22.21	10.51	22.75	11.05	60.00	50.00	-37.25	-38.95

- REMARKS:**
1. Q.P. and AV. are abbreviations of quasi-peak and average individually.
  2. "-": The Quasi-peak reading value also meets average limit and measurement with the average detector is unnecessary.
  3. The emission levels of other frequencies were very low against the limit.
  4. Margin value = Emission level - Limit value
  5. Correction factor = Insertion loss + Cable loss
  6. Emission Level = Correction Factor + Reading Value.

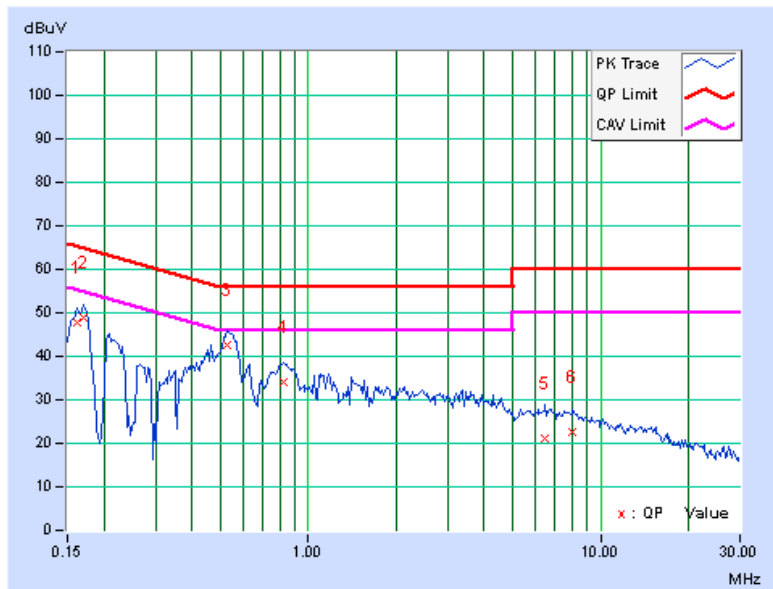

PHASE	Line 2	6dB BANDWIDTH	9kHz
-------	--------	---------------	------

No	Freq. [MHz]	Corr. Factor (dB)	Reading Value		Emission Level		Limit		Margin	
			[dB (uV)]		[dB (uV)]		[dB (uV)]		(dB)	
			Q.P.	AV.	Q.P.	AV.	Q.P.	AV.	Q.P.	AV.
1	0.162	0.13	51.96	35.35	52.09	35.48	65.38	55.38	-13.29	-19.90
2	0.172	0.13	51.56	30.87	51.69	31.00	64.86	54.86	-13.17	-23.86
3	0.552	0.15	36.59	21.52	36.74	21.67	56.00	46.00	-19.26	-24.33
4	0.838	0.17	28.43	15.38	28.60	15.55	56.00	46.00	-27.40	-30.45
5	6.551	0.44	17.97	8.68	18.41	9.12	60.00	50.00	-41.59	-40.88
6	14.445	0.73	16.47	6.06	17.20	6.79	60.00	50.00	-42.80	-43.21

- REMARKS:**
1. Q.P. and AV. are abbreviations of quasi-peak and average individually.
  2. "-": The Quasi-peak reading value also meets average limit and measurement with the average detector is unnecessary.
  3. The emission levels of other frequencies were very low against the limit.
  4. Margin value = Emission level - Limit value
  5. Correction factor = Insertion loss + Cable loss
  6. Emission Level = Correction Factor + Reading Value.

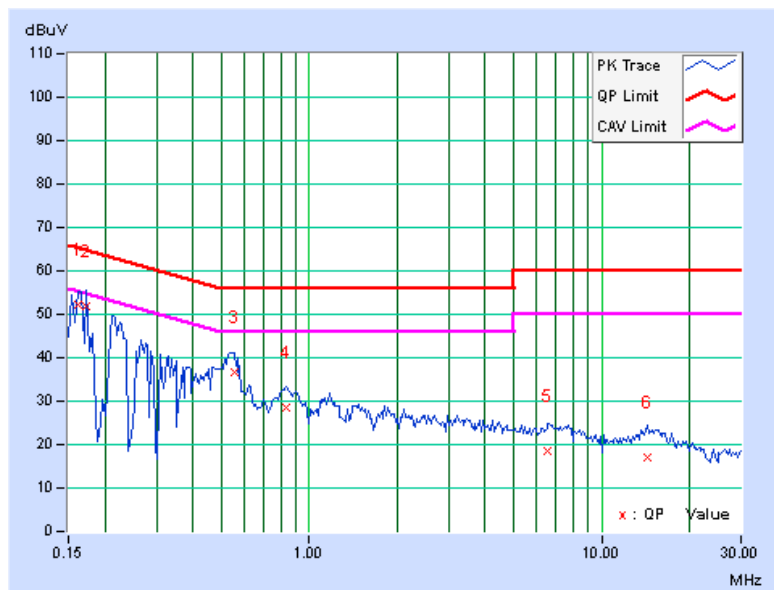

## 4.3 6dB BANDWIDTH MEASUREMENT

### 4.3.1 LIMITS OF 6dB BANDWIDTH MEASUREMENT

The minimum of 6dB Bandwidth Measurement is 0.5 MHz.

### 4.3.2 TEST SETUP

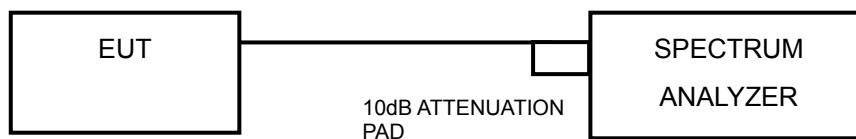

### 4.3.3 TEST INSTRUMENTS

Refer to section 4.1.2 to get information of above instrument.

### 4.3.4 TEST PROCEDURE

1. Set resolution bandwidth (RBW) = approximately 1% of the emission bandwidth
2. Set the video bandwidth (VBW)  $\geq 3 \times$  RBW, Detector = Peak.
3. Trace mode = max hold.
4. Sweep = auto couple.
5. Measure the maximum width of the emission that is constrained by the frequencies associated with the two amplitude points (upper and lower) that are attenuated by 6 dB relative to the maximum level measured in the fundamental emission.

### 4.3.5 DEVIATION FROM TEST STANDARD

No deviation.

### 4.3.6 EUT OPERATING CONDITIONS

The software provided by client to enable the EUT under transmission condition continuously at lowest, middle and highest channel frequencies individually.



### 4.3.7 TEST RESULTS

#### 802.11b

CHANNEL	FREQUENCY (MHz)	6dB BANDWIDTH (MHz)	MINIMUM LIMIT (MHz)	PASS / FAIL
1	2412	10.23	0.5	PASS
6	2437	10.22	0.5	PASS
11	2462	10.23	0.5	PASS

#### 802.11g

CHANNEL	FREQUENCY (MHz)	6dB BANDWIDTH (MHz)	MINIMUM LIMIT (MHz)	PASS / FAIL
1	2412	16.53	0.5	PASS
6	2437	16.52	0.5	PASS
11	2462	16.53	0.5	PASS

#### 802.11n (20MHz)

CHANNEL	FREQUENCY (MHz)	6dB BANDWIDTH (MHz)		MINIMUM LIMIT (MHz)	PASS / FAIL
		CHAIN 0	CHAIN 1		
1	2412	17.73	17.76	0.5	PASS
6	2437	17.73	17.76	0.5	PASS
11	2462	17.72	17.75	0.5	PASS

#### 802.11n (40MHz)

CHANNEL	FREQUENCY (MHz)	6dB BANDWIDTH (MHz)		MINIMUM LIMIT (MHz)	PASS / FAIL
		CHAIN 0	CHAIN 1		
1	2422	36.24	36.20	0.5	PASS
4	2437	36.33	36.14	0.5	PASS
7	2452	36.35	36.18	0.5	PASS



## 4.4 CONDUCTED OUTPUT POWER

### 4.4.1 LIMITS OF CONDUCTED OUTPUT POWER MEASUREMENT

For systems using digital modulation in the 2400–2483.5 MHz: 1 Watt (30dBm)

### 4.4.2 TEST SETUP

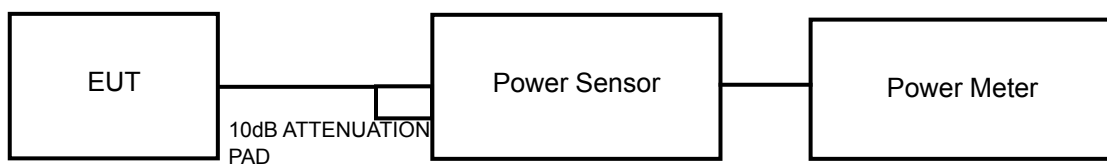

### 4.4.3 TEST INSTRUMENTS

Refer to section 4.1.2 to get information of above instrument.

### 4.4.4 TEST PROCEDURES

A power sensor was used on the output port of the EUT. A power meter was used to read the response of the power sensor. Record the power level.

### 4.4.5 DEVIATION FROM TEST STANDARD

No deviation.

### 4.4.6 EUT OPERATING CONDITIONS

Same as Item 4.3.6.



#### 4.4.7 TEST RESULTS

##### 802.11b

CHANNEL	FREQUENCY (MHz)	PEAK POWER (mW)	PEAK POWER (dBm)	LIMIT (dBm)	PASS/FAIL
1	2412	83.2	19.2	30	PASS
6	2437	69.2	18.4	30	PASS
11	2462	75.9	18.8	30	PASS

##### 802.11g

CHANNEL	FREQUENCY (MHz)	PEAK POWER (mW)	PEAK POWER (dBm)	LIMIT (dBm)	PASS/FAIL
1	2412	251.2	24.0	30	PASS
6	2437	229.1	23.6	30	PASS
11	2462	257.0	24.1	30	PASS

##### 802.11n (20MHz)

CHAN.	FREQUENCY (MHz)	PEAK POWER (dBm)		TOTAL POWER (mW)	TOTAL POWER (dBm)	LIMIT (dBm)	PASS / FAIL
		CHAIN 0	CHAIN 1				
1	2412	22.2	22.5	343.8	25.4	30	PASS
6	2437	22.8	22.1	<b>352.7</b>	25.5	30	PASS
11	2462	22.1	22.6	344.2	25.4	30	PASS

##### 802.11n (40MHz)

CHAN.	FREQUENCY (MHz)	PEAK POWER (dBm)		TOTAL POWER (mW)	TOTAL POWER (dBm)	LIMIT (dBm)	PASS / FAIL
		CHAIN 0	CHAIN 1				
1	2422	22.0	22.7	344.7	25.4	30	PASS
4	2437	22.8	22.1	352.7	25.5	30	PASS
7	2452	21.1	21.8	280.2	24.5	30	PASS

## 4.5 POWER SPECTRAL DENSITY MEASUREMENT

### 4.5.1 LIMITS OF POWER SPECTRAL DENSITY MEASUREMENT

The Maximum of Power Spectral Density Measurement is 8dBm.

### 4.5.2 TEST SETUP

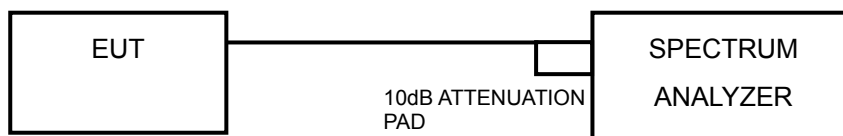

### 4.5.3 TEST INSTRUMENTS

Refer to section 4.1.2 to get information of above instrument.

### 4.5.4 TEST PROCEDURE

1. Set the RBW = 100 kHz, VBW = 300 kHz, Detector = peak.
2. Sweep time = auto couple, Trace mode = max hold, allow trace to fully stabilize.
3. Use the peak marker function to determine the maximum power level in any 100 kHz band segment within the fundamental EBW.
4. Scale the observed power level to an equivalent value in 3 kHz by adjusting (reducing) the measured power by a bandwidth correction factor (BWCF) where  $BWCF = 10\log(3 \text{ kHz}/100\text{kHz})$

### 4.5.5 DEVIATION FROM TEST STANDARD

No deviation.

### 4.5.6 EUT OPERATING CONDITION

Same as Item 4.3.6



#### 4.5.7 TEST RESULTS

##### 802.11b

Channel	FREQ. (MHz)	PSD (dBm/100kHz)	PSD (dBm/3kHz)	Limit (dBm/3kHz)	PASS /FAIL
1	2412	7.24	-7.99	8	PASS
6	2437	6.56	-8.67	8	PASS
11	2462	6.79	-8.44	8	PASS

##### 802.11g

Channel	FREQ. (MHz)	PSD (dBm/100kHz)	PSD (dBm/3kHz)	Limit (dBm/3kHz)	PASS /FAIL
1	2412	0.53	-14.7	8	PASS
6	2437	0.33	-14.9	8	PASS
11	2462	0.63	-14.6	8	PASS

##### 802.11n (20MHz)

TX chain	Channel	FREQ. (MHz)	PSD (dBm/100kHz)	PSD (dBm/3kHz)	10 log (N=2) dB	Total PSD (dBm/3kHz)	Limit (dBm/3kHz)	PASS /FAIL
0	1	2412	-1.32	-16.55	3.01	-13.54	8	PASS
	6	2437	-0.83	-16.06	3.01	-13.05	8	PASS
	11	2462	-1.18	-16.41	3.01	-13.40	8	PASS
1	1	2412	-0.22	-15.45	3.01	-12.44	8	PASS
	6	2437	-0.60	-15.83	3.01	-12.82	8	PASS
	11	2462	-0.21	-15.44	3.01	-12.43	8	PASS

##### 802.11n (40MHz)

TX chain	Channel	FREQ. (MHz)	PSD (dBm/100kHz)	PSD (dBm/3kHz)	10 log (N=2) dB	Total PSD (dBm/3kHz)	Limit (dBm/3kHz)	PASS /FAIL
0	1	2422	-4.10	-19.33	3.01	-16.32	8	PASS
	4	2437	-3.40	-18.63	3.01	-15.62	8	PASS
	7	2452	-4.84	-20.07	3.01	-17.06	8	PASS
1	1	2422	-3.10	-18.33	3.01	-15.32	8	PASS
	4	2437	-3.66	-18.89	3.01	-15.88	8	PASS
	7	2452	-3.96	-19.19	3.01	-16.18	8	PASS

## 4.6 CONDUCTED EMISSION MEASUREMENT

### 4.6.1 LIMITS OF BAND EDGES MEASUREMENT

Below  $-20\text{dB}$  of the highest emission level of operating band (in 100kHz Resolution Bandwidth).

### 4.6.2 TEST SETUP

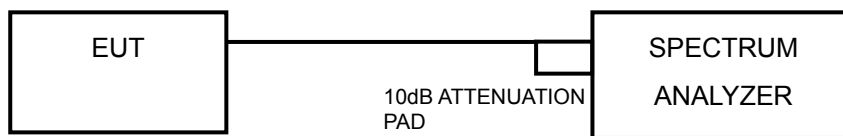

### 4.6.3 TEST INSTRUMENTS

Refer to section 4.1.2 to get information of above instrument.

### 4.6.4 TEST PROCEDURE

#### MEASUREMENT PROCEDURE REF

1. Set the RBW = 100 kHz.
2. Set the VBW  $\geq$  300 kHz.
3. Detector = peak.
4. Sweep time = auto couple.
5. Trace mode = max hold.
6. Allow trace to fully stabilize.
7. Use the peak marker function to determine the maximum power level in any 100 kHz band segment within the fundamental EBW.



A D T

## MEASUREMENT PROCEDURE OOBE

1. Set RBW = 100 kHz.
2. Set VBW  $\geq$  300 kHz.
3. Set span to encompass the spectrum to be examined
4. Detector = peak.
5. Trace Mode = max hold.
6. Sweep = auto couple.

### 4.6.5 DEVIATION FROM TEST STANDARD

No deviation.

### 4.6.6 EUT OPERATING CONDITION

Same as Item 4.3.6

### 4.6.7 TEST RESULTS

The conducted emission test is performed on each TX port of operating mode without summing or adding  $10\log(N)$  since the limit is relative emission limit. Only worst data of each operating mode is presented.

The spectrum plots are attached on the following pages. D1 line indicates the highest level, and D2 line indicates the 20dB offset below D1. It shows compliance with the requirement in part 15.247(d).

### 4.6.8 TEST RESULTS

#### 802.11b

##### CH 1

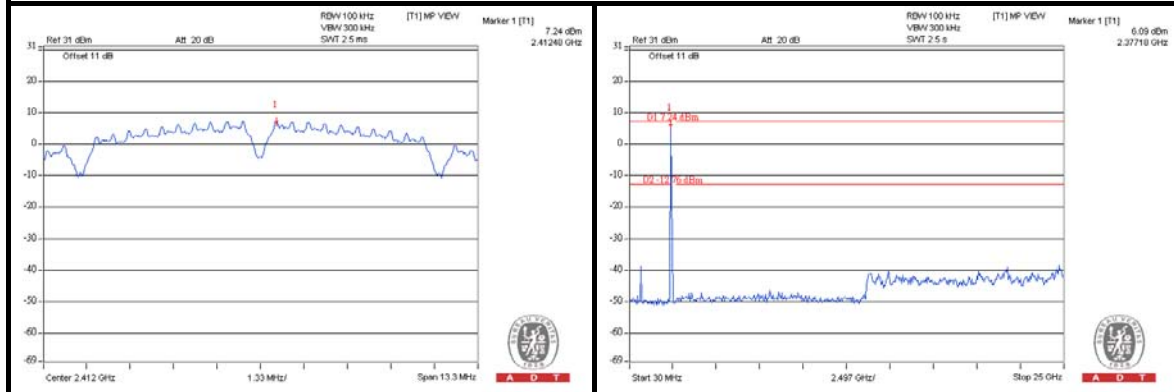

##### CH 6

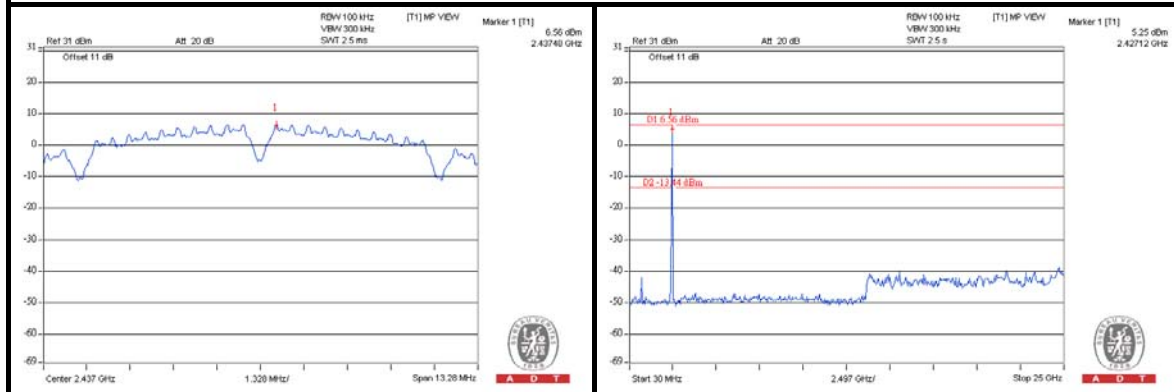

##### CH 11

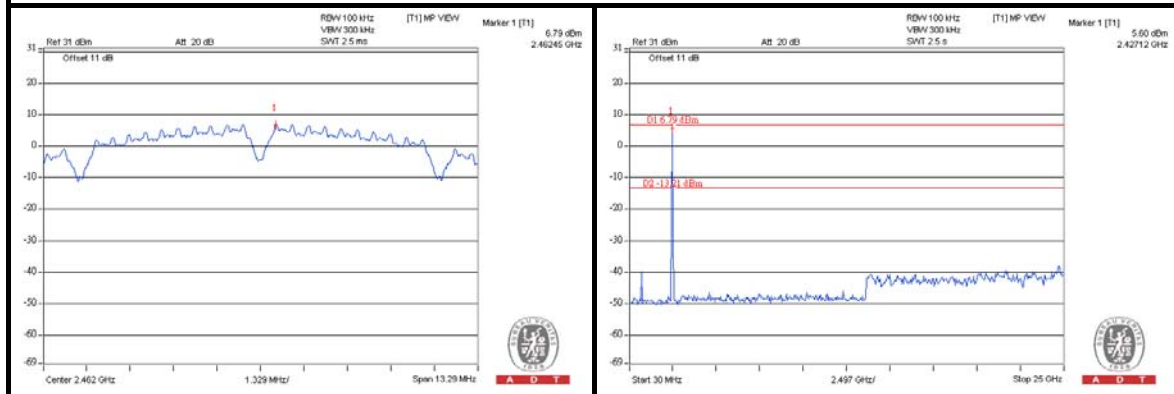



A D T

### 802.11g

#### CH 1

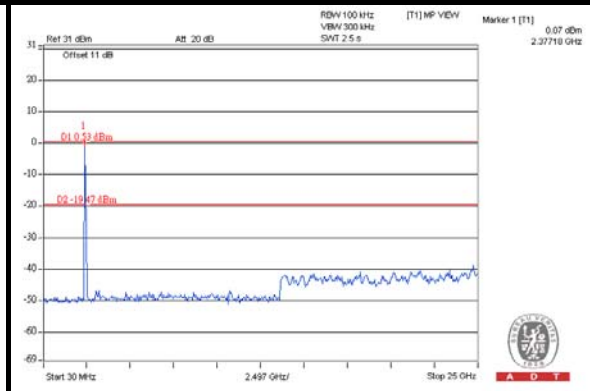
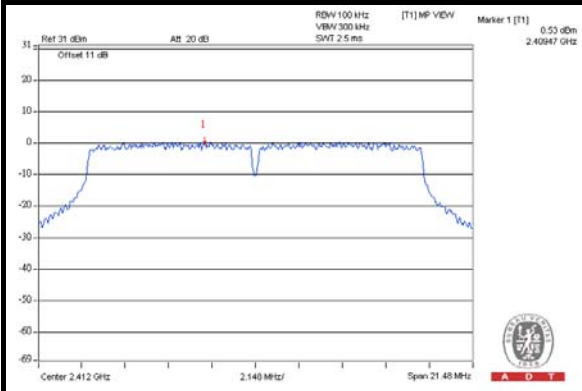

#### CH 6

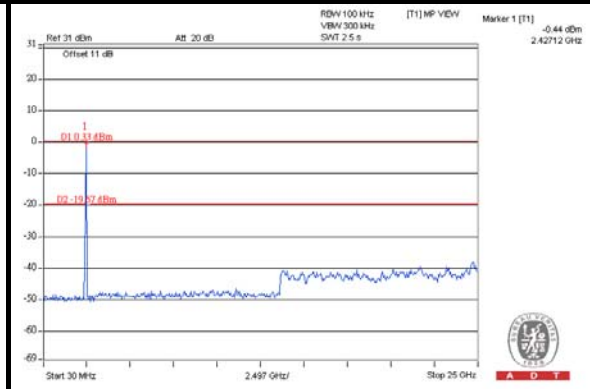
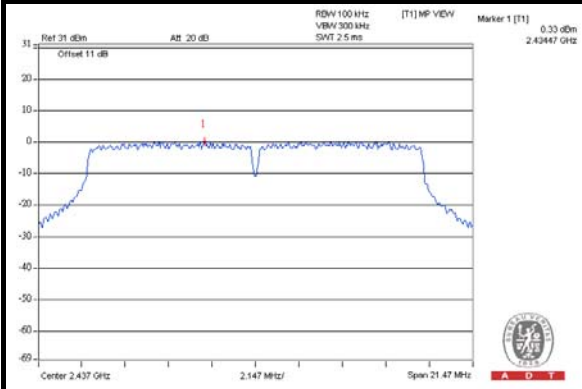

#### CH 11

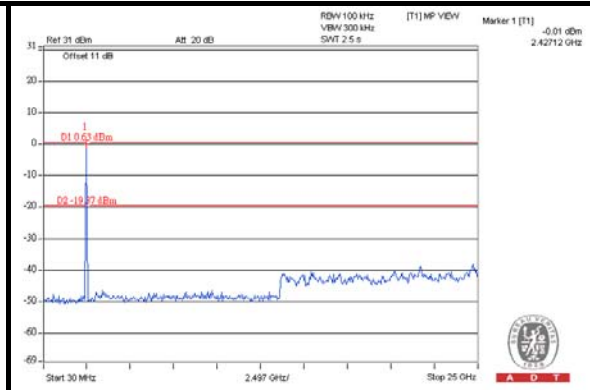
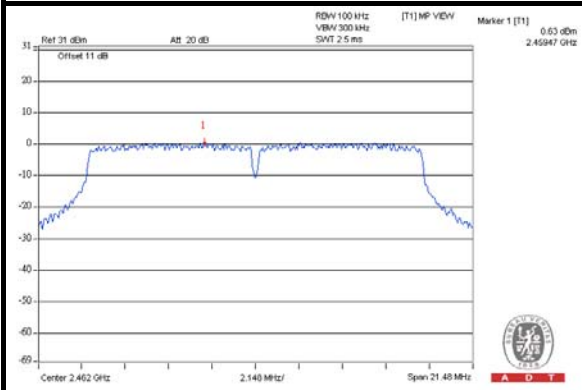



### 802.11n (20MHz)

#### CH 1

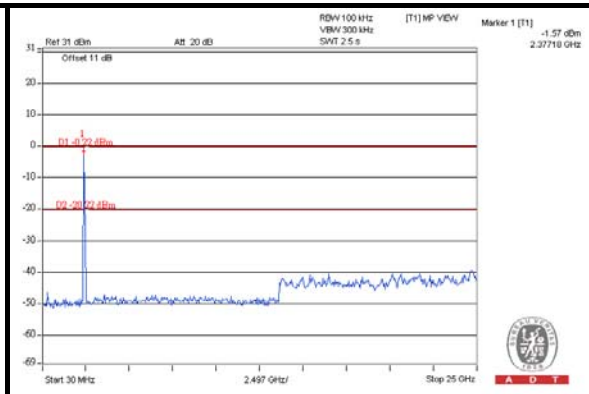
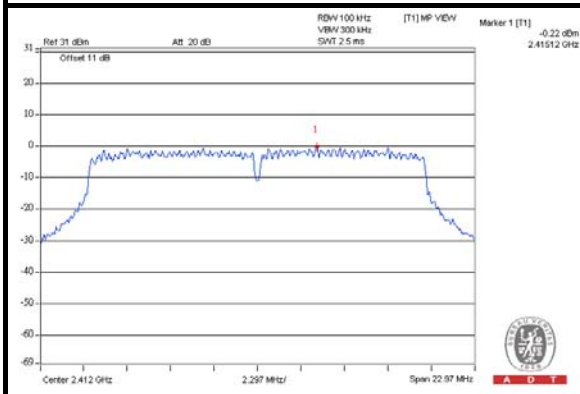

#### CH 6

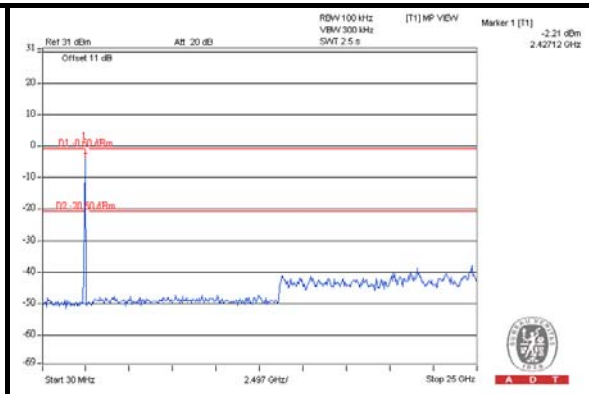
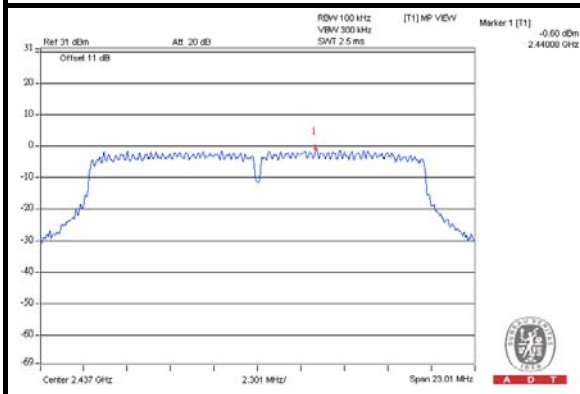

#### CH 11

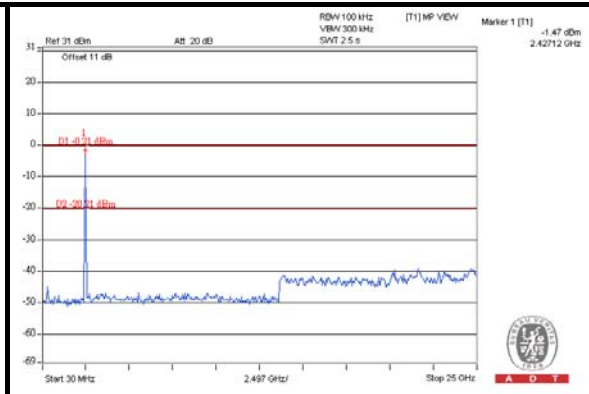
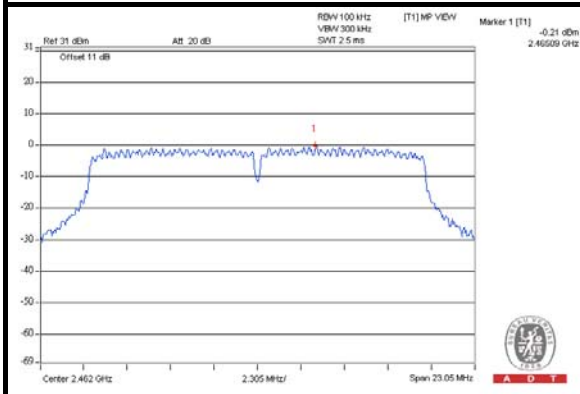

### 802.11n (40MHz)

#### CH 1

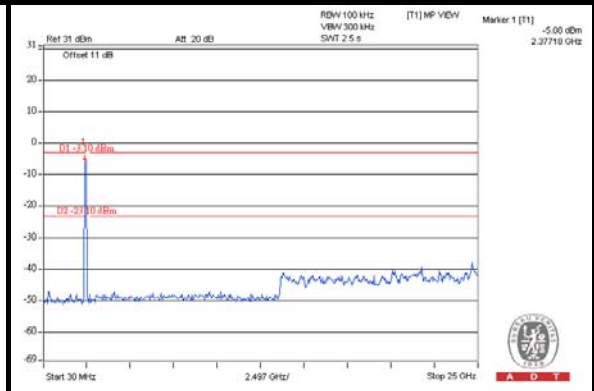
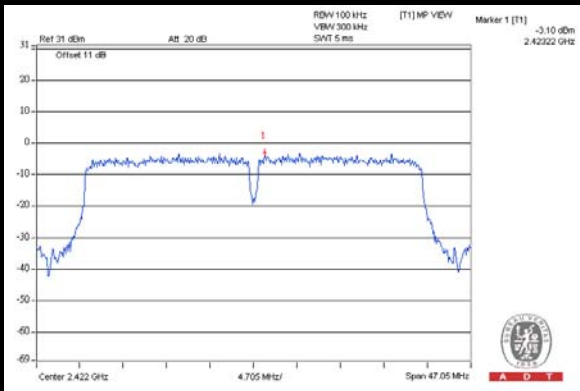

#### CH 4

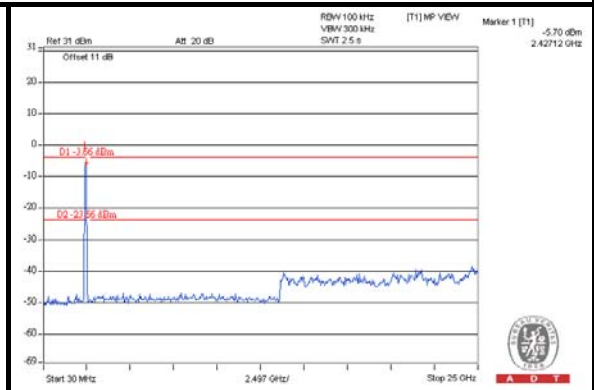
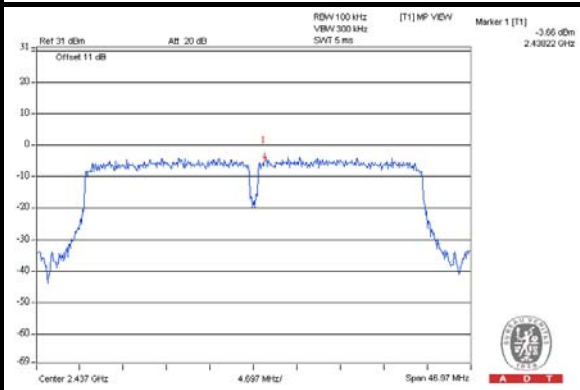

#### CH 7

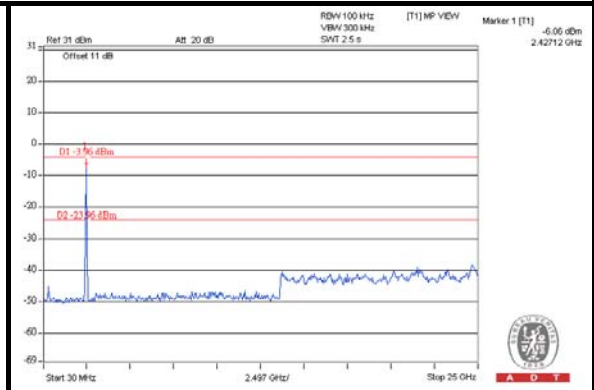
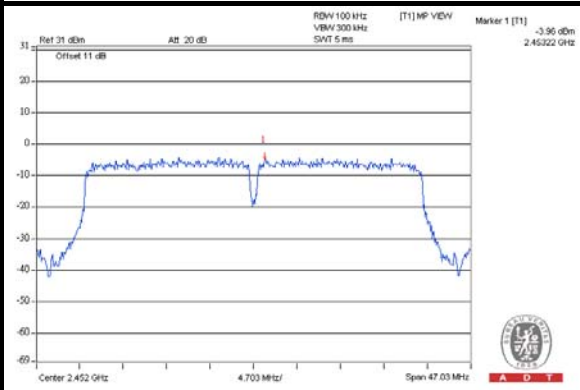



## 5. TEST TYPES AND RESULTS (FOR 5.0GHz BAND)

### 5.1 RADIATED EMISSION AND BANDEDGE MEASUREMENT

#### 5.1.1 LIMITS OF RADIATED EMISSION AND BANDEDGE MEASUREMENT

Radiated emissions which fall in the restricted bands, as defined in Section 15.205(a), must also comply with the radiated emission limits specified in Section 15.209(a). Other emissions shall be at least 20dB below the highest level of the desired power.

FREQUENCIES (MHz)	FIELD STRENGTH (microvolts/meter)	MEASUREMENT DISTANCE (meters)
0.009 ~ 0.490	2400/F(kHz)	300
0.490 ~ 1.705	24000/F(kHz)	30
1.705 ~ 30.0	30	30
30 ~ 88	100	3
88 ~ 216	150	3
216 ~ 960	200	3
Above 960	500	3

**NOTE:**

1. The lower limit shall apply at the transition frequencies.
2. Emission level (dBuV/m) = 20 log Emission level (uV/m).
3. As shown in 15.35(b), for frequencies above 1000MHz, the field strength limits are based on average detector, however, the peak field strength of any emission shall not exceed the maximum permitted average limits, specified above by more than 20dB under any condition of modulation.



A D T

### 5.1.2 TEST INSTRUMENTS

DESCRIPTION & MANUFACTURER	MODEL NO.	SERIAL NO.	DATE OF CALIBRATION	DUE DATE OF CALIBRATION
Test Receiver ROHDE & SCHWARZ	ESCI	100744	Apr. 19, 2011	Apr. 18, 2012
Spectrum Analyzer ROHDE & SCHWARZ	FSP40	100269	Jan. 06, 2011	Jan. 05, 2012
BILOG Antenna SCHWARZBECK	VULB9168	9168-156	Apr. 12, 2011	Apr. 11, 2012
HORN Antenna SCHWARZBECK	BBHA 9120 D	9120D-563	Sep. 06, 2011	Sep. 05, 2012
HORN Antenna SCHWARZBECK	BBHA 9170	BBHA9170243	Dec. 27, 2010	Dec. 26, 2011
Preamplifier Agilent	8449B	3008A01911	Oct. 29, 2011	Oct. 28, 2012
Preamplifier Agilent	8447D	2944A10638	Oct. 29, 2011	Oct. 28, 2012
RF signal cable HUBER+SUHNER	SUCOFLEX 104	295013/4 283403/4	Aug. 19, 2011	Aug. 18, 2012
RF signal cable Worken	8D-FB	Cable-HYCH9-01	Aug. 13, 2011	Aug. 12, 2012
Software	ADT_Radiated_ V7.6.15.9.2	NA	NA	NA
Antenna Tower EMCO	2070/2080	512.835.4684	NA	NA
Turn Table EMCO	2087-2.03	NA	NA	NA
Antenna Tower & Turn Table Controller EMCO	2090	NA	NA	NA
26GHz ~ 40GHz Amplifier	EM26400	815221	Oct. 29, 2011	Oct. 28, 2012
High Speed Peak Power Meter	ML2495A	0824011	Aug. 04, 2011	Aug. 03, 2012
Power Sensor	MA2411B	0738171	Aug. 04, 2011	Aug. 03, 2012

- NOTE:**
1. The calibration interval of the above test instruments is 12 months and the calibrations are traceable to NML/ROC and NIST/USA.
  2. The test was performed in HwaYa Chamber 9.
  3. The horn antenna and HP preamplifier (model: 8449B) are used only for the measurement of emission frequency above 1GHz if tested.
  4. The FCC Site Registration No. is 460141.
  5. The IC Site Registration No. is IC 7450F-4.



A D T

### 5.1.3 TEST PROCEDURES

- a. The EUT was placed on the top of a rotating table 0.8 meters above the ground at a 3 meters semi-anechoic chamber. The table was rotated 360 degrees to determine the position of the highest radiation.
- b. The EUT was set 3 meters away from the interference-receiving antenna, which was mounted on the top of a variable-height antenna tower.
- c. The antenna is a broadband antenna, and its height is varied from one meter to four meters above the ground to determine the maximum value of the field strength. Both horizontal and vertical polarizations of the antenna are set to make the measurement.
- d. For each suspected emission, the EUT was arranged to its worst case and then the antenna was tuned to heights from 1 meter to 4 meters and the rotatable table was turned from 0 degrees to 360 degrees to find the maximum reading.
- e. The test-receiver system was set to Peak Detect Function and Specified Bandwidth with Maximum Hold Mode.
- f. If the emission level of the EUT in peak mode was lower than the limit specified, then testing could be stopped and the peak values of the EUT would be reported. Otherwise the emissions would be re-tested one by one using peak, quasi-peak or average method as specified and then reported in a data sheet.

**NOTE:**

1. The resolution bandwidth and video bandwidth of test receiver/spectrum analyzer is 120kHz for Quasi-peak detection at frequency below 1GHz.
2. The resolution bandwidth of test receiver/spectrum analyzer is 100kHz and video bandwidth is 300kHz for Peak detection at frequency above 1GHz.
3. The resolution bandwidth of test receiver/spectrum analyzer is 1MHz and the video bandwidth is 1kHz for Average detection (AV) at frequency above 1GHz.
4. All modes of operation were investigated and the worst-case emissions are reported.

### 5.1.4 DEVIATION FROM TEST STANDARD

No deviation.

### 5.1.5 TEST SETUP

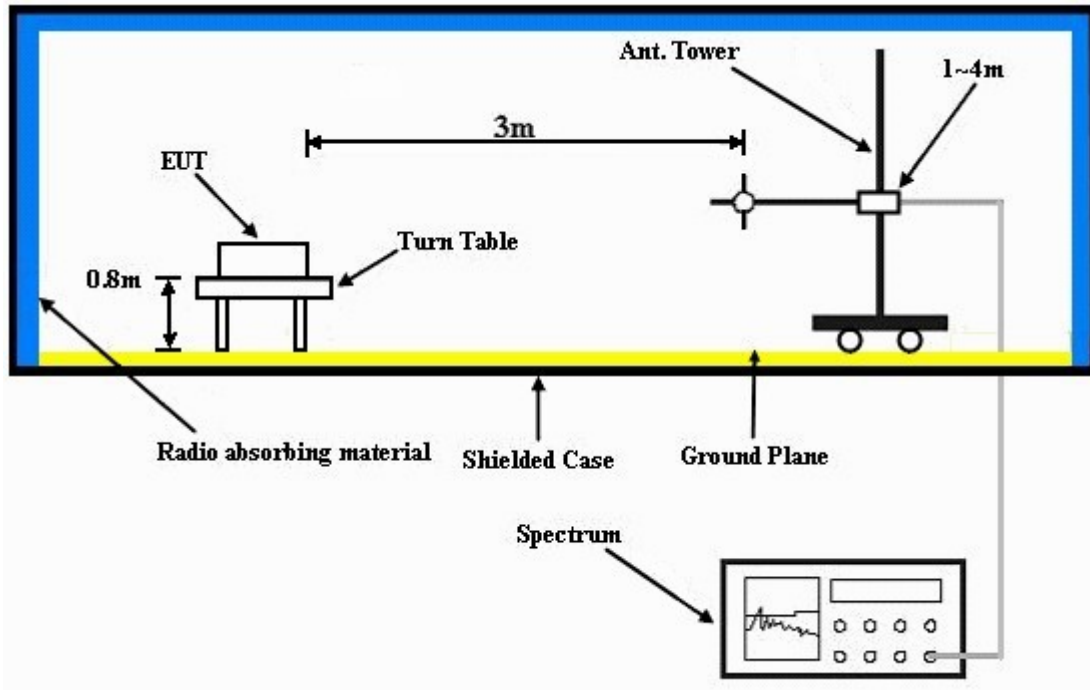

For the actual test configuration, please refer to the attached file (Test Setup Photo).

### 5.1.6 EUT OPERATING CONDITIONS

Same as 4.1.6.



A D T

### 5.1.7 TEST RESULTS

#### ABOVE 1GHz WORST-CASE DATA : 802.11a

EUT TEST CONDITION		MEASUREMENT DETAIL	
CHANNEL	Channel 149	FREQUENCY RANGE	1 ~ 40GHz
INPUT POWER (SYSTEM)	120Vac, 60 Hz	DETECTOR FUNCTION	Peak (PK) Average (AV)
ENVIRONMENTAL CONDITIONS	25deg. C, 65%RH	TESTED BY	Sun Lin

ANTENNA POLARITY & TEST DISTANCE: HORIZONTAL AT 3 M								
NO.	FREQ. (MHz)	EMISSION LEVEL (dBuV/m)	LIMIT (dBuV/m)	MARGIN (dB)	ANTENNA HEIGHT (m)	TABLE ANGLE (Degree)	RAW VALUE (dBuV)	CORRECTION FACTOR (dB/m)
1	#5725.00	62.4 PK	80.3	-17.9	1.12 H	253	23.00	39.40
2	#5725.00	44.4 AV	70.8	-26.4	1.12 H	253	5.00	39.40
3	*5745.00	100.3 PK			1.12 H	253	60.80	39.50
4	*5745.00	90.8 AV			1.12 H	253	51.30	39.50
5	11490.00	66.9 PK	74.0	-7.1	1.42 H	51	17.20	49.70
6	11490.00	50.0 AV	54.0	-4.0	1.42 H	51	0.30	49.70
ANTENNA POLARITY & TEST DISTANCE: VERTICAL AT 3 M								
NO.	FREQ. (MHz)	EMISSION LEVEL (dBuV/m)	LIMIT (dBuV/m)	MARGIN (dB)	ANTENNA HEIGHT (m)	TABLE ANGLE (Degree)	RAW VALUE (dBuV)	CORRECTION FACTOR (dB/m)
1	#5725.00	72.8 PK	87.8	-15.0	1.18 V	264	33.40	39.40
2	#5725.00	53.6 AV	78.1	-24.5	1.18 V	264	14.20	39.40
3	*5745.00	107.8 PK			1.08 V	279	68.30	39.50
4	*5745.00	98.1 AV			1.08 V	279	58.60	39.50
5	11490.00	61.1 PK	74.0	-12.9	1.23 V	202	11.40	49.70
6	11490.00	45.9 AV	54.0	-8.1	1.23 V	202	-3.80	49.70

- REMARKS:**
1. Emission level (dBuV/m) = Raw Value (dBuV) + Correction Factor (dB/m).
  2. Correction Factor (dB/m) = Antenna Factor (dB/m) + Cable Factor (dB).
  3. The other emission levels were very low against the limit.
  4. Margin value = Emission level – Limit value.
  5. “ \* “: Fundamental frequency.
  6. The limit value is defined as per 15.247.
  7. "#":The radiated frequency is out the restricted band.



A D T

EUT TEST CONDITION		MEASUREMENT DETAIL	
CHANNEL	Channel 157	FREQUENCY RANGE	1 ~ 40GHz
INPUT POWER (SYSTEM)	120Vac, 60 Hz	DETECTOR FUNCTION	Peak (PK) Average (AV)
ENVIRONMENTAL CONDITIONS	25deg. C, 65%RH	TESTED BY	Sun Lin

ANTENNA POLARITY & TEST DISTANCE: HORIZONTAL AT 3 M								
NO.	FREQ. (MHz)	EMISSION LEVEL (dBuV/m)	LIMIT (dBuV/m)	MARGIN (dB)	ANTENNA HEIGHT (m)	TABLE ANGLE (Degree)	RAW VALUE (dBuV)	CORRECTION FACTOR (dB/m)
1	#5725.00	46.0 PK	80.0	-34.0	1.13 H	249	6.60	39.40
2	#5725.00	34.0 AV	70.8	-36.8	1.13 H	249	-5.40	39.40
3	*5785.00	100.0 PK			1.13 H	249	60.40	39.60
4	*5785.00	90.8 AV			1.13 H	249	51.20	39.60
5	11570.00	66.2 PK	74.0	-7.8	1.42 H	53	16.70	49.50
6	11570.00	49.3 AV	54.0	-4.7	1.42 H	53	-0.20	49.50
ANTENNA POLARITY & TEST DISTANCE: VERTICAL AT 3 M								
NO.	FREQ. (MHz)	EMISSION LEVEL (dBuV/m)	LIMIT (dBuV/m)	MARGIN (dB)	ANTENNA HEIGHT (m)	TABLE ANGLE (Degree)	RAW VALUE (dBuV)	CORRECTION FACTOR (dB/m)
1	#5725.00	50.5 PK	87.2	-36.7	1.00 V	77	11.10	39.40
2	#5725.00	38.6 AV	77.5	-38.9	1.00 V	77	-0.80	39.40
3	*5785.00	107.2 PK			1.00 V	77	67.60	39.60
4	*5785.00	97.5 AV			1.00 V	77	57.90	39.60
5	11570.00	61.7 PK	74.0	-12.3	1.00 V	0	12.20	49.50
6	11570.00	47.2 AV	54.0	-6.8	1.00 V	0	-2.30	49.50

- REMARKS:**
1. Emission level (dBuV/m) = Raw Value (dBuV) + Correction Factor (dB/m).
  2. Correction Factor (dB/m) = Antenna Factor (dB/m) + Cable Factor (dB).
  3. The other emission levels were very low against the limit.
  4. Margin value = Emission level – Limit value.
  5. “ \* “: Fundamental frequency.
  6. The limit value is defined as per 15.247.
  7. “#“: The radiated frequency is out the restricted band.





A D T

EUT TEST CONDITION		MEASUREMENT DETAIL	
CHANNEL	Channel 165	FREQUENCY RANGE	1 ~ 40GHz
INPUT POWER (SYSTEM)	120Vac, 60 Hz	DETECTOR FUNCTION	Peak (PK) Average (AV)
ENVIRONMENTAL CONDITIONS	25deg. C, 65%RH	TESTED BY	Sun Lin

ANTENNA POLARITY & TEST DISTANCE: HORIZONTAL AT 3 M								
NO.	FREQ. (MHz)	EMISSION LEVEL (dBuV/m)	LIMIT (dBuV/m)	MARGIN (dB)	ANTENNA HEIGHT (m)	TABLE ANGLE (Degree)	RAW VALUE (dBuV)	CORRECTION FACTOR (dB/m)
1	*5825.00	99.4 PK			1.11 H	252	59.70	39.70
2	*5825.00	90.0 AV			1.11 H	252	50.30	39.70
3	#5850.00	62.4 PK	79.4	-17.0	1.13 H	251	22.70	39.70
4	#5850.00	43.0 AV	70.0	-27.0	1.13 H	251	3.30	39.70
5	11650.00	65.9 PK	74.0	-8.1	1.42 H	49	16.50	49.40
6	11650.00	49.0 AV	54.0	-5.0	1.42 H	49	-0.40	49.40

ANTENNA POLARITY & TEST DISTANCE: VERTICAL AT 3 M								
NO.	FREQ. (MHz)	EMISSION LEVEL (dBuV/m)	LIMIT (dBuV/m)	MARGIN (dB)	ANTENNA HEIGHT (m)	TABLE ANGLE (Degree)	RAW VALUE (dBuV)	CORRECTION FACTOR (dB/m)
1	*5825.00	106.7 PK			1.18 V	251	67.00	39.70
2	*5825.00	97.0 AV			1.18 V	251	57.30	39.70
3	#5850.00	70.1 PK	86.7	-16.6	1.07 V	257	30.40	39.70
4	#5850.00	51.9 AV	77.0	-25.1	1.07 V	257	12.20	39.70
5	11650.00	62.2 PK	74.0	-11.8	1.18 V	207	12.80	49.40
6	11650.00	47.2 AV	54.0	-6.8	1.18 V	207	-2.20	49.40

- REMARKS:**
1. Emission level (dBuV/m) = Raw Value (dBuV) + Correction Factor (dB/m).
  2. Correction Factor (dB/m) = Antenna Factor (dB/m) + Cable Factor (dB).
  3. The other emission levels were very low against the limit.
  4. Margin value = Emission level – Limit value.
  5. “ \* “: Fundamental frequency.
  6. The limit value is defined as per 15.247.
  7. "#":The radiated frequency is out the restricted band.



A D T

802.11n (20MHz)

EUT TEST CONDITION		MEASUREMENT DETAIL	
CHANNEL	Channel 149	FREQUENCY RANGE	1 ~ 40GHz
INPUT POWER (SYSTEM)	120Vac, 60 Hz	DETECTOR FUNCTION	Peak (PK) Average (AV)
ENVIRONMENTAL CONDITIONS	25deg. C, 65%RH	TESTED BY	Sun Lin

ANTENNA POLARITY & TEST DISTANCE: HORIZONTAL AT 3 M								
NO.	FREQ. (MHz)	EMISSION LEVEL (dBuV/m)	LIMIT (dBuV/m)	MARGIN (dB)	ANTENNA HEIGHT (m)	TABLE ANGLE (Degree)	RAW VALUE (dBuV)	CORRECTION FACTOR (dB/m)
1	#5725.00	58.3 PK	80.4	-22.1	1.38 H	333	18.90	39.40
2	#5725.00	44.0 AV	68.5	-24.5	1.38 H	333	4.60	39.40
3	*5745.00	100.4 PK			1.38 H	333	60.90	39.50
4	*5745.00	88.5 AV			1.38 H	333	49.00	39.50
5	11490.00	62.5 PK	74.0	-11.5	1.45 H	46	12.80	49.70
6	11490.00	48.4 AV	54.0	-5.6	1.45 H	46	-1.30	49.70
ANTENNA POLARITY & TEST DISTANCE: VERTICAL AT 3 M								
NO.	FREQ. (MHz)	EMISSION LEVEL (dBuV/m)	LIMIT (dBuV/m)	MARGIN (dB)	ANTENNA HEIGHT (m)	TABLE ANGLE (Degree)	RAW VALUE (dBuV)	CORRECTION FACTOR (dB/m)
1	#5725.00	65.3 PK	91.2	-25.9	1.42 V	193	25.90	39.40
2	#5725.00	51.7 AV	79.6	-27.9	1.42 V	193	12.30	39.40
3	*5745.00	111.2 PK			1.42 V	191	71.70	39.50
4	*5745.00	99.6 AV			1.42 V	191	60.10	39.50
5	11490.00	59.8 PK	74.0	-14.2	1.40 V	148	10.10	49.70
6	11490.00	47.0 AV	54.0	-7.0	1.40 V	148	-2.70	49.70

- REMARKS:**
1. Emission level (dBuV/m) = Raw Value (dBuV) + Correction Factor (dB/m).
  2. Correction Factor (dB/m) = Antenna Factor (dB/m) + Cable Factor (dB).
  3. The other emission levels were very low against the limit.
  4. Margin value = Emission level – Limit value.
  5. “ \* “: Fundamental frequency.
  6. The limit value is defined as per 15.247.
  7. "#":The radiated frequency is out the restricted band.



A D T

EUT TEST CONDITION		MEASUREMENT DETAIL	
CHANNEL	Channel 157	FREQUENCY RANGE	1 ~ 40GHz
INPUT POWER (SYSTEM)	120Vac, 60 Hz	DETECTOR FUNCTION	Peak (PK) Average (AV)
ENVIRONMENTAL CONDITIONS	25deg. C, 65%RH	TESTED BY	Sun Lin

ANTENNA POLARITY & TEST DISTANCE: HORIZONTAL AT 3 M								
NO.	FREQ. (MHz)	EMISSION LEVEL (dBuV/m)	LIMIT (dBuV/m)	MARGIN (dB)	ANTENNA HEIGHT (m)	TABLE ANGLE (Degree)	RAW VALUE (dBuV)	CORRECTION FACTOR (dB/m)
1	#5725.00	47.8 PK	80.0	-32.2	1.37 H	335	8.40	39.40
2	#5725.00	35.6 AV	68.0	-32.4	1.37 H	335	-3.80	39.40
3	*5785.00	100.0 PK			1.37 H	335	60.40	39.60
4	*5785.00	88.0 AV			1.37 H	335	48.40	39.60
5	11570.00	61.3 PK	74.0	-12.7	1.47 H	47	11.80	49.50
6	11570.00	47.7 AV	54.0	-6.3	1.47 H	47	-1.80	49.50
ANTENNA POLARITY & TEST DISTANCE: VERTICAL AT 3 M								
NO.	FREQ. (MHz)	EMISSION LEVEL (dBuV/m)	LIMIT (dBuV/m)	MARGIN (dB)	ANTENNA HEIGHT (m)	TABLE ANGLE (Degree)	RAW VALUE (dBuV)	CORRECTION FACTOR (dB/m)
1	#5725.00	50.0 PK	90.6	-40.6	1.16 V	9	10.60	39.40
2	#5725.00	38.6 AV	79.0	-40.4	1.16 V	9	-0.80	39.40
3	*5785.00	110.6 PK			1.16 V	9	71.00	39.60
4	*5785.00	99.0 AV			1.16 V	9	59.40	39.60
5	11570.00	61.0 PK	74.0	-13.0	1.16 V	21	11.50	49.50
6	11570.00	46.8 AV	54.0	-7.2	1.16 V	21	-2.70	49.50

- REMARKS:**
1. Emission level (dBuV/m) = Raw Value (dBuV) + Correction Factor (dB/m).
  2. Correction Factor (dB/m) = Antenna Factor (dB/m) + Cable Factor (dB).
  3. The other emission levels were very low against the limit.
  4. Margin value = Emission level – Limit value.
  5. “ \* “: Fundamental frequency.
  6. The limit value is defined as per 15.247.
  7. “#“: The radiated frequency is out the restricted band.



A D T

EUT TEST CONDITION		MEASUREMENT DETAIL	
CHANNEL	Channel 165	FREQUENCY RANGE	1 ~ 40GHz
INPUT POWER (SYSTEM)	120Vac, 60 Hz	DETECTOR FUNCTION	Peak (PK) Average (AV)
ENVIRONMENTAL CONDITIONS	25deg. C, 65%RH	TESTED BY	Sun Lin

ANTENNA POLARITY & TEST DISTANCE: HORIZONTAL AT 3 M								
NO.	FREQ. (MHz)	EMISSION LEVEL (dBuV/m)	LIMIT (dBuV/m)	MARGIN (dB)	ANTENNA HEIGHT (m)	TABLE ANGLE (Degree)	RAW VALUE (dBuV)	CORRECTION FACTOR (dB/m)
1	*5825.00	99.2 PK			1.37 H	335	59.50	39.70
2	*5825.00	87.3 AV			1.37 H	335	47.60	39.70
3	#5850.00	54.7 PK	79.2	-24.5	1.37 H	335	15.00	39.70
4	#5850.00	37.4 AV	67.3	-29.9	1.37 H	335	-2.30	39.70
5	11650.00	61.4 PK	74.0	-12.6	1.48 H	48	12.00	49.40
6	11650.00	47.6 AV	54.0	-6.4	1.48 H	48	-1.80	49.40
ANTENNA POLARITY & TEST DISTANCE: VERTICAL AT 3 M								
NO.	FREQ. (MHz)	EMISSION LEVEL (dBuV/m)	LIMIT (dBuV/m)	MARGIN (dB)	ANTENNA HEIGHT (m)	TABLE ANGLE (Degree)	RAW VALUE (dBuV)	CORRECTION FACTOR (dB/m)
1	*5825.00	109.8 PK			1.12 V	198	70.10	39.70
2	*5825.00	98.3 AV			1.12 V	198	58.60	39.70
3	#5850.00	65.4 PK	89.8	-24.4	1.12 V	241	25.70	39.70
4	#5850.00	43.2 AV	78.3	-35.1	1.12 V	241	3.50	39.70
5	11650.00	60.8 PK	74.0	-13.2	1.12 V	198	11.40	49.40
6	11650.00	46.6 AV	54.0	-7.4	1.12 V	198	-2.80	49.40

- REMARKS:**
1. Emission level (dBuV/m) = Raw Value (dBuV) + Correction Factor (dB/m).
  2. Correction Factor (dB/m) = Antenna Factor (dB/m) + Cable Factor (dB).
  3. The other emission levels were very low against the limit.
  4. Margin value = Emission level – Limit value.
  5. “ \* “: Fundamental frequency.
  6. The limit value is defined as per 15.247.
  7. “#“: The radiated frequency is out the restricted band.



A D T

802.11n (40MHz)

EUT TEST CONDITION		MEASUREMENT DETAIL	
CHANNEL	Channel 151	FREQUENCY RANGE	1 ~ 40GHz
INPUT POWER (SYSTEM)	120Vac, 60 Hz	DETECTOR FUNCTION	Peak (PK) Average (AV)
ENVIRONMENTAL CONDITIONS	25deg. C, 65%RH	TESTED BY	Sun Lin

ANTENNA POLARITY & TEST DISTANCE: HORIZONTAL AT 3 M								
NO.	FREQ. (MHz)	EMISSION LEVEL (dBuV/m)	LIMIT (dBuV/m)	MARGIN (dB)	ANTENNA HEIGHT (m)	TABLE ANGLE (Degree)	RAW VALUE (dBuV)	CORRECTION FACTOR (dB/m)
1	#5725.00	60.5 PK	76.7	-16.2	1.33 H	336	21.10	39.40
2	#5725.00	47.8 AV	66.0	-18.2	1.33 H	336	8.40	39.40
3	*5755.00	96.7 PK			1.33 H	336	57.20	39.50
4	*5755.00	86.0 AV			1.33 H	336	46.50	39.50
5	11510.00	57.3 PK	74.0	-16.7	1.00 H	0	7.70	49.60
6	11510.00	45.1 AV	54.0	-8.9	1.00 H	0	-4.50	49.60
ANTENNA POLARITY & TEST DISTANCE: VERTICAL AT 3 M								
NO.	FREQ. (MHz)	EMISSION LEVEL (dBuV/m)	LIMIT (dBuV/m)	MARGIN (dB)	ANTENNA HEIGHT (m)	TABLE ANGLE (Degree)	RAW VALUE (dBuV)	CORRECTION FACTOR (dB/m)
1	#5725.00	82.5 PK	87.9	-5.4	1.08 V	169	43.10	39.40
2	#5725.00	63.7 AV	77.1	-13.4	1.08 V	169	24.30	39.40
3	*5755.00	107.9 PK			1.06 V	165	68.40	39.50
4	*5755.00	97.1 AV			1.06 V	165	57.60	39.50
5	11510.00	57.5 PK	74.0	-16.5	1.00 V	82	7.90	49.60
6	11510.00	45.3 AV	54.0	-8.7	1.00 V	82	-4.30	49.60

- REMARKS:**
1. Emission level (dBuV/m) = Raw Value (dBuV) + Correction Factor (dB/m).
  2. Correction Factor (dB/m) = Antenna Factor (dB/m) + Cable Factor (dB).
  3. The other emission levels were very low against the limit.
  4. Margin value = Emission level – Limit value.
  5. “ \* “: Fundamental frequency.
  6. The limit value is defined as per 15.247.
  7. "#":The radiated frequency is out the restricted band.



A D T

EUT TEST CONDITION		MEASUREMENT DETAIL	
CHANNEL	Channel 159	FREQUENCY RANGE	1 ~ 40GHz
INPUT POWER (SYSTEM)	120Vac, 60 Hz	DETECTOR FUNCTION	Peak (PK) Average (AV)
ENVIRONMENTAL CONDITIONS	25deg. C, 65%RH	TESTED BY	Sun Lin

ANTENNA POLARITY & TEST DISTANCE: HORIZONTAL AT 3 M								
NO.	FREQ. (MHz)	EMISSION LEVEL (dBuV/m)	LIMIT (dBuV/m)	MARGIN (dB)	ANTENNA HEIGHT (m)	TABLE ANGLE (Degree)	RAW VALUE (dBuV)	CORRECTION FACTOR (dB/m)
1	*5795.00	96.1 PK			1.32 H	335	56.50	39.60
2	*5795.00	85.6 AV			1.32 H	335	46.00	39.60
3	#5850.00	52.0 PK	76.1	-24.1	1.32 H	335	12.30	39.70
4	#5850.00	37.0 AV	65.6	-28.6	1.32 H	335	-2.70	39.70
5	11590.00	58.5 PK	74.0	-15.5	1.00 H	0	9.00	49.50
6	11590.00	45.2 AV	54.0	-8.8	1.00 H	0	-4.30	49.50
ANTENNA POLARITY & TEST DISTANCE: VERTICAL AT 3 M								
NO.	FREQ. (MHz)	EMISSION LEVEL (dBuV/m)	LIMIT (dBuV/m)	MARGIN (dB)	ANTENNA HEIGHT (m)	TABLE ANGLE (Degree)	RAW VALUE (dBuV)	CORRECTION FACTOR (dB/m)
1	*5795.00	107.5 PK			1.12 V	157	67.90	39.60
2	*5795.00	96.8 AV			1.12 V	157	57.20	39.60
3	#5850.00	75.6 PK	87.5	-11.9	1.12 V	158	35.90	39.70
4	#5850.00	54.7 AV	76.8	-22.1	1.12 V	158	15.00	39.70
5	11590.00	57.9 PK	74.0	-16.1	1.08 V	108	8.40	49.50
6	11590.00	45.8 AV	54.0	-8.2	1.08 V	108	-3.70	49.50

- REMARKS:**
1. Emission level (dBuV/m) = Raw Value (dBuV) + Correction Factor (dB/m).
  2. Correction Factor (dB/m) = Antenna Factor (dB/m) + Cable Factor (dB).
  3. The other emission levels were very low against the limit.
  4. Margin value = Emission level – Limit value.
  5. “ \* “: Fundamental frequency.
  6. The limit value is defined as per 15.247.
  7. “#”:The radiated frequency is out the restricted band.



A D T

BELOW 1GHz WORST-CASE DATA : 802.11a

EUT TEST CONDITION		MEASUREMENT DETAIL	
CHANNEL	Channel 165	FREQUENCY RANGE	Below 1000MHz
INPUT POWER (SYSTEM)	120Vac, 60 Hz	DETECTOR FUNCTION	Quasi-Peak
ENVIRONMENTAL CONDITIONS	25deg. C, 68%RH	TESTED BY	Sun Lin

ANTENNA POLARITY & TEST DISTANCE: HORIZONTAL AT 3 M								
NO.	FREQ. (MHz)	EMISSION LEVEL (dBuV/m)	LIMIT (dBuV/m)	MARGIN (dB)	ANTENNA HEIGHT (m)	TABLE ANGLE (Degree)	RAW VALUE (dBuV)	CORRECTION FACTOR (dB/m)
1	283.80	42.3 QP	46.0	-3.7	1.08 H	57	28.30	14.00
2	362.37	34.3 QP	46.0	-11.7	1.50 H	286	18.20	16.10
3	420.70	32.9 QP	46.0	-13.1	2.00 H	241	15.40	17.50
4	479.03	33.7 QP	46.0	-12.3	2.00 H	37	14.60	19.10
5	539.30	35.2 QP	46.0	-10.8	1.75 H	52	14.50	20.70
6	599.58	42.7 QP	46.0	-3.3	1.00 H	220	20.60	22.10
ANTENNA POLARITY & TEST DISTANCE: VERTICAL AT 3 M								
NO.	FREQ. (MHz)	EMISSION LEVEL (dBuV/m)	LIMIT (dBuV/m)	MARGIN (dB)	ANTENNA HEIGHT (m)	TABLE ANGLE (Degree)	RAW VALUE (dBuV)	CORRECTION FACTOR (dB/m)
1	43.51	34.4 QP	40.0	-5.6	1.25 V	310	21.40	13.00
2	189.33	31.1 QP	43.5	-12.4	1.50 V	184	20.30	10.80
3	282.66	42.8 QP	46.0	-3.2	2.00 V	10	28.90	13.90
4	420.70	32.9 QP	46.0	-13.1	2.00 V	355	15.40	17.50
5	500.42	35.6 QP	46.0	-10.4	1.00 V	328	15.90	19.70
6	599.58	38.2 QP	46.0	-7.8	2.00 V	88	16.10	22.10

- REMARKS:**
1. Emission level (dBuV/m) = Raw Value (dBuV) + Correction Factor (dB/m).
  2. Correction Factor (dB/m) = Antenna Factor (dB/m) + Cable Factor (dB).
  3. The other emission levels were very low against the limit.
  4. Margin value = Emission level – Limit value.



## 5.2 CONDUCTED EMISSION MEASUREMENT

### 5.2.1 LIMITS OF CONDUCTED EMISSION MEASUREMENT

FREQUENCY OF EMISSION (MHz)	CONDUCTED LIMIT (dBµV)	
	Quasi-peak	Average
0.15 ~ 0.5	66 to 56	56 to 46
0.5 ~ 5	56	46
5 ~ 30	60	50

- NOTE:** 1. The lower limit shall apply at the transition frequencies.  
 2. The limit decreases in line with the logarithm of the frequency in the range of 0.15 to 0.50MHz.  
 3. All emanations from a class A/B digital device or system, including any network of conductors and apparatus connected thereto, shall not exceed the level of field strengths specified above.

### 5.2.2 TEST INSTRUMENTS

DESCRIPTION & MANUFACTURER	MODEL NO.	SERIAL NO.	DATE OF CALIBRATION	DUE DATE OF CALIBRATION
Test Receiver ROHDE & SCHWARZ	ESCS30	100291	Nov. 23, 2011	Nov. 22, 2012
RF signal cable Woken	5D-FB	Cable-HYC01-01	Dec. 30, 2010	Dec. 29, 2011
LISN ROHDE & SCHWARZ	ESH3-Z5	100312	Jul. 07, 2011	Jul. 06, 2012
LISN ROHDE & SCHWARZ	ESH2-Z5	100100	Jan. 06, 2011	Jan. 05, 2012
LISN ROHDE & SCHWARZ	ESH3-Z5	835239/001	Feb. 22, 2011	Feb. 21, 2012
V-LISN SCHWARZBECK	NNBL 8226-2	8226-142	Jun. 30, 2011	Jun. 29, 2012
LISN ROHDE & SCHWARZ	ENV216	100072	Jun. 10, 2011	Jun. 09, 2012
Software ADT	ADT_Cond_ V7.3.7	NA	NA	NA

- NOTE:** 1. The calibration interval of the above test instruments is 12 months and the calibrations are traceable to NML/ROC and NIST/USA.  
 2. The test was performed in HwaYa Shielded Room 1.  
 3. The VCCI Site Registration No. is C-2040.





A D T

### 5.2.3 TEST PROCEDURES

- a. The EUT was placed 0.4 meters from the conducting wall of the shielded room with EUT being connected to the power mains through a line impedance stabilization network (LISN). Other support units were connected to the power mains through another LISN. The two LISNs provide 50 ohm/ 50uH of coupling impedance for the measuring instrument.
- b. Both lines of the power mains connected to the EUT were checked for maximum conducted interference.
- c. The frequency range from 150kHz to 30MHz was searched. Emission levels under (Limit - 20dB) was not recorded.

**NOTE:** All modes of operation were investigated and the worst-case emissions are reported.

### 5.2.4 DEVIATION FROM TEST STANDARD

No deviation.

### 5.2.5 TEST SETUP

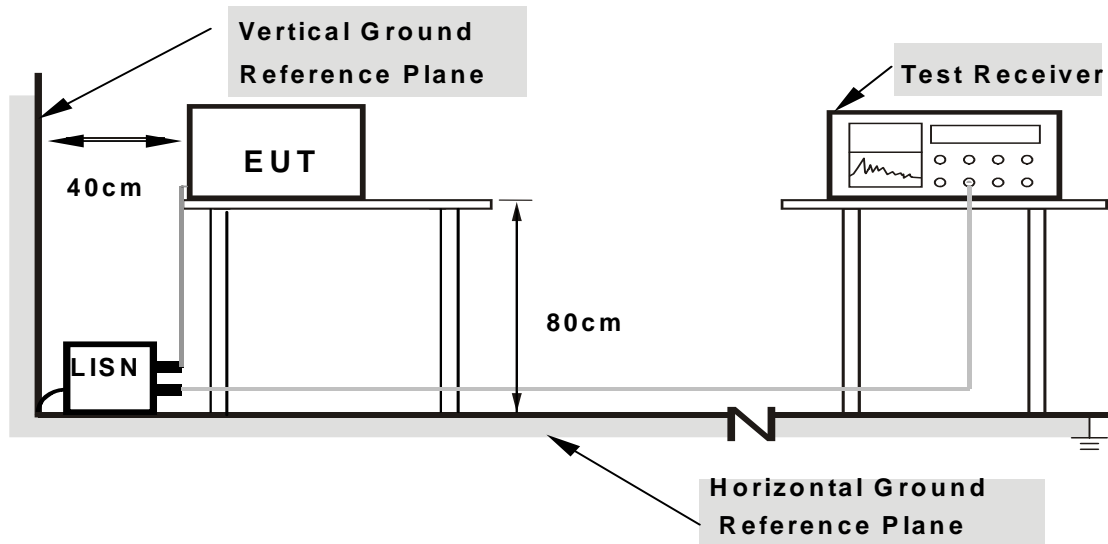

- Note:**
1. Support units were connected to second LISN.
  2. Both of LISNs (AMN) are 80 cm from EUT and at least 80 from other units and other metal planes

For the actual test configuration, please refer to the attached file (Test Setup Photo).

### 5.2.6 EUT OPERATING CONDITIONS

Same as 4.1.6

### 5.2.7 TEST RESULTS

**CONDUCTED WORST-CASE DATA : 802.11n (20MHz)**

<b>PHASE</b>	Line 1	<b>6dB BANDWIDTH</b>	9kHz
--------------	--------	----------------------	------

No	Freq. [MHz]	Corr. Factor (dB)	Reading Value		Emission Level		Limit		Margin	
			[dB (uV)]		[dB (uV)]		[dB (uV)]		(dB)	
			Q.P.	AV.	Q.P.	AV.	Q.P.	AV.	Q.P.	AV.
1	0.162	0.12	48.25	39.43	48.37	39.55	65.38	55.38	-17.01	-15.83
2	0.173	0.12	48.30	33.96	48.42	34.08	64.79	54.79	-16.38	-20.72
3	0.537	0.13	41.40	25.54	41.53	25.67	56.00	46.00	-14.47	-20.33
4	0.814	0.15	33.46	17.03	33.61	17.18	56.00	46.00	-22.39	-28.82
5	1.160	0.16	30.72	17.49	30.88	17.65	56.00	46.00	-25.12	-28.35
6	9.102	0.61	19.36	9.31	19.97	9.92	60.00	50.00	-40.03	-40.08

- REMARKS:**
1. Q.P. and AV. are abbreviations of quasi-peak and average individually.
  2. "-": The Quasi-peak reading value also meets average limit and measurement with the average detector is unnecessary.
  3. The emission levels of other frequencies were very low against the limit.
  4. Margin value = Emission level - Limit value
  5. Correction factor = Insertion loss + Cable loss
  6. Emission Level = Correction Factor + Reading Value.

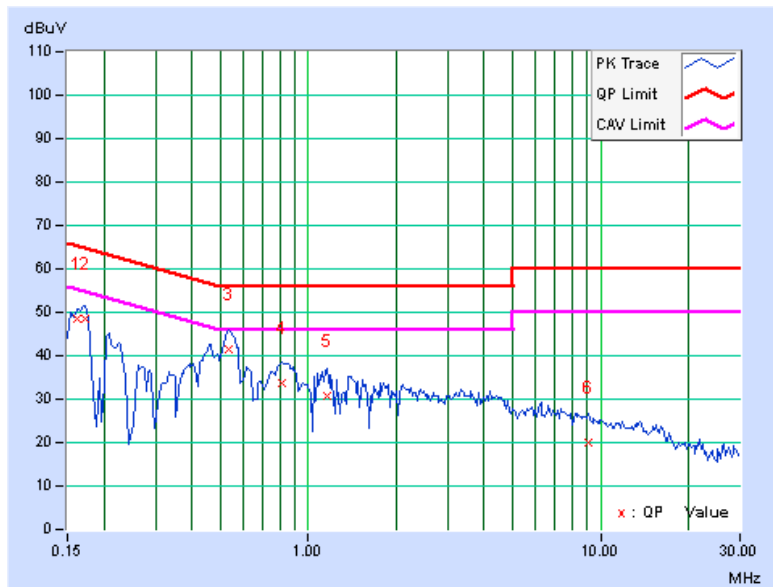

PHASE	Line 2	6dB BANDWIDTH	9kHz
-------	--------	---------------	------

No	Freq. [MHz]	Corr. Factor (dB)	Reading Value		Emission Level		Limit		Margin	
			[dB (uV)]		[dB (uV)]		[dB (uV)]		(dB)	
			Q.P.	AV.	Q.P.	AV.	Q.P.	AV.	Q.P.	AV.
1	0.162	0.13	50.67	33.65	50.80	33.78	65.38	55.38	-14.58	-21.60
2	0.173	0.13	49.73	27.96	49.86	28.09	64.79	54.79	-14.94	-26.71
3	0.525	0.15	37.57	23.74	37.72	23.89	56.00	46.00	-18.28	-22.11
4	0.826	0.17	28.45	13.39	28.62	13.56	56.00	46.00	-27.38	-32.44
5	6.680	0.45	18.72	10.02	19.17	10.47	60.00	50.00	-40.83	-39.53
6	14.434	0.73	15.86	5.50	16.59	6.23	60.00	50.00	-43.41	-43.77

- REMARKS:**
1. Q.P. and AV. are abbreviations of quasi-peak and average individually.
  2. "-": The Quasi-peak reading value also meets average limit and measurement with the average detector is unnecessary.
  3. The emission levels of other frequencies were very low against the limit.
  4. Margin value = Emission level - Limit value
  5. Correction factor = Insertion loss + Cable loss
  6. Emission Level = Correction Factor + Reading Value.

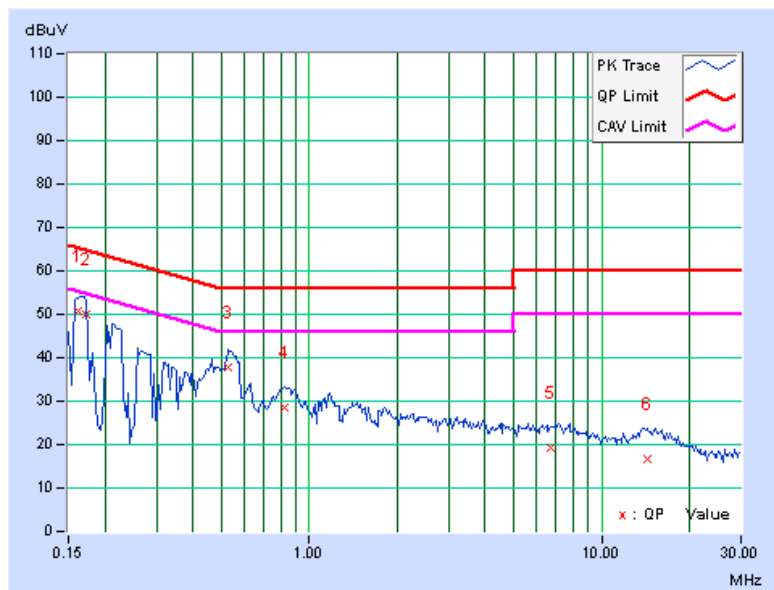

### 5.3 6dB BANDWIDTH MEASUREMENT

#### 5.3.1 LIMITS OF 6dB BANDWIDTH MEASUREMENT

The minimum of 6dB Bandwidth Measurement is 0.5MHz.

#### 5.3.2 TEST SETUP

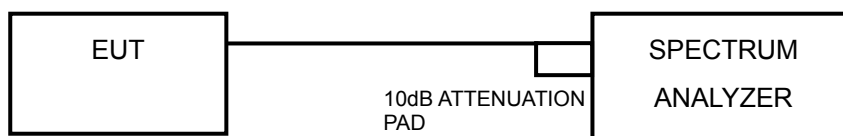

#### 5.3.3 TEST INSTRUMENTS

Refer to section 4.1.2 to get information of above instrument.

#### 5.3.4 TEST PROCEDURE

1. Set resolution bandwidth (RBW) = approximately 1% of the emission bandwidth
2. Set the video bandwidth (VBW)  $\geq 3 \times$  RBW, Detector = Peak.
3. Trace mode = max hold.
4. Sweep = auto couple.
5. Measure the maximum width of the emission that is constrained by the frequencies associated with the two amplitude points (upper and lower) that are attenuated by 6 dB relative to the maximum level measured in the fundamental emission

#### 5.3.5 DEVIATION FROM TEST STANDARD

No deviation.

#### 5.3.6 EUT OPERATING CONDITIONS

The software provided by client to enable the EUT under transmission condition continuously at lowest, middle and highest channel frequencies



A D T

individually.

### 5.3.7 TEST RESULTS

#### 802.11a

CHANNEL	CHANNEL FREQUENCY (MHz)	6dB BANDWIDTH (MHz)	MINIMUM LIMIT (MHz)	PASS / FAIL
149	5745	16.50	0.5	PASS
157	5785	16.52	0.5	PASS
165	5825	16.53	0.5	PASS

#### 802.11n (20MHz)

CHANNEL	CHANNEL FREQUENCY (MHz)	6dB BANDWIDTH (MHz)		MINIMUM LIMIT (MHz)	PASS / FAIL
		CHAIN 0	CHAIN 1		
149	5745	17.73	17.76	0.5	PASS
157	5785	17.73	17.76	0.5	PASS
165	5825	17.72	17.75	0.5	PASS

#### 802.11n (40MHz)

CHANNEL	CHANNEL FREQUENCY (MHz)	6dB BANDWIDTH (MHz)		MINIMUM LIMIT (MHz)	PASS / FAIL
		CHAIN 0	CHAIN 1		
151	5755	36.64	36.24	0.5	PASS
159	5795	36.46	36.31	0.5	PASS

## 5.4 MAXIMUM OUTPUT POWER

### 5.4.1 LIMITS OF MAXIMUM OUTPUT POWER MEASUREMENT

For systems using digital modulation in the 5725 –5850 MHz bands: 1 Watt (30dBm)

### 5.4.2 TEST SETUP

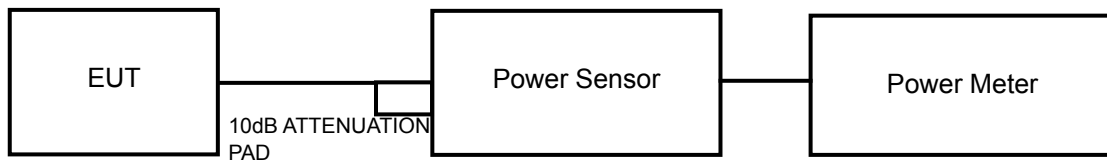

### 5.4.3 INSTRUMENTS

Refer to section 4.1.2 to get information of above instrument.

### 5.4.4 TEST PROCEDURES

A power sensor was used on the output port of the EUT. A power meter was used to read the response of the power sensor. Record the power level.

### 5.4.5 DEVIATION FROM TEST STANDARD

No deviation.

### 5.4.6 EUT OPERATING CONDITIONS

Same as Item 4.3.6.



### 5.4.7 TEST RESULTS

#### 802.11a

CHANNEL	FREQUENCY (MHz)	PEAK POWER (mW)	PEAK POWER (dBm)	LIMIT (dBm)	PASS/FAIL
149	5745	186.2	22.7	30	PASS
157	5785	158.5	22.0	30	PASS
165	5825	173.8	22.4	30	PASS

#### 802.11n (20MHz)

CHAN.	CHAN. FREQ. (MHz)	POWER OUTPUT (dBm)		TOTAL POWER (mW)	TOTAL POWER (dBm)	POWER LIMIT (dBm)	PASS / FAIL
		CHAIN 0	CHAIN 1				
149	5745	22.1	21.2	294.0	24.7	30	PASS
157	5785	21.8	21.6	<b>295.9</b>	24.7	30	PASS
165	5825	21.8	21.6	295.9	24.7	30	PASS

#### 802.11n (40MHz)

CHAN.	CHAN. FREQ. (MHz)	POWER OUTPUT (dBm)		TOTAL POWER (mW)	TOTAL POWER (dBm)	POWER LIMIT (dBm)	PASS / FAIL
		CHAIN 0	CHAIN 1				
151	5755	21.3	21.5	276.2	24.4	30	PASS
159	5795	21.4	21.5	279.3	24.5	30	PASS



## 5.5 POWER SPECTRAL DENSITY MEASUREMENT

### 5.5.1 LIMITS OF POWER SPECTRAL DENSITY MEASUREMENT

The Maximum of Power Spectral Density Measurement is 8dBm.

### 5.5.2 TEST SETUP

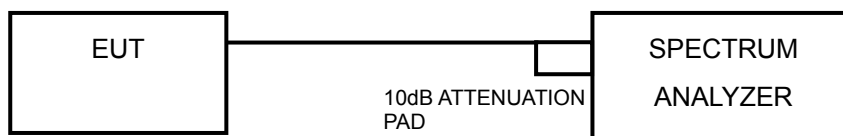

### 5.5.3 TEST INSTRUMENTS

Refer to section 4.1.2 to get information of above instrument.

### 5.5.4 TEST PROCEDURE.

1. Set the RBW = 100 kHz, VBW = 300 kHz, Detector = peak.
2. Sweep time = auto couple, Trace mode = max hold, allow trace to fully stabilize.
3. Use the peak marker function to determine the maximum power level in any 100 kHz band segment within the fundamental EBW.
4. Scale the observed power level to an equivalent value in 3 kHz by adjusting (reducing) the measured power by a bandwidth correction factor (BWCF) where  $BWCF = 10\log(3 \text{ kHz}/100\text{kHz})$

### 5.5.5 DEVIATION FROM TEST STANDARD

No deviation.

### 5.5.6 EUT OPERATING CONDITION

Same as Item 5.3.6.



## 5.5.7 TEST RESULTS

### 802.11a

Channel	FREQ. (MHz)	PSD (dBm/100kHz)	PSD (dBm/3kHz)	Limit (dBm/3kHz)	PASS /FAIL
149	5745	2.23	-13.00	8	PASS
157	5785	2.10	-13.13	8	PASS
165	5825	1.95	-13.28	8	PASS

### 802.11n (20MHz)

TX chain	Channel	FREQ. (MHz)	PSD (dBm/100kHz)	PSD (dBm/3kHz)	10 log (N=2) dB	Total PSD (dBm/3kHz)	Limit (dBm/3kHz)	PASS /FAIL
0	149	5745	-0.50	-15.73	3.01	-12.72	8	PASS
	157	5785	-0.75	-15.98	3.01	-12.97	8	PASS
	165	5825	-0.83	-16.06	3.01	-13.05	8	PASS
1	149	5745	0.00	-15.23	3.01	-12.22	8	PASS
	157	5785	0.56	-14.67	3.01	-11.66	8	PASS
	165	5825	0.34	-14.89	3.01	-11.88	8	PASS

### 802.11n (40MHz)

TX chain	Channel	FREQ. (MHz)	PSD (dBm/100kHz)	PSD (dBm/3kHz)	10 log (N=2) dB	Total PSD (dBm/3kHz)	Limit (dBm/3kHz)	PASS /FAIL
0	151	5755	-3.03	-18.26	3.01	-15.25	8	PASS
	159	5795	-2.96	-18.19	3.01	-15.18	8	PASS
1	151	5755	-2.68	-17.91	3.01	-14.90	8	PASS
	159	5795	-2.63	-17.86	3.01	-14.85	8	PASS

## 5.6 CONDUCTED EMISSION MEASUREMENT

### 5.6.1 LIMITS OF BAND EDGES MEASUREMENT

Below  $-20\text{dB}$  of the highest emission level of operating band (in 100kHz Resolution Bandwidth).

### 5.6.2 TEST SETUP

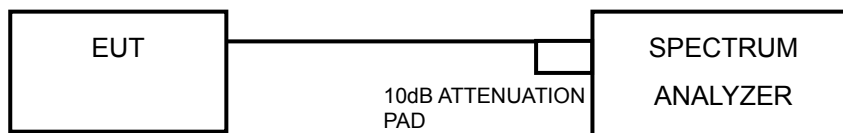

### 5.6.3 TEST INSTRUMENTS

Refer to section 4.1.2 to get information of above instrument.

### 5.6.4 TEST PROCEDURE

#### MEASUREMENT PROCEDURE REF

1. Set the RBW = 100 kHz.
2. Set the VBW  $\geq$  300 kHz.
3. Detector = peak.
4. Sweep time = auto couple.
5. Trace mode = max hold.
6. Allow trace to fully stabilize.
7. Use the peak marker function to determine the maximum power level in any 100 kHz band segment within the fundamental EBW.



A D T

## MEASUREMENT PROCEDURE OOBE

1. Set RBW = 100 kHz.
2. Set VBW  $\geq$  300 kHz.
3. Set span to encompass the spectrum to be examined.
4. Detector = peak.
5. Trace Mode = max hold.
6. Sweep = auto couple.

### 5.6.5 DEVIATION FROM TEST STANDARD

No deviation.

### 5.6.6 EUT OPERATING CONDITION

Same as Item 5.3.6

### 5.6.7 TEST RESULTS

The conducted emission test is performed on each TX port of operating mode without summing or adding  $10\log(N)$  since the limit is relative emission limit. Only worst data of each operating mode is presented.

The spectrum plots are attached on the following pages. D1 line indicates the highest level, and D2 line indicates the 20dB offset below D1. It shows compliance with the requirement in part 15.247(d).



A D T

### 802.11a

#### CH 149

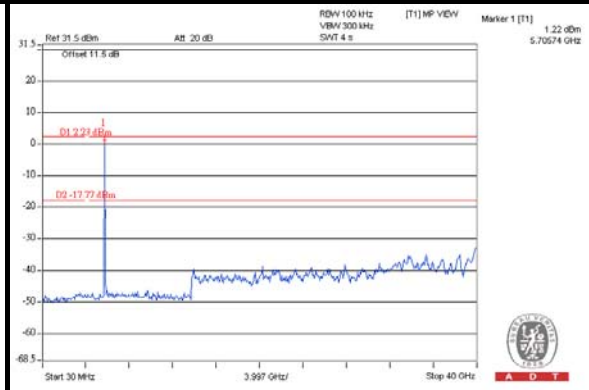
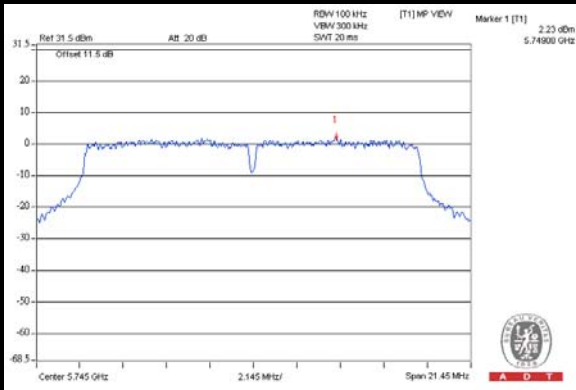

#### CH 157

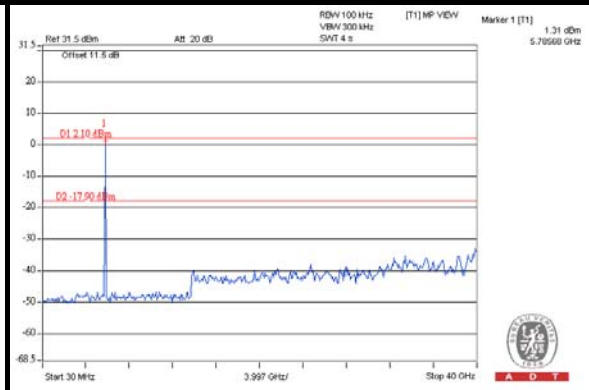
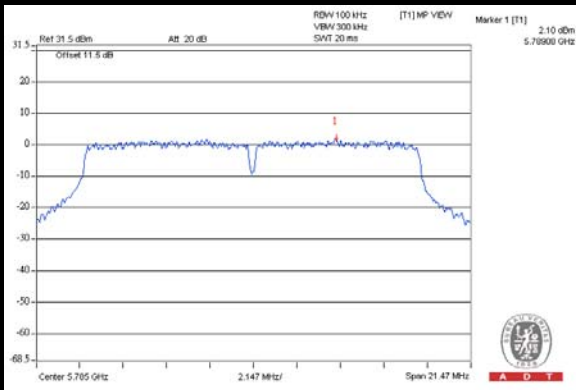

#### CH 165

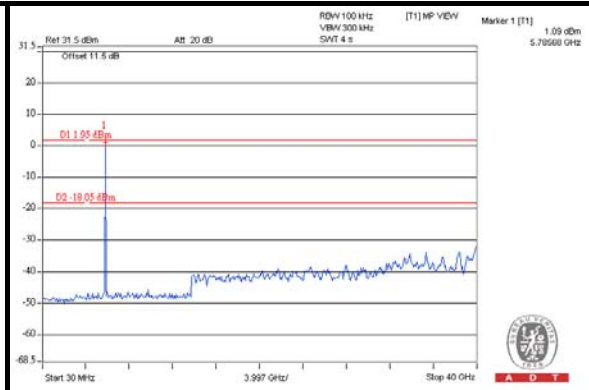
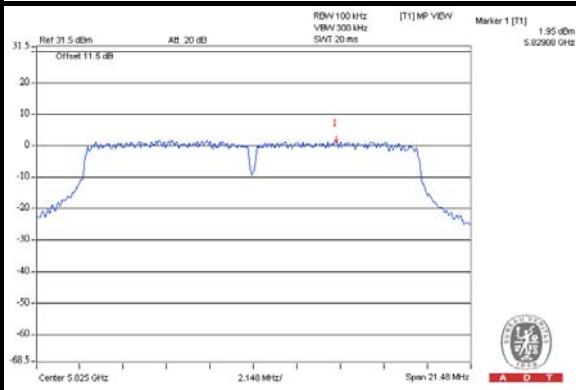

### 802.11n(20MHz)

#### CH 149

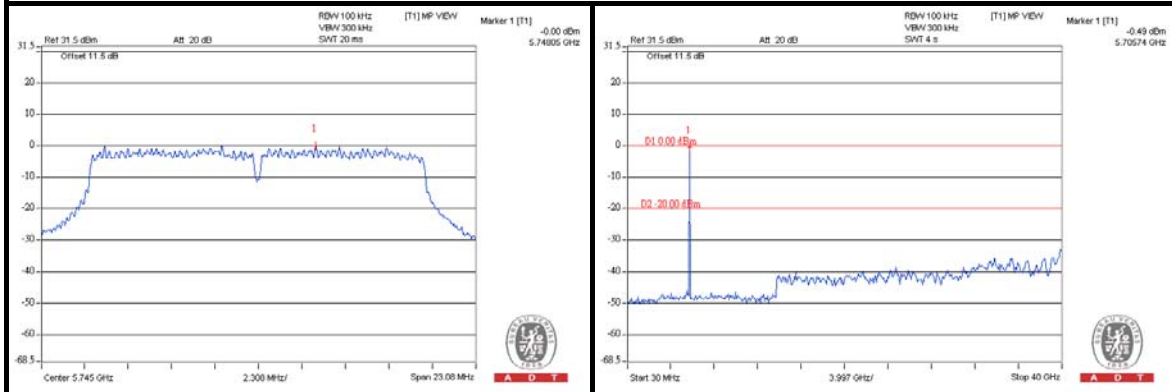

#### CH 157

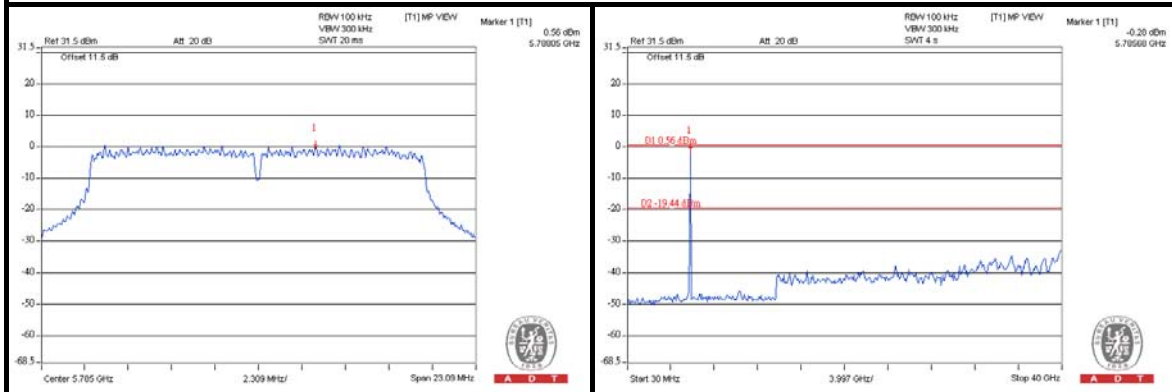

#### CH 165

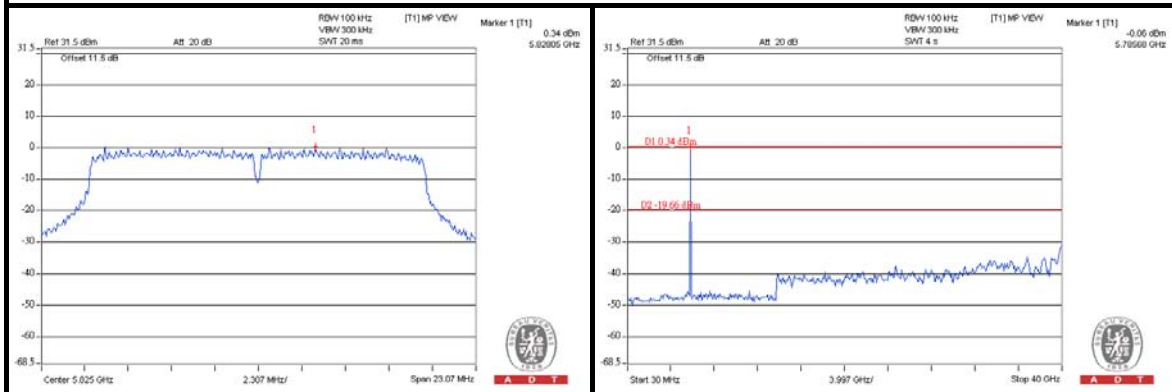



A D T

## 802.11n(40MHz)

### CH 151

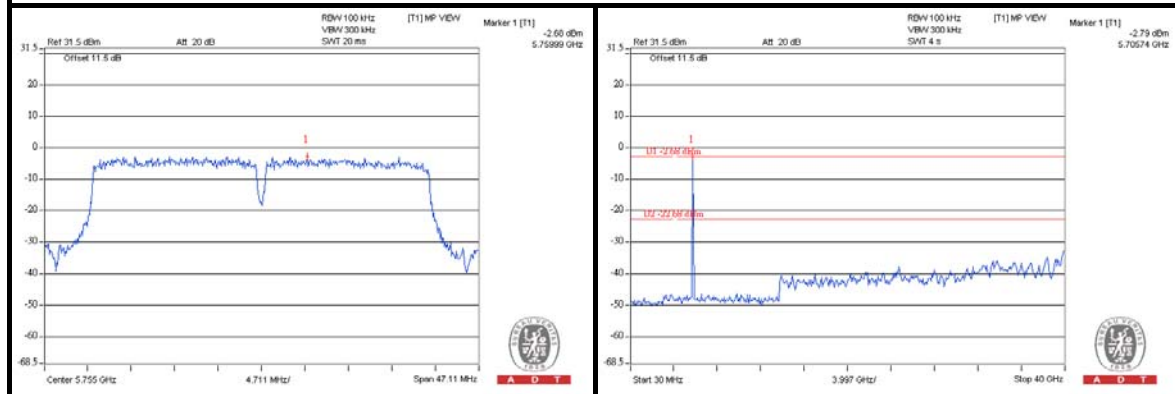

### CH 159

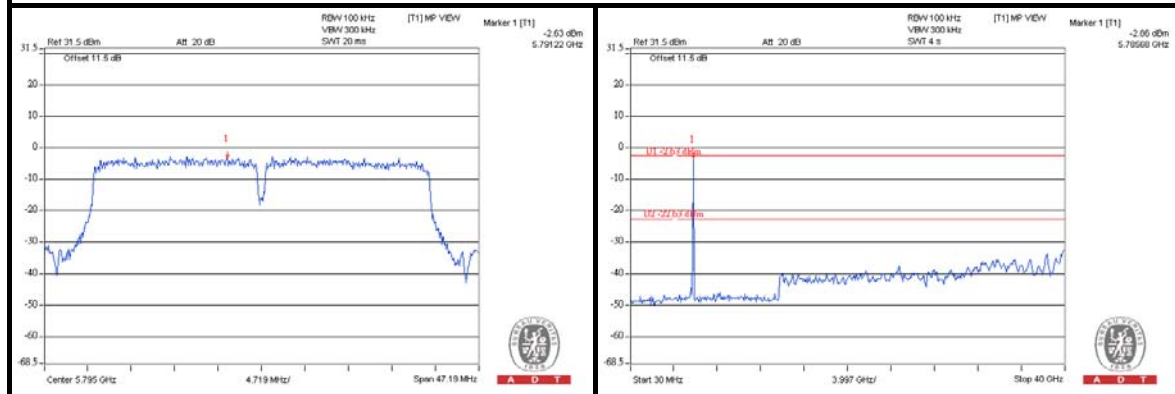



A D T

## 6. PHOTOGRAPHS OF THE TEST CONFIGURATION

Please refer to the attached file (Test Setup Photo).





A D T

## 7. INFORMATION ON THE TESTING LABORATORIES

We, Bureau Veritas Consumer Products Services (H.K.) Ltd., Taoyuan Branch, were founded in 1988 to provide our best service in EMC, Radio, Telecom and Safety consultation. Our laboratories are accredited and approved according to ISO/IEC 17025.

Copies of accreditation and authorization certificates of our laboratories obtained from approval agencies can be downloaded from our web site: [www.adt.com.tw/index.5.phtml](http://www.adt.com.tw/index.5.phtml).

If you have any comments, please feel free to contact us at the following:

**Linko EMC/RF Lab**

Tel: 886-2-26052180

Fax: 886-2-26051924

**Hsin Chu EMC/RF Lab**

Tel: 886-3-5935343

Fax: 886-3-5935342

**Hwa Ya EMC/RF/Safety/Telecom Lab**

Tel: 886-3-3183232

Fax: 886-3-3185050

**Email:** [service.adt@tw.bureauveritas.com](mailto:service.adt@tw.bureauveritas.com)

**Web Site:** [www.adt.com.tw](http://www.adt.com.tw)

The address and road map of all our labs can be found in our web site also.



A D T

## **8. APPENDIX A - MODIFICATIONS RECORDERS FOR ENGINEERING CHANGES TO THE EUT BY THE LAB**

No modifications were made to the EUT by the lab during the test.

**---END---**