



FCC TEST REPORT (15.247)

REPORT NO.: RF130328E02A

MODEL NO.: TEW-750DAP

FCC ID: XU8TEW750DAP

RECEIVED: Mar. 28, 2013

TESTED: Apr. 08 to 11, 2013

ISSUED: June 06, 2013

APPLICANT: TRENDnet, Inc

ADDRESS: 20675 Manhattan Place, Torrance, CA 90501
U.S.A.

ISSUED BY: Bureau Veritas Consumer Products Services
(H.K.) Ltd., Taoyuan Branch Hsin Chu Laboratory

LAB ADDRESS : No. 81-1, Lu Liao Keng, 9th Ling, Wu Lung Tsuen,
Chiung Lin Hsiang, Hsin Chu Hsien 307, Taiwan,
R.O.C.

TEST LOCATION (1): No. 81-1, Lu Liao Keng, 9th Ling, Wu Lung Tsuen,
Chiung Lin Hsiang, Hsin Chu Hsien 307, Taiwan,
R.O.C.

TEST LOCATION (2): No. 49, Ln. 206, Wende Rd., Shangshan Tsuen,
Chiung Lin Hsiang, Hsin Chu Hsien 307, Taiwan,
R.O.C.

This report should not be used by the client to claim product certification, approval, or endorsement by TAF or any government agencies.



This report is for your exclusive use. Any copying or replication of this report to or for any other person or entity, or use of our name or trademark, is permitted only with our prior written permission. This report sets forth our findings solely with respect to the test samples identified herein. The results set forth in this report are not indicative or representative of the quality or characteristics of the lot from which a test sample was taken or any similar or identical product unless specifically and expressly noted. Our report includes all of the tests requested by you and the results thereof based upon the information that you provided to us. You have 60 days from date of issuance of this report to notify us of any material error or omission caused by our negligence, provided, however, that such notice shall be in writing and shall specifically address the issue you wish to raise. A failure to raise such issue within the prescribed time shall constitute your unqualified acceptance of the completeness of this report, the tests conducted and the correctness of the report contents. Unless specific mention, the uncertainty of measurement has been explicitly taken into account to declare the compliance or non-compliance to the specification



A D T

Table of Contents

RELEASE CONTROL RECORD	5
1. CERTIFICATION	6
2. SUMMARY OF TEST RESULTS	7
2.1 MEASUREMENT UNCERTAINTY	8
3. GENERAL INFORMATION	9
3.1 GENERAL DESCRIPTION OF EUT	9
3.2 DESCRIPTION OF TEST MODES	12
3.2.1 TEST MODE APPLICABILITY AND TESTED CHANNEL DETAIL	13
3.3 GENERAL DESCRIPTION OF APPLIED STANDARDS	16
3.4 DESCRIPTION OF SUPPORT UNITS	17
3.5 CONFIGURATION OF SYSTEM UNDER TEST	18
4. TEST TYPES AND RESULTS (FOR 2.4GHz, 2.400 ~ 2.4835GHz Band)	19
4.1 CONDUCTED EMISSION MEASUREMENT	19
4.1.1 LIMITS OF CONDUCTED EMISSION MEASUREMENT	19
4.1.2 TEST INSTRUMENTS	19
4.1.3 TEST PROCEDURES	20
4.1.4 DEVIATION FROM TEST STANDARD	20
4.1.5 TEST SETUP	20
4.1.6 EUT OPERATING CONDITIONS	21
4.1.7 TEST RESULTS	22
4.2 RADIATED EMISSION AND BANDEDGE MEASUREMENT	26
4.2.1 LIMITS OF RADIATED EMISSION AND BANDEDGE MEASUREMENT	26
4.2.2 TEST INSTRUMENTS	27
4.2.3 TEST PROCEDURES	28
4.2.4 DEVIATION FROM TEST STANDARD	28
4.2.5 TEST SETUP	29
4.2.6 EUT OPERATING CONDITIONS	29
4.2.7 TEST RESULTS	30
4.3 6dB BANDWIDTH MEASUREMENT	43
4.3.1 LIMITS OF 6dB BANDWIDTH MEASUREMENT	43
4.3.2 TEST INSTRUMENTS	43
4.3.3 TEST PROCEDURE	43
4.3.4 DEVIATION FROM TEST STANDARD	43
4.3.5 TEST SETUP	43
4.3.6 EUT OPERATING CONDITIONS	43
4.3.7 TEST RESULTS	44
4.4 CONDUCTED OUTPUT POWER MEASUREMENT	45
4.4.1 LIMITS OF MAXIMUM PEAK OUTPUT POWER MEASUREMENT	45
4.4.2 INSTRUMENTS	45
4.4.3 TEST PROCEDURES	45
4.4.4 DEVIATION FROM TEST STANDARD	45
4.4.5 TEST SETUP	45
4.4.6 EUT OPERATING CONDITIONS	46
4.4.7 TEST RESULTS	47
4.5 POWER SPECTRAL DENSITY MEASUREMENT	50
4.5.1 LIMITS OF POWER SPECTRAL DENSITY MEASUREMENT	50
4.5.2 TEST INSTRUMENTS	50
4.5.3 TEST PROCEDURE	50
4.5.4 DEVIATION FROM TEST STANDARD	50
4.5.5 TEST SETUP	50



4.5.6	EUT OPERATING CONDITION.....	50
4.5.7	TEST RESULTS.....	51
4.6	CONDUCTED OUT-BAND EMISSION MEASUREMENT.....	52
4.6.1	LIMITS OF CONDUCTED OUT-BAND EMISSION MEASUREMENT.....	52
4.6.2	TEST INSTRUMENTS.....	52
4.6.3	TEST PROCEDURE.....	52
4.6.4	DEVIATION FROM TEST STANDARD.....	53
4.6.5	TEST SETUP.....	53
4.6.6	EUT OPERATING CONDITION.....	53
4.6.7	TEST RESULTS.....	53
5.	TEST TYPES AND RESULTS (FOR 5gHz, 5.725~5.850GHz Band).....	60
5.1	CONDUCTED EMISSION MEASUREMENT.....	60
5.1.1	LIMITS OF CONDUCTED EMISSION MEASUREMENT.....	60
5.1.2	TEST INSTRUMENTS.....	60
5.1.3	TEST PROCEDURES.....	61
5.1.4	DEVIATION FROM TEST STANDARD.....	61
5.1.5	TEST SETUP.....	61
5.1.6	EUT OPERATING CONDITIONS.....	62
5.1.7	TEST RESULTS.....	63
5.2	RADIATED AND BANDEDGE EMISSION MEASUREMENT.....	67
5.2.1	LIMITS OF RADIATED AND BANDEDGE EMISSION MEASUREMENT.....	67
5.2.2	TEST INSTRUMENTS.....	68
5.2.3	TEST PROCEDURES.....	69
5.2.4	DEVIATION FROM TEST STANDARD.....	69
5.2.5	TEST SETUP.....	70
5.2.6	EUT OPERATING CONDITIONS.....	70
5.2.7	TEST RESULTS.....	71
5.3	6dB BANDWIDTH MEASUREMENT.....	80
5.3.1	LIMITS OF 6dB BANDWIDTH MEASUREMENT.....	80
5.3.2	TEST INSTRUMENTS.....	80
5.3.3	TEST PROCEDURE.....	80
5.3.4	DEVIATION FROM TEST STANDARD.....	80
5.3.5	TEST SETUP.....	80
5.3.6	EUT OPERATING CONDITIONS.....	80
5.3.7	TEST RESULTS.....	81
5.4	CONDUCTED OUTPUT POWER MEASUREMENT.....	82
5.4.1	LIMITS OF CONDUCTED OUTPUT POWER MEASUREMENT.....	82
5.4.2	INSTRUMENTS.....	82
5.4.3	TEST PROCEDURES.....	82
5.4.4	DEVIATION FROM TEST STANDARD.....	82
5.4.5	TEST SETUP.....	82
5.4.6	EUT OPERATING CONDITIONS.....	82
5.4.7	TEST RESULTS.....	84
5.5	POWER SPECTRAL DENSITY MEASUREMENT.....	87
5.5.1	LIMITS OF POWER SPECTRAL DENSITY MEASUREMENT.....	87
5.5.2	TEST INSTRUMENTS.....	87
5.5.3	TEST PROCEDURE.....	87
5.5.4	DEVIATION FROM TEST STANDARD.....	87
5.5.5	TEST SETUP.....	87
5.5.6	EUT OPERATING CONDITION.....	87
5.5.7	TEST RESULTS.....	88
5.6	CONDUCTED OUT-BAND EMISSION MEASUREMENT.....	89



A D T

5.6.1	LIMITS OF CONDUCTED OUT-BAND EMISSION MEASUREMENT.....	89
5.6.2	TEST INSTRUMENTS.....	89
5.6.3	TEST PROCEDURE.....	89
5.6.4	DEVIATION FROM TEST STANDARD.....	90
5.6.5	TEST SETUP	90
5.6.6	EUT OPERATING CONDITION.....	90
5.6.7	TEST RESULTS	90
6.	PHOTOGRAPHS OF THE TEST CONFIGURATION.....	96
7.	INFORMATION ON THE TESTING LABORATORIES	97
8.	APPENDIX A - MODIFICATIONS RECORDERS FOR ENGINEERING CHANGES TO THE EUT BY THE LAB.....	98



A D T

RELEASE CONTROL RECORD

ISSUE NO.	REASON FOR CHANGE	DATE ISSUED
RF130328E02A	Original release	June 06, 2013



A D T

1. CERTIFICATION

PRODUCT: N600 Dual Band Wireless Access Point
BRAND NAME: TRENDnet
MODEL NO.: TEW-750DAP
TEST SAMPLE: ENGINEERING SAMPLE
APPLICANT: TRENDnet, Inc
TESTED: Apr. 08 to 11, 2013
STANDARDS: FCC Part 15, Subpart C (Section 15.247)
ANSI C63.10-2009

The above equipment (Model: TEW-750DAP) has been tested by **Bureau Veritas Consumer Products Services (H.K.) Ltd., Taoyuan Branch**, and found compliance with the requirement of the above standards. The test record, data evaluation & Equipment Under Test (EUT) configurations represented herein are true and accurate accounts of the measurements of the sample's EMC characteristics under the conditions specified in this report.

PREPARED BY :  , **DATE:** June 06, 2013
(Elsie Hsu, Specialist)

APPROVED BY :  , **DATE:** June 06, 2013
(May Chen, Manager)



A D T

2. SUMMARY OF TEST RESULTS

The EUT has been tested according to the following specifications:

For 2.4GHz, 2400~2483.5MHz Band

APPLIED STANDARD: FCC PART 15, SUBPART C (SECTION 15.247)			
STANDARD SECTION	TEST TYPE	RESULT	REMARK
15.207	AC Power Conducted Emission	PASS	Meet the requirement of limit. Minimum passing margin is -11.65dB at 0.46250MHz
15.247(d) 15.209	Radiated Emissions	PASS	Meet the requirement of limit. Minimum passing margin is -0.5dB at 7386.00MHz & 2390.00MHz
15.247(d)	Band Edge Measurement	PASS	Meet the requirement of limit.
15.247(a)(2)	6dB bandwidth	PASS	Meet the requirement of limit.
15.247(b)	Conducted Output power	PASS	Meet the requirement of limit.
15.247(e)	Power Spectral Density	PASS	Meet the requirement of limit.
15.203	Antenna Requirement	PASS	No antenna connector is used.

For 5GHz, 5725~5850MHz Band

APPLIED STANDARD: FCC PART 15, SUBPART C (SECTION 15.247)			
STANDARD SECTION	TEST TYPE	RESULT	REMARK
15.207	AC Power Conducted Emission	PASS	Meet the requirement of limit. Minimum passing margin is -12.00dB at 0.45859MHz
15.247(d) 15.209	Radiated Emissions	PASS	Meet the requirement of limit. Minimum passing margin is -0.6dB at 5350.00MHz
15.247(d)	Band Edge Measurement	PASS	Meet the requirement of limit.
15.247(a)(2)	6dB bandwidth	PASS	Meet the requirement of limit.
15.247(b)	Conducted Output power	PASS	Meet the requirement of limit.
15.247(e)	Power Spectral Density	PASS	Meet the requirement of limit.
15.203	Antenna Requirement	PASS	Antenna connectors is I-PEX not a standard connector.

NOTE: The EUT was operating in 2.400 ~ 2.4835GHz, 5.15~5.25GHz and 5.725~5.850GHz frequencies band. This report was recorded the RF parameters including 2.400 ~ 2.4835GHz and 5.725~5.850GHz. For the 5.15~5.25GHz RF parameters was recorded in another test report.

2.1 MEASUREMENT UNCERTAINTY

Where relevant, the following measurement uncertainty levels have been estimated for tests performed on the EUT as specified in CISPR 16-4-2:

This uncertainty represents an expanded uncertainty expressed at approximately the 95% confidence level using a coverage factor of $k=2$.

Measurement	Value
Conducted emissions	2.98 dB
Radiated emissions (30MHz-1GHz)	5.59 dB
Radiated emissions (1GHz -6GHz)	3.73 dB
Radiated emissions (6GHz -18GHz)	3.90 dB
Radiated emissions (18GHz -40GHz)	4.11 dB



A D T

3. GENERAL INFORMATION

3.1 GENERAL DESCRIPTION OF EUT

PRODUCT	N600 Dual Band Wireless Access Point
MODEL NO.	TEW-750DAP
POWER SUPPLY	DC 12V from power adapter
MODULATION TYPE	CCK, DQPSK, DBPSK for DSSS 64QAM, 16QAM, QPSK, BPSK for OFDM
MODULATION TECHNOLOGY	DSSS,OFDM
TRANSFER RATE	802.11b: up to 11Mbps 802.11a / g: up to 54Mbps 802.11n: up to 300Mbps
OPERATING FREQUENCY	For 15.407 802.11a/n: 5.18 ~ 5.24GHz
	For 15.247 802.11b/g/n: 2.412 ~ 2.462GHz 802.11a/n: 5.745 ~ 5.825GHz
NUMBER OF CHANNEL	For 15.407 4 for 802.11a, 802.11n (HT20) 2 for 802.11n (HT40)
	For 15.247 (2.4GHz) 11 for 802.11b, 802.11g, 802.11n (HT20) 7 for 802.11n (HT40) For 15.247 (5GHz) 5 for 802.11a, 802.11n (HT20) 2 for 802.11n (HT40)

MAXIMUM OUTPUT POWER	<p>For 15.407</p> <p>802.11a: 37.931mW 802.11n (HT20): 30.729mW 802.11n (HT40): 43.860mW</p> <p>For 15.247 (2.4GHz)</p> <p>802.11b: 188.799mW 802.11g: 268.534mW 802.11n (HT20): 475.999mW 802.11n (HT40): 274.533mW</p> <p>For 15.247 (5GHz)</p> <p>802.11a: 359.749mW 802.11n (HT20): 700.492mW 802.11n (HT40): 654.822mW</p>
ANTENNA TYPE	Please see NOTE
DATA CABLE	NA
I/O PORTS	Refer to user's manual
ASSOCIATED DEVICES	Adapter x 1

NOTE:

- The EUT must be supplied with a power adapter and following two different model names could be chosen:

No.	Brand	Model No.	Spec.
1	LEI	MU12AB120100-A1	Input: 100-240V, 0.4A, 50-60Hz Output: 12V, 1A DC output cable(1.2m, unshielded)
2	AMIGO	AMS9-1201000FC2	Input: 100-240V, 0.5A, 50-60Hz Output: 12V, 1A DC output cable(1.2m, unshielded)

- The EUT was pre-tested for radiated test under following test modes:

Pre-test Mode	Power
Mode A	With adapter 1
Mode B	With adapter 2

From the above modes, the worst radiated test was found in **Mode B**. Therefore only the test data of the mode was recorded in this report.

3. The antennas provided to the EUT, please refer to the following table:

For 2.4GHz								
Transmitter Circuit	Brand	Model name	Gain (dBi) Include cable loss	Antenna Type	Connector	Frequency range (MHz to MHz)	Cable Loss (dB)	Cable Length (cm)
Chain (0)	NA	NA	0.02	printing	NA	2400~2500	NA	NA
Chain (1)	NA	NA	1.12	printing	NA	2400~2500	NA	NA
For 5GHz								
Transmitter Circuit	Brand	Model name	Gain (dBi) Include cable loss	Antenna Type	Connector	Frequency range (MHz to MHz)	Cable Loss (dB)	Cable Length (cm)
Chain (0)	MAG.LA YERS	PCA-2010-5 G0C1-A8	4.86	FR4 assembly	I-PEX	5150~5850	0.21	6.35
Chain (1)	MAG.LA YERS	PCA-2010-5 G0C1-A7	4.55	FR4 assembly	I-PEX	5150~5850	0.26	7.75

Note: For 802.11bg mode will fix transmission on Chain (0).

4. The EUT incorporates a MIMO function without beam forming.

MODULATION MODE	TX/RX FUNCTION
802.11a	1TX/1RX
802.11b	1TX/1RX
802.11g	1TX/1RX
802.11n (HT20)	2TX/2RX
802.11n (HT40)	2TX/2RX

5. Conducted emission and radiated emission of the simultaneous operation (2.4GHz & 5GHz) has been evaluated and no non-compliance was found.

6. When the EUT operating in 802.11n, the software operation, which is defined by manufacturer, MCS (Modulation and Coding Schemes) from 0 to 15.

7. The above EUT information was declared by the manufacturer and for more detailed features description, please refer to the manufacturer's specifications or User's Manual.



A D T

3.2 DESCRIPTION OF TEST MODES

Operated in 2400 ~ 2483.5MHz band:

11 channels are provided for 802.11b, 802.11g, 802.11n (HT20):

CHANNEL	FREQUENCY	CHANNEL	FREQUENCY
1	2412MHz	7	2442MHz
2	2417MHz	8	2447MHz
3	2422MHz	9	2452MHz
4	2427MHz	10	2457MHz
5	2432MHz	11	2462MHz
6	2437MHz		

7 channels are provided for 802.11n (HT40):

CHANNEL	FREQUENCY	CHANNEL	FREQUENCY
3	2422MHz	7	2442MHz
4	2427MHz	8	2447MHz
5	2432MHz	9	2452MHz
6	2437MHz		

Operated in 5725 ~ 5850MHz band:

5 channels are provided for 802.11a, 802.11n (HT20):

CHANNEL	FREQUENCY	CHANNEL	FREQUENCY
149	5745 MHz	161	5805 MHz
153	5765 MHz	165	5825 MHz
157	5785 MHz		

2 channels are provided for 802.11n (HT40):

CHANNEL	FREQUENCY
151	5755 MHz
159	5795 MHz

3.2.1 TEST MODE APPLICABILITY AND TESTED CHANNEL DETAIL

EUT CONFIGURE MODE	APPLICABLE TO					DESCRIPTION
	PLC	RE < 1G	RE ≥ 1G	APCM	OB	
1	√	√	√	√	√	With power adapter 2
2	√	-	-	-	-	With power adapter 1

Where **PLC**: Power Line Conducted Emission **RE < 1G**: Radiated Emission below 1GHz
RE ≥ 1G: Radiated Emission above 1GHz **APCM**: Antenna Port Conducted Measurement
OB: Conducted Out-Band Emission Measurement

POWER LINE CONDUCTED EMISSION TEST:

- Pre-Scan has been conducted to determine the worst-case mode from all possible combinations between available modulations, data rates and antenna ports (if EUT with antenna diversity architecture).
- Following channel(s) was (were) selected for the final test as listed below.

MODE	AVAILABLE CHANNEL	TESTED CHANNEL	MODULATION TECHNOLOGY	MODULATION TYPE	DATA RATE (Mbps)
For 2.4 GHz 802.11n (HT20)	1 to 11	6	OFDM	BPSK	6.5
For 5 GHz 802.11n (HT20)	149 to 165	165	OFDM	BPSK	6.5

RADIATED EMISSION TEST (BELOW 1 GHz):

- Pre-Scan has been conducted to determine the worst-case mode from all possible combinations between available modulations, data rates and antenna ports (if EUT with antenna diversity architecture).
- Following channel(s) was (were) selected for the final test as listed below.

MODE	AVAILABLE CHANNEL	TESTED CHANNEL	MODULATION TECHNOLOGY	MODULATION TYPE	DATA RATE (Mbps)
For 2.4 GHz 802.11n (HT20)	1 to 11	6	OFDM	BPSK	6.5
For 5 GHz 802.11n (HT20)	149 to 165	165	OFDM	BPSK	6.5



A D T

RADIATED EMISSION TEST (ABOVE 1 GHz):

- Pre-Scan has been conducted to determine the worst-case mode from all possible combinations between available modulations, data rates and antenna ports (if EUT with antenna diversity architecture).
- Following channel(s) was (were) selected for the final test as listed below.

MODE	AVAILABLE CHANNEL	TESTED CHANNEL	MODULATION TECHNOLOGY	MODULATION TYPE	DATA RATE (Mbps)
802.11b	1 to 11	1, 6, 11	DSSS	DBPSK	1
802.11g	1 to 11	1, 6, 11	OFDM	BPSK	6
For 2.4 GHz 802.11n (HT20)	1 to 11	1, 6, 11	OFDM	BPSK	6.5
For 2.4 GHz 802.11n (HT40)	3 to 9	3, 6, 9	OFDM	BPSK	13.5
802.11a	149 to 165	149, 157, 165	OFDM	BPSK	6
For 5 GHz 802.11n (HT20)	149 to 165	149, 157, 165	OFDM	BPSK	6.5
For 5 GHz 802.11n (HT40)	151 to 159	151, 159	OFDM	BPSK	13.5

ANTENNA PORT CONDUCTED MEASUREMENT:

- Pre-Scan has been conducted to determine the worst-case mode from all possible combinations between available modulations, data rates and antenna ports (if EUT with antenna diversity architecture).
- Following channel(s) was (were) selected for the final test as listed below.

MODE	AVAILABLE CHANNEL	TESTED CHANNEL	MODULATION TECHNOLOGY	MODULATION TYPE	DATA RATE (Mbps)
802.11b	1 to 11	1, 6, 11	DSSS	DBPSK	1
802.11g	1 to 11	1, 6, 11	OFDM	BPSK	6
For 2.4 GHz 802.11n (HT20)	1 to 11	1, 6, 11	OFDM	BPSK	6.5
For 2.4 GHz 802.11n (HT40)	3 to 9	3, 6, 9	OFDM	BPSK	13.5
802.11a	149 to 165	149, 157, 165	OFDM	BPSK	6
For 5 GHz 802.11n (HT20)	149 to 165	149, 157, 165	OFDM	BPSK	6.5
For 5 GHz 802.11n (HT40)	151 to 159	151, 159	OFDM	BPSK	13.5



A D T

CONDUCTED OUT-BAND EMISSION MEASUREMENT:

- Pre-Scan has been conducted to determine the worst-case mode from all possible combinations between available modulations, data rates and antenna ports (if EUT with antenna diversity architecture).
- Following channel(s) was (were) selected for the final test as listed below.

MODE	AVAILABLE CHANNEL	TESTED CHANNEL	MODULATION TECHNOLOGY	MODULATION TYPE	DATA RATE (Mbps)
802.11b	1 to 11	1, 6, 11	DSSS	DBPSK	1
802.11g	1 to 11	1, 6, 11	OFDM	BPSK	6
For 2.4 GHz 802.11n (HT20)	1 to 11	1, 6, 11	OFDM	BPSK	6.5
For 2.4 GHz 802.11n (HT40)	3 to 9	3, 6, 9	OFDM	BPSK	13.5
802.11a	149 to 165	149, 157, 165	OFDM	BPSK	6
For 5 GHz 802.11n (HT20)	149 to 165	149, 157, 165	OFDM	BPSK	6.5
For 5 GHz 802.11n (HT40)	151 to 159	151, 159	OFDM	BPSK	13.5

TEST CONDITION:

APPLICABLE TO	ENVIRONMENTAL CONDITIONS	INPUT POWER	TESTED BY
PLC	20deg. C, 70%RH	120Vac, 60Hz	Mike Hsieh
RE<1G	24deg. C, 67%RH	120Vac, 60Hz	Robert Cheng
RE ³ 1G	23deg. C, 70%RH	120Vac, 60Hz	Robert Cheng
APCM	25deg. C, 60%RH	120Vac, 60Hz	James Chan
OB	25deg. C, 60%RH	120Vac, 60Hz	James Chan

3.3 GENERAL DESCRIPTION OF APPLIED STANDARDS

The EUT is a RF product. According to the specifications of the manufacturer, it must comply with the requirements of the following standards:

FCC Part 15, Subpart C. (15.247)

558074 D01 DTS Meas Guidance v03r01

662911 D01 Multiple Transmitter Output v01 r02

ANSI C63.10-2009

All test items have been performed and recorded as per the above standards.

Note: The EUT has been verified to comply with the requirements of FCC Part 15, Subpart B, Class B (DoC). The test report has been issued separately.



A D T

3.4 DESCRIPTION OF SUPPORT UNITS

The EUT has been tested as an independent unit together with other necessary accessories or support units. The following support units or accessories were used to form a representative test configuration during the tests.

NO.	PRODUCT	BRAND	MODEL NO.	SERIAL NO.	FCC ID
1	NOTEBOOK COMPUTER	DELL	PP32LA	FSLB32S	FCC DoC
2	HUB	ZyXEL	ES-116P	S060H02000215	FCC DoC

NO.	SIGNAL CABLE DESCRIPTION OF THE ABOVE SUPPORT UNITS
1	UTP cable (10m)
2	UTP cable (10m)

NOTE: All power cords of the above support units are non shielded (1.8m).

3.5 CONFIGURATION OF SYSTEM UNDER TEST

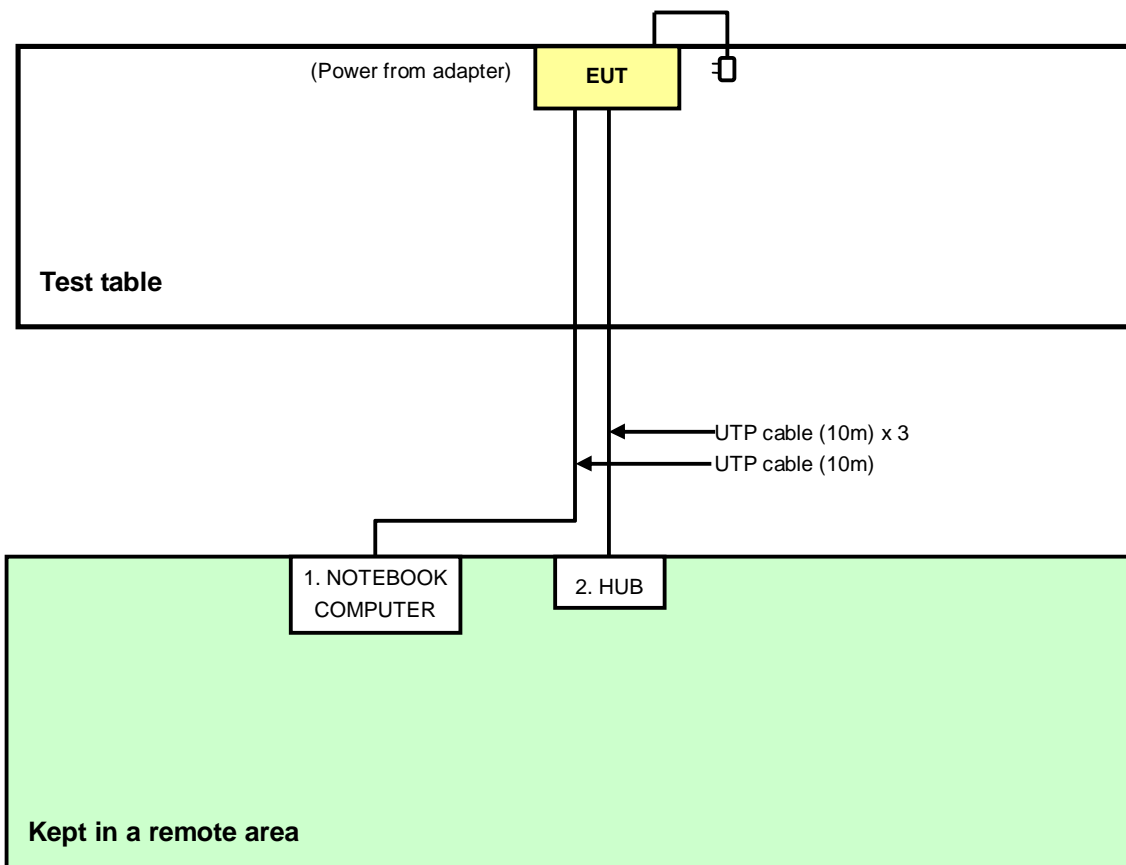

4. TEST TYPES AND RESULTS (FOR 2.4GHz, 2.400 ~ 2.4835GHz Band)

4.1 CONDUCTED EMISSION MEASUREMENT

4.1.1 LIMITS OF CONDUCTED EMISSION MEASUREMENT

FREQUENCY OF EMISSION (MHz)	CONDUCTED LIMIT (dB μ V)	
	Quasi-peak	Average
0.15-0.5	66 to 56	56 to 46
0.5-5	56	46
5-30	60	50

- NOTE:**
1. The lower limit shall apply at the transition frequencies.
 2. The limit decreases in line with the logarithm of the frequency in the range of 0.15 to 0.50 MHz.

4.1.2 TEST INSTRUMENTS

DESCRIPTION & MANUFACTURER	MODEL NO.	SERIAL NO.	CALIBRATED DATE	CALIBRATED UNTIL
Test Receiver	ESCS 30	100375	Mar.11, 2013	Mar.10, 2014
Line-Impedance Stabilization Network (for EUT) SCHWARZBECK	NSLK8127	8127-522	Sep. 06, 2012	Sep. 05, 2013
Line-Impedance Stabilization Network (for Peripheral)	ENV216	100072	June 08,2012	June 07,2013
RF Cable (JYBAO)	5DFB	COCCAB-001	Aug. 28, 2012	Aug. 27, 2013
50 ohms Terminator	50	EMC-3	Sep. 25, 2012	Sep. 24, 2013
Software ADT	BV ADT_Cond_V7.3.7.3	NA	NA	NA

Note:

1. The calibration interval of the above test instruments is 12 months and the calibrations are traceable to NML/ROC and NIST/USA.
2. The test was performed in Shielded Room No. C.
3. The VCCI Con C Registration No. is C-3611.
4. Tested Date: Apr. 11, 2013

4.1.3 TEST PROCEDURES

- a. The EUT was placed 0.4 meters from the conducting wall of the shielded room with EUT being connected to the power mains through a line impedance stabilization network (LISN). Other support units were connected to the power mains through another LISN.
- b. The two LISNs provide 50 ohm/ 50uH of coupling impedance for the measuring instrument.
- c. Both lines of the power mains connected to the EUT were checked for maximum conducted interference.
- d. The frequency range from 150kHz to 30MHz was searched. Emission levels under (Limit - 20dB) were not recorded.

NOTE:

1. The resolution bandwidth of test receiver is 9kHz for Quasi-peak detection (QP) & Average detection (AV).

4.1.4 DEVIATION FROM TEST STANDARD

No deviation

4.1.5 TEST SETUP

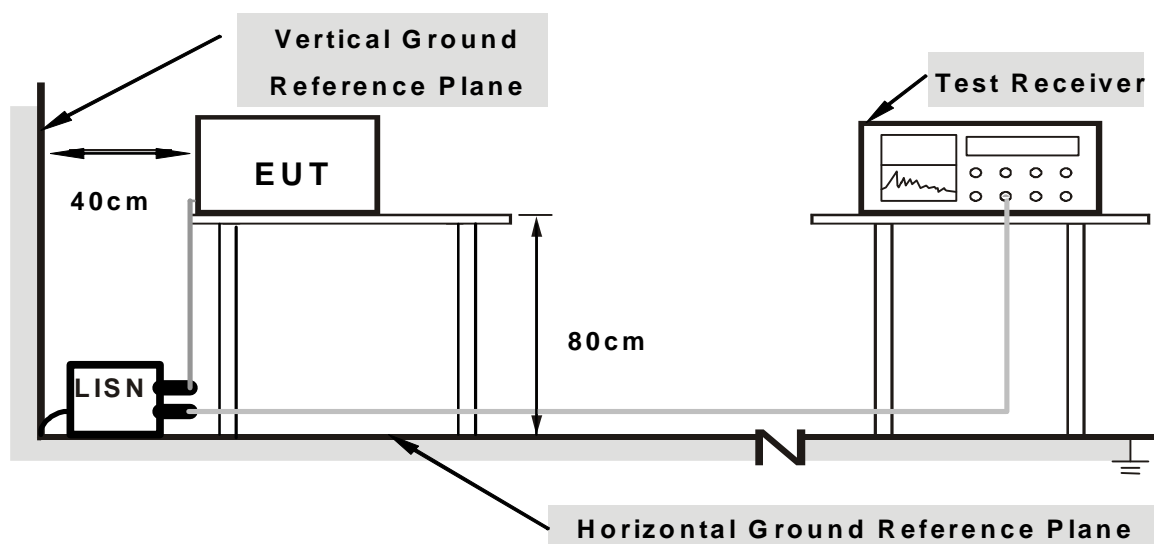

Note: 1.Support units were connected to second LISN.

For the actual test configuration, please refer to the related item – Photographs of the Test Configuration.

4.1.6 EUT OPERATING CONDITIONS

1. Turn on the power of EUT.
2. The communication partner run test program “MT7620QA.exe” to enable EUT under transmission/receiving condition continuously at specific channel frequency.

4.1.7 TEST RESULTS (MODE 1)

PHASE	Line (L)	DETECTOR FUNCTION	Quasi-Peak (QP) / Average (AV)
-------	----------	-------------------	--------------------------------

No	Freq. [MHz]	Corr. Factor (dB)	Reading Value [dB (uV)]		Emission Level [dB (uV)]		Limit [dB (uV)]		Margin (dB)	
			Q.P.	AV.	Q.P.	AV.	Q.P.	AV.	Q.P.	AV.
	1	0.18906	0.11	41.96	34.40	42.07	34.51	64.08	54.08	-22.01
2	0.23594	0.11	40.52	30.82	40.63	30.93	62.24	52.24	-21.60	-21.30
3	0.46250	0.13	40.98	34.86	41.11	34.99	56.65	46.65	-15.53	-11.65
4	0.88047	0.16	37.95	29.65	38.11	29.81	56.00	46.00	-17.89	-16.19
5	1.98022	0.21	36.55	24.89	36.76	25.10	56.00	46.00	-19.24	-20.90
6	5.07422	0.38	34.77	22.71	35.15	23.09	60.00	50.00	-24.85	-26.91
7	17.69531	0.90	34.65	29.73	35.55	30.63	60.00	50.00	-24.45	-19.37

REMARKS:

1. Q.P. and AV. are abbreviations of quasi-peak and average individually.
2. The emission levels of other frequencies were very low against the limit.
3. Margin value = Emission level - Limit value
4. Correction factor = Insertion loss + Cable loss
5. Emission Level = Correction Factor + Reading Value.

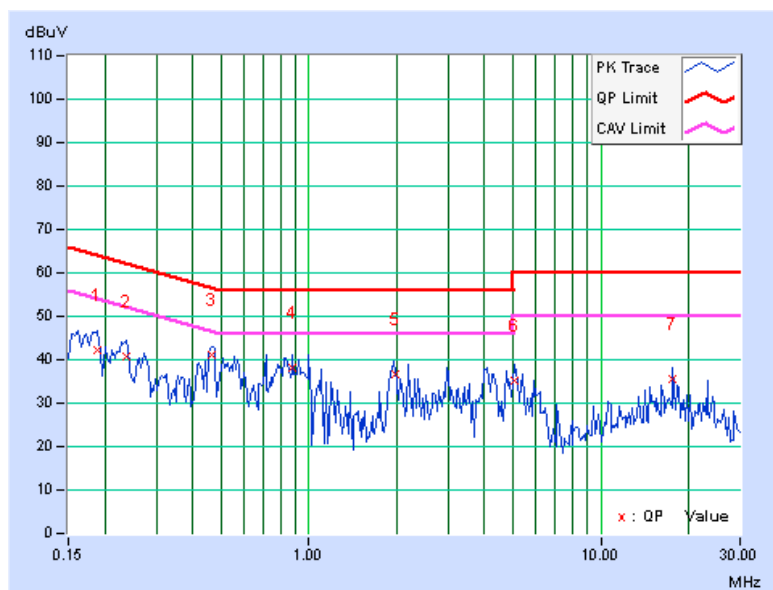

PHASE	Neutral (N)	DETECTOR FUNCTION	Quasi-Peak (QP) / Average (AV)
--------------	-------------	--------------------------	--------------------------------

No	Freq. [MHz]	Corr. Factor (dB)	Reading Value [dB (uV)]		Emission Level [dB (uV)]		Limit [dB (uV)]		Margin (dB)	
			Q.P.	AV.	Q.P.	AV.	Q.P.	AV.	Q.P.	AV.
	1	0.18647	0.09	44.71	36.01	44.80	36.10	64.19	54.19	-19.40
2	0.45469	0.12	36.23	26.56	36.35	26.68	56.79	46.79	-20.44	-20.11
3	0.90781	0.15	33.68	18.23	33.83	18.38	56.00	46.00	-22.17	-27.62
4	1.95703	0.19	30.37	16.49	30.56	16.68	56.00	46.00	-25.44	-29.32
5	3.35938	0.26	26.45	13.31	26.71	13.57	56.00	46.00	-29.29	-32.43
6	17.69531	0.63	31.20	27.88	31.83	28.51	60.00	50.00	-28.17	-21.49

REMARKS:

1. Q.P. and AV. are abbreviations of quasi-peak and average individually.
2. The emission levels of other frequencies were very low against the limit.
3. Margin value = Emission level - Limit value
4. Correction factor = Insertion loss + Cable loss
5. Emission Level = Correction Factor + Reading Value.

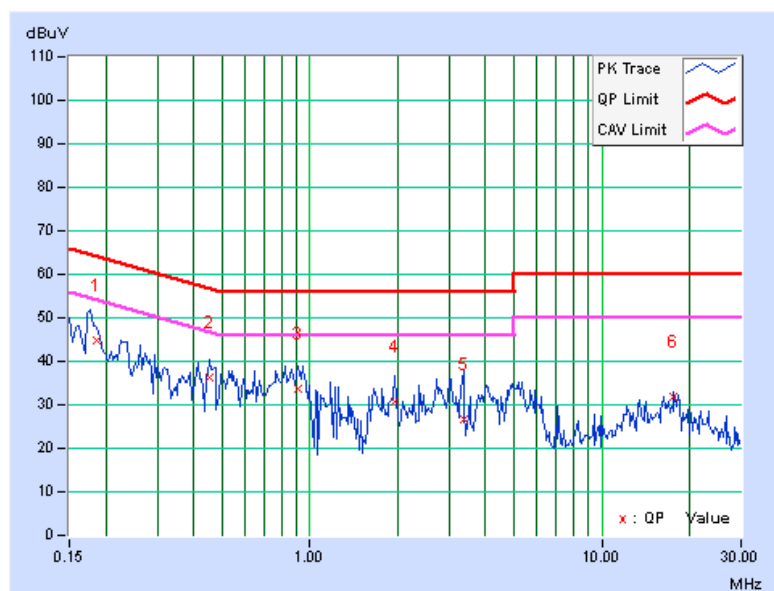

4.1.8 TEST RESULTS (MODE 2)

PHASE	Line (L)	DETECTOR FUNCTION	Quasi-Peak (QP) / Average (AV)
--------------	----------	--------------------------	--------------------------------

No	Freq. [MHz]	Corr. Factor (dB)	Reading Value [dB (uV)]		Emission Level [dB (uV)]		Limit [dB (uV)]		Margin (dB)	
			Q.P.	AV.	Q.P.	AV.	Q.P.	AV.	Q.P.	AV.
			1	0.15781	0.10	45.15	37.48	45.25	37.58	65.58
2	0.23594	0.11	36.91	27.66	37.02	27.77	62.24	52.24	-25.21	-24.46
3	0.88828	0.16	23.63	13.81	23.79	13.97	56.00	46.00	-32.21	-32.03
4	2.62891	0.25	27.94	20.51	28.19	20.76	56.00	46.00	-27.81	-25.24
5	5.90625	0.42	36.53	32.95	36.95	33.37	60.00	50.00	-23.05	-16.63
6	16.22656	0.84	34.04	28.98	34.88	29.82	60.00	50.00	-25.12	-20.18

REMARKS:

1. Q.P. and AV. are abbreviations of quasi-peak and average individually.
2. The emission levels of other frequencies were very low against the limit.
3. Margin value = Emission level - Limit value
4. Correction factor = Insertion loss + Cable loss
5. Emission Level = Correction Factor + Reading Value.

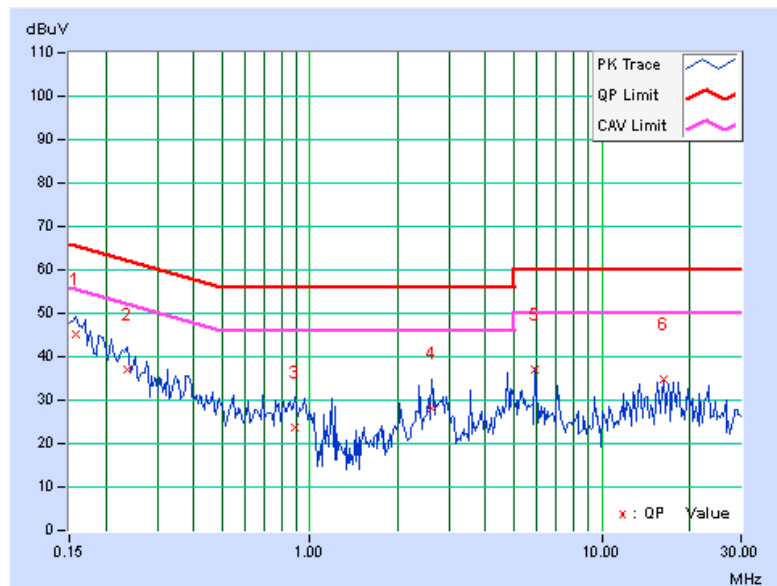

PHASE	Neutral (N)	DETECTOR FUNCTION	Quasi-Peak (QP) / Average (AV)
--------------	-------------	--------------------------	--------------------------------

No	Freq. [MHz]	Corr. Factor (dB)	Reading Value [dB (uV)]		Emission Level [dB (uV)]		Limit [dB (uV)]		Margin (dB)	
			Q.P.	AV.	Q.P.	AV.	Q.P.	AV.	Q.P.	AV.
	1	0.16172	0.08	40.43	26.39	40.51	26.47	65.38	55.38	-24.86
2	0.22812	0.09	39.39	31.00	39.48	31.09	62.52	52.52	-23.03	-21.42
3	0.34531	0.11	31.87	23.55	31.98	23.66	59.07	49.07	-27.09	-25.41
4	2.82031	0.24	23.20	14.73	23.44	14.97	56.00	46.00	-32.56	-31.03
5	5.90625	0.35	32.29	26.77	32.64	27.12	60.00	50.00	-27.36	-22.88
6	26.48438	0.83	22.45	14.80	23.28	15.63	60.00	50.00	-36.72	-34.37

REMARKS:

1. Q.P. and AV. are abbreviations of quasi-peak and average individually.
2. The emission levels of other frequencies were very low against the limit.
3. Margin value = Emission level - Limit value
4. Correction factor = Insertion loss + Cable loss
5. Emission Level = Correction Factor + Reading Value.

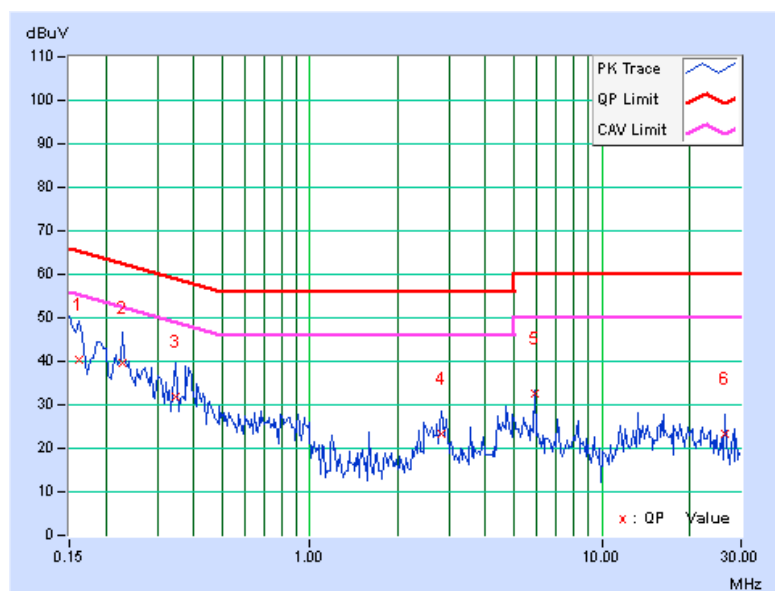

4.2 RADIATED EMISSION AND BANDEGE MEASUREMENT

4.2.1 LIMITS OF RADIATED EMISSION AND BANDEGE MEASUREMENT

Radiated emissions which fall in the restricted bands must comply with the radiated emission limits specified as below table. Other emissions shall be at least 30dB below the highest level of the desired power:

Frequencies (MHz)	Field strength (microvolts/meter)	Measurement distance (meters)
0.009-0.490	2400/F(kHz)	300
0.490-1.705	24000/F(kHz)	30
1.705-30.0	30	30
30-88	100	3
88-216	150	3
216-960	200	3
Above 960	500	3

NOTE:

1. The lower limit shall apply at the transition frequencies.
2. Emission level (dBuV/m) = 20 log Emission level (uV/m).
3. For frequencies above 1000MHz, the field strength limits are based on average detector, however, the peak field strength of any emission shall not exceed the maximum permitted average limits, specified above by more than 20dB under any condition of modulation.



A D T

4.2.2 TEST INSTRUMENTS

DESCRIPTION & MANUFACTURER	MODEL NO.	SERIAL NO.	CALIBRATED DATE	CALIBRATED UNTIL
Spectrum Analyzer Agilent	E4446A	MY48250253	Sep. 03, 2012	Sep. 02, 2013
MXE EMI Receiver Agilent	N9038A	MY51210105	Jan. 29, 2013	Jan. 28, 2014
Pre-Amplifier Mini-Circuits	ZFL-1000VH2 B	AMP-ZFL-03	Nov. 14, 2012	Nov. 13, 2013
Pre-Amplifier Agilent	8449B	3008A02578	June 26, 2012	June 25, 2013
Pre-Amplifier SPACEK LABS	SLKKa-48-6	9K16	Nov. 14, 2012	Nov. 13, 2013
Trilog Broadband Antenna SCHWARZBECK	VULB 9168	9168-360	Mar. 19, 2013	Mar. 18, 2014
Horn_Antenna AISI	AIH.8018	0000320091110	Nov. 19, 2012	Nov. 18, 2013
Horn_Antenna SCHWARZBECK	BBHA 9170	9170-424	Oct. 12, 2012	Oct. 11, 2013
RF Cable	NA	RF104-201 RF104-203 RF104-204	Dec. 25, 2012	Dec. 24, 2013
RF Cable	NA	CHGCAB_001	Oct. 06, 2012	Oct. 05, 2013
Software	ADT_Radiated _V8.7.05	NA	NA	NA
Antenna Tower & Turn Table CT	NA	NA	NA	NA

Note:

1. The calibration interval of the above test instruments is 12 months and the calibrations are traceable to NML/ROC and NIST/USA.
2. The horn antenna, preamplifier (model: 8449B) are used only for the measurement of emission frequency above 1GHz if tested.
- 3 The test was performed in 966 Chamber No. G.
4. The FCC Site Registration No. is 966073.
- 5 The VCCI Site Registration No. is G-137.
- 6 The CANADA Site Registration No. is IC 7450H-2.
- 7 Tested Date: Apr. 10, 2013

4.2.3 TEST PROCEDURES

- a. The EUT was placed on the top of a rotating table 0.8 meters above the ground at 3 meter chamber room for test. The table was rotated 360 degrees to determine the position of the highest radiation.
- b. The EUT was set 3 meters away from the interference-receiving antenna, which was mounted on the top of a variable-height antenna tower.
- c. The height of antenna is varied from one meter to four meters above the ground to determine the maximum value of the field strength. Both horizontal and vertical polarizations of the antenna are set to make the measurement.
- d. For each suspected emission, the EUT was arranged to its worst case and then the antenna was tuned to heights from 1 meter to 4 meters and the rotatable table was turned from 0 degrees to 360 degrees to find the maximum reading.
- e. The test-receiver system was set to quasi-peak detect function and specified bandwidth with maximum hold mode when the test frequency is below 1 GHz.
- f. The test-receiver system was set to peak and average detect function and specified bandwidth with maximum hold mode when the test frequency is above 1 GHz. If the peak reading value also meets average limit, measurement with the average detector is unnecessary.

NOTE:

1. The resolution bandwidth and video bandwidth of test receiver/spectrum analyzer is 120kHz for Quasi-peak detection (QP) at frequency below 1GHz.
2. The resolution bandwidth of test receiver/spectrum analyzer is 1 MHz and the video bandwidth is 3 MHz for Peak detection (PK) at frequency above 1GHz.
3. The resolution bandwidth of test receiver/spectrum analyzer is 1 MHz and the video bandwidth is 10 Hz for Average detection (AV) at frequency above 1GHz.
4. All modes of operation were investigated and the worst-case emissions are reported.

4.2.4 DEVIATION FROM TEST STANDARD

No deviation

4.2.5 TEST SETUP

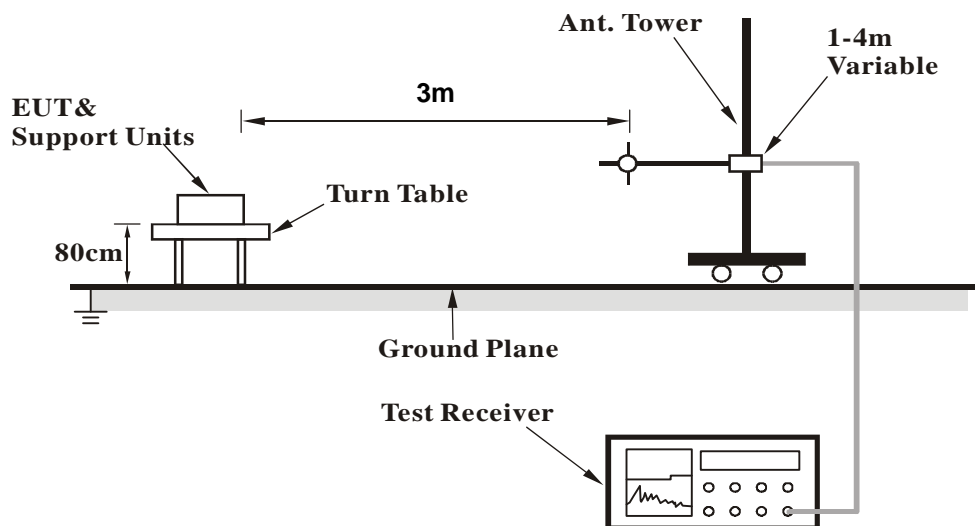

For the actual test configuration, please refer to the related item – Photographs of the Test Configuration.

4.2.6 EUT OPERATING CONDITIONS

Same as 4.1.6

4.2.7 TEST RESULTS

BELOW 1GHz WORST-CASE DATA

802.11n (HT20)

CHANNEL	TX Channel 6	DETECTOR FUNCTION	Quasi-Peak (QP)
FREQUENCY RANGE	Below 1GHz		

ANTENNA POLARITY & TEST DISTANCE: HORIZONTAL AT 3 M								
NO.	FREQ. (MHz)	EMISSION LEVEL (dBuV/m)	LIMIT (dBuV/m)	MARGIN (dB)	ANTENNA HEIGHT (m)	TABLE ANGLE (Degree)	RAW VALUE (dBuV)	CORRECTION FACTOR (dB/m)
1	143.30	34.7 QP	43.5	-8.8	2.00 H	281	48.18	-13.46
2	382.64	30.8 QP	46.0	-15.2	1.00 H	170	41.51	-10.72
3	500.01	31.9 QP	46.0	-14.1	1.50 H	323	39.72	-7.84
4	531.73	29.3 QP	46.0	-16.7	1.00 H	141	36.70	-7.40
5	676.70	30.3 QP	46.0	-15.7	2.00 H	53	34.60	-4.32
6	749.98	28.5 QP	46.0	-17.5	1.00 H	273	30.92	-2.45
ANTENNA POLARITY & TEST DISTANCE: VERTICAL AT 3 M								
NO.	FREQ. (MHz)	EMISSION LEVEL (dBuV/m)	LIMIT (dBuV/m)	MARGIN (dB)	ANTENNA HEIGHT (m)	TABLE ANGLE (Degree)	RAW VALUE (dBuV)	CORRECTION FACTOR (dB/m)
1	77.24	34.9 QP	40.0	-5.1	1.00 V	259	52.67	-17.76
2	531.73	38.4 QP	46.0	-7.6	1.00 V	73	45.79	-7.40
3	628.44	31.9 QP	46.0	-14.1	1.50 V	360	36.72	-4.84
4	676.60	38.3 QP	46.0	-7.7	1.50 V	73	42.66	-4.32
5	870.02	35.2 QP	46.0	-10.8	2.00 V	76	36.21	-1.03
6	895.58	34.2 QP	46.0	-11.8	1.00 V	12	34.76	-0.53

REMARKS:

1. Emission level (dBuV/m) = Raw Value (dBuV) + Correction Factor (dB/m).
2. Correction Factor (dB/m) = Antenna Factor (dB/m) + Cable Factor (dB).
3. The other emission levels were very low against the limit.
4. Margin value = Emission level – Limit value.



A D T

ABOVE 1GHz DATA

802.11b

CHANNEL	TX Channel 1	DETECTOR FUNCTION	Peak (PK)
FREQUENCY RANGE	1GHz ~ 25GHz		Average (AV)

ANTENNA POLARITY & TEST DISTANCE: HORIZONTAL AT 3 M

NO.	FREQ. (MHz)	EMISSION LEVEL (dBuV/m)	LIMIT (dBuV/m)	MARGIN (dB)	ANTENNA HEIGHT (m)	TABLE ANGLE (Degree)	RAW VALUE (dBuV)	CORRECTION FACTOR (dB/m)
1	2390.00	64.3 PK	74.0	-9.7	1.00 H	85	32.32	31.98
2	2390.00	53.1 AV	54.0	-0.9	1.00 H	85	21.12	31.98
3	*2412.00	110.1 PK			1.00 H	85	78.05	32.05
4	*2412.00	108.3 AV			1.00 H	85	76.25	32.05
5	4824.00	52.2 PK	74.0	-21.8	1.23 H	109	12.62	39.58
6	4824.00	43.8 AV	54.0	-10.2	1.23 H	109	4.22	39.58

ANTENNA POLARITY & TEST DISTANCE: VERTICAL AT 3 M

NO.	FREQ. (MHz)	EMISSION LEVEL (dBuV/m)	LIMIT (dBuV/m)	MARGIN (dB)	ANTENNA HEIGHT (m)	TABLE ANGLE (Degree)	RAW VALUE (dBuV)	CORRECTION FACTOR (dB/m)
1	2390.00	61.6 PK	74.0	-12.4	1.28 V	37	29.62	31.98
2	2390.00	51.1 AV	54.0	-2.9	1.28 V	37	19.12	31.98
3	*2412.00	107.1 PK			1.52 V	18	75.05	32.05
4	*2412.00	105.1 AV			1.52 V	18	73.05	32.05
5	4824.00	50.9 PK	74.0	-23.1	1.28 V	115	11.32	39.58
6	4824.00	43.2 AV	54.0	-10.8	1.28 V	115	3.62	39.58

REMARKS:

1. Emission level (dBuV/m) = Raw Value (dBuV) + Correction Factor (dB/m).
2. Correction Factor (dB/m) = Antenna Factor (dB/m) + Cable Factor (dB).
3. The other emission levels were very low against the limit.
4. Margin value = Emission level – Limit value.
5. " * ": Fundamental frequency.



A D T

CHANNEL	TX Channel 6	DETECTOR FUNCTION	Peak (PK)
FREQUENCY RANGE	1GHz ~ 25GHz		Average (AV)

ANTENNA POLARITY & TEST DISTANCE: HORIZONTAL AT 3 M

NO.	FREQ. (MHz)	EMISSION LEVEL (dBuV/m)	LIMIT (dBuV/m)	MARGIN (dB)	ANTENNA HEIGHT (m)	TABLE ANGLE (Degree)	RAW VALUE (dBuV)	CORRECTION FACTOR (dB/m)
1	2390.00	58.5 PK	74.0	-15.5	1.47 H	87	26.52	31.98
2	2390.00	46.9 AV	54.0	-7.1	1.47 H	87	14.92	31.98
3	*2437.00	108.0 PK			1.47 H	87	75.88	32.12
4	*2437.00	106.1 AV			1.47 H	87	73.98	32.12
5	2483.50	58.7 PK	74.0	-15.3	1.47 H	87	26.46	32.24
6	2483.50	46.4 AV	54.0	-7.6	1.47 H	87	14.16	32.24
7	4874.00	52.3 PK	74.0	-21.7	1.24 H	112	12.60	39.70
8	4874.00	44.1 AV	54.0	-9.9	1.24 H	112	4.40	39.70
9	7311.00	59.3 PK	74.0	-14.7	1.06 H	38	11.71	47.59
10	7311.00	52.7 AV	54.0	-1.3	1.06 H	38	5.11	47.59

ANTENNA POLARITY & TEST DISTANCE: VERTICAL AT 3 M

NO.	FREQ. (MHz)	EMISSION LEVEL (dBuV/m)	LIMIT (dBuV/m)	MARGIN (dB)	ANTENNA HEIGHT (m)	TABLE ANGLE (Degree)	RAW VALUE (dBuV)	CORRECTION FACTOR (dB/m)
1	2390.00	57.8 PK	74.0	-16.2	1.30 V	32	25.82	31.98
2	2390.00	46.6 AV	54.0	-7.4	1.30 V	32	14.62	31.98
3	*2437.00	106.1 PK			1.30 V	32	73.98	32.12
4	*2437.00	104.0 AV			1.30 V	32	71.88	32.12
5	2483.50	57.9 PK	74.0	-16.1	1.30 V	32	25.66	32.24
6	2483.50	46.4 AV	54.0	-7.6	1.30 V	32	14.16	32.24
7	4874.00	51.5 PK	74.0	-22.5	1.33 V	106	11.80	39.70
8	4874.00	43.6 AV	54.0	-10.4	1.33 V	106	3.90	39.70
9	7311.00	56.8 PK	74.0	-17.2	1.23 V	222	9.21	47.59
10	7311.00	50.2 AV	54.0	-3.8	1.23 V	222	2.61	47.59

REMARKS:

1. Emission level (dBuV/m) = Raw Value (dBuV) + Correction Factor (dB/m).
2. Correction Factor (dB/m) = Antenna Factor (dB/m) + Cable Factor (dB).
3. The other emission levels were very low against the limit.
4. Margin value = Emission level – Limit value.
5. " * ": Fundamental frequency.



A D T

CHANNEL	TX Channel 11	DETECTOR FUNCTION	Peak (PK)
FREQUENCY RANGE	1GHz ~ 25GHz		Average (AV)

ANTENNA POLARITY & TEST DISTANCE: HORIZONTAL AT 3 M

NO.	FREQ. (MHz)	EMISSION LEVEL (dBuV/m)	LIMIT (dBuV/m)	MARGIN (dB)	ANTENNA HEIGHT (m)	TABLE ANGLE (Degree)	RAW VALUE (dBuV)	CORRECTION FACTOR (dB/m)
1	*2462.00	109.1 PK			1.43 H	57	76.92	32.18
2	*2462.00	107.0 AV			1.43 H	57	74.82	32.18
3	2483.50	61.2 PK	74.0	-12.8	1.43 H	57	28.96	32.24
4	2483.50	49.1 AV	54.0	-4.9	1.43 H	57	16.86	32.24
5	4924.00	52.3 PK	74.0	-21.7	1.24 H	112	12.46	39.84
6	4924.00	44.1 AV	54.0	-9.9	1.24 H	112	4.26	39.84
7	7386.00	58.8 PK	74.0	-15.2	1.30 H	166	11.28	47.52
8	7386.00	53.5 AV	54.0	-0.5	1.30 H	166	5.98	47.52

ANTENNA POLARITY & TEST DISTANCE: VERTICAL AT 3 M

NO.	FREQ. (MHz)	EMISSION LEVEL (dBuV/m)	LIMIT (dBuV/m)	MARGIN (dB)	ANTENNA HEIGHT (m)	TABLE ANGLE (Degree)	RAW VALUE (dBuV)	CORRECTION FACTOR (dB/m)
1	*2462.00	105.9 PK			1.30 V	28	73.72	32.18
2	*2462.00	104.0 AV			1.30 V	28	71.82	32.18
3	2483.50	58.2 PK	74.0	-15.8	1.30 V	28	25.96	32.24
4	2483.50	47.0 AV	54.0	-7.0	1.30 V	28	14.76	32.24
5	4924.00	51.7 PK	74.0	-22.3	1.28 V	101	11.86	39.84
6	4924.00	43.7 AV	54.0	-10.3	1.28 V	101	3.86	39.84
7	7386.00	57.1 PK	74.0	-16.9	1.12 V	278	9.58	47.52
8	7386.00	51.2 AV	54.0	-2.8	1.12 V	278	3.68	47.52

REMARKS:

1. Emission level (dBuV/m) = Raw Value (dBuV) + Correction Factor (dB/m).
2. Correction Factor (dB/m) = Antenna Factor (dB/m) + Cable Factor (dB).
3. The other emission levels were very low against the limit.
4. Margin value = Emission level – Limit value.
5. " * ": Fundamental frequency.

802.11g

CHANNEL	TX Channel 1	DETECTOR FUNCTION	Peak (PK)
FREQUENCY RANGE	1GHz ~ 25GHz		Average (AV)

ANTENNA POLARITY & TEST DISTANCE: HORIZONTAL AT 3 M								
NO.	FREQ. (MHz)	EMISSION LEVEL (dBuV/m)	LIMIT (dBuV/m)	MARGIN (dB)	ANTENNA HEIGHT (m)	TABLE ANGLE (Degree)	RAW VALUE (dBuV)	CORRECTION FACTOR (dB/m)
1	2390.00	68.4 PK	74.0	-5.6	1.00 H	263	36.42	31.98
2	2390.00	53.1 AV	54.0	-0.9	1.00 H	263	21.12	31.98
3	*2412.00	106.2 PK			1.00 H	263	74.15	32.05
4	*2412.00	98.4 AV			1.00 H	263	66.35	32.05
5	4824.00	54.4 PK	74.0	-19.6	1.12 H	91	14.82	39.58
6	4824.00	46.7 AV	54.0	-7.3	1.12 H	91	7.12	39.58
ANTENNA POLARITY & TEST DISTANCE: VERTICAL AT 3 M								
NO.	FREQ. (MHz)	EMISSION LEVEL (dBuV/m)	LIMIT (dBuV/m)	MARGIN (dB)	ANTENNA HEIGHT (m)	TABLE ANGLE (Degree)	RAW VALUE (dBuV)	CORRECTION FACTOR (dB/m)
1	2390.00	65.4 PK	74.0	-8.6	1.22 V	242	33.42	31.98
2	2390.00	50.1 AV	54.0	-3.9	1.22 V	242	18.12	31.98
3	*2412.00	103.2 PK			1.22 V	242	71.15	32.05
4	*2412.00	95.4 AV			1.22 V	242	63.35	32.05
5	4824.00	51.4 PK	74.0	-22.6	1.31 V	89	11.82	39.58
6	4824.00	43.7 AV	54.0	-10.3	1.31 V	89	4.12	39.58

REMARKS:

1. Emission level (dBuV/m) = Raw Value (dBuV) + Correction Factor (dB/m).
2. Correction Factor (dB/m) = Antenna Factor (dB/m) + Cable Factor (dB).
3. The other emission levels were very low against the limit.
4. Margin value = Emission level – Limit value.
5. " * ": Fundamental frequency.



A D T

CHANNEL	TX Channel 6	DETECTOR FUNCTION	Peak (PK)
FREQUENCY RANGE	1GHz ~ 25GHz		Average (AV)

ANTENNA POLARITY & TEST DISTANCE: HORIZONTAL AT 3 M

NO.	FREQ. (MHz)	EMISSION LEVEL (dBuV/m)	LIMIT (dBuV/m)	MARGIN (dB)	ANTENNA HEIGHT (m)	TABLE ANGLE (Degree)	RAW VALUE (dBuV)	CORRECTION FACTOR (dB/m)
1	2390.00	63.9 PK	74.0	-10.1	1.00 H	277	31.92	31.98
2	2390.00	50.8 AV	54.0	-3.2	1.00 H	277	18.82	31.98
3	*2437.00	112.7 PK			1.00 H	277	80.58	32.12
4	*2437.00	104.9 AV			1.00 H	277	72.78	32.12
5	2483.50	61.9 PK	74.0	-12.1	1.00 H	276	29.66	32.24
6	2483.50	48.4 AV	54.0	-5.6	1.00 H	276	16.16	32.24
7	4874.00	55.0 PK	74.0	-19.0	1.12 H	80	15.30	39.70
8	4874.00	47.0 AV	54.0	-7.0	1.12 H	80	7.30	39.70
9	7311.00	64.7 PK	74.0	-9.3	1.16 H	171	17.11	47.59
10	7311.00	53.3 AV	54.0	-0.7	1.16 H	171	5.71	47.59

ANTENNA POLARITY & TEST DISTANCE: VERTICAL AT 3 M

NO.	FREQ. (MHz)	EMISSION LEVEL (dBuV/m)	LIMIT (dBuV/m)	MARGIN (dB)	ANTENNA HEIGHT (m)	TABLE ANGLE (Degree)	RAW VALUE (dBuV)	CORRECTION FACTOR (dB/m)
1	2390.00	60.9 PK	74.0	-13.1	1.53 V	330	28.92	31.98
2	2390.00	47.8 AV	54.0	-6.2	1.53 V	330	15.82	31.98
3	*2437.00	109.7 PK			1.51 V	311	77.58	32.12
4	*2437.00	101.9 AV			1.51 V	311	69.78	32.12
5	2483.50	58.9 PK	74.0	-15.1	1.49 V	327	26.66	32.24
6	2483.50	45.4 AV	54.0	-8.6	1.49 V	327	13.16	32.24
7	4874.00	52.0 PK	74.0	-22.0	1.28 V	107	12.30	39.70
8	4874.00	44.0 AV	54.0	-10.0	1.28 V	107	4.30	39.70
9	7311.00	61.8 PK	74.0	-12.2	1.24 V	211	14.21	47.59
10	7311.00	51.2 AV	54.0	-2.8	1.24 V	211	3.61	47.59

REMARKS:

1. Emission level (dBuV/m) = Raw Value (dBuV) + Correction Factor (dB/m).
2. Correction Factor (dB/m) = Antenna Factor (dB/m) + Cable Factor (dB).
3. The other emission levels were very low against the limit.
4. Margin value = Emission level – Limit value.
5. " * ": Fundamental frequency.



A D T

CHANNEL	TX Channel 11	DETECTOR FUNCTION	Peak (PK)
FREQUENCY RANGE	1GHz ~ 25GHz		Average (AV)

ANTENNA POLARITY & TEST DISTANCE: HORIZONTAL AT 3 M

NO.	FREQ. (MHz)	EMISSION LEVEL (dBuV/m)	LIMIT (dBuV/m)	MARGIN (dB)	ANTENNA HEIGHT (m)	TABLE ANGLE (Degree)	RAW VALUE (dBuV)	CORRECTION FACTOR (dB/m)
1	*2462.00	106.3 PK			1.00 H	81	74.12	32.18
2	*2462.00	98.4 AV			1.00 H	81	66.22	32.18
3	2483.50	69.3 PK	74.0	-4.7	1.00 H	81	37.06	32.24
4	2483.50	52.6 AV	54.0	-1.4	1.00 H	81	20.36	32.24
5	4924.00	54.9 PK	74.0	-19.1	1.09 H	89	15.06	39.84
6	4924.00	46.8 AV	54.0	-7.2	1.09 H	89	6.96	39.84
7	7386.00	53.6 PK	74.0	-20.4	1.10 H	68	6.08	47.52
8	7386.00	46.3 AV	54.0	-7.7	1.10 H	68	-1.22	47.52

ANTENNA POLARITY & TEST DISTANCE: VERTICAL AT 3 M

NO.	FREQ. (MHz)	EMISSION LEVEL (dBuV/m)	LIMIT (dBuV/m)	MARGIN (dB)	ANTENNA HEIGHT (m)	TABLE ANGLE (Degree)	RAW VALUE (dBuV)	CORRECTION FACTOR (dB/m)
1	*2462.00	103.3 PK			1.44 V	306	71.12	32.18
2	*2462.00	95.4 AV			1.44 V	306	63.22	32.18
3	2483.50	66.3 PK	74.0	-7.7	1.50 V	317	34.06	32.24
4	2483.50	49.6 AV	54.0	-4.4	1.50 V	317	17.36	32.24
5	4924.00	51.9 PK	74.0	-22.1	1.27 V	107	12.06	39.84
6	4924.00	43.8 AV	54.0	-10.2	1.27 V	107	3.96	39.84
7	7386.00	50.6 PK	74.0	-23.4	1.28 V	78	3.08	47.52
8	7386.00	43.3 AV	54.0	-10.7	1.28 V	78	-4.22	47.52

REMARKS:

1. Emission level (dBuV/m) = Raw Value (dBuV) + Correction Factor (dB/m).
2. Correction Factor (dB/m) = Antenna Factor (dB/m) + Cable Factor (dB).
3. The other emission levels were very low against the limit.
4. Margin value = Emission level – Limit value.
5. " * " : Fundamental frequency.

802.11n (HT20)

CHANNEL	TX Channel 1	DETECTOR FUNCTION	Peak (PK)
FREQUENCY RANGE	1GHz ~ 25GHz		Average (AV)

ANTENNA POLARITY & TEST DISTANCE: HORIZONTAL AT 3 M								
NO.	FREQ. (MHz)	EMISSION LEVEL (dBuV/m)	LIMIT (dBuV/m)	MARGIN (dB)	ANTENNA HEIGHT (m)	TABLE ANGLE (Degree)	RAW VALUE (dBuV)	CORRECTION FACTOR (dB/m)
1	2390.00	70.6 PK	74.0	-3.4	1.00 H	304	38.62	31.98
2	2390.00	53.2 AV	54.0	-0.8	1.00 H	304	21.22	31.98
3	*2412.00	108.1 PK			1.00 H	304	76.05	32.05
4	*2412.00	98.0 AV			1.00 H	304	65.95	32.05
5	4824.00	54.5 PK	74.0	-19.5	1.21 H	69	14.92	39.58
6	4824.00	46.7 AV	54.0	-7.3	1.21 H	69	7.12	39.58
ANTENNA POLARITY & TEST DISTANCE: VERTICAL AT 3 M								
NO.	FREQ. (MHz)	EMISSION LEVEL (dBuV/m)	LIMIT (dBuV/m)	MARGIN (dB)	ANTENNA HEIGHT (m)	TABLE ANGLE (Degree)	RAW VALUE (dBuV)	CORRECTION FACTOR (dB/m)
1	2390.00	67.6 PK	74.0	-6.4	1.08 V	100	35.62	31.98
2	2390.00	50.2 AV	54.0	-3.8	1.08 V	100	18.22	31.98
3	*2412.00	105.0 PK			1.48 V	317	72.95	32.05
4	*2412.00	95.4 AV			1.48 V	317	63.35	32.05
5	4824.00	51.5 PK	74.0	-22.5	1.34 V	114	11.92	39.58
6	4824.00	43.7 AV	54.0	-10.3	1.34 V	114	4.12	39.58

REMARKS:

1. Emission level (dBuV/m) = Raw Value (dBuV) + Correction Factor (dB/m).
2. Correction Factor (dB/m) = Antenna Factor (dB/m) + Cable Factor (dB).
3. The other emission levels were very low against the limit.
4. Margin value = Emission level – Limit value.
5. " * ": Fundamental frequency.



A D T

CHANNEL	TX Channel 6	DETECTOR FUNCTION	Peak (PK)
FREQUENCY RANGE	1GHz ~ 25GHz		Average (AV)

ANTENNA POLARITY & TEST DISTANCE: HORIZONTAL AT 3 M

NO.	FREQ. (MHz)	EMISSION LEVEL (dBuV/m)	LIMIT (dBuV/m)	MARGIN (dB)	ANTENNA HEIGHT (m)	TABLE ANGLE (Degree)	RAW VALUE (dBuV)	CORRECTION FACTOR (dB/m)
1	2390.00	65.1 PK	74.0	-8.9	1.00 H	305	33.12	31.98
2	2390.00	50.7 AV	54.0	-3.3	1.00 H	305	18.72	31.98
3	*2437.00	114.7 PK			1.00 H	305	82.58	32.12
4	*2437.00	105.6 AV			1.00 H	305	73.48	32.12
5	2483.50	65.3 PK	74.0	-8.7	1.00 H	305	33.06	32.24
6	2483.50	49.7 AV	54.0	-4.3	1.00 H	305	17.46	32.24
7	4874.00	55.0 PK	74.0	-19.0	1.09 H	87	15.30	39.70
8	4874.00	47.0 AV	54.0	-7.0	1.09 H	87	7.30	39.70
9	7311.00	53.7 PK	74.0	-20.3	1.16 H	70	6.11	47.59
10	7311.00	46.1 AV	54.0	-7.9	1.16 H	70	-1.49	47.59

ANTENNA POLARITY & TEST DISTANCE: VERTICAL AT 3 M

NO.	FREQ. (MHz)	EMISSION LEVEL (dBuV/m)	LIMIT (dBuV/m)	MARGIN (dB)	ANTENNA HEIGHT (m)	TABLE ANGLE (Degree)	RAW VALUE (dBuV)	CORRECTION FACTOR (dB/m)
1	2390.00	62.1 PK	74.0	-11.9	1.25 V	71	30.12	31.98
2	2390.00	47.7 AV	54.0	-6.3	1.25 V	71	15.72	31.98
3	*2437.00	111.7 PK			1.04 V	104	79.58	32.12
4	*2437.00	102.6 AV			1.04 V	104	70.48	32.12
5	2483.50	62.3 PK	74.0	-11.7	1.16 V	111	30.06	32.24
6	2483.50	46.7 AV	54.0	-7.3	1.16 V	111	14.46	32.24
7	4874.00	52.0 PK	74.0	-22.0	1.22 V	103	12.30	39.70
8	4874.00	44.0 AV	54.0	-10.0	1.22 V	103	4.30	39.70
9	7311.00	50.7 PK	74.0	-23.3	1.16 V	87	3.11	47.59
10	7311.00	43.1 AV	54.0	-10.9	1.16 V	87	-4.49	47.59

REMARKS:

1. Emission level (dBuV/m) = Raw Value (dBuV) + Correction Factor (dB/m).
2. Correction Factor (dB/m) = Antenna Factor (dB/m) + Cable Factor (dB).
3. The other emission levels were very low against the limit.
4. Margin value = Emission level – Limit value.
5. " * ": Fundamental frequency.



A D T

CHANNEL	TX Channel 11	DETECTOR FUNCTION	Peak (PK)
FREQUENCY RANGE	1GHz ~ 25GHz		Average (AV)

ANTENNA POLARITY & TEST DISTANCE: HORIZONTAL AT 3 M

NO.	FREQ. (MHz)	EMISSION LEVEL (dBuV/m)	LIMIT (dBuV/m)	MARGIN (dB)	ANTENNA HEIGHT (m)	TABLE ANGLE (Degree)	RAW VALUE (dBuV)	CORRECTION FACTOR (dB/m)
1	*2462.00	108.4 PK			1.00 H	306	76.22	32.18
2	*2462.00	98.5 AV			1.00 H	306	66.32	32.18
3	2483.50	68.2 PK	74.0	-5.8	1.00 H	306	35.96	32.24
4	2483.50	53.4 AV	54.0	-0.6	1.00 H	306	21.16	32.24
5	4924.00	53.8 PK	74.0	-20.2	1.33 H	338	13.96	39.84
6	4924.00	41.8 AV	54.0	-12.2	1.33 H	338	1.96	39.84
7	7386.00	54.8 PK	74.0	-19.2	1.00 H	107	7.28	47.52
8	7386.00	44.2 AV	54.0	-9.8	1.00 H	107	-3.32	47.52

ANTENNA POLARITY & TEST DISTANCE: VERTICAL AT 3 M

NO.	FREQ. (MHz)	EMISSION LEVEL (dBuV/m)	LIMIT (dBuV/m)	MARGIN (dB)	ANTENNA HEIGHT (m)	TABLE ANGLE (Degree)	RAW VALUE (dBuV)	CORRECTION FACTOR (dB/m)
1	*2462.00	105.4 PK			1.14 V	76	73.22	32.18
2	*2462.00	95.5 AV			1.14 V	76	63.32	32.18
3	2483.50	65.2 PK	74.0	-8.8	1.08 V	94	32.96	32.24
4	2483.50	50.4 AV	54.0	-3.6	1.08 V	94	18.16	32.24
5	4924.00	56.8 PK	74.0	-17.2	1.00 V	100	16.96	39.84
6	4924.00	44.9 AV	54.0	-9.1	1.00 V	100	5.06	39.84
7	7386.00	54.6 PK	74.0	-19.4	1.00 V	166	7.08	47.52
8	7386.00	44.0 AV	54.0	-10.0	1.00 V	166	-3.52	47.52

REMARKS:

1. Emission level (dBuV/m) = Raw Value (dBuV) + Correction Factor (dB/m).
2. Correction Factor (dB/m) = Antenna Factor (dB/m) + Cable Factor (dB).
3. The other emission levels were very low against the limit.
4. Margin value = Emission level – Limit value.
5. " * ": Fundamental frequency.



A D T

802.11n (HT40)

CHANNEL	TX Channel 3	DETECTOR FUNCTION	Peak (PK)
FREQUENCY RANGE	1GHz ~ 25GHz		Average (AV)

ANTENNA POLARITY & TEST DISTANCE: HORIZONTAL AT 3 M

NO.	FREQ. (MHz)	EMISSION LEVEL (dBuV/m)	LIMIT (dBuV/m)	MARGIN (dB)	ANTENNA HEIGHT (m)	TABLE ANGLE (Degree)	RAW VALUE (dBuV)	CORRECTION FACTOR (dB/m)
1	2390.00	68.5 PK	74.0	-5.5	1.00 H	306	36.52	31.98
2	2390.00	53.2 AV	54.0	-0.8	1.00 H	306	21.22	31.98
3	*2422.00	103.0 PK			1.00 H	306	70.92	32.08
4	*2422.00	93.2 AV			1.00 H	306	61.12	32.08
5	4844.00	54.5 PK	74.0	-19.5	1.24 H	113	14.87	39.63
6	4844.00	46.5 AV	54.0	-7.5	1.24 H	113	6.87	39.63
7	7266.00	53.7 PK	74.0	-20.3	1.26 H	126	6.10	47.60
8	7266.00	46.4 AV	54.0	-7.6	1.26 H	126	-1.20	47.60

ANTENNA POLARITY & TEST DISTANCE: VERTICAL AT 3 M

NO.	FREQ. (MHz)	EMISSION LEVEL (dBuV/m)	LIMIT (dBuV/m)	MARGIN (dB)	ANTENNA HEIGHT (m)	TABLE ANGLE (Degree)	RAW VALUE (dBuV)	CORRECTION FACTOR (dB/m)
1	2390.00	65.5 PK	74.0	-8.5	1.17 V	81	33.52	31.98
2	2390.00	50.2 AV	54.0	-3.8	1.17 V	81	18.22	31.98
3	*2422.00	100.0 PK			1.10 V	77	67.92	32.08
4	*2422.00	90.2 AV			1.10 V	77	58.12	32.08
5	4844.00	51.5 PK	74.0	-22.5	1.26 V	109	11.87	39.63
6	4844.00	43.5 AV	54.0	-10.5	1.26 V	109	3.87	39.63
7	7266.00	50.7 PK	74.0	-23.3	1.20 V	84	3.10	47.60
8	7266.00	43.4 AV	54.0	-10.6	1.20 V	84	-4.20	47.60

REMARKS:

1. Emission level (dBuV/m) = Raw Value (dBuV) + Correction Factor (dB/m).
2. Correction Factor (dB/m) = Antenna Factor (dB/m) + Cable Factor (dB).
3. The other emission levels were very low against the limit.
4. Margin value = Emission level – Limit value.
5. " * ": Fundamental frequency.



A D T

CHANNEL	TX Channel 6	DETECTOR FUNCTION	Peak (PK)
FREQUENCY RANGE	1GHz ~ 25GHz		Average (AV)

ANTENNA POLARITY & TEST DISTANCE: HORIZONTAL AT 3 M

NO.	FREQ. (MHz)	EMISSION LEVEL (dBuV/m)	LIMIT (dBuV/m)	MARGIN (dB)	ANTENNA HEIGHT (m)	TABLE ANGLE (Degree)	RAW VALUE (dBuV)	CORRECTION FACTOR (dB/m)
1	2390.00	71.5 PK	74.0	-2.5	1.02 H	262	39.52	31.98
2	2390.00	53.5 AV	54.0	-0.5	1.02 H	262	21.52	31.98
3	*2437.00	104.9 PK			1.03 H	264	72.78	32.12
4	*2437.00	96.1 AV			1.03 H	264	63.98	32.12
5	2500.00	64.7 PK	74.0	-9.3	1.02 H	310	32.42	32.28
6	2500.00	49.2 AV	54.0	-4.8	1.02 H	310	16.92	32.28
7	4874.00	54.0 PK	74.0	-20.0	1.18 H	100	14.30	39.70
8	4874.00	46.4 AV	54.0	-7.6	1.18 H	100	6.70	39.70
9	7311.00	53.4 PK	74.0	-20.6	1.11 H	78	5.81	47.59
10	7311.00	46.3 AV	54.0	-7.7	1.11 H	78	-1.29	47.59

ANTENNA POLARITY & TEST DISTANCE: VERTICAL AT 3 M

NO.	FREQ. (MHz)	EMISSION LEVEL (dBuV/m)	LIMIT (dBuV/m)	MARGIN (dB)	ANTENNA HEIGHT (m)	TABLE ANGLE (Degree)	RAW VALUE (dBuV)	CORRECTION FACTOR (dB/m)
1	2390.00	68.5 PK	74.0	-5.5	1.23 V	90	36.52	31.98
2	2390.00	50.5 AV	54.0	-3.5	1.23 V	90	18.52	31.98
3	*2437.00	101.9 PK			1.10 V	99	69.78	32.12
4	*2437.00	93.1 AV			1.10 V	99	60.98	32.12
5	2500.00	61.7 PK	74.0	-12.3	1.11 V	80	29.42	32.28
6	2500.00	46.2 AV	54.0	-7.8	1.11 V	80	13.92	32.28
7	4874.00	51.0 PK	74.0	-23.0	1.22 V	98	11.30	39.70
8	4874.00	43.4 AV	54.0	-10.6	1.22 V	98	3.70	39.70
9	7311.00	50.4 PK	74.0	-23.6	1.23 V	90	2.81	47.59
10	7311.00	43.3 AV	54.0	-10.7	1.23 V	90	-4.29	47.59

REMARKS:

1. Emission level (dBuV/m) = Raw Value (dBuV) + Correction Factor (dB/m).
2. Correction Factor (dB/m) = Antenna Factor (dB/m) + Cable Factor (dB).
3. The other emission levels were very low against the limit.
4. Margin value = Emission level – Limit value.
5. " * ": Fundamental frequency.



A D T

CHANNEL	TX Channel 9	DETECTOR FUNCTION	Peak (PK)
FREQUENCY RANGE	1GHz ~ 25GHz		Average (AV)

ANTENNA POLARITY & TEST DISTANCE: HORIZONTAL AT 3 M

NO.	FREQ. (MHz)	EMISSION LEVEL (dBuV/m)	LIMIT (dBuV/m)	MARGIN (dB)	ANTENNA HEIGHT (m)	TABLE ANGLE (Degree)	RAW VALUE (dBuV)	CORRECTION FACTOR (dB/m)
1	*2452.00	104.3 PK			1.00 H	306	72.14	32.16
2	*2452.00	93.9 AV			1.00 H	306	61.74	32.16
3	2483.50	67.1 PK	74.0	-6.9	1.00 H	306	34.86	32.24
4	2483.50	53.1 AV	54.0	-0.9	1.00 H	306	20.86	32.24
5	4904.00	54.1 PK	74.0	-19.9	1.16 H	83	14.33	39.77
6	4904.00	46.5 AV	54.0	-7.5	1.16 H	83	6.73	39.77
7	7356.00	53.9 PK	74.0	-20.1	1.21 H	69	6.35	47.55
8	7356.00	46.3 AV	54.0	-7.7	1.21 H	69	-1.25	47.55

ANTENNA POLARITY & TEST DISTANCE: VERTICAL AT 3 M

NO.	FREQ. (MHz)	EMISSION LEVEL (dBuV/m)	LIMIT (dBuV/m)	MARGIN (dB)	ANTENNA HEIGHT (m)	TABLE ANGLE (Degree)	RAW VALUE (dBuV)	CORRECTION FACTOR (dB/m)
1	*2452.00	101.3 PK			1.02 V	97	69.14	32.16
2	*2452.00	90.9 AV			1.02 V	97	58.74	32.16
3	2483.50	64.1 PK	74.0	-9.9	1.11 V	221	31.86	32.24
4	2483.50	50.1 AV	54.0	-3.9	1.11 V	221	17.86	32.24
5	4904.00	51.1 PK	74.0	-22.9	1.29 V	110	11.33	39.77
6	4904.00	43.5 AV	54.0	-10.5	1.29 V	110	3.73	39.77
7	7356.00	50.9 PK	74.0	-23.1	1.14 V	92	3.35	47.55
8	7356.00	43.3 AV	54.0	-10.7	1.14 V	92	-4.25	47.55

REMARKS:

1. Emission level (dBuV/m) = Raw Value (dBuV) + Correction Factor (dB/m).
2. Correction Factor (dB/m) = Antenna Factor (dB/m) + Cable Factor (dB).
3. The other emission levels were very low against the limit.
4. Margin value = Emission level – Limit value.
5. " * ": Fundamental frequency.

4.3 6dB BANDWIDTH MEASUREMENT

4.3.1 LIMITS OF 6dB BANDWIDTH MEASUREMENT

The minimum of 6dB Bandwidth Measurement is 0.5 MHz.

4.3.2 TEST INSTRUMENTS

DESCRIPTION & MANUFACTURER	MODEL NO.	SERIAL NO.	CALIBRATED DATE	CALIBRATED UNTIL
R&S SPECTRUM ANALYZER	FSP40	100037	Nov. 01, 2012	Oct. 31, 2013

Note:

1. The calibration interval of the above test instruments is 12 months and the calibrations are traceable to NML/ROC and NIST/USA.
2. Tested date : Apr. 11, 2013

4.3.3 TEST PROCEDURE

1. Set resolution bandwidth (RBW) = 100kHz
2. Set the video bandwidth (VBW) $\geq 3 \times$ RBW, Detector = Peak.
3. Trace mode = max hold.
4. Sweep = auto couple.
5. Measure the maximum width of the emission that is constrained by the frequencies associated with the two amplitude points (upper and lower) that are attenuated by 6 dB relative to the maximum level measured in the fundamental emission

4.3.4 DEVIATION FROM TEST STANDARD

No deviation

4.3.5 TEST SETUP

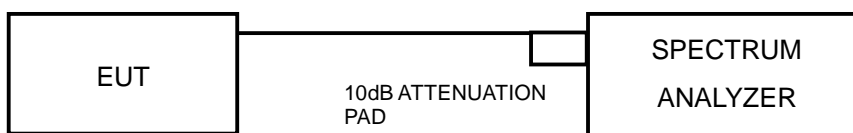

4.3.6 EUT OPERATING CONDITIONS

The software provided by client to enable the EUT under transmission condition continuously at lowest, middle and highest channel frequencies individually.

4.3.7 TEST RESULTS

802.11b

CHANNEL	FREQUENCY (MHz)	6dB BANDWIDTH (MHz)	MINIMUM LIMIT (MHz)	PASS / FAIL
1	2412	8.88	0.5	PASS
6	2437	8.86	0.5	PASS
11	2462	9.72	0.5	PASS

802.11g

CHANNEL	FREQUENCY (MHz)	6dB BANDWIDTH (MHz)	MINIMUM LIMIT (MHz)	PASS / FAIL
1	2412	16.42	0.5	PASS
6	2437	16.45	0.5	PASS
11	2462	16.45	0.5	PASS

802.11n (HT20)

CHANNEL	CHANNEL FREQUENCY (MHz)	6dB BANDWIDTH (MHz)		MINIMUM LIMIT (MHz)	PASS / FAIL
		CHAIN 0	CHAIN 1		
1	2412	17.73	17.38	0.5	PASS
6	2437	17.61	17.63	0.5	PASS
11	2462	17.34	17.62	0.5	PASS

802.11n (HT40)

CHANNEL	CHANNEL FREQUENCY (MHz)	6dB BANDWIDTH (MHz)		MINIMUM LIMIT (MHz)	PASS / FAIL
		CHAIN 0	CHAIN 1		
3	2422	36.46	36.08	0.5	PASS
6	2437	36.25	36.11	0.5	PASS
9	2452	36.55	36.06	0.5	PASS

4.4 CONDUCTED OUTPUT POWER MEASUREMENT

4.4.1 LIMITS OF MAXIMUM PEAK OUTPUT POWER MEASUREMENT

For systems using digital modulation in the 2400–2483.5 MHz band: 1 Watt (30dBm)

Per KDB 662911 D01 Multiple Transmitter Output v01r02 Method of conducted output power measurement on IEEE 802.11 devices,

- Array Gain = 0 dB (i.e., no array gain) for NANT \leq 4;
- Array Gain = 0 dB (i.e., no array gain) for channel widths \geq 40 MHz for any NANT;
- Array Gain = $5 \log(\text{NANT}/\text{NSS})$ dB or 3 dB, whichever is less for 20-MHz channel widths with NANT \geq 5.

For power measurements on all other devices: Array Gain = $10 \log(\text{NANT}/\text{NSS})$ dB.

4.4.2 INSTRUMENTS

DESCRIPTION & MANUFACTURER	MODEL NO.	SERIAL NO.	CALIBRATED DATE	CALIBRATED UNTIL
Power Meter	ML2495A	0824006	May 10, 2012	May 09, 2013
Power Sensor	MA2411B	0738172	May 10, 2012	May 09, 2013

- Note:**
1. The calibration interval of the above test instruments is 12 months and the calibrations are traceable to NML/ROC and NIST/USA.
 2. Tested date : Apr. 11, 2013

4.4.3 TEST PROCEDURES

The peak power sensor was used on the output port of the EUT. A power meter was used to read the response of the peak power sensor. Record the peak power level.

4.4.4 DEVIATION FROM TEST STANDARD

No deviation.

4.4.5 TEST SETUP

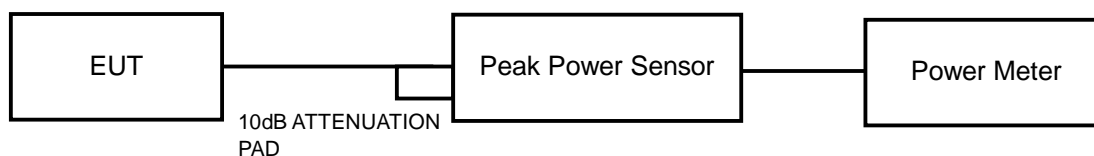



A D T

4.4.6 EUT OPERATING CONDITIONS

Same as Item 4.3.6



A D T

4.4.7 TEST RESULTS

802.11b

CHANNEL	FREQUENCY (MHz)	PEAK POWER (mW)	PEAK POWER (dBm)	LIMIT (dBm)	PASS/FAIL
1	2412	188.799	22.76	30	PASS
6	2437	159.956	22.04	30	PASS
11	2462	134.586	21.29	30	PASS

802.11g

CHANNEL	FREQUENCY (MHz)	PEAK POWER (mW)	PEAK POWER (dBm)	LIMIT (dBm)	PASS/FAIL
1	2412	123.595	20.92	30	PASS
6	2437	268.534	24.29	30	PASS
11	2462	154.882	21.90	30	PASS

802.11n (HT20)

CHAN.	FREQUENCY (MHz)	PEAK POWER (dBm)		TOTAL POWER (mW)	TOTAL POWER (dBm)	LIMIT (dBm)	PASS / FAIL
		CHAIN 0	CHAIN 1				
1	2412	20.30	20.07	208.777	23.20	30	PASS
6	2437	24.17	23.32	475.999	26.78	30	PASS
11	2462	21.36	20.80	256.999	24.10	30	PASS

802.11n (HT40)

CHAN.	FREQUENCY (MHz)	PEAK POWER (dBm)		TOTAL POWER (mW)	TOTAL POWER (dBm)	LIMIT (dBm)	PASS / FAIL
		CHAIN 0	CHAIN 1				
3	2422	18.18	19.12	147.424	21.69	30	PASS
6	2437	21.30	21.45	274.533	24.39	30	PASS
9	2452	19.16	20.01	182.645	22.62	30	PASS

4.5 AVERAGE OUTPUT POWER

4.5.1 FOR REFERENCE.

4.5.2 TEST INSTRUMENTS

DESCRIPTION & MANUFACTURER	MODEL NO.	SERIAL NO.	CALIBRATED DATE	CALIBRATED UNTIL
Power Meter	ML2495A	0824006	May 10, 2012	May 09, 2013
Power Sensor	MA2411B	0738172	May 10, 2012	May 09, 2013

Note:

1. The calibration interval of the above test instruments is 12 months and the calibrations are traceable to NML/ROC and NIST/USA.
2. Tested date : Apr. 11, 2013

4.5.3 TEST PROCEDURES

The average power sensor was used on the output port of the EUT. A power meter was used to read the response of the power sensor. Record the power level.

4.5.4 TEST SETUP

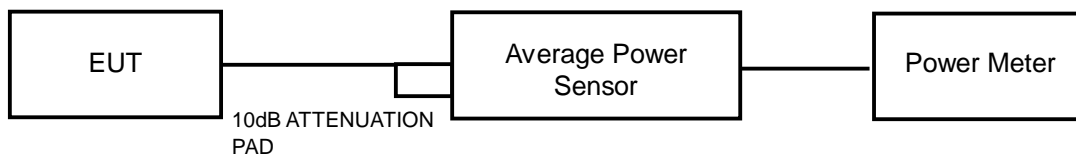

4.5.5 EUT OPERATING CONDITIONS

Same as Item 4.3.6



A D T

4.5.6 TEST RESULTS

802.11b

CHAN.	FREQUENCY (MHz)	AVERAGE POWER (mW)	AVERAGE POWER (dBm)
1	2412	102.565	20.11
6	2437	80.724	19.07
11	2462	65.163	18.14

802.11g

CHAN.	FREQUENCY (MHz)	AVERAGE POWER (mW)	AVERAGE POWER (dBm)
1	2412	20.845	13.19
6	2437	114.025	20.57
11	2462	25.293	14.03

802.11n (HT20)

CHAN.	FREQUENCY (MHz)	AVERAGE POWER (dBm)		TOTAL POWER (mW)	TOTAL POWER (dBm)
		CHAIN 0	CHAIN 1		
1	2412	12.36	11.98	32.995	15.18
6	2437	20.64	19.45	203.983	23.10
11	2462	13.49	13.15	42.990	16.33

802.11n (HT40)

CHAN.	FREQUENCY (MHz)	AVERAGE POWER (dBm)		TOTAL POWER (mW)	TOTAL POWER (dBm)
		CHAIN 0	CHAIN 1		
3	2422	9.96	10.91	22.239	13.47
6	2437	13.27	13.93	45.949	16.62
9	2452	11.34	12.34	30.754	14.88

4.6 POWER SPECTRAL DENSITY MEASUREMENT

4.6.1 LIMITS OF POWER SPECTRAL DENSITY MEASUREMENT

The Maximum of Power Spectral Density Measurement is 8dBm.

4.6.2 TEST INSTRUMENTS

DESCRIPTION & MANUFACTURER	MODEL NO.	SERIAL NO.	CALIBRATED DATE	CALIBRATED UNTIL
R&S Spectrum Analyzer	FSP40	100037	Nov. 01, 2012	Oct. 31, 2013

Note:

1. The calibration interval of the above test instruments is 12 months and the calibrations are traceable to NML/ROC and NIST/USA.
2. Tested date : Apr. 11, 2013

4.6.3 TEST PROCEDURE

1. Set the RBW = 3 kHz, VBW =10 kHz, Detector = peak.
2. Sweep time = auto couple, Trace mode = max hold, allow trace to fully stabilize.
3. Use the peak marker function to determine the maximum amplitude level.

4.6.4 DEVIATION FROM TEST STANDARD

No deviation

4.6.5 TEST SETUP

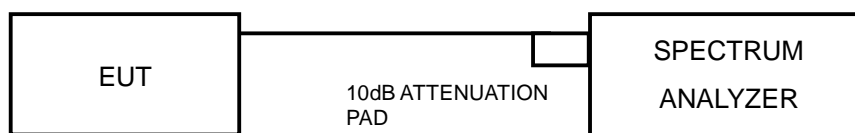

4.6.6 EUT OPERATING CONDITION

Same as Item 4.3.6



A D T

4.6.7 TEST RESULTS

802.11b

Channel	FREQUENCY (MHz)	PSD (dBm/3kHz)	Limit (dBm/3kHz)	PASS /FAIL
1	2412	-2.48	8	PASS
6	2437	-4.60	8	PASS
11	2462	-4.39	8	PASS

802.11g

Channel	FREQUENCY (MHz)	PSD (dBm/3kHz)	Limit (dBm/3kHz)	PASS /FAIL
1	2412	-13.16	8	PASS
6	2437	-4.76	8	PASS
11	2462	-12.19	8	PASS

802.11n (HT20)

TX chain	Channel	FREQ. (MHz)	PSD (dBm/3kHz)	10 log (N=2) dB	Total PSD (dBm/3kHz)	Limit (dBm/3kHz)	PASS /FAIL
0	1	2412	-12.93	3.01	-9.92	8	PASS
	6	2437	-4.53	3.01	-1.52	8	PASS
	11	2462	-12.16	3.01	-9.15	8	PASS
1	1	2412	-14.58	3.01	-11.57	8	PASS
	6	2437	-7.14	3.01	-4.13	8	PASS
	11	2462	-11.94	3.01	-8.93	8	PASS

NOTE: Directional gain = $10 \log[(10^{G1/20} + 10^{G2/20})^2 / 2] = 3.6\text{dBi} < 6\text{dBi}$, so the power density limit shall not be reduced.

802.11n (HT40)

TX chain	Channel	FREQ. (MHz)	PSD (dBm/3kHz)	10 log (N=2) dB	Total PSD (dBm/3kHz)	Limit (dBm/3kHz)	PASS /FAIL
0	3	2422	-14.42	3.01	-11.41	8	PASS
	6	2437	-15.14	3.01	-12.13	8	PASS
	9	2452	-13.94	3.01	-10.93	8	PASS
1	3	2422	-17.86	3.01	-14.85	8	PASS
	6	2437	-15.44	3.01	-12.43	8	PASS
	9	2452	-16.48	3.01	-13.47	8	PASS

NOTE: Directional gain = $10 \log[(10^{G1/20} + 10^{G2/20})^2 / 2] = 3.6\text{dBi} < 6\text{dBi}$, so the power density limit shall not be reduced.



A D T

4.7 CONDUCTED OUT-BAND EMISSION MEASUREMENT

4.7.1 LIMITS OF CONDUCTED OUT-BAND EMISSION MEASUREMENT

Below 20dB of the highest emission level of operating band (in 100kHz Resolution Bandwidth).

4.7.2 TEST INSTRUMENTS

DESCRIPTION & MANUFACTURER	MODEL NO.	SERIAL NO.	CALIBRATED DATE	CALIBRATED UNTIL
R&S Spectrum Analyzer	FSP40	100037	Nov. 01, 2012	Oct. 31, 2013

Note:

1. The calibration interval of the above test instruments is 12 months and the calibrations are traceable to NML/ROC and NIST/USA.
2. Tested date : Apr. 11, 2013

4.7.3 TEST PROCEDURE

Measurement Procedure - Reference Level

1. Set the RBW = 100 kHz.
2. Set the VBW \geq 300 kHz.
3. Detector = peak.
4. Sweep time = auto couple.
5. Trace mode = max hold.
6. Allow trace to fully stabilize.
7. Use the peak marker function to determine the maximum power level in any 100 kHz band segment within the fundamental EBW.

Measurement Procedure –Unwanted Emission Level

1. Set RBW = 100 kHz.
2. Set VBW \geq 300 kHz.
3. Set span to encompass the spectrum to be examined
4. Detector = peak.
5. Trace Mode = max hold.
6. Sweep = auto couple.

4.7.4 DEVIATION FROM TEST STANDARD

No deviation

4.7.5 TEST SETUP

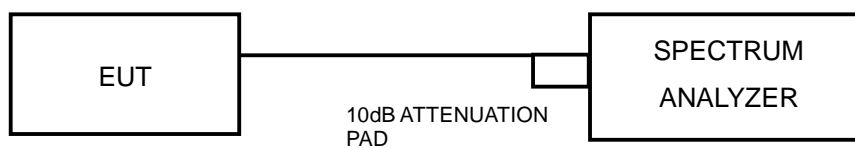

4.7.6 EUT OPERATING CONDITION

Same as Item 4.3.6

4.7.7 TEST RESULTS

The spectrum plots are attached on the following pages. D1 line indicates the highest level, and D2 line indicates the 20dB offset below D1. It shows compliance with the requirement.



A D T

802.11b:

CH 1

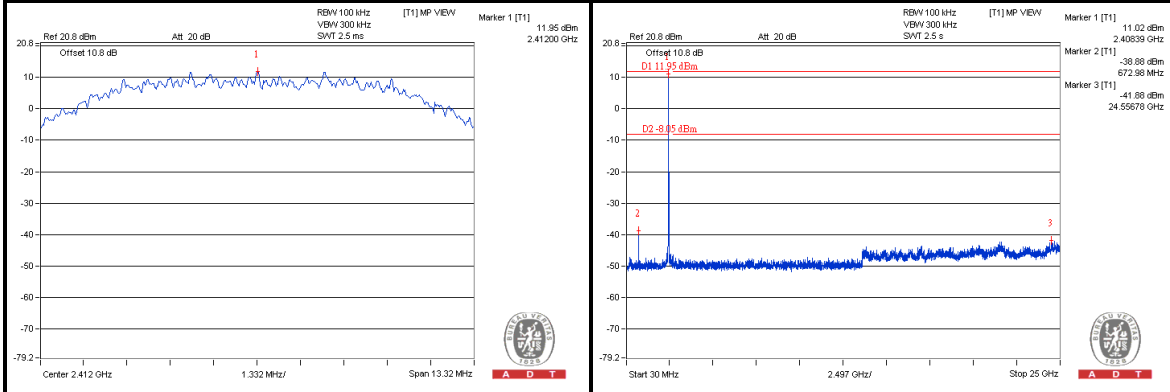

CH 6

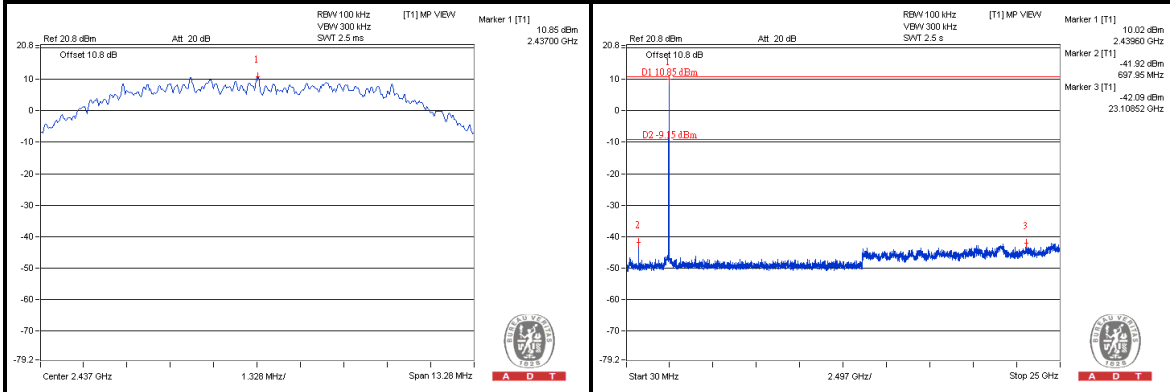

CH 11

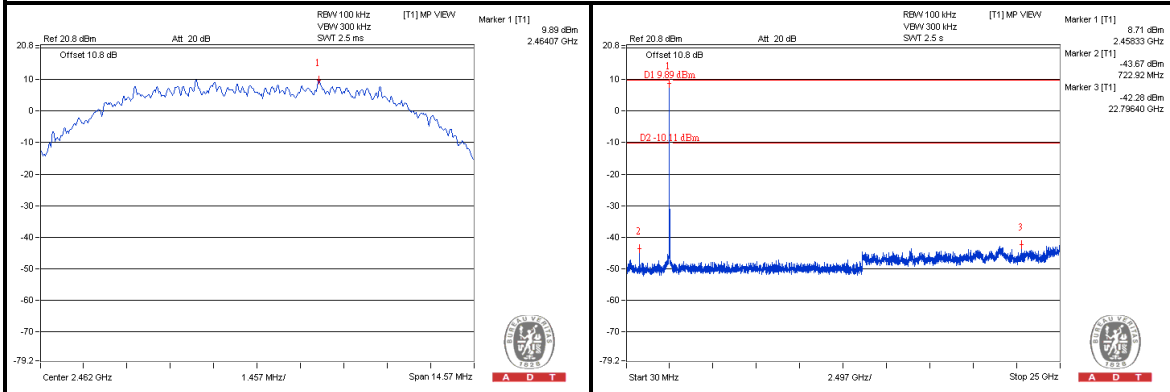



A D T

802.11g:

CH 1

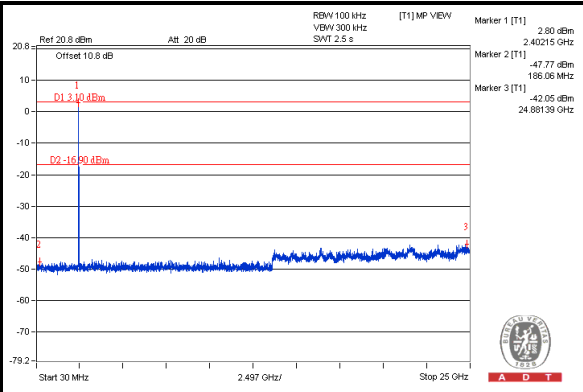
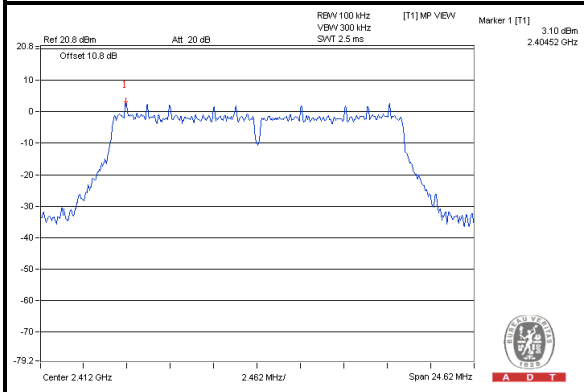

CH 6

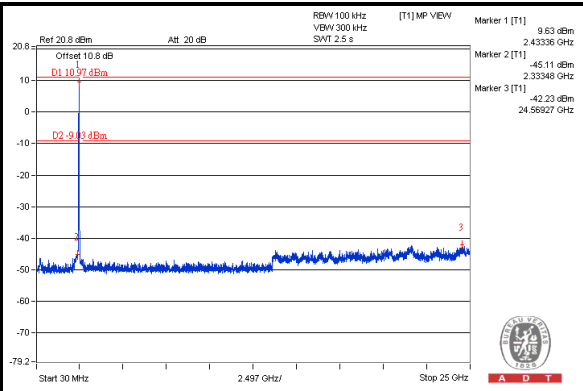
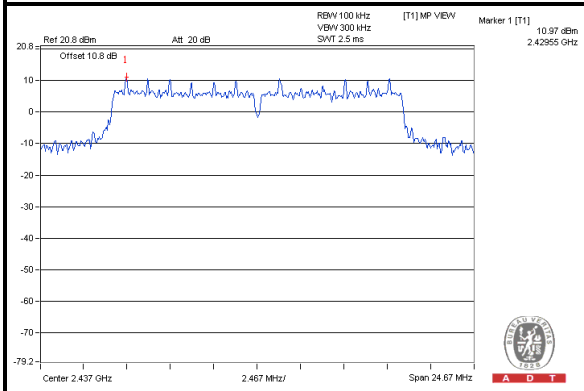

CH 11

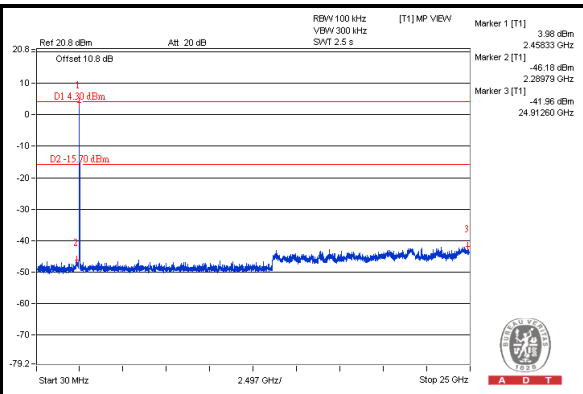
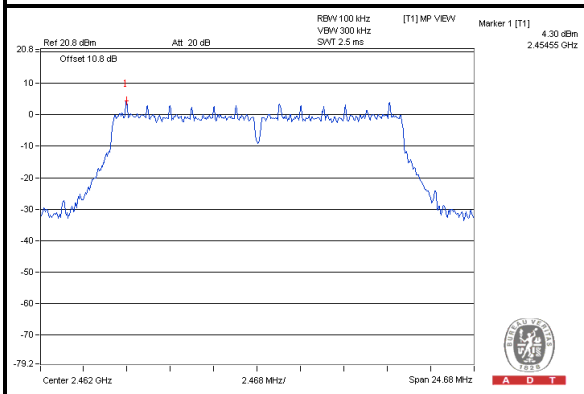



A D T

802.11n (HT20):

Chain (0)

CH 1

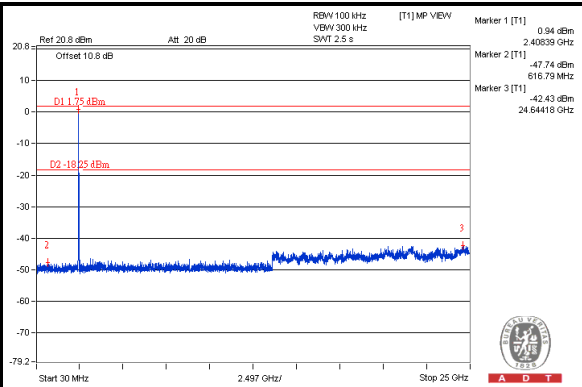
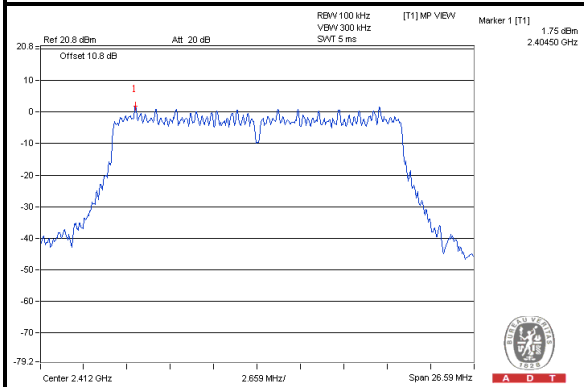

CH 6

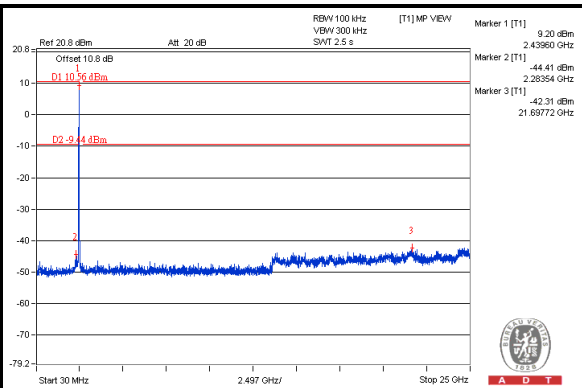
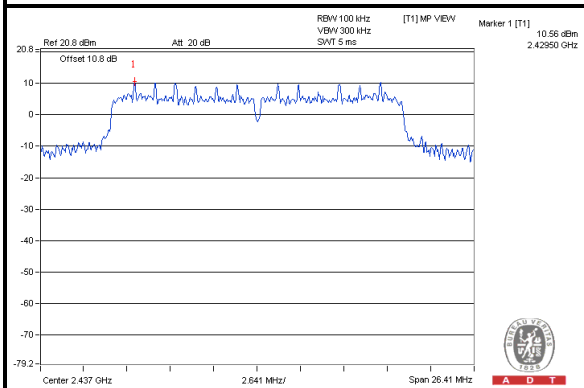

CH 11

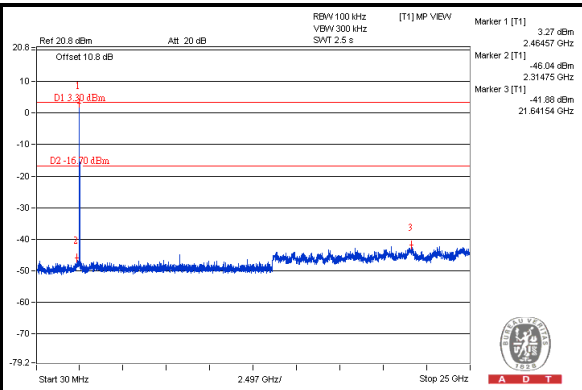
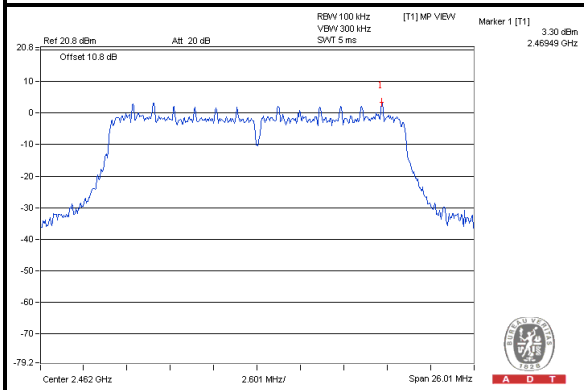



A D T

Chain (1)

CH 1

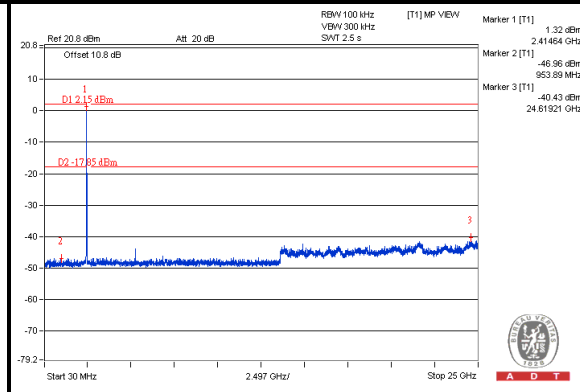
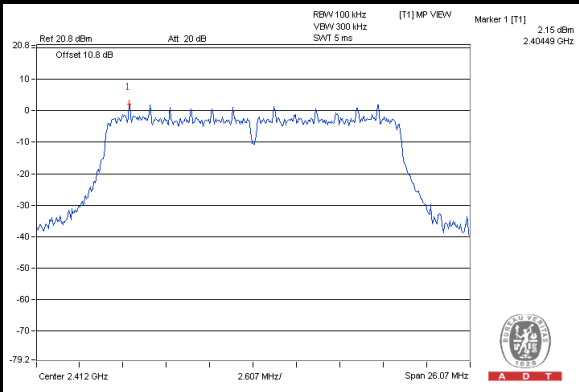

CH 6

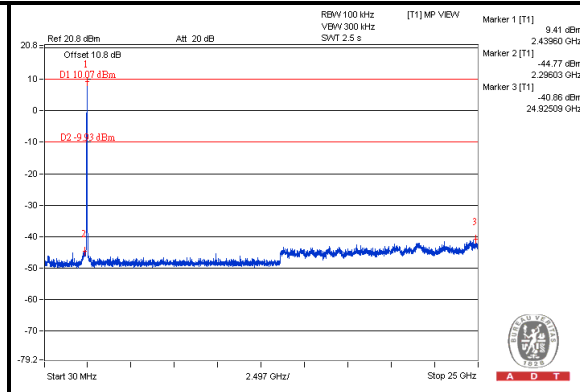
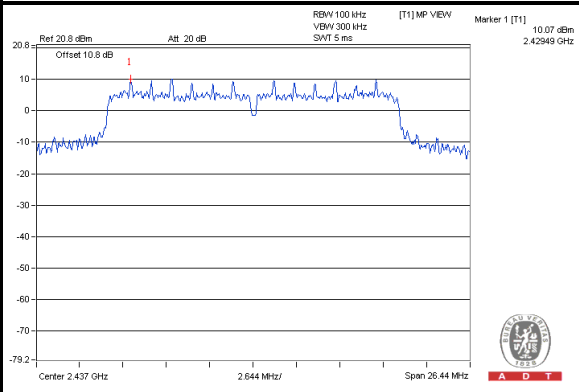

CH 11

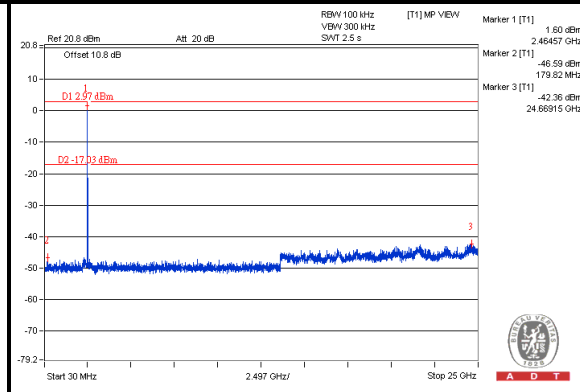
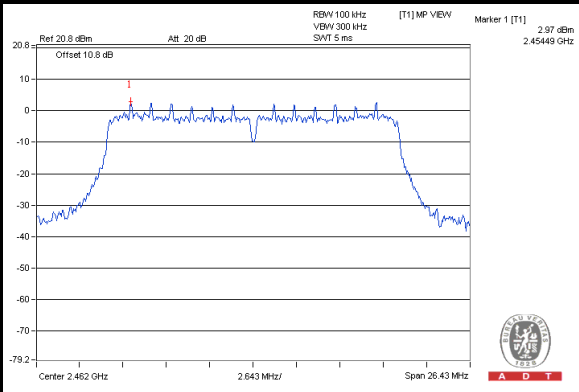



A D T

802.11n (HT40):

Chain (0)

CH 3

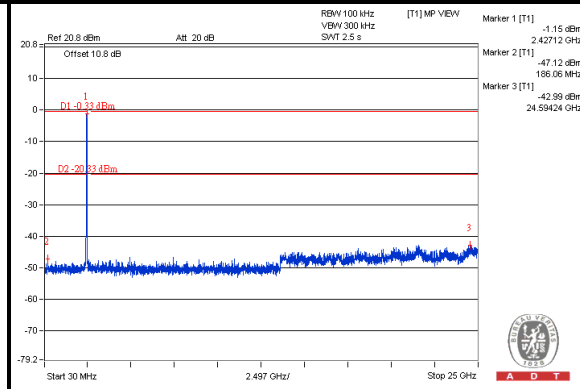
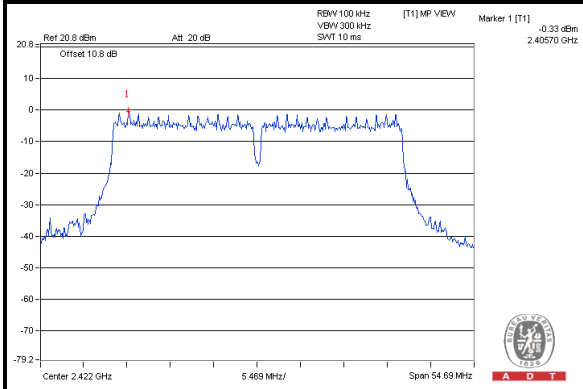

CH 6

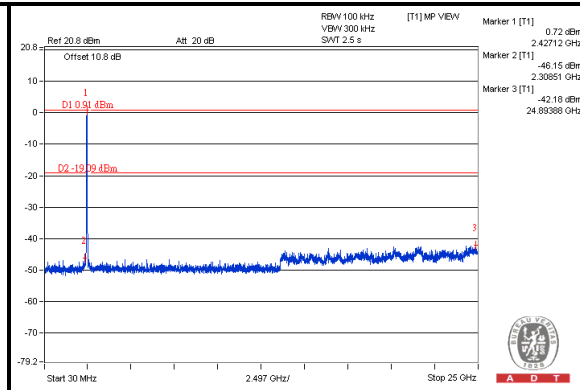
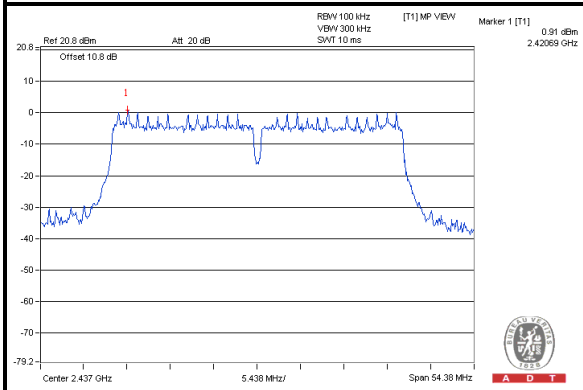

CH 9

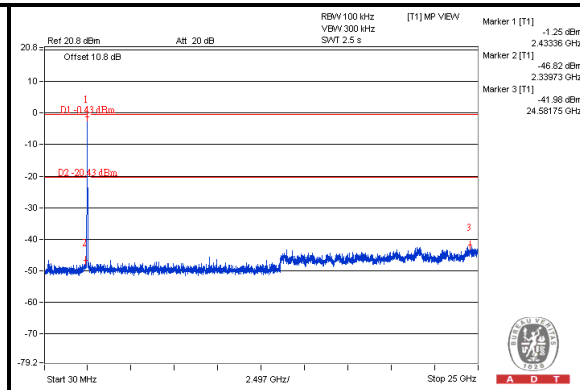
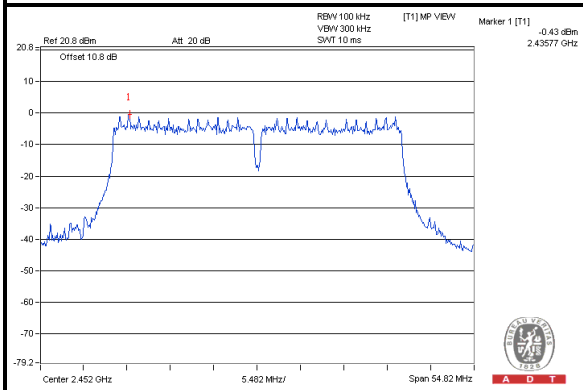



A D T

Chain (1)

CH 3

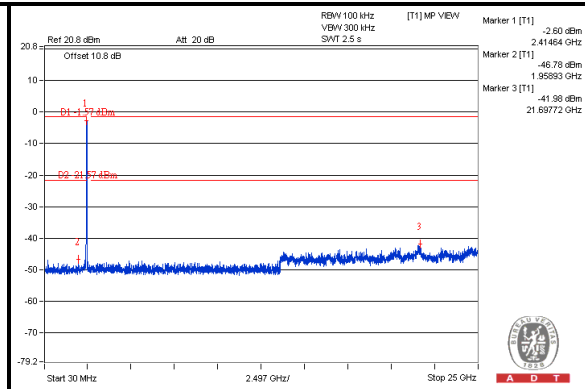
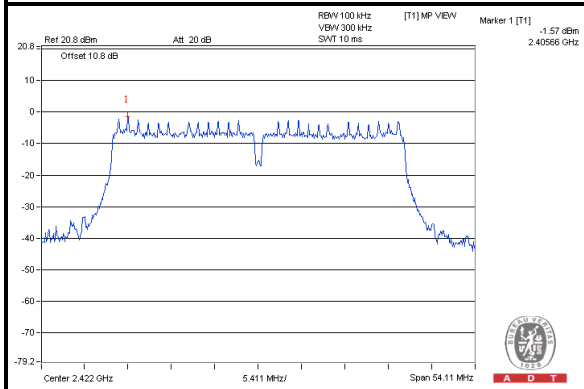

CH 6

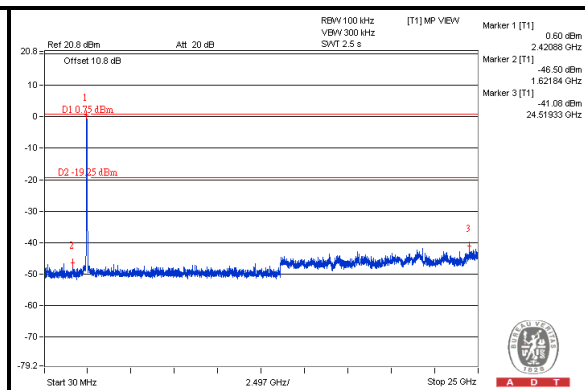
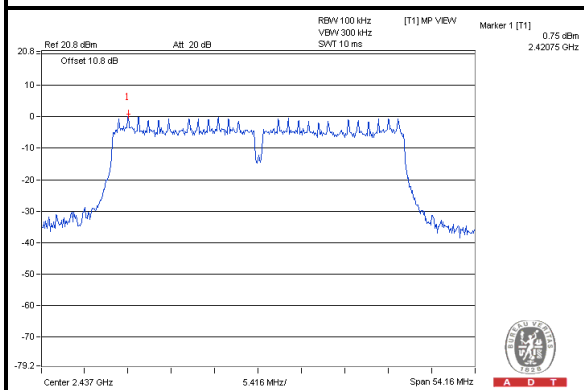

CH 9

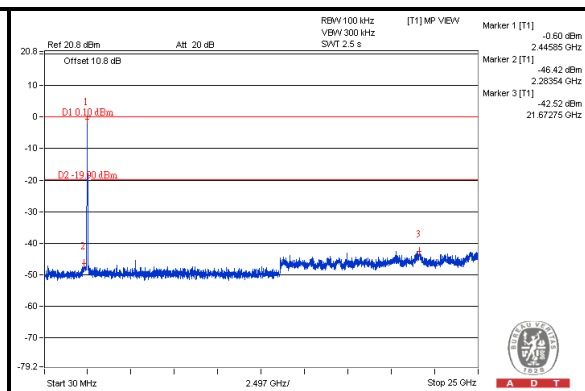
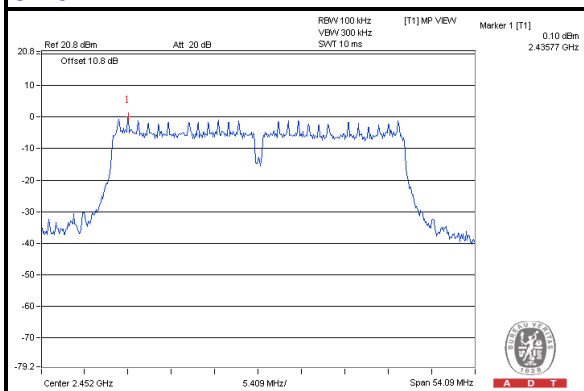

5. TEST TYPES AND RESULTS (FOR 5GHz, 5.725~5.850GHz Band)

5.1 CONDUCTED EMISSION MEASUREMENT

5.1.1 LIMITS OF CONDUCTED EMISSION MEASUREMENT

FREQUENCY OF EMISSION (MHz)	CONDUCTED LIMIT (dB μ V)	
	Quasi-peak	Average
0.15-0.5	66 to 56	56 to 46
0.5-5	56	46
5-30	60	50

- NOTE:**
1. The lower limit shall apply at the transition frequencies.
 2. The limit decreases in line with the logarithm of the frequency in the range of 0.15 to 0.50 MHz.

5.1.2 TEST INSTRUMENTS

DESCRIPTION & MANUFACTURER	MODEL NO.	SERIAL NO.	CALIBRATED DATE	CALIBRATED UNTIL
Test Receiver	ESCS 30	100375	Mar.11, 2013	Mar.10, 2014
Line-Impedance Stabilization Network (for EUT) SCHWARZBECK	NSLK8127	8127-522	Sep. 06, 2012	Sep. 05, 2013
Line-Impedance Stabilization Network (for Peripheral)	ENV216	100072	June 08,2012	June 07,2013
RF Cable (JYEBAO)	5DFB	COCCAB-001	Aug. 28, 2012	Aug. 27, 2013
50 ohms Terminator	50	EMC-3	Sep. 25, 2012	Sep. 24, 2013
Software ADT	BV ADT_Cond_V7.3.7.3	NA	NA	NA

Note:

1. The calibration interval of the above test instruments is 12 months and the calibrations are traceable to NML/ROC and NIST/USA.
2. The test was performed in Shielded Room No. C.
3. The VCCI Con C Registration No. is C-3611.
4. Tested Date: Apr. 11, 2013

5.1.3 TEST PROCEDURES

- a. The EUT was placed 0.4 meters from the conducting wall of the shielded room with EUT being connected to the power mains through a line impedance stabilization network (LISN). Other support units were connected to the power mains through another LISN.
- b. The two LISNs provide 50 ohm/ 50uH of coupling impedance for the measuring instrument.
- c. Both lines of the power mains connected to the EUT were checked for maximum conducted interference.
- d. The frequency range from 150kHz to 30MHz was searched. Emission levels under (Limit – 20dB) were not recorded.

NOTE:

1. The resolution bandwidth of test receiver is 9kHz for Quasi-peak detection (QP) & Average detection (AV).

5.1.4 DEVIATION FROM TEST STANDARD

No deviation

5.1.5 TEST SETUP

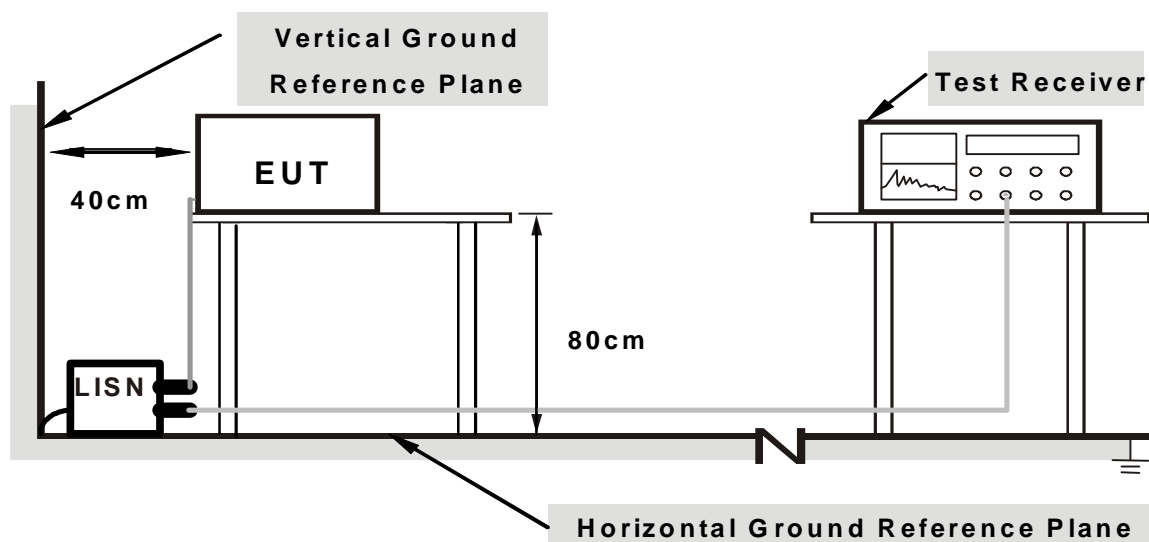

Note: 1. Support units were connected to second LISN.

For the actual test configuration, please refer to the related item – Photographs of the Test Configuration.

5.1.6 EUT OPERATING CONDITIONS

Same as the 4.1.6

5.1.7 TEST RESULTS (MODE 1)

PHASE	Line (L)	DETECTOR FUNCTION	Quasi-Peak (QP) / Average (AV)
--------------	----------	--------------------------	--------------------------------

No	Freq. [MHz]	Corr. Factor (dB)	Reading Value [dB (uV)]		Emission Level [dB (uV)]		Limit [dB (uV)]		Margin (dB)	
			Q.P.	AV.	Q.P.	AV.	Q.P.	AV.	Q.P.	AV.
			1	0.17344	0.10	42.39	31.46	42.49	31.56	64.79
2	0.45859	0.13	41.18	34.58	41.31	34.71	56.72	46.72	-15.40	-12.00
3	0.87100	0.16	38.25	29.40	38.41	29.56	56.00	46.00	-17.59	-16.44
4	3.00000	0.27	34.43	23.16	34.70	23.43	56.00	46.00	-21.30	-22.57
5	5.09766	0.38	36.30	23.98	36.68	24.36	60.00	50.00	-23.32	-25.64
6	17.69141	0.90	34.20	29.13	35.10	30.03	60.00	50.00	-24.90	-19.97

REMARKS:

1. Q.P. and AV. are abbreviations of quasi-peak and average individually.
2. The emission levels of other frequencies were very low against the limit.
3. Margin value = Emission level - Limit value
4. Correction factor = Insertion loss + Cable loss
5. Emission Level = Correction Factor + Reading Value.

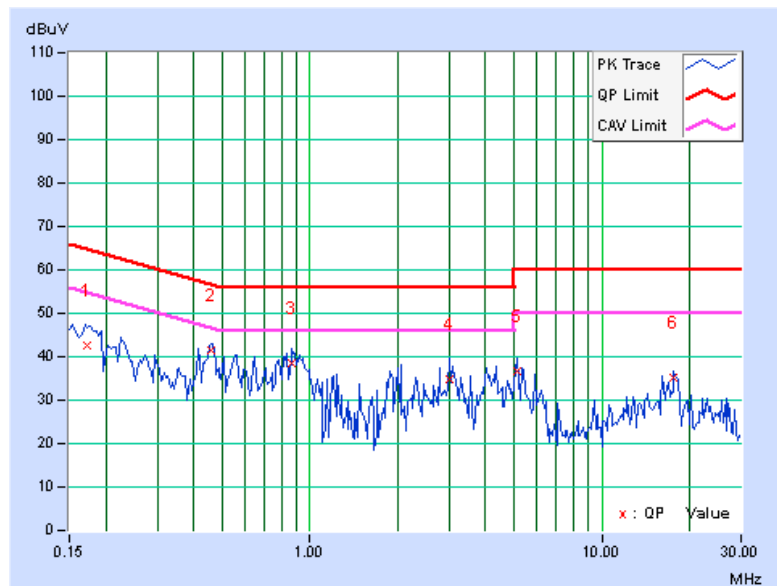

PHASE	Neutral (N)	DETECTOR FUNCTION	Quasi-Peak (QP) / Average (AV)
--------------	-------------	--------------------------	--------------------------------

No	Freq. [MHz]	Corr. Factor (dB)	Reading Value [dB (uV)]		Emission Level [dB (uV)]		Limit [dB (uV)]		Margin (dB)	
			Q.P.	AV.	Q.P.	AV.	Q.P.	AV.	Q.P.	AV.
	1	0.18516	0.09	43.14	35.00	43.23	35.09	64.25	54.25	-21.02
2	0.45469	0.12	36.37	27.85	36.49	27.97	56.79	46.79	-20.30	-18.82
3	0.86875	0.14	34.01	24.62	34.15	24.76	56.00	46.00	-21.85	-21.24
4	3.02734	0.25	30.48	19.48	30.73	19.73	56.00	46.00	-25.27	-26.27
5	5.23438	0.33	29.54	17.97	29.87	18.30	60.00	50.00	-30.13	-31.70
6	16.22656	0.60	31.02	27.60	31.62	28.20	60.00	50.00	-28.38	-21.80

REMARKS:

1. Q.P. and AV. are abbreviations of quasi-peak and average individually.
2. The emission levels of other frequencies were very low against the limit.
3. Margin value = Emission level - Limit value
4. Correction factor = Insertion loss + Cable loss
5. Emission Level = Correction Factor + Reading Value.

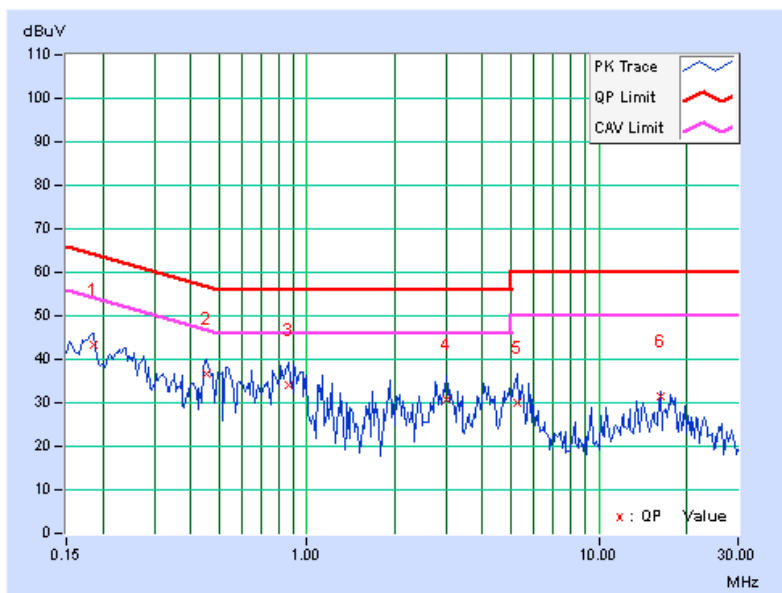

5.1.8 TEST RESULTS (MODE 2)

PHASE	Line (L)	DETECTOR FUNCTION	Quasi-Peak (QP) / Average (AV)
--------------	----------	--------------------------	--------------------------------

No	Freq. [MHz]	Corr. Factor (dB)	Reading Value [dB (uV)]		Emission Level [dB (uV)]		Limit [dB (uV)]		Margin (dB)	
			Q.P.	AV.	Q.P.	AV.	Q.P.	AV.	Q.P.	AV.
			1	0.16953	0.10	42.49	28.43	42.59	28.53	64.98
2	0.22353	0.11	41.10	33.16	41.21	33.27	62.69	52.69	-21.47	-19.41
3	0.38047	0.13	32.35	28.04	32.48	28.17	58.27	48.27	-25.79	-20.10
4	2.78906	0.26	29.30	20.89	29.56	21.15	56.00	46.00	-26.44	-24.85
5	5.90625	0.42	37.41	33.51	37.83	33.93	60.00	50.00	-22.17	-16.07
6	17.69531	0.90	33.70	28.73	34.60	29.63	60.00	50.00	-25.40	-20.37

REMARKS:

1. Q.P. and AV. are abbreviations of quasi-peak and average individually.
2. The emission levels of other frequencies were very low against the limit.
3. Margin value = Emission level - Limit value
4. Correction factor = Insertion loss + Cable loss
5. Emission Level = Correction Factor + Reading Value.

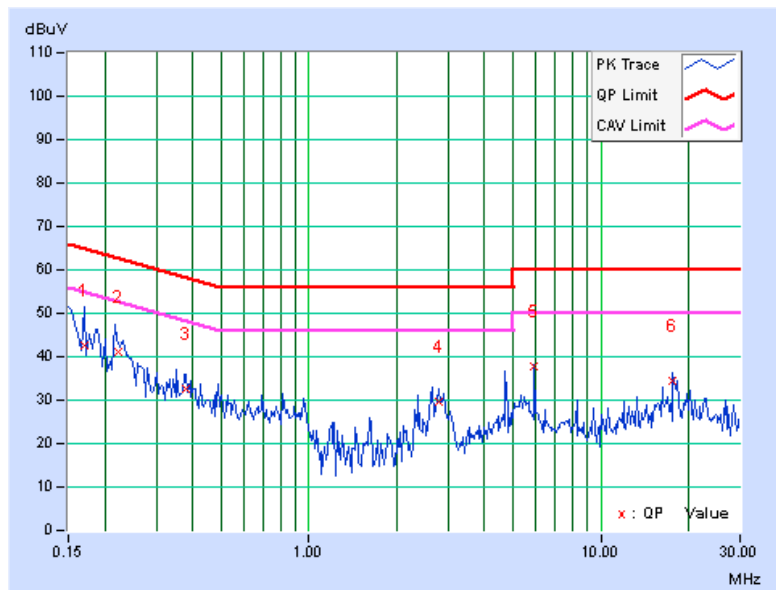

PHASE	Neutral (N)	DETECTOR FUNCTION	Quasi-Peak (QP) / Average (AV)
--------------	-------------	--------------------------	--------------------------------

No	Freq. [MHz]	Corr. Factor (dB)	Reading Value [dB (uV)]		Emission Level [dB (uV)]		Limit [dB (uV)]		Margin (dB)	
			Q.P.	AV.	Q.P.	AV.	Q.P.	AV.	Q.P.	AV.
	1	0.15000	0.08	47.14	38.00	47.22	38.08	66.00	56.00	-18.78
2	0.18906	0.09	43.62	35.26	43.71	35.35	64.08	54.08	-20.37	-18.73
3	0.37294	0.12	36.18	26.08	36.30	26.20	58.44	48.44	-22.14	-22.24
4	2.75391	0.23	23.56	14.72	23.79	14.95	56.00	46.00	-32.21	-31.05
5	4.72656	0.32	32.69	27.48	33.01	27.80	56.00	46.00	-22.99	-18.20
6	18.30469	0.64	27.61	21.86	28.25	22.50	60.00	50.00	-31.75	-27.50

REMARKS:

1. Q.P. and AV. are abbreviations of quasi-peak and average individually.
2. The emission levels of other frequencies were very low against the limit.
3. Margin value = Emission level - Limit value
4. Correction factor = Insertion loss + Cable loss
5. Emission Level = Correction Factor + Reading Value.

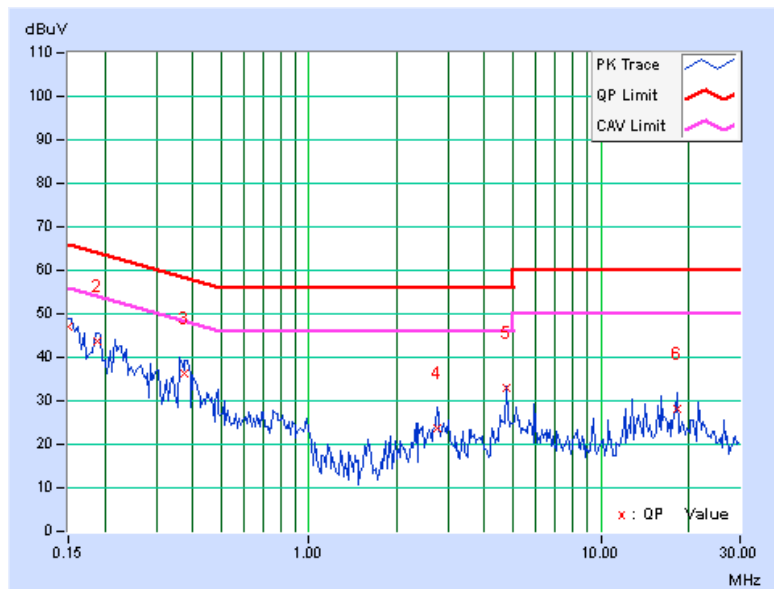

5.2 RADIATED AND BANDEDGE EMISSION MEASUREMENT

5.2.1 LIMITS OF RADIATED AND BANDEDGE EMISSION MEASUREMENT

Radiated emissions which fall in the restricted bands must comply with the radiated emission limits specified as below table. Other emissions shall be at least 30dB below the highest level of the desired power:

Frequencies (MHz)	Field strength (microvolts/meter)	Measurement distance (meters)
0.009-0.490	2400/F(kHz)	300
0.490-1.705	24000/F(kHz)	30
1.705-30.0	30	30
30-88	100	3
88-216	150	3
216-960	200	3
Above 960	500	3

NOTE:

1. The lower limit shall apply at the transition frequencies.
2. Emission level (dBuV/m) = 20 log Emission level (uV/m).
3. For frequencies above 1000MHz, the field strength limits are based on average detector, however, the peak field strength of any emission shall not exceed the maximum permitted average limits, specified above by more than 20dB under any condition of modulation.



A D T

5.2.2 TEST INSTRUMENTS

DESCRIPTION & MANUFACTURER	MODEL NO.	SERIAL NO.	CALIBRATED DATE	CALIBRATED UNTIL
Spectrum Analyzer Agilent	E4446A	MY48250253	Sep. 03, 2012	Sep. 02, 2013
MXE EMI Receiver Agilent	N9038A	MY51210105	Jan. 29, 2013	Jan. 28, 2014
Pre-Amplifier Mini-Circuits	ZFL-1000VH2 B	AMP-ZFL-03	Nov. 14, 2012	Nov. 13, 2013
Pre-Amplifier Agilent	8449B	3008A02578	June 26, 2012	June 25, 2013
Pre-Amplifier SPACEK LABS	SLKKa-48-6	9K16	Nov. 14, 2012	Nov. 13, 2013
Trilog Broadband Antenna SCHWARZBECK	VULB 9168	9168-360	Mar. 19, 2013	Mar. 18, 2014
Horn_Antenna AISI	AIH.8018	0000320091110	Nov. 19, 2012	Nov. 18, 2013
Horn_Antenna SCHWARZBECK	BBHA 9170	9170-424	Oct. 12, 2012	Oct. 11, 2013
RF Cable	NA	RF104-201 RF104-203 RF104-204	Dec. 25, 2012	Dec. 24, 2013
RF Cable	NA	CHGCAB_001	Oct. 06, 2012	Oct. 05, 2013
Software	ADT_Radiated _V8.7.05	NA	NA	NA
Antenna Tower & Turn Table CT	NA	NA	NA	NA

Note:

1. The calibration interval of the above test instruments is 12 months and the calibrations are traceable to NML/ROC and NIST/USA.
2. The horn antenna, preamplifier (model: 8449B) are used only for the measurement of emission frequency above 1GHz if tested.
- 3 The test was performed in 966 Chamber No. G.
4. The FCC Site Registration No. is 966073.
- 5 The VCCI Site Registration No. is G-137.
- 6 The CANADA Site Registration No. is IC 7450H-2.
- 7 Tested Date: Apr. 10, 2013

5.2.3 TEST PROCEDURES

- a. The EUT was placed on the top of a rotating table 0.8 meters above the ground at 3 meter chamber room for test. The table was rotated 360 degrees to determine the position of the highest radiation.
- b. The EUT was set 3 meters away from the interference-receiving antenna, which was mounted on the top of a variable-height antenna tower.
- c. The height of antenna is varied from one meter to four meters above the ground to determine the maximum value of the field strength. Both horizontal and vertical polarizations of the antenna are set to make the measurement.
- d. For each suspected emission, the EUT was arranged to its worst case and then the antenna was tuned to heights from 1 meter to 4 meters and the rotatable table was turned from 0 degrees to 360 degrees to find the maximum reading.
- e. The test-receiver system was set to quasi-peak detect function and specified bandwidth with maximum hold mode when the test frequency is below 1 GHz.
- f. The test-receiver system was set to peak and average detect function and specified bandwidth with maximum hold mode when the test frequency is above 1 GHz. If the peak reading value also meets average limit, measurement with the average detector is unnecessary.

NOTE:

1. The resolution bandwidth and video bandwidth of test receiver/spectrum analyzer is 120kHz for Quasi-peak detection (QP) at frequency below 1GHz.
2. The resolution bandwidth of test receiver/spectrum analyzer is 1 MHz and the video bandwidth is 3 MHz for Peak detection (PK) at frequency above 1GHz.
3. The resolution bandwidth of test receiver/spectrum analyzer is 1 MHz and the video bandwidth is 10 Hz for Average detection (AV) at frequency above 1GHz.
4. All modes of operation were investigated and the worst-case emissions are reported.

5.2.4 DEVIATION FROM TEST STANDARD

No deviation

5.2.5 TEST SETUP

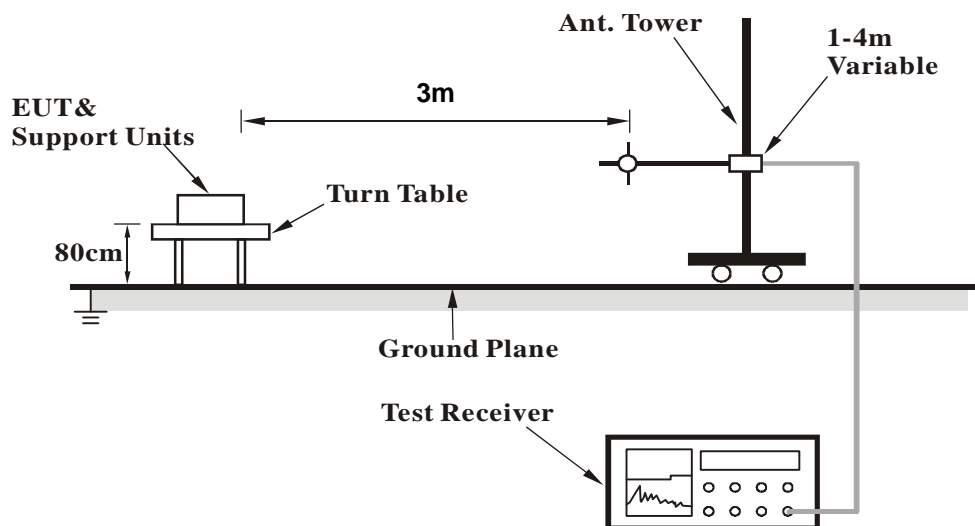

For the actual test configuration, please refer to the related item – Photographs of the Test Configuration.

5.2.6 EUT OPERATING CONDITIONS

Same as the 4.1.6

5.2.7 TEST RESULTS

BELOW 1GHz WORST-CASE DATA

802.11n (HT20)

CHANNEL	TX Channel 165	DETECTOR FUNCTION	Quasi-Peak (QP)
FREQUENCY RANGE	Below 1GHz		

ANTENNA POLARITY & TEST DISTANCE: HORIZONTAL AT 3 M

NO.	FREQ. (MHz)	EMISSION LEVEL (dBuV/m)	LIMIT (dBuV/m)	MARGIN (dB)	ANTENNA HEIGHT (m)	TABLE ANGLE (Degree)	RAW VALUE (dBuV)	CORRECTION FACTOR (dB/m)
1	143.30	34.9 QP	43.5	-8.6	2.00 H	281	48.34	-13.46
2	382.64	31.0 QP	46.0	-15.1	1.00 H	170	41.67	-10.72
3	500.01	32.1 QP	46.0	-13.9	1.50 H	323	39.91	-7.84
4	531.73	29.5 QP	46.0	-16.5	1.00 H	141	36.87	-7.40
5	676.70	30.5 QP	46.0	-15.5	2.00 H	53	34.79	-4.32
6	749.98	28.6 QP	46.0	-17.4	1.00 H	273	31.07	-2.45

ANTENNA POLARITY & TEST DISTANCE: VERTICAL AT 3 M

NO.	FREQ. (MHz)	EMISSION LEVEL (dBuV/m)	LIMIT (dBuV/m)	MARGIN (dB)	ANTENNA HEIGHT (m)	TABLE ANGLE (Degree)	RAW VALUE (dBuV)	CORRECTION FACTOR (dB/m)
1	77.24	35.5 QP	40.0	-4.6	1.00 V	259	53.21	-17.76
2	531.73	38.8 QP	46.0	-7.2	1.00 V	73	46.24	-7.40
3	628.44	32.3 QP	46.0	-13.7	1.50 V	360	37.14	-4.84
4	676.60	38.8 QP	46.0	-7.2	1.50 V	73	43.10	-4.32
5	870.02	35.4 QP	46.0	-10.6	2.00 V	76	36.47	-1.03
6	895.58	34.6 QP	46.0	-11.4	1.00 V	12	35.11	-0.53

REMARKS:

1. Emission level (dBuV/m) = Raw Value (dBuV) + Correction Factor (dB/m).
2. Correction Factor (dB/m) = Antenna Factor (dB/m) + Cable Factor (dB).
3. The other emission levels were very low against the limit.
4. Margin value = Emission level – Limit value.



ABOVE 1GHz DATA

802.11a

CHANNEL	TX Channel 149	DETECTOR FUNCTION	Peak (PK)
FREQUENCY RANGE	1GHz ~ 40GHz		Average (AV)

ANTENNA POLARITY & TEST DISTANCE: HORIZONTAL AT 3 M

NO.	FREQ. (MHz)	EMISSION LEVEL (dBuV/m)	LIMIT (dBuV/m)	MARGIN (dB)	ANTENNA HEIGHT (m)	TABLE ANGLE (Degree)	RAW VALUE (dBuV)	CORRECTION FACTOR (dB/m)
1	5350.00	55.7 PK	74.0	-18.3	1.10 H	287	14.55	41.15
2	5350.00	42.2 AV	54.0	-11.8	1.10 H	287	1.05	41.15
3	*5745.00	113.0 PK			1.10 H	289	70.63	42.37
4	*5745.00	104.2 AV			1.10 H	289	61.83	42.37
5	11490.00	62.6 PK	74.0	-11.4	1.00 H	246	13.84	48.76
6	11490.00	50.5 AV	54.0	-3.5	1.00 H	246	1.74	48.76

ANTENNA POLARITY & TEST DISTANCE: VERTICAL AT 3 M

NO.	FREQ. (MHz)	EMISSION LEVEL (dBuV/m)	LIMIT (dBuV/m)	MARGIN (dB)	ANTENNA HEIGHT (m)	TABLE ANGLE (Degree)	RAW VALUE (dBuV)	CORRECTION FACTOR (dB/m)
1	5350.00	65.0 PK	74.0	-9.0	1.11 V	287	23.85	41.15
2	5350.00	52.6 AV	54.0	-1.4	1.11 V	287	11.45	41.15
3	*5745.00	123.2 PK			1.11 V	287	80.83	42.37
4	*5745.00	114.1 AV			1.11 V	287	71.73	42.37
5	11490.00	62.5 PK	74.0	-11.5	1.00 V	249	13.74	48.76
6	11490.00	50.6 AV	54.0	-3.4	1.00 V	249	1.84	48.76

REMARKS:

1. Emission level (dBuV/m) = Raw Value (dBuV) + Correction Factor (dB/m).
2. Correction Factor (dB/m) = Antenna Factor (dB/m) + Cable Factor (dB).
3. The other emission levels were very low against the limit.
4. Margin value = Emission level – Limit value.
5. " * ": Fundamental frequency.
6. The limit value is defined as per 15.247.



A D T

CHANNEL	TX Channel 157	DETECTOR FUNCTION	Peak (PK)
FREQUENCY RANGE	1GHz ~ 40GHz		Average (AV)

ANTENNA POLARITY & TEST DISTANCE: HORIZONTAL AT 3 M

NO.	FREQ. (MHz)	EMISSION LEVEL (dBuV/m)	LIMIT (dBuV/m)	MARGIN (dB)	ANTENNA HEIGHT (m)	TABLE ANGLE (Degree)	RAW VALUE (dBuV)	CORRECTION FACTOR (dB/m)
1	5350.00	55.0 PK	74.0	-19.0	1.04 H	297	13.85	41.15
2	5350.00	43.2 AV	54.0	-10.8	1.04 H	297	2.05	41.15
3	*5785.00	112.4 PK			1.05 H	281	69.96	42.44
4	*5785.00	103.6 AV			1.05 H	281	61.16	42.44
5	11570.00	62.7 PK	74.0	-11.3	1.00 H	264	13.99	48.71
6	11570.00	50.9 AV	54.0	-3.1	1.00 H	264	2.19	48.71

ANTENNA POLARITY & TEST DISTANCE: VERTICAL AT 3 M

NO.	FREQ. (MHz)	EMISSION LEVEL (dBuV/m)	LIMIT (dBuV/m)	MARGIN (dB)	ANTENNA HEIGHT (m)	TABLE ANGLE (Degree)	RAW VALUE (dBuV)	CORRECTION FACTOR (dB/m)
1	5350.00	65.0 PK	74.0	-9.0	1.11 V	287	23.85	41.15
2	5350.00	53.2 AV	54.0	-0.8	1.11 V	287	12.05	41.15
3	*5785.00	122.4 PK			1.11 V	287	79.96	42.44
4	*5785.00	113.6 AV			1.11 V	287	71.16	42.44
5	11570.00	62.6 PK	74.0	-11.4	1.01 V	263	13.89	48.71
6	11570.00	50.7 AV	54.0	-3.3	1.01 V	263	1.99	48.71

REMARKS:

1. Emission level (dBuV/m) = Raw Value (dBuV) + Correction Factor (dB/m).
2. Correction Factor (dB/m) = Antenna Factor (dB/m) + Cable Factor (dB).
3. The other emission levels were very low against the limit.
4. Margin value = Emission level – Limit value.
5. " * ": Fundamental frequency.
6. The limit value is defined as per 15.247.



A D T

CHANNEL	TX Channel 165	DETECTOR FUNCTION	Peak (PK)
FREQUENCY RANGE	1GHz ~ 40GHz		Average (AV)

ANTENNA POLARITY & TEST DISTANCE: HORIZONTAL AT 3 M

NO.	FREQ. (MHz)	EMISSION LEVEL (dBuV/m)	LIMIT (dBuV/m)	MARGIN (dB)	ANTENNA HEIGHT (m)	TABLE ANGLE (Degree)	RAW VALUE (dBuV)	CORRECTION FACTOR (dB/m)
1	5350.00	54.0 PK	74.0	-20.0	1.04 H	296	12.85	41.15
2	5350.00	43.2 AV	54.0	-10.8	1.04 H	296	2.05	41.15
3	*5825.00	108.5 PK			1.10 H	280	65.93	42.57
4	*5825.00	100.2 AV			1.10 H	280	57.63	42.57
5	11650.00	60.9 PK	74.0	-13.1	1.25 H	296	11.98	48.92
6	11650.00	48.8 AV	54.0	-5.2	1.25 H	296	-0.12	48.92

ANTENNA POLARITY & TEST DISTANCE: VERTICAL AT 3 M

NO.	FREQ. (MHz)	EMISSION LEVEL (dBuV/m)	LIMIT (dBuV/m)	MARGIN (dB)	ANTENNA HEIGHT (m)	TABLE ANGLE (Degree)	RAW VALUE (dBuV)	CORRECTION FACTOR (dB/m)
1	5350.00	64.0 PK	74.0	-10.0	1.09 V	290	22.85	41.15
2	5350.00	53.2 AV	54.0	-0.8	1.09 V	290	12.05	41.15
3	*5825.00	118.5 PK			1.09 V	290	75.93	42.57
4	*5825.00	110.2 AV			1.09 V	290	67.63	42.57
5	11650.00	61.3 PK	74.0	-12.7	1.16 V	291	12.38	48.92
6	11650.00	49.0 AV	54.0	-5.0	1.16 V	291	0.08	48.92

REMARKS:

1. Emission level (dBuV/m) = Raw Value (dBuV) + Correction Factor (dB/m).
2. Correction Factor (dB/m) = Antenna Factor (dB/m) + Cable Factor (dB).
3. The other emission levels were very low against the limit.
4. Margin value = Emission level – Limit value.
5. " * ": Fundamental frequency.
6. The limit value is defined as per 15.247.



A D T

802.11n (HT20)

CHANNEL	TX Channel 149	DETECTOR FUNCTION	Peak (PK)
FREQUENCY RANGE	1GHz ~ 40GHz		Average (AV)

ANTENNA POLARITY & TEST DISTANCE: HORIZONTAL AT 3 M

NO.	FREQ. (MHz)	EMISSION LEVEL (dBuV/m)	LIMIT (dBuV/m)	MARGIN (dB)	ANTENNA HEIGHT (m)	TABLE ANGLE (Degree)	RAW VALUE (dBuV)	CORRECTION FACTOR (dB/m)
1	5350.00	54.8 PK	74.0	-19.2	1.07 H	281	13.65	41.15
2	5350.00	43.3 AV	54.0	-10.7	1.07 H	281	2.15	41.15
3	*5745.00	113.1 PK			1.09 H	269	70.73	42.37
4	*5745.00	103.1 AV			1.09 H	269	60.73	42.37
5	11490.00	62.0 PK	74.0	-12.0	1.22 H	88	13.24	48.76
6	11490.00	51.5 AV	54.0	-2.5	1.22 H	88	2.74	48.76

ANTENNA POLARITY & TEST DISTANCE: VERTICAL AT 3 M

NO.	FREQ. (MHz)	EMISSION LEVEL (dBuV/m)	LIMIT (dBuV/m)	MARGIN (dB)	ANTENNA HEIGHT (m)	TABLE ANGLE (Degree)	RAW VALUE (dBuV)	CORRECTION FACTOR (dB/m)
1	5350.00	64.8 PK	74.0	-9.2	1.10 V	284	23.65	41.15
2	5350.00	53.3 AV	54.0	-0.7	1.10 V	284	12.15	41.15
3	*5745.00	123.1 PK			1.10 V	284	80.73	42.37
4	*5745.00	113.1 AV			1.10 V	284	70.73	42.37
5	11490.00	62.5 PK	74.0	-11.5	1.22 V	102	13.74	48.76
6	11490.00	51.9 AV	54.0	-2.1	1.22 V	102	3.14	48.76

REMARKS:

1. Emission level (dBuV/m) = Raw Value (dBuV) + Correction Factor (dB/m).
2. Correction Factor (dB/m) = Antenna Factor (dB/m) + Cable Factor (dB).
3. The other emission levels were very low against the limit.
4. Margin value = Emission level – Limit value.
5. " * ": Fundamental frequency.
6. The limit value is defined as per 15.247.



A D T

CHANNEL	TX Channel 157	DETECTOR FUNCTION	Peak (PK)
FREQUENCY RANGE	1GHz ~ 40GHz		Average (AV)

ANTENNA POLARITY & TEST DISTANCE: HORIZONTAL AT 3 M

NO.	FREQ. (MHz)	EMISSION LEVEL (dBuV/m)	LIMIT (dBuV/m)	MARGIN (dB)	ANTENNA HEIGHT (m)	TABLE ANGLE (Degree)	RAW VALUE (dBuV)	CORRECTION FACTOR (dB/m)
1	5350.00	56.1 PK	74.0	-17.9	1.06 H	282	14.95	41.15
2	5350.00	43.4 AV	54.0	-10.6	1.06 H	282	2.25	41.15
3	*5785.00	111.3 PK			1.08 H	300	68.86	42.44
4	*5785.00	102.5 AV			1.08 H	300	60.06	42.44
5	11570.00	62.0 PK	74.0	-12.0	1.25 H	77	13.29	48.71
6	11570.00	51.3 AV	54.0	-2.7	1.25 H	77	2.59	48.71

ANTENNA POLARITY & TEST DISTANCE: VERTICAL AT 3 M

NO.	FREQ. (MHz)	EMISSION LEVEL (dBuV/m)	LIMIT (dBuV/m)	MARGIN (dB)	ANTENNA HEIGHT (m)	TABLE ANGLE (Degree)	RAW VALUE (dBuV)	CORRECTION FACTOR (dB/m)
1	5350.00	66.1 PK	74.0	-7.9	1.09 V	286	24.95	41.15
2	5350.00	53.4 AV	54.0	-0.6	1.09 V	286	12.25	41.15
3	*5785.00	121.3 PK			1.09 V	286	78.86	42.44
4	*5785.00	112.5 AV			1.09 V	286	70.06	42.44
5	11570.00	61.6 PK	74.0	-12.4	1.20 V	93	12.89	48.71
6	11570.00	51.0 AV	54.0	-3.0	1.20 V	93	2.29	48.71

REMARKS:

1. Emission level (dBuV/m) = Raw Value (dBuV) + Correction Factor (dB/m).
2. Correction Factor (dB/m) = Antenna Factor (dB/m) + Cable Factor (dB).
3. The other emission levels were very low against the limit.
4. Margin value = Emission level – Limit value.
5. " * ": Fundamental frequency.
6. The limit value is defined as per 15.247.



A D T

CHANNEL	TX Channel 165	DETECTOR FUNCTION	Peak (PK)
FREQUENCY RANGE	1GHz ~ 40GHz		Average (AV)

ANTENNA POLARITY & TEST DISTANCE: HORIZONTAL AT 3 M

NO.	FREQ. (MHz)	EMISSION LEVEL (dBuV/m)	LIMIT (dBuV/m)	MARGIN (dB)	ANTENNA HEIGHT (m)	TABLE ANGLE (Degree)	RAW VALUE (dBuV)	CORRECTION FACTOR (dB/m)
1	5460.00	54.5 PK	74.0	-19.5	1.07 H	260	12.99	41.51
2	5460.00	43.3 AV	54.0	-10.7	1.07 H	260	1.79	41.51
3	*5825.00	110.9 PK			1.10 H	295	68.33	42.57
4	*5825.00	102.7 AV			1.10 H	295	60.13	42.57
5	11650.00	61.9 PK	74.0	-12.1	1.24 H	95	12.98	48.92
6	11650.00	51.3 AV	54.0	-2.7	1.24 H	95	2.38	48.92

ANTENNA POLARITY & TEST DISTANCE: VERTICAL AT 3 M

NO.	FREQ. (MHz)	EMISSION LEVEL (dBuV/m)	LIMIT (dBuV/m)	MARGIN (dB)	ANTENNA HEIGHT (m)	TABLE ANGLE (Degree)	RAW VALUE (dBuV)	CORRECTION FACTOR (dB/m)
1	5460.00	64.5 PK	74.0	-9.5	1.31 V	282	22.99	41.51
2	5460.00	53.3 AV	54.0	-0.7	1.31 V	282	11.79	41.51
3	*5825.00	120.9 PK			1.31 V	282	78.33	42.57
4	*5825.00	112.7 AV			1.31 V	282	70.13	42.57
5	11650.00	62.0 PK	74.0	-12.0	1.17 V	72	13.08	48.92
6	11650.00	51.8 AV	54.0	-2.2	1.17 V	72	2.88	48.92

REMARKS:

1. Emission level (dBuV/m) = Raw Value (dBuV) + Correction Factor (dB/m).
2. Correction Factor (dB/m) = Antenna Factor (dB/m) + Cable Factor (dB).
3. The other emission levels were very low against the limit.
4. Margin value = Emission level – Limit value.
5. " * " : Fundamental frequency.
6. The limit value is defined as per 15.247.



A D T

802.11n (HT40)

CHANNEL	TX Channel 151	DETECTOR FUNCTION	Peak (PK)
FREQUENCY RANGE	1GHz ~ 40GHz		Average (AV)

ANTENNA POLARITY & TEST DISTANCE: HORIZONTAL AT 3 M

NO.	FREQ. (MHz)	EMISSION LEVEL (dBuV/m)	LIMIT (dBuV/m)	MARGIN (dB)	ANTENNA HEIGHT (m)	TABLE ANGLE (Degree)	RAW VALUE (dBuV)	CORRECTION FACTOR (dB/m)
1	5350.00	55.7 PK	74.0	-18.3	1.11 H	274	14.55	41.15
2	5350.00	43.4 AV	54.0	-10.6	1.11 H	274	2.25	41.15
3	*5755.00	110.3 PK			1.04 H	288	67.91	42.39
4	*5755.00	100.4 AV			1.04 H	288	58.01	42.39
5	11510.00	62.1 PK	74.0	-11.9	1.19 H	74	13.36	48.74
6	11510.00	51.4 AV	54.0	-2.6	1.19 H	74	2.66	48.74

ANTENNA POLARITY & TEST DISTANCE: VERTICAL AT 3 M

NO.	FREQ. (MHz)	EMISSION LEVEL (dBuV/m)	LIMIT (dBuV/m)	MARGIN (dB)	ANTENNA HEIGHT (m)	TABLE ANGLE (Degree)	RAW VALUE (dBuV)	CORRECTION FACTOR (dB/m)
1	5350.00	65.7 PK	74.0	-8.3	1.10 V	284	24.55	41.15
2	5350.00	53.4 AV	54.0	-0.6	1.10 V	284	12.25	41.15
3	*5755.00	120.3 PK			1.10 V	283	77.91	42.39
4	*5755.00	110.4 AV			1.10 V	283	68.01	42.39
5	11510.00	62.2 PK	74.0	-11.8	1.23 V	86	13.46	48.74
6	11510.00	51.9 AV	54.0	-2.1	1.23 V	86	3.16	48.74

REMARKS:

1. Emission level (dBuV/m) = Raw Value (dBuV) + Correction Factor (dB/m).
2. Correction Factor (dB/m) = Antenna Factor (dB/m) + Cable Factor (dB).
3. The other emission levels were very low against the limit.
4. Margin value = Emission level – Limit value.
5. " * ": Fundamental frequency.
6. The limit value is defined as per 15.247.



A D T

CHANNEL	TX Channel 159	DETECTOR FUNCTION	Peak (PK)
FREQUENCY RANGE	1GHz ~ 40GHz		Average (AV)

ANTENNA POLARITY & TEST DISTANCE: HORIZONTAL AT 3 M

NO.	FREQ. (MHz)	EMISSION LEVEL (dBuV/m)	LIMIT (dBuV/m)	MARGIN (dB)	ANTENNA HEIGHT (m)	TABLE ANGLE (Degree)	RAW VALUE (dBuV)	CORRECTION FACTOR (dB/m)
1	5350.00	54.7 PK	74.0	-19.3	1.07 H	272	13.55	41.15
2	5350.00	43.2 AV	54.0	-10.8	1.07 H	272	2.05	41.15
3	*5795.00	107.3 PK			1.06 H	273	64.85	42.45
4	*5795.00	98.5 AV			1.06 H	273	56.05	42.45
5	11590.00	62.3 PK	74.0	-11.7	1.26 H	92	13.60	48.70
6	11590.00	51.6 AV	54.0	-2.4	1.26 H	92	2.90	48.70

ANTENNA POLARITY & TEST DISTANCE: VERTICAL AT 3 M

NO.	FREQ. (MHz)	EMISSION LEVEL (dBuV/m)	LIMIT (dBuV/m)	MARGIN (dB)	ANTENNA HEIGHT (m)	TABLE ANGLE (Degree)	RAW VALUE (dBuV)	CORRECTION FACTOR (dB/m)
1	5350.00	64.7 PK	74.0	-9.3	1.09 V	283	23.55	41.15
2	5350.00	53.2 AV	54.0	-0.8	1.09 V	283	12.05	41.15
3	*5795.00	117.3 PK			1.09 V	283	74.85	42.45
4	*5795.00	108.5 AV			1.09 V	283	66.05	42.45
5	11590.00	61.8 PK	74.0	-12.2	1.23 V	91	13.10	48.70
6	11590.00	51.3 AV	54.0	-2.7	1.23 V	91	2.60	48.70

REMARKS:

1. Emission level (dBuV/m) = Raw Value (dBuV) + Correction Factor (dB/m).
2. Correction Factor (dB/m) = Antenna Factor (dB/m) + Cable Factor (dB).
3. The other emission levels were very low against the limit.
4. Margin value = Emission level – Limit value.
5. " * ": Fundamental frequency.
6. The limit value is defined as per 15.247.

5.3 6dB BANDWIDTH MEASUREMENT

5.3.1 LIMITS OF 6dB BANDWIDTH MEASUREMENT

The minimum of 6dB Bandwidth Measurement is 0.5 MHz.

5.3.2 TEST INSTRUMENTS

DESCRIPTION & MANUFACTURER	MODEL NO.	SERIAL NO.	CALIBRATED DATE	CALIBRATED UNTIL
R&S SPECTRUM ANALYZER	FSP40	100037	Nov. 01, 2012	Oct. 31, 2013

Note:

1. The calibration interval of the above test instruments is 12 months and the calibrations are traceable to NML/ROC and NIST/USA.
2. Tested date : Apr. 11, 2013

5.3.3 TEST PROCEDURE

1. Set resolution bandwidth (RBW) = 100kHz
2. Set the video bandwidth (VBW) $\geq 3 \times$ RBW, Detector = Peak.
3. Trace mode = max hold.
4. Sweep = auto couple.
5. Measure the maximum width of the emission that is constrained by the frequencies associated with the two amplitude points (upper and lower) that are attenuated by 6 dB relative to the maximum level measured in the fundamental emission

5.3.4 DEVIATION FROM TEST STANDARD

No deviation

5.3.5 TEST SETUP

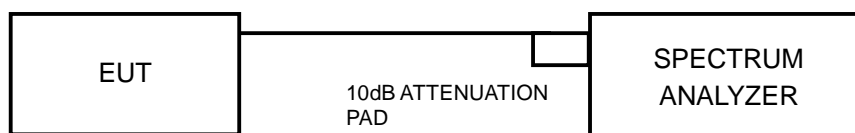

5.3.6 EUT OPERATING CONDITIONS

The software provided by client to enable the EUT under transmission condition continuously at lowest, middle and highest channel frequencies individually.



A D T

5.3.7 TEST RESULTS

802.11a

CHANNEL	FREQUENCY (MHz)	6dB BANDWIDTH (MHz)	MINIMUM LIMIT (MHz)	PASS / FAIL
149	5745	15.72	0.5	PASS
157	5785	16.09	0.5	PASS
165	5825	15.77	0.5	PASS

802.11n (HT20)

CHANNEL	CHANNEL FREQUENCY (MHz)	6dB BANDWIDTH (MHz)		MINIMUM LIMIT (MHz)	PASS / FAIL
		CHAIN 0	CHAIN 1		
149	5745	16.58	16.58	0.5	PASS
157	5785	16.09	16.37	0.5	PASS
165	5825	16.08	16.12	0.5	PASS

802.11n (HT40)

CHANNEL	CHANNEL FREQUENCY (MHz)	6dB BANDWIDTH (MHz)		MINIMUM LIMIT (MHz)	PASS / FAIL
		CHAIN 0	CHAIN 1		
151	5755	35.22	35.57	0.5	PASS
159	5795	34.26	35.40	0.5	PASS

5.4 CONDUCTED OUTPUT POWER MEASUREMENT

5.4.1 LIMITS OF CONDUCTED OUTPUT POWER MEASUREMENT

For systems using digital modulation in the 5725 –5850 MHz band: 1 Watt (30dBm)

Per KDB 662911 D01 Multiple Transmitter Output v01r02 Method of conducted output power measurement on IEEE 802.11 devices,

- Array Gain = 0 dB (i.e., no array gain) for NANT \leq 4;
- Array Gain = 0 dB (i.e., no array gain) for channel widths \geq 40 MHz for any NANT;
- Array Gain = 5 log(NANT/NSS) dB or 3 dB, whichever is less for 20-MHz channel widths with NANT \geq 5.

For power measurements on all other devices: Array Gain = 10 log(NANT/NSS) dB.

5.4.2 INSTRUMENTS

DESCRIPTION & MANUFACTURER	MODEL NO.	SERIAL NO.	CALIBRATED DATE	CALIBRATED UNTIL
Power Meter	ML2495A	0824006	May 10, 2012	May 09, 2013
Power Sensor	MA2411B	0738172	May 10, 2012	May 09, 2013

- Note:** 3. The calibration interval of the above test instruments is 12 months and the calibrations are traceable to NML/ROC and NIST/USA.
 4. Tested date : Apr. 11, 2013

5.4.3 TEST PROCEDURES

The peak power sensor was used on the output port of the EUT. A power meter was used to read the response of the peak power sensor. Record the peak power level.

5.4.4 DEVIATION FROM TEST STANDARD

No deviation.

5.4.5 TEST SETUP

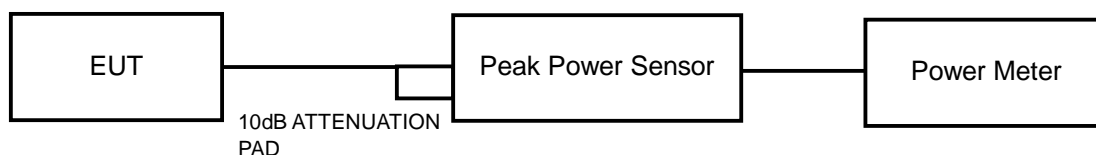

5.4.6 EUT OPERATING CONDITIONS

Same as Item 5.3.6



A D T

5.4.7 TEST RESULTS

802.11a

CHANNEL	FREQUENCY (MHz)	PEAK POWER (mW)	PEAK POWER (dBm)	LIMIT (dBm)	PASS/FAIL
149	5745	301.301	24.79	30.00	PASS
157	5785	319.890	25.05	30.00	PASS
165	5825	359.749	25.56	30.00	PASS

802.11n (HT20)

CHAN.	CHAN. FREQ. (MHz)	PEAK POWER (dBm)		TOTAL POWER (mW)	TOTAL POWER (dBm)	LIMIT (dBm)	PASS / FAIL
		CHAIN 0	CHAIN 1				
149	5745	24.83	24.93	615.261	27.89	30.00	PASS
157	5785	25.16	25.07	649.461	28.13	30.00	PASS
165	5825	25.62	25.26	700.492	28.45	30.00	PASS

802.11n (HT40)

CHAN.	CHAN. FREQ. (MHz)	PEAK POWER (dBm)		TOTAL POWER (mW)	TOTAL POWER (dBm)	LIMIT (dBm)	PASS / FAIL
		CHAIN 0	CHAIN 1				
151	5755	24.86	24.81	608.887	27.85	30.00	PASS
159	5795	25.24	25.06	654.822	28.16	30.00	PASS

5.5 AVERAGE OUTPUT POWER

5.5.1 FOR REFERENCE.

5.5.2 TEST INSTRUMENTS

DESCRIPTION & MANUFACTURER	MODEL NO.	SERIAL NO.	CALIBRATED DATE	CALIBRATED UNTIL
Power Meter	ML2495A	0824006	May 10, 2012	May 09, 2013
Power Sensor	MA2411B	0738172	May 10, 2012	May 09, 2013

Note:

1. The calibration interval of the above test instruments is 12 months and the calibrations are traceable to NML/ROC and NIST/USA.
2. Tested date : Apr. 11, 2013

5.5.3 TEST PROCEDURES

The average power sensor was used on the output port of the EUT. A power meter was used to read the response of the power sensor. Record the power level.

5.5.4 TEST SETUP

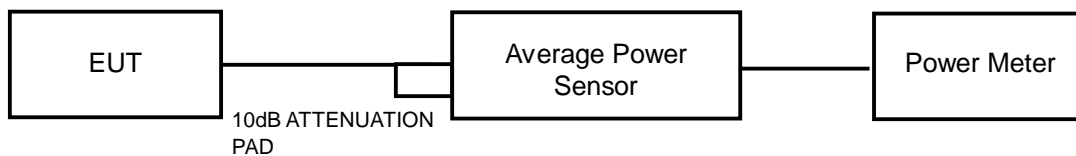

5.5.5 EUT OPERATING CONDITIONS

Same as Item 4.3.6



A D T

5.5.6 TEST RESULTS

802.11a

CHAN.	FREQUENCY (MHz)	AVERAGE POWER (mW)	AVERAGE POWER (dBm)
149	5745	206.063	23.14
157	5785	261.818	24.18
165	5825	170.216	22.31

802.11n (HT20)

CHAN.	FREQUENCY (MHz)	AVERAGE POWER (dBm)		TOTAL POWER (mW)	TOTAL POWER (dBm)
		CHAIN 0	CHAIN 1		
149	5745	22.76	23.36	405.569	26.08
157	5785	22.61	23.13	387.979	25.89
165	5825	22.05	22.66	344.827	25.38

802.11n (HT40)

CHAN.	FREQUENCY (MHz)	AVERAGE POWER (dBm)		TOTAL POWER (mW)	TOTAL POWER (dBm)
		CHAIN 0	CHAIN 1		
151	5755	21.58	21.53	286.113	24.57
159	5795	23.91	23.71	481.000	26.82

5.6 POWER SPECTRAL DENSITY MEASUREMENT

5.6.1 LIMITS OF POWER SPECTRAL DENSITY MEASUREMENT

The Maximum of Power Spectral Density Measurement is 8dBm.

5.6.2 TEST INSTRUMENTS

DESCRIPTION & MANUFACTURER	MODEL NO.	SERIAL NO.	CALIBRATED DATE	CALIBRATED UNTIL
R&S Spectrum Analyzer	FSP40	100037	Nov. 01, 2012	Oct. 31, 2013

Note:

1. The calibration interval of the above test instruments is 12 months and the calibrations are traceable to NML/ROC and NIST/USA.
2. Tested date : Apr. 11, 2013

5.6.3 TEST PROCEDURE

1. Set the RBW = 3 kHz, VBW =10 kHz, Detector = peak.
2. Sweep time = auto couple, Trace mode = max hold, allow trace to fully stabilize.
3. Use the peak marker function to determine the maximum amplitude level.

5.6.4 DEVIATION FROM TEST STANDARD

No deviation

5.6.5 TEST SETUP

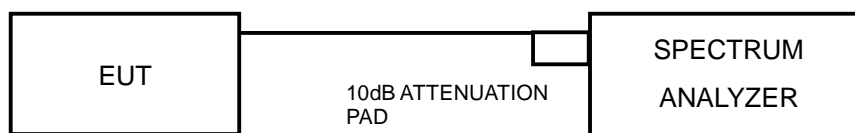

5.6.6 EUT OPERATING CONDITION

Same as Item 4.3.6



A D T

5.6.7 TEST RESULTS

802.11a

Channel	FREQUENCY (MHz)	PSD (dBm/3kHz)	Limit (dBm/3kHz)	PASS /FAIL
149	5745	-1.37	8.00	PASS
157	5785	-1.85	8.00	PASS
165	5825	-1.69	8.00	PASS

802.11n (HT20)

TX chain	Channel	FREQ. (MHz)	PSD (dBm/3kHz)	10 log (N=2) dB	Total PSD (dBm/3kHz)	Limit (dBm/3kHz)	PASS /FAIL
0	149	5745	-2.34	3.01	0.67	6.28	PASS
	157	5785	-1.80	3.01	1.21	6.28	PASS
	165	5825	-4.53	3.01	-1.52	6.28	PASS
1	149	5745	-1.94	3.01	1.07	6.28	PASS
	157	5785	-0.95	3.01	2.06	6.28	PASS
	165	5825	-0.68	3.01	2.33	6.28	PASS

NOTE: Directional gain = $10 \log[(10^{G1/20} + 10^{G2/20})^2 / 2] = 7.72\text{dBi} > 6\text{dBi}$, so the power density limit shall be reduced to $8 - (7.72 - 6) = 6.28\text{dBm}$.

802.11n (HT40)

TX chain	Channel	FREQ. (MHz)	PSD (dBm/3kHz)	10 log (N=2) dB	Total PSD (dBm/3kHz)	Limit (dBm/3kHz)	PASS /FAIL
0	151	5755	-4.26	3.01	-1.25	6.28	PASS
	159	5795	-2.81	3.01	0.20	6.28	PASS
1	151	5755	-3.68	3.01	-0.67	6.28	PASS
	159	5795	-1.04	3.01	1.97	6.28	PASS

NOTE: Directional gain = $10 \log[(10^{G1/20} + 10^{G2/20})^2 / 2] = 7.72\text{dBi} > 6\text{dBi}$, so the power density limit shall be reduced to $8 - (7.72 - 6) = 6.28\text{dBm}$.

5.7 CONDUCTED OUT-BAND EMISSION MEASUREMENT

5.7.1 LIMITS OF CONDUCTED OUT-BAND EMISSION MEASUREMENT

Below 20dB of the highest emission level of operating band (in 100kHz Resolution Bandwidth).

5.7.2 TEST INSTRUMENTS

DESCRIPTION & MANUFACTURER	MODEL NO.	SERIAL NO.	CALIBRATED DATE	CALIBRATED UNTIL
R&S Spectrum Analyzer	FSP40	100037	Nov. 01, 2012	Oct. 31, 2013

Note:

1. The calibration interval of the above test instruments is 12 months and the calibrations are traceable to NML/ROC and NIST/USA.
2. Tested date : Apr. 11, 2013

5.7.3 TEST PROCEDURE

Measurement Procedure - Reference Level

1. Set the RBW = 100 kHz.
2. Set the VBW \geq 300 kHz.
3. Detector = peak.
4. Sweep time = auto couple.
5. Trace mode = max hold.
6. Allow trace to fully stabilize.
7. Use the peak marker function to determine the maximum power level in any 100 kHz band segment within the fundamental EBW.

Measurement Procedure –Unwanted Emission Level

1. Set RBW = 100 kHz.
2. Set VBW \geq 300 kHz.
3. Set span to encompass the spectrum to be examined
4. Detector = peak.
5. Trace Mode = max hold.
6. Sweep = auto couple.

5.7.4 DEVIATION FROM TEST STANDARD

No deviation

5.7.5 TEST SETUP

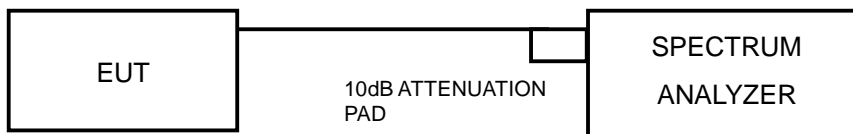

5.7.6 EUT OPERATING CONDITION

Same as Item 4.3.6

5.7.7 TEST RESULTS

The spectrum plots are attached on the following pages. D1 line indicates the highest level, and D2 line indicates the 20dB offset below D1. It shows compliance with the requirement.



A D T

802.11a

CH 149

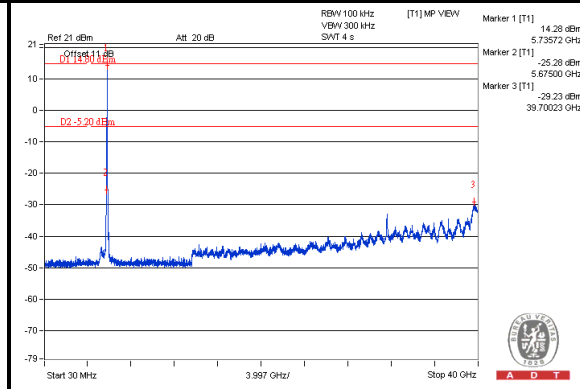
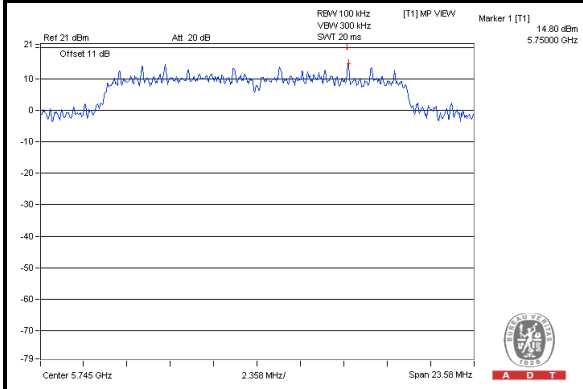

CH 157

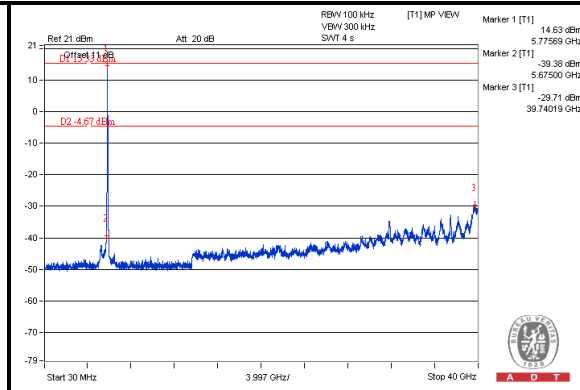
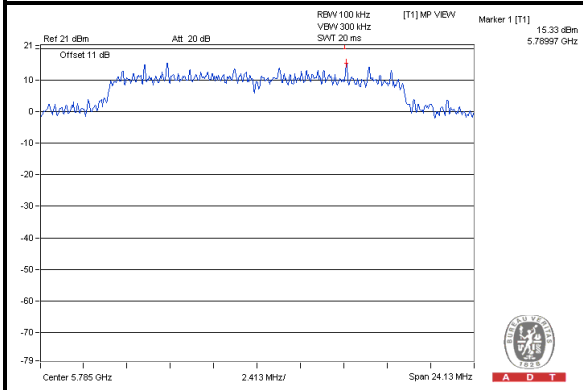

CH 165

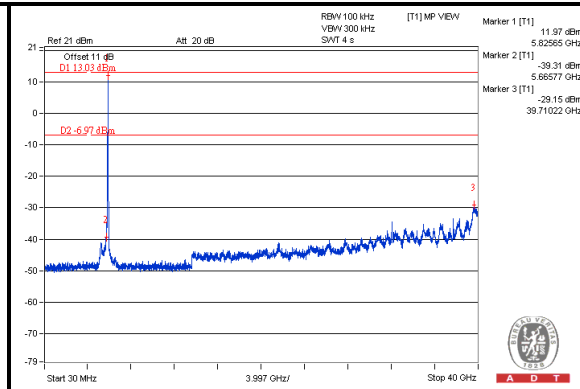
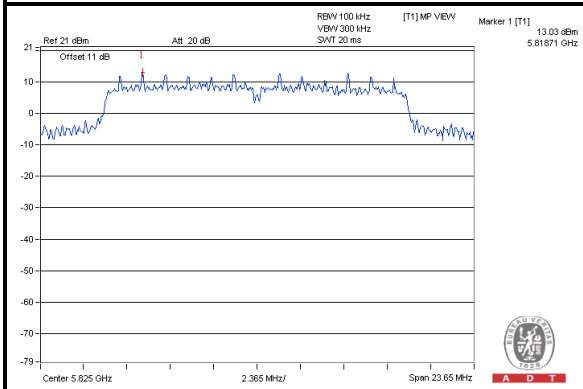



A D T

802.11n (HT20):

Chain (0)

CH 149

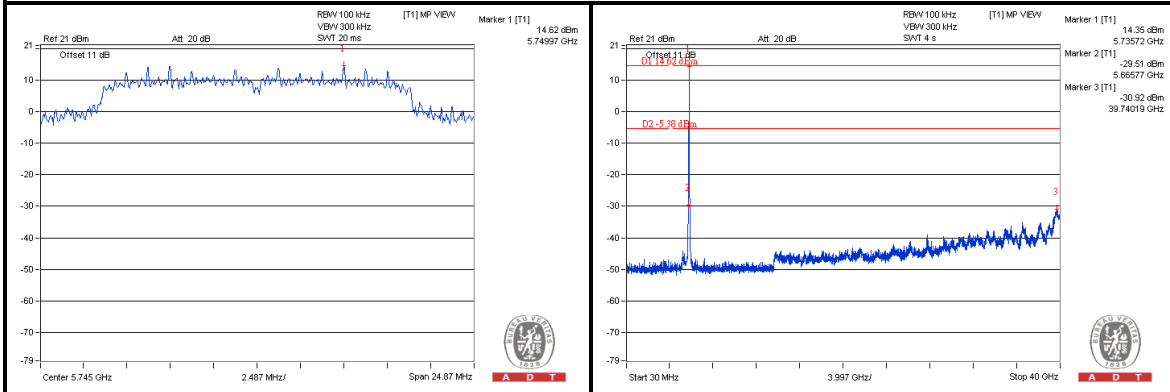

CH 157

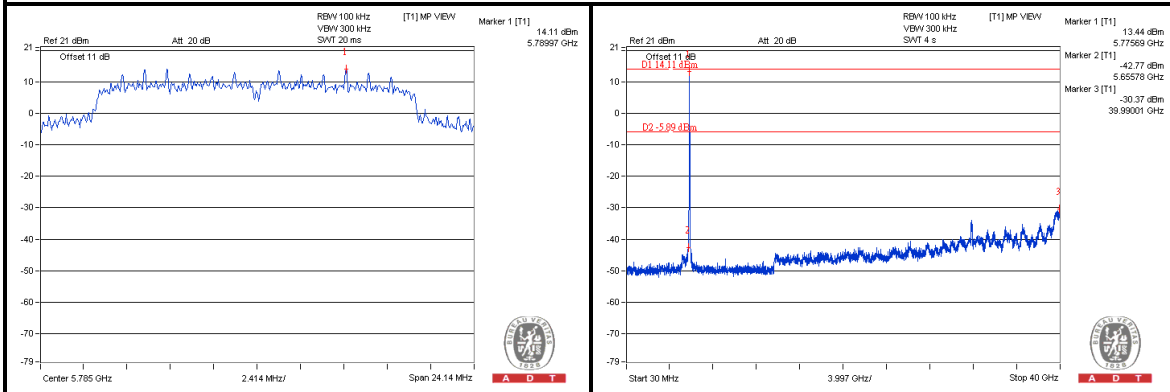

CH 165

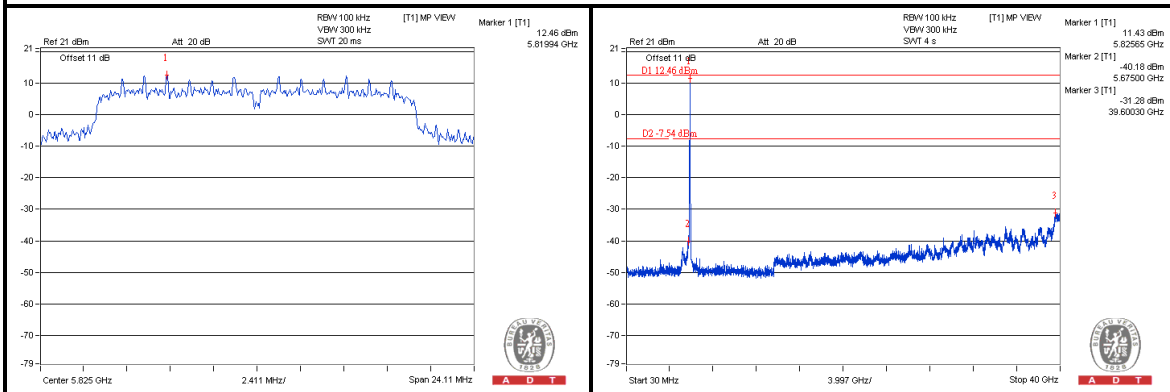



A D T

Chain (1) CH 149

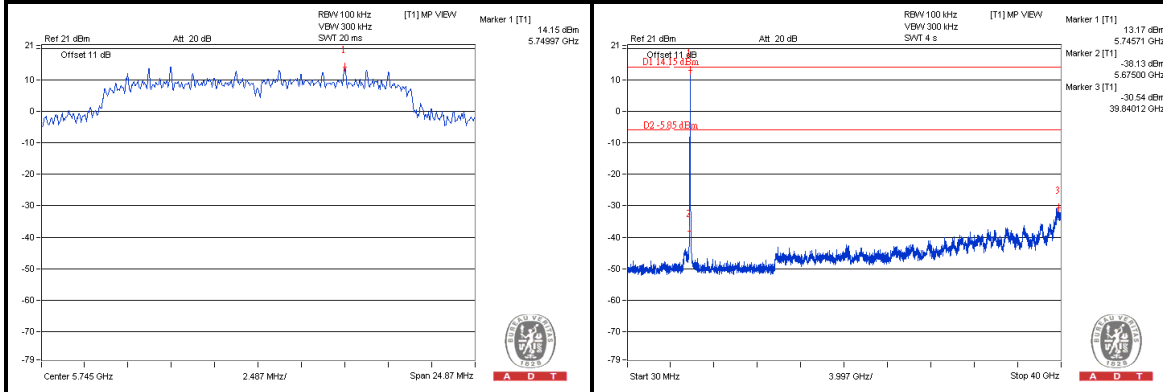

CH 157

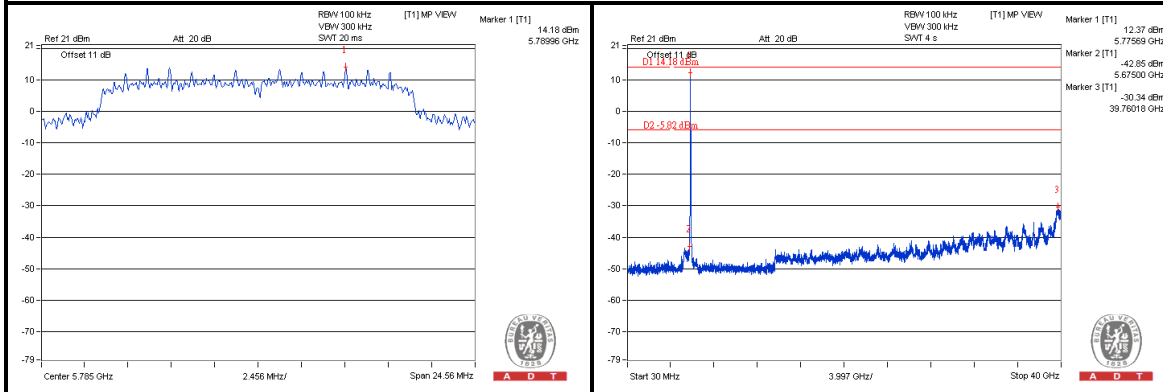

CH 165

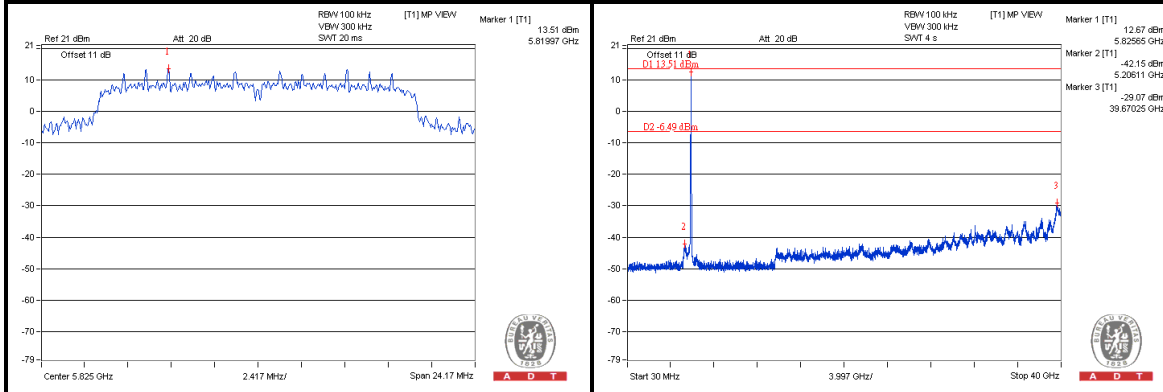



A D T

802.11n (HT40):

Chain (0)

CH 15

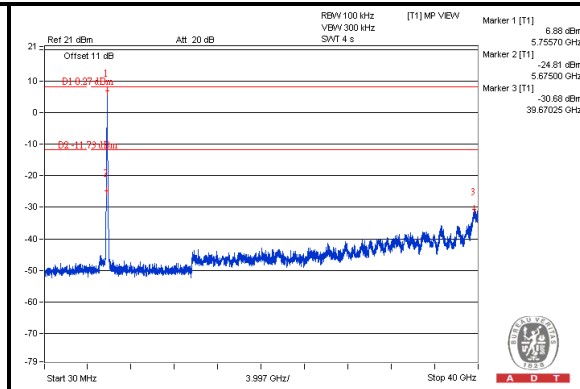
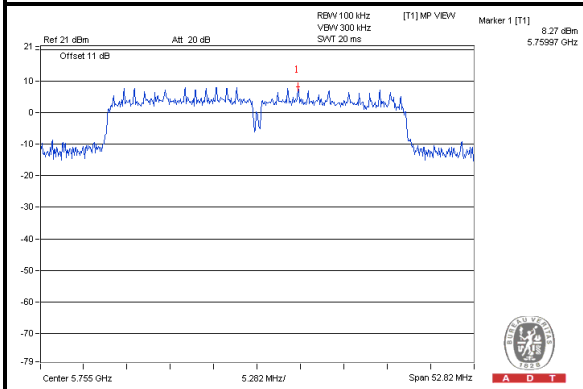

CH 159

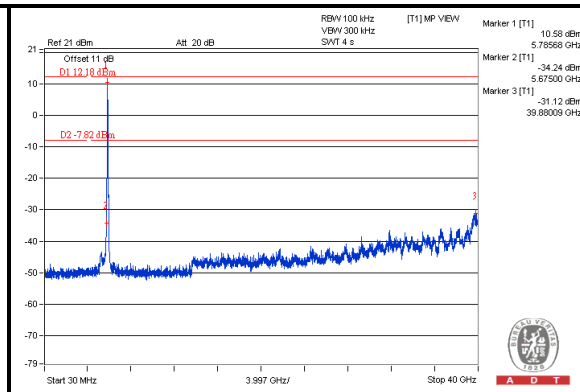
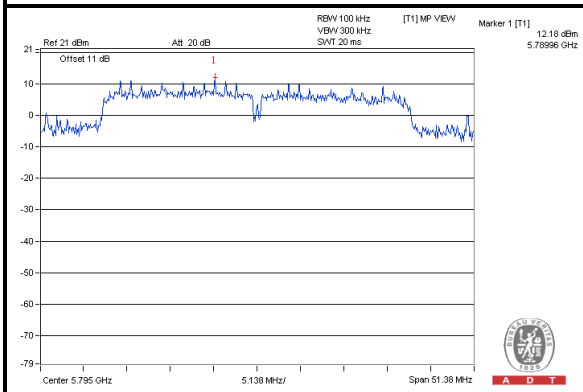



A D T

Chain (1)

CH 151

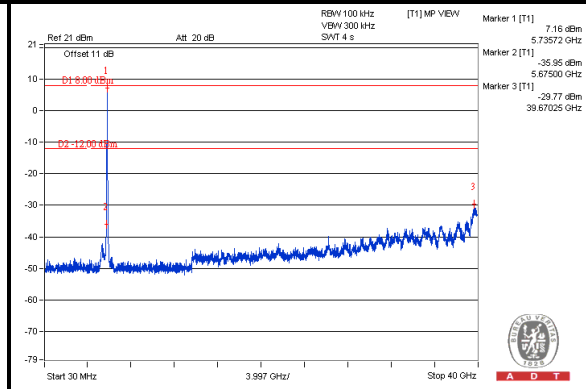
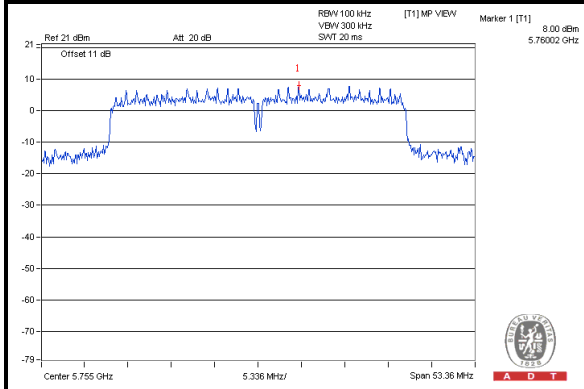

CH 159

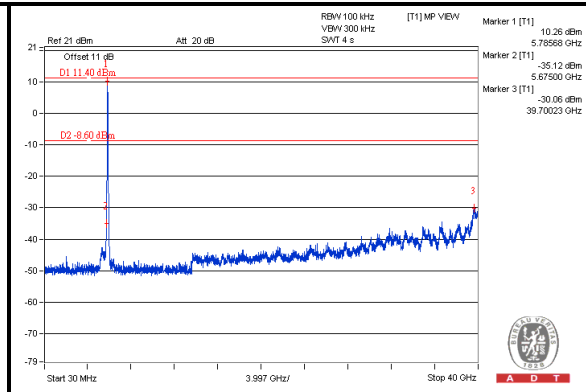
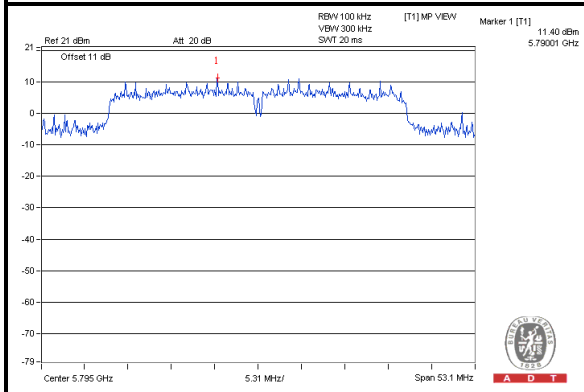

6. PHOTOGRAPHS OF THE TEST CONFIGURATION

Please refer to the attached file (Test Setup Photo).



7. INFORMATION ON THE TESTING LABORATORIES

We, Bureau Veritas Consumer Products Services (H.K.) Ltd., Taoyuan Branch, were founded in 1988 to provide our best service in EMC, Radio, Telecom and Safety consultation. Our laboratories are accredited and approved according to ISO/IEC 17025.

If you have any comments, please feel free to contact us at the following:

Linko EMC/RF Lab:

Tel: 886-2-26052180

Fax: 886-2-26052943

Hsin Chu EMC/RF Lab:

Tel: 886-3-5935343

Fax: 886-3-5935342

Hwa Ya EMC/RF/Safety/Telecom Lab:

Tel: 886-3-3183232

Fax: 886-3-3270892

Email: service.adt@tw.bureauveritas.com

Web Site: www.bureauveritas-adt.com

The address and road map of all our labs can be found in our web site also.



A D T

8. APPENDIX A - MODIFICATIONS RECORDERS FOR ENGINEERING CHANGES TO THE EUT BY THE LAB

No modifications were made to the EUT by the lab during the test.

--- END ---