RADIO TEST REPORT

FCC 47 CFR PART 15 SUBPART C

INDUSTRY CANADA RSS-247

Test Standard	FCC Part 15.247 and RSS-247 Issue 2
FCC ID	XU8TEW740APBOV2
ISED No.	6337A-740APBOV2
Product name	10 dBi Wireless N300 Outdoor PoE Access Point 10 dBi Wireless N300 Outdoor PoE Preconfigured Point-to-Point Bridge Kit
Model No.	TEW-740APBO V2.0, TEW-740APBO2K
Trade name	TRENDnet
Test Result	Pass

The test Result was tested by Compliance Certification Services Inc. The test data, data evaluation, test procedures, and equipment configurations shown in this report were given in ANSI C63.10: 2013 and compliance standards.

The test results of this report relate only to the tested sample (EUT) identified in this report.

The test Report of full or partial shall not copy. Without written approval of Compliance Certification Services Inc. (Wugu Laboratory)



Approved by:

Handwritten signature of Sam Chuang in black ink.

Sam Chuang
Manager

Tested by:

Handwritten signature of Ed Chiang in black ink.

Ed Chiang
Engineer

Revision History

Rev.	Issue Date	Revisions	Revised By
00	May 22, 2017	Initial Issue	Vicki Huang
01	August 25, 2017	<ol style="list-style-type: none"> 1. Added Directional Gain in P.5 2. Modify Peak and Average output power in P.4, 25~26 3. Revise section 4.3's limit in P.24~25 4. Revise section 4.4's limit in P.27~28 	Vicki Huang
02	September 11, 2017	<ol style="list-style-type: none"> 1. Modify Directional Gain in P.5 2. Modify Output Power in P.4 3. Modify Peak and Average output power in P.4, 25~26 4. Modify section 4.4's limit in P.28 	Vicki Huang

Table of contents

1. GENERAL INFORMATION.....	4
1.1 EUT INFORMATION	4
1.2 EUT CHANNEL INFORMATION.....	5
1.3 ANTENNA INFORMATION.....	5
1.4 MEASUREMENT UNCERTAINTY.....	6
1.5 FACILITIES AND TEST LOCATION	7
1.6 INSTRUMENT CALIBRATION	7
1.7 SUPPORT AND EUT ACCESSORIES EQUIPMENT.....	8
1.8 TEST METHODOLOGY AND APPLIED STANDARDS	8
1.9 TABLE OF ACCREDITATIONS AND LISTINGS	8
2. TEST SUMMERY	9
3. DESCRIPTION OF TEST MODES.....	10
3.1 THE WORST MODE OF OPERATING CONDITION.....	10
3.2 THE WORST MODE OF MEASUREMENT	11
3.3 EUT DUTY CYCLE	12
4. TEST RESULT	13
4.1 AC POWER LINE CONDUCTED EMISSION	13
4.2 6DB BANDWIDTH AND OCCUPIED BANDWIDTH(99%).....	14
4.3 OUTPUT POWER MEASUREMENT	24
4.4 POWER SPECTRAL DENSITY	27
4.5 CONDUCTED BANEDGE AND SPURIOUS EMISSION	35
4.6 RADIATION BANEDGE AND SPURIOUS EMISSION	52
APPENDIX 1 - PHOTOGRAPHS OF EUT	

1. GENERAL INFORMATION

1.1 EUT INFORMATION

Applicant	TRENDnet, Inc. 20675 Manhattan Place, Torrance, CA 90501 USA		
Manufacturer	TRENDnet, Inc. 20675 Manhattan Place, Torrance, CA 90501 USA		
Equipment	10 dBi Wireless N300 Outdoor PoE Access Point 10 dBi Wireless N300 Outdoor PoE Preconfigured Point-to-Point Bridge Kit		
Model Name	TEW-740APBO V2.0, TEW-740APBO2K		
Model Difference	Product	Model Number	Difference
	10 dBi Wireless N300 Outdoor PoE Access Point	TEW-740APBO V2.0	(1) Default IP change (2) Default SSID/encryption change
	10 dBi Wireless N300 Outdoor PoE Preconfigured Point-to-Point Bridge Kit	TEW-740APBO2K	(3) UI model name change
Trade Name	TRENDnet		
Received Date	December 21, 2016		
Date of Test	January 14 ~ March 19, 2017		
Output Power(W)	IEEE 802.11b Mode: 0.0392 IEEE 802.11g Mode: 0.1914 IEEE 802.11n HT 20 MHz Mode: 0.2153 IEEE 802.11n HT 40 MHz Mode: 0.2198		
Power Adapter	1. Powertron Electronics Corp. / Model: PA1024-4I/PA1024-4IB/PA1024-480IB050 I/P: 100-240V, 50-60Hz, 0.6A O/P: 48, 0.5A, 24W Max 2. UNIFIVE / Model: UEC345-4808 I/P: AC 100-240V, 50-60Hz, 1A O/P: DC 48V, 0.875A 3. LEADER ELECTRONICS INC. / Model: MU24-B480050-A1 I/P: 100-240V, 50-60Hz, 1.0A O/P: 48V, 0.5A 4. LEI / Model: MU24A5480050-A1 (Label 6) I/P: 100-240V, 50-60Hz, 0.7A O/P: 48V, 0.5A 5. DVE / DSA-12PFT-12FUS I/P: 100-240V, 50-60Hz, 0.5A O/P: 12V, 1A		

1.2 EUT CHANNEL INFORMATION

Frequency Range	2412MHz-2462MHz
Modulation Type	1. IEEE 802.11b Mode: CCK 2. IEEE 802.11g Mode: OFDM 3. IEEE 802.11n HT 20 MHz Mode: OFDM 4. IEEE 802.11n HT 40 MHz Mode: OFDM
Number of channel	1. IEEE 802.11b Mode: 11 Channels 2. IEEE 802.11g Mode: 11 Channels 3. IEEE 802.11n HT 20 MHz Mode: 11 Channels 4. IEEE 802.11n HT 40 MHz Mode: 9 Channels

Remark:

Refer as ANSI 63.10:2013 clause 5.6.1 Table 4 and RSS-GEN Table A1 for test channels

Number of frequencies to be tested		
Frequency range in which device operates	Number of frequencies	Location in frequency range of operation
<input type="checkbox"/> 1 MHz or less	1	Middle
<input type="checkbox"/> 1 MHz to 10 MHz	2	1 near top and 1 near bottom
<input checked="" type="checkbox"/> More than 10 MHz	3	1 near top, 1 near middle, and 1 near bottom

1.3 ANTENNA INFORMATION

Antenna Type	<input type="checkbox"/> PIFA <input type="checkbox"/> PCB <input checked="" type="checkbox"/> Dipole <input type="checkbox"/> Coils
Antenna Gain	9.12 dBi Directional Gain:12.13dBi

Note:

$Directional\ gain = 9.12\ dBi + 10\log(2) = 12.13\ dBi$

1.4 MEASUREMENT UNCERTAINTY

PARAMETER	UNCERTAINTY
AC Powerline Conducted Emission	+/- 1.2575
Emission bandwidth, 20dB bandwidth	+/- 1.4003
RF output power, conducted	+/- 1.1372
Power density, conducted	+/- 1.4003
3M Semi Anechoic Chamber / 30M~200M	+/- 4.0138
3M Semi Anechoic Chamber / 200M~1000M	+/- 3.9483
3M Semi Anechoic Chamber / 1G~8G	+/- 2.5975
3M Semi Anechoic Chamber / 8G~18G	+/- 2.6112
3M Semi Anechoic Chamber / 18G~26G	+/- 2.7389
3M Semi Anechoic Chamber / 26G~40G	+/- 2.9683
3M Semi Anechoic Chamber / 40G~60G	+/- 1.8509
3M Semi Anechoic Chamber / 60G~75G	+/- 1.9869
3M Semi Anechoic Chamber / 75G~110G	+/- 2.9651
3M Semi Anechoic Chamber / 110G~170G	+/- 2.7807
3M Semi Anechoic Chamber / 170G~220G	+/- 3.6437
3M Semi Anechoic Chamber / 220G~325G	+/- 4.2982

Remark:

1. This uncertainty represents an expanded uncertainty expressed at approximately the 95% confidence level using a coverage factor of $k=2$
2. ISO/IEC 17025 requires that an estimate of the measurement uncertainties associated with the emissions test results be included in the report.

1.5 FACILITIES AND TEST LOCATION

All measurement facilities used to collect the measurement data are located at
 No.11, Wugong 6th Rd., Wugu Dist., New Taipei City 24891, Taiwan. (R.O.C.)

Test site	Test Engineer	Remark
AC Conduction Room	Ed Chiang	
Radiation	Ed Chiang	
RF Conducted	Eric Lee	

Remark: The sites are constructed in conformance with the requirements of ANSI C63.7, ANSI C63.4 and CISPR Publication 22.

1.6 INSTRUMENT CALIBRATION

RF Conducted Test Site					
Name of Equipment	Manufacturer	Model	Serial Number	Calibration Date	Calibration Due
Power Meter	Anritsu	ML2495A	1012009	07/04/2016	07/03/2017
Power Sensor	Anritsu	MA2411B	917072	07/04/2016	07/03/2017
Spectrum Analyzer	R&S	FSV 40	101073	10/05/2016	10/04/2017

Wugu 966 Chamber A					
Name of Equipment	Manufacturer	Model	Serial Number	Calibration Date	Calibration Due
Bilog Antenna	Sunol Sciences	JB3	A030105	07/03/2016	07/02/2017
Horn Antenna	EMCO	3117	00055165	02/20/2017	02/19/2018
Pre-Amplifier	EMCI	EMC 012635	980151	06/23/2016	06/22/2017
Pre-Amplifier	EMEC	EM330	060609	06/08/2016	06/07/2017
Spectrum Analyzer	Agilent	E4446A	US42510252	12/05/2016	12/04/2017
Antenna Tower	CCS	CC-A-1F	N/A	N.C.R	N.C.R
Controller	CCS	CC-C-1F	N/A	N.C.R	N.C.R
Turn Table	CCS	CC-T-1F	N/A	N.C.R	N.C.R
Software	EZ-EMC (CCS-3A1RE)				

Conducted Emission room # B					
Name of Equipment	Manufacturer	Model	Serial Number	Calibration Date	Calibration Due
EMI Test Receiver	R&S	ESCI	101073	08/20/2016	08/19/2017
LISN	R&S	ENV216	101054	05/11/2016	05/10/2017
LISN	Schwarzbeck	NSLK8128	5012	04/15/2016	04/14/2017
Test S/W			CCS-3A1-CE		

Remark: Each piece of equipment is scheduled for calibration once a year.

1.7 SUPPORT AND EUT ACCESSORIES EQUIPMENT

EUT Accessories Equipment					
No.	Equipment	Brand	Model	Series No.	FCC ID
	N/A				

Support Equipment					
No.	Equipment	Brand	Model	Series No.	FCC ID
1	Notebook	Lenovo	IBM 1951	N/A	N/A

1.8 TEST METHODOLOGY AND APPLIED STANDARDS

The test methodology, setups and results comply with all requirements in accordance with ANSI C63.10:2013, FCC Part 2, FCC Part 15.247, KDB 558074 D01 v03r05, RSS-247 Issue 2 and RSS-GEN Issue 4.

1.9 TABLE OF ACCREDITATIONS AND LISTINGS

Country	Agency	Scope of Accreditation	Logo
Canada	Industry Canada	3M Semi Anechoic Chamber (IC 2324G-1 / IC 2324G-2) to perform	 IC 2324G-1 IC 2324G-2

2. TEST SUMMERY

FCC Standard Section	IC Standard Section	Report Section	Test Item	Result
15.203	-	1.3	Antenna Requirement	Pass
15.207(a)	RSS-GEN 8.8	4.1	AC Conducted Emission	Pass
15.247(a)(2)	RSS-247(5.2)(a)	4.2	6 dB Bandwidth	Pass
-	RSS-GEN 6.6	4.2	Occupied Bandwidth (99%)	Pass
15.247(b)	RSS-247(5.4)(d)	4.3	Output Power Measurement	Pass
15.247(e)	RSS-247(5.2)(b)	4.4	Power Spectral Density	Pass
15.247(d)	RSS-247(5.5)	4.5	Conducted Band Edge	Pass
15.247(d)	RSS-247(5.5)	4.5	Conducted Emission	Pass
15.247(d)	RSS-GEN 8.9, 8.10	4.6	Radiation Band Edge	Pass
15.247(d)	RSS-GEN 8.9, 8.10	4.6	Radiation Spurious Emission	Pass

3. DESCRIPTION OF TEST MODES

3.1 THE WORST MODE OF OPERATING CONDITION

<p>Operation Mode</p>	<p>IEEE 802.11b Mode :1Mbps IEEE 802.11g Mode :6Mbps IEEE 802.11n HT20 Mode :MCS0 IEEE 802.11n HT40 Mode :MCS0</p>
<p>Test Channel Frequencies</p>	<p>IEEE 802.11b Mode : 1. Lowest Channel : 2412MHz 2. Middle Channel : 2437MHz 3. Highest Channel : 2462MHz IEEE 802.11g Mode : 1. Lowest Channel : 2412MHz 2. Middle Channel : 2437MHz 3. Highest Channel : 2462MHz IEEE 802.11n HT20 Mode : 1. Lowest Channel : 2412MHz 2. Middle Channel : 2437MHz 3. Highest Channel : 2462MHz IEEE 802.11n HT40 Mode : 1. Lowest Channel : 2422MHz 2. Middle Channel : 2437MHz 3. Highest Channel : 2452MHz</p>

Remark:

1. EUT pre-scanned data rate of output power for each mode, the worst data rate were recorded in this report.

.

3.2 THE WORST MODE OF MEASUREMENT

AC Power Line Conducted Emission	
Test Condition	AC Power line conducted emission for line and neutral
Voltage/Hz	120V/60Hz
Test Mode	Mode 1:EUT power by AC adapter via power cable.
Worst Mode	<input checked="" type="checkbox"/> Mode 1 <input type="checkbox"/> Mode 2 <input type="checkbox"/> Mode 3 <input type="checkbox"/> Mode 4

Radiated Emission Measurement Above 1G	
Test Condition	Band edge, Emission for Unwanted and Fundamental
Voltage/Hz	120V/60Hz
Test Mode	Mode 1:EUT power by AC adapter via power cable.
Worst Mode	<input checked="" type="checkbox"/> Mode 1 <input type="checkbox"/> Mode 2 <input type="checkbox"/> Mode 3 <input type="checkbox"/> Mode 4
Worst Position	<input type="checkbox"/> Placed in fixed position. <input type="checkbox"/> Placed in fixed position at X-Plane (E2-Plane) <input checked="" type="checkbox"/> Placed in fixed position at Y-Plane (E1-Plane) <input type="checkbox"/> Placed in fixed position at Z-Plane (H-Plane)
Worst Polarity	<input type="checkbox"/> Horizontal <input checked="" type="checkbox"/> Vertical

Radiated Emission Measurement Below 1G	
Test Condition	Radiated Emission Below 1G
Voltage/Hz	120V/60Hz
Test Mode	Mode 1:EUT power by AC adapter via power cable.
Worst Mode	<input checked="" type="checkbox"/> Mode 1 <input type="checkbox"/> Mode 2 <input type="checkbox"/> Mode 3 <input type="checkbox"/> Mode 4

Remark:

1. The worst mode was record in this test report.
2. EUT pre-scanned in three axis ,X,Y, Z and two polarity, Horizontal and Vertical for radiated measurement. The worst case(Y-Plane and Vertical) were recorded in this report
3. For AC power line conducted emission and below 1G radiation emission were performed the EUT transmit at the highest output power channel as worse case.

3.3 EUT DUTY CYCLE

Duty Cycle				
Configuration	TX ON (ms)	TX ALL (ms)	Duty Cycle (%)	Duty Factor(dB)
802.11b	8.2200	8.2200	100.00	0.00
802.11g	1.4000	1.4200	98.59	0.06
802.11n HT20	1.2900	1.3200	97.73	0.10
802.11n HT40	0.3600	0.3800	94.74	0.23

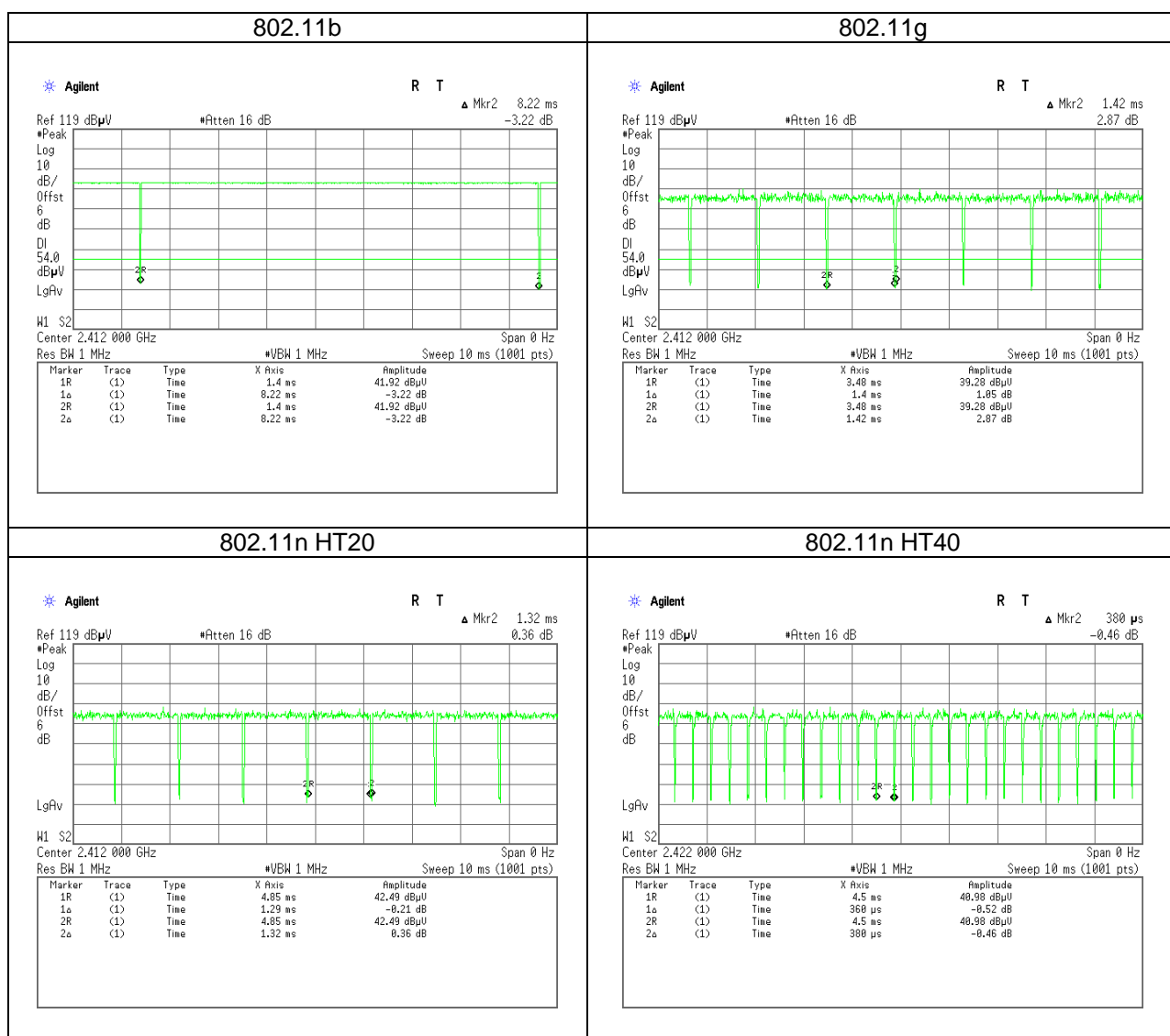

4. TEST RESULT

4.1 AC POWER LINE CONDUCTED EMISSION

4.1.1 Test Limit

According to §15.207(a)(2) and RSS-GEN section 8.8,

Frequency Range (MHz)	Limits(dBµV)	
	Quasi-peak	Average
0.15 to 0.50	66 to 56*	56 to 46*
0.50 to 5	56	46
5 to 30	60	50

* Decreases with the logarithm of the frequency.

4.1.2 Test Procedure

Test method Refer as ANSI 63.10:2013 clause 6.2,

1. The EUT was placed on a non-conducted table, which is 0.8m above horizontal ground plane and 0.4m above vertical ground plane.
2. EUT connected to the line impedance stabilization network (LISN)
3. Receiver set RBW of 9kHz and Detector Peak, and note as quasi-peak and average.
4. Maximum procedure was performed on the six highest emissions to ensure EUT compliance.
5. Recorded Line for Neutral and Line.

4.1.3 Test Setup

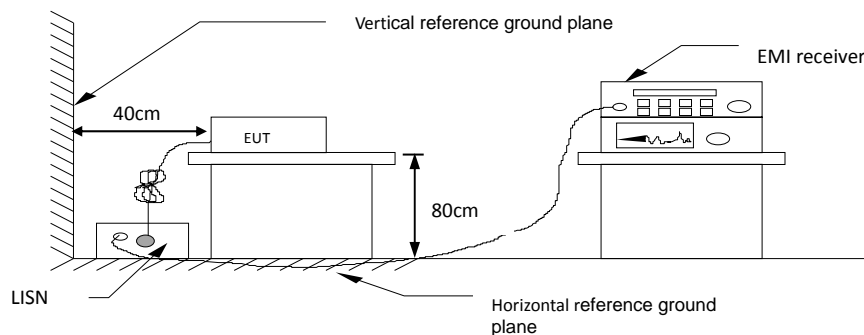

4.1.4 Test Result

Pass

Test Data

Test Mode:	Mode 1	Temp/Hum	27(°C)/ 53%RH
Test Voltage:	120Vac / 60Hz	Test Date	February 20, 2017
Phase:	Line	Test Engineer	Ed Chiang

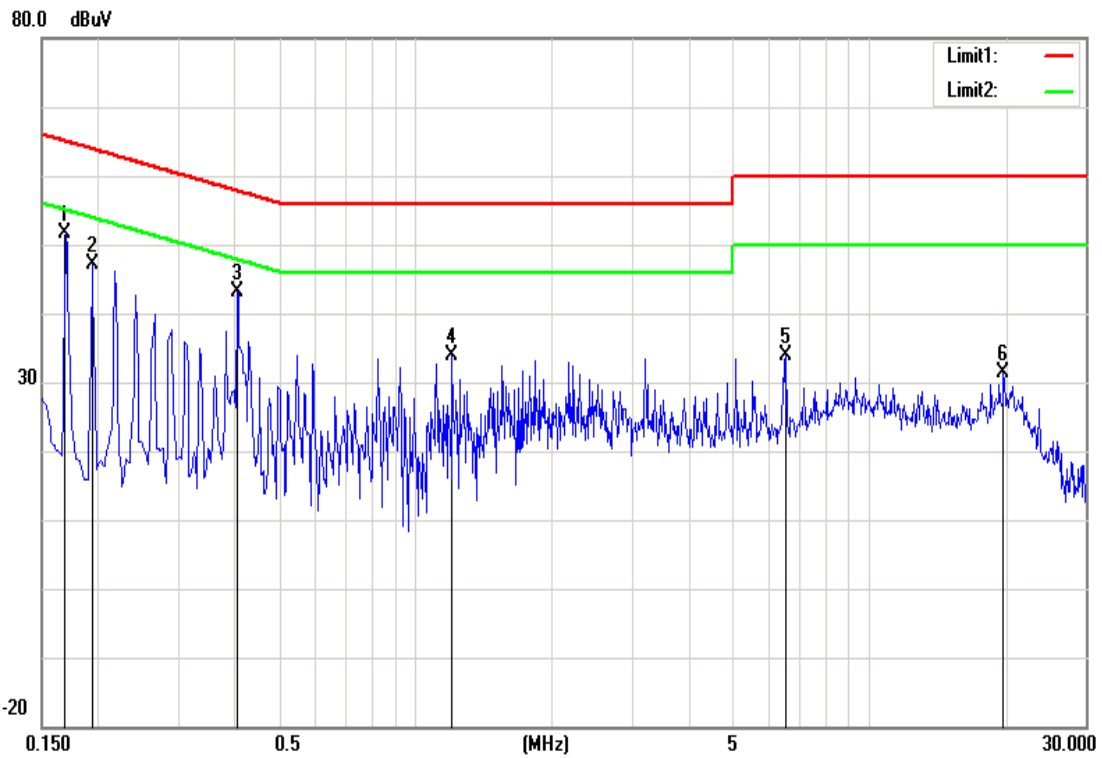

Frequency (MHz)	QP Reading (dBuV)	AV Reading (dBuV)	Corr. factor (dB)	QP Result (dBuV)	AV Result (dBuV)	QP Limit (dBuV)	AV Limit (dBuV)	QP Margin (dB)	AV Margin (dB)
0.1700	42.96	21.52	-0.02	42.94	21.50	64.96	54.96	-22.02	-33.46
0.1940	42.86	20.91	-0.03	42.83	20.88	63.86	53.86	-21.03	-32.98
0.4060	36.86	26.64	-0.05	36.81	26.59	57.73	47.73	-20.92	-21.14
1.2060	27.04	17.36	-0.05	26.99	17.31	56.00	46.00	-29.01	-28.69
6.5780	21.58	13.80	0.06	21.64	13.86	60.00	50.00	-38.36	-36.14
19.7580	23.83	16.69	-0.33	23.50	16.36	60.00	50.00	-36.50	-33.64

Test Mode:	Mode 1	Temp/Hum	27(°C)/ 53%RH
Test Voltage:	120Vac / 60Hz	Test Date	February 20, 2017
Phase:	Neutral	Test Engineer	Ed Chiang

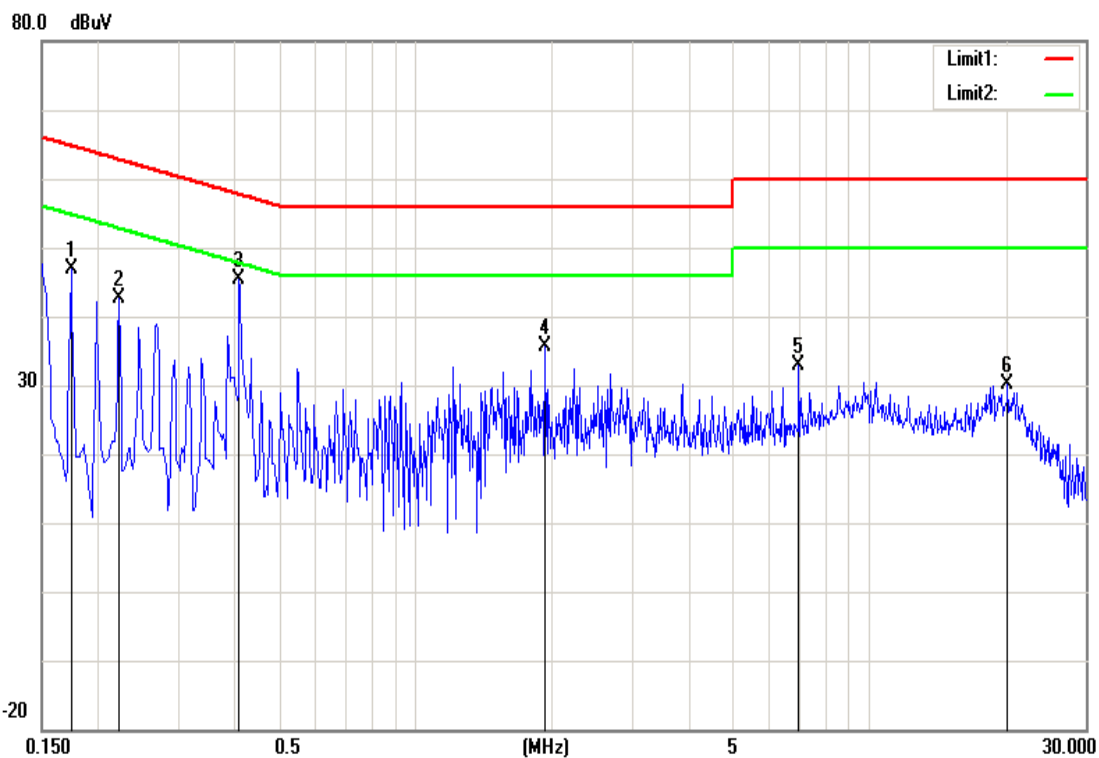

Frequency (MHz)	QP Reading (dBuV)	AV Reading (dBuV)	Corr. factor (dB)	QP Result (dBuV)	AV Result (dBuV)	QP Limit (dBuV)	AV Limit (dBuV)	QP Margin (dB)	AV Margin (dB)
0.1740	41.97	21.21	-0.09	41.88	21.12	64.77	54.77	-22.89	-33.65
0.2220	39.68	21.27	-0.10	39.58	21.17	62.74	52.74	-23.16	-31.57
0.4100	37.07	27.29	-0.13	36.94	27.16	57.65	47.65	-20.71	-20.49
1.9300	25.23	15.56	-0.14	25.09	15.42	56.00	46.00	-30.91	-30.58
7.0100	20.89	14.32	-0.18	20.71	14.14	60.00	50.00	-39.29	-35.86
20.1740	23.64	16.66	-0.34	23.30	16.32	60.00	50.00	-36.70	-33.68

4.2 6DB BANDWIDTH AND OCCUPIED BANDWIDTH(99%)

4.2.1 Test Limit

According to §15.247(a)(2) and RSS-247 section 5.2(a),

6 dB Bandwidth :

Limit	Shall be at least 500kHz
-------	--------------------------

Occupied Bandwidth(99%) : For reporting purposes only.

4.2.2 Test Procedure

Test method Refer as KDB 558074 D01 v03r05, Section 8.1 and ANSI 63.10:2013 clause 6.9.3,

1. The EUT RF output connected to the spectrum analyzer by RF cable.
2. Setting maximum power transmit of EUT
3. SA set RBW = 100kHz, VBW = 300kHz and Detector = Peak, to measurement 6 dB Bandwidth and 99% Bandwidth.
4. Measure and record the result of 26 dB Bandwidth and 99% Bandwidth in the test report.

4.2.3 Test Setup

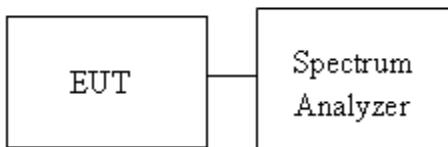

4.2.4 Test Result

Test mode: IEEE 802.11b mode / 2412-2462 MHz				
Channel	Frequency (MHz)	OBW (99%) (MHz)	6dB BW (MHz)	6dB limit (kHz)
Low	2412	13.8929	10.1304	≥500
Mid	2437	13.8929	10.1304	
High	2462	13.8929	10.1304	

Test mode: IEEE 802.11g mode / 2412-2462 MHz				
Channel	Frequency (MHz)	OBW (99%) (MHz)	6dB BW (MHz)	6dB limit (kHz)
Low	2412	16.5846	16.6087	≥500
Mid	2437	16.5846	16.5652	
High	2462	16.5846	16.6087	

Test mode: IEEE 802.11n HT 20 MHz mode / 2412-2462 MHz						
Channel	Frequency (MHz)	Chain 0 OBW (99%) (MHz)	Chain 1 OBW (99%) (MHz)	Chain 0 6dB BW (MHz)	Chain 1 6dB BW (MHz)	6dB limit (kHz)
Low	2412	17.7568	17.7134	17.7826	17.8261	≥500
Mid	2437	17.7568	17.7568	17.8261	17.8261	
High	2462	17.7568	17.7134	17.8261	17.8261	

Test mode: IEEE 802.11n HT 40 MHz mode / 2422-2452 MHz						
Channel	Frequency (MHz)	Chain 0 OBW (99%) (MHz)	Chain 1 OBW (99%) (MHz)	Chain 0 6dB BW (MHz)	Chain 1 6dB BW (MHz)	6dB limit (kHz)
Low	2422	36.2373	36.2373	36.6380	36.6380	>500
Mid	2437	36.3531	36.3531	36.6380	36.5220	
High	2452	36.3531	36.3531	36.5220	36.6380	

Test Data

IEEE 802.11b mode

Low CH



Date: 11 MAR 2017 17:52:40

Mid CH

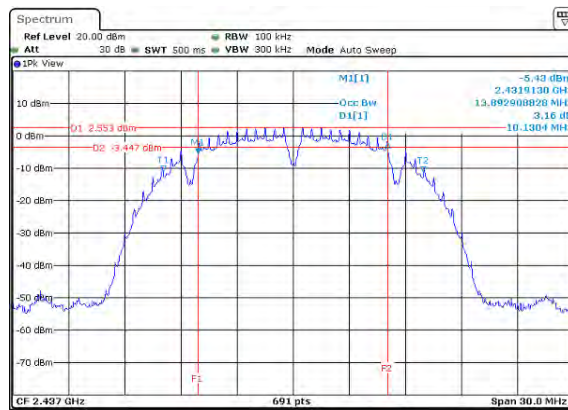

Date: 11 MAR 2017 17:57:36

High CH



Date: 11 MAR 2017 18:01:18

IEEE 802.11g mode

Low CH

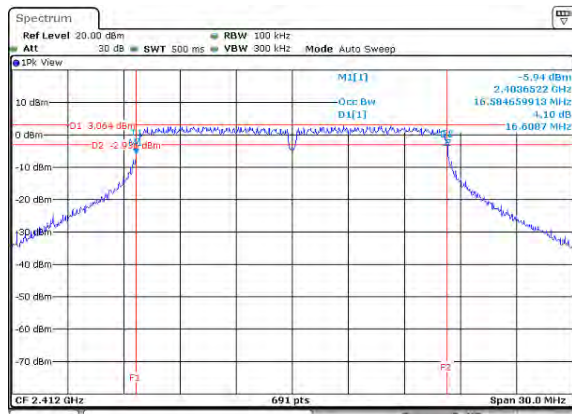

Date: 11 MAR 2017 17:28:37

Mid CH

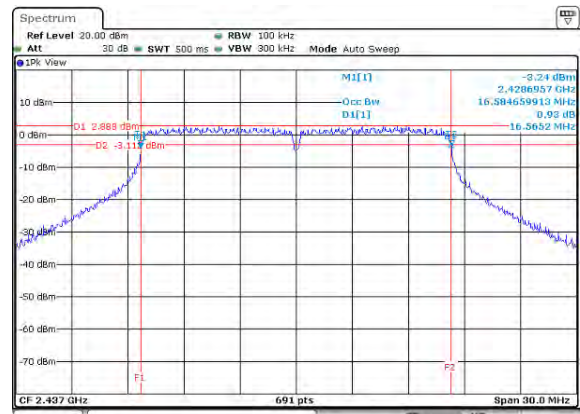

Date: 11 MAR 2017 17:28:32

High CH

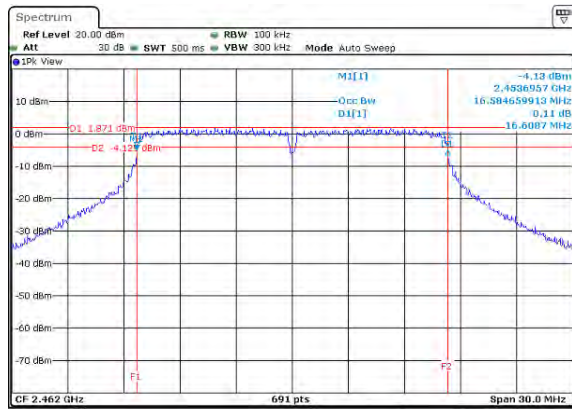

Date: 11 MAR 2017 17:40:23

IEEE 802.11n HT20 mode- chain 0

Low CH

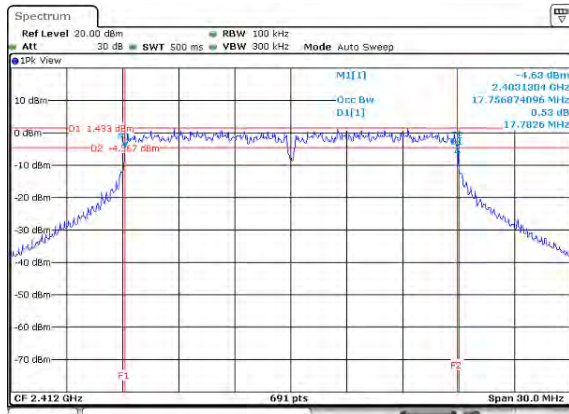

Mid CH

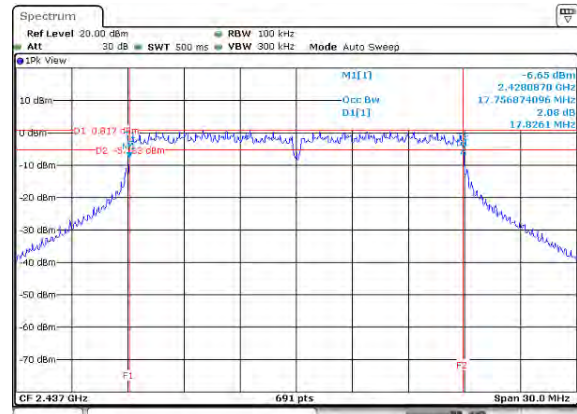

High CH

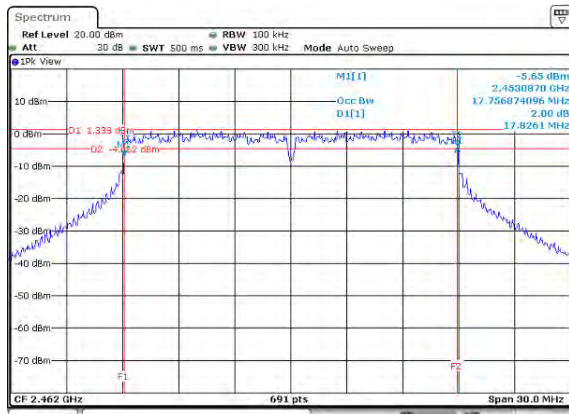

IEEE 802.11n HT20 mode- chain 1

Low CH

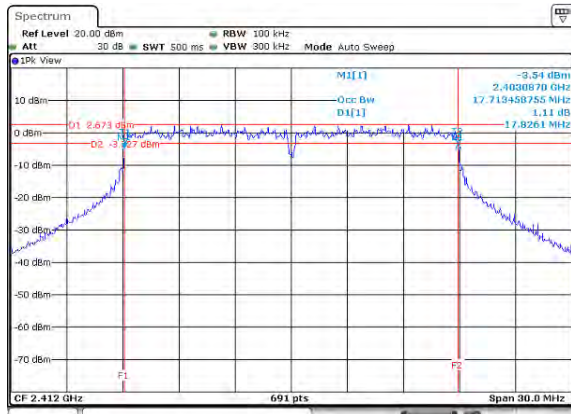

Date: 11 MAR 2017 16:43:36

Mid CH

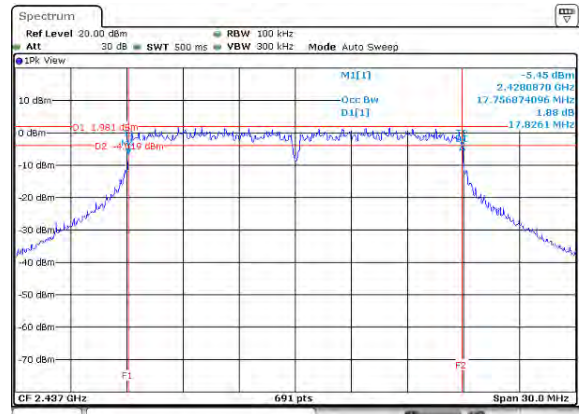

Date: 11 MAR 2017 16:54:08

High CH

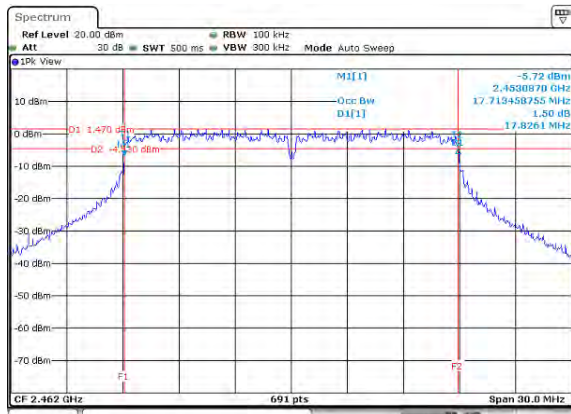

Date: 11 MAR 2017 17:06:46

IEEE 802.11n HT40 mode- chain 0

Low CH

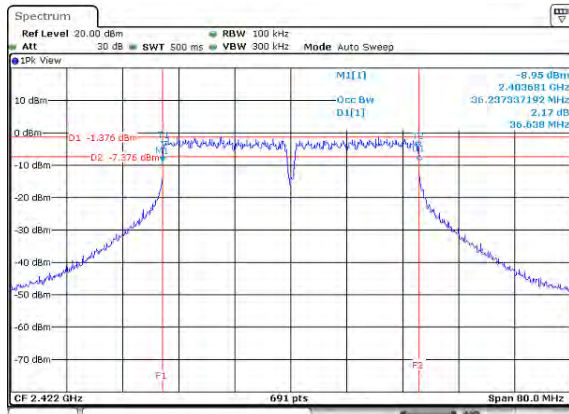

Mid CH

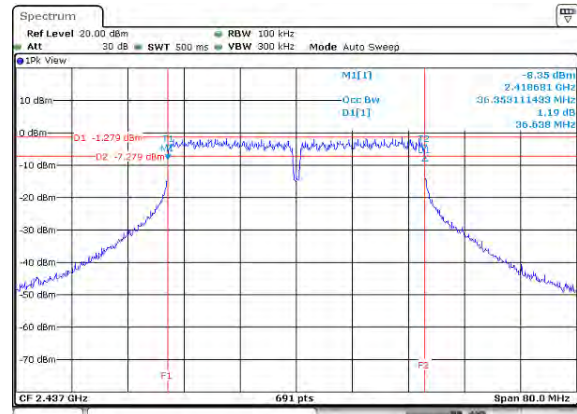

High CH



IEEE 802.11n HT40 mode- chain 1

Low CH

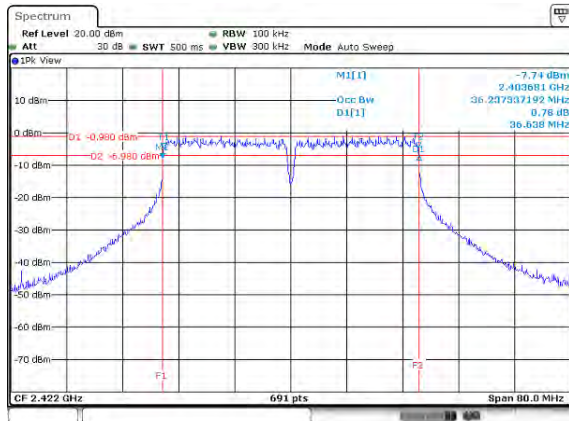

Date: 11 MAR 2017 16:29:22

Mid CH

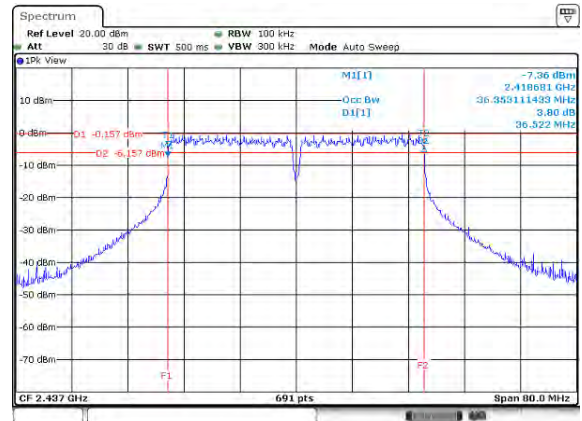

Date: 11 MAR 2017 16:24:40

High CH

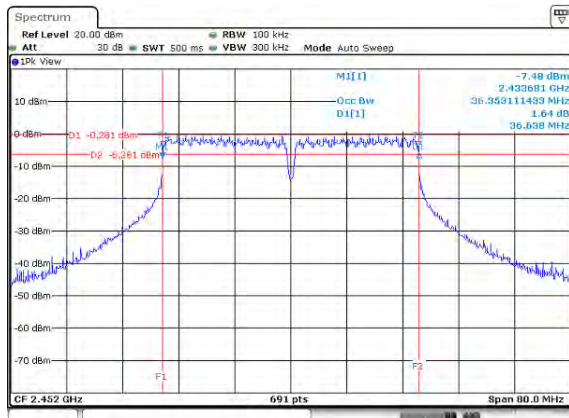

Date: 11 MAR 2017 16:17:34

4.3 OUTPUT POWER MEASUREMENT

4.3.1 Test Limit

According to §15.247(b) and RSS-247 section 5.4(d),

Peak output power :

For systems using digital modulation in the 2400-2483.5 MHz, and 5725-5850 MHz bands: 1 Watt(30 dBm), base on the use of antennas with directional gain not exceed 6 dBi If transmitting antennas of directional gain greater than 6dBi are used the peak output power the conducted output power from the intentional radiator shall be reduced by the amount in dB that the directional gain of the antenna exceeds 6 dBi. In case of point-to-point operation, the limit has to be reduced by 1dB for every 3 dB that the directional gain of the antenna exceeds 6 dBi.

Limit	<input type="checkbox"/> Antenna not exceed 6 dBi <input checked="" type="checkbox"/> Antenna with DG greater than 6 dBi [Limit = 30 – (DG – 6)] <input type="checkbox"/> Point-to-point operation :
-------	--

Average output power : For reporting purposes only.

4.3.2 Test Procedure

Test method Refer as KDB 558074 D01 v03r05, Section 9.1.2.

1. The EUT RF output connected to the power meter by RF cable.
2. Setting maximum power transmit of EUT.
3. The path loss was compensated to the results for each measurement.
4. Measure and record the result of Peak output power and Average output power in the test report.

4.3.3 Test Setup

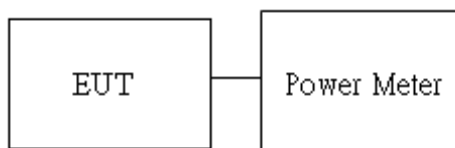

4.3.4 Test Result

Peak output power :

IEEE 802.11b mode

Channel	Frequency (MHz)	Output Power (dBm)	Output Power (W)	Limit (dBm)	Result
Low	2412	15.17	0.0329	23.87	PASS
Mid	2437	15.91	0.0390		PASS
High	2462	*15.93	0.0392		PASS

IEEE 802.11g mode

Channel	Frequency (MHz)	Output Power (dBm)	Output Power (W)	Limit (dBm)	Result
Low	2412	22.28	0.1690	23.87	PASS
Mid	2437	22.56	0.1803		PASS
High	2462	*22.82	0.1914		PASS

IEEE 802.11n HT 20 MHz mode

Channel	Frequency (MHz)	Chain 0 Output Power (dBm)	Chain 1 Output Power (dBm)	Total Output Power (dBm)	Output Power (W)	Limit (dBm)	Result
Low	2412	20.07	20.02	23.06	0.2023	23.87	PASS
Mid	2437	20.10	20.52	*23.33	0.2153		PASS
High	2462	20.09	20.15	23.13	0.2056		PASS

IEEE 802.11n HT 40 MHz mode

Channel	Frequency (MHz)	Chain 0 Output Power (dBm)	Chain 1 Output Power (dBm)	Total Output Power (dBm)	Output Power (W)	Limit (dBm)	Result
Low	2422	20.25	20.06	23.17	0.2075	23.87	PASS
Mid	2437	20.17	20.35	23.27	0.2123		PASS
High	2452	20.24	20.58	*23.42	0.2198		PASS

Remark: Total Output Power (w) = Chain 0 (10^{^(Output Power /10)}/1000)+ Chain 1 (10^{^(Output Power /10)}/1000)

Average output power :

Test mode: IEEE 802.11b mode

Channel	Frequency (MHz)	Output Power (dBm)	Output Power (W)
Low	2412	12.78	0.0190
Mid	2437	13.55	0.0226
High	2462	13.54	0.0226

Test mode: IEEE 802.11g mode

Channel	Frequency (MHz)	Output Power (dBm)	Output Power (W)
Low	2412	16.16	0.0413
Mid	2437	17.15	0.0519
High	2462	16.48	0.0445

Test mode: IEEE 802.11n HT 20 MHz mode

Channel	Frequency (MHz)	Chain 0 Output Power (dBm)	Chain 1 Output Power (dBm)	Total Output Power (dBm)	Output Power (W)
Low	2412	14.24	14.23	17.25	0.0531
Mid	2437	14.36	14.82	17.61	0.0577
High	2462	14.63	14.75	17.70	0.0589

Test mode: IEEE 802.11n HT 40 MHz mode

Channel	Frequency (MHz)	Chain 0 Output Power (dBm)	Chain 1 Output Power (dBm)	Total Output Power (dBm)	Output Power (W)
Low	2422	15.35	15.94	17.57	0.0571
Mid	2437	16.23	16.12	18.12	0.0649
High	2452	15.28	15.25	18.28	0.0673

Remark: Total Output Power (w) = Chain 0 (10^(Output Power /10)/1000)+ Chain 1 (10^(Output Power /10)/1000)

4.4 POWER SPECTRAL DENSITY

4.4.1 Test Limit

According to §15.247(e) and RSS-247 section 5.2(2),

For digitally modulated systems, the power spectral density conducted from the intentional radiator to the antenna shall not be greater than 8 dBm in any 3 kHz band during any time interval of continuous transmission.

Limit	<input type="checkbox"/> Antenna not exceed 6 dBi <input checked="" type="checkbox"/> Antenna with DG greater than 6 dBi [Limit = 8 – (DG – 6)] <input type="checkbox"/> Point-to-point operation :
-------	--

4.4.2 Test Procedure

Test method Refer as KDB 558074 D01 v03r05, Section 10.2

1. The EUT RF output connected to the spectrum analyzer by RF cable.
2. Setting maximum power transmit of EUT
3. SA set RBW = 3kHz, VBW = 30kHz, Span = 1.5 times DTS Bandwidth (6 dB BW), Detector = Peak, Sweep Time = Auto and Trace = Max hold.
4. The path loss and Duty Factor were compensated to the results for each measurement by SA.
5. Mark the maximum level.
6. Measure and record the result of power spectral density. in the test report.

4.4.3 Test Setup

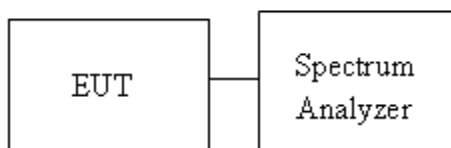

4.4.4 Test Result

Test mode: IEEE 802.11b mode / 2412-2462 MHz			
Channel	Frequency (MHz)	PSSD (dBm)	Limit (dBm)
Low	2412	-11.49	1.87
Mid	2437	-9.46	
High	2462	-10.45	

Test mode: IEEE 802.11g mode / 2412-2462 MHz			
Channel	Frequency (MHz)	PSSD (dBm)	Limit (dBm)
Low	2412	-8.30	1.87
Mid	2437	-8.38	
High	2462	-6.90	

Test mode: IEEE 802.11n HT 20 MHz mode / 2412-2462 MHz					
Channel	Frequency (MHz)	Chain 0 PPSD (dBm)	Chain 1 PPSD (dBm)	Total PSSD (dBm)	limit (dBm)
Low	2412	-12.02	-11.02	-8.48	1.87
Mid	2437	-11.63	-11.05	-8.32	
High	2462	-11.29	-10.89	-8.08	

Test mode: IEEE 802.11n HT 40 MHz mode / 2422-2452 MHz					
Channel	Frequency (MHz)	Chain 0 PPSD (dBm)	Chain 1 PPSD (dBm)	Total PSSD (dBm)	limit (dBm)
Low	2422	-12.30	-12.15	-9.21	1.87
Mid	2437	-11.38	-11.67	-8.51	
High	2452	-11.34	-10.62	-7.95	

Test Data

IEEE 802.11b mode

Low CH



Date: 11 MAR 2017 17:58:17

Mid CH



Date: 11 MAR 2017 17:58:08

High CH

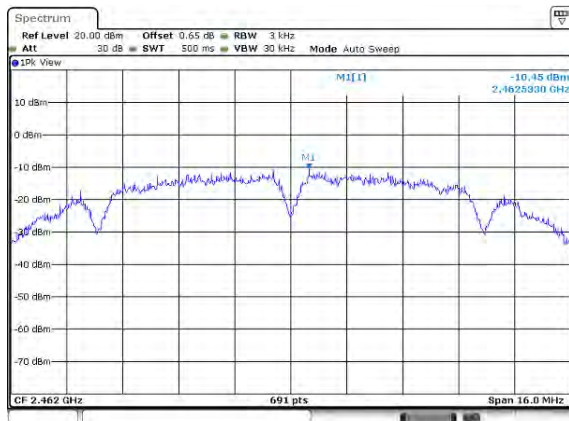

Date: 11 MAR 2017 18:01:47

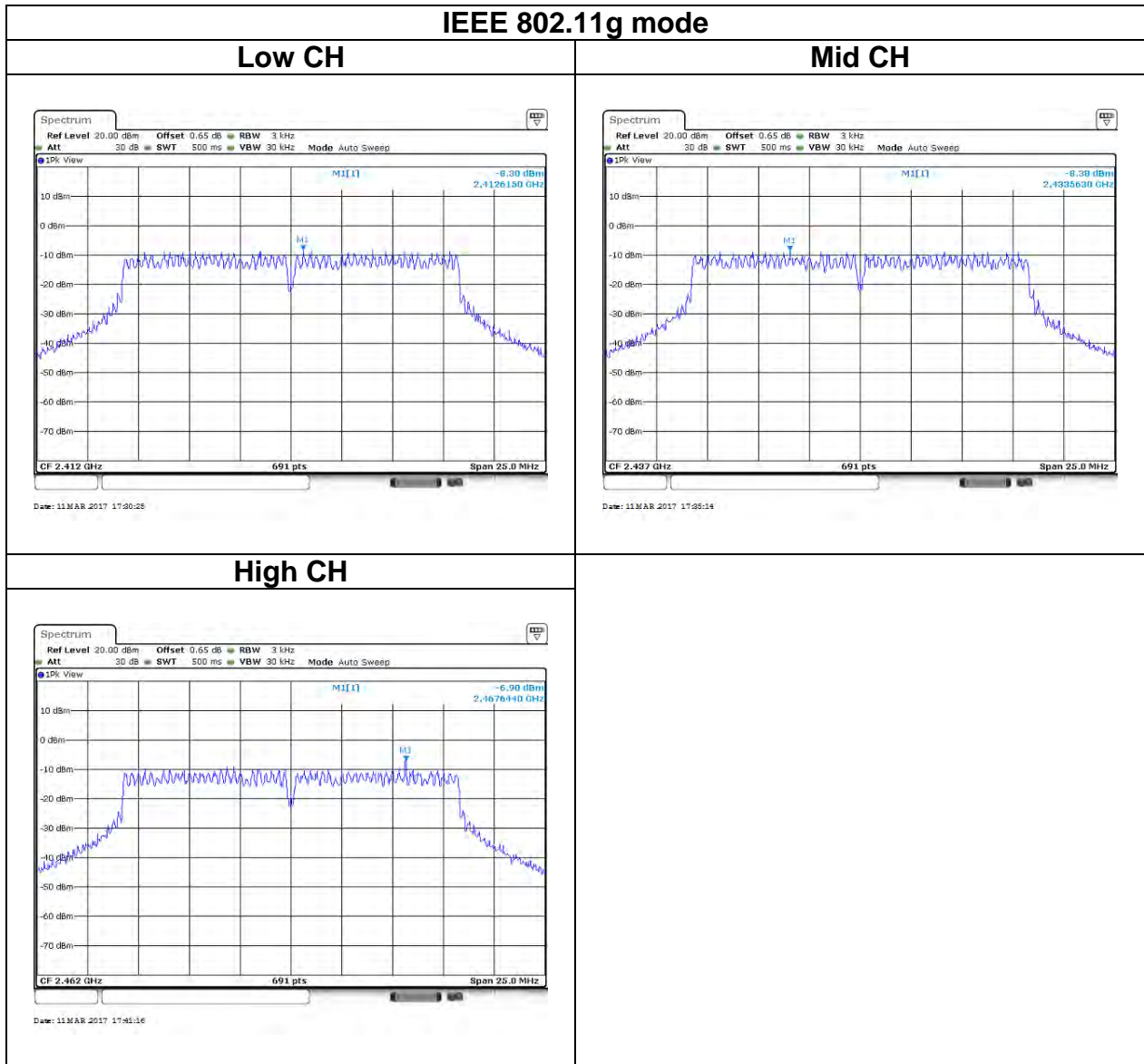

IEEE 802.11n HT20 mode- chain 0

Low CH

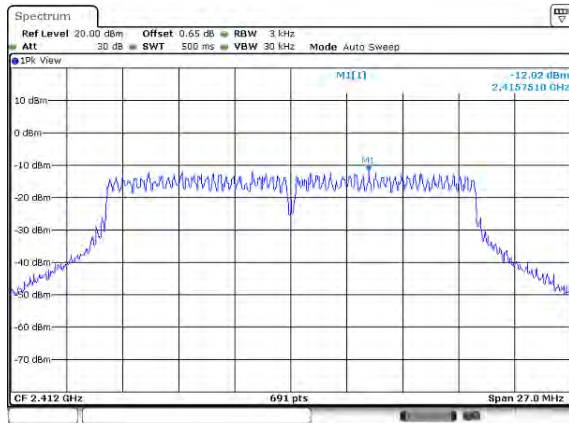

Mid CH

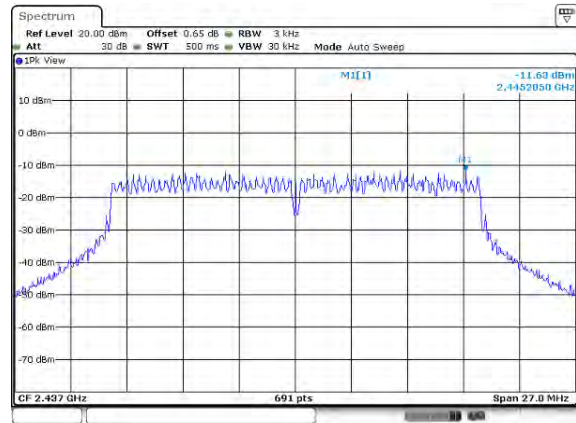

High CH

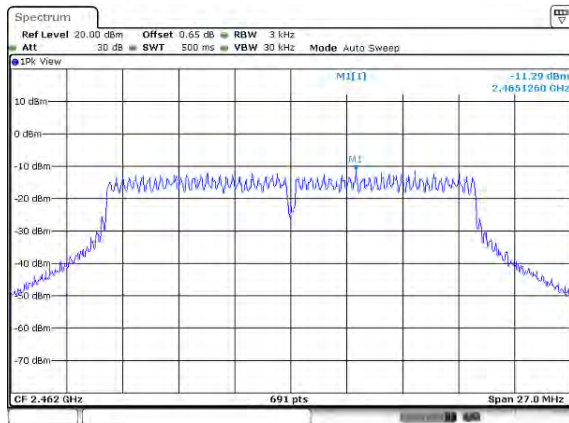

IEEE 802.11n HT20 mode-chain 1

Low CH

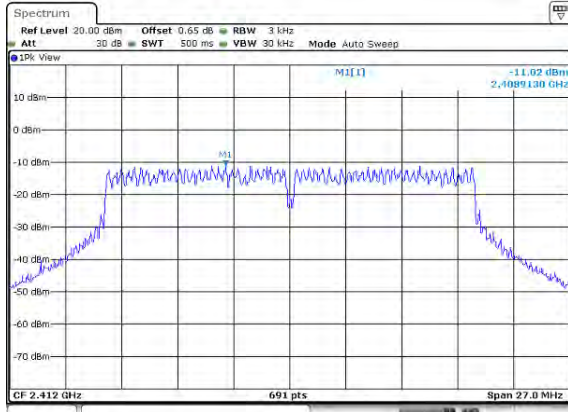

Mid CH

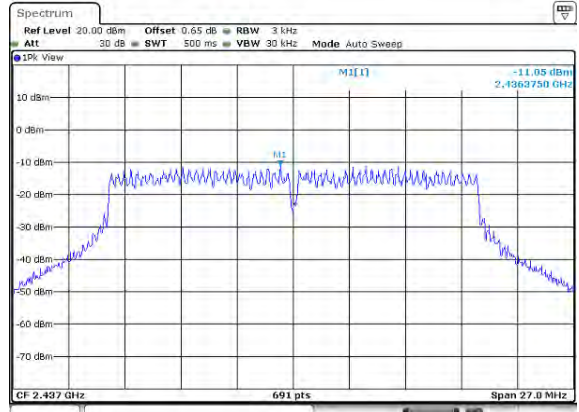

High CH

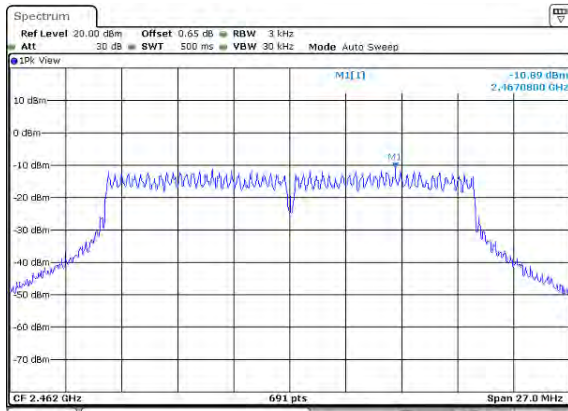

IEEE 802.11n HT40 mode-chain 0

Low CH

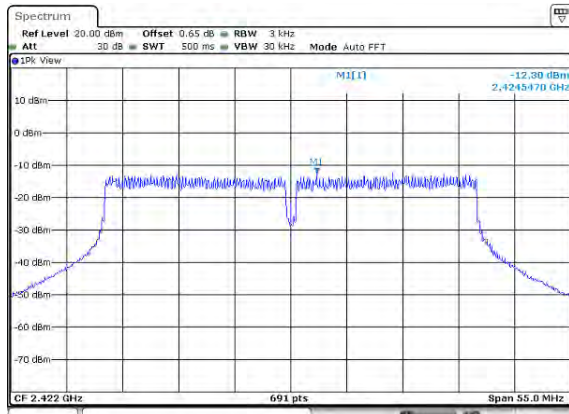

Date: 11 MAR 2017 16:28:20

Mid CH



Date: 11 MAR 2017 16:31:08

High CH

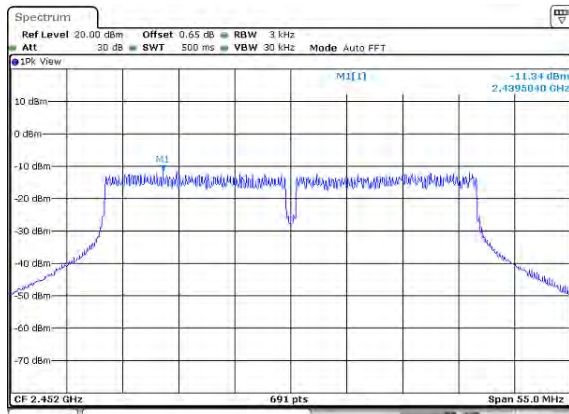

Date: 11 MAR 2017 16:32:44

IEEE 802.11n HT40 mode-chain 1

Low CH

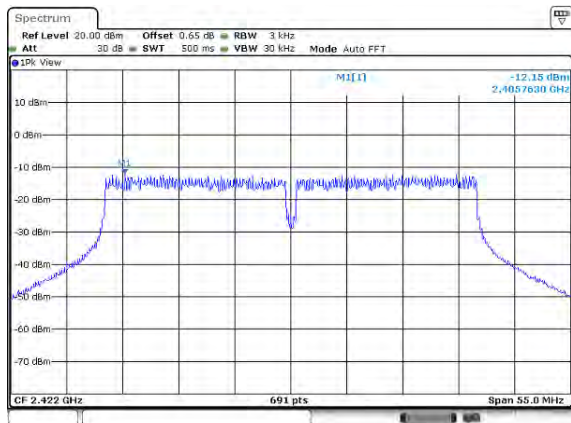

Mid CH

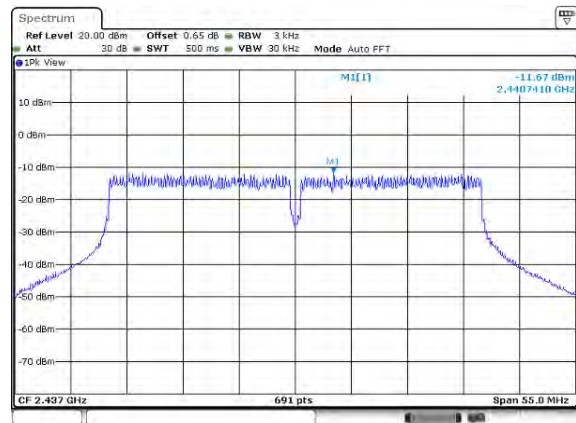

High CH

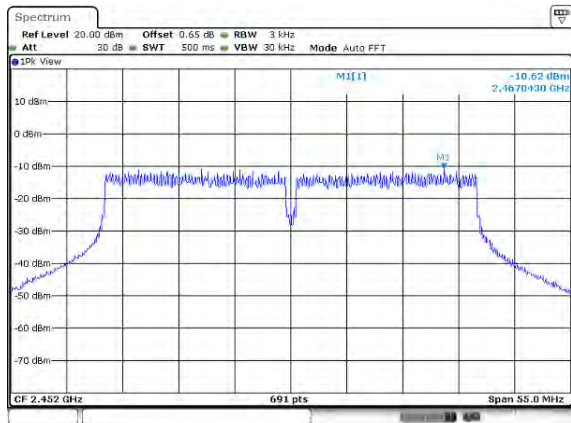

4.5 CONDUCTED BANDEGE AND SPURIOUS EMISSION

4.5.1 Test Limit

According to §15.247(d) and RSS-247 section 5.5,

In any 100 kHz bandwidth outside the authorized frequency band,

Non-restricted bands shall be attenuated at least 20 dB/30 dB relative to the maximum PSD level in 100 kHz by RF conducted or a radiated measurement which fall in the restricted bands, as defined in §15.205(a), must also comply with the radiated emission limits specified in §15.209(a).

4.5.2 Test Procedure

Test method Refer as KDB 558074 D01 v03r05, Section 11.

1. EUT RF output port connected to the SA by RF cable, and the path loss was compensated to result.
2. SA setting, RBW=100kHz, VBW=300kHz, Detector=Peak, Trace mode = max hold, SWT = Auto.
3. In any 100 kHz bandwidth outside the authorized frequency band, shall be attenuated at least 20 dB relative to the maximum in-band peak PSD level in 100 kHz when conducted power procedure is used. f the transmitter complies with the conducted power limits based on the use of RMS averaging over a time interval, the attenuation required under this paragraph shall be 30 dB instead of 20 dB.

4.5.3 Test Setup



4.5.4 Test Result

Test Data

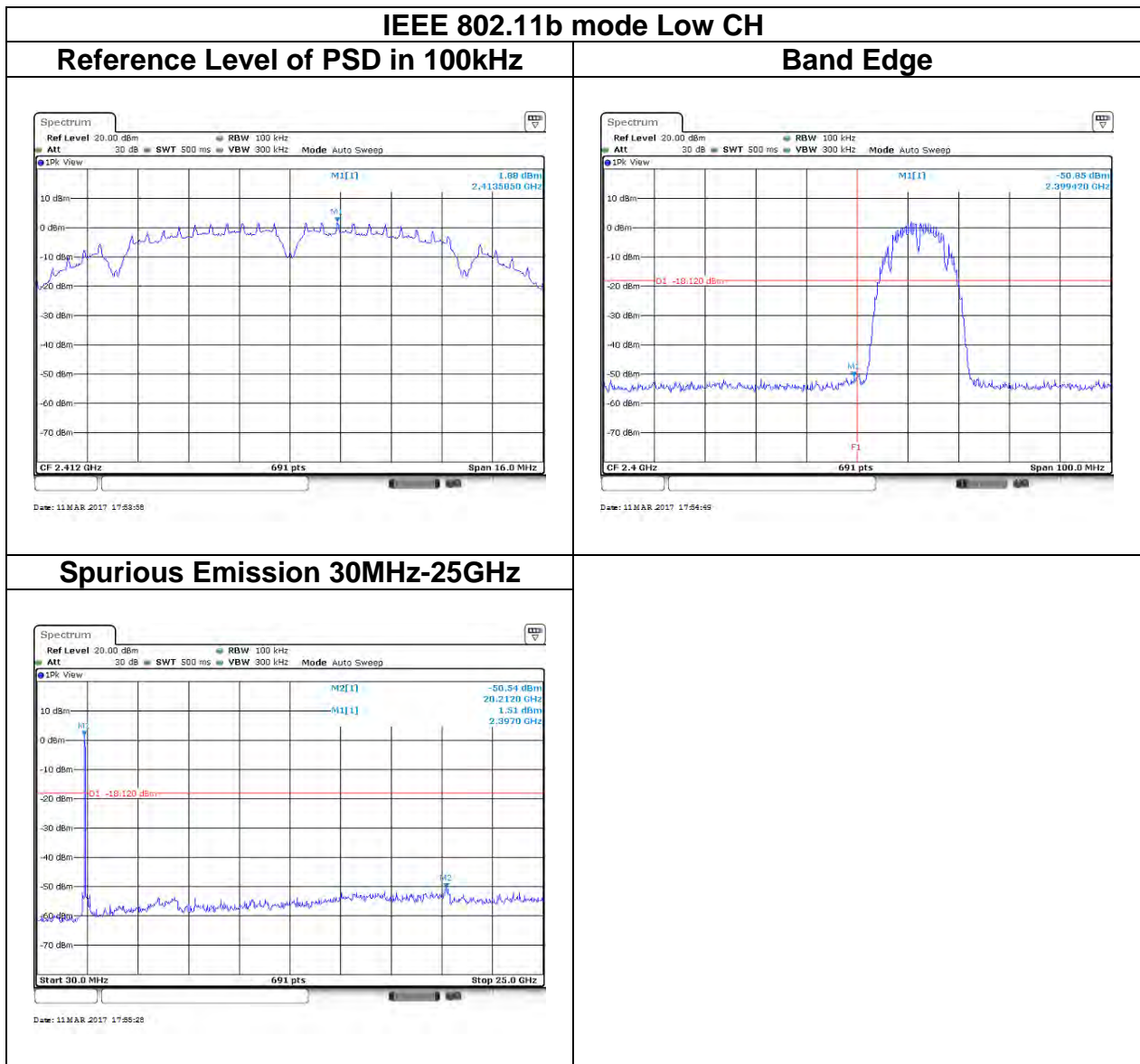

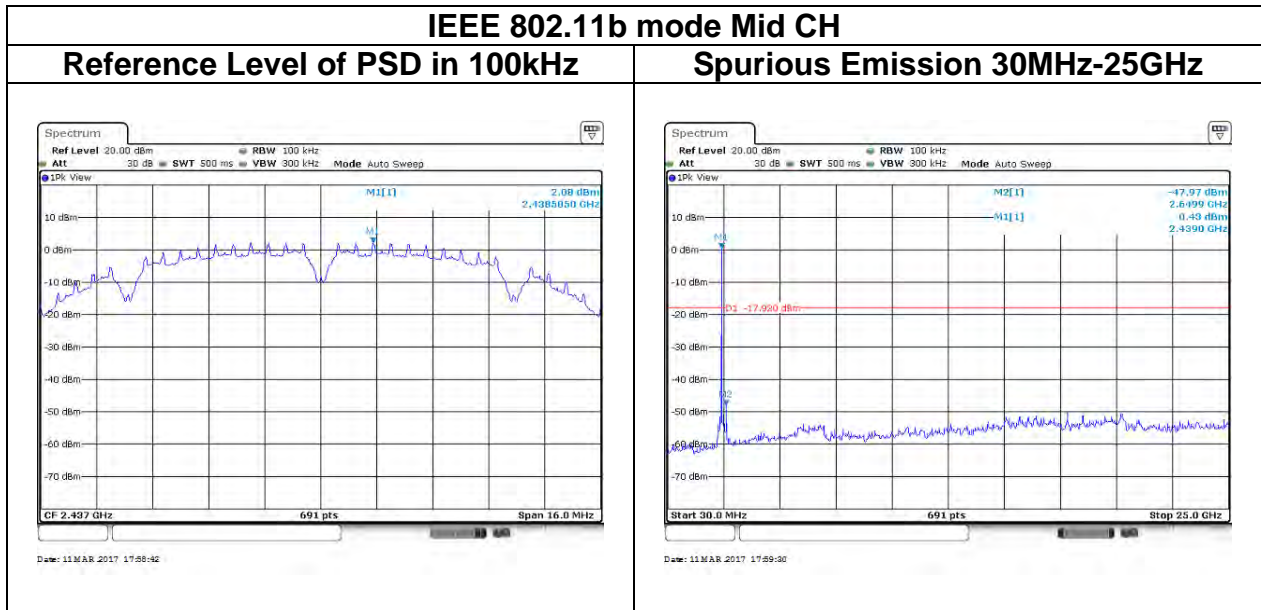

IEEE 802.11b mode High CH

Reference Level of PSD in 100kHz



Date: 11 MAR 2017 18:02:21

Band Edge

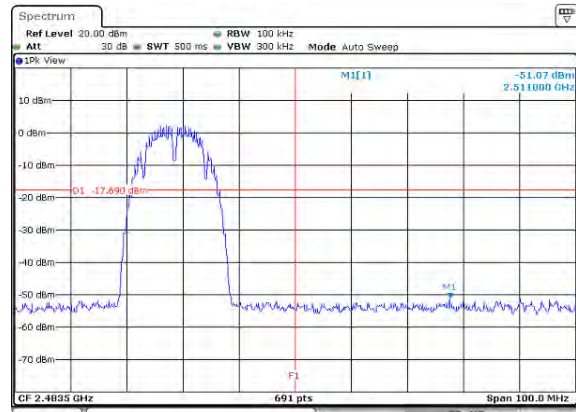

Date: 11 MAR 2017 18:03:16

Spurious Emission 30MHz-25GHz

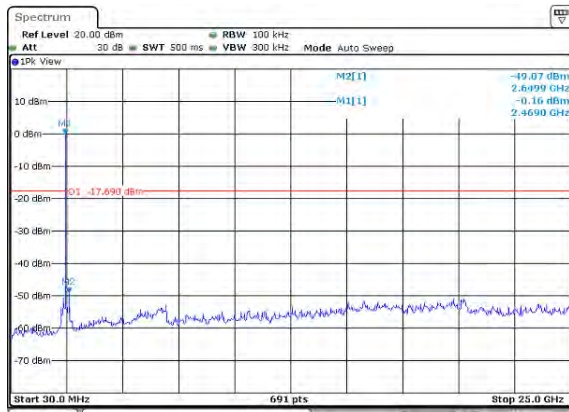

Date: 11 MAR 2017 18:03:54

IEEE 802.11g mode Low CH

Reference Level of PSD in 100kHz

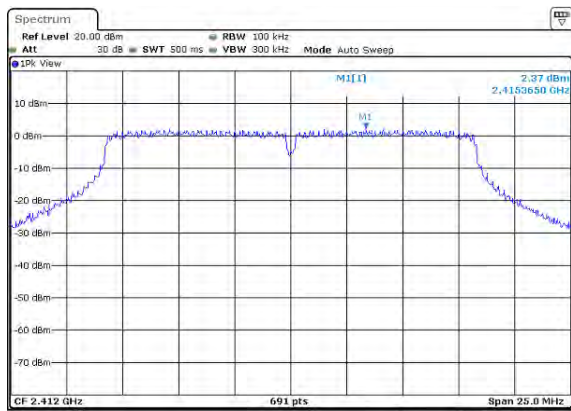

Date: 11.MAR.2017 17:20:59

Band Edge

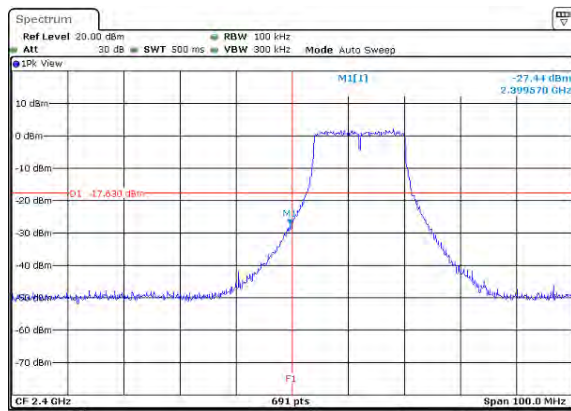

Date: 11.MAR.2017 17:22:02

Spurious Emission 30MHz-25GHz

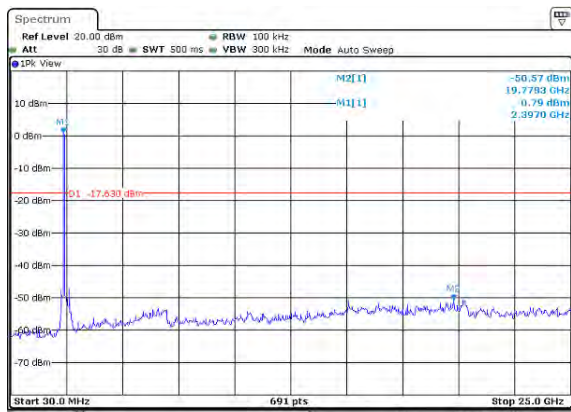

Date: 11.MAR.2017 17:22:47

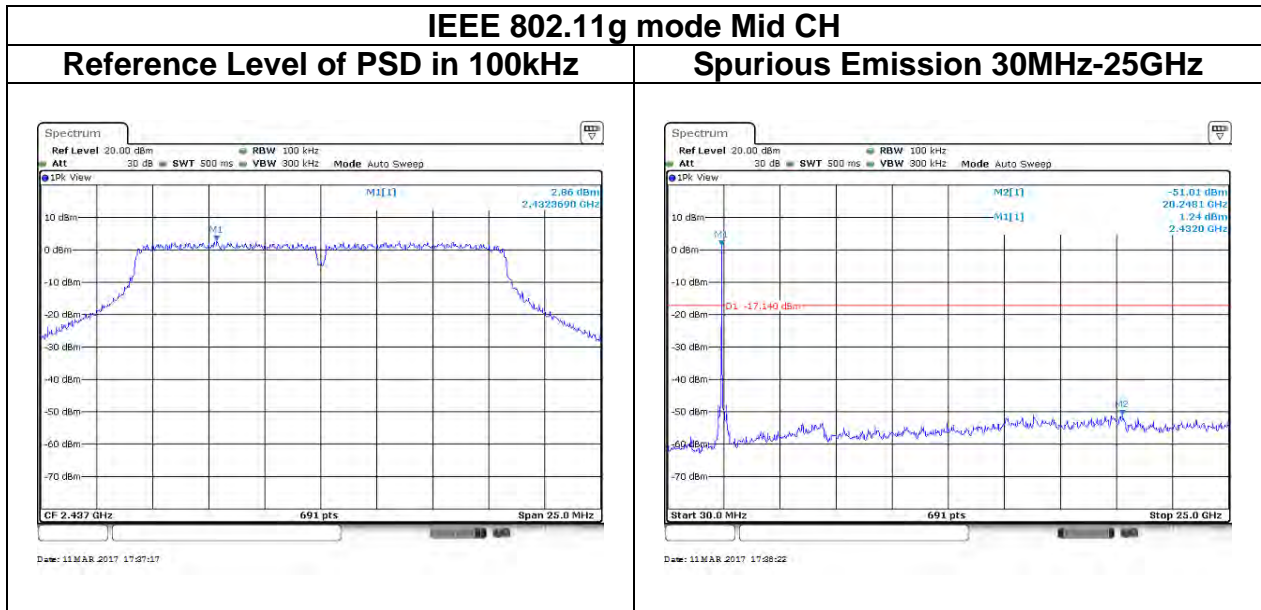

IEEE 802.11g mode High CH

Reference Level of PSD in 100kHz

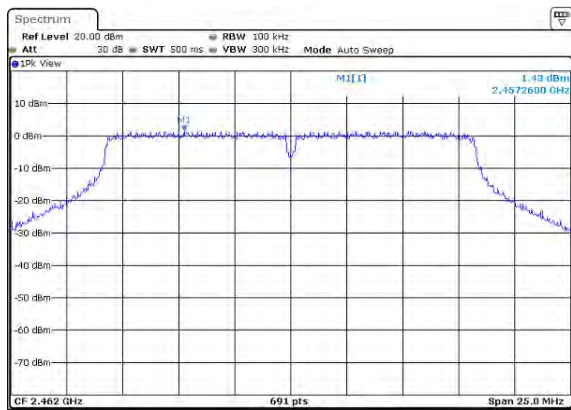

Date: 11 MAR 2017 17:48:21

Band Edge

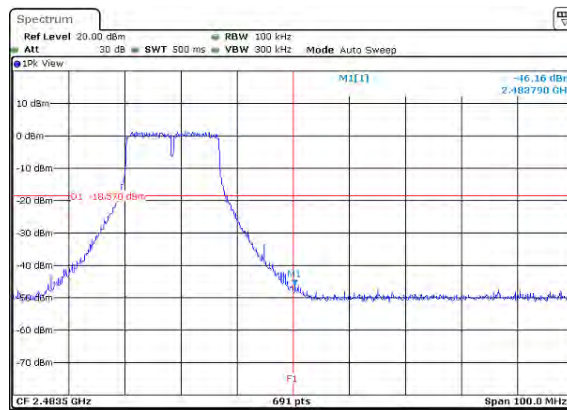

Date: 11 MAR 2017 17:48:20

Spurious Emission 30MHz-25GHz

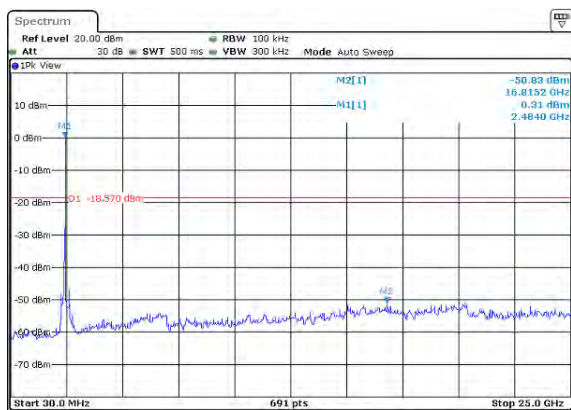

Date: 11 MAR 2017 17:48:58

IEEE 802.11 n HT20 mode Low CH chain 0

Reference Level of PSD in 100kHz



Band Edge

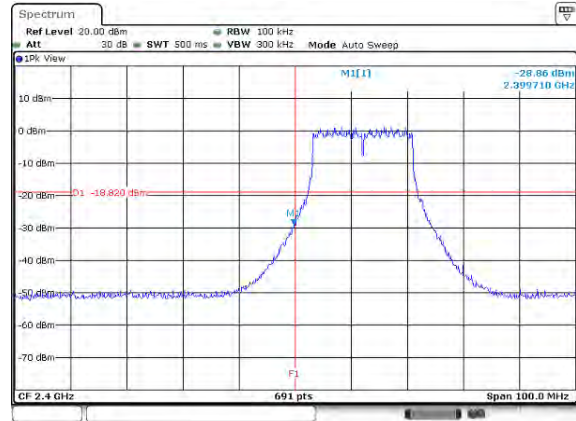

Spurious Emission 30MHz-25GHz

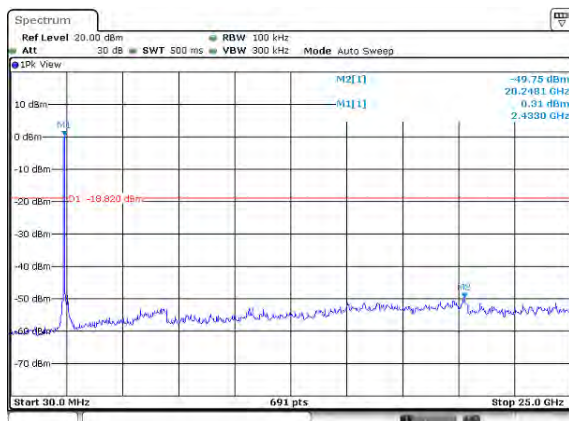

IEEE 802.11 n HT20 mode Low CH chain 1

Reference Level of PSD in 100kHz

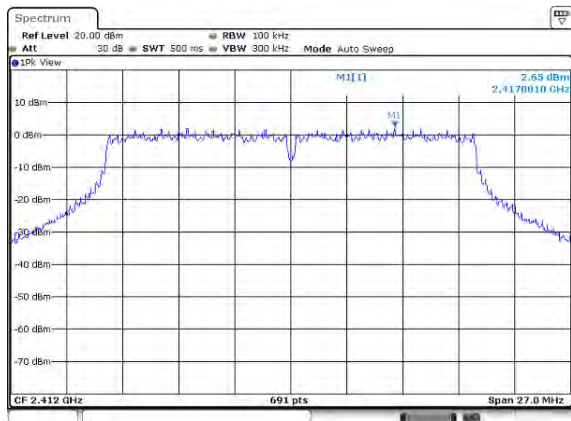

Band Edge

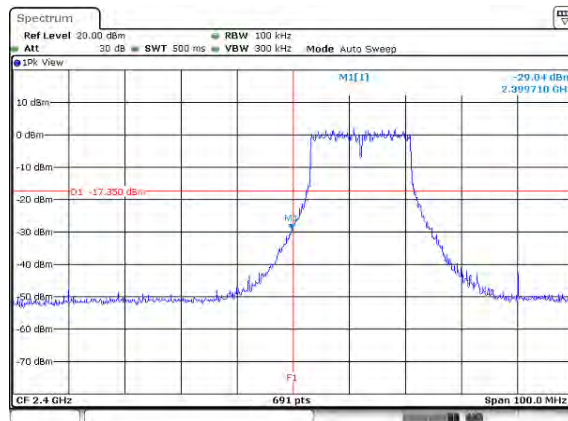

Spurious Emission 30MHz-25GHz

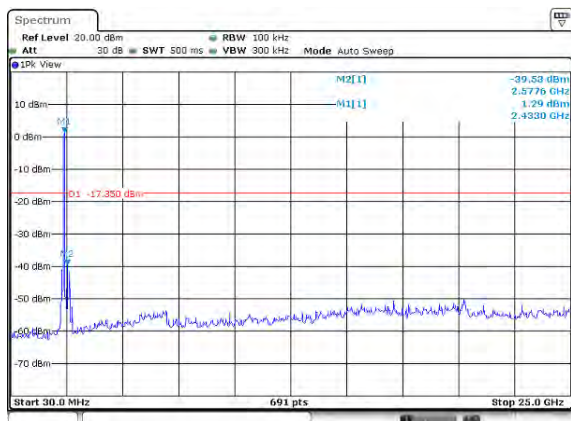

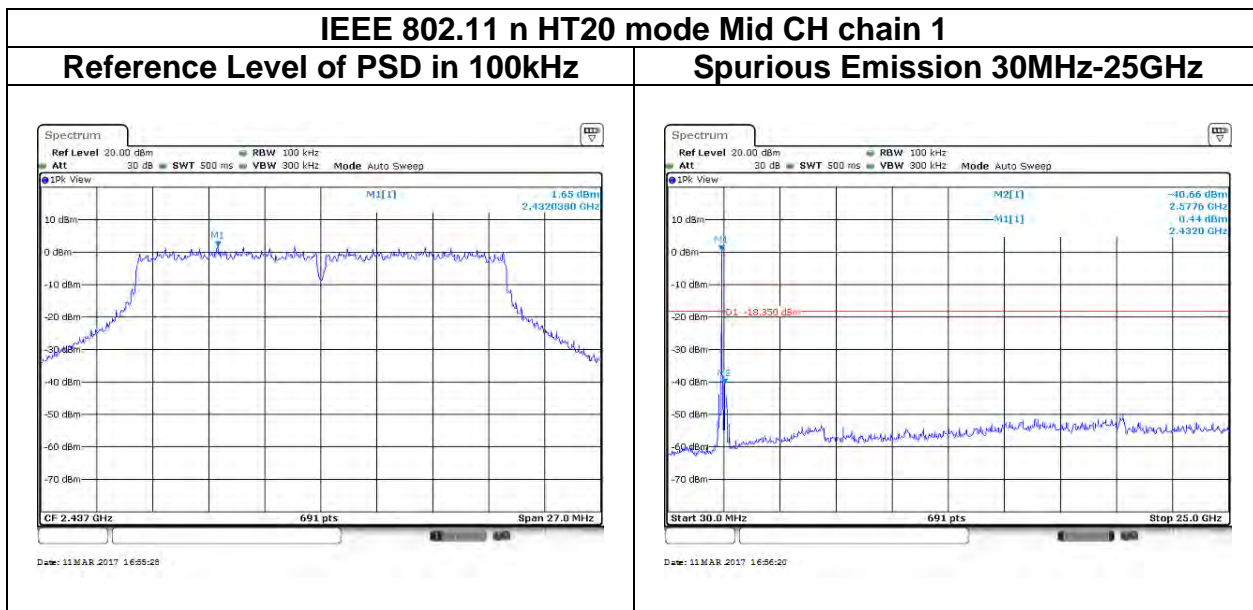
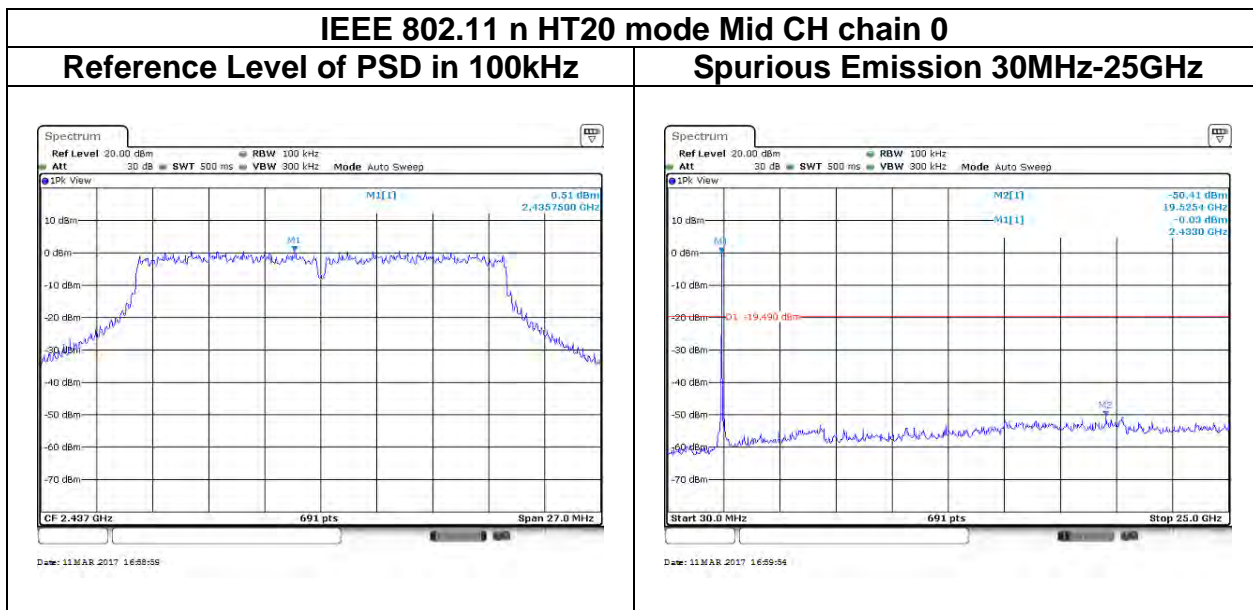

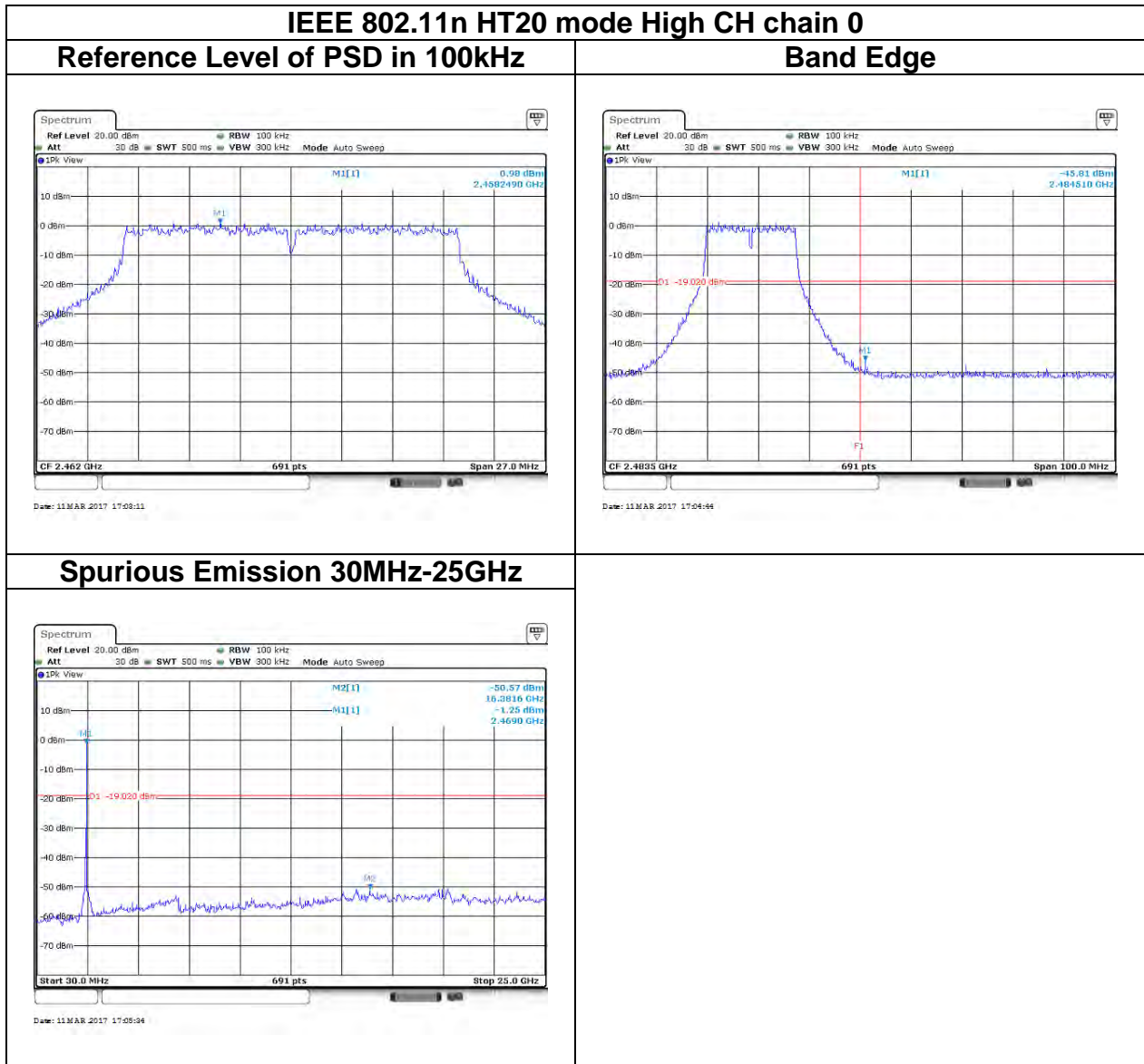

IEEE 802.11n HT20 mode High CH chain 1

Reference Level of PSD in 100kHz



Band Edge

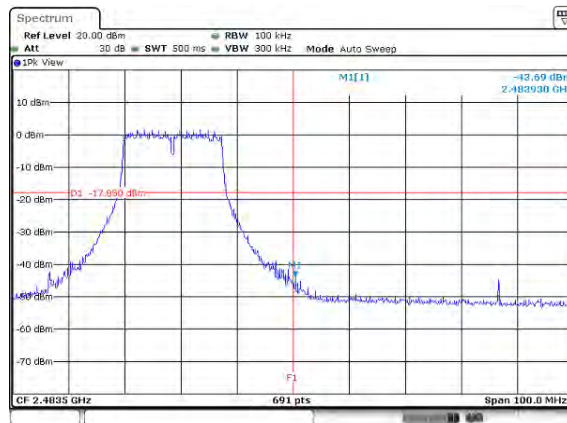

Spurious Emission 30MHz-25GHz

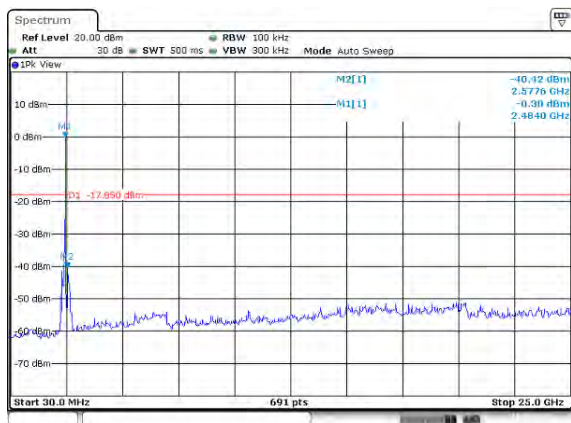

IEEE 802.11 n HT40 mode Low CH chain 0

Reference Level of PSD in 100kHz

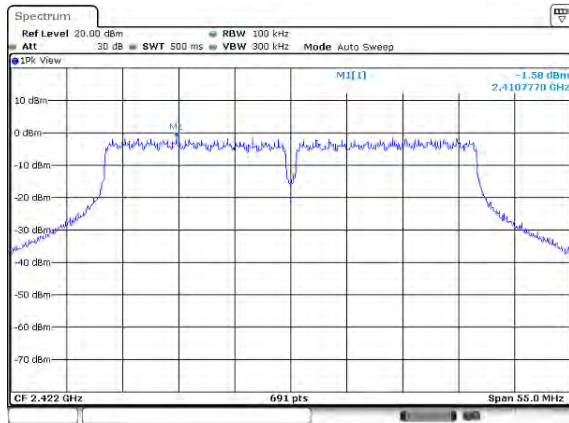

Band Edge

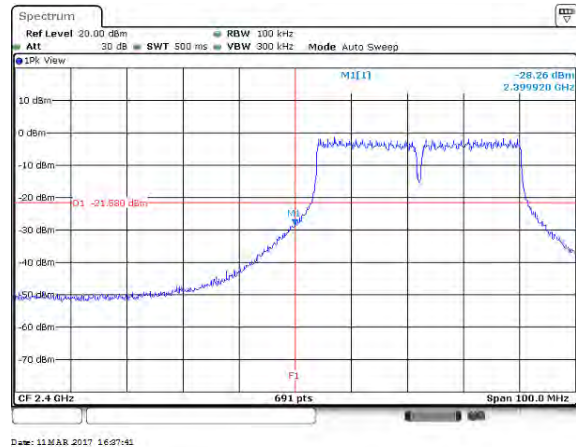

Spurious Emission 30MHz-25GHz

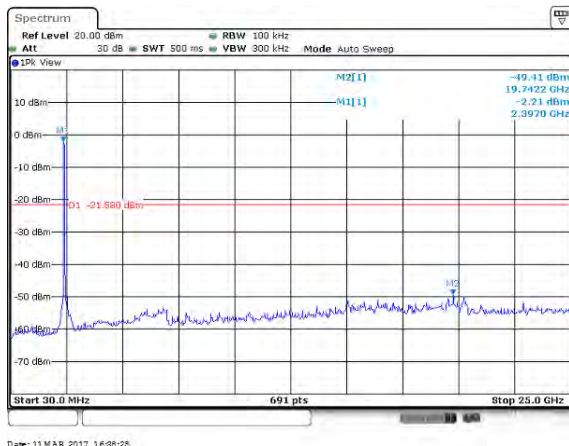

IEEE 802.11 n HT40 mode Low CH chain 1

Reference Level of PSD in 100kHz

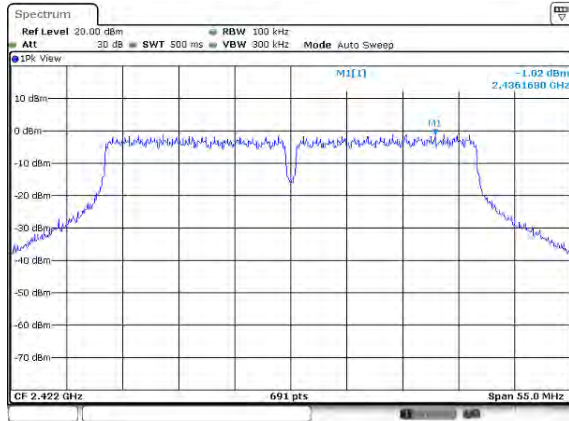

Band Edge

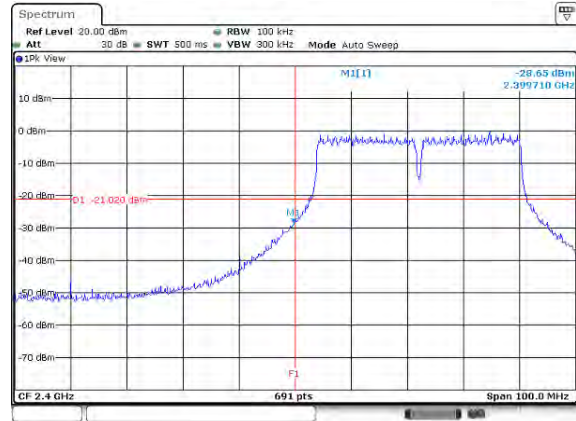

Spurious Emission 30MHz-25GHz

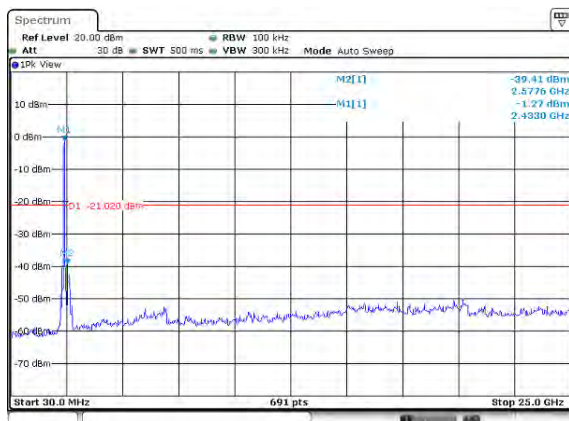

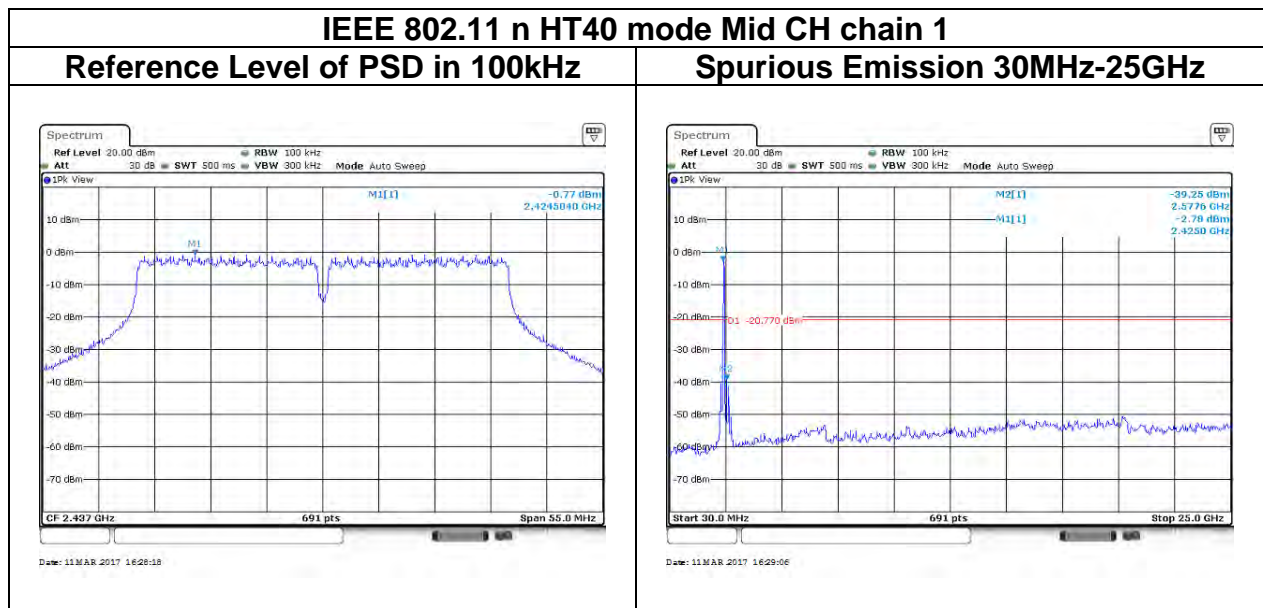
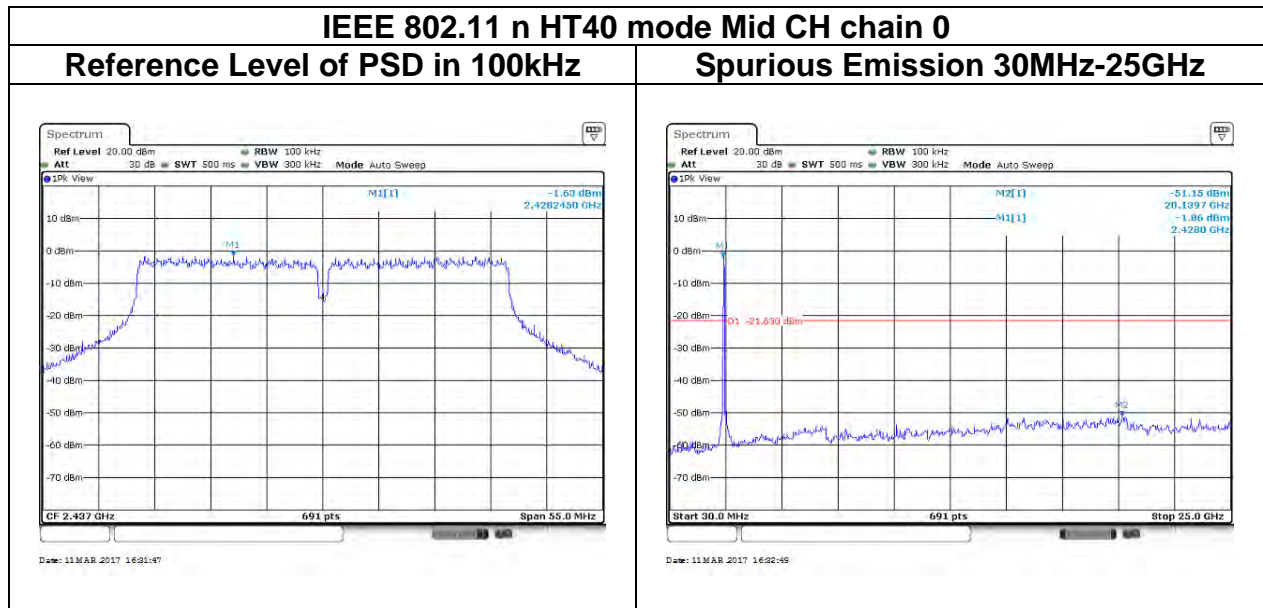

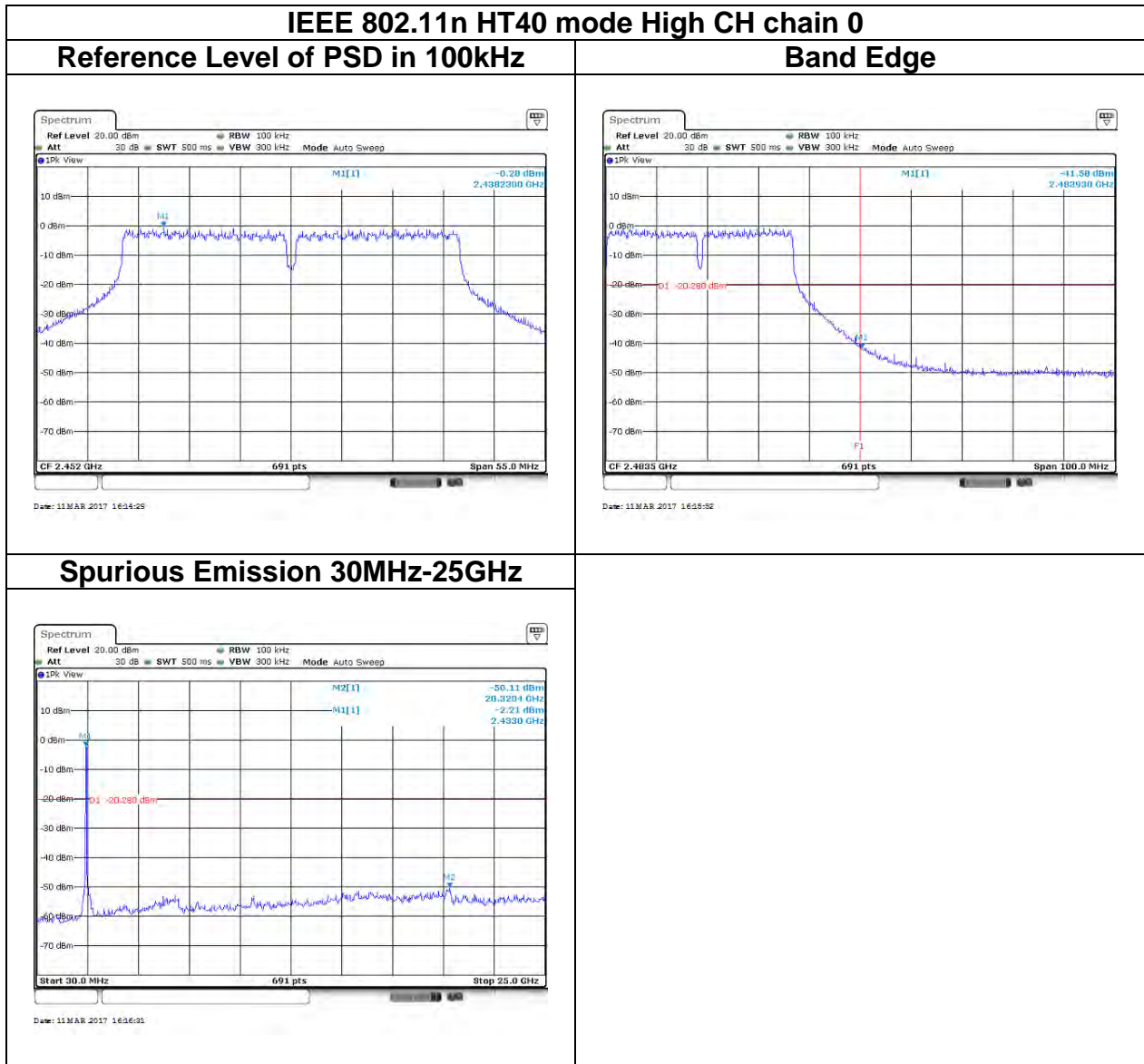

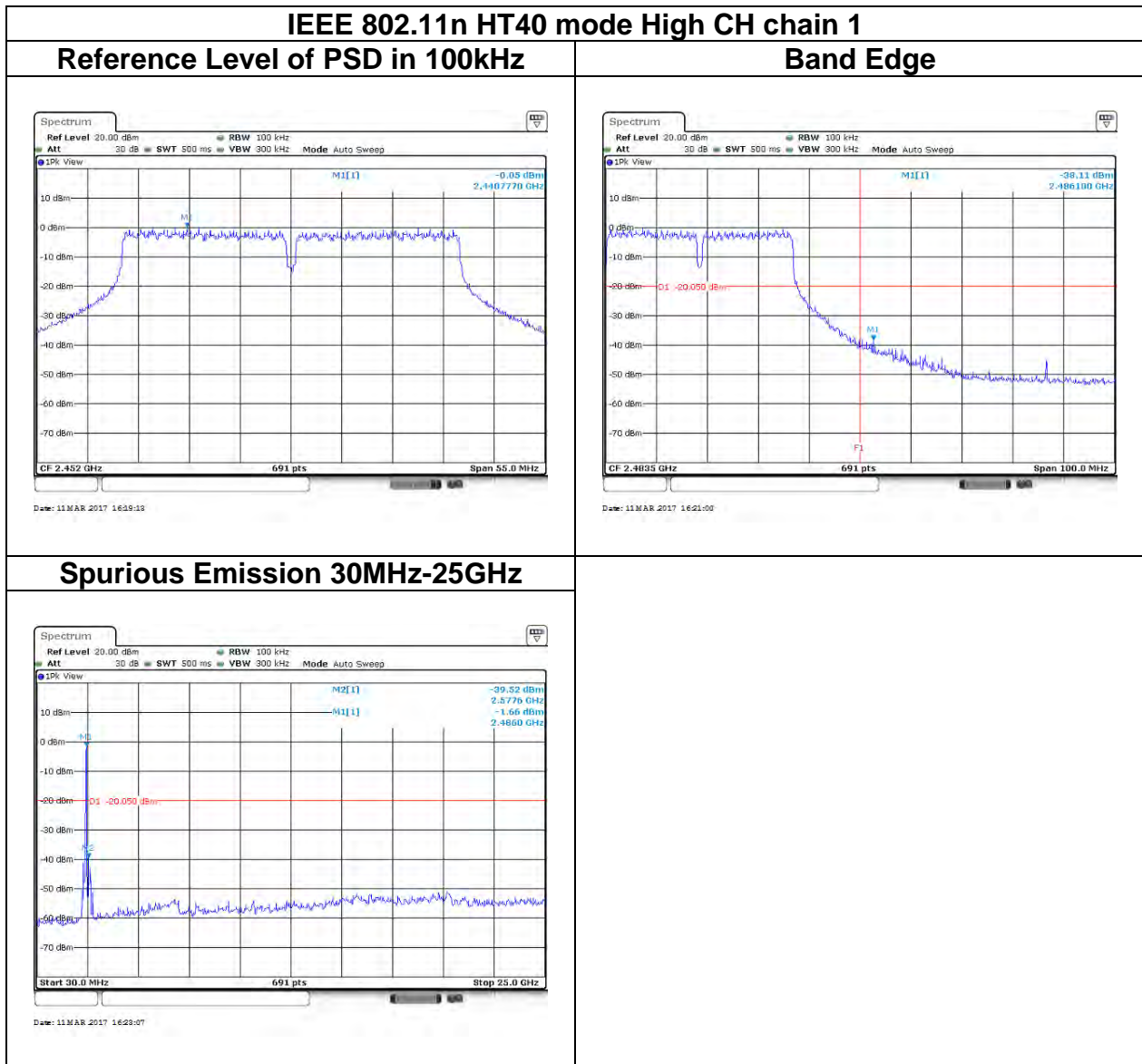

4.6 RADIATION BANDEGE AND SPURIOUS EMISSION

4.6.1 Test Limit

FCC according to §15.247(d), §15.209 and §15.205,

IC according to RSS-247 section 5.5, RSS-Gen, Section 8.9 and 8.10

In any 100 kHz bandwidth outside the authorized frequency band, all harmonic and spurious must be least 20 dB below the highest emission level with the authorized frequency band. Radiation emission which fall in the restricted bands must also follow the FCC section 15.209 as below limit in table.

Below 30 MHz

Frequency	Field Strength (microvolts/m)	Magnetic H-Field (microamperes/m)	Measurement Distance (metres)
9-490 kHz	2,400/F (F in kHz)	2,400/F (F in kHz)	300
490-1,705 kHz	24,000/F (F in kHz)	24,000/F (F in kHz)	30
1.705-30 MHz	30	N/A	30

Above 30 MHz

Frequency (MHz)	Field Strength microvolts/m at 3 metres (watts, e.i.r.p.)	
	Transmitters	Receivers
30-88	100 (3 nW)	100 (3 nW)
88-216	150 (6.8 nW)	150 (6.8 nW)
216-960	200 (12 nW)	200 (12 nW)
Above 960	500 (75 nW)	500 (75 nW)

Remark:

Although these tests were performed other than open area test site, adequate comparison measurements were confirmed against 30 m open are test site. Therefore sufficient tests were made to demonstrate that the alternative site produces results that correlate with the ones of tests made in an open field based on KDB 937606.

4.6.2 Test Procedure

Test method Refer as KDB 558074 D01 v03r05, Section 12.1.

1. The EUT is placed on a turntable, Above 1 GHz is 1.5m and below 1 GHz is 0.8m above ground plane. The EUT Configured un accordance with ANSI C63.10, and the EUT set in a continuous mode.
2. The turntable shall be rotated for 360 degrees to determine the position of maximum emission level. And EUT is set 3m away from the receiving antenna, which is scanned from 1m to 4m above the ground plane to find out the highest emissions. Measurement are made polarized in both the vertical and the horizontal positions with antenna.
3. Span shall wide enough to full capture the emission measured. The SA from 30MHz to 26.5GHz set to the low, Mid and High channels with the EUT transmit.
5. The SA setting following :
 - (1) Below 1G : RBW = 100kHz, VBW ≥ 3 RBW, Sweep = Auto, Detector = Peak, Trace = Max hold.
 - (2) Above 1G :
 - (2.1) For Peak measurement : RBW = 1MHz, VBW ≥ 3 RBW, Sweep = Auto, Detector = Peak, Trace = Max hold.
 - (2.2) For Average measurement : RBW = 1MHz, VBW
 - If Duty Cycle ≥ 98%, VBW=10Hz.
 - If Duty Cycle < 98%, VBW≥1/T.

Configuration	Duty Cycle (%)	T(μs)	1/T (kHz)	VBW
802.11b	100.00	822	-	10Hz
802.11g	98.59	140	-	10Hz
802.11n HT20	97.73	129	0.775	820Hz
802.11n HT40	94.74	360	2.778	3kHz

4.6.3 Test Setup

9kHz ~ 30MHz

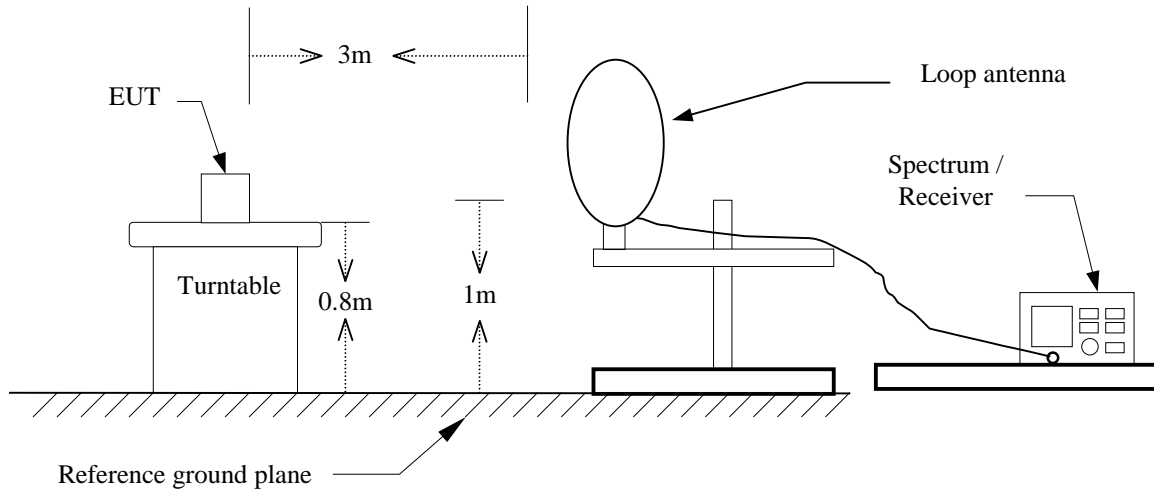

30MHz ~ 1GHz

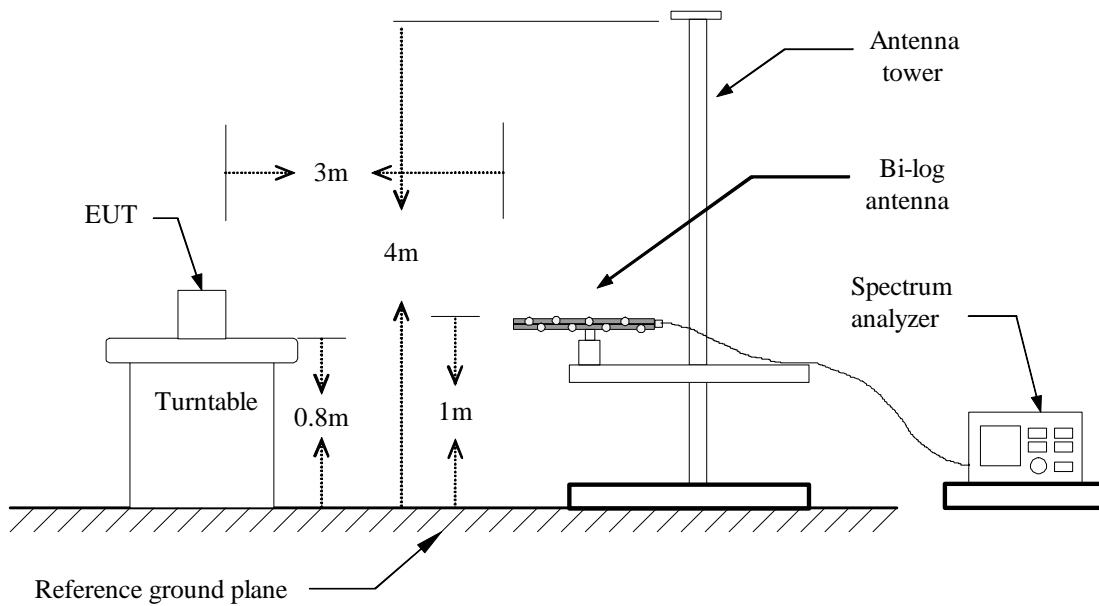

Above 1 GHz

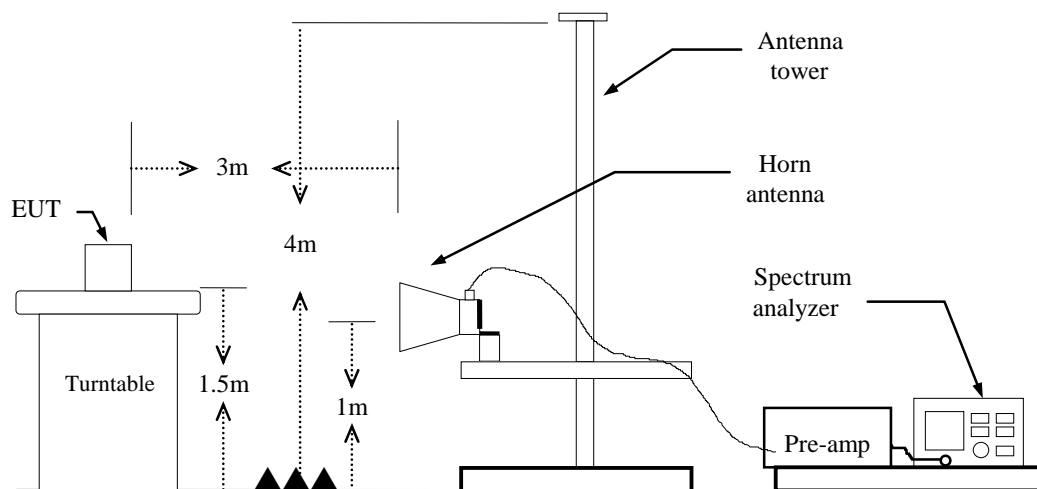

4.6.4 Test Result

Band Edge Test Data

Test Mode:	IEEE 802.11b Low CH	Temp/Hum	27(°C)/ 53%RH
Test Item	Band Edge	Test Date	March 19, 2017
Polarize	Vertical	Test Engineer	Ed Chiang
Detector	Peak		

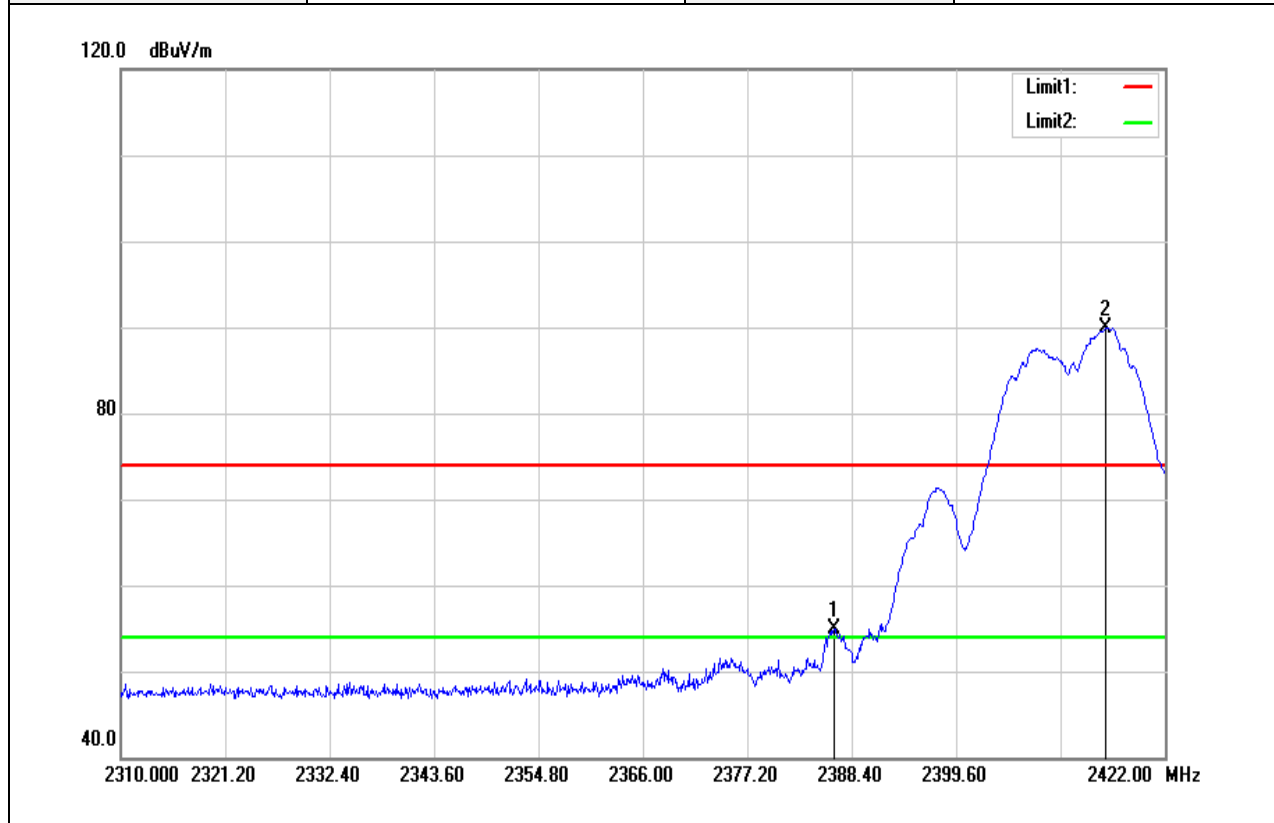

Frequency (MHz)	Reading (dBuV)	Correct Factor (dB/m)	Result (dBuV/m)	Limit (dBuV/m)	Margin (dB)	Remark
2386.496	57.37	-2.52	54.85	74.00	-19.15	peak
2415.616	92.29	-2.39	89.90	-	-	peak

Test Mode:	IEEE 802.11b Low CH	Temperature:	27(°C)/ 53%RH
Test Item	Band Edge	Test Date	March 19, 2017
Polarize	Vertical	Test Engineer	Ed Chiang
Detector	Average		

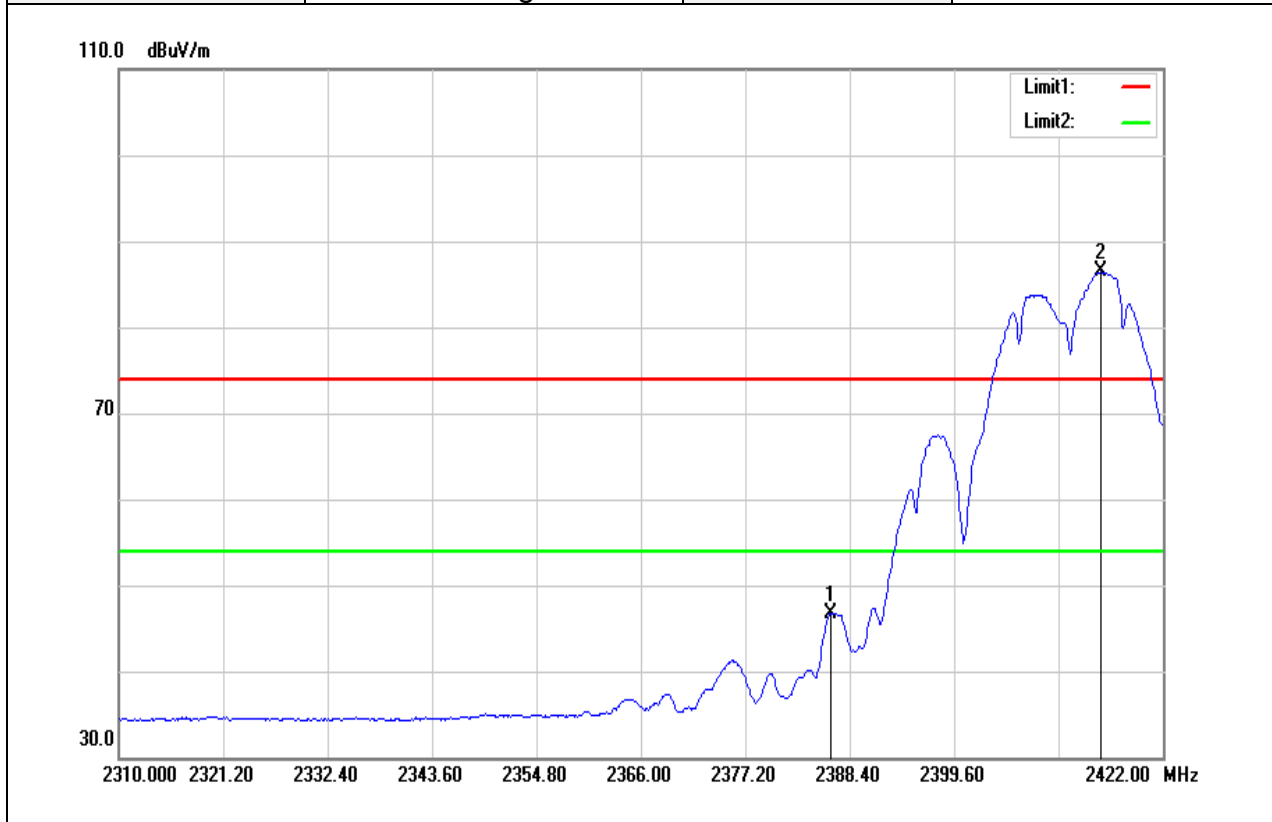

Frequency (MHz)	Reading (dBuV)	Correct Factor (dB/m)	Result (dBuV/m)	Limit (dBuV/m)	Margin (dB)	Remark
2386.384	49.31	-2.52	46.79	54.00	-7.21	AVG
2415.280	88.84	-2.39	86.45	-	-	AVG

Test Mode:	IEEE 802.11b High CH	Temp/Hum	27(°C)/ 53%RH
Test Item	Band Edge	Test Date	March 19, 2017
Polarize	Vertical	Test Engineer	Ed Chiang
Detector	Peak		

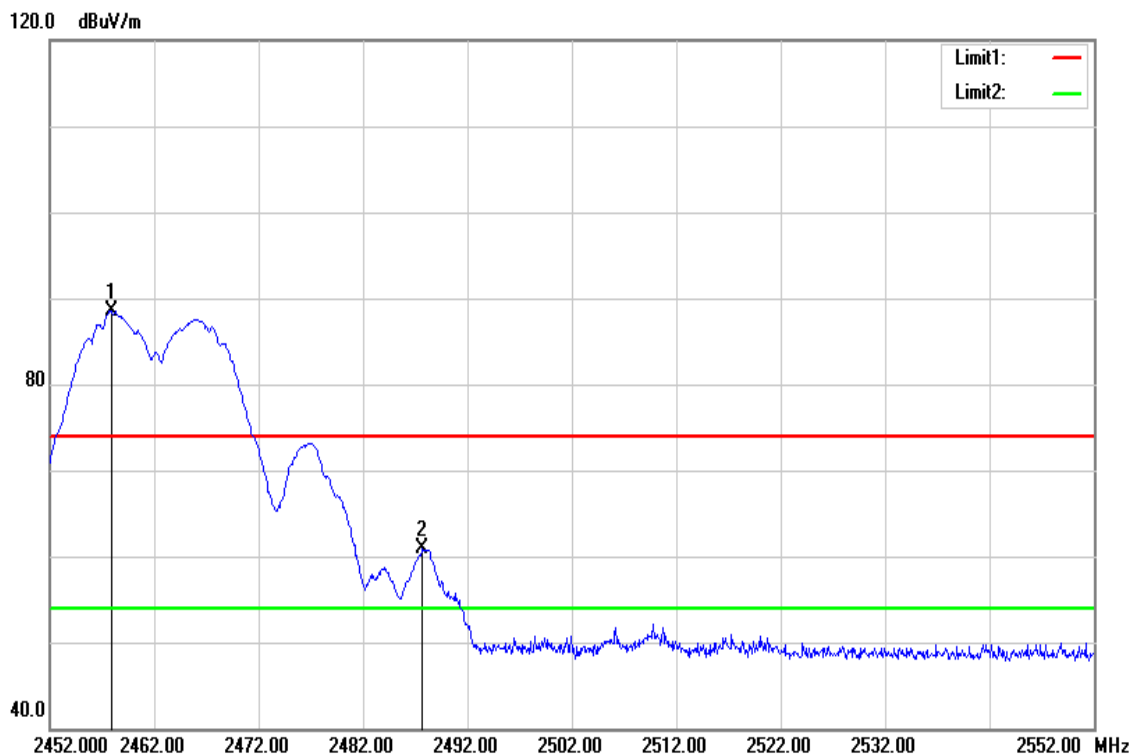

Frequency (MHz)	Reading (dBuV)	Correct Factor (dB/m)	Result (dBuV/m)	Limit (dBuV/m)	Margin (dB)	Remark
2457.900	90.60	-2.11	88.49	-	-	peak
2487.700	62.94	-1.95	60.99	74.00	-13.01	peak

Test Mode:	IEEE 802.11b High CH	Temperature:	27(°C)/ 53%RH
Test Item	Band Edge	Test Date	March 19, 2017
Polarize	Vertical	Test Engineer	Ed Chiang
Detector	Average		



Frequency (MHz)	Reading (dBuV)	Correct Factor (dB/m)	Result (dBuV/m)	Limit (dBuV/m)	Margin (dB)	Remark
2458.900	86.64	-2.11	84.53	-	-	AVG
2487.900	54.54	-1.95	52.59	54.00	-1.41	AVG

Test Mode:	IEEE 802.11g Low CH	Temp/Hum	27(°C)/ 53%RH
Test Item	Band Edge	Test Date	March 19, 2017
Polarize	Vertical	Test Engineer	Ed Chiang
Detector	Peak		

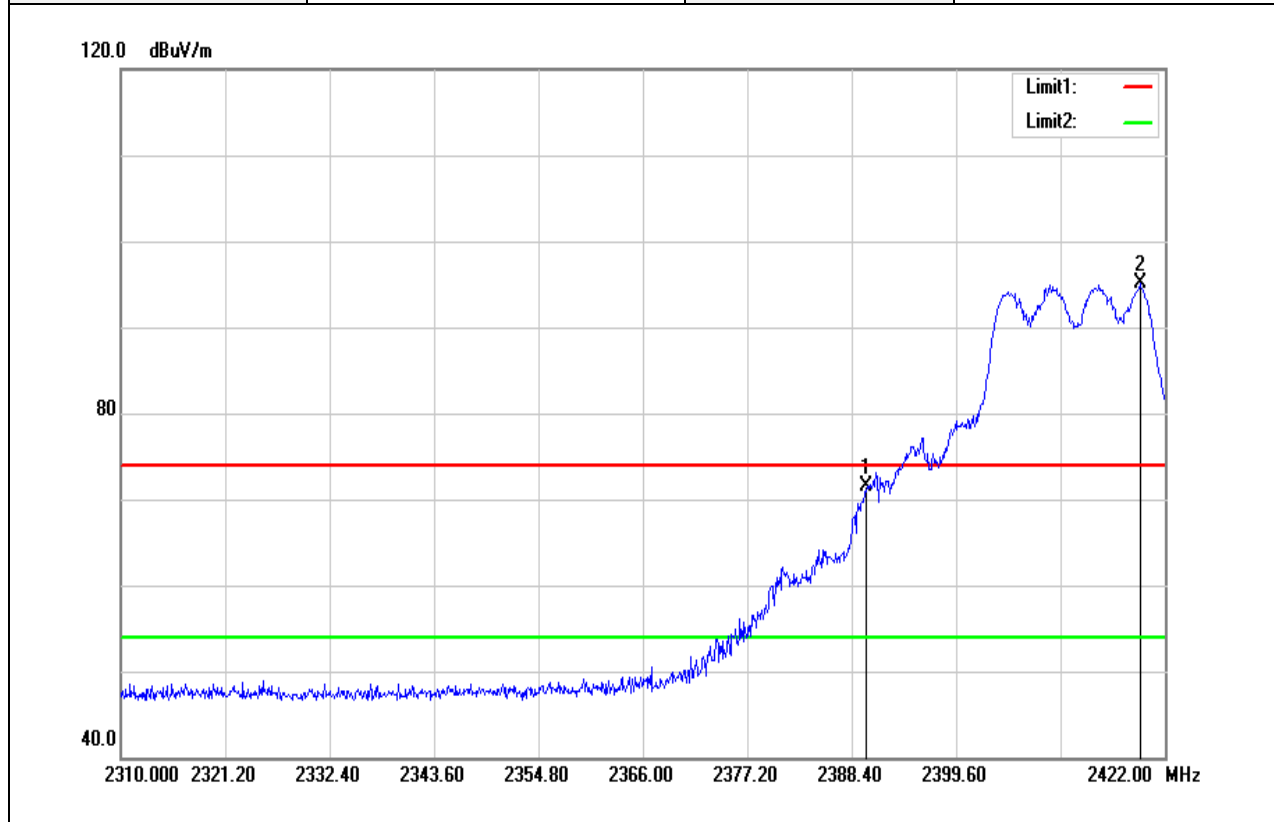

Frequency (MHz)	Reading (dBuV)	Correct Factor (dB/m)	Result (dBuV/m)	Limit (dBuV/m)	Margin (dB)	Remark
2390.000	73.96	-2.49	71.47	74.00	-2.53	peak
2419.312	97.48	-2.36	95.12	-	-	peak

Test Mode:	IEEE 802.11g Low CH	Temperature:	27(°C)/ 53%RH
Test Item	Band Edge	Test Date	March 19, 2017
Polarize	Vertical	Test Engineer	Ed Chiang
Detector	Average		

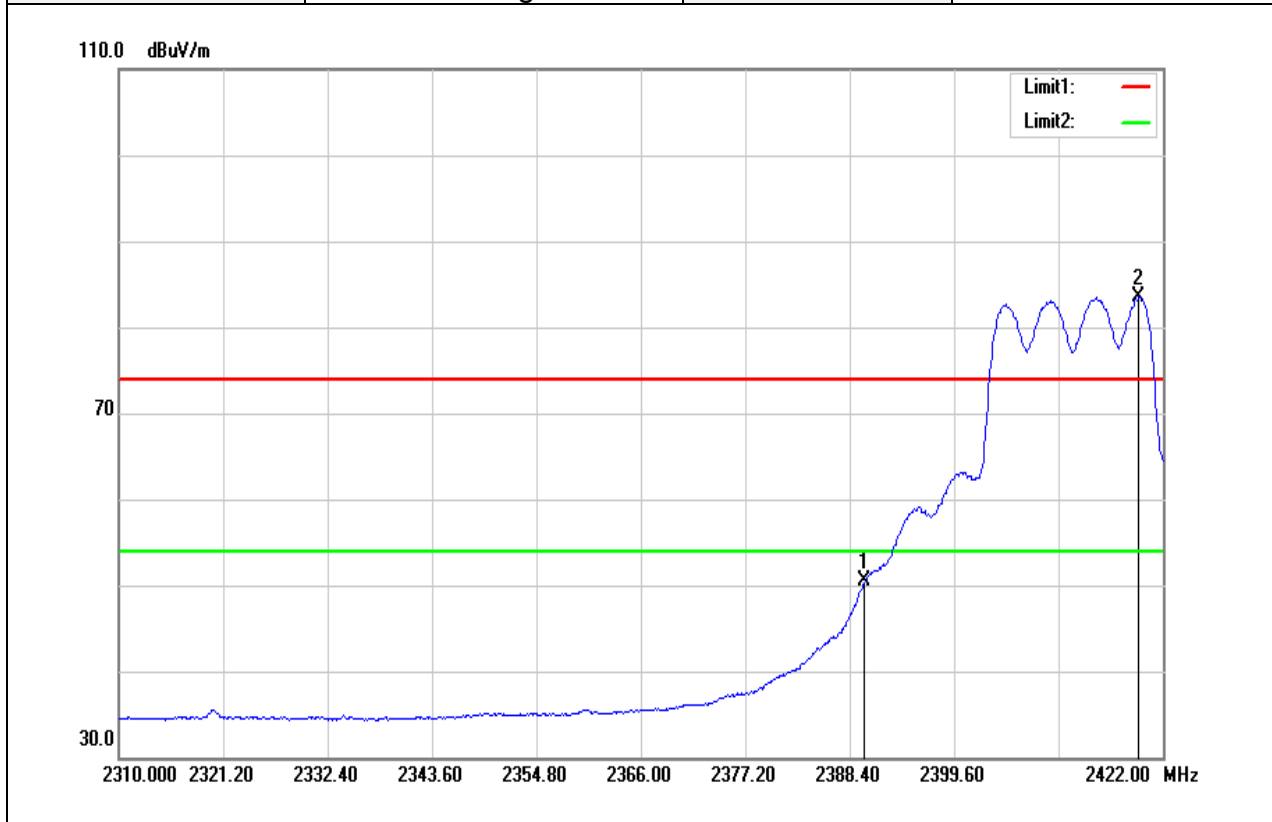

Frequency (MHz)	Reading (dBuV)	Correct Factor (dB/m)	Result (dBuV/m)	Limit (dBuV/m)	Margin (dB)	Remark
2390.000	52.98	-2.49	50.49	54.00	-3.51	AVG
2419.424	85.87	-2.36	83.51	-	-	AVG

Test Mode:	IEEE 802.11g High CH	Temp/Hum	27(°C)/ 53%RH
Test Item	Band Edge	Test Date	March 19, 2017
Polarize	Vertical	Test Engineer	Ed Chiang
Detector	Peak		

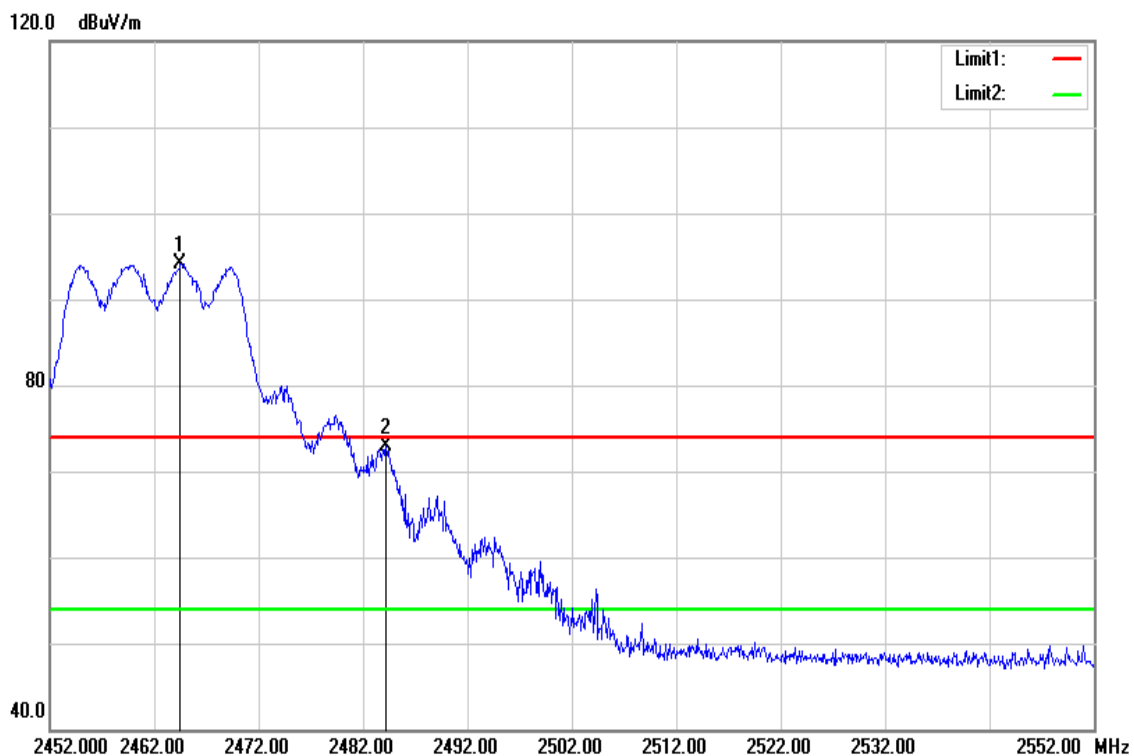

Frequency (MHz)	Reading (dBuV)	Correct Factor (dB/m)	Result (dBuV/m)	Limit (dBuV/m)	Margin (dB)	Remark
2464.500	96.26	-2.09	94.17	-	-	peak
2484.200	74.81	-1.99	72.82	74.00	-1.18	peak

Test Mode:	IEEE 802.11g High CH	Temperature:	27(°C)/ 53%RH
Test Item	Band Edge	Test Date	March 19, 2017
Polarize	Vertical	Test Engineer	Ed Chiang
Detector	Average		

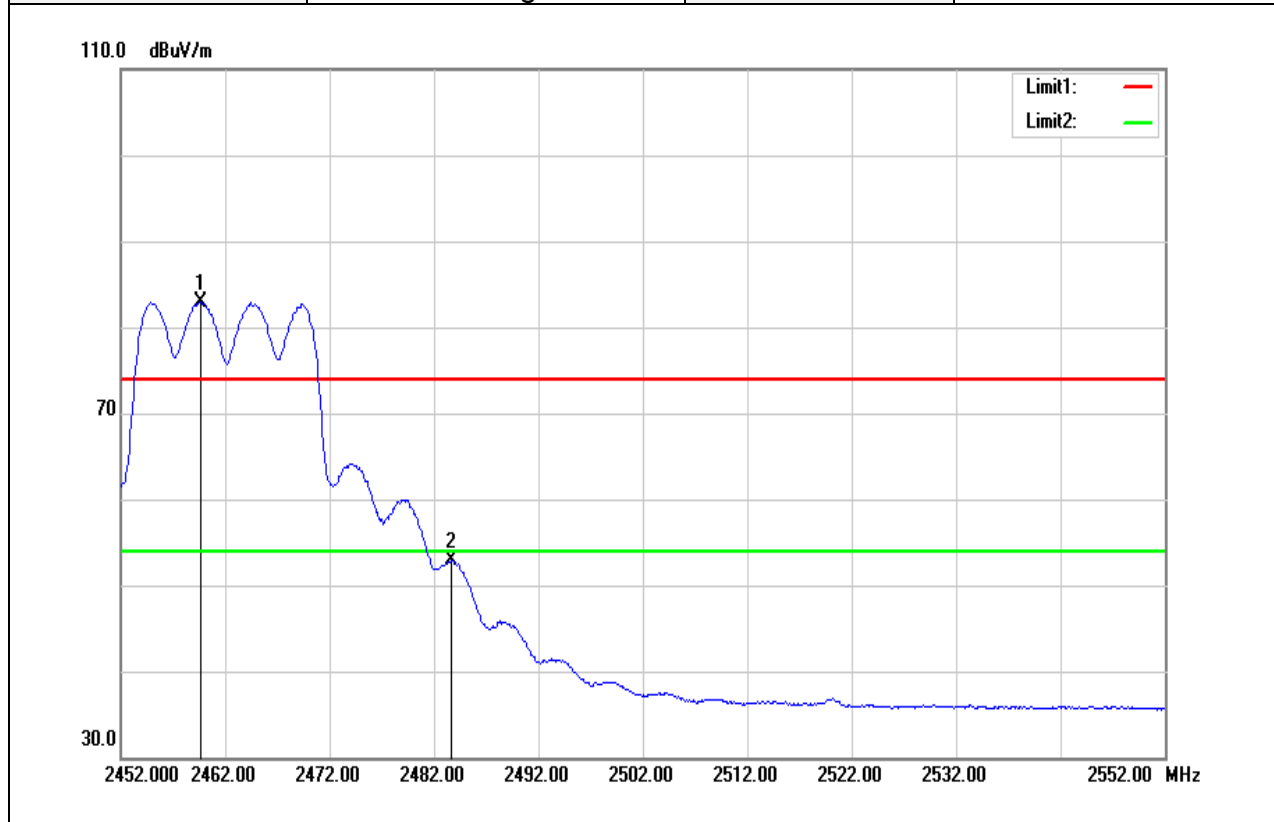

Frequency (MHz)	Reading (dBuV)	Correct Factor (dB/m)	Result (dBuV/m)	Limit (dBuV/m)	Margin (dB)	Remark
2459.700	85.02	-2.10	82.92	-	-	AVG
2483.700	54.98	-1.99	52.99	54.00	-1.01	AVG

Test Mode:	IEEE 802.11n HT20 Low CH	Temp/Hum	27(°C)/ 53%RH
Test Item	Band Edge	Test Date	March 19, 2017
Polarize	Vertical	Test Engineer	Ed Chiang
Detector	Peak		

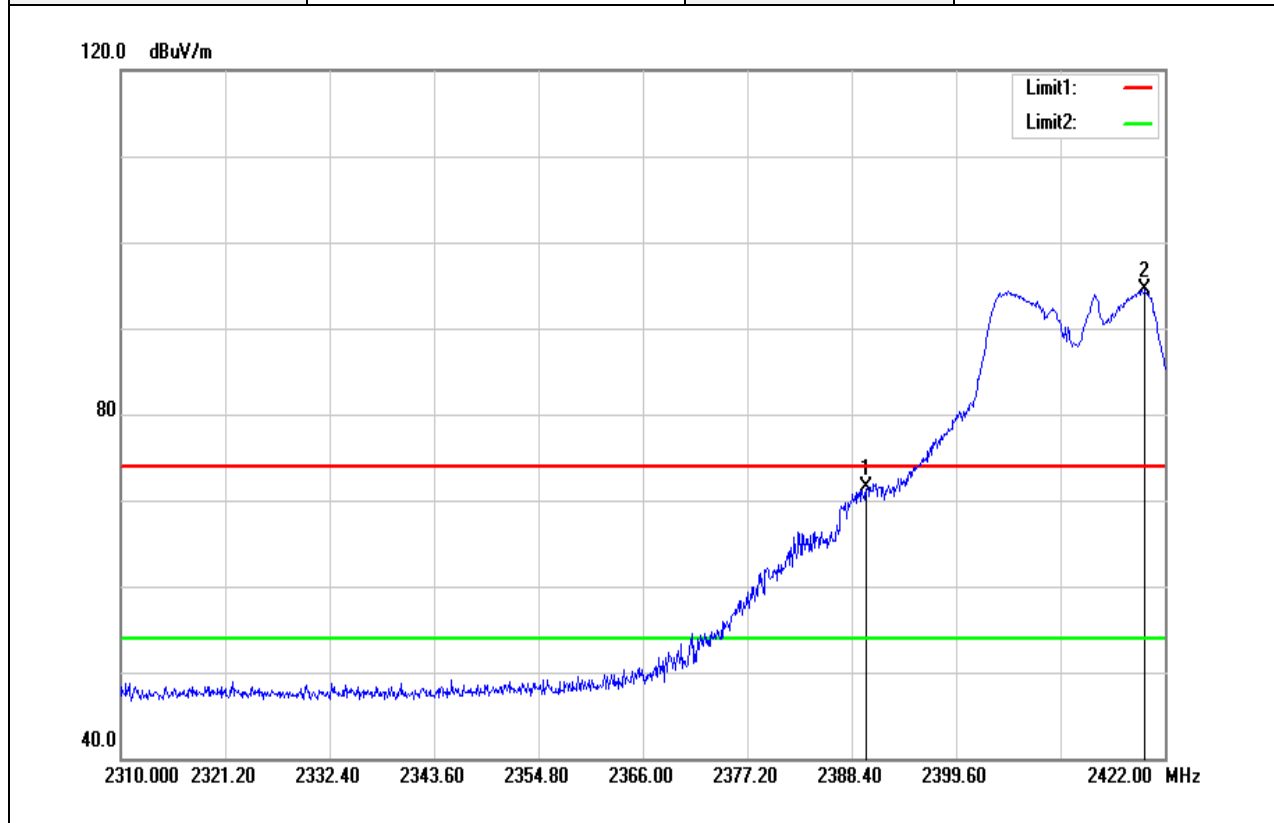

Frequency (MHz)	Reading (dBuV)	Correct Factor (dB/m)	Result (dBuV/m)	Limit (dBuV/m)	Margin (dB)	Remark
2390.000	74.05	-2.49	71.56	74.00	-2.44	peak
2419.872	96.85	-2.36	94.49	-	-	peak

Test Mode:	IEEE 802.11n HT20 Low CH	Temperature:	27(°C)/ 53%RH
Test Item	Band Edge	Test Date	March 19, 2017
Polarize	Vertical	Test Engineer	Ed Chiang
Detector	Average		

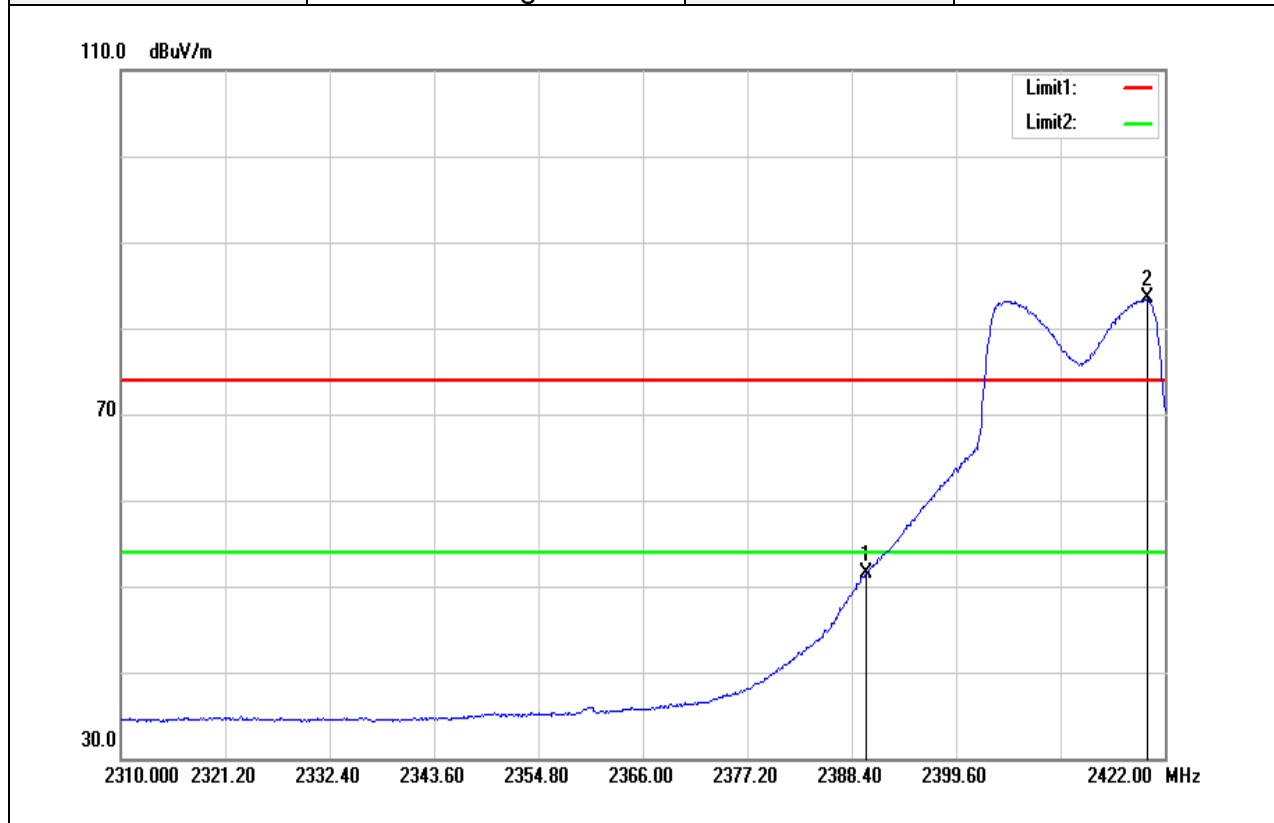

Frequency (MHz)	Reading (dBuV)	Correct Factor (dB/m)	Result (dBuV/m)	Limit (dBuV/m)	Margin (dB)	Remark
2390.000	54.06	-2.49	51.57	54.00	-2.43	AVG
2420.096	85.80	-2.36	83.44	-	-	AVG

Test Mode:	IEEE 802.11n HT20 High CH	Temp/Hum	27(°C)/ 53%RH
Test Item	Band Edge	Test Date	March 19, 2017
Polarize	Vertical	Test Engineer	Ed Chiang
Detector	Peak		

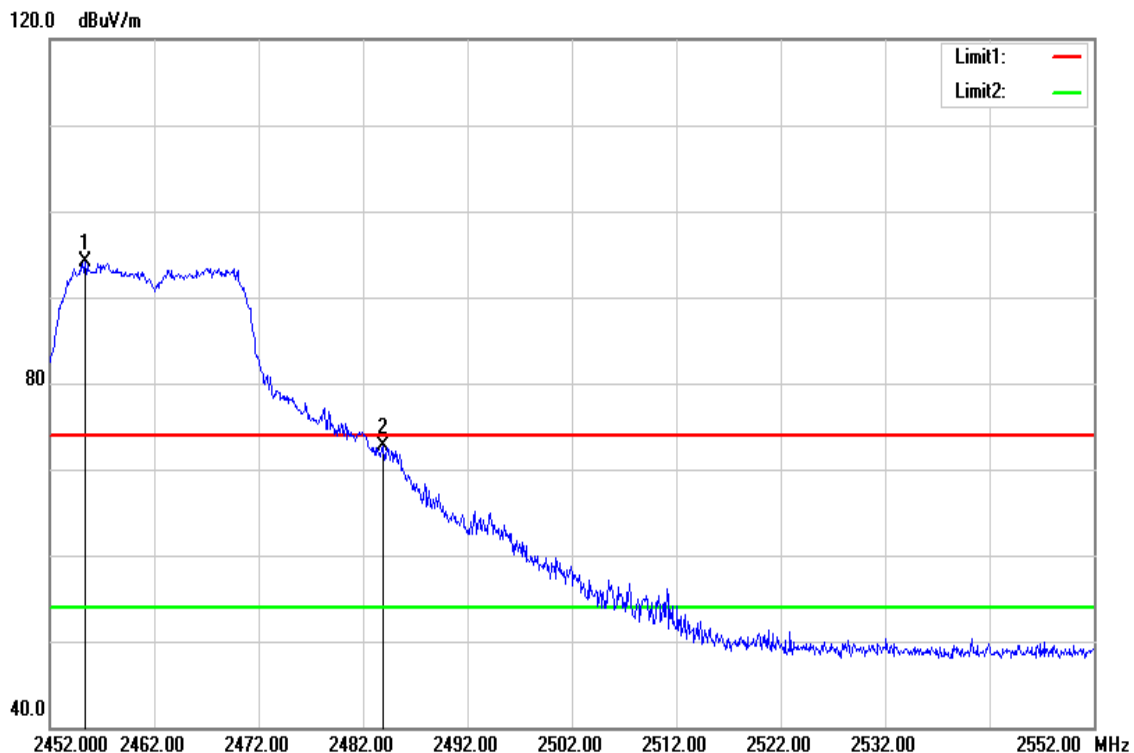

Frequency (MHz)	Reading (dBuV)	Correct Factor (dB/m)	Result (dBuV/m)	Limit (dBuV/m)	Margin (dB)	Remark
2455.400	96.21	-2.12	94.09	-	-	peak
2483.900	74.65	-1.99	72.66	74.00	-1.34	peak

Test Mode:	IEEE 802.11n HT20 High CH	Temperature:	27(°C)/ 53%RH
Test Item	Band Edge	Test Date	March 19, 2017
Polarize	Vertical	Test Engineer	Ed Chiang
Detector	Average		

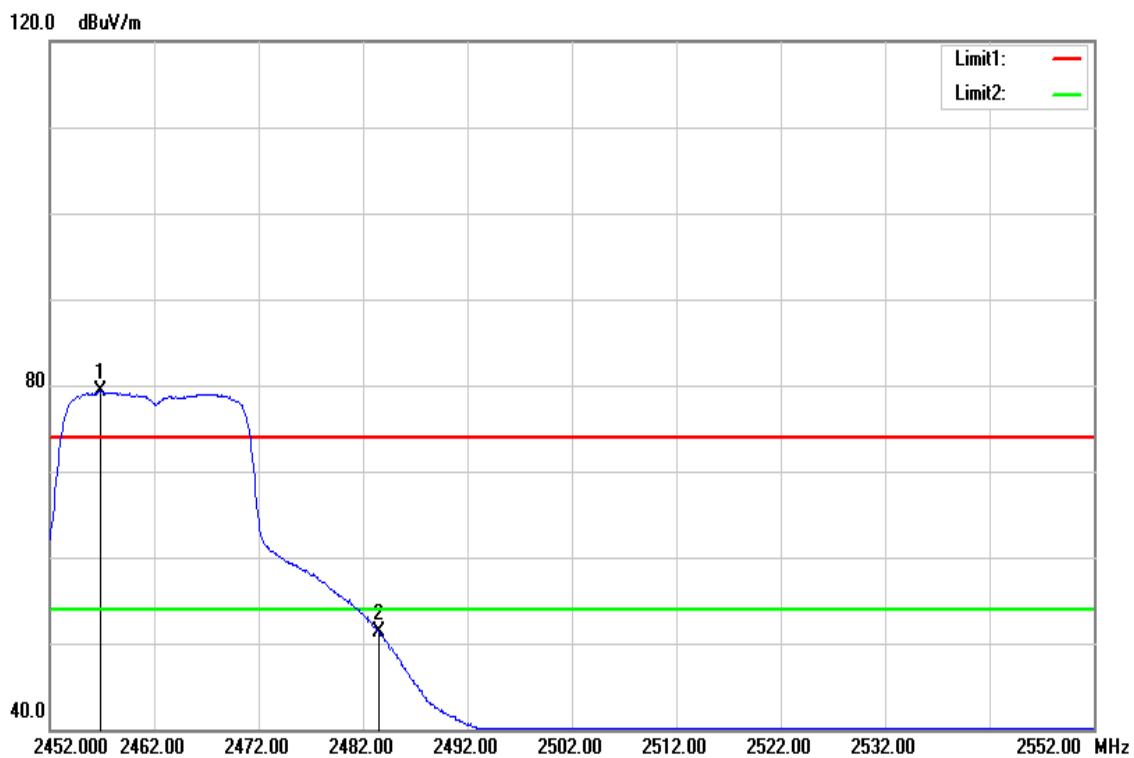

Frequency (MHz)	Reading (dBuV)	Correct Factor (dB/m)	Result (dBuV/m)	Limit (dBuV/m)	Margin (dB)	Remark
2456.800	81.38	-2.12	79.26	-	-	AVG
2483.500	53.38	-1.99	51.39	54.00	-2.61	AVG

Test Mode:	IEEE 802.11n HT40 Low CH	Temp/Hum	27(°C)/ 53%RH
Test Item	Band Edge	Test Date	March 19, 2017
Polarize	Vertical	Test Engineer	Ed Chiang
Detector	Peak		

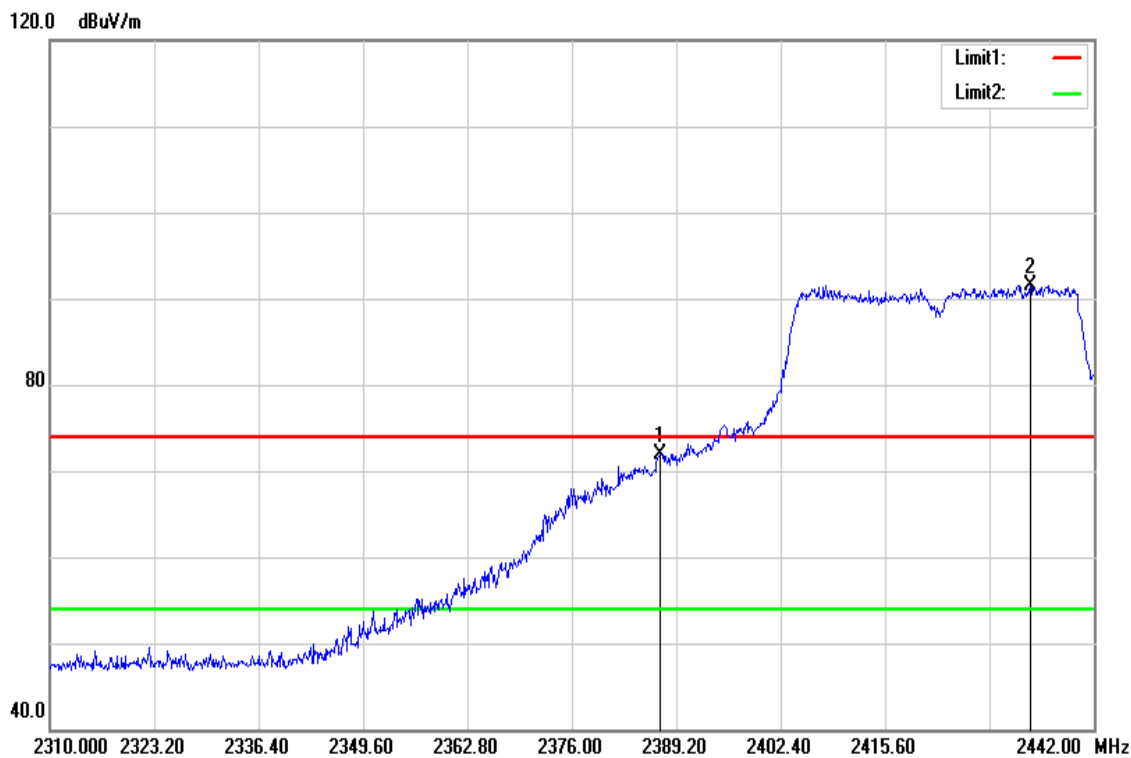

Frequency (MHz)	Reading (dBuV)	Correct Factor (dB/m)	Result (dBuV/m)	Limit (dBuV/m)	Margin (dB)	Remark
2387.088	74.48	-2.52	71.96	74.00	-2.04	peak
2433.948	93.73	-2.26	91.47	-	-	peak

Test Mode:	IEEE 802.11n HT40 Low CH	Temperature:	27(°C)/ 53%RH
Test Item	Band Edge	Test Date	March 19, 2017
Polarize	Vertical	Test Engineer	Ed Chiang
Detector	Average		

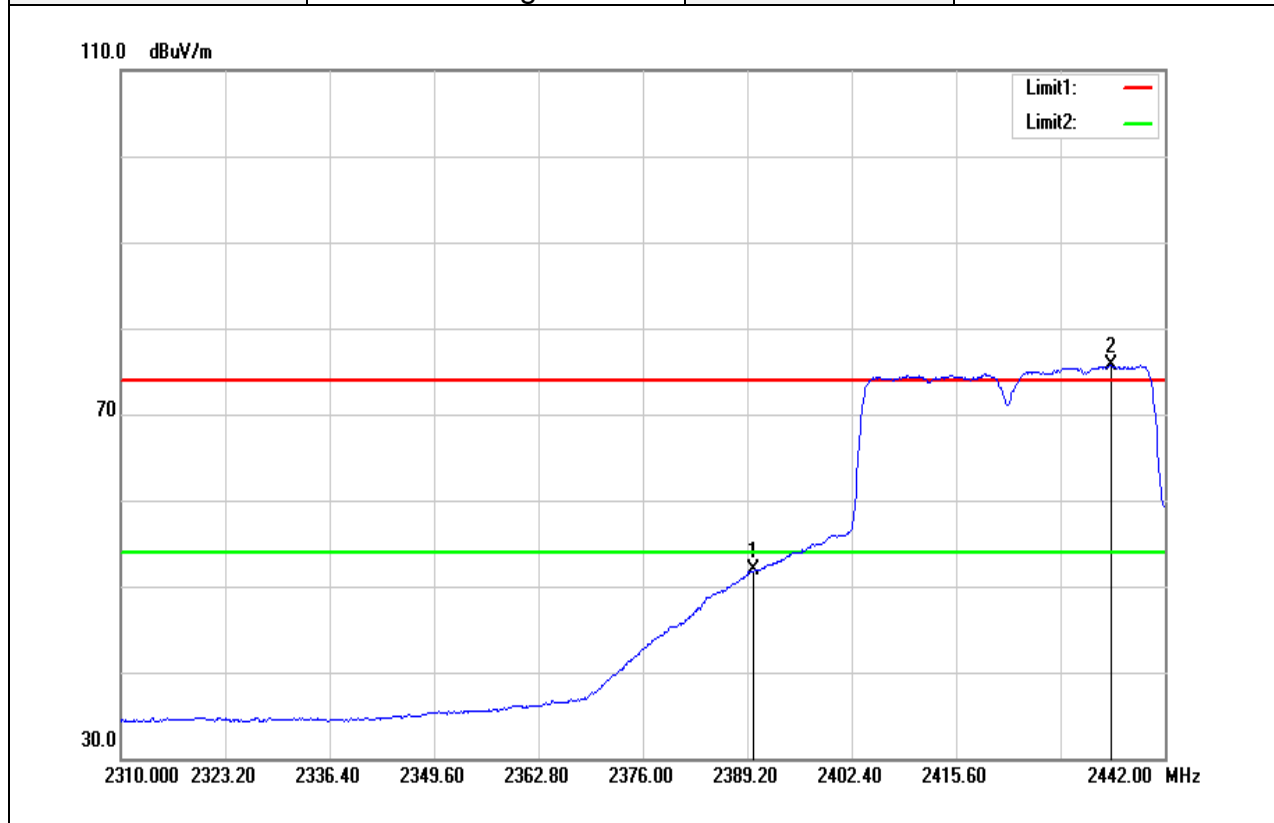

Frequency (MHz)	Reading (dBuV)	Correct Factor (dB/m)	Result (dBuV/m)	Limit (dBuV/m)	Margin (dB)	Remark
2390.000	54.30	-2.49	51.81	54.00	-2.19	AVG
2435.268	77.95	-2.25	75.70	-	-	AVG

Test Mode:	IEEE 802.11n HT40 High CH	Temp/Hum	27(°C)/ 53%RH
Test Item	Band Edge	Test Date	March 19, 2017
Polarize	Vertical	Test Engineer	Ed Chiang
Detector	Peak		

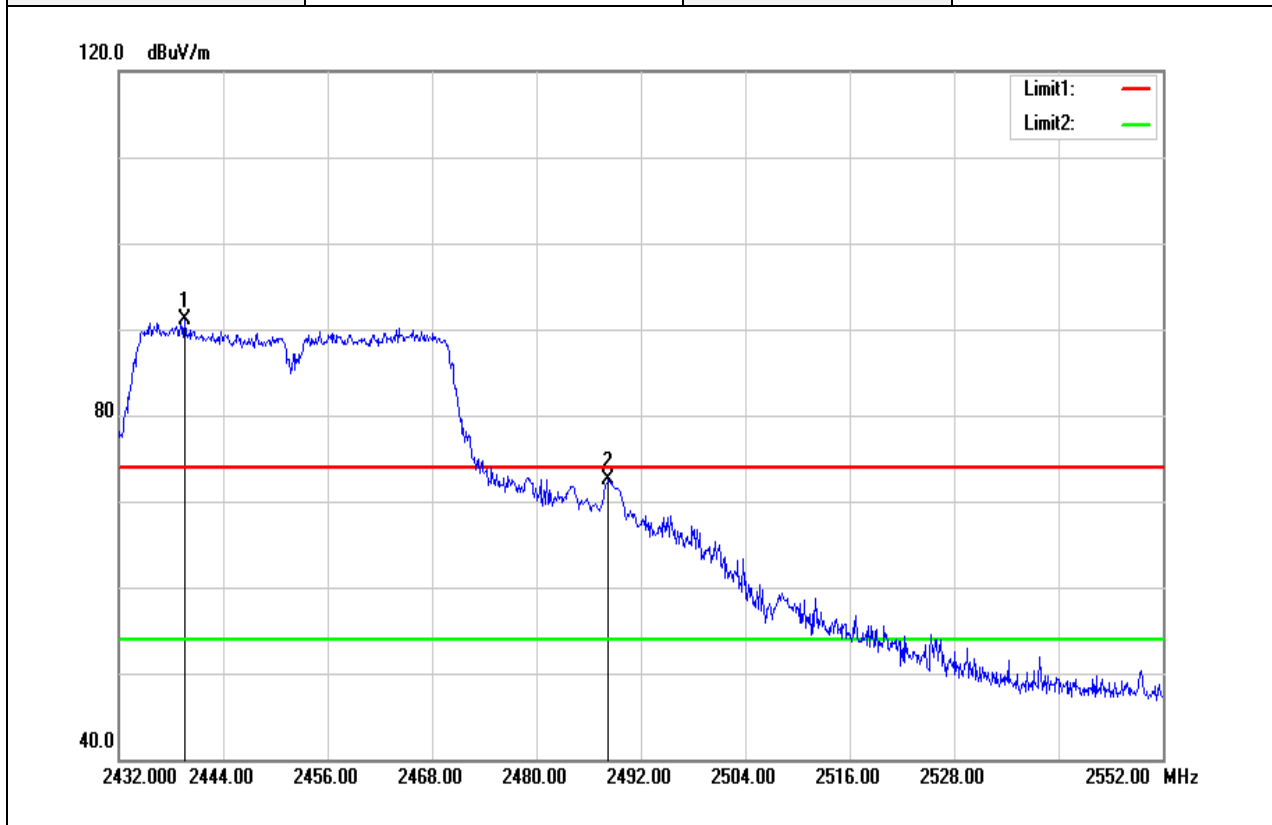

Frequency (MHz)	Reading (dBuV)	Correct Factor (dB/m)	Result (dBuV/m)	Limit (dBuV/m)	Margin (dB)	Remark
2439.560	93.25	-2.22	91.03	-	-	peak
2488.280	74.36	-1.95	72.41	74.00	-1.59	peak

Test Mode:	IEEE 802.11n HT40 High CH	Temperature:	27(°C)/ 53%RH
Test Item	Band Edge	Test Date	March 19, 2017
Polarize	Vertical	Test Engineer	Ed Chiang
Detector	Average		

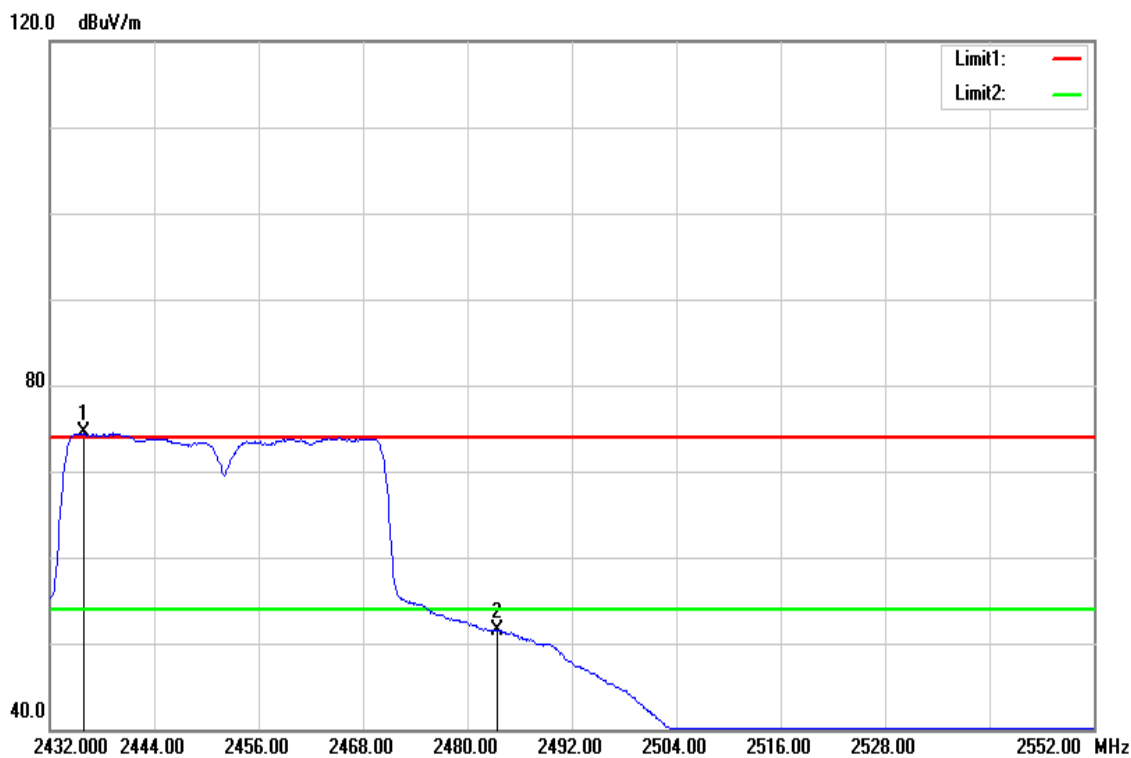

Frequency (MHz)	Reading (dBuV)	Correct Factor (dB/m)	Result (dBuV/m)	Limit (dBuV/m)	Margin (dB)	Remark
2435.960	76.66	-2.24	74.42	-	-	AVG
2483.500	53.51	-1.99	51.52	54.00	-2.48	AVG

Below 1G Test Data

Test Mode:	Mode 1	Temp/Hum	27(°C)/ 53%RH
Test Item	30MHz-1GHz	Test Date	January 14, 2017
Polarize	Vertical	Test Engineer	Kevin Kuo
Detector	Peak and Qusi-peak		

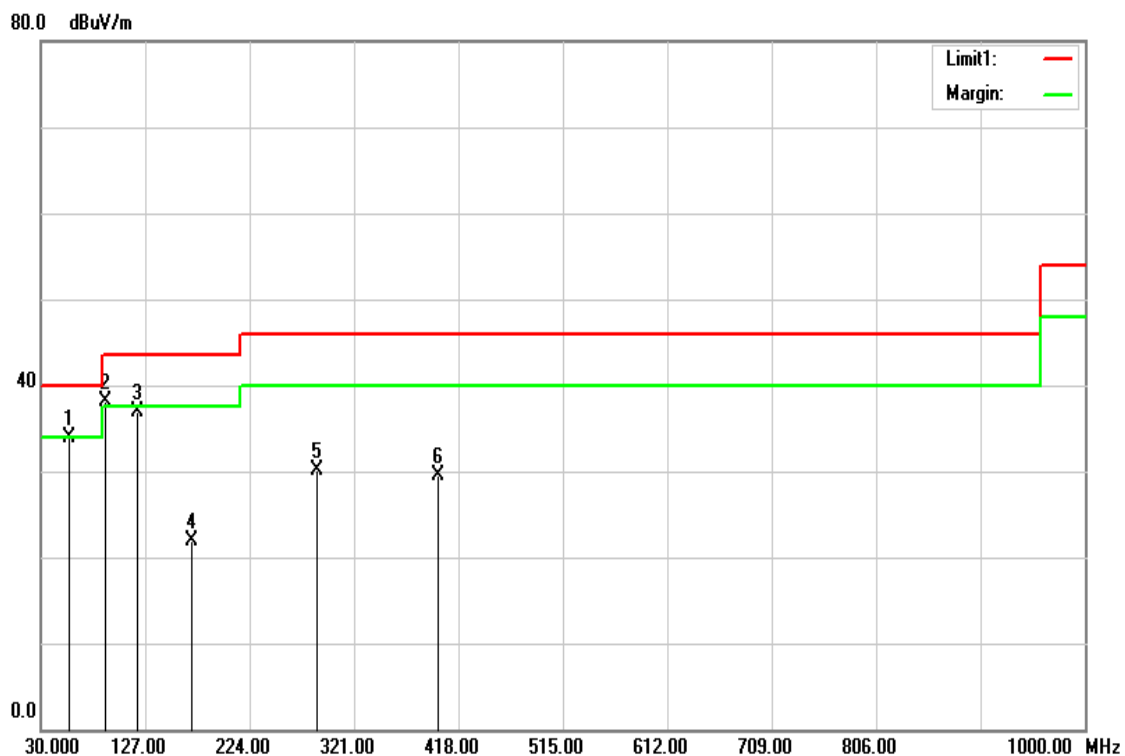

Frequency (MHz)	Reading (dBuV)	Correct Factor (dB/m)	Result (dBuV/m)	Limit (dBuV/m)	Margin (dB)	Remark
56.1900	55.65	-21.71	33.94	40.00	-6.06	QP
90.1400	59.66	-21.47	38.19	43.50	-5.31	QP
120.2100	52.47	-15.50	36.97	43.50	-6.53	QP
169.6800	38.69	-16.83	21.86	43.50	-21.64	QP
286.0800	44.52	-14.50	30.02	46.00	-15.98	peak
399.5700	41.19	-11.71	29.48	46.00	-16.52	peak

Test Mode:	IEEE 802.11g Low CH	Temp/Hum	27(°C)/ 53%RH
Test Item	30MHz-1GHz	Test Date	January 14, 2017
Polarize	Horizontal	Test Engineer	Kevin Kuo
Detector	Peak and Qusi-peak		

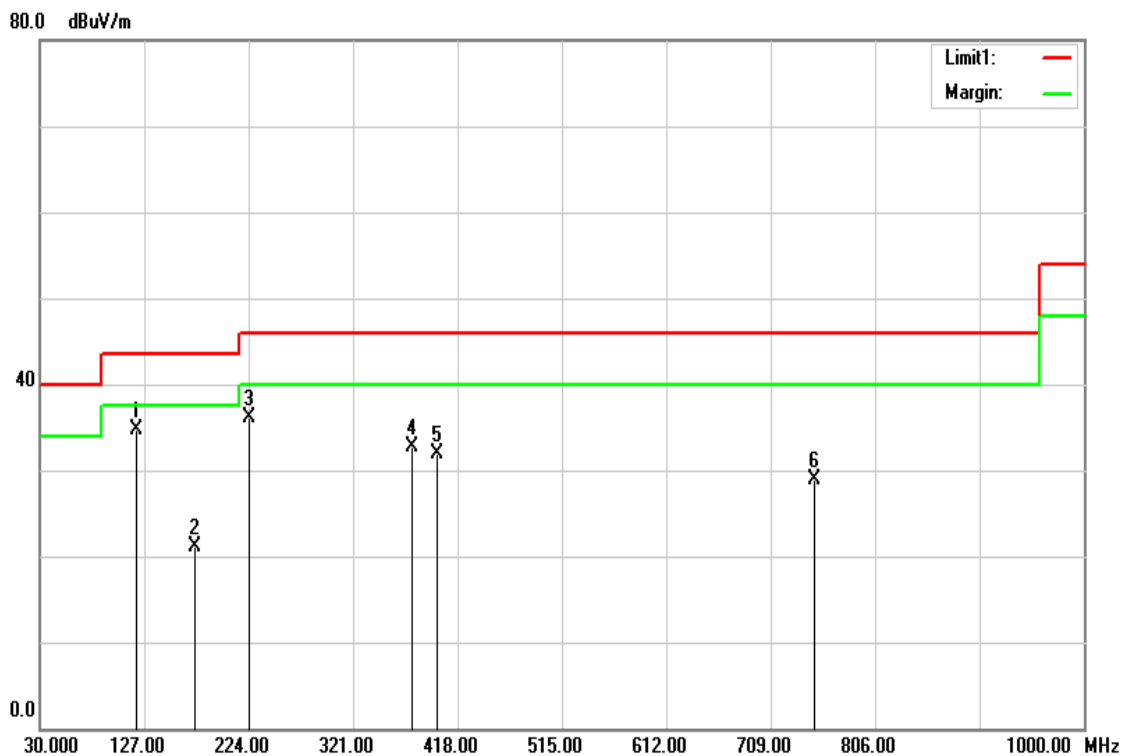

Frequency (MHz)	Reading (dBuV)	Correct Factor (dB/m)	Result (dBuV/m)	Limit (dBuV/m)	Margin (dB)	Remark
120.2100	50.30	-15.50	34.80	43.50	-8.70	peak
174.5300	38.26	-17.07	21.19	43.50	-22.31	QP
224.9700	52.93	-16.85	36.08	46.00	-9.92	peak
375.3200	44.98	-12.29	32.69	46.00	-13.31	peak
399.5700	43.65	-11.71	31.94	46.00	-14.06	peak
749.7400	33.78	-4.93	28.85	46.00	-17.15	peak

Above 1G Test Data

Test Mode:	IEEE 802.11b Low CH	Temp/Hum	27(°C)/ 53%RH
Test Item	Harmonic	Test Date	March 19, 2017
Polarize	Vertical	Test Engineer	Ed Chiang
Detector	Peak and Average		

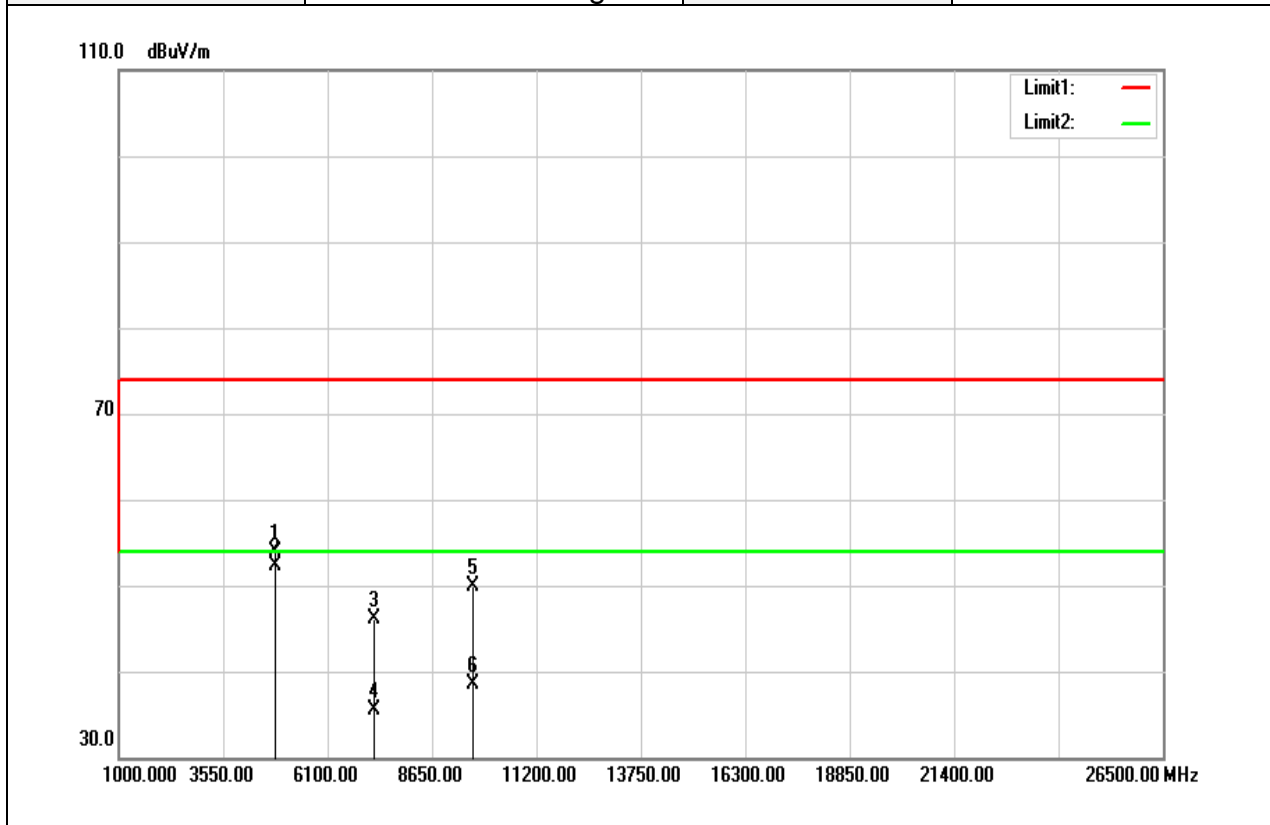

Frequency (MHz)	Reading (dBuV)	Correct Factor (dB/m)	Result (dBuV/m)	Limit (dBuV/m)	Margin (dB)	Remark
4827.000	48.71	5.11	53.82	74.00	-20.18	peak
4827.000	47.28	5.11	52.39	54.00	-1.61	AVG
7236.000	33.34	12.71	46.05	74.00	-27.95	peak
7236.000	22.82	12.71	35.53	54.00	-18.47	AVG
9648.000	32.37	17.60	49.97	74.00	-24.03	peak
9648.000	20.88	17.60	38.48	54.00	-15.52	AVG

Remark:

1. Measuring frequencies from 1 GHz to the 10th harmonic of highest fundamental frequency.
2. For above 1GHz, the EUT peak value was under average limit, therefore the Average value compliance with the average limit

Test Mode:	IEEE 802.11b Low CH	Temp/Hum	27(°C)/ 53%RH
Test Item	Harmonic	Test Date	March 19, 2017
Polarize	Horizontal	Test Engineer	Ed Chiang
Detector	Peak and Average		

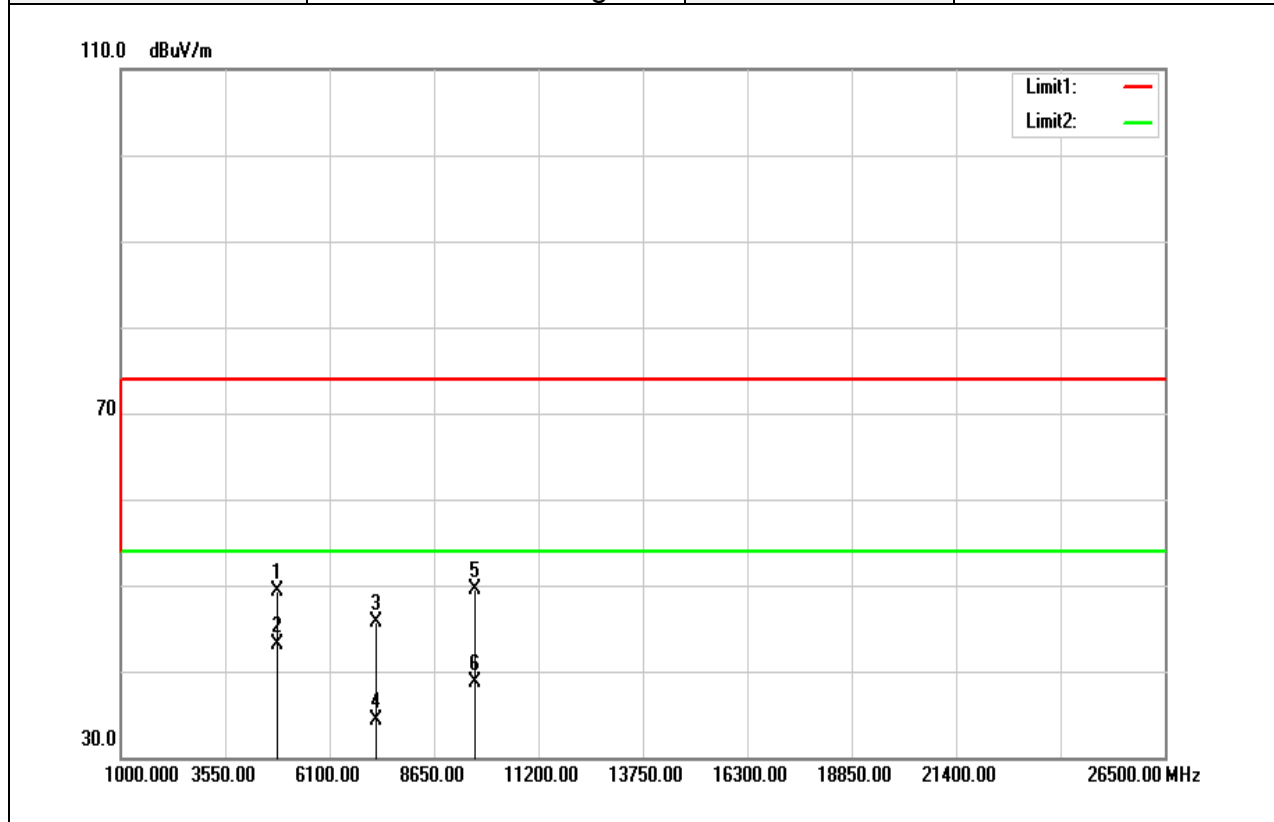

Frequency (MHz)	Reading (dBuV)	Correct Factor (dB/m)	Result (dBuV/m)	Limit (dBuV/m)	Margin (dB)	Remark
4827.000	44.21	5.11	49.32	74.00	-24.68	peak
4827.000	38.07	5.11	43.18	54.00	-10.82	AVG
7236.000	33.07	12.71	45.78	74.00	-28.22	peak
7236.000	21.55	12.71	34.26	54.00	-19.74	AVG
9648.000	31.83	17.60	49.43	74.00	-24.57	peak
9648.000	21.03	17.60	38.63	54.00	-15.37	AVG

Remark:

1. Measuring frequencies from 1 GHz to the 10th harmonic of highest fundamental frequency.
2. For above 1GHz, the EUT peak value was under average limit, therefore the Average value compliance with the average limit

Test Mode:	IEEE 802.11b Mid CH	Temp/Hum	27(°C)/ 53%RH
Test Item	Harmonic	Test Date	March 19, 2017
Polarize	Vertical	Test Engineer	Ed Chiang
Detector	Peak and Average		

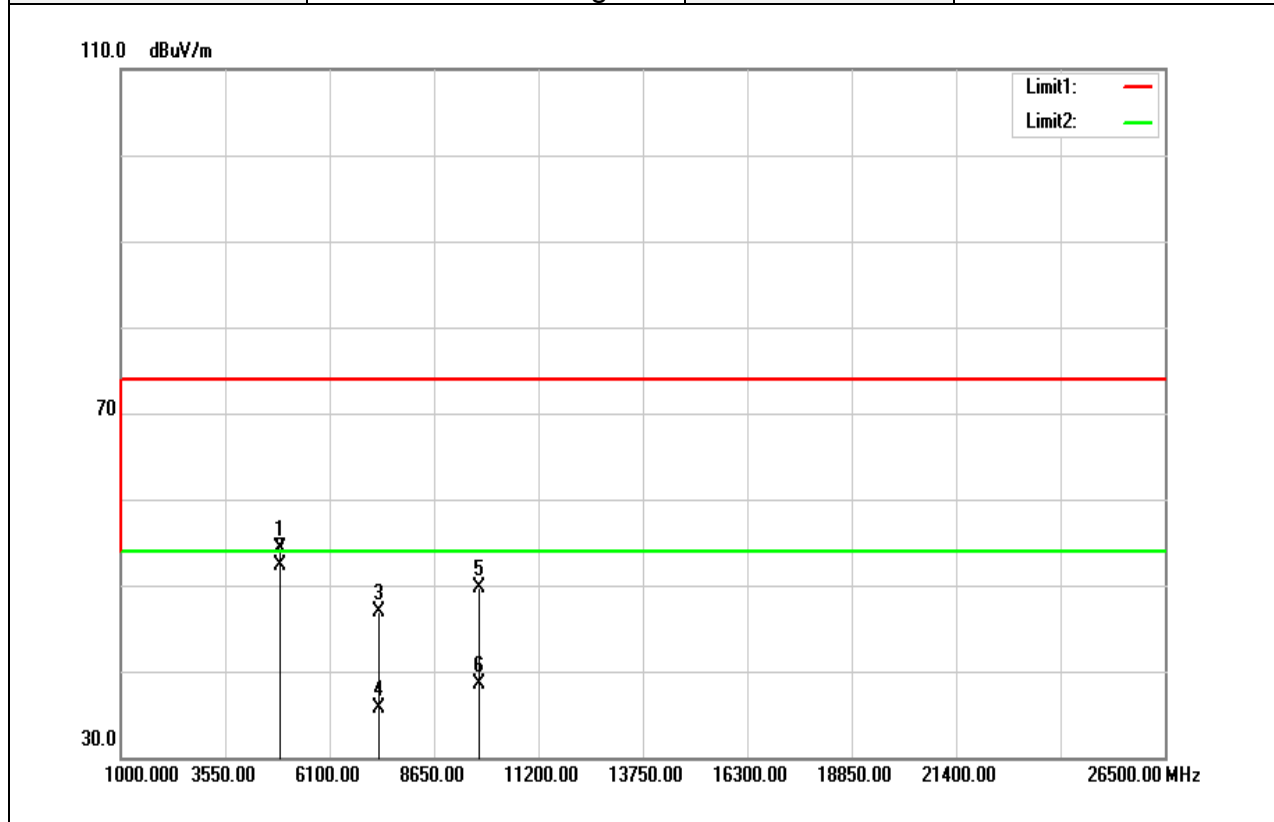

Frequency (MHz)	Reading (dBuV)	Correct Factor (dB/m)	Result (dBuV/m)	Limit (dBuV/m)	Margin (dB)	Remark
4876.000	49.14	5.24	54.38	74.00	-19.62	peak
4876.000	47.04	5.24	52.28	54.00	-1.72	AVG
7311.000	33.93	12.94	46.87	74.00	-27.13	peak
7311.000	22.68	12.94	35.62	54.00	-18.38	AVG
9748.000	32.03	17.60	49.63	74.00	-24.37	peak
9748.000	20.88	17.60	38.48	54.00	-15.52	AVG

Remark:

1. Measuring frequencies from 1 GHz to the 10th harmonic of highest fundamental frequency.
2. For above 1GHz, the EUT peak value was under average limit, therefore the Average value compliance with the average limit

Test Mode:	IEEE 802.11b Mid CH	Temp/Hum	27(°C)/ 53%RH
Test Item	Harmonic	Test Date	March 19, 2017
Polarize	Horizontal	Test Engineer	Ed Chiang
Detector	Peak and Average		

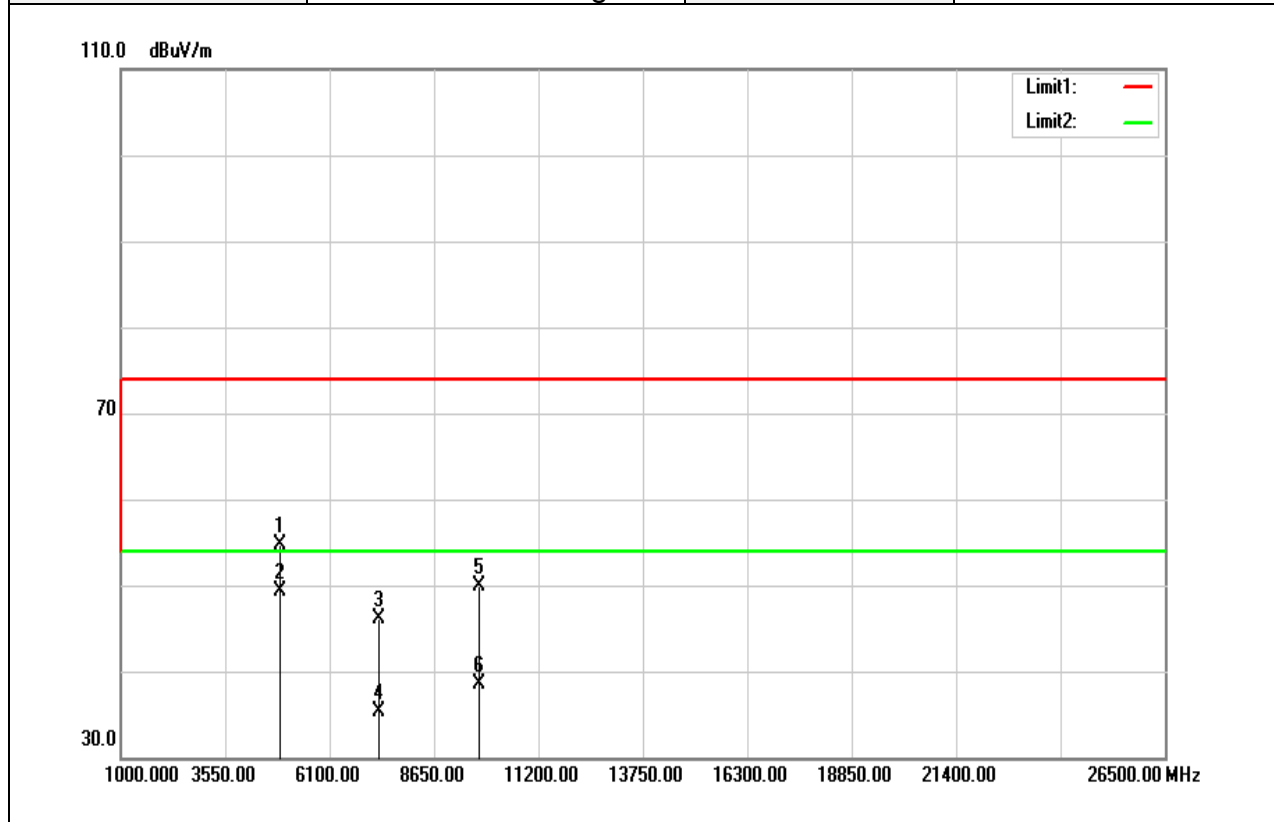

Frequency (MHz)	Reading (dBuV)	Correct Factor (dB/m)	Result (dBuV/m)	Limit (dBuV/m)	Margin (dB)	Remark
4876.000	49.38	5.24	54.62	74.00	-19.38	peak
4876.000	44.10	5.24	49.34	54.00	-4.66	AVG
7311.000	33.18	12.94	46.12	74.00	-27.88	peak
7311.000	22.29	12.94	35.23	54.00	-18.77	AVG
9748.000	32.33	17.60	49.93	74.00	-24.07	peak
9748.000	20.86	17.60	38.46	54.00	-15.54	AVG

Remark:

1. Measuring frequencies from 1 GHz to the 10th harmonic of highest fundamental frequency.
2. For above 1GHz, the EUT peak value was under average limit, therefore the Average value compliance with the average limit

Test Mode:	IEEE 802.11b High CH	Temp/Hum	27(°C)/ 53%RH
Test Item	Harmonic	Test Date	March 19, 2017
Polarize	Vertical	Test Engineer	Ed Chiang
Detector	Peak and Average		

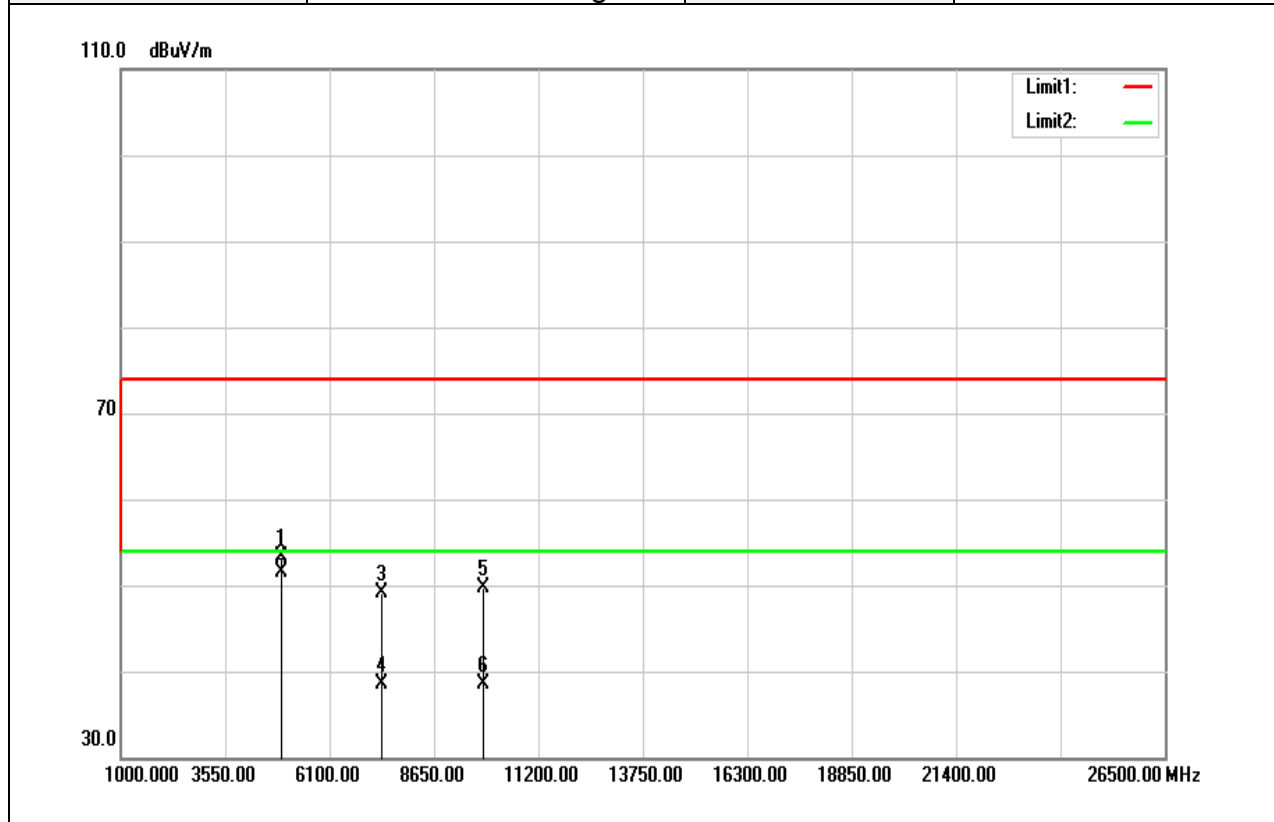

Frequency (MHz)	Reading (dBuV)	Correct Factor (dB/m)	Result (dBuV/m)	Limit (dBuV/m)	Margin (dB)	Remark
4925.000	47.89	5.37	53.26	74.00	-20.74	peak
4925.000	46.19	5.37	51.56	54.00	-2.44	AVG
7386.000	36.00	13.17	49.17	74.00	-24.83	peak
7386.000	25.39	13.17	38.56	54.00	-15.44	AVG
9848.000	32.01	17.60	49.61	74.00	-24.39	peak
9848.000	20.81	17.60	38.41	54.00	-15.59	AVG

Remark:

1. Measuring frequencies from 1 GHz to the 10th harmonic of highest fundamental frequency.
2. For above 1GHz, the EUT peak value was under average limit, therefore the Average value compliance with the average limit

Test Mode:	IEEE 802.11b High CH	Temp/Hum	27(°C)/ 53%RH
Test Item	Harmonic	Test Date	March 19, 2017
Polarize	Horizontal	Test Engineer	Ed Chiang
Detector	Peak and Average		

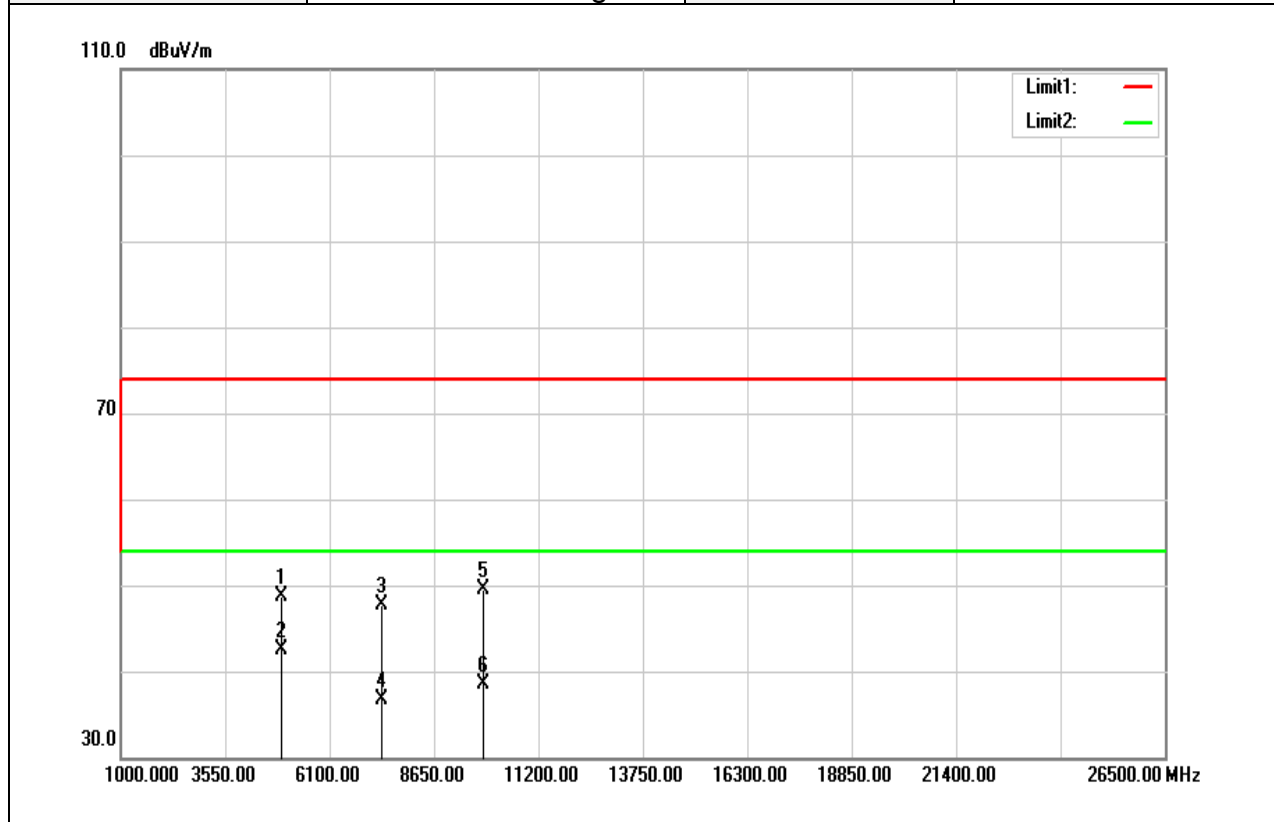

Frequency (MHz)	Reading (dBuV)	Correct Factor (dB/m)	Result (dBuV/m)	Limit (dBuV/m)	Margin (dB)	Remark
4925.000	43.43	5.37	48.80	74.00	-25.20	peak
4925.000	37.19	5.37	42.56	54.00	-11.44	AVG
7386.000	34.52	13.17	47.69	74.00	-26.31	peak
7386.000	23.47	13.17	36.64	54.00	-17.36	AVG
9848.000	31.94	17.60	49.54	74.00	-24.46	peak
9848.000	20.81	17.60	38.41	54.00	-15.59	AVG

Remark:

1. Measuring frequencies from 1 GHz to the 10th harmonic of highest fundamental frequency.
2. For above 1GHz, the EUT peak value was under average limit, therefore the Average value compliance with the average limit

Test Mode:	IEEE 802.11g Low CH	Temp/Hum	27(°C)/ 53%RH
Test Item	Harmonic	Test Date	March 19, 2017
Polarize	Vertical	Test Engineer	Ed Chiang
Detector	Peak and Average		

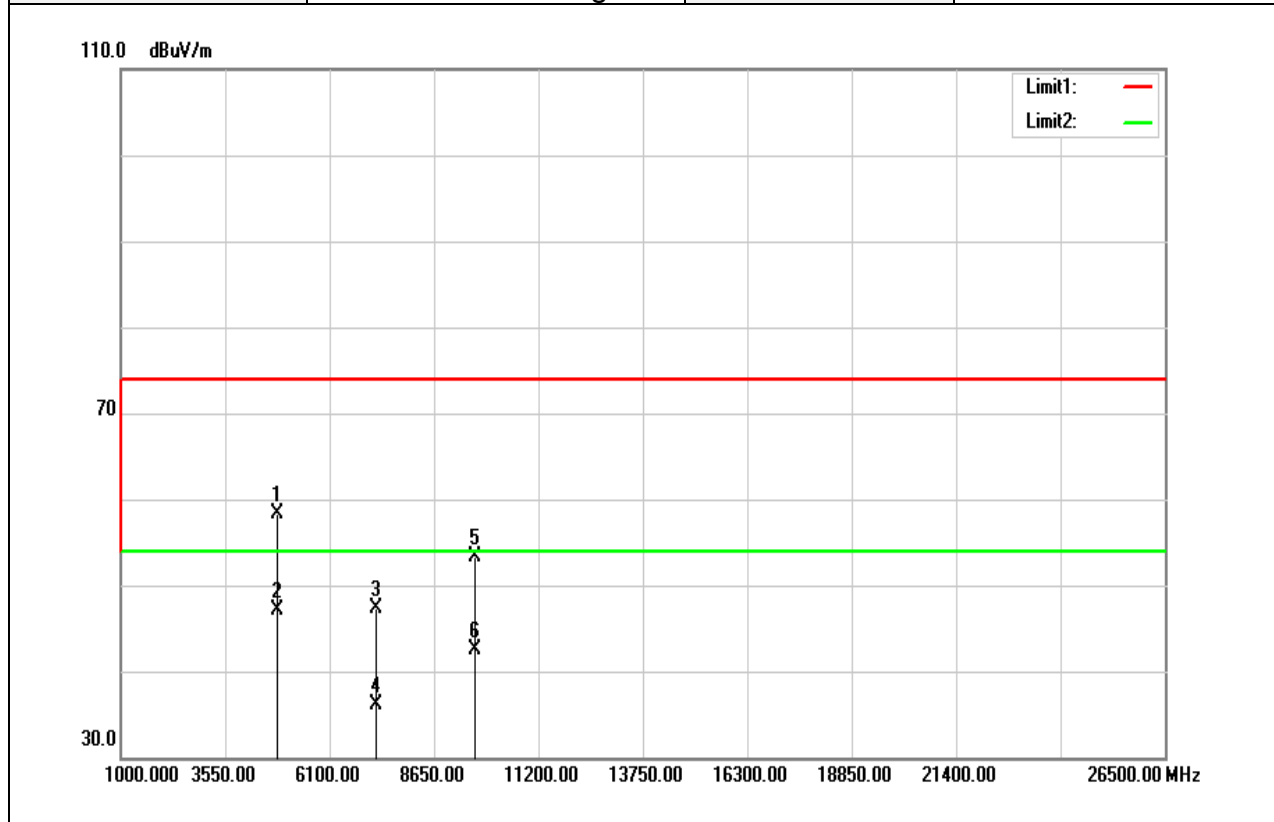

Frequency (MHz)	Reading (dBuV)	Correct Factor (dB/m)	Result (dBuV/m)	Limit (dBuV/m)	Margin (dB)	Remark
4820.000	53.13	5.09	58.22	74.00	-15.78	peak
4820.000	41.93	5.09	47.02	54.00	-6.98	AVG
7236.000	34.52	12.71	47.23	74.00	-26.77	peak
7236.000	23.40	12.71	36.11	54.00	-17.89	AVG
9648.000	35.80	17.60	53.40	74.00	-20.60	peak
9648.000	24.98	17.60	42.58	54.00	-11.42	AVG

Remark:

1. Measuring frequencies from 1 GHz to the 10th harmonic of highest fundamental frequency.
2. For above 1GHz, the EUT peak value was under average limit, therefore the Average value compliance with the average limit

Test Mode:	IEEE 802.11g Low CH	Temp/Hum	27(°C)/ 53%RH
Test Item	Harmonic	Test Date	March 19, 2017
Polarize	Horizontal	Test Engineer	Ed Chiang
Detector	Peak and Average		

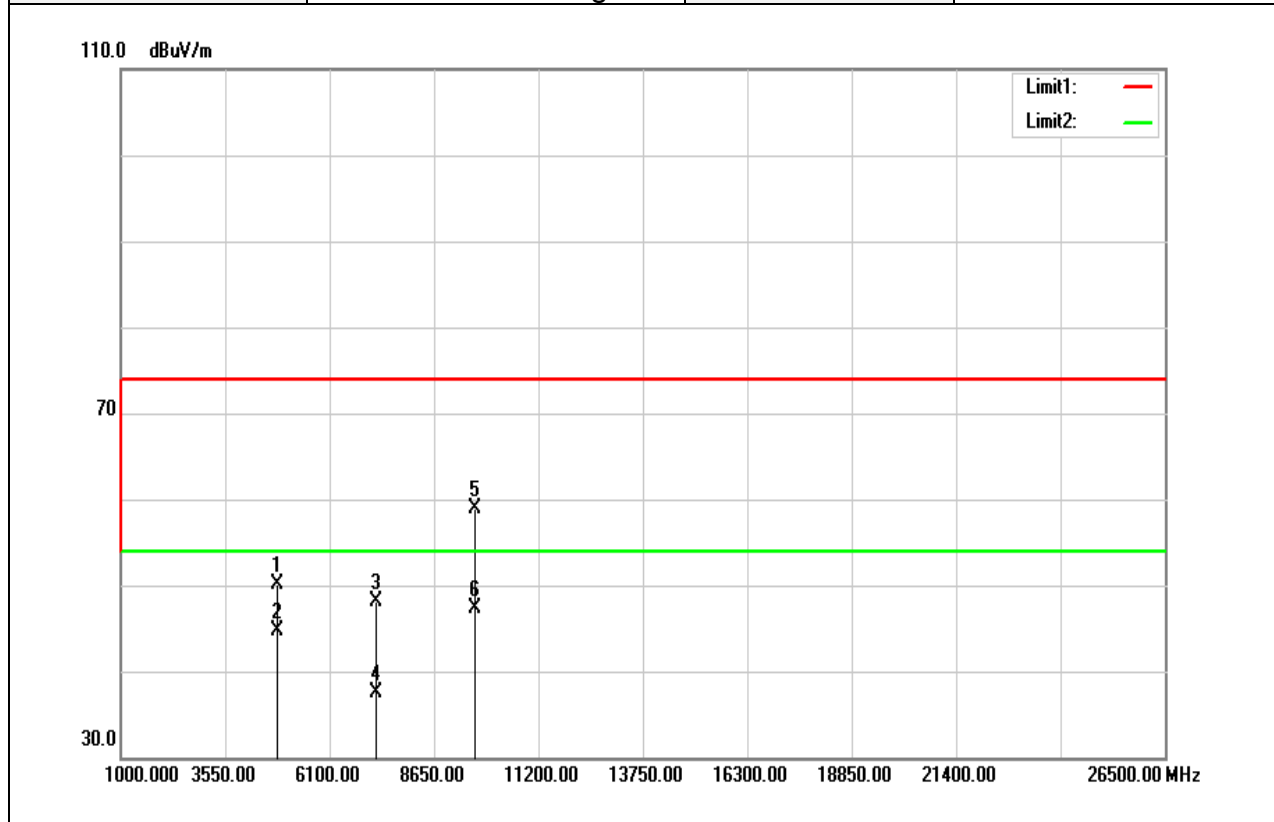

Frequency (MHz)	Reading (dBuV)	Correct Factor (dB/m)	Result (dBuV/m)	Limit (dBuV/m)	Margin (dB)	Remark
4820.000	44.97	5.09	50.06	74.00	-23.94	peak
4820.000	39.54	5.09	44.63	54.00	-9.37	AVG
7236.000	35.32	12.71	48.03	74.00	-25.97	peak
7236.000	24.83	12.71	37.54	54.00	-16.46	AVG
9648.000	41.36	17.60	58.96	74.00	-15.04	peak
9648.000	29.65	17.60	47.25	54.00	-6.75	AVG

Remark:

1. Measuring frequencies from 1 GHz to the 10th harmonic of highest fundamental frequency.
2. For above 1GHz, the EUT peak value was under average limit, therefore the Average value compliance with the average limit

Test Mode:	IEEE 802.11g Mid CH	Temp/Hum	27(°C)/ 53%RH
Test Item	Harmonic	Test Date	March 19, 2017
Polarize	Vertical	Test Engineer	Ed Chiang
Detector	Peak and Average		

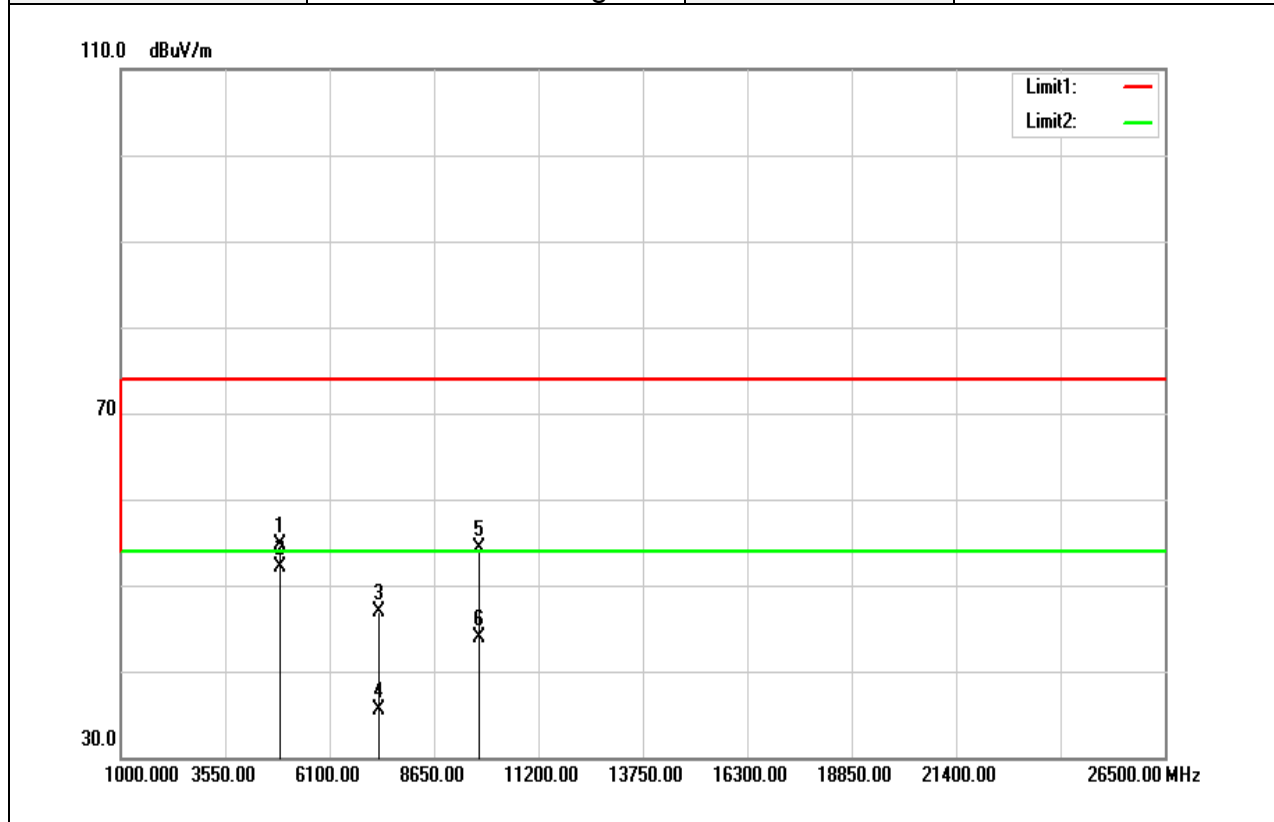

Frequency (MHz)	Reading (dBuV)	Correct Factor (dB/m)	Result (dBuV/m)	Limit (dBuV/m)	Margin (dB)	Remark
4876.000	49.40	5.24	54.64	74.00	-19.36	peak
4876.000	46.94	5.24	52.18	54.00	-1.82	AVG
7311.000	33.95	12.94	46.89	74.00	-27.11	peak
7311.000	22.51	12.94	35.45	54.00	-18.55	AVG
9748.000	36.64	17.60	54.24	74.00	-19.76	peak
9748.000	26.35	17.60	43.95	54.00	-10.05	AVG

Remark:

1. Measuring frequencies from 1 GHz to the 10th harmonic of highest fundamental frequency.
2. For above 1GHz, the EUT peak value was under average limit, therefore the Average value compliance with the average limit

Test Mode:	IEEE 802.11g Mid CH	Temp/Hum	27(°C)/ 53%RH
Test Item	Harmonic	Test Date	March 19, 2017
Polarize	Horizontal	Test Engineer	Ed Chiang
Detector	Peak and Average		

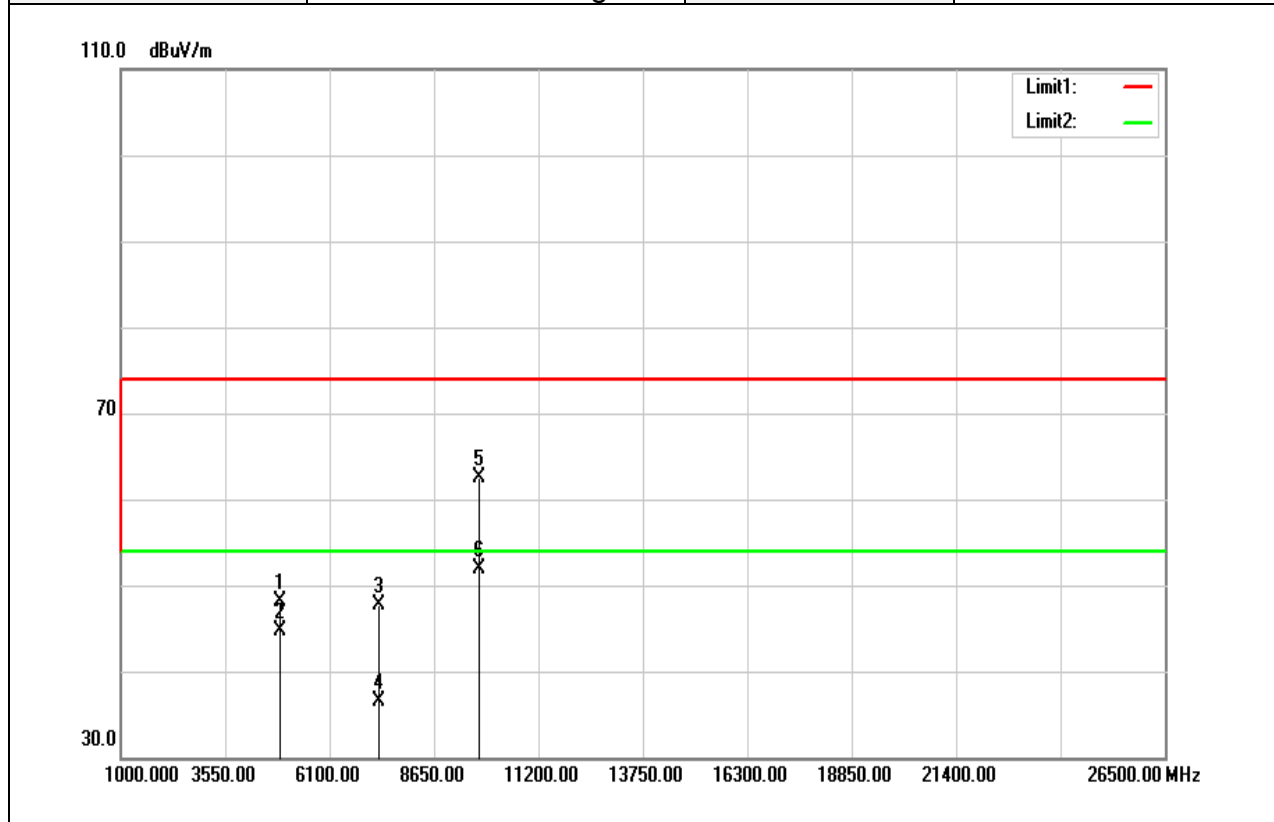

Frequency (MHz)	Reading (dBuV)	Correct Factor (dB/m)	Result (dBuV/m)	Limit (dBuV/m)	Margin (dB)	Remark
4876.000	42.87	5.24	48.11	74.00	-25.89	peak
4876.000	39.38	5.24	44.62	54.00	-9.38	AVG
7311.000	34.73	12.94	47.67	74.00	-26.33	peak
7311.000	23.53	12.94	36.47	54.00	-17.53	AVG
9748.000	44.85	17.60	62.45	74.00	-11.55	peak
9748.000	34.24	17.60	51.84	54.00	-2.16	AVG

Remark:

1. Measuring frequencies from 1 GHz to the 10th harmonic of highest fundamental frequency.
2. For above 1GHz, the EUT peak value was under average limit, therefore the Average value compliance with the average limit

Test Mode:	IEEE 802.11g High CH	Temp/Hum	27(°C)/ 53%RH
Test Item	Harmonic	Test Date	March 19, 2017
Polarize	Vertical	Test Engineer	Ed Chiang
Detector	Peak and Average		

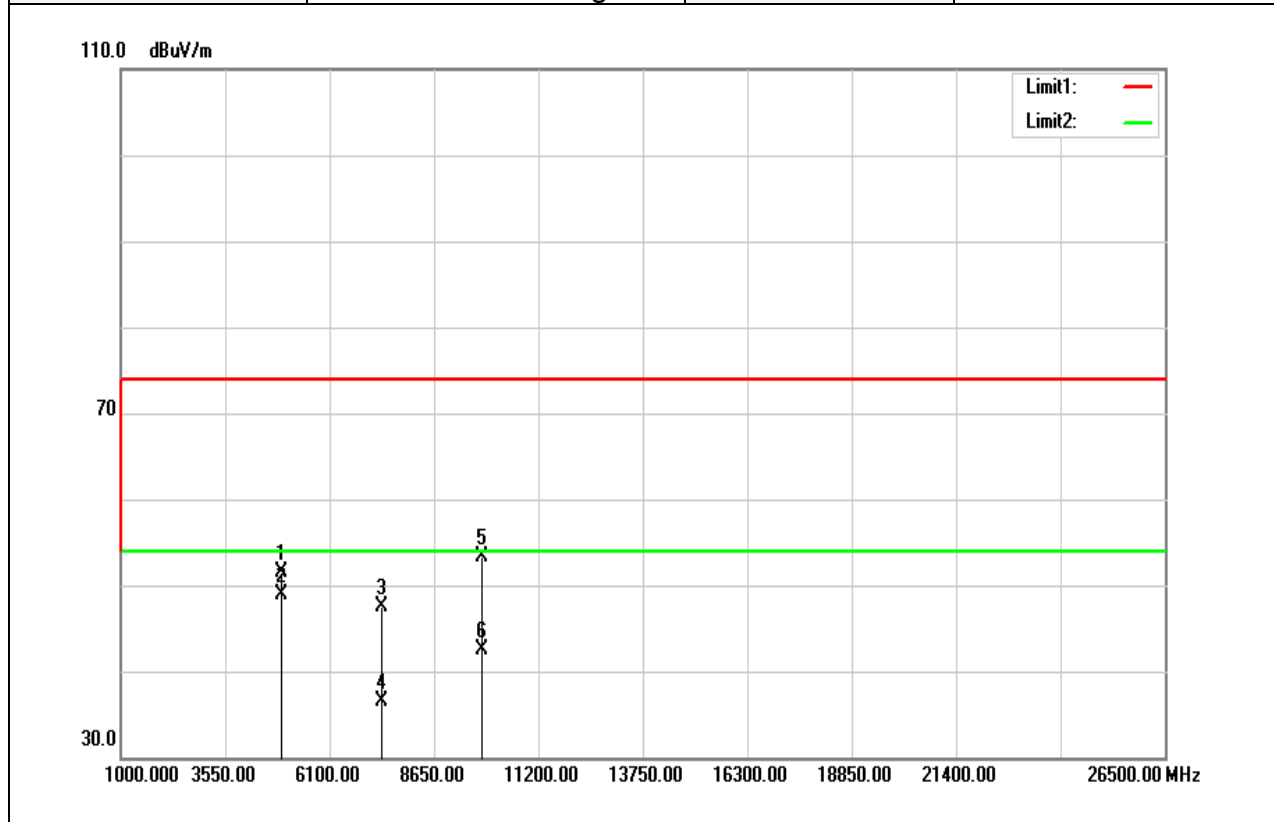

Frequency (MHz)	Reading (dBuV)	Correct Factor (dB/m)	Result (dBuV/m)	Limit (dBuV/m)	Margin (dB)	Remark
4918.000	46.17	5.35	51.52	74.00	-22.48	peak
4918.000	43.52	5.35	48.87	54.00	-5.13	AVG
7386.000	34.43	13.17	47.60	74.00	-26.40	peak
7386.000	23.30	13.17	36.47	54.00	-17.53	AVG
9839.000	35.69	17.60	53.29	74.00	-20.71	peak
9839.000	24.84	17.60	42.44	54.00	-11.56	AVG

Remark:

1. Measuring frequencies from 1 GHz to the 10th harmonic of highest fundamental frequency.
2. For above 1GHz, the EUT peak value was under average limit, therefore the Average value compliance with the average limit

Test Mode:	IEEE 802.11g High CH	Temp/Hum	27(°C)/ 53%RH
Test Item	Harmonic	Test Date	March 19, 2017
Polarize	Horizontal	Test Engineer	Ed Chiang
Detector	Peak and Average		

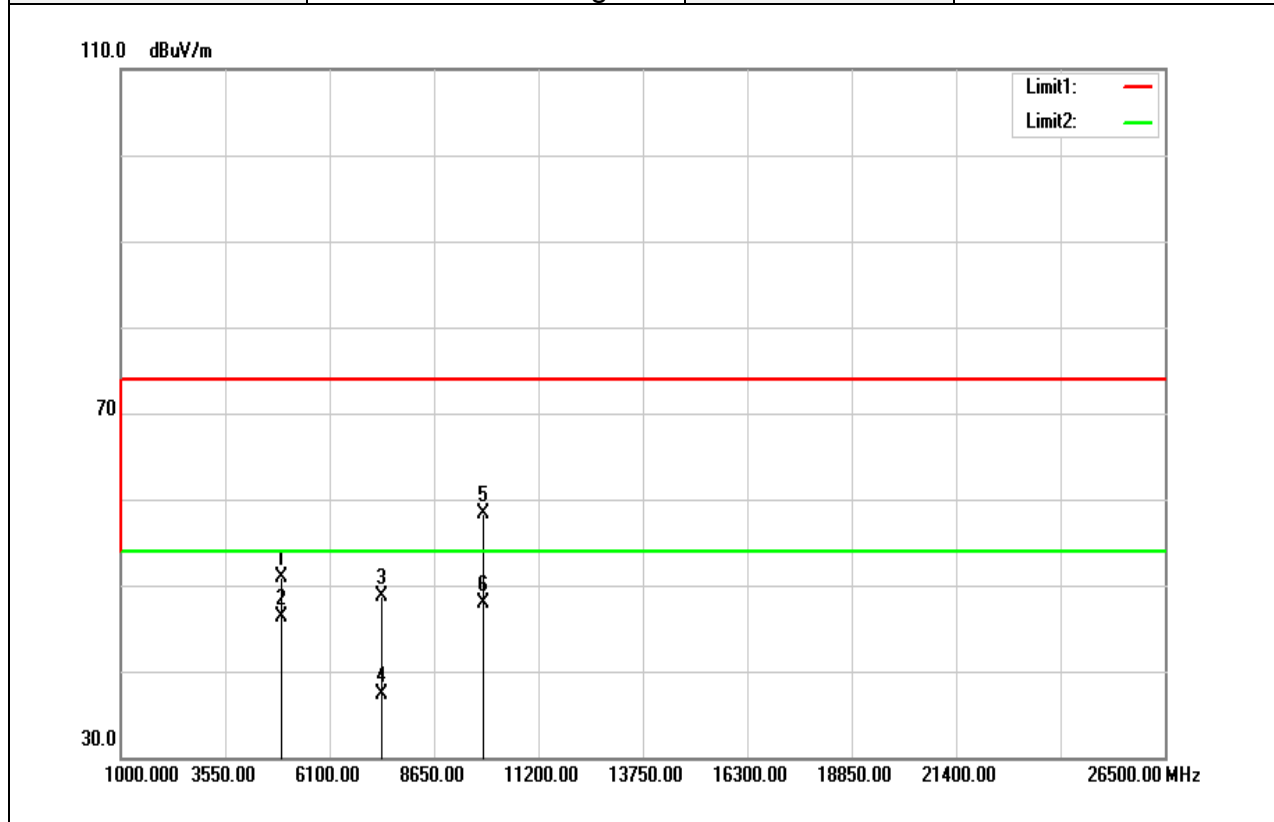

Frequency (MHz)	Reading (dBuV)	Correct Factor (dB/m)	Result (dBuV/m)	Limit (dBuV/m)	Margin (dB)	Remark
4925.000	45.48	5.37	50.85	74.00	-23.15	peak
4925.000	40.90	5.37	46.27	54.00	-7.73	AVG
7386.000	35.45	13.17	48.62	74.00	-25.38	peak
7386.000	24.07	13.17	37.24	54.00	-16.76	AVG
9853.000	40.65	17.60	58.25	74.00	-15.75	peak
9853.000	30.28	17.60	47.88	54.00	-6.12	AVG

Remark:

1. Measuring frequencies from 1 GHz to the 10th harmonic of highest fundamental frequency.
2. For above 1GHz, the EUT peak value was under average limit, therefore the Average value compliance with the average limit

Test Mode:	IEEE 802.11n HT20 Low CH	Temp/Hum	27(°C)/ 53%RH
Test Item	Harmonic	Test Date	March 19, 2017
Polarize	Vertical	Test Engineer	Ed Chiang
Detector	Peak and Average		

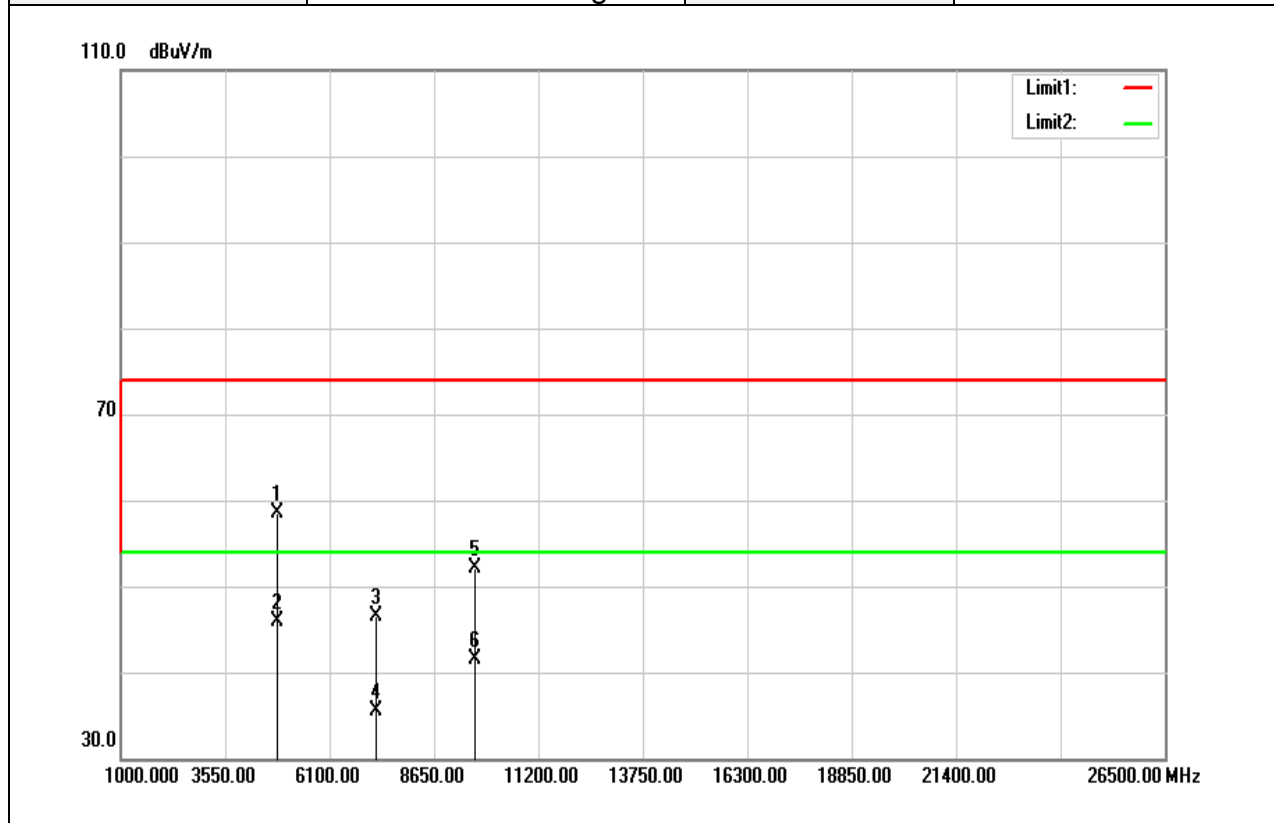

Frequency (MHz)	Reading (dBuV)	Correct Factor (dB/m)	Result (dBuV/m)	Limit (dBuV/m)	Margin (dB)	Remark
4827.000	53.35	5.11	58.46	74.00	-15.54	peak
4827.000	40.82	5.11	45.93	54.00	-8.07	AVG
7236.000	33.80	12.71	46.51	74.00	-27.49	peak
7236.000	22.78	12.71	35.49	54.00	-18.51	AVG
9648.000	34.55	17.60	52.15	74.00	-21.85	peak
9648.000	23.95	17.60	41.55	54.00	-12.45	AVG

Remark:

1. Measuring frequencies from 1 GHz to the 10th harmonic of highest fundamental frequency.
2. For above 1GHz, the EUT peak value was under average limit, therefore the Average value compliance with the average limit

Test Mode:	IEEE 802.11n HT20 Low CH	Temp/Hum	27(°C)/ 53%RH
Test Item	Harmonic	Test Date	March 19, 2017
Polarize	Horizontal	Test Engineer	Ed Chiang
Detector	Peak and Average		

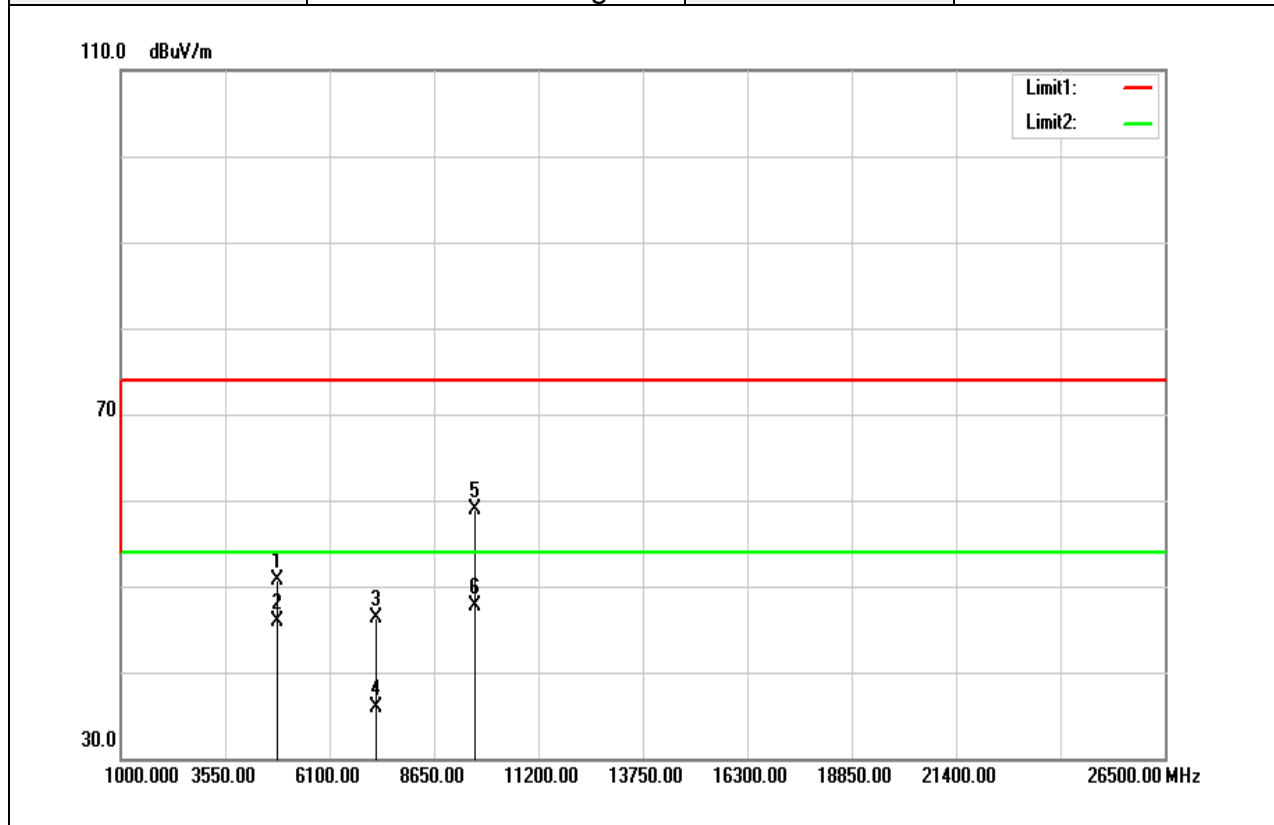

Frequency (MHz)	Reading (dBuV)	Correct Factor (dB/m)	Result (dBuV/m)	Limit (dBuV/m)	Margin (dB)	Remark
4820.000	45.68	5.09	50.77	74.00	-23.23	peak
4820.000	40.73	5.09	45.82	54.00	-8.18	AVG
7236.000	33.64	12.71	46.35	74.00	-27.65	peak
7236.000	23.13	12.71	35.84	54.00	-18.16	AVG
9648.000	41.26	17.60	58.86	74.00	-15.14	peak
9648.000	30.02	17.60	47.62	54.00	-6.38	AVG

Remark:

1. Measuring frequencies from 1 GHz to the 10th harmonic of highest fundamental frequency.
2. For above 1GHz, the EUT peak value was under average limit, therefore the Average value compliance with the average limit

Test Mode:	IEEE 802.11n HT20 Mid CH	Temp/Hum	27(°C)/ 53%RH
Test Item	Harmonic	Test Date	March 19, 2017
Polarize	Vertical	Test Engineer	Ed Chiang
Detector	Peak and Average		

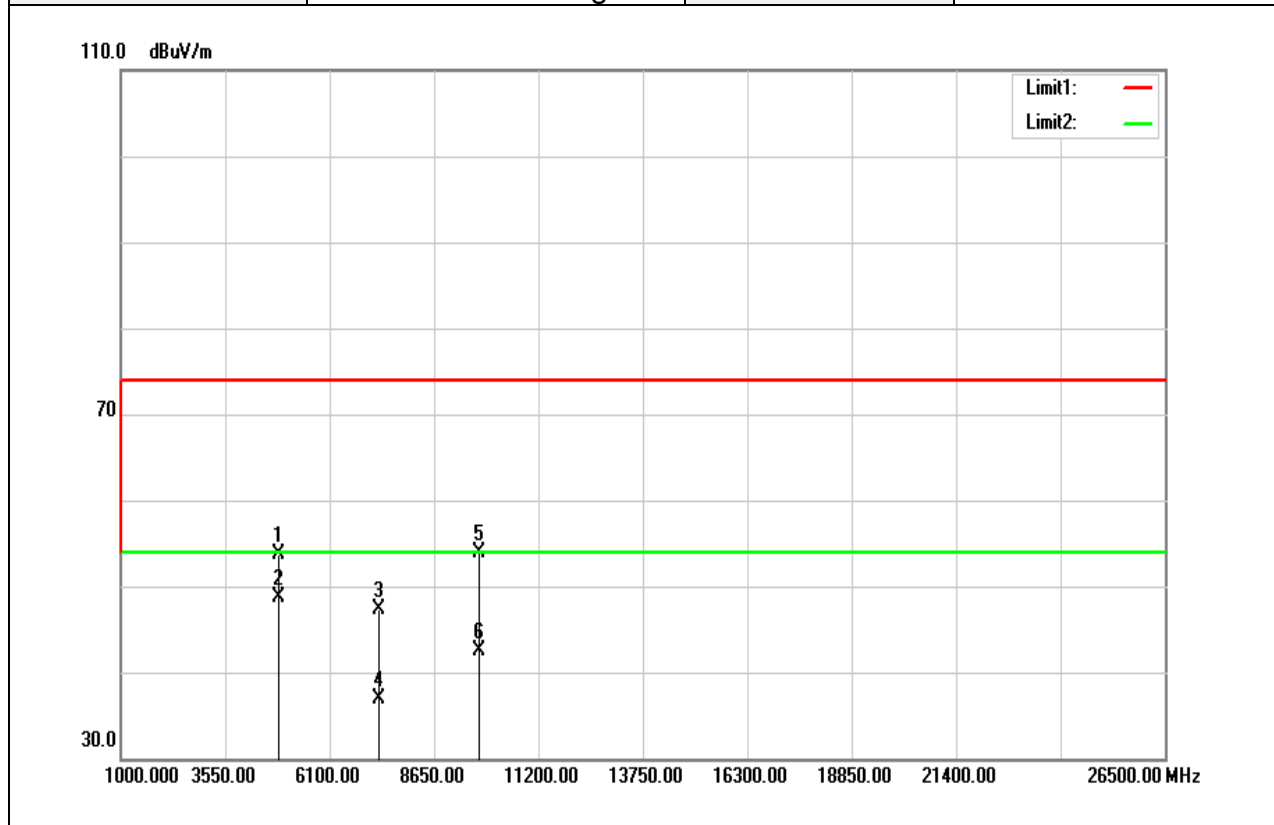

Frequency (MHz)	Reading (dBuV)	Correct Factor (dB/m)	Result (dBuV/m)	Limit (dBuV/m)	Margin (dB)	Remark
4869.000	48.57	5.22	53.79	74.00	-20.21	peak
4869.000	43.41	5.22	48.63	54.00	-5.37	AVG
7311.000	34.32	12.94	47.26	74.00	-26.74	peak
7311.000	23.90	12.94	36.84	54.00	-17.16	AVG
9748.000	36.24	17.60	53.84	74.00	-20.16	peak
9748.000	24.95	17.60	42.55	54.00	-11.45	AVG

Remark:

1. Measuring frequencies from 1 GHz to the 10th harmonic of highest fundamental frequency.
2. For above 1GHz, the EUT peak value was under average limit, therefore the Average value compliance with the average limit

Test Mode:	IEEE 802.11n HT20 Mid CH	Temp/Hum	27(°C)/ 53%RH
Test Item	Harmonic	Test Date	March 19, 2017
Polarize	Horizontal	Test Engineer	Ed Chiang
Detector	Peak and Average		

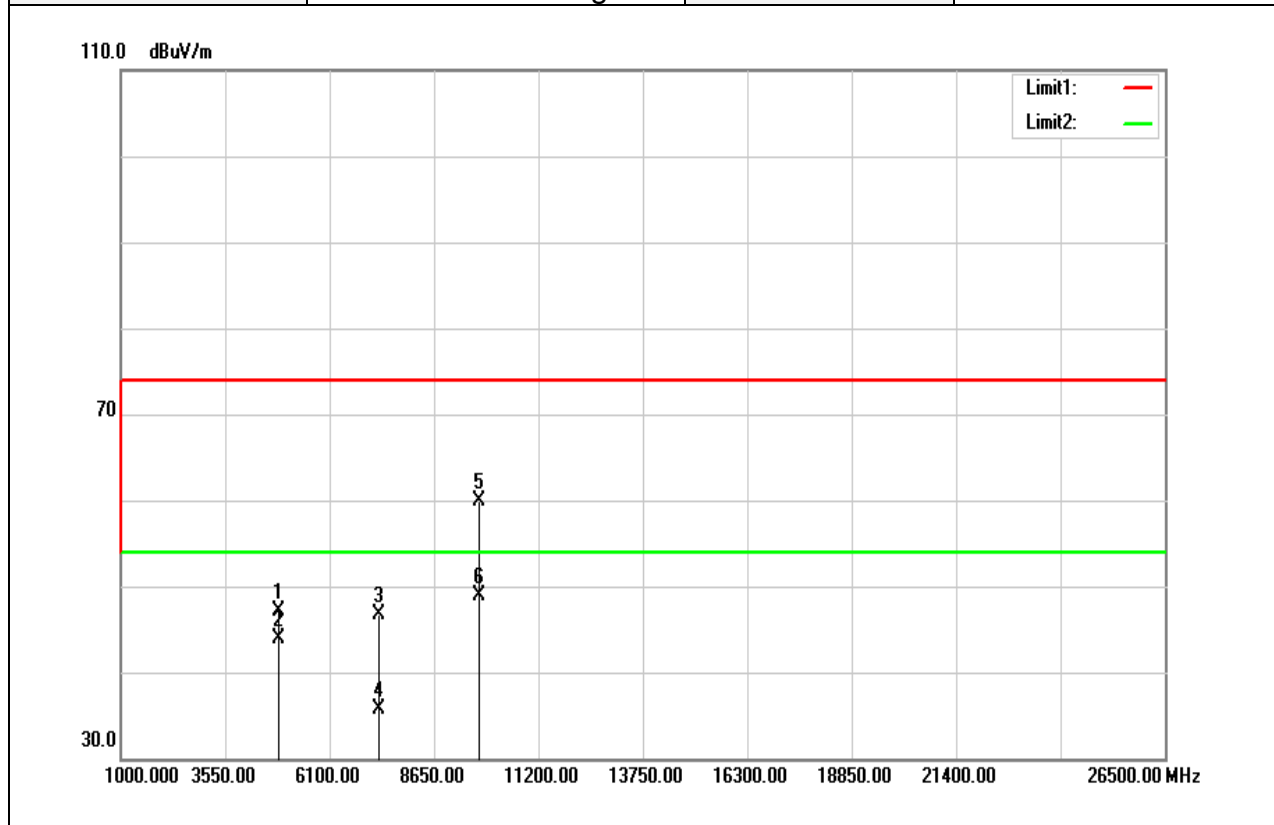

Frequency (MHz)	Reading (dBuV)	Correct Factor (dB/m)	Result (dBuV/m)	Limit (dBuV/m)	Margin (dB)	Remark
4869.000	41.97	5.22	47.19	74.00	-26.81	peak
4869.000	38.63	5.22	43.85	54.00	-10.15	AVG
7311.000	33.85	12.94	46.79	74.00	-27.21	peak
7311.000	22.74	12.94	35.68	54.00	-18.32	AVG
9741.000	42.25	17.60	59.85	74.00	-14.15	peak
9741.000	31.31	17.60	48.91	54.00	-5.09	AVG

Remark:

1. Measuring frequencies from 1 GHz to the 10th harmonic of highest fundamental frequency.
2. For above 1GHz, the EUT peak value was under average limit, therefore the Average value compliance with the average limit

Test Mode:	IEEE 802.11n HT20 High CH	Temp/Hum	27(°C)/ 53%RH
Test Item	Harmonic	Test Date	March 19, 2017
Polarize	Vertical	Test Engineer	Ed Chiang
Detector	Peak and Average		

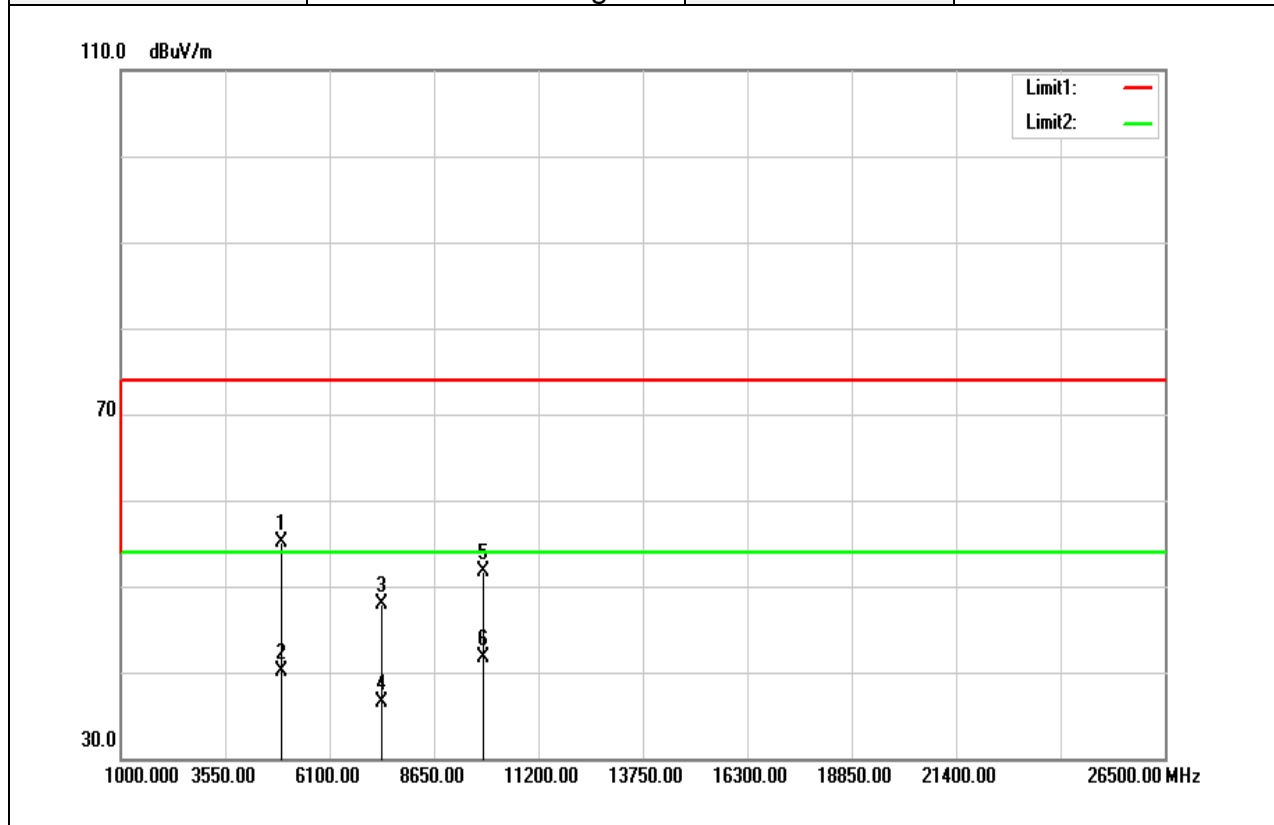

Frequency (MHz)	Reading (dBuV)	Correct Factor (dB/m)	Result (dBuV/m)	Limit (dBuV/m)	Margin (dB)	Remark
4925.000	49.69	5.37	55.06	74.00	-18.94	peak
4925.000	34.81	5.37	40.18	54.00	-13.82	AVG
7386.000	34.81	13.17	47.98	74.00	-26.02	peak
7386.000	23.42	13.17	36.59	54.00	-17.41	AVG
9848.000	34.03	17.60	51.63	74.00	-22.37	peak
9848.000	24.17	17.60	41.77	54.00	-12.23	AVG

Remark:

1. Measuring frequencies from 1 GHz to the 10th harmonic of highest fundamental frequency.
2. For above 1GHz, the EUT peak value was under average limit, therefore the Average value compliance with the average limit

Test Mode:	IEEE 802.11n HT20 High CH	Temp/Hum	27(°C)/ 53%RH
Test Item	Harmonic	Test Date	March 19, 2017
Polarize	Horizontal	Test Engineer	Ed Chiang
Detector	Peak and Average		

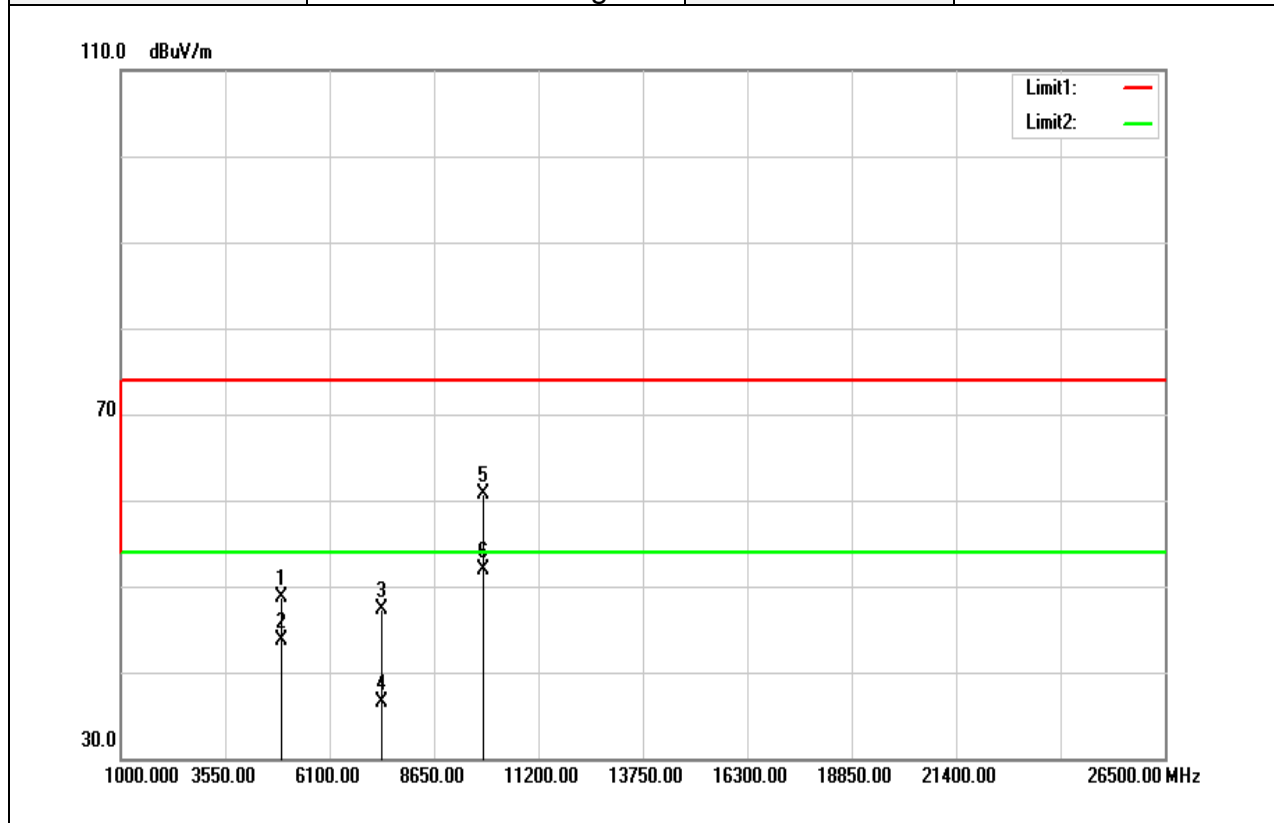

Frequency (MHz)	Reading (dBuV)	Correct Factor (dB/m)	Result (dBuV/m)	Limit (dBuV/m)	Margin (dB)	Remark
4925.000	43.36	5.37	48.73	74.00	-25.27	peak
4925.000	38.31	5.37	43.68	54.00	-10.32	AVG
7386.000	34.12	13.17	47.29	74.00	-26.71	peak
7386.000	23.31	13.17	36.48	54.00	-17.52	AVG
9846.000	43.04	17.60	60.64	74.00	-13.36	peak
9846.000	34.28	17.60	51.88	54.00	-2.12	AVG

Remark:

1. Measuring frequencies from 1 GHz to the 10th harmonic of highest fundamental frequency.
2. For above 1GHz, the EUT peak value was under average limit, therefore the Average value compliance with the average limit

Test Mode:	IEEE 802.11n HT40 Low CH	Temp/Hum	27(°C)/ 53%RH
Test Item	Harmonic	Test Date	March 19, 2017
Polarize	Vertical	Test Engineer	Ed Chiang
Detector	Peak and Average		

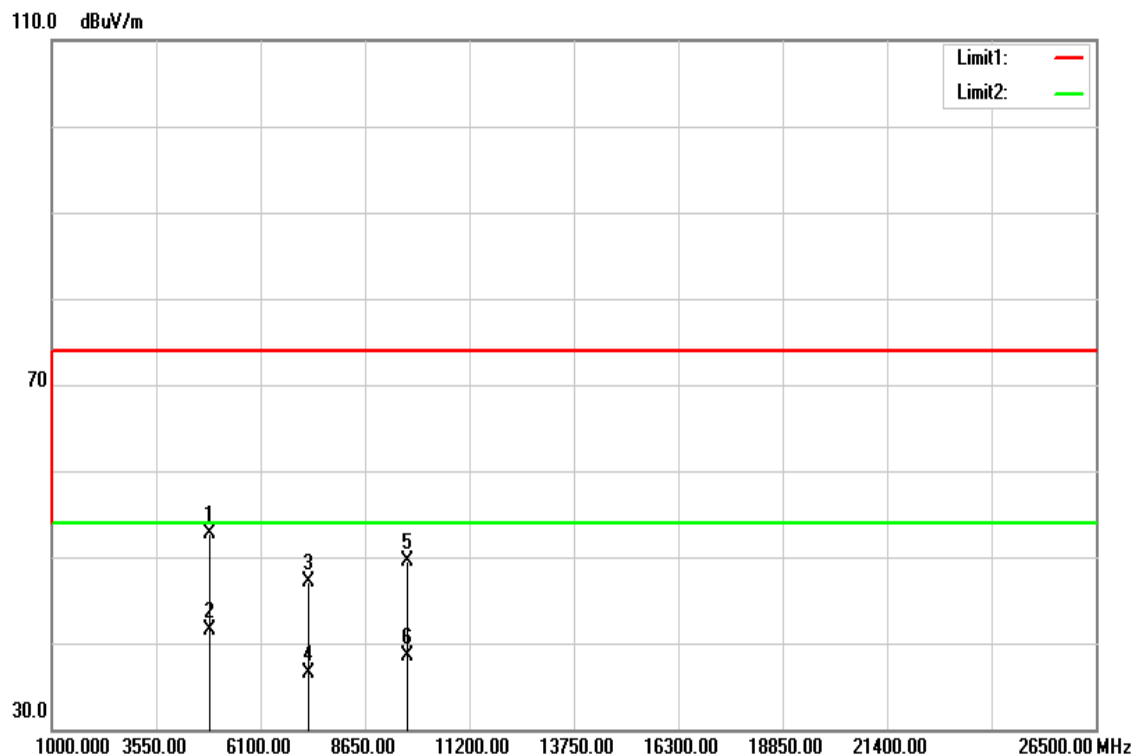

Frequency (MHz)	Reading (dBuV)	Correct Factor (dB/m)	Result (dBuV/m)	Limit (dBuV/m)	Margin (dB)	Remark
4848.000	47.47	5.16	52.63	74.00	-21.37	peak
4848.000	36.36	5.16	41.52	54.00	-12.48	AVG
7266.000	34.21	12.80	47.01	74.00	-26.99	peak
7266.000	23.67	12.80	36.47	54.00	-17.53	AVG
9688.000	31.99	17.60	49.59	74.00	-24.41	peak
9688.000	20.88	17.60	38.48	54.00	-15.52	AVG

Remark:

1. Measuring frequencies from 1 GHz to the 10th harmonic of highest fundamental frequency.
2. For above 1GHz, the EUT peak value was under average limit, therefore the Average value compliance with the average limit

Test Mode:	IEEE 802.11n HT40 Low CH	Temp/Hum	27(°C)/ 53%RH
Test Item	Harmonic	Test Date	March 19, 2017
Polarize	Horizontal	Test Engineer	Ed Chiang
Detector	Peak and Average		

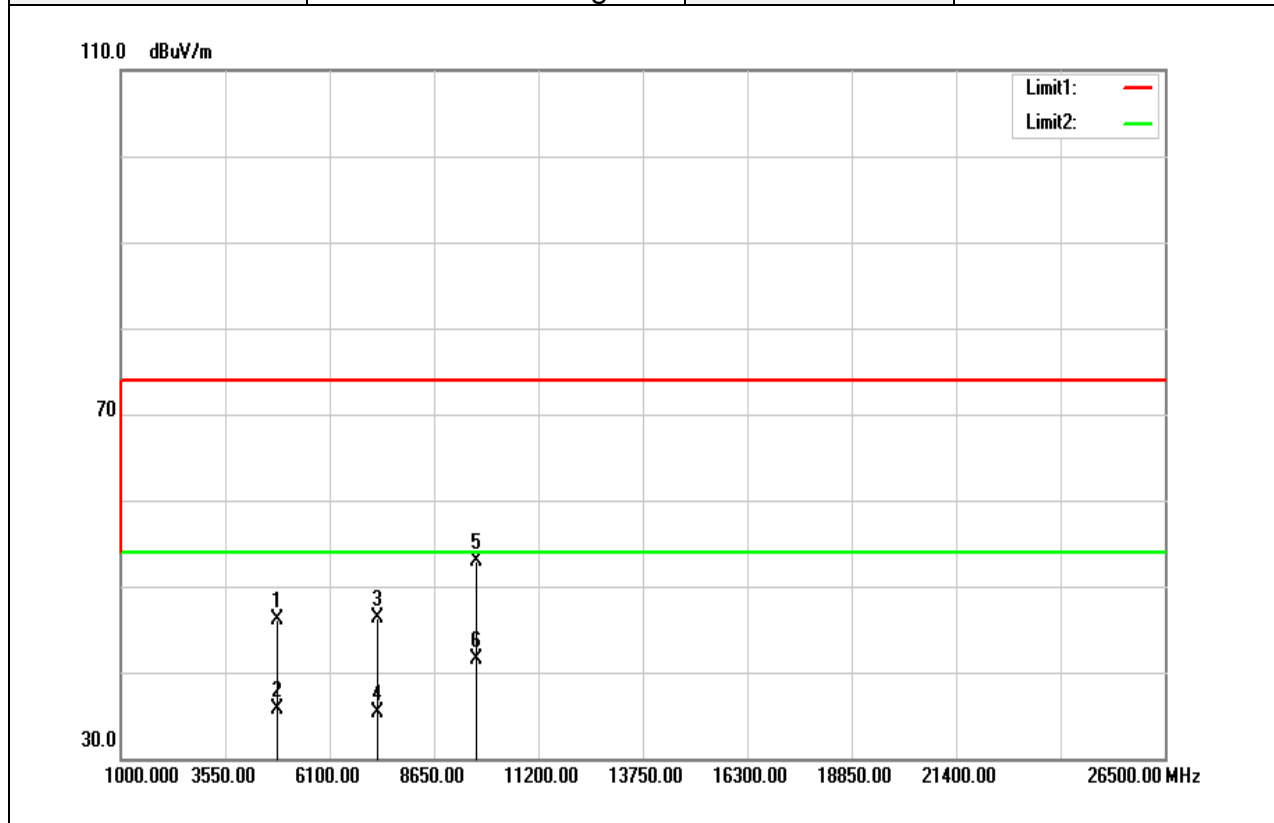

Frequency (MHz)	Reading (dBuV)	Correct Factor (dB/m)	Result (dBuV/m)	Limit (dBuV/m)	Margin (dB)	Remark
4841.000	40.94	5.14	46.08	74.00	-27.92	peak
4841.000	30.59	5.14	35.73	54.00	-18.27	AVG
7266.000	33.60	12.80	46.40	74.00	-27.60	peak
7266.000	22.49	12.80	35.29	54.00	-18.71	AVG
9688.000	35.37	17.60	52.97	74.00	-21.03	peak
9688.000	23.98	17.60	41.58	54.00	-12.42	AVG

Remark:

1. Measuring frequencies from 1 GHz to the 10th harmonic of highest fundamental frequency.
2. For above 1GHz, the EUT peak value was under average limit, therefore the Average value compliance with the average limit

Test Mode:	IEEE 802.11n HT40 Mid CH	Temp/Hum	27(°C)/ 53%RH
Test Item	Harmonic	Test Date	March 19, 2017
Polarize	Vertical	Test Engineer	Ed Chiang
Detector	Peak and Average		

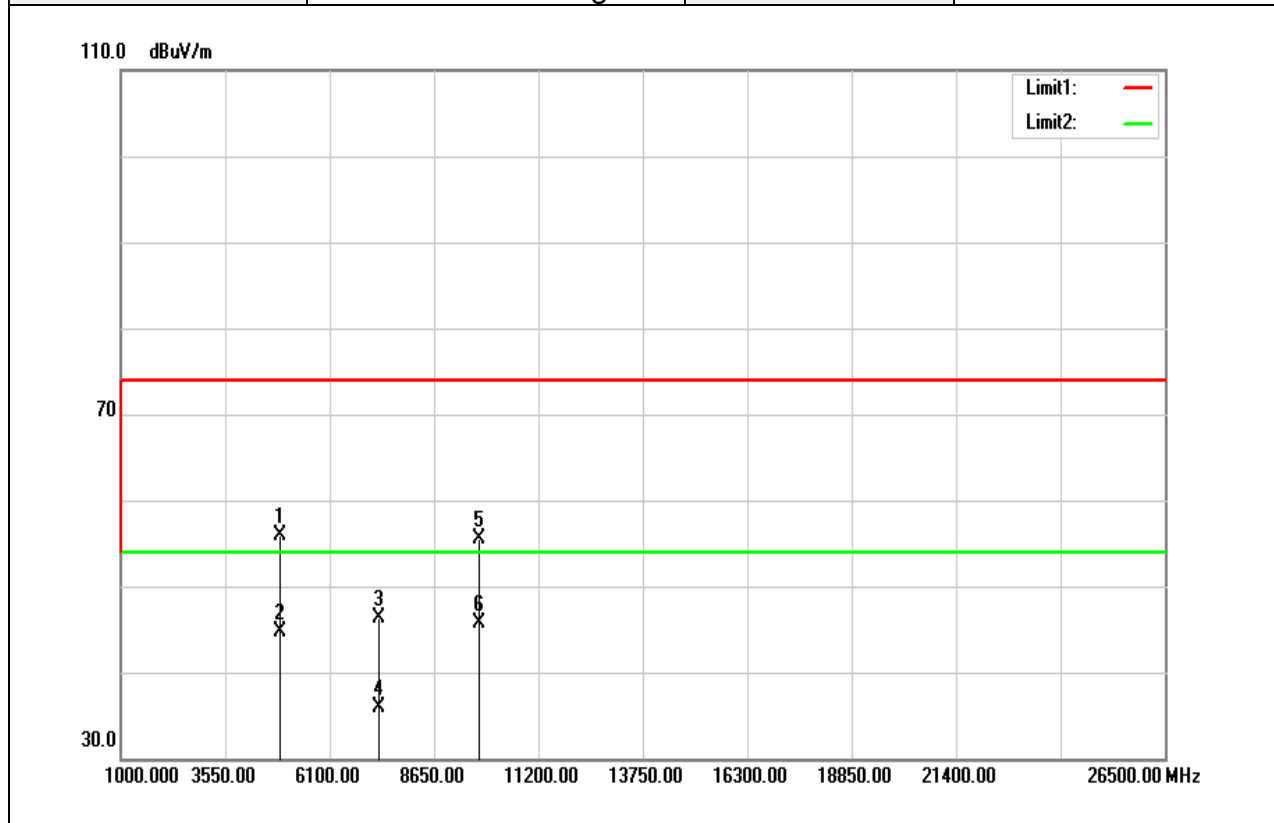

Frequency (MHz)	Reading (dBuV)	Correct Factor (dB/m)	Result (dBuV/m)	Limit (dBuV/m)	Margin (dB)	Remark
4876.000	50.65	5.24	55.89	74.00	-18.11	peak
4876.000	39.44	5.24	44.68	54.00	-9.32	AVG
7311.000	33.46	12.94	46.40	74.00	-27.60	peak
7311.000	22.90	12.94	35.84	54.00	-18.16	AVG
9748.000	37.94	17.60	55.54	74.00	-18.46	peak
9748.000	28.14	17.60	45.74	54.00	-8.26	AVG

Remark:

1. Measuring frequencies from 1 GHz to the 10th harmonic of highest fundamental frequency.
2. For above 1GHz, the EUT peak value was under average limit, therefore the Average value compliance with the average limit

Test Mode:	IEEE 802.11n HT40 Mid CH	Temp/Hum	27(°C)/ 53%RH
Test Item	Harmonic	Test Date	March 19, 2017
Polarize	Horizontal	Test Engineer	Ed Chiang
Detector	Peak and Average		

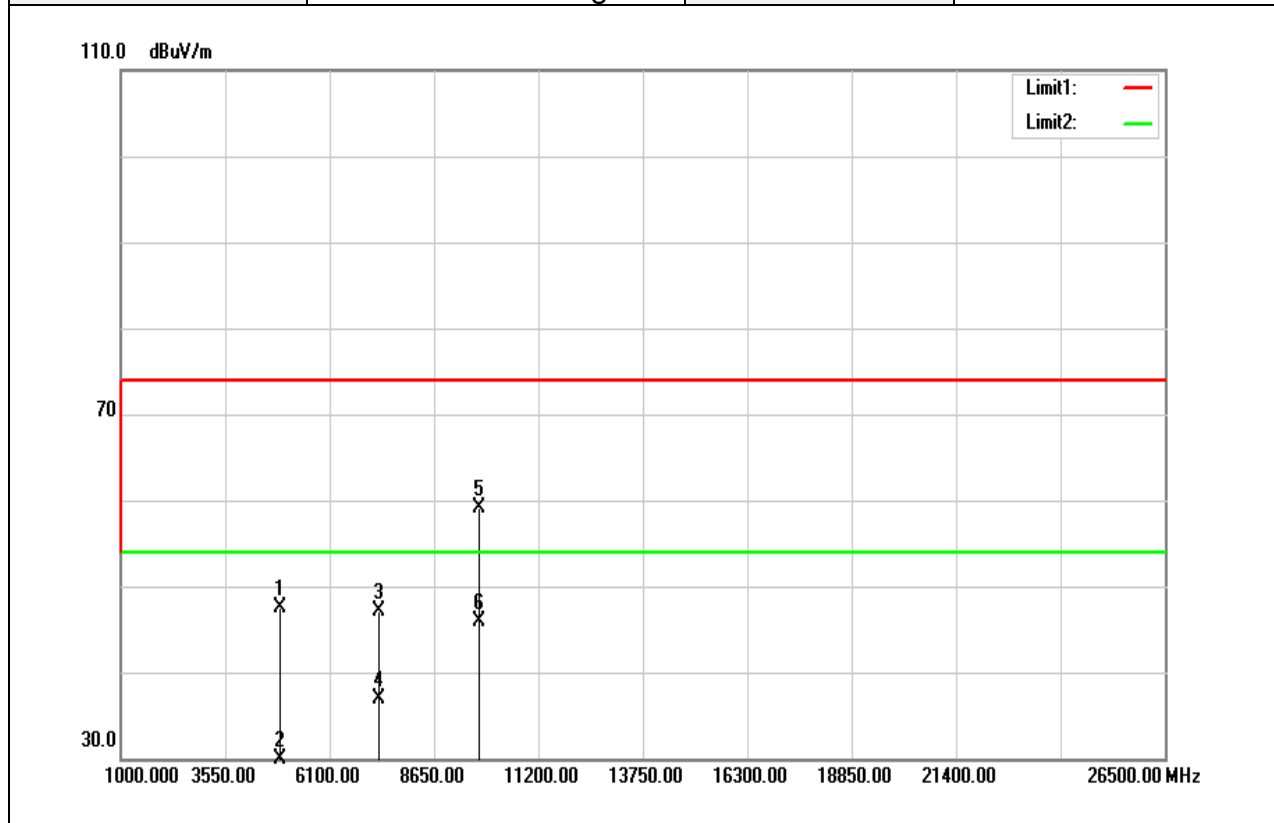

Frequency (MHz)	Reading (dBuV)	Correct Factor (dB/m)	Result (dBuV/m)	Limit (dBuV/m)	Margin (dB)	Remark
4876.000	42.36	5.24	47.60	74.00	-26.40	peak
4876.000	1.24	5.24	6.48	54.00	-47.52	AVG
7311.000	34.08	12.94	47.02	74.00	-26.98	peak
7311.000	23.94	12.94	36.88	54.00	-17.12	AVG
9748.000	41.56	17.60	59.16	74.00	-14.84	peak
9748.000	28.34	17.60	45.94	54.00	-8.06	AVG

Remark:

1. Measuring frequencies from 1 GHz to the 10th harmonic of highest fundamental frequency.
2. For above 1GHz, the EUT peak value was under average limit, therefore the Average value compliance with the average limit

Test Mode:	IEEE 802.11n HT40 High CH	Temp/Hum	27(°C)/ 53%RH
Test Item	Harmonic	Test Date	March 19, 2017
Polarize	Vertical	Test Engineer	Ed Chiang
Detector	Peak and Average		

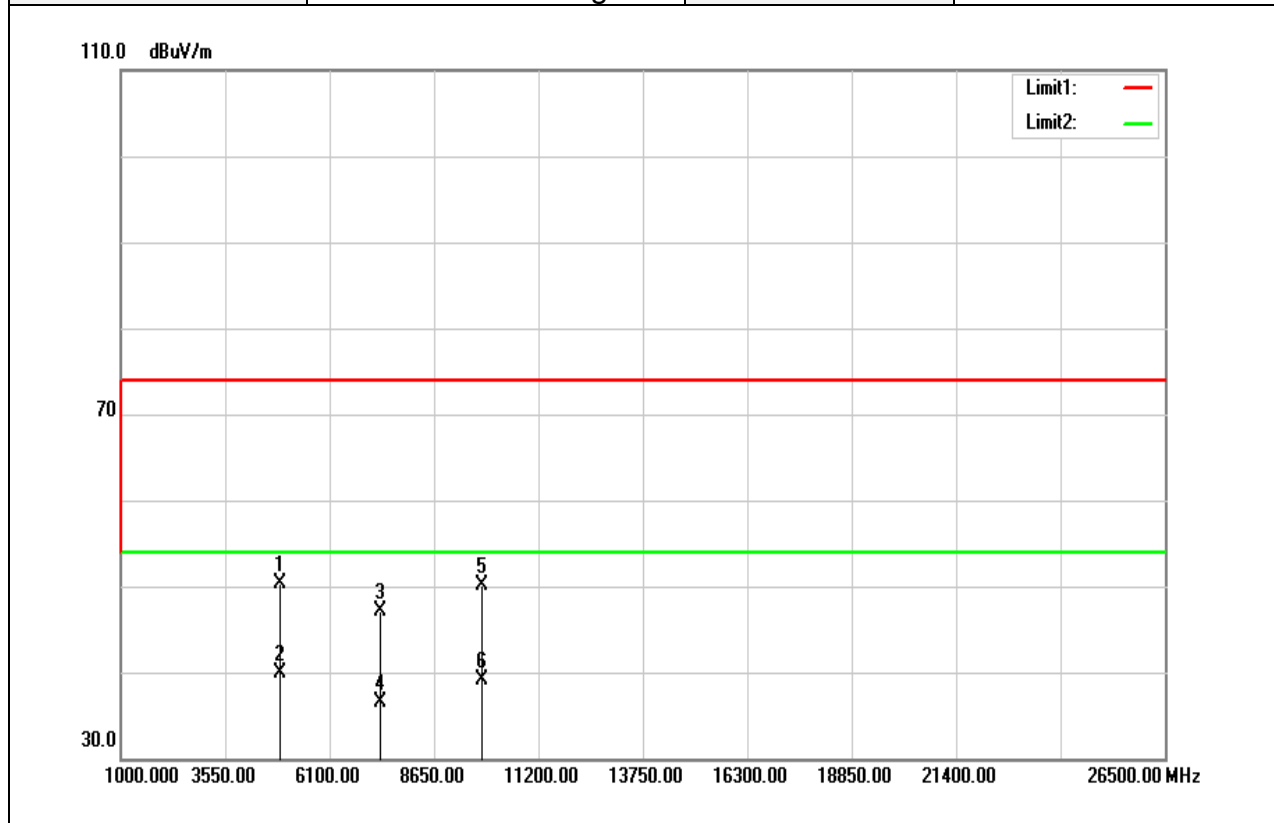

Frequency (MHz)	Reading (dBuV)	Correct Factor (dB/m)	Result (dBuV/m)	Limit (dBuV/m)	Margin (dB)	Remark
4904.000	44.94	5.31	50.25	74.00	-23.75	peak
4904.000	34.53	5.31	39.84	54.00	-14.16	AVG
7356.000	34.03	13.08	47.11	74.00	-26.89	peak
7356.000	23.46	13.08	36.54	54.00	-17.46	AVG
9808.000	32.53	17.60	50.13	74.00	-23.87	peak
9808.000	21.57	17.60	39.17	54.00	-14.83	AVG

Remark:

1. Measuring frequencies from 1 GHz to the 10th harmonic of highest fundamental frequency.
2. For above 1GHz, the EUT peak value was under average limit, therefore the Average value compliance with the average limit

Test Mode:	IEEE 802.11n HT40 High CH	Temp/Hum	27(°C)/ 53%RH
Test Item	Harmonic	Test Date	March 19, 2017
Polarize	Horizontal	Test Engineer	Ed Chiang
Detector	Peak and Average		

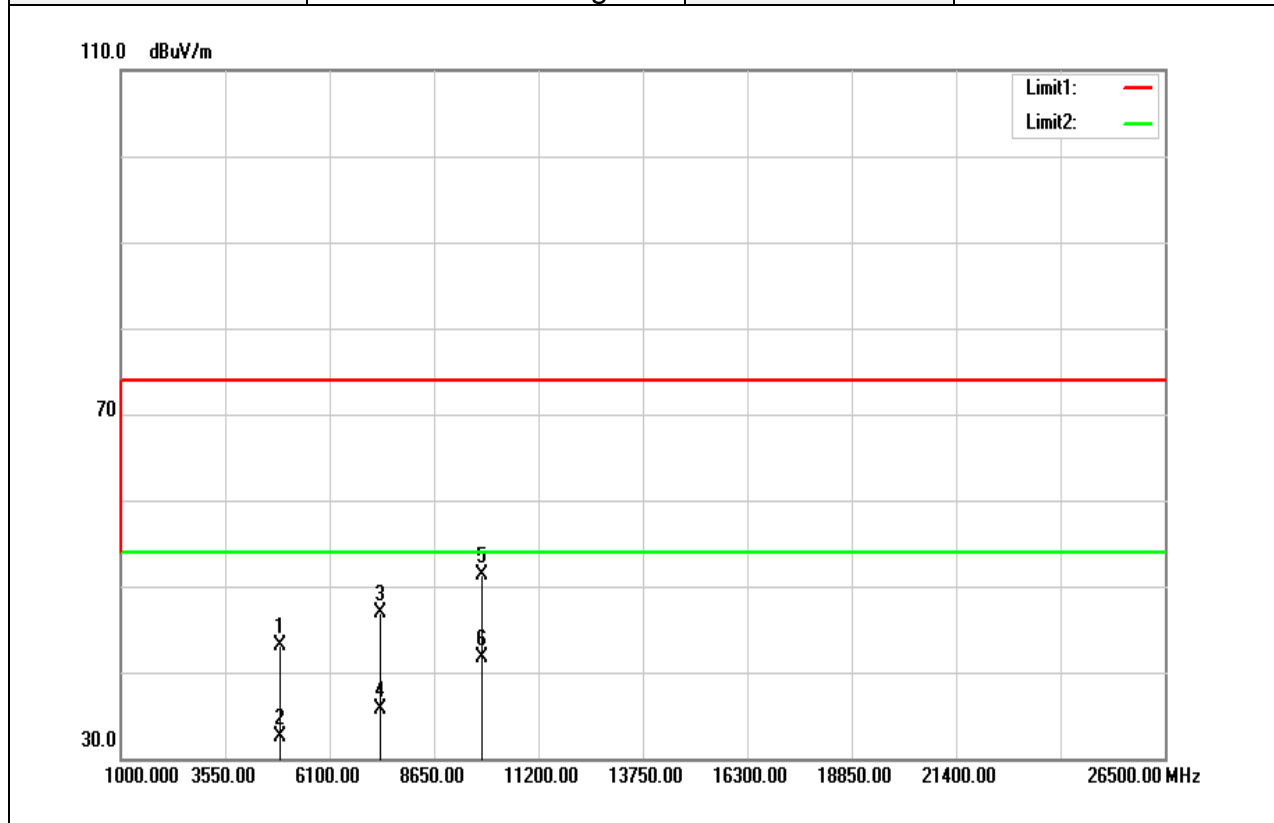

Frequency (MHz)	Reading (dBuV)	Correct Factor (dB/m)	Result (dBuV/m)	Limit (dBuV/m)	Margin (dB)	Remark
4904.000	37.71	5.31	43.02	74.00	-30.98	peak
4904.000	27.25	5.31	32.56	54.00	-21.44	AVG
7356.000	33.83	13.08	46.91	74.00	-27.09	peak
7356.000	22.54	13.08	35.62	54.00	-18.38	AVG
9808.000	33.69	17.60	51.29	74.00	-22.71	peak
9808.000	24.14	17.60	41.74	54.00	-12.26	AVG

Remark:

1. Measuring frequencies from 1 GHz to the 10th harmonic of highest fundamental frequency.
2. For above 1GHz, the EUT peak value was under average limit, therefore the Average value compliance with the average limit