



FCC TEST REPORT (15.407)

REPORT NO.: RF110617E04B-1

MODEL NO.: TEW-726EC

FCC ID: XU8TEW726EC

RECEIVED: June 17, 2011

TESTED: June 22 to July 07, 2011 and
Feb. 07 to 20, 2013

ISSUED: Mar. 12, 2013

APPLICANT: TRENDnet Inc

ADDRESS: 20675 Manhattan Place, Torrance, CA
90501, USA

ISSUED BY: Bureau Veritas Consumer Products Services
(H.K.) Ltd., Taoyuan Branch Hsin Chu Laboratory

LAB ADDRESS : No. 81-1, Lu Liao Keng, 9th Ling, Wu Lung Tsuen,
Chiung Lin Hsiang, Hsin Chu Hsien 307, Taiwan,
R.O.C.

TEST LOCATION (1): No. 81-1, Lu Liao Keng, 9th Ling, Wu Lung Tsuen,
Chiung Lin Hsiang, Hsin Chu Hsien 307, Taiwan,
R.O.C.

TEST LOCATION (2): No. 49, Ln. 206, Wende Rd., Shangshan Tsuen,
Chiung Lin Hsiang, Hsin Chu Hsien 307, Taiwan,
R.O.C.

This report should not be used by the client to claim product certification, approval, or endorsement by TAF or any government agencies.



This report is for your exclusive use. Any copying or replication of this report to or for any other person or entity, or use of our name or trademark, is permitted only with our prior written permission. This report sets forth our findings solely with respect to the test samples identified herein. The results set forth in this report are not indicative or representative of the quality or characteristics of the lot from which a test sample was taken or any similar or identical product unless specifically and expressly noted. Our report includes all of the tests requested by you and the results thereof based upon the information that you provided to us. You have 60 days from date of issuance of this report to notify us of any material error or omission caused by our negligence, provided, however, that such notice shall be in writing and shall specifically address the issue you wish to raise. A failure to raise such issue within the prescribed time shall constitute your unqualified acceptance of the completeness of this report, the tests conducted and the correctness of the report contents. Unless specific mention, the uncertainty of measurement has been explicitly taken into account to declare the compliance or non-compliance to the specification



A D T

Table of Contents

RELEASE CONTROL RECORD.....	4
1. CERTIFICATION.....	5
2. SUMMARY OF TEST RESULTS.....	6
2.1 MEASUREMENT UNCERTAINTY	7
3. GENERAL INFORMATION	8
3.1 GENERAL DESCRIPTION OF EUT.....	8
3.2 DESCRIPTION OF TEST MODES.....	11
3.2.1 TEST MODE APPLICABILITY AND TESTED CHANNEL DETAIL	12
3.3 GENERAL DESCRIPTION OF APPLIED STANDARDS	14
3.4 DUTY CYCLE OF TEST SIGNAL.....	15
3.5 DESCRIPTION OF SUPPORT UNITS.....	16
3.6 CONFIGURATION OF SYSTEM UNDER TEST	17
4. TEST TYPES AND RESULTS.....	18
4.1 CONDUCTED EMISSION MEASUREMENT	18
4.1.1 LIMITS OF CONDUCTED EMISSION MEASUREMENT.....	18
4.1.2 TEST INSTRUMENTS	18
4.1.3 TEST PROCEDURES.....	19
4.1.4 DEVIATION FROM TEST STANDARD	19
4.1.5 TEST SETUP	19
4.1.6 EUT OPERATING CONDITIONS.....	20
4.1.7 TEST RESULTS.....	21
4.2 RADIATED EMISSION AND BANDEDGE MEASUREMENT.....	23
4.2.1 LIMITS OF RADIATED EMISSION AND BANDEDGE MEASUREMENT	23
4.2.2 LIMITS OF UNWANTED EMISSION OUT OF THE RESTRICTED BANDS.....	23
4.2.3 TEST INSTRUMENTS	24
4.2.4 TEST PROCEDURES.....	25
4.2.5 DEVIATION FROM TEST STANDARD	25
4.2.6 TEST SETUP	26
4.2.7 EUT OPERATING CONDITION	26
4.2.8 TEST RESULTS.....	27
4.3 TRANSMIT POWER MEASUREMENT.....	36
4.3.1 LIMITS OF TRANSMIT POWER MEASUREMENT	36
4.3.2 TEST INSTRUMENTS	36
4.3.3 TEST PROCEDURE	37
4.3.4 DEVIATION FROM TEST STANDARD	37
4.3.5 TEST SETUP	37
4.3.6 EUT OPERATING CONDITIONS.....	38
4.3.7 TEST RESULTS.....	39
4.4 PEAK POWER SPECTRAL DENSITY MEASUREMENT	41
4.4.1 LIMITS OF PEAK POWER SPECTRAL DENSITY MEASUREMENT	41
4.4.2 TEST INSTRUMENTS	41
4.4.3 TEST PROCEDURES.....	41
4.4.4 DEVIATION FROM TEST STANDARD	41



A D T

4.4.5	TEST SETUP	41
4.4.6	EUT OPERATING CONDITIONS	42
4.4.7	TEST RESULTS	43
4.5	PEAK POWER EXCURSION MEASUREMENT	44
4.5.1	LIMITS OF PEAK POWER EXCURSION MEASUREMENT	44
4.5.2	TEST INSTRUMENTS	44
4.5.3	TEST PROCEDURE	44
4.5.4	DEVIATION FROM TEST STANDARD	44
4.5.5	TEST SETUP	44
4.5.6	EUT OPERATING CONDITIONS	44
4.5.7	TEST RESULTS	45
4.6	FREQUENCY STABILITY	46
4.6.1	LIMITS OF FREQUENCY STABILITY MEASUREMENT	46
4.6.2	TEST INSTRUMENTS	46
4.6.3	TEST PROCEDURE	46
4.6.4	DEVIATION FROM TEST STANDARD	47
4.6.5	TEST SETUP	47
4.6.6	EUT OPERATING CONDITION	47
4.6.7	TEST RESULTS	48
5.	PHOTOGRAPHS OF THE TEST CONFIGURATION.....	49
6.	INFORMATION ON THE TESTING LABORATORIES	50
7.	APPENDIX A - MODIFICATIONS RECORDERS FOR ENGINEERING CHANGES TO THE EUT BY THE LAB.....	51



A D T

RELEASE CONTROL RECORD

ISSUE NO.	REASON FOR CHANGE	DATE ISSUED
RF110617E04B-1	Original release	Mar. 12, 2013



1. CERTIFICATION

PRODUCT: PCIe adapter
BRAND NAME: TRENDnet
MODEL NO.: TEW-726EC
TEST SAMPLE: MASS-PRODUCTION
APPLICANT: TRENDnet Inc
TESTED: June 22 to July 07, 2011 and Feb. 07 to 20, 2013
STANDARDS: FCC Part 15, Subpart E (Section 15.407)
ANSI C63.10-2009

The above equipment (Model: TEW-726EC) has been tested by **Bureau Veritas Consumer Products Services (H.K.) Ltd., Taoyuan Branch**, and found compliance with the requirement of the above standards. The test record, data evaluation & Equipment Under Test (EUT) configurations represented herein are true and accurate accounts of the measurements of the sample's EMC characteristics under the conditions specified in this report.

PREPARED BY :  , **DATE:** Mar. 12, 2013
(Elsie Hsu, Specialist)

APPROVED BY :  , **DATE:** Mar. 12, 2013
(May Chen, Manager)



A D T

2. SUMMARY OF TEST RESULTS

The EUT has been tested according to the following specifications:

For 5GHz, 5150~5250MHz

APPLIED STANDARD: FCC PART 15, SUBPART E (SECTION 15.407)			
STANDARD SECTION	TEST TYPE	RESULT	REMARK
15.407(b)(6)	AC Power Conducted Emission	PASS	Meet the requirement of limit. Minimum passing margin is -11.74dB at 0.20552MHz
15.407(b/1/2/3) (b)(5)	Spurious Emissions	PASS	Meet the requirement of limit. Minimum passing margin is -0.9dB at 5150.00MHz
15.407(a/1/2/3)	Transmit Power	PASS	Meet the requirement of limit.
15.407(a)(6)	Peak Power Excursion	PASS	Meet the requirement of limit.
15.407(a/1/2/3)	Peak Power Spectral Density	PASS	Meet the requirement of limit.
15.407(g)	Frequency Stability	PASS	Meet the requirement of limit.
15.203	Antenna Requirement	PASS	Antenna connector is SMA Plug Straight / Reverse not a standard connector.

NOTE: The EUT was operating in 2.400 ~ 2.4835GHz, 5.15~5.25GHz and 5.725~5.850GHz frequencies band. This report was recorded the RF parameters including 5.15~5.25GHz. For the 2.400 ~ 2.4835GHz and 5.725~5.850GHz RF parameters was recorded in another test report.



A D T

2.1 MEASUREMENT UNCERTAINTY

Where relevant, the following measurement uncertainty levels have been estimated for tests performed on the EUT as specified in CISPR 16-4-2:

This uncertainty represents an expanded uncertainty expressed at approximately the 95% confidence level using a coverage factor of $k=2$.

Measurement	Value
Conducted emissions	2.98 dB
Radiated emissions (30MHz-1GHz)	5.63 dB
Radiated emissions (1GHz -6GHz)	3.73 dB
Radiated emissions (6GHz -18GHz)	3.90 dB
Radiated emissions (18GHz -40GHz)	4.11 dB



A D T

3. GENERAL INFORMATION

3.1 GENERAL DESCRIPTION OF EUT

PRODUCT	PCIe adapter
MODEL NO.	TEW-726EC
POWER SUPPLY	DC 3.3V \pm 10% from host equipment
MODULATION TYPE	CCK, DQPSK, DBPSK for DSSS 64QAM, 16QAM, QPSK, BPSK for OFDM
MODULATION TECHNOLOGY	DSSS, OFDM
TRANSFER RATE	802.11b: up to 11Mbps 802.11a / g: up to 54Mbps 802.11n: up to 300Mbps
OPERATING FREQUENCY	For 15.407 802.11a/n: 5.18 ~ 5.24GHz
	For 15.247 802.11b/g/n: 2.412 ~ 2.462GHz 802.11a/n: 5.745 ~ 5.825GHz
NUMBER OF CHANNEL	For 15.407 4 for 802.11a, 802.11n (HT20) 2 for 802.11n (HT40)
	For 15.247 (2.4GHz) 11 for 802.11b, 802.11g, 802.11n (HT20) 7 for 802.11n (HT40) For 15.247 (5GHz) 5 for 802.11a, 802.11n (HT20) 2 for 802.11n (HT40)



A D T

MAXIMUM OUTPUT POWER	For 15.407 802.11a: 28.9mW 802.11n (20MHz): 29.0mW 802.11n (40MHz): 44.9mW For 15.247 (2.4GHz) 802.11b: 220.951mW 802.11g: 442.648mW 802.11n (HT20): 502.511mW 802.11n (HT40): 347.652mW For 15.247 (5GHz) 802.11a: 302.712mW 802.11n (HT20): 306.725mW 802.11n (HT40): 355.750mW
ANTENNA TYPE	Please see NOTE
DATA CABLE	NA
I/O PORTS	Refer to user's manual
ASSOCIATED DEVICES	NA



A D T

NOTE:

1. There are two antennas provided to this EUT, please refer to the following table:

Transmitter Circuit	Brand	Model	Gain (dBi) include cable loss	Antenna Type	Connector
Chain (0)	WHA YU GROUP	C037-511105-A (SSR-02561)	2	Dipole	SMA Plug Straight / Reverse
Chain (1)	WHA YU GROUP	C037-511105-A (SSR-02561)	2	Dipole	SMA Plug Straight / Reverse

2. 2.4GHz and 5GHz technology cannot transmit at same time.

3. The EUT incorporates a MIMO function without beam forming.

MODULATION MODE	TX/RX FUNCTION
802.11a	2TX/2RX
802.11b	2TX/2RX
802.11g	2TX/2RX
802.11n (HT20)	2TX/2RX
802.11n (HT40)	2TX/2RX

4. When the EUT operating in 802.11n, the software operation, which is defined by manufacturer, MCS (Modulation and Coding Schemes) from 0 to 15.

5. The above EUT information was declared by the manufacturer and for more detailed features description, please refer to the manufacturer's specifications or User's Manual.



A D T

3.2 DESCRIPTION OF TEST MODES

Operated in 5150 ~ 5250MHz band:

4 channels are provided for 802.11a, 802.11n (HT20):

CHANNEL	FREQUENCY
36	5180 MHz
40	5200 MHz
44	5220 MHz
48	5240 MHz

2 channels are provided for 802.11n (HT40):

CHANNEL	FREQUENCY
38	5190 MHz
46	5230 MHz



3.2.1 TEST MODE APPLICABILITY AND TESTED CHANNEL DETAIL

EUT CONFIGURE MODE	APPLICABLE TO				DESCRIPTION
	PLC	RE < 1G	RE ≥ 1G	APCM	
-	√	√	√	√	-

Where **PLC**: Power Line Conducted Emission **RE < 1G**: Radiated Emission below 1GHz
RE ≥ 1G: Radiated Emission above 1GHz **APCM**: Antenna Port Conducted Measurement

POWER LINE CONDUCTED EMISSION TEST:

- Pre-Scan has been conducted to determine the worst-case mode from all possible combinations between available modulations, data rates and antenna ports (if EUT with antenna diversity architecture).
- Following channel(s) was (were) selected for the final test as listed below.

MODE	AVAILABLE CHANNEL	TESTED CHANNEL	MODULATION TECHNOLOGY	MODULATION TYPE	DATA RATE (MBPS)
802.11n (HT20)	36 to 48	48	OFDM	BPSK	6.5

RADIATED EMISSION TEST (BELOW 1 GHz):

- Pre-Scan has been conducted to determine the worst-case mode from all possible combinations between available modulations, data rates and antenna ports (if EUT with antenna diversity architecture).
- Following channel(s) was (were) selected for the final test as listed below.

MODE	AVAILABLE CHANNEL	TESTED CHANNEL	MODULATION TECHNOLOGY	MODULATION TYPE	DATA RATE (Mbps)
802.11n (HT20)	36 to 48	48	OFDM	BPSK	6.5

RADIATED EMISSION TEST (ABOVE 1 GHz):

- Pre-Scan has been conducted to determine the worst-case mode from all possible combinations between available modulations, data rates and antenna ports (if EUT with antenna diversity architecture).
- Following channel(s) was (were) selected for the final test as listed below.

MODE	AVAILABLE CHANNEL	TESTED CHANNEL	MODULATION TECHNOLOGY	MODULATION TYPE	DATA RATE (Mbps)
802.11a	36 to 48	36, 40, 48	OFDM	BPSK	6
802.11n (HT20)	36 to 48	36, 40, 48	OFDM	BPSK	6.5
802.11n (HT40)	38 to 46	38, 46	OFDM	BPSK	13.5

ANTENNA PORT CONDUCTED MEASUREMENT:

- Pre-Scan has been conducted to determine the worst-case mode from all possible combinations between available modulations, data rates and antenna ports (if EUT with antenna diversity architecture).
- Following channel(s) was (were) selected for the final test as listed below.

MODE	AVAILABLE CHANNEL	TESTED CHANNEL	MODULATION TECHNOLOGY	MODULATION TYPE	DATA RATE (Mbps)
802.11a	36 to 48	36, 40, 48	OFDM	BPSK	6
802.11n (HT20)	36 to 48	36, 40, 48	OFDM	BPSK	6.5
802.11n (HT40)	38 to 46	38, 46	OFDM	BPSK	13.5

TEST CONDITION:

APPLICABLE TO	ENVIRONMENTAL CONDITIONS	INPUT POWER	TESTED BY
PLC	20deg. C, 67%RH	120Vac, 60Hz	Eagle Chen
RE<1G	23deg. C, 65%RH	120Vac, 60Hz	Robert Cheng
RE ³ 1G	23deg. C, 67%RH	120Vac, 60Hz	Robert Cheng
APCM	25deg. C, 60%RH	120Vac, 60Hz	Robert Cheng

3.3 GENERAL DESCRIPTION OF APPLIED STANDARDS

The EUT is a RF product. According to the specifications of the manufacturer, it must comply with the requirements of the following standards:

FCC Part 15, Subpart E (15.407)

789033 D01 General UNII Test Procedures v01 r02

662911 D01 Multiple Transmitter Output v01 r02

ANSI C63.10-2009

All test items have been performed and recorded as per the above standards.

NOTE: The EUT is also considered as a kind of computer peripheral, because the connection to computer is necessary for typical use. It has been verified to comply with the requirements of FCC Part 15, Subpart B, Class B (DoC). The test report has been issued separately.



A D T

3.4 DUTY CYCLE OF TEST SIGNAL

Duty cycle of test signal is 100 % > 98 %, duty factor is not required.

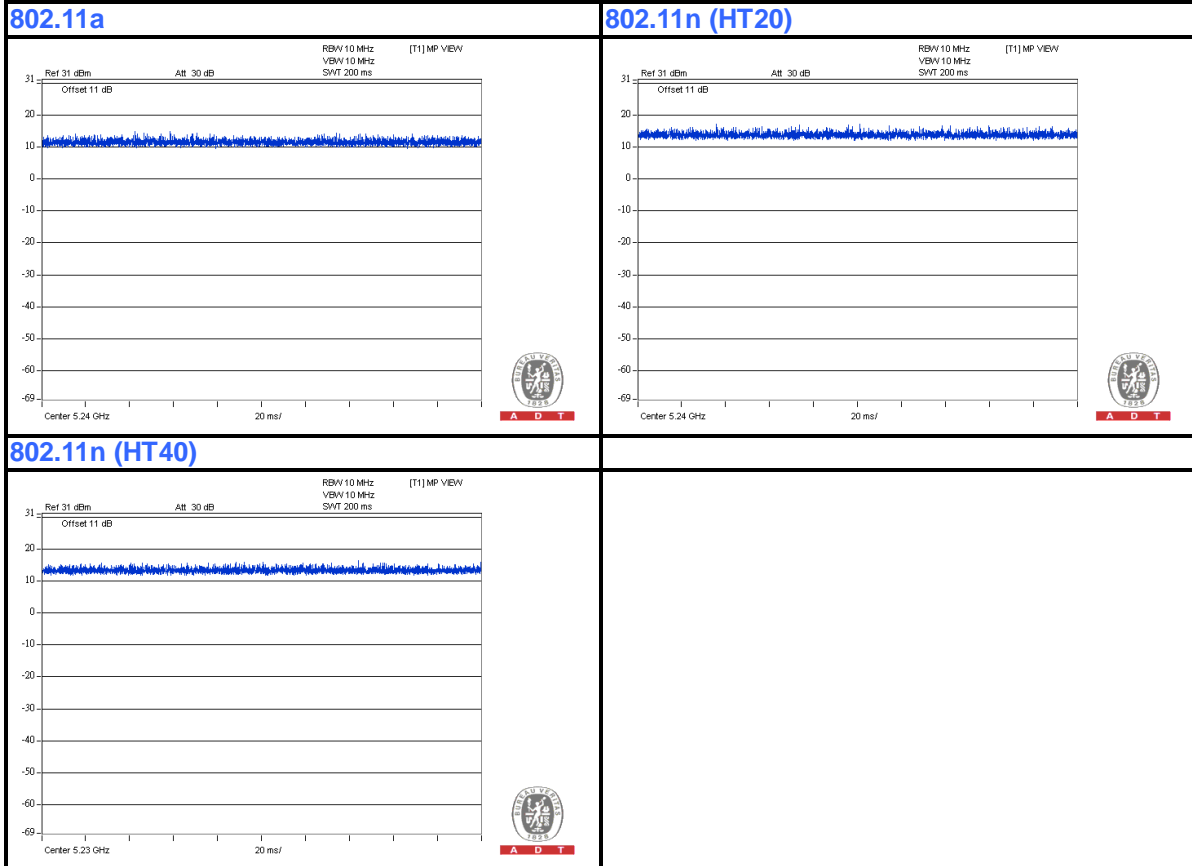



A D T

3.5 DESCRIPTION OF SUPPORT UNITS

The EUT has been tested as an independent unit together with other necessary accessories or support units. The following support units or accessories were used to form a representative test configuration during the tests.

For Conducted test					
NO.	PRODUCT	BRAND	MODEL NO.	SERIAL NO.	FCC ID
1	PERSONAL COMPUTER	DELL	DCSCMF	9KKB32S	FCC DoC
2	MONITOR	DELL	E2210Hc	CN-OG337R-64 180-97S-OQDS	FCC DoC
3	PRINTER	EPSON	LQ-300+II	G88Y074083	FCC DoC
4	MODEM	ACEEX	1414	0206026778	IFAXDM1414
5	KEYBOARD	DELL	SK-8115	MY-0DJ325-716 19-99B-0476	FCC DoC
6	MOUSE	DELL	MOC5UO	I1401LVG	FCC DoC
For other test items					
NO.	PRODUCT	BRAND	MODEL NO.	SERIAL NO.	FCC ID
1	PERSONAL COMPUTER	IBM	A65	L3B4724	FCC DoC
2	MONITOR	DELL	E2210Hc	CN-OG337R-64 180-97S-OQ8S	FCC DoC
3	PRINTER	EPSON	LQ-300+II	G88Y074015	FCC DoC
4	MODEM	ACEEX	1414	0206026778	IFAXDM1414
5	KEYBOARD	DELL	SK-8115	MY-0DJ325-716 19-99B-0479	FCC DoC
6	MOUSE	DELL	MOC5UO	I14066PS	FCC DoC

NO.	SIGNAL CABLE DESCRIPTION OF THE ABOVE SUPPORT UNITS
1	NA
2	1.8m VGA Cable, shielded, with two cores.
3	1.8m braid shielded wire, terminated with DB25 and Centronics connector via metallic frame, w/o core.
4	1.2m braid shielded wire, terminated with DB25 and DB9 connector via metallic frame, w/o core.
5	1.8m USB Cable, shielded.
6	1.5m USB Cable, shielded.

NOTE: All power cords of the above support units are non shielded (1.8m).

3.6 CONFIGURATION OF SYSTEM UNDER TEST

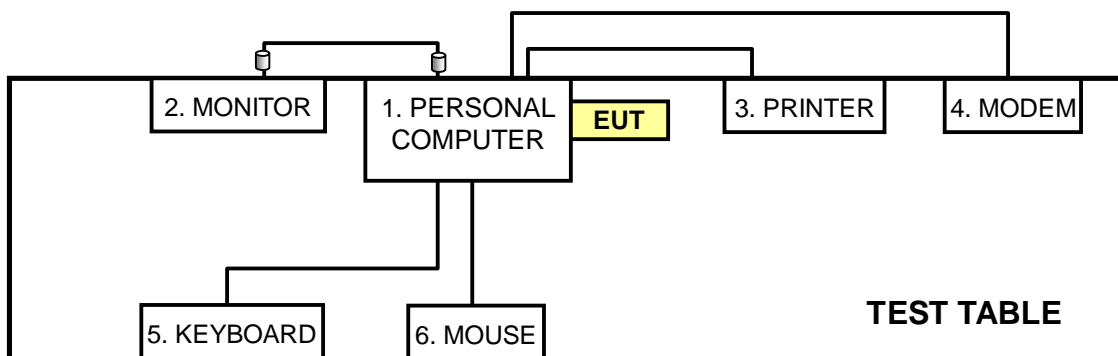



A D T

4. TEST TYPES AND RESULTS

4.1 CONDUCTED EMISSION MEASUREMENT

4.1.1 LIMITS OF CONDUCTED EMISSION MEASUREMENT

FREQUENCY OF EMISSION (MHz)	CONDUCTED LIMIT (dB μ V)	
	Quasi-peak	Average
0.15-0.5	66 to 56	56 to 46
0.5-5	56	46
5-30	60	50

- NOTE:**
1. The lower limit shall apply at the transition frequencies.
 2. The limit decreases in line with the logarithm of the frequency in the range of 0.15 to 0.50 MHz.

4.1.2 TEST INSTRUMENTS

DESCRIPTION & MANUFACTURER	MODEL NO.	SERIAL NO.	CALIBRATED DATE	CALIBRATED UNTIL
Test Receiver	ESCS 30	100375	Mar. 12, 2012	Mar. 11, 2013
Line-Impedance Stabilization Network (for EUT) SCHWARZBECK	NSLK8127	8127-522	Sep. 06, 2012	Sep. 05, 2013
Line-Impedance Stabilization Network (for Peripheral)	ENV216	100072	June 08, 2012	June 07, 2013
RF Cable (JYEBAO)	5DFB	COCCAB-001	Aug. 28, 2012	Aug. 27, 2013
50 ohms Terminator	50	EMC-3	Sep. 25, 2012	Sep. 24, 2013
Software ADT	BV ADT_Cond_V7.3.7.3	NA	NA	NA

Note:

1. The calibration interval of the above test instruments is 12 months and the calibrations are traceable to NML/ROC and NIST/USA.
2. The test was performed in Shielded Room No. C.
3. The VCCI Con C Registration No. is C-3611.
4. Tested Date: Feb. 20, 2013

4.1.3 TEST PROCEDURES

- a. The EUT was placed 0.4 meters from the conducting wall of the shielded room with EUT being connected to the power mains through a line impedance stabilization network (LISN). Other support units were connected to the power mains through another LISN.
- b. The two LISNs provide 50 ohm/ 50uH of coupling impedance for the measuring instrument.
- c. Both lines of the power mains connected to the EUT were checked for maximum conducted interference.
- d. The frequency range from 150kHz to 30MHz was searched. Emission level under (Limit – 20dB) was not recorded.

NOTE:

1. The resolution bandwidth of test receiver is 9kHz for Quasi-peak detection (QP) & Average detection (AV).

4.1.4 DEVIATION FROM TEST STANDARD

No deviation

4.1.5 TEST SETUP

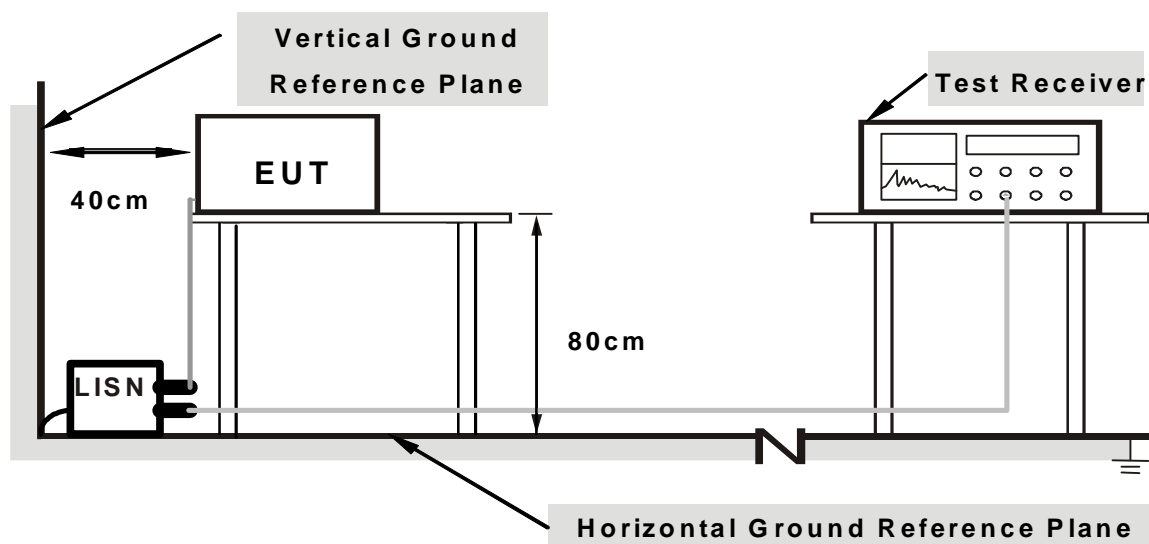

Note: 1.Support units were connected to second LISN.

For the actual test configuration, please refer to the related item – Photographs of the Test Configuration.



A D T

4.1.6 EUT OPERATING CONDITIONS

1. Turned on the power of all equipment.
2. Prepared computer system support unit 1 (Personal Computer) to act as communication partner.
3. The communication partner ran test program “art2_ver_2_14BIN” to enable EUT under transmission/receiving condition continuously.



A D T

4.1.7 TEST RESULTS

PHASE	Line (L)	DETECTOR FUNCTION	Quasi-Peak (QP) / Average (AV)
-------	----------	-------------------	--------------------------------

No	Freq. [MHz]	Corr. Factor (dB)	Reading Value [dB (uV)]		Emission Level [dB (uV)]		Limit [dB (uV)]		Margin (dB)	
			Q.P.	AV.	Q.P.	AV.	Q.P.	AV.	Q.P.	AV.
	1	0.15001	0.11	38.92	27.56	39.03	27.67	66.00	56.00	-26.97
2	0.20552	0.12	44.31	41.52	44.43	41.64	63.38	53.38	-18.95	-11.74
3	0.31026	0.14	30.95	30.83	31.09	30.97	59.96	49.96	-28.87	-18.99
4	0.41378	0.16	30.11	29.3	30.27	29.46	57.57	47.57	-27.30	-18.11
5	9.90243	0.56	27.95	23.72	28.51	24.28	60.00	50.00	-31.49	-25.72
6	14.44555	0.72	34.25	30.27	34.97	30.99	60.00	50.00	-25.03	-19.01
7	23.99227	1.03	31.43	30.66	32.46	31.69	60.00	50.00	-27.54	-18.31

REMARKS:

1. Q.P. and AV. are abbreviations of quasi-peak and average individually.
2. The emission levels of other frequencies were very low against the limit.
3. Margin value = Emission level - Limit value
4. Correction factor = Insertion loss + Cable loss
5. Emission Level = Correction Factor + Reading Value.

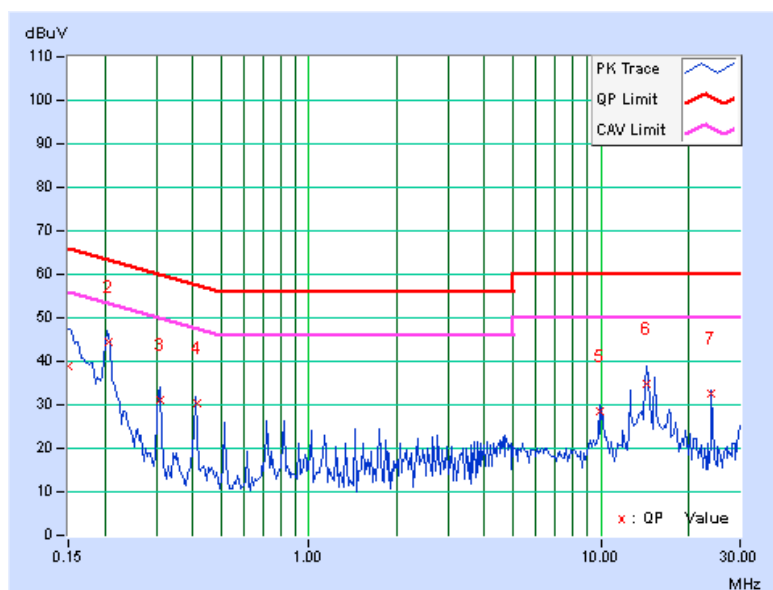

PHASE	Neutral (N)	DETECTOR FUNCTION	Quasi-Peak (QP) / Average (AV)
--------------	-------------	--------------------------	--------------------------------

No	Freq. [MHz]	Corr. Factor (dB)	Reading Value [dB (uV)]		Emission Level [dB (uV)]		Limit [dB (uV)]		Margin (dB)	
			Q.P.	AV.	Q.P.	AV.	Q.P.	AV.	Q.P.	AV.
	1	0.15004	0.09	42.33	29.78	42.42	29.87	66.00	56.00	-23.58
2	0.20845	0.10	40.81	33.62	40.91	33.72	63.27	53.27	-22.35	-19.54
3	0.31019	0.13	27.72	27.36	27.85	27.49	59.97	49.97	-32.12	-22.48
4	0.51882	0.15	27.63	27.35	27.78	27.50	56.00	46.00	-28.22	-18.50
5	12.63674	0.47	29.57	25.46	30.04	25.93	60.00	50.00	-29.96	-24.07
6	15.35941	0.53	33.86	30.70	34.39	31.23	60.00	50.00	-25.61	-18.77
7	23.99236	0.70	31.04	29.26	31.74	29.96	60.00	50.00	-28.26	-20.04

REMARKS:

1. Q.P. and AV. are abbreviations of quasi-peak and average individually.
2. The emission levels of other frequencies were very low against the limit.
3. Margin value = Emission level - Limit value
4. Correction factor = Insertion loss + Cable loss
5. Emission Level = Correction Factor + Reading Value.

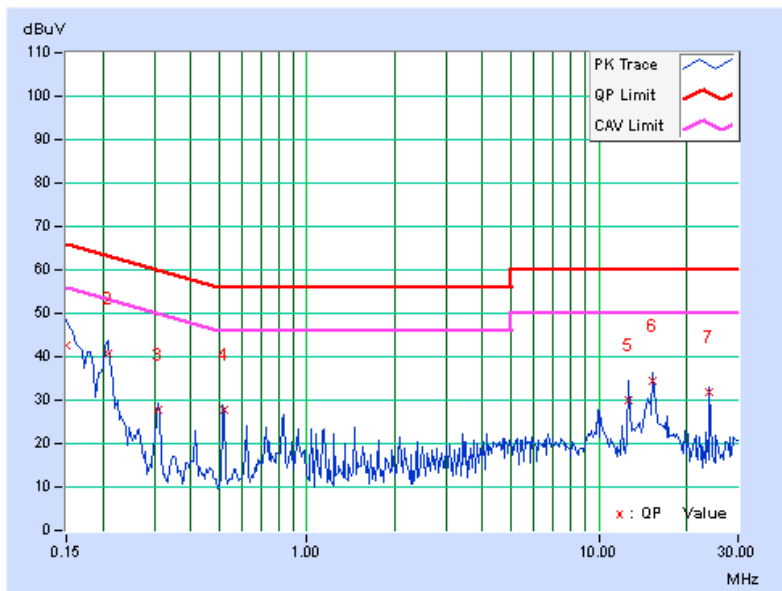



A D T

4.2 RADIATED EMISSION AND BANDEGE MEASUREMENT

4.2.1 LIMITS OF RADIATED EMISSION AND BANDEGE MEASUREMENT

Radiated emissions which fall in the restricted bands must comply with the radiated emission limits specified as below table:

Frequencies (MHz)	Field strength (microvolts/meter)	Measurement distance (meters)
0.009-0.490	2400/F(kHz)	300
0.490-1.705	24000/F(kHz)	30
1.705-30.0	30	30
30-88	100	3
88-216	150	3
216-960	200	3
Above 960	500	3

NOTE:

1. The lower limit shall apply at the transition frequencies.
2. Emission level (dBuV/m) = 20 log Emission level (uV/m).
3. For frequencies above 1000MHz, the field strength limits are based on average detector, however, the peak field strength of any emission shall not exceed the maximum permitted average limits, specified above by more than 20dB under any condition of modulation.

4.2.2 LIMITS OF UNWANTED EMISSION OUT OF THE RESTRICTED BANDS

APPLICABLE TO	LIMIT	
-	FIELD STRENGTH AT 3m (dBμV/m)	
	PK	AV
	74	54
√	EIRP LIMIT (dBm)	EQUIVALENT FIELD STRENGTH AT 3m (dBμV/m)
	PK	PK
	-27	68.3

NOTE:

1. The following formula is used to convert the equipment isotropic radiated power (eirp) to field strength:

$$E = \frac{1000000\sqrt{30P}}{3} \mu\text{V/m, where P is the eirp (Watts).}$$



A D T

4.2.3 TEST INSTRUMENTS

DESCRIPTION & MANUFACTURER	MODEL NO.	SERIAL NO.	CALIBRATED DATE	CALIBRATED UNTIL
Spectrum Analyzer Agilent	E4446A	MY48250254	July 09, 2012	July 08, 2013
Pre-Selector Agilent	N9039A	MY46520311	July 09, 2012	July 08, 2013
Signal Generator Agilent	N5181A	MY49060517	July 09, 2012	July 08, 2013
Pre-Amplifier Mini-Circuits	ZFL-1000VH2 B	AMP-ZFL-03	Nov. 14, 2012	Nov. 13, 2013
Pre-Amplifier Agilent	8449B	3008A02578	June 26, 2012	June 25, 2013
Pre-Amplifier SPACEK LABS	SLKKa-48-6	9K16	Nov. 14, 2012	Nov. 13, 2013
Trilog Broadband Antenna SCHWARZBECK	VULB 9168	9168-360	Apr. 09, 2012	Apr. 08, 2013
Horn_Antenna AISI	AIH.8018	0000320091110	Nov. 19, 2012	Nov. 18, 2013
Horn_Antenna SCHWARZBECK	BBHA 9170	9170-424	Oct. 12, 2012	Oct. 11, 2013
RF Cable	NA	RF104-201 RF104-203 RF104-204	Dec. 25, 2012	Dec. 24, 2013
RF Cable	NA	CHGCAB_001	Oct. 06, 2012	Oct. 05, 2013
Software	ADT_Radiated _V8.7.05	NA	NA	NA
Antenna Tower & Turn Table CT	NA	NA	NA	NA

Note:

1. The calibration interval of the above test instruments is 12 months and the calibrations are traceable to NML/ROC and NIST/USA.
2. The horn antenna, preamplifier (model: 8449B) are used only for the measurement of emission frequency above 1GHz if tested.
- 3 The test was performed in 966 Chamber No. G.
4. The FCC Site Registration No. is 966073.
- 5 The VCCI Site Registration No. is G-137.
- 6 The CANADA Site Registration No. is IC 7450H-2.
- 7 Tested Date: Feb. 07 to 19, 2013

4.2.4 TEST PROCEDURES

- a. The EUT was placed on the top of a rotating table 0.8 meters above the ground at 3 meter chamber room for test. The table was rotated 360 degrees to determine the position of the highest radiation.
- b. The EUT was set 3 meters away from the interference-receiving antenna, which was mounted on the top of a variable-height antenna tower.
- c. The height of antenna is varied from one meter to four meters above the ground to determine the maximum value of the field strength. Both horizontal and vertical polarizations of the antenna are set to make the measurement.
- d. For each suspected emission, the EUT was arranged to its worst case and then the antenna was tuned to heights from 1 meter to 4 meters and the rotatable table was turned from 0 degrees to 360 degrees to find the maximum reading.
- e. The test-receiver system was set to quasi-peak detect function and specified bandwidth with maximum hold mode when the test frequency is below 1 GHz.
- f. The test-receiver system was set to peak and average detect function and specified bandwidth with maximum hold mode when the test frequency is above 1 GHz. If the peak reading value also meets average limit, measurement with the average detector is unnecessary.

NOTE:

1. The resolution bandwidth and video bandwidth of test receiver/spectrum analyzer is 120kHz for Quasi-peak detection (QP) at frequency below 1GHz.
2. The resolution bandwidth of test receiver/spectrum analyzer is 1 MHz and the video bandwidth is 3 MHz for Peak detection (PK) at frequency above 1GHz.
3. The resolution bandwidth of test receiver/spectrum analyzer is 1 MHz and the video bandwidth is 10 Hz for Average detection (AV) at frequency above 1GHz.
4. All modes of operation were investigated and the worst-case emissions are reported.

4.2.5 DEVIATION FROM TEST STANDARD

No deviation

4.2.6 TEST SETUP

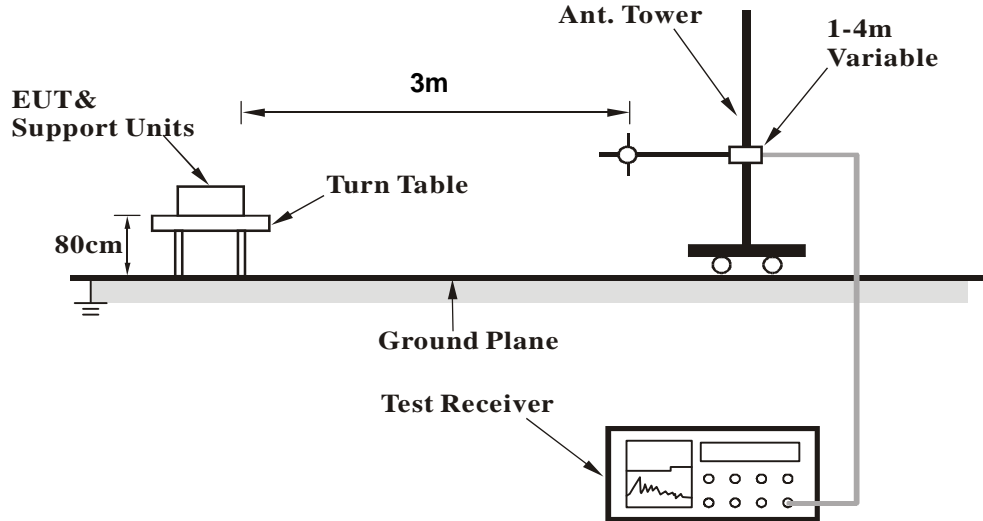

For the actual test configuration, please refer to the related item – Photographs of the Test Configuration.

4.2.7 EUT OPERATING CONDITION

Same as 4.1.6

4.2.8 TEST RESULTS

BELOW 1GHz WORST-CASE DATA

802.11n (HT20)

CHANNEL	TX Channel 48	DETECTOR FUNCTION	Quasi-Peak (QP)
FREQUENCY RANGE	Below 1GHz		

ANTENNA POLARITY & TEST DISTANCE: HORIZONTAL AT 3 M

NO.	FREQ. (MHz)	EMISSION LEVEL (dBuV/m)	LIMIT (dBuV/m)	MARGIN (dB)	ANTENNA HEIGHT (m)	TABLE ANGLE (Degree)	RAW VALUE (dBuV)	CORRECTION FACTOR (dB/m)
1	38.29	26.3 QP	40.0	-13.8	1.50 H	0	12.67	13.58
2	69.55	29.5 QP	40.0	-10.5	1.50 H	0	16.78	12.68
3	108.75	29.0 QP	43.5	-14.6	1.50 H	254	17.89	11.06
4	133.03	30.3 QP	43.5	-13.2	1.50 H	310	16.80	13.46
5	699.68	35.9 QP	46.0	-10.1	1.00 H	236	11.90	23.97
6	766.23	35.8 QP	46.0	-10.2	1.00 H	234	10.57	25.23

ANTENNA POLARITY & TEST DISTANCE: VERTICAL AT 3 M

NO.	FREQ. (MHz)	EMISSION LEVEL (dBuV/m)	LIMIT (dBuV/m)	MARGIN (dB)	ANTENNA HEIGHT (m)	TABLE ANGLE (Degree)	RAW VALUE (dBuV)	CORRECTION FACTOR (dB/m)
1	40.78	28.1 QP	40.0	-11.9	1.50 V	357	14.22	13.90
2	104.13	25.0 QP	43.5	-18.5	1.50 V	264	14.56	10.44
3	232.27	21.4 QP	46.0	-24.6	1.00 V	308	8.84	12.57
4	374.97	24.0 QP	46.0	-22.0	1.50 V	199	6.79	17.22
5	495.28	25.1 QP	46.0	-21.0	1.00 V	159	4.78	20.27
6	699.56	33.9 QP	46.0	-12.1	2.00 V	205	9.96	23.96

REMARKS:

1. Emission level (dBuV/m) = Raw Value (dBuV) + Correction Factor (dB/m).
2. Correction Factor (dB/m) = Antenna Factor (dB/m) + Cable Factor (dB).
3. The other emission levels were very low against the limit.
4. Margin value = Emission level – Limit value.



ABOVE 1GHz DATA

802.11a

CHANNEL	TX Channel 36	DETECTOR FUNCTION	Peak (PK)
FREQUENCY RANGE	1GHz ~ 40GHz		Average (AV)

ANTENNA POLARITY & TEST DISTANCE: HORIZONTAL AT 3 M

NO.	FREQ. (MHz)	EMISSION LEVEL (dBuV/m)	LIMIT (dBuV/m)	MARGIN (dB)	ANTENNA HEIGHT (m)	TABLE ANGLE (Degree)	RAW VALUE (dBuV)	CORRECTION FACTOR (dB/m)
1	5150.00	57.3 PK	74.0	-16.7	1.54 H	33	16.75	40.55
2	5150.00	48.2 AV	54.0	-5.8	1.54 H	33	7.65	40.55
3	*5180.00	109.0 PK			1.47 H	57	68.32	40.68
4	*5180.00	99.0 AV			1.47 H	57	58.32	40.68
5	#10360.00	53.9 PK	68.3	-14.4	1.18 H	39	6.08	47.82
6	15540.00	62.9 PK	74.0	-11.1	1.00 H	97	9.63	53.27
7	15540.00	50.1 AV	54.0	-3.9	1.00 H	97	-3.17	53.27

ANTENNA POLARITY & TEST DISTANCE: VERTICAL AT 3 M

NO.	FREQ. (MHz)	EMISSION LEVEL (dBuV/m)	LIMIT (dBuV/m)	MARGIN (dB)	ANTENNA HEIGHT (m)	TABLE ANGLE (Degree)	RAW VALUE (dBuV)	CORRECTION FACTOR (dB/m)
1	5150.00	66.3 PK	74.0	-7.7	1.40 V	0	25.75	40.55
2	5150.00	51.8 AV	54.0	-2.2	1.40 V	0	11.25	40.55
3	*5180.00	114.9 PK			1.50 V	6	74.22	40.68
4	*5180.00	104.5 AV			1.50 V	6	63.82	40.68
5	#10360.00	53.3 PK	68.3	-15.0	1.08 V	51	5.48	47.82
6	15540.00	63.1 PK	74.0	-10.9	1.00 V	60	9.83	53.27
7	15540.00	50.2 AV	54.0	-3.8	1.00 V	60	-3.07	53.27

REMARKS:

1. Emission level (dBuV/m) = Raw Value (dBuV) + Correction Factor (dB/m).
2. Correction Factor (dB/m) = Antenna Factor (dB/m) + Cable Factor (dB).
3. The other emission levels were very low against the limit.
4. Margin value = Emission level – Limit value.
5. " * ": Fundamental frequency.
6. " # ": The radiated frequency is out of the restricted band.



A D T

CHANNEL	TX Channel 40	DETECTOR FUNCTION	Peak (PK)
FREQUENCY RANGE	1GHz ~ 40GHz		Average (AV)

ANTENNA POLARITY & TEST DISTANCE: HORIZONTAL AT 3 M

NO.	FREQ. (MHz)	EMISSION LEVEL (dBuV/m)	LIMIT (dBuV/m)	MARGIN (dB)	ANTENNA HEIGHT (m)	TABLE ANGLE (Degree)	RAW VALUE (dBuV)	CORRECTION FACTOR (dB/m)
1	*5200.00	108.4 PK			1.47 H	58	67.63	40.77
2	*5200.00	99.0 AV			1.47 H	58	58.23	40.77
3	#10400.00	53.7 PK	68.3	-14.6	1.17 H	32	6.34	47.36
4	15600.00	62.5 PK	74.0	-11.5	1.01 H	96	9.51	52.99
5	15600.00	50.0 AV	54.0	-4.0	1.01 H	96	-2.99	52.99

ANTENNA POLARITY & TEST DISTANCE: VERTICAL AT 3 M

NO.	FREQ. (MHz)	EMISSION LEVEL (dBuV/m)	LIMIT (dBuV/m)	MARGIN (dB)	ANTENNA HEIGHT (m)	TABLE ANGLE (Degree)	RAW VALUE (dBuV)	CORRECTION FACTOR (dB/m)
1	*5200.00	114.6 PK			1.53 V	20	73.83	40.77
2	*5200.00	104.1 AV			1.53 V	20	63.33	40.77
3	#10400.00	53.5 PK	68.3	-14.8	1.09 V	65	6.14	47.36
4	15600.00	62.9 PK	74.0	-11.1	1.00 V	54	9.91	52.99
5	15600.00	49.9 AV	54.0	-4.1	1.00 V	54	-3.09	52.99

REMARKS:

1. Emission level (dBuV/m) = Raw Value (dBuV) + Correction Factor (dB/m).
2. Correction Factor (dB/m) = Antenna Factor (dB/m) + Cable Factor (dB).
3. The other emission levels were very low against the limit.
4. Margin value = Emission level – Limit value.
5. " * ": Fundamental frequency.
6. " # ": The radiated frequency is out of the restricted band.



A D T

CHANNEL	TX Channel 48	DETECTOR FUNCTION	Peak (PK)
FREQUENCY RANGE	1GHz ~ 40GHz		Average (AV)

ANTENNA POLARITY & TEST DISTANCE: HORIZONTAL AT 3 M

NO.	FREQ. (MHz)	EMISSION LEVEL (dBuV/m)	LIMIT (dBuV/m)	MARGIN (dB)	ANTENNA HEIGHT (m)	TABLE ANGLE (Degree)	RAW VALUE (dBuV)	CORRECTION FACTOR (dB/m)
1	*5240.00	109.4 PK			1.52 H	43	68.51	40.89
2	*5240.00	99.2 AV			1.52 H	43	58.31	40.89
3	5350.00	57.1 PK	74.0	-16.9	1.49 H	31	15.95	41.15
4	5350.00	48.3 AV	54.0	-5.7	1.49 H	31	7.15	41.15
5	#10480.00	53.3 PK	68.3	-15.0	1.07 H	25	5.65	47.65
6	15720.00	62.9 PK	74.0	-11.1	1.00 H	106	10.31	52.59
7	15720.00	50.0 AV	54.0	-4.0	1.00 H	106	-2.59	52.59

ANTENNA POLARITY & TEST DISTANCE: VERTICAL AT 3 M

NO.	FREQ. (MHz)	EMISSION LEVEL (dBuV/m)	LIMIT (dBuV/m)	MARGIN (dB)	ANTENNA HEIGHT (m)	TABLE ANGLE (Degree)	RAW VALUE (dBuV)	CORRECTION FACTOR (dB/m)
1	*5240.00	114.5 PK			1.57 V	10	73.61	40.89
2	*5240.00	103.9 AV			1.57 V	10	63.01	40.89
3	5350.00	60.1 PK	74.0	-13.9	1.57 V	10	18.95	41.15
4	5350.00	47.2 AV	54.0	-6.8	1.57 V	10	6.05	41.15
5	#10480.00	52.9 PK	68.3	-15.4	1.06 V	62	5.25	47.65
6	15720.00	62.8 PK	74.0	-11.2	1.00 V	63	10.21	52.59
7	15720.00	49.8 AV	54.0	-4.2	1.00 V	63	-2.79	52.59

REMARKS:

1. Emission level (dBuV/m) = Raw Value (dBuV) + Correction Factor (dB/m).
2. Correction Factor (dB/m) = Antenna Factor (dB/m) + Cable Factor (dB).
3. The other emission levels were very low against the limit.
4. Margin value = Emission level – Limit value.
5. " * ": Fundamental frequency.
6. " # ": The radiated frequency is out of the restricted band.



A D T

802.11n (HT20)

CHANNEL	TX Channel 36	DETECTOR FUNCTION	Peak (PK)
FREQUENCY RANGE	1GHz ~ 40GHz		Average (AV)

ANTENNA POLARITY & TEST DISTANCE: HORIZONTAL AT 3 M

NO.	FREQ. (MHz)	EMISSION LEVEL (dBuV/m)	LIMIT (dBuV/m)	MARGIN (dB)	ANTENNA HEIGHT (m)	TABLE ANGLE (Degree)	RAW VALUE (dBuV)	CORRECTION FACTOR (dB/m)
1	5150.00	56.0 PK	74.0	-18.0	1.34 H	39	15.45	40.55
2	5150.00	47.8 AV	54.0	-6.2	1.34 H	39	7.25	40.55
3	*5180.00	109.7 PK			1.57 H	38	69.02	40.68
4	*5180.00	99.4 AV			1.57 H	38	58.72	40.68
5	#10360.00	53.3 PK	68.3	-15.0	1.04 H	8	5.48	47.82
6	15540.00	62.0 PK	74.0	-12.0	1.00 H	92	8.73	53.27
7	15540.00	49.7 AV	54.0	-4.3	1.00 H	92	-3.57	53.27

ANTENNA POLARITY & TEST DISTANCE: VERTICAL AT 3 M

NO.	FREQ. (MHz)	EMISSION LEVEL (dBuV/m)	LIMIT (dBuV/m)	MARGIN (dB)	ANTENNA HEIGHT (m)	TABLE ANGLE (Degree)	RAW VALUE (dBuV)	CORRECTION FACTOR (dB/m)
1	5150.00	60.2 PK	74.0	-13.8	1.59 V	13	19.65	40.55
2	5150.00	47.4 AV	54.0	-6.6	1.59 V	13	6.85	40.55
3	*5180.00	114.8 PK			1.56 V	16	74.12	40.68
4	*5180.00	104.5 AV			1.56 V	16	63.82	40.68
5	#10360.00	53.3 PK	68.3	-15.0	1.12 V	46	5.48	47.82
6	15540.00	62.9 PK	74.0	-11.1	1.00 V	47	9.63	53.27
7	15540.00	49.7 AV	54.0	-4.3	1.00 V	47	-3.57	53.27

REMARKS:

1. Emission level (dBuV/m) = Raw Value (dBuV) + Correction Factor (dB/m).
2. Correction Factor (dB/m) = Antenna Factor (dB/m) + Cable Factor (dB).
3. The other emission levels were very low against the limit.
4. Margin value = Emission level – Limit value.
5. " * ": Fundamental frequency.
6. " # ": The radiated frequency is out of the restricted band.



A D T

CHANNEL	TX Channel 40	DETECTOR FUNCTION	Peak (PK)
FREQUENCY RANGE	1GHz ~ 40GHz		Average (AV)

ANTENNA POLARITY & TEST DISTANCE: HORIZONTAL AT 3 M

NO.	FREQ. (MHz)	EMISSION LEVEL (dBuV/m)	LIMIT (dBuV/m)	MARGIN (dB)	ANTENNA HEIGHT (m)	TABLE ANGLE (Degree)	RAW VALUE (dBuV)	CORRECTION FACTOR (dB/m)
1	*5200.00	109.6 PK			1.47 H	53	68.83	40.77
2	*5200.00	99.3 AV			1.47 H	53	58.53	40.77
3	#10400.00	53.2 PK	68.3	-15.1	1.02 H	0	5.84	47.36
4	15600.00	61.6 PK	74.0	-12.4	1.00 H	58	8.61	52.99
5	15600.00	49.8 AV	54.0	-4.2	1.00 H	58	-3.19	52.99

ANTENNA POLARITY & TEST DISTANCE: VERTICAL AT 3 M

NO.	FREQ. (MHz)	EMISSION LEVEL (dBuV/m)	LIMIT (dBuV/m)	MARGIN (dB)	ANTENNA HEIGHT (m)	TABLE ANGLE (Degree)	RAW VALUE (dBuV)	CORRECTION FACTOR (dB/m)
1	*5200.00	114.0 PK			1.59 V	7	73.23	40.77
2	*5200.00	103.4 AV			1.59 V	7	62.63	40.77
3	#10400.00	52.7 PK	68.3	-15.6	1.02 V	47	5.34	47.36
4	15600.00	62.7 PK	74.0	-11.3	1.00 V	51	9.71	52.99
5	15600.00	49.5 AV	54.0	-4.5	1.00 V	51	-3.49	52.99

REMARKS:

1. Emission level (dBuV/m) = Raw Value (dBuV) + Correction Factor (dB/m).
2. Correction Factor (dB/m) = Antenna Factor (dB/m) + Cable Factor (dB).
3. The other emission levels were very low against the limit.
4. Margin value = Emission level – Limit value.
5. " * ": Fundamental frequency.
6. " # ": The radiated frequency is out of the restricted band.



A D T

CHANNEL	TX Channel 48	DETECTOR FUNCTION	Peak (PK)
FREQUENCY RANGE	1GHz ~ 40GHz		Average (AV)

ANTENNA POLARITY & TEST DISTANCE: HORIZONTAL AT 3 M

NO.	FREQ. (MHz)	EMISSION LEVEL (dBuV/m)	LIMIT (dBuV/m)	MARGIN (dB)	ANTENNA HEIGHT (m)	TABLE ANGLE (Degree)	RAW VALUE (dBuV)	CORRECTION FACTOR (dB/m)
1	*5240.00	110.0 PK			1.54 H	20	69.11	40.89
2	*5240.00	99.6 AV			1.54 H	20	58.71	40.89
3	5350.00	55.3 PK	74.0	-18.7	1.25 H	22	14.15	41.15
4	5350.00	47.2 AV	54.0	-6.8	1.25 H	22	6.05	41.15
5	#10480.00	53.7 PK	68.3	-14.6	1.01 H	0	6.05	47.65
6	15720.00	62.1 PK	74.0	-11.9	1.00 H	104	9.51	52.59
7	15720.00	50.1 AV	54.0	-3.9	1.00 H	104	-2.49	52.59

ANTENNA POLARITY & TEST DISTANCE: VERTICAL AT 3 M

NO.	FREQ. (MHz)	EMISSION LEVEL (dBuV/m)	LIMIT (dBuV/m)	MARGIN (dB)	ANTENNA HEIGHT (m)	TABLE ANGLE (Degree)	RAW VALUE (dBuV)	CORRECTION FACTOR (dB/m)
1	*5240.00	113.0 PK			1.55 V	2	72.11	40.89
2	*5240.00	103.0 AV			1.55 V	2	62.11	40.89
3	5350.00	59.3 PK	74.0	-14.7	1.56 V	0	18.15	41.15
4	5350.00	46.4 AV	54.0	-7.6	1.56 V	0	5.25	41.15
5	#10480.00	51.9 PK	68.3	-16.4	1.02 V	35	4.25	47.65
6	15720.00	62.6 PK	74.0	-11.4	1.00 V	40	10.01	52.59
7	15720.00	49.7 AV	54.0	-4.3	1.00 V	40	-2.89	52.59

REMARKS:

1. Emission level (dBuV/m) = Raw Value (dBuV) + Correction Factor (dB/m).
2. Correction Factor (dB/m) = Antenna Factor (dB/m) + Cable Factor (dB).
3. The other emission levels were very low against the limit.
4. Margin value = Emission level – Limit value.
5. " * ": Fundamental frequency.
6. " # ": The radiated frequency is out of the restricted band.



A D T

802.11n (HT40)

CHANNEL	TX Channel 38	DETECTOR FUNCTION	Peak (PK)
FREQUENCY RANGE	1GHz ~ 40GHz		Average (AV)

ANTENNA POLARITY & TEST DISTANCE: HORIZONTAL AT 3 M

NO.	FREQ. (MHz)	EMISSION LEVEL (dBuV/m)	LIMIT (dBuV/m)	MARGIN (dB)	ANTENNA HEIGHT (m)	TABLE ANGLE (Degree)	RAW VALUE (dBuV)	CORRECTION FACTOR (dB/m)
1	5150.00	55.5 PK	74.0	-18.5	1.12 H	28	14.95	40.55
2	5150.00	47.6 AV	54.0	-6.4	1.12 H	28	7.05	40.55
3	*5190.00	103.5 PK			1.21 H	12	62.77	40.73
4	*5190.00	93.6 AV			1.21 H	12	52.87	40.73
5	#10380.00	53.2 PK	68.3	-15.1	1.00 H	0	5.61	47.59
6	15570.00	60.8 PK	74.0	-13.2	1.00 H	100	7.67	53.13
7	15570.00	48.9 AV	54.0	-5.1	1.00 H	100	-4.23	53.13

ANTENNA POLARITY & TEST DISTANCE: VERTICAL AT 3 M

NO.	FREQ. (MHz)	EMISSION LEVEL (dBuV/m)	LIMIT (dBuV/m)	MARGIN (dB)	ANTENNA HEIGHT (m)	TABLE ANGLE (Degree)	RAW VALUE (dBuV)	CORRECTION FACTOR (dB/m)
1	5150.00	69.0 PK	74.0	-5.0	1.33 V	8	28.45	40.55
2	5150.00	53.1 AV	54.0	-0.9	1.33 V	8	12.55	40.55
3	*5190.00	109.9 PK			1.17 V	9	69.17	40.73
4	*5190.00	99.9 AV			1.17 V	9	59.17	40.73
5	#10380.00	51.5 PK	68.3	-16.8	1.03 V	22	3.91	47.59
6	15570.00	61.5 PK	74.0	-12.5	1.00 V	46	8.37	53.13
7	15570.00	48.9 AV	54.0	-5.1	1.00 V	46	-4.23	53.13

REMARKS:

1. Emission level (dBuV/m) = Raw Value (dBuV) + Correction Factor (dB/m).
2. Correction Factor (dB/m) = Antenna Factor (dB/m) + Cable Factor (dB).
3. The other emission levels were very low against the limit.
4. Margin value = Emission level – Limit value.
5. " * ": Fundamental frequency.
6. " # ": The radiated frequency is out of the restricted band.

CHANNEL	TX Channel 46	DETECTOR FUNCTION	Peak (PK)
FREQUENCY RANGE	1GHz ~ 40GHz		Average (AV)

ANTENNA POLARITY & TEST DISTANCE: HORIZONTAL AT 3 M								
NO.	FREQ. (MHz)	EMISSION LEVEL (dBuV/m)	LIMIT (dBuV/m)	MARGIN (dB)	ANTENNA HEIGHT (m)	TABLE ANGLE (Degree)	RAW VALUE (dBuV)	CORRECTION FACTOR (dB/m)
1	*5230.00	100.1 PK			1.21 H	12	59.24	40.86
2	*5230.00	96.8 AV			1.21 H	12	55.94	40.86
3	5350.00	55.6 PK	74.0	-18.4	1.09 H	13	14.45	41.15
4	5350.00	47.5 AV	54.0	-6.5	1.09 H	13	6.35	41.15
5	#10460.00	52.9 PK	68.3	-15.4	1.00 H	0	5.32	47.58
6	15690.00	60.8 PK	74.0	-13.2	1.00 H	115	8.16	52.64
7	15690.00	48.9 AV	54.0	-5.1	1.00 H	115	-3.74	52.64

ANTENNA POLARITY & TEST DISTANCE: VERTICAL AT 3 M								
NO.	FREQ. (MHz)	EMISSION LEVEL (dBuV/m)	LIMIT (dBuV/m)	MARGIN (dB)	ANTENNA HEIGHT (m)	TABLE ANGLE (Degree)	RAW VALUE (dBuV)	CORRECTION FACTOR (dB/m)
1	*5230.00	112.4 PK			1.23 V	61	71.54	40.86
2	*5230.00	102.6 AV			1.23 V	61	61.74	40.86
3	5350.00	58.9 PK	74.0	-15.1	1.00 V	37	17.75	41.15
4	5350.00	46.0 AV	54.0	-8.0	1.00 V	37	4.85	41.15
5	#10460.00	50.7 PK	68.3	-17.6	1.02 V	22	3.12	47.58
6	15690.00	61.7 PK	74.0	-12.3	1.00 V	60	9.06	52.64
7	15690.00	49.0 AV	54.0	-5.0	1.00 V	60	-3.64	52.64

REMARKS:

1. Emission level (dBuV/m) = Raw Value (dBuV) + Correction Factor (dB/m).
2. Correction Factor (dB/m) = Antenna Factor (dB/m) + Cable Factor (dB).
3. The other emission levels were very low against the limit.
4. Margin value = Emission level – Limit value.
5. " * ": Fundamental frequency.
6. " # ": The radiated frequency is out of the restricted band.



A D T

4.3 TRANSMIT POWER MEASUREMENT

4.3.1 LIMITS OF TRANSMIT POWER MEASUREMENT

Frequency Band	Limit
5.15 – 5.25GHz	The lesser of 50mW (17dBm) or 4dBm + 10logB
5.25 – 5.35GHz	The lesser of 250mW (24dBm) or 11dBm + 10logB
5.47 – 5.725GHz	The lesser of 250mW (24dBm) or 11dBm + 10logB
5.725 – 5.825GHz	The lesser of 1W (30dBm) or 17dBm + 10logB

NOTE: Where B is the 26dB emission bandwidth in MHz.

Per KDB 662911 D01 Multiple Transmitter Output v01r02 Method of conducted output power measurement on IEEE 802.11 devices,

- Array Gain = 0 dB (i.e., no array gain) for NANT ≤ 4;
- Array Gain = 0 dB (i.e., no array gain) for channel widths ≥ 40 MHz for any NANT;
- Array Gain = 5 log(NANT/NSS) dB or 3 dB, whichever is less for 20-MHz channel widths with NANT ≥ 5.

For power measurements on all other devices: Array Gain = 10 log(NANT/NSS) dB.

4.3.2 TEST INSTRUMENTS

DESCRIPTION & MANUFACTURER	MODEL NO.	SERIAL NO.	CALIBRATED DATE	CALIBRATED UNTIL
Spectrum Analyzer	E4446A	MY48250254	July 14, 2010	July 13, 2011

1. The calibration interval of the above test instruments is 12 months and the calibrations are traceable to NML/ROC and NIST/USA.
2. Tested date : July 07, 2011

4.3.3 TEST PROCEDURE

FOR POWER OUTPUT MEASUREMENT

1. Set span to encompass the entire emission bandwidth (EBW) of the signal.
2. Set RBW =1MHz.
3. Set the VBW $\geq 3 \times$ RBW.
4. Number of points in sweep ≥ 2 Span / RBW.
5. Sweep time = auto.
6. Set trigger to free run (duty cycle ≥ 98 percent) ; Set video trigger (duty cycle < 98 percent)
7. Detector = RMS.
8. Trace average at least 100 traces in power averaging mode
9. Compute power by integrating the spectrum across the 26 dB EBW of the signal.

FOR 26dB OCCUPIED BANDWIDTH

- 1) Set RBW = approximately 1% of the emission bandwidth.
- 2) Set the VBW $>$ RBW.
- 3) Detector = Peak.
- 4) Trace mode = max hold.
- 5) Measure the maximum width of the emission that is 26 dB down from the peak of the emission. Compare this with the RBW setting of the analyzer. Readjust RBW and repeat measurement as needed until the RBW/EBW ratio is approximately 1%.

4.3.4 DEVIATION FROM TEST STANDARD

No deviation

4.3.5 TEST SETUP

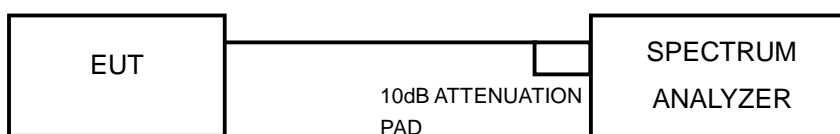

4.3.6 EUT OPERATING CONDITIONS

The software provided by client to enable the EUT under transmission condition continuously at specific channel frequencies individually.



A D T

4.3.7 TEST RESULTS

POWER OUTPUT:

802.11a

CHAN.	CHAN. FREQ. (MHz)	AVERAGE POWER (dBm)		TOTAL POWER (mW)	TOTAL POWER (dBm)	POWER LIMIT (dBm)	PASS / FAIL
		CHAIN 0	CHAIN 1				
36	5180	12.3	10.0	27.0	14.3	17	PASS
40	5200	11.7	10.0	24.8	13.9	17	PASS
48	5240	12.4	10.6	28.9	14.6	17	PASS

802.11n (HT20)

CHAN.	CHAN. FREQ. (MHz)	AVERAGE POWER (dBm)		TOTAL POWER (mW)	TOTAL POWER (dBm)	POWER LIMIT (dBm)	PASS / FAIL
		CHAIN 0	CHAIN 1				
36	5180	12.1	10.1	26.5	14.2	17	PASS
40	5200	12.2	10.6	28.1	14.5	17	PASS
48	5240	12.3	10.8	29.0	14.6	17	PASS

802.11n (HT40)

CHAN.	CHAN. FREQ. (MHz)	AVERAGE POWER (dBm)		TOTAL POWER (mW)	TOTAL POWER (dBm)	POWER LIMIT (dBm)	PASS / FAIL
		CHAIN 0	CHAIN 1				
38	5190	11.9	9.5	24.4	13.9	17	PASS
46	5230	14.2	12.7	44.9	16.5	17	PASS



A D T

26dB OCCUPIED BANDWIDTH:

802.11a

CHANNEL	CHANNEL FREQUENCY (MHz)	26dBc BANDWIDTH (MHz)	
		CHAIN 0	CHAIN 1
36	5180	24.58	24.45
40	5200	23.83	23.74
48	5240	25.67	25.51

802.11n (HT20)

CHANNEL	CHANNEL FREQUENCY (MHz)	26dBc BANDWIDTH (MHz)	
		CHAIN 0	CHAIN 1
36	5180	25.00	24.98
40	5200	24.42	24.26
48	5240	24.42	24.32

802.11n (HT40)

CHANNEL	CHANNEL FREQUENCY (MHz)	26dBc BANDWIDTH (MHz)	
		CHAIN 0	CHAIN 1
38	5190	47.33	47.22
46	5230	48.50	48.26



A D T

4.4 PEAK POWER SPECTRAL DENSITY MEASUREMENT

4.4.1 LIMITS OF PEAK POWER SPECTRAL DENSITY MEASUREMENT

Frequency Band	Limit
5.15 ~ 5.25GHz	4dBm
5.25 ~ 5.35GHz	11dBm
5.47 ~ 5.725GHz	11dBm
5.725 ~ 5.825GHz	17dBm

4.4.2 TEST INSTRUMENTS

DESCRIPTION & MANUFACTURER	MODEL NO.	SERIAL NO.	CALIBRATED DATE	CALIBRATED UNTIL
Spectrum Analyzer	E4446A	MY48250254	July 14, 2010	July 13, 2011

Note:

1. The calibration interval of the above test instruments is 12 months and the calibrations are traceable to NML/ROC and NIST/USA.
2. Tested date : July 07, 2011

4.4.3 TEST PROCEDURES

Using method SA-1

Set span to encompass the entire emission bandwidth (EBW) of the signal.

1. Set span to encompass the entire emission bandwidth (EBW) of the signal.
2. Set RBW = 1 MHz, Set VBW \geq 3 MHz, Detector = RMS
3. Sweep time = auto, trigger set to "free run".
4. Trace average at least 100 traces in power averaging mode.
5. Record the max value

4.4.4 DEVIATION FROM TEST STANDARD

No deviation

4.4.5 TEST SETUP

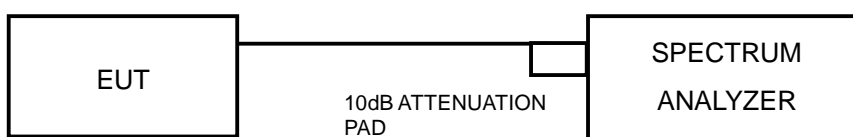



A D T

4.4.6 EUT OPERATING CONDITIONS

Same as 4.3.6



4.4.7 TEST RESULTS

802.11a

CHANNEL	FREQUENCY (MHz)	PSD (dBm)		TOTAL POWER DENSITY (dBm)	MAX. LIMIT (dBm)	PASS/FAIL
		CHAIN 0	CHAIN 1			
36	5180	1.7	-0.9	3.6	4	PASS
40	5200	1.5	-0.6	3.6	4	PASS
48	5240	1.5	-0.3	3.7	4	PASS

- NOTE:**
1. Method 1 of power density measurement of KDB 662911 is using for calculating total power density. Total power density is summing entire spectra across corresponding frequency bins on the various outputs by computer.
 2. Directional gain = $2\text{dBi} + 10\log(2) = 5\text{dBi} < 6\text{dBi}$, so the power density limit shall not be reduced.

802.11n (HT20)

CHANNEL	FREQUENCY (MHz)	PSD (dBm)		TOTAL POWER DENSITY (dBm)	MAX. LIMIT (dBm)	PASS/FAIL
		CHAIN 0	CHAIN 1			
36	5180	1.3	-0.9	3.3	4	PASS
40	5200	1.4	0.3	3.9	4	PASS
48	5240	1.0	-0.3	3.4	4	PASS

- NOTE:**
1. Method 1 of power density measurement of KDB 662911 is using for calculating total power density. Total power density is summing entire spectra across corresponding frequency bins on the various outputs by computer.
 2. Directional gain = $2\text{dBi} + 10\log(2) = 5\text{dBi} < 6\text{dBi}$, so the power density limit shall not be reduced.

802.11n (HT40)

CHANNEL	FREQUENCY (MHz)	PSD (dBm)		TOTAL POWER DENSITY (dBm)	MAX. LIMIT (dBm)	PASS/FAIL
		CHAIN 0	CHAIN 1			
38	5190	-1.3	-4.7	0.3	4	PASS
46	5230	0.1	-1.6	2.3	4	PASS

- NOTE:**
1. Method 1 of power density measurement of KDB 662911 is using for calculating total power density. Total power density is summing entire spectra across corresponding frequency bins on the various outputs by computer.
 2. Directional gain = $2\text{dBi} + 10\log(2) = 5\text{dBi} < 6\text{dBi}$, so the power density limit shall not be reduced.

4.5 PEAK POWER EXCURSION MEASUREMENT

4.5.1 LIMITS OF PEAK POWER EXCURSION MEASUREMENT

Shall not exceed 13 dB

4.5.2 TEST INSTRUMENTS

DESCRIPTION & MANUFACTURER	MODEL NO.	SERIAL NO.	CALIBRATED DATE	CALIBRATED UNTIL
Spectrum Analyzer	E4446A	MY48250254	July 14, 2010	July 13, 2011

Note:

1. The calibration interval of the above test instruments is 12 months and the calibrations are traceable to NML/ROC and NIST/USA.
2. Tested date : July 07, 2011

4.5.3 TEST PROCEDURE

1. Set RBW = 1 MHz, VBW \geq 3 MHz, Detector = peak.
2. Trace mode = max-hold. Allow the sweeps to continue until the trace stabilizes.
3. Use the peak search function to find the peak of the spectrum.
4. Measure the PPSD.
5. Compute the ratio of the maximum of the peak-max-hold spectrum to the PPSD.

4.5.4 DEVIATION FROM TEST STANDARD

No deviation

4.5.5 TEST SETUP

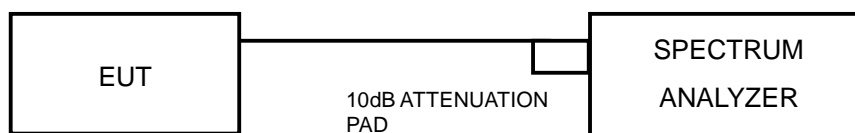

4.5.6 EUT OPERATING CONDITIONS

The software provided by client to enable the EUT under transmission condition continuously at specific channel frequencies individually.



A D T

4.5.7 TEST RESULTS

802.11a

CHAN.	CHAN. FREQ. (MHz)	PEAK VALUE (dBm)		PPSD (dBm)		PEAK EXCURSION (dB)		LIMIT (dB)	PASS/F AIL
		CHAIN 0	CHAIN 1	CHAIN 0	CHAIN 1	CHAIN 0	CHAIN 1		
36	5180	10.00	7.20	1.70	-0.90	8.30	8.10	13	PASS
40	5200	9.50	7.30	1.50	-0.60	8.00	7.90	13	PASS
48	5240	9.10	7.20	1.50	-0.30	7.60	7.50	13	PASS

802.11n (HT20)

CHAN.	CHAN. FREQ. (MHz)	PEAK VALUE (dBm)		PPSD (dBm)		PEAK EXCURSION (dB)		LIMIT (dB)	PASS/F AIL
		CHAIN 0	CHAIN 1	CHAIN 0	CHAIN 1	CHAIN 0	CHAIN 1		
36	5180	8.80	6.50	1.30	-0.90	7.50	7.40	13	PASS
40	5200	9.20	7.90	1.40	0.30	7.80	7.60	13	PASS
48	5240	8.60	7.20	1.00	-0.30	7.60	7.50	13	PASS

802.11n (HT40)

CHAN.	CHAN. FREQ. (MHz)	PEAK VALUE (dBm)		PPSD (dBm)		PEAK EXCURSION (dB)		LIMIT (dB)	PASS/F AIL
		CHAIN 0	CHAIN 1	CHAIN 0	CHAIN 1	CHAIN 0	CHAIN 1		
38	5190	7.30	3.80	-1.30	-4.70	8.60	8.50	13	PASS
46	5230	8.10	6.20	0.10	-1.60	8.00	7.80	13	PASS

4.6 FREQUENCY STABILITY

4.6.1 LIMITS OF FREQUENCY STABILITY MEASUREMENT

The frequency of the carrier signal shall be maintained within band of operation

4.6.2 TEST INSTRUMENTS

DESCRIPTION & MANUFACTURER	MODEL NO.	SERIAL NO.	CALIBRATED DATE	CALIBRATED UNTIL
R&S Spectrum Analyzer	FSP40	100037	Nov. 01, 2012	Oct. 31, 2013

Note:

1. The calibration interval of the above test instruments is 12 months and the calibrations are traceable to NML/ROC and NIST/USA.
2. Tested date : Feb. 19, 2013

4.6.3 TEST PROCEDURE

1. The EUT was placed inside the environmental test chamber and powered by nominal AC voltage.
2. Turn the EUT on and couple its output to a spectrum analyzer.
3. Turn the EUT off and set the chamber to the highest temperature specified.
4. Allow sufficient time (approximately 30 min) for the temperature of the chamber to stabilize, turn the EUT on and measure the operating frequency after 2, 5, and 10 minutes.
5. Repeat step 2 and 3 with the temperature chamber set to the lowest temperature.
6. The test chamber was allowed to stabilize at +20 degree C for a minimum of 30 minutes. The supply voltage was then adjusted on the EUT from 85% to 115% and the frequency record.

4.6.4 DEVIATION FROM TEST STANDARD

No deviation

4.6.5 TEST SETUP

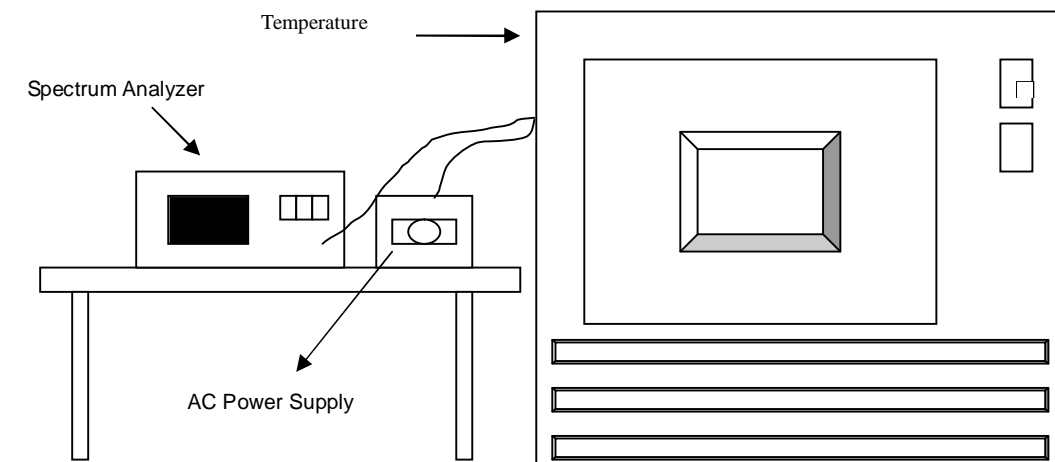

4.6.6 EUT OPERATING CONDITION

Set the EUT transmit at un-modulation mode to test frequency stability.



A D T

4.6.7 TEST RESULTS

FREQUENCY STABILITY VERSUS TEMP.									
OPERATING FREQUENCY: 5240MHz									
TEMP. (°C)	POWER SUPPLY (Vac)	0 MINUTE		2 MINUTE		5 MINUTE		10 MINUTE	
		Measured Frequency	Frequency Drift	Measured Frequency	Frequency Drift	Measured Frequency	Frequency Drift	Measured Frequency	Frequency Drift
		(MHz)	ppm	(MHz)	ppm	(MHz)	ppm	(MHz)	ppm
50	120	5239.9971	-0.5534	5239.9981	-0.3626	5240.0032	0.6107	5239.9987	-0.2481
40	120	5239.99	-1.9084	5239.9877	-2.3473	5239.9879	-2.3092	5239.994	-1.1450
30	120	5240.0167	3.1870	5240.0136	2.5954	5240.0151	2.8817	5240.0127	2.4237
20	120	5240.0159	3.0344	5240.0159	3.0344	5240.0195	3.7214	5240.0183	3.4924
10	120	5240.0087	1.6603	5240.0125	2.3855	5240.0094	1.7939	5240.0166	3.1679
0	120	5239.9914	-1.6412	5239.9891	-2.0802	5239.9833	-3.1870	5239.987	-2.4809
-10	120	5240.0091	1.7366	5240.0003	0.0573	5240.0094	1.7939	5240.0082	1.5649
-20	120	5239.9923	-1.4695	5239.9931	-1.3168	5239.9896	-1.9847	5239.9952	-0.9160
-30	120	5239.9893	-2.0420	5239.9862	-2.6336	5239.9847	-2.9198	5239.9849	-2.8817

FREQUENCY STABILITY VERSUS VOLTAGE									
OPERATING FREQUENCY: 5240MHz									
TEMP. (°C)	POWER SUPPLY (Vac)	0 MINUTE		2 MINUTE		5 MINUTE		10 MINUTE	
		Measured Frequency	Frequency Drift	Measured Frequency	Frequency Drift	Measured Frequency	Frequency Drift	Measured Frequency	Frequency Drift
		(MHz)	ppm	(MHz)	ppm	(MHz)	ppm	(MHz)	ppm
20	138	5240.015	2.8626	5240.0159	3.0344	5240.0195	3.7214	5240.017	3.2443
	120	5240.0159	3.0344	5240.0159	3.0344	5240.0195	3.7214	5240.0183	3.4924
	102	5240.0149	2.8435	5240.0155	2.9580	5240.0189	3.6069	5240.0188	3.5878



A D T

5. PHOTOGRAPHS OF THE TEST CONFIGURATION

Please refer to the attached file (Test Setup Photo).





6. INFORMATION ON THE TESTING LABORATORIES

We, Bureau Veritas Consumer Products Services (H.K.) Ltd., Taoyuan Branch, were founded in 1988 to provide our best service in EMC, Radio, Telecom and Safety consultation. Our laboratories are accredited and approved according to ISO/IEC 17025.

If you have any comments, please feel free to contact us at the following:

Linko EMC/RF Lab:

Tel: 886-2-26052180

Fax: 886-2-26052943

Hsin Chu EMC/RF Lab:

Tel: 886-3-5935343

Fax: 886-3-5935342

Hwa Ya EMC/RF/Safety/Telecom Lab:

Tel: 886-3-3183232

Fax: 886-3-3270892

Email: service.adt@tw.bureauveritas.com

Web Site: www.bureauveritas-adt.com

The address and road map of all our labs can be found in our web site also.



A D T

7.APPENDIX A - MODIFICATIONS RECORDERS FOR ENGINEERING CHANGES TO THE EUT BY THE LAB

No modifications were made to the EUT by the lab during the test.

--- END ---