



FCC 47 CFR PART 15 SUBPART E

TEST REPORT

For

450Mbps Dual Band Wireless N 4-Port Media Bridge

Model: TEW-680MB

Trade Name: TRENDnet

Issued to

**TRENDnet, Inc.
20675 Manhattan Place, Torrance, CA 90501**

Issued by

**Compliance Certification Services Inc.
No.11, Wu-Gong 6th Rd., Wugu Industrial Park,
New Taipei City 248, Taiwan (R.O.C.)
<http://www.ccsrf.com>
service@ccsrf.com
Issued Date: August 3, 2011**



Note: This report shall not be reproduced except in full, without the written approval of Compliance Certification Services Inc. This document may be altered or revised by Compliance Certification Services Inc. personnel only, and shall be noted in the revision section of the document.



Revision History

Rev.	Issue Date	Revisions	Effect Page	Revised By
00	July 27, 2011	Initial Issue	ALL	Sandy Lin
01	August 3, 2011	Revised Conducted emission test	P.101-103 & P.106-107	Sandy Lin



TABLE OF CONTENTS

1. TEST RESULT CERTIFICATION.....	4
2. EUT DESCRIPTION	5
3. TEST METHODOLOGY	6
3.1 EUT CONFIGURATION	6
3.2 EUT EXERCISE	6
3.3 GENERAL TEST PROCEDURES	6
3.4 FCC PART 15.205 RESTRICTED BANDS OF OPERATIONS	7
3.5 DESCRIPTION OF TEST MODES	8
4. INSTRUMENT CALIBRATION.....	9
4.1 MEASURING INSTRUMENT CALIBRATION	9
4.2 MEASUREMENT EQUIPMENT USED	9
4.3 MEASUREMENT UNCERTAINTY	10
5. FACILITIES AND ACCREDITATIONS	11
5.1 FACILITIES	11
5.2 EQUIPMENT	11
5.3 TABLE OF ACCREDITATIONS AND LISTINGS	12
6. SETUP OF EQUIPMENT UNDER TEST	13
6.1 SETUP CONFIGURATION OF EUT	13
6.2 SUPPORT EQUIPMENT	13
7. FCC PART 15 REQUIREMENTS.....	14
7.1 26 DB EMISSION BANDWIDTH	14
7.2 PEAK POWER	27
7.3 BAND EDGES MEASUREMENT	41
7.4 PEAK POWER SPECTRAL DENSITY	54
7.5 PEAK EXCURSION	67
7.6 RADIATED UNDESIRABLE EMISSION.....	81
7.7 CONDUCTED UNDESIRABLE EMISSION	94
7.8 POWERLINE CONDUCTED EMISSIONS	108
7.9 FREQUENCY STABILITY.....	111
APPENDIX I RADIO FREQUENCY EXPOSURE	118
APPENDIX II PHOTOGRAPHS OF TEST SETUP.....	121
APPENDIX 1 - PHOTOGRAPHS OF EUT	



1. TEST RESULT CERTIFICATION

Applicant: TRENDnet, Inc.
20675 Manhattan Place, Torrance, CA 90501

Equipment Under Test: 450Mbps Dual Band Wireless N 4-Port Media Bridge

Trade Name: TRENDnet

Model: TEW-680MB

Date of Test: July 9 ~ August 2, 2011

APPLICABLE STANDARDS	
STANDARD	TEST RESULT
FCC 47 CFR Part 15 Subpart E	No non-compliance noted

We hereby certify that:

Compliance Certification Services Inc. tested the above equipment. The test data, data evaluation, test procedures, and equipment configurations shown in this report were made in accordance with the procedures given in ANSI C63.4: 2003 and the energy emitted by the sample EUT tested as described in this report is in compliance with conducted and radiated emission limits of FCC Rules Part 15.407.

The test results of this report relate only to the tested sample identified in this report.

Approved by:

Reviewed by:

Rex Lai
Section Manager
Compliance Certification Services Inc.

Gina Lo
Section Manager
Compliance Certification Services Inc.



2. EUT DESCRIPTION

Product	450Mbps Dual Band Wireless N 4-Port Media Bridge		
Trade Name	TRENDnet		
Model Number	TEW-680MB		
Model Discrepancy	N/A		
Received Date	July 5, 2011		
Power Supply	Power Adapter Bestec / EA0121WAA I/P: 100-240V, 50-60Hz, 0.5A O/P: 12V, 1A, 12W		
Operating Frequency Range & Number of Channels		Mode	Frequency Range (MHz)
	UNII Band I	IEEE 802.11a	5180 – 5240
		IEEE 802.11n HT 20 MHz mode	5180 – 5240
		IEEE 802.11n HT 40 MHz mode	5190 ~ 5230
Transmit Power	IEEE 802.11a mode / 5180 ~ 5240MHz: 12.97 dBm IEEE 802.11n HT 20 MHz mode / 5180 ~ 5240MHz: 11.52 dBm IEEE 802.11n HT 40 MHz mode / 5190 ~ 5230MHz: 12.80 dBm		
Modulation Technique	OFDM (QPSK, BPSK, 16-QAM, 64-QAM)		
Transmit Data Rate	IEEE 802.11a mode: OFDM IEEE 802.11n HT 20 MHz mode: OFDM IEEE 802.11n HT 40 MHz mode: OFDM		
Antenna Specification	PCB Antenna / Gain: 1 dBi MIMO Mode: Total ANT= $10 * \text{LOG}(((10^{(\text{ANT0}/20)} + 10^{(\text{ANT1}/20)})^2) + 10^{(\text{ANT2}/20)})^2 / 3)$ 5.725~5.850 GHz: 5.77 dBi (Numeric gain: 3.78)		

Operation Frequency

UNLICENSED NATIONAL INFORMATION INFRASTRUCTURE (U-NII)	
CHANNEL	MHz
36	5180
38	5190
40	5200
46	5230
48	5240

Remark:

1. The sample selected for test was production product and was provided by manufacturer.
2. This submittal(s) (test report) is intended for FCC ID: **XU8TEW680MB** filing to comply with Section 15.207, 15.209 and 15.247 of the FCC Part 15, Subpart C Rules.



3. TEST METHODOLOGY

Both conducted and radiated testing was performed according to the procedures in ANSI C63.4. Radiated testing was performed at an antenna to EUT distance 3 meters.

3.1 EUT CONFIGURATION

The EUT configuration for testing is installed for RF field strength measurement to meet the Commissions requirement, and is operated in a manner intended to generate the maximum emission in a continuous normal application.

3.2 EUT EXERCISE

The EUT is operated in the engineering mode to fix the Tx frequency for the purposes of measurement.

According to its specifications, the EUT must comply with the requirements of Section 15.407 under the FCC Rules Part 15 Subpart E.

3.3 GENERAL TEST PROCEDURES

Conducted Emissions

The EUT is placed on the turntable, which is positioned at 0.8 m above the ground plane. According to the requirements in Section 13.1.4.1 of ANSI C63.4, the conducted emission from the EUT is measured in the frequency range between 0.15 MHz and 30MHz, using the CISPR Quasi-Peak detector mode.

Radiated Emissions

The EUT is placed on the turntable, which is 0.8 m above the ground plane. The turntable is then rotated for 360 degrees to determine the proper orientation for the maximum emission level. The EUT is set 3m away from the receiving antenna, which is varied from 1m to 4m to find out the highest emission level. And, each emission is to be maximized by changing the horizontal and vertical polarization of the receiving antenna. In order to find out the maximum emissions, exploratory radiated emission measurements were made according to the requirements in Section 13.1.4.1 of ANSI C63.4.



3.4 FCC PART 15.205 RESTRICTED BANDS OF OPERATIONS

(a) Except as shown in paragraph (d) of this section, only spurious emissions are permitted in any of the frequency bands listed below:

MHz	MHz	MHz	GHz
0.090 - 0.110	16.42 - 16.423	399.9 - 410	4.5 - 5.15
¹ 0.495 - 0.505	16.69475 - 16.69525	608 - 614	5.35 - 5.46
2.1735 - 2.1905	16.80425 - 16.80475	960 - 1240	7.25 - 7.75
4.125 - 4.128	25.5 - 25.67	1300 - 1427	8.025 - 8.5
4.17725 - 4.17775	37.5 - 38.25	1435 - 1626.5	9.0 - 9.2
4.20725 - 4.20775	73 - 74.6	1645.5 - 1646.5	9.3 - 9.5
6.215 - 6.218	74.8 - 75.2	1660 - 1710	10.6 - 12.7
6.26775 - 6.26825	108 - 121.94	1718.8 - 1722.2	13.25 - 13.4
6.31175 - 6.31225	123 - 138	2200 - 2300	14.47 - 14.5
8.291 - 8.294	149.9 - 150.05	2310 - 2390	15.35 - 16.2
8.362 - 8.366	156.52475 -	2483.5 - 2500	17.7 - 21.4
8.37625 - 8.38675	156.52525	2655 - 2900	22.01 - 23.12
8.41425 - 8.41475	156.7 - 156.9	3260 - 3267	23.6 - 24.0
12.29 - 12.293	162.0125 - 167.17	3332 - 3339	31.2 - 31.8
12.51975 - 12.52025	167.72 - 173.2	3345.8 - 3358	36.43 - 36.5
12.57675 - 12.57725	240 - 285	3600 - 4400	(²)
13.36 - 13.41	322 - 335.4		

¹ Until February 1, 1999, this restricted band shall be 0.490-0.510 MHz.

² Above 38.6

(b) Except as provided in paragraphs (d) and (e), the field strength of emissions appearing within these frequency bands shall not exceed the limits shown in Section 15.209. At frequencies equal to or less than 1000 MHz, compliance with the limits in Section 15.209 shall be demonstrated using measurement instrumentation employing a CISPR quasi-peak detector. Above 1000 MHz, compliance with the emission limits in Section 15.209 shall be demonstrated based on the average value of the measured emissions. The provisions in Section 15.35 apply to these measurements.



3.5 DESCRIPTION OF TEST MODES

The EUT (model: TEW-680MB) had been tested under operating condition.

The EUT is a 3x3 configuration spatial MIMO (3Tx & 3Rx) without beam forming function that operate in triple TX chains and triple RX chains. The 3x3 configuration is implemented with three outside TX & RX chains (Chain 0, Chain 1 and Chain 2).

Software used to control the EUT for staying in continuous transmitting mode was programmed.

After verification, all tests were carried out with the worst case test modes as shown below except radiated spurious emission below 1GHz and power line conducted emissions below 30MHz, which worst case was in normal link mode only.

IEEE 802.11a mode / 5180 ~ 5240MHz:

Channel Low (5180MHz), Channel Mid (5220MHz) and Channel High (5240MHz) with 6Mbps data rate were chosen for full testing.

IEEE 802.11n HT 20 MHz mode / 5180 ~ 5240MHz:

Channel Low (5180MHz), Channel Mid (5220MHz) and Channel High (5240MHz) with 6.5Mbps data rate were chosen for full testing.

IEEE 802.11n HT 40 MHz mode / 5190 ~ 5230MHz:

Channel Low (5190MHz) and Channel High (5230MHz) with 13.5Mbps data rate were chosen for full testing.



4. INSTRUMENT CALIBRATION

4.1 MEASURING INSTRUMENT CALIBRATION

The measuring equipment, which was utilized in performing the tests documented herein, has been calibrated in accordance with the manufacturer's recommendations for utilizing calibration equipment, which is traceable to recognized national standards.

4.2 MEASUREMENT EQUIPMENT USED

Equipment Used for Emissions Measurement

Remark: Each piece of equipment is scheduled for calibration once a year and Loop Antenna is scheduled for calibration once three years.

Conducted Emissions Test Site				
Name of Equipment	Manufacturer	Model	Serial Number	Calibration Due
Spectrum Analyzer	Agilent	E4446A	MY43360131	03/02/2012

Wugu 966 Chamber A				
Name of Equipment	Manufacturer	Model	Serial Number	Calibration Due
Spectrum Analyzer	Agilent	E4446A	US42510252	11/03/2011
EMI Test Receiver	R&S	ESCI	100064	02/03/2012
Pre-Amplifier	Mini-Circuits	ZFL-1000LN	SF350700823	01/12/2012
Pre-Amplifier	MITEQ	AFS44-00102650-42-10P-44	1415367	11/19/2011
Bilog Antenna	Sunol Sciences	JB3	A030105	10/06/2011
Horn Antenna	EMCO	3117	00055165	01/12/2012
Turn Table	CCS	CC-T-1F	N/A	N.C.R
Antenna Tower	CCS	CC-A-1F	N/A	N.C.R
Controller	CCS	CC-C-1F	N/A	N.C.R
Site NSA	CCS	N/A	N/A	12/26/2011
Site NSA	CCS	N/A	N/A	12/26/2011
Test S/W	EZ-EMC (CCS-3A1RE)			

Conducted Emission room # A				
Name of Equipment	Manufacturer	Model	Serial Number	Calibration Due
EMI Test Receiver	R&S	ESHS10	843743/015	05/01/2012
LISN	SCHWARZBECK	NSLK 8127	8127-541	12/18/2011
LISN	SCHAFFNER	NNB 41	03/10013	N.C.R.
Test S/W	CCS-3A1-CE			



4.3 MEASUREMENT UNCERTAINTY

PARAMETER	UNCERTAINTY
Powerline Conducted Emission	+/- 1.6202
3M Semi Anechoic Chamber / 30M~200M	+/- 4.0606
3M Semi Anechoic Chamber / 200M~1000M	+/- 3.9979
3M Semi Anechoic Chamber / 1G~8G	+/- 2.5790
3M Semi Anechoic Chamber / 8G~18G	+/- 2.5928
3M Semi Anechoic Chamber / 18G~26G	+/- 2.7212
3M Semi Anechoic Chamber / 26G~40G	+/- 2.9520

Remark: This uncertainty represents an expanded uncertainty expressed at approximately the 95% confidence level using a coverage factor of $k=2$.



5. FACILITIES AND ACCREDITATIONS

5.1 FACILITIES

All measurement facilities used to collect the measurement data are located at

- No.199, Chungshen Road, Hsintien City, Taipei Hsien, Taiwan, R.O.C.
Tel: 886-2-2217-0894 / Fax: 886-2-2217-1029
- No.11, Wu-Gong 6th Rd., Wugu Industrial Park, New Taipei City 248, Taiwan (R.O.C.)
Tel: 886-2-2299-9720 / Fax: 886-2-2298-4045
- No.81-1, Lane 210, Bade 2nd Rd., Lujhu Township, Taoyuan County 33841, TAIWAN, R.O.C.
Tel: 886-3-324-0332 / Fax: 886-3-324-5235

The sites are constructed in conformance with the requirements of ANSI C63.7, ANSI C63.4 and CISPR Publication 22.

5.2 EQUIPMENT

Radiated emissions are measured with one or more of the following types of linearly polarized antennas: tuned dipole, biconical, log periodic, bi-log, and/or ridged waveguide, horn. Spectrum analyzers with pre-selectors and quasi-peak detectors are used to perform radiated measurements.



Conducted emissions are measured with Line Impedance Stabilization Networks and EMI Test Receivers.

Calibrated wideband preamplifiers, coaxial cables, and coaxial attenuators are also used for making measurements.

All receiving equipment conforms to CISPR Publication 16-1, "Radio Interference Measuring Apparatus and Measurement Methods."



5.3 TABLE OF ACCREDITATIONS AND LISTINGS

Country	Agency	Scope of Accreditation	Logo
USA	FCC	3M Semi Anechoic Chamber (FCC MRA: TW1039) to perform FCC Part 15 measurements	 FCC MRA: TW1039
Taiwan	TAF	LP0002, RTTE01, FCC Method-47 CFR Part 15 Subpart C, D, E, RSS-210, RSS-310 IDA TS SRD, AS/NZS 4268, AS/NZS 4771, TS 12.1 & 12.2, ETSI EN 300 440-1, ETSI EN 300 440-2, ETSI EN 300 328, ETSI EN 300 220-1, ETSI EN 300 220-2, ETSI EN 301 893, ETSI EN 301 489-1/3/7/17 FCC OET Bulletin 65 + Supplement C, EN 50360, EN 50361, EN 50371, RSS 102, EN 50383, EN 50385, EN 50392, IEC 62209, CNS 14958-1, CNS 14959 FCC Method -47 CFR Part 15 Subpart B IEC / EN 61000-3-2, IEC / EN 61000-3-3, IEC / EN 61000-4-2/3/4/5/6/8/11	
Canada	Industry Canada	3M Semi Anechoic Chamber (IC 2324G-1 / IC 2324G-2) to perform	

* No part of this report may be used to claim or imply product endorsement by A2LA or any agency of the US Government.



6. SETUP OF EQUIPMENT UNDER TEST

6.1 SETUP CONFIGURATION OF EUT

See test photographs attached in Appendix II for the actual connections between EUT and support equipment.

6.2 SUPPORT EQUIPMENT

No	Equipment	Brand	Model	Series No.	FCC ID	Data Cable	Power Cord
1	Wireless Pre-N Router (MIMO) (Remote)	BELKIN	F5D8230-4	N/A	SA3-AGN0901AP 0100	N/A	AC I/P: Unshielded, 1.8m DC O/P: Unshielded, 1.8m with a core
2	Notebook PC (Remote)	HP	dv6-1332TX	CNF9491GLJ	PD9112BNHU	N/A	AC I/P: Unshielded, 1.8m DC O/P: Unshielded, 1.8m with a core

Remark:

1. All the equipment/cables were placed in the worst-case configuration to maximize the emission during the test.
2. Grounding was established in accordance with the manufacturer's requirements and conditions for the intended use.



7. FCC PART 15 REQUIREMENTS

7.1 26 DB EMISSION BANDWIDTH

LIMIT

According to §15.303(c), for purposes of this subpart the emission bandwidth shall be determined by measuring the width of the signal between two points, one below the carrier center frequency and one above the carrier center frequency, that are 26 dB down relative to the maximum level of the modulated carrier. Compliance with the emissions limits is based on the use of measurement instrumentation employing a peak detector function with an instrument resolutions bandwidth approximately equal to 1.0 percent of the emission bandwidth of the device under measurement.

Test Configuration

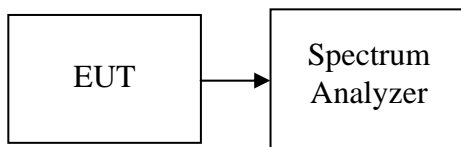

TEST PROCEDURE

1. Place the EUT on the table and set it in the transmitting mode.
2. Remove the antenna from the EUT and then connect a low-loss RF cable from the antenna port to the spectrum analyzer.
3. Set the spectrum analyzer as RBW > 1%EBW, VBW > RBW, Span >26dB bandwidth, and Sweep = auto.
4. Mark the peak frequency and -26dB (upper and lower) frequency.
5. Repeat until all the rest channels were investigated.



TEST RESULTS

No non-compliance noted

Test Data

Test mode: IEEE 802.11a mode / 5180 ~ 5240MHz

Channel	Frequency (MHz)	Bandwidth (MHz)
Low	5180	20.378
Mid	5220	20.668
High	5240	19.137

Test mode: IEEE 802.11n HT 20 MHz mode / 5180 ~ 5240MHz / Chain 0

Channel	Frequency (MHz)	Bandwidth (MHz)
Low	5180	19.601
Mid	5220	19.517
High	5240	19.571

Test mode: IEEE 802.11n HT 20 MHz mode / 5180 ~ 5240MHz / Chain 1

Channel	Frequency (MHz)	Bandwidth (MHz)
Low	5180	19.486
Mid	5220	19.401
High	5240	19.410

Test mode: IEEE 802.11n HT 20 MHz mode / 5180 ~ 5240MHz / Chain 2

Channel	Frequency (MHz)	Bandwidth (MHz)
Low	5180	19.589
Mid	5220	19.454
High	5240	19.632

Test mode: IEEE 802.11n HT 40 MHz mode / 5190 ~ 5230MHz / Chain 0

Channel	Frequency (MHz)	Bandwidth (MHz)
Low	5190	39.632
High	5230	39.464

Test mode: IEEE 802.11n HT 40 MHz mode / 5190 ~ 5230MHz / Chain 1

Channel	Frequency (MHz)	Bandwidth (MHz)
Low	5190	39.065
High	5230	38.922

Test mode: IEEE 802.11n HT 40 MHz mode / 5190 ~ 5230MHz / Chain 2

Channel	Frequency (MHz)	Bandwidth (MHz)
Low	5190	39.664
High	5230	39.691



Test Plot

IEEE 802.11a mode / 5180 ~ 5240MHz

CH Low

Agilent 16:40:52 Jul 20, 2011

R T

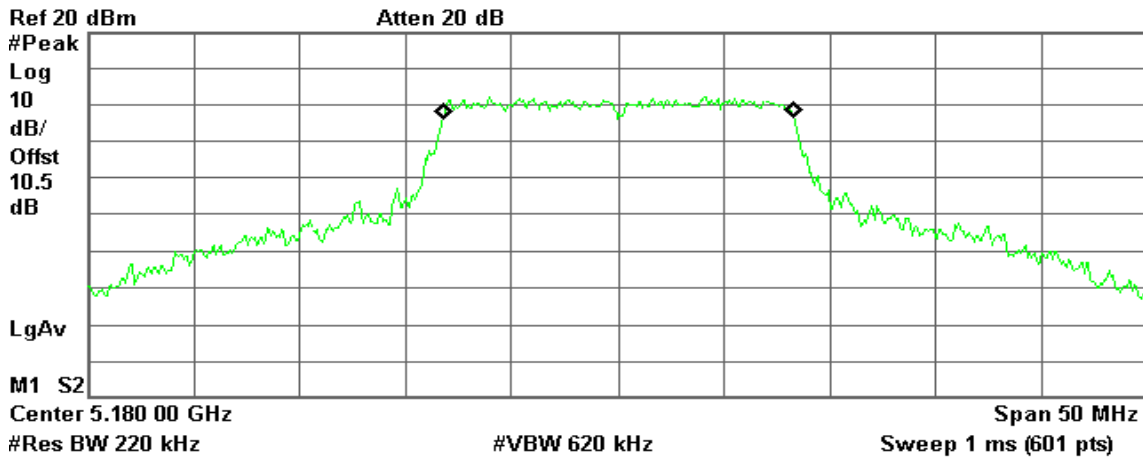

Occupied Bandwidth
16.4792 MHz

Occ BW % Pwr 99.00 %
x dB -26.00 dB

Transmit Freq Error 51.534 kHz
x dB Bandwidth 20.378 MHz

CH Mid

Agilent 16:46:33 Jul 20, 2011

R T

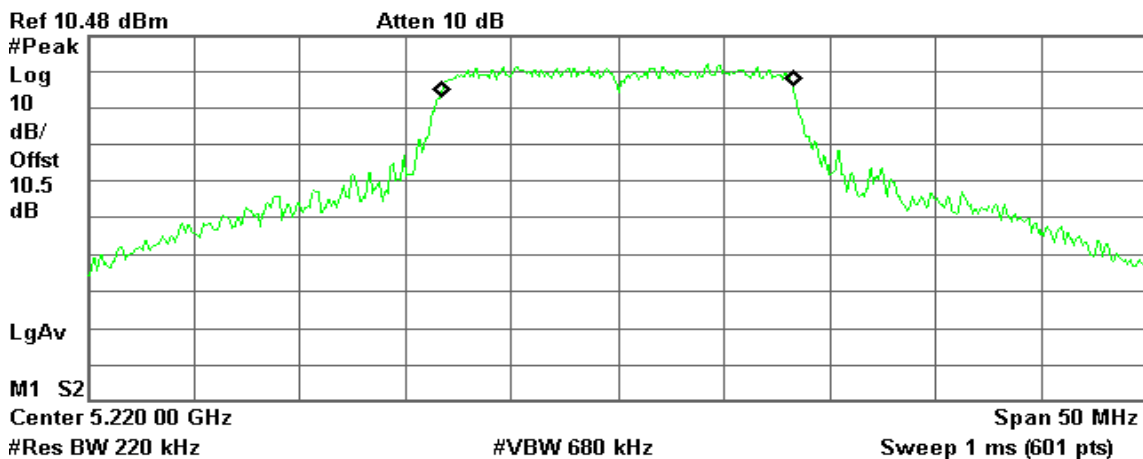

Occupied Bandwidth
16.5290 MHz

Occ BW % Pwr 99.00 %
x dB -26.00 dB

Transmit Freq Error -16.536 kHz
x dB Bandwidth 20.668 MHz



CH High

* Agilent 16:49:18 Jul 20, 2011

R T

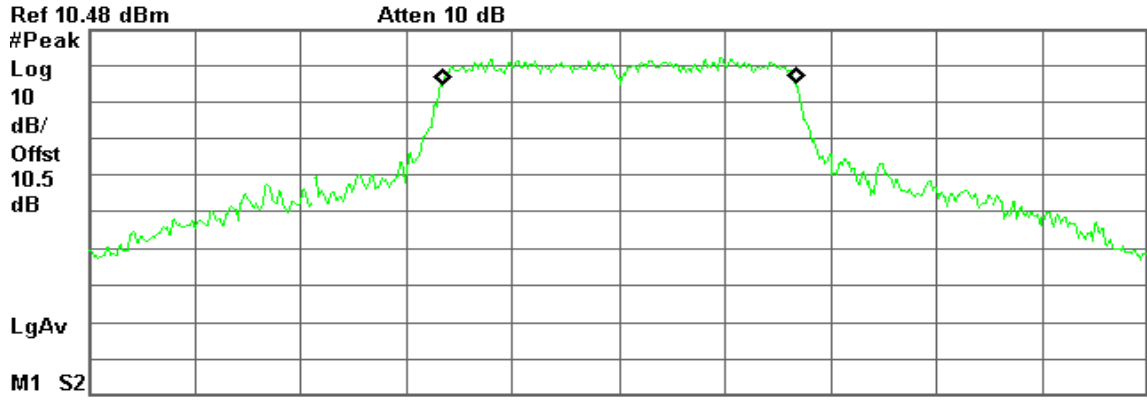

Center 5.240 00 GHz #VBW 680 kHz Span 50 MHz
#Res BW 220 kHz Sweep 1 ms (601 pts)

Occupied Bandwidth
16.5718 MHz

Occ BW % Pwr 99.00 %
x dB -26.00 dB

Transmit Freq Error 11.310 kHz
x dB Bandwidth 19.137 MHz



IEEE 802.11n HT 20 MHz mode / 5180 ~ 5240MHz / Chain 0

CH Low

Agilent 17:47:13 Jul 20, 2011

R T

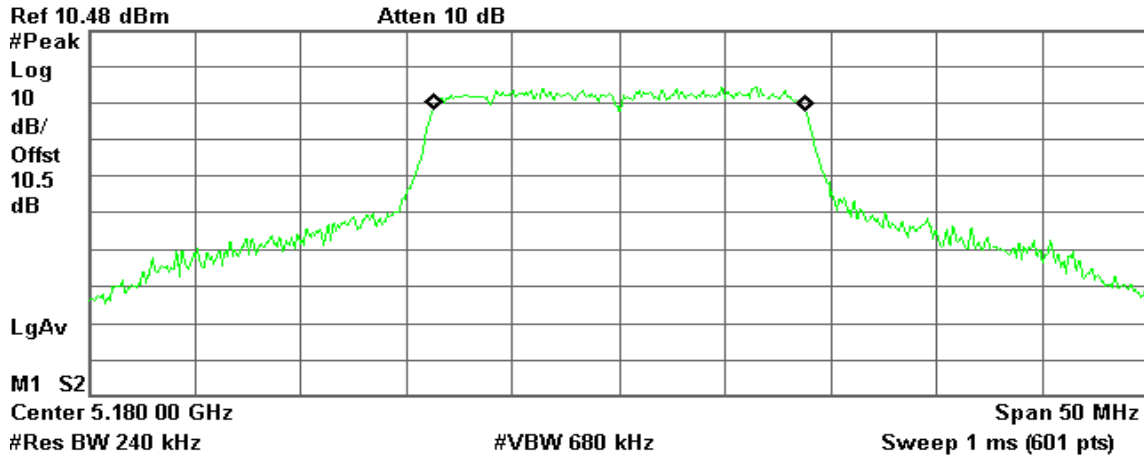

Occupied Bandwidth
17.4647 MHz

Occ BW % Pwr 99.00 %
x dB -26.00 dB

Transmit Freq Error 27.850 kHz
x dB Bandwidth 19.601 MHz

CH Mid

Agilent 17:51:13 Jul 20, 2011

R T

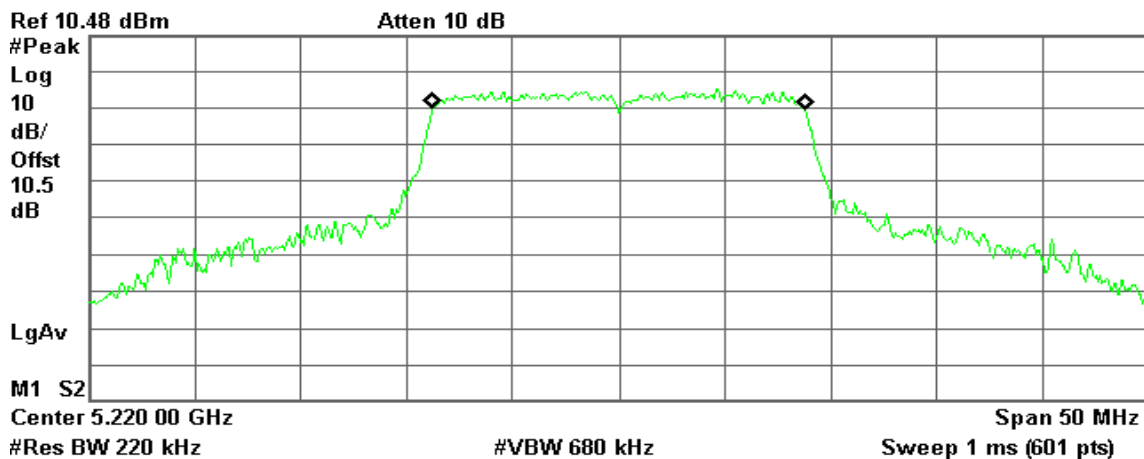

Occupied Bandwidth
17.4776 MHz

Occ BW % Pwr 99.00 %
x dB -26.00 dB

Transmit Freq Error 24.574 kHz
x dB Bandwidth 19.517 MHz



CH High

Agilent 18:08:37 Jul 20, 2011

R T

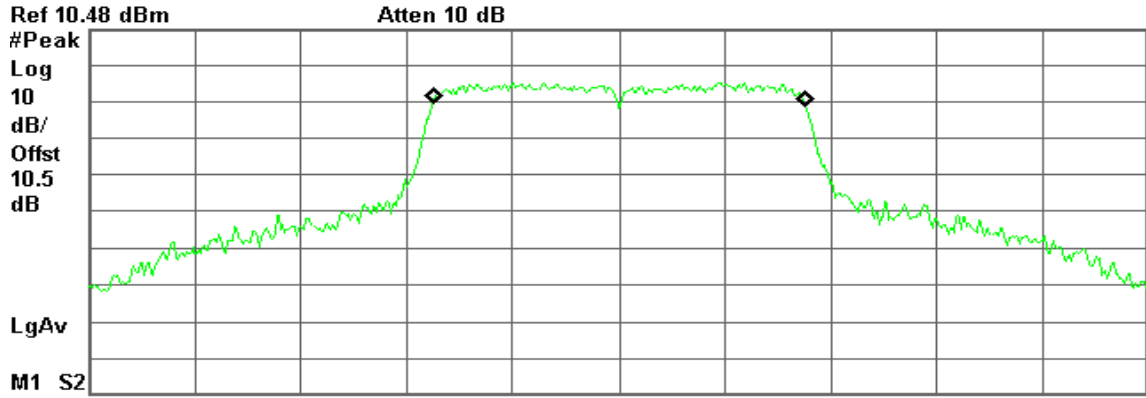

Occupied Bandwidth
17.4454 MHz

Occ BW % Pwr 99.00 %
x dB -26.00 dB

Transmit Freq Error 20.908 kHz
x dB Bandwidth 19.571 MHz



IEEE 802.11n HT 20 MHz mode / 5180 ~ 5240MHz / Chain 1

CH Low

Agilent 18:18:38 Jul 20, 2011

R T

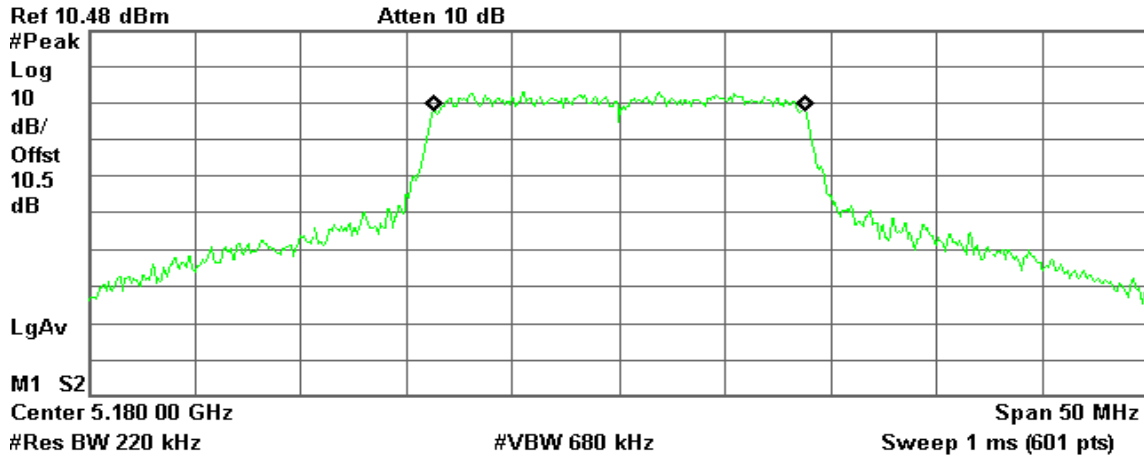

Occupied Bandwidth
17.4727 MHz

Occ BW % Pwr 99.00 %
x dB -26.00 dB

Transmit Freq Error 37.791 kHz
x dB Bandwidth 19.486 MHz

CH Mid

Agilent 18:16:01 Jul 20, 2011

R T

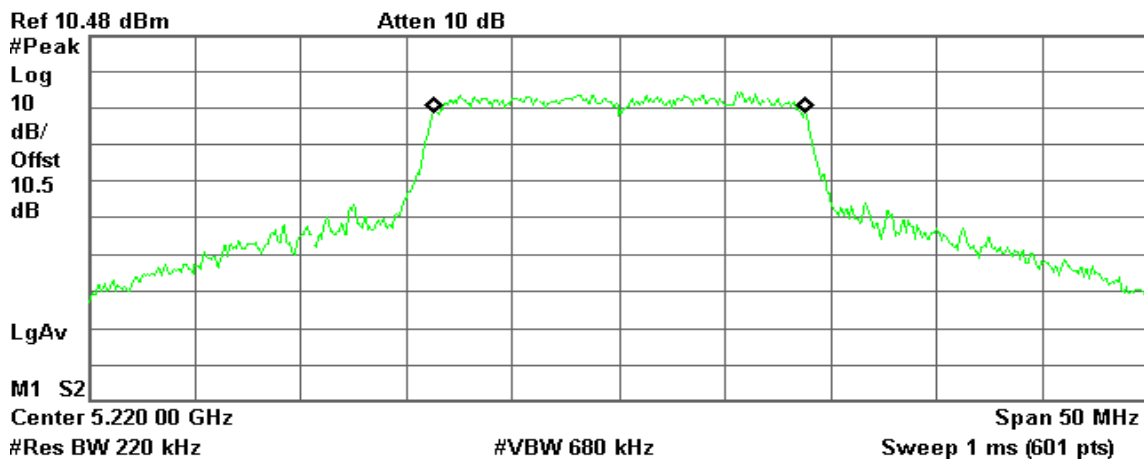

Occupied Bandwidth
17.4626 MHz

Occ BW % Pwr 99.00 %
x dB -26.00 dB

Transmit Freq Error 42.364 kHz
x dB Bandwidth 19.401 MHz



CH High

Agilent 18:13:05 Jul 20, 2011

R L

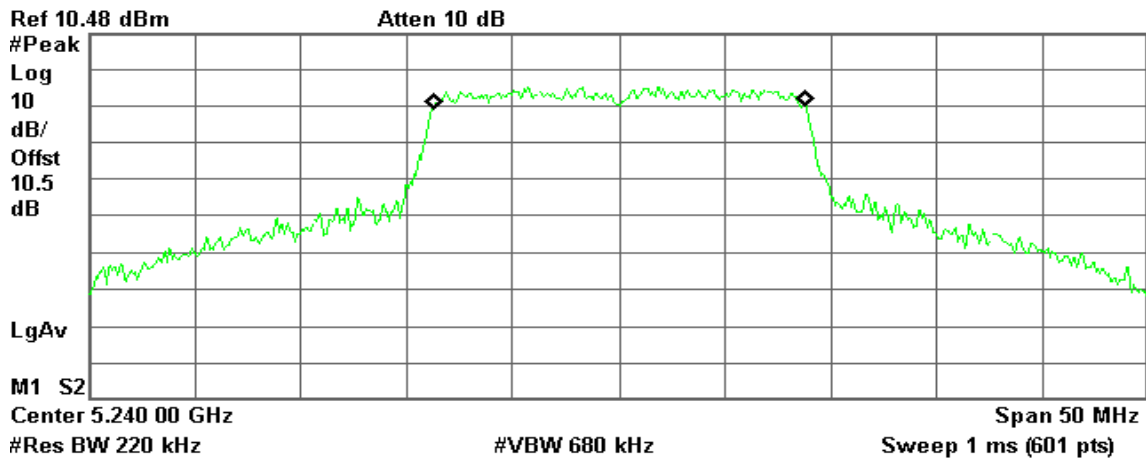

Occupied Bandwidth
17.4903 MHz

Occ BW % Pwr 99.00 %
x dB -26.00 dB

Transmit Freq Error 41.549 kHz
x dB Bandwidth 19.410 MHz



IEEE 802.11n HT 20 MHz mode / 5180 ~ 5240MHz / Chain 2

CH Low

Agilent 18:43:22 Jul 20, 2011

R T

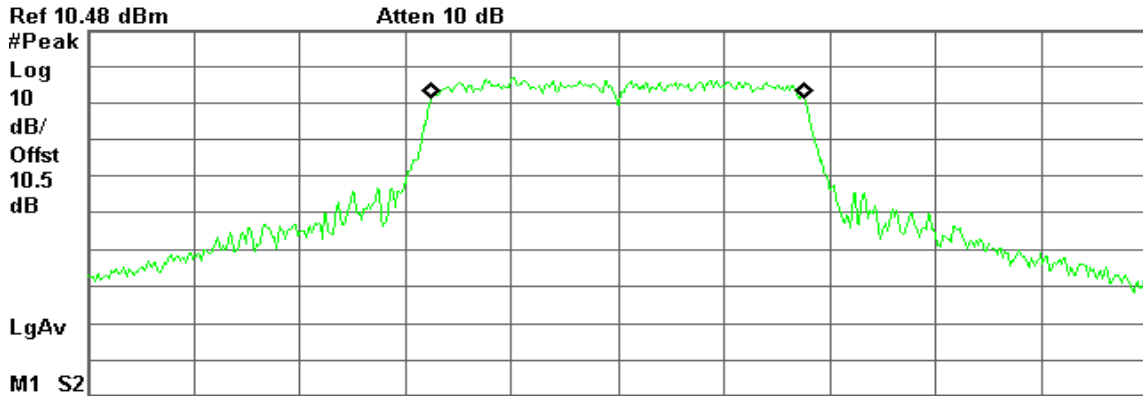

Center 5.180 00 GHz Span 50 MHz
#Res BW 240 kHz #VBW 680 kHz Sweep 1 ms (601 pts)

Occupied Bandwidth
17.4991 MHz

Occ BW % Pwr 99.00 %
x dB -26.00 dB

Transmit Freq Error 24.084 kHz
x dB Bandwidth 19.589 MHz

CH Mid

Agilent 18:49:53 Jul 20, 2011

R T

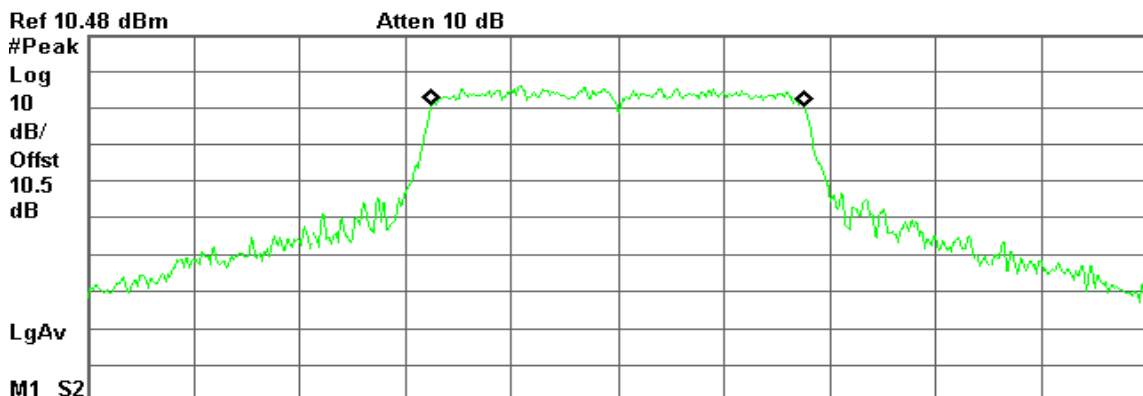

Center 5.220 00 GHz Span 50 MHz
#Res BW 220 kHz #VBW 680 kHz Sweep 1 ms (601 pts)

Occupied Bandwidth
17.5066 MHz

Occ BW % Pwr 99.00 %
x dB -26.00 dB

Transmit Freq Error 36.609 kHz
x dB Bandwidth 19.454 MHz



CH High

Agilent 18:54:22 Jul 20, 2011

R L

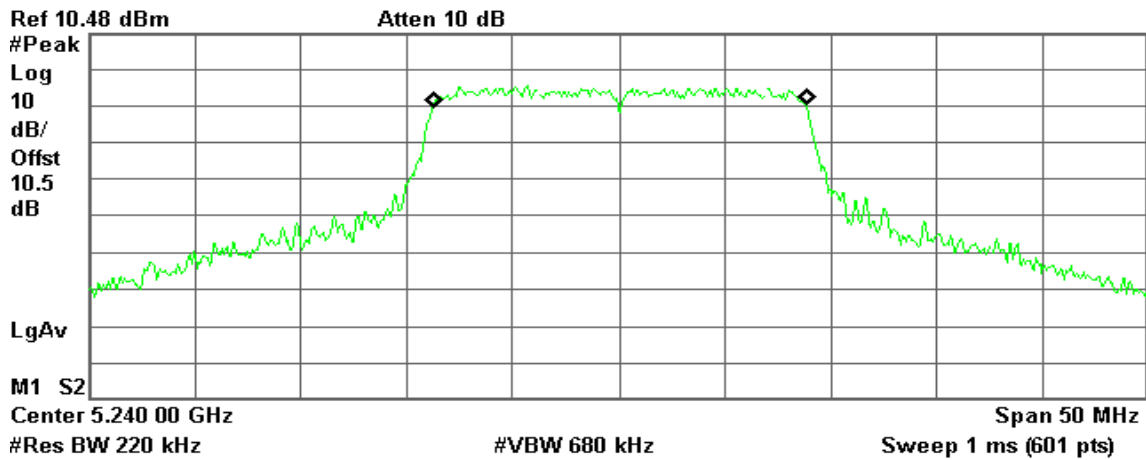

Occupied Bandwidth
17.4999 MHz

Occ BW % Pwr 99.00 %
x dB -26.00 dB

Transmit Freq Error 50.194 kHz
x dB Bandwidth 19.632 MHz



IEEE 802.11n HT 40 MHz mode / 5190 ~ 5230MHz / Chain 0

CH Low

Agilent 12:17:16 Jul 21, 2011

R T

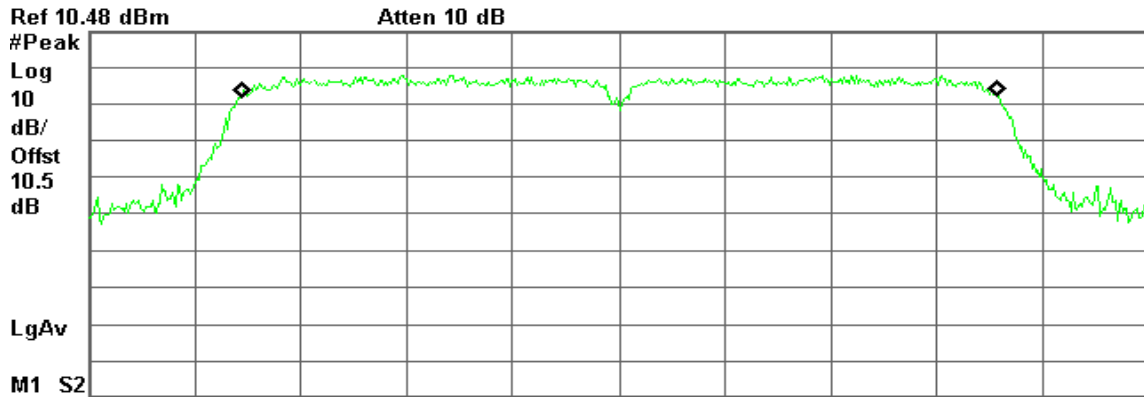

Center 5.190 00 GHz Span 50 MHz
#Res BW 470 kHz #VBW 1.3 MHz Sweep 1 ms (601 pts)

Occupied Bandwidth
35.6143 MHz

Occ BW % Pwr 99.00 %
x dB -26.00 dB

Transmit Freq Error 23.081 kHz
x dB Bandwidth 39.632 MHz

CH High

Agilent 12:20:12 Jul 21, 2011

R L

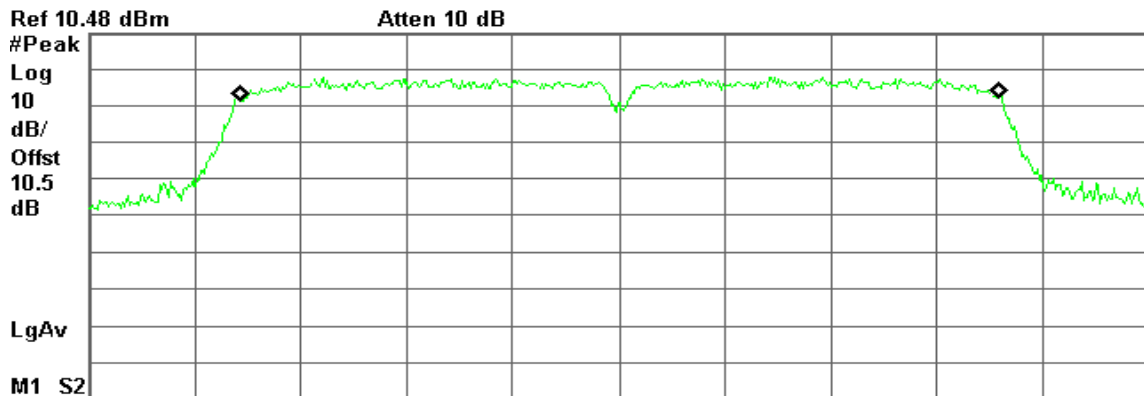

Center 5.230 00 GHz Span 50 MHz
#Res BW 470 kHz #VBW 1.3 MHz Sweep 1 ms (601 pts)

Occupied Bandwidth
35.7709 MHz

Occ BW % Pwr 99.00 %
x dB -26.00 dB

Transmit Freq Error 29.007 kHz
x dB Bandwidth 39.464 MHz



IEEE 802.11n HT 40 MHz mode / 5190 ~ 5230MHz / Chain 1

CH Low

Agilent 12:13:55 Jul 21, 2011

R L

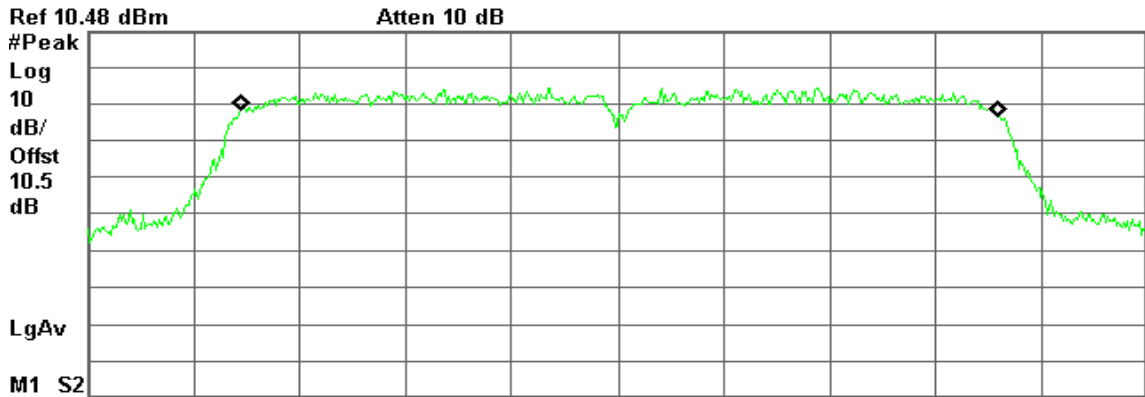

Center 5.190 00 GHz Span 50 MHz
#Res BW 470 kHz #VBW 1.3 MHz Sweep 1 ms (601 pts)

Occupied Bandwidth
35.6770 MHz

Occ BW % Pwr 99.00 %
x dB -26.00 dB

Transmit Freq Error 53.746 kHz
x dB Bandwidth 39.065 MHz

CH High

Agilent 12:11:27 Jul 21, 2011

R L

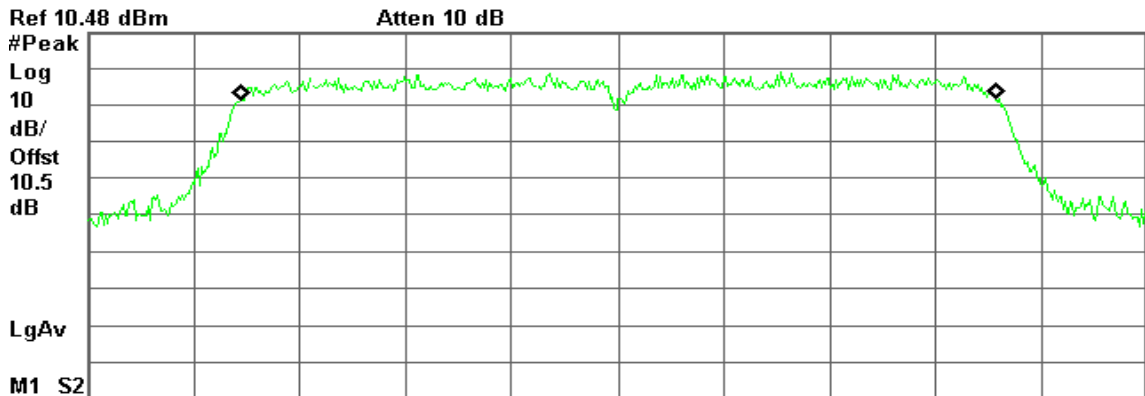

Center 5.230 00 GHz Span 50 MHz
#Res BW 470 kHz #VBW 1.3 MHz Sweep 1 ms (601 pts)

Occupied Bandwidth
35.5530 MHz

Occ BW % Pwr 99.00 %
x dB -26.00 dB

Transmit Freq Error 65.000 kHz
x dB Bandwidth 38.922 MHz



IEEE 802.11n HT 40 MHz mode / 5190 ~ 5230MHz / Chain 2

CH Low

Agilent 11:46:06 Jul 21, 2011

R L

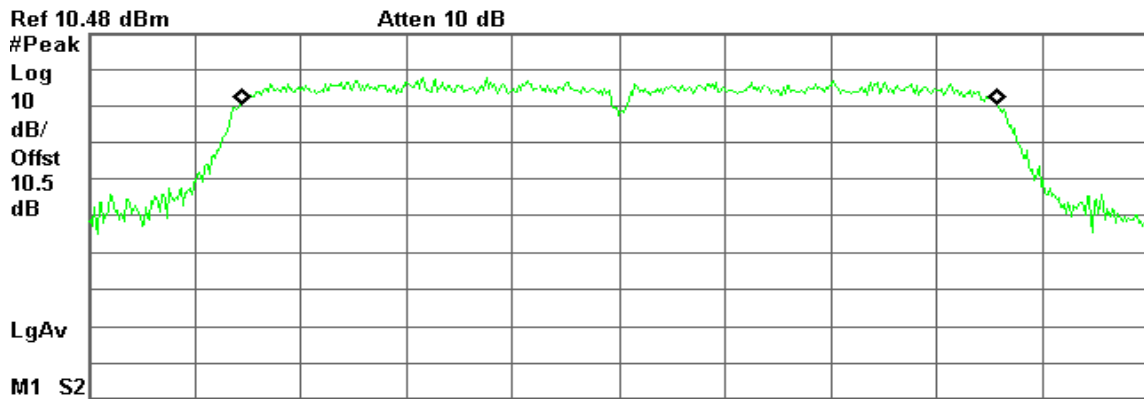

M1 S2
 Center 5.190 00 GHz Span 50 MHz
 #Res BW 470 kHz #VBW 1.3 MHz Sweep 1 ms (601 pts)

Occupied Bandwidth
35.6195 MHz

Occ BW % Pwr 99.00 %
 x dB -26.00 dB

Transmit Freq Error 19.295 kHz
 x dB Bandwidth 39.664 MHz

CH High

Agilent 11:50:34 Jul 21, 2011

R T

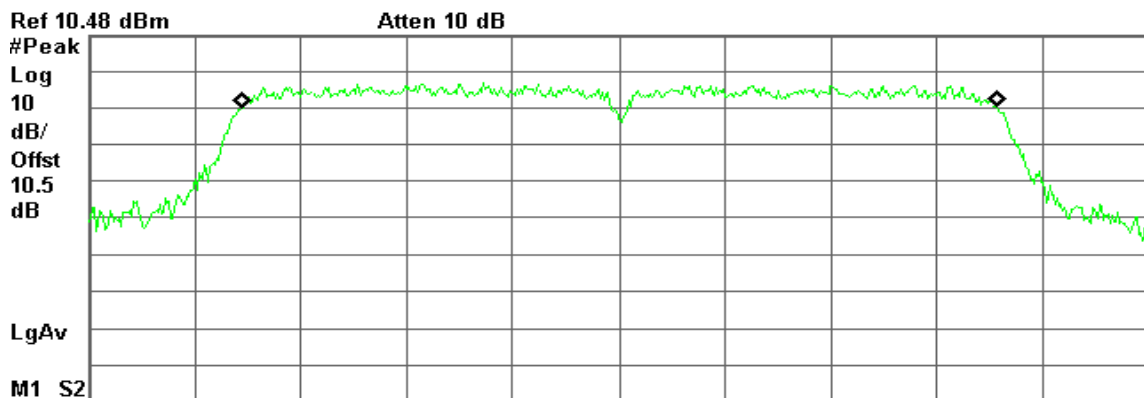

M1 S2
 Center 5.230 00 GHz Span 50 MHz
 #Res BW 470 kHz #VBW 1.3 MHz Sweep 1 ms (601 pts)

Occupied Bandwidth
35.5635 MHz

Occ BW % Pwr 99.00 %
 x dB -26.00 dB

Transmit Freq Error 26.172 kHz
 x dB Bandwidth 39.691 MHz



7.2 PEAK POWER

LIMIT

According to §15.407(a),

- (1) For the band 5.15-5.25 GHz, the maximum conducted output power over the frequency band of operation shall not exceed the lesser of 50 mW or $4 \text{ dBm} + 10 \log B$, where B is the 26 dB emission bandwidth in MHz.
- (2) For the 5.25-5.35 GHz and 5.47-5.725 GHz bands, the maximum conducted output power over the frequency bands of operation shall not exceed the lesser of 250 mW or $11 \text{ dBm} + 10 \log B$, where B is the 26 dB emission bandwidth in MHz.

If transmitting antennas of directional gain greater than 6dBi are used, both the peak transmit power and the peak power spectral density shall be reduced by the amount in dB that the directional gain of the antenna exceeds 6dBi.

The peak power shall not exceed the limit as follow:

Specified Limit of the Peak Power

Test mode: IEEE 802.11a mode / 5180 ~ 5240MHz

Channel	Frequency (MHz)	26 dB Bandwidth (B) (MHz)	10 Log B (dB)	4 + 10 Log B (dBm)	Maximum Conducted Output Power Limit (dBm)
Low	5180	20.378	13.09	17.09	17.00
Mid	5220	20.668	13.15	17.15	17.00
High	5240	19.137	12.82	16.82	17.00

Test mode: IEEE 802.11n HT 20 MHz mode / 5180 ~ 5240MHz

Channel	Frequency (MHz)	Chain 0 26 dB Bandwidth (B) (MHz)	Chain 1 26 dB Bandwidth (B) (MHz)	Chain 2 26 dB Bandwidth (B) (MHz)	10 Log B (dB)	4 + 10 Log B (dBm)	Maximum Conducted Output Power Limit (dBm)
Low	5180	19.601	19.486	19.589	12.92	16.92	17.00
Mid	5220	19.517	19.401	19.454	12.90	16.90	17.00
High	5240	19.571	19.41	19.632	12.93	16.93	17.00

Test mode: IEEE 802.11n HT 40 MHz mode / 5190 ~ 5230MHz

Channel	Frequency (MHz)	Chain 0 26 dB Bandwidth (B) (MHz)	Chain 1 26 dB Bandwidth (B) (MHz)	Chain 2 26 dB Bandwidth (B) (MHz)	10 Log B (dB)	4 + 10 Log B (dBm)	Maximum Conducted Output Power Limit (dBm)
Low	5190	39.632	39.065	39.664	15.98	19.98	17.00
High	5230	39.464	38.922	39.691	15.99	19.99	17.00



Test Configuration

The EUT was connected to a spectrum analyzer through a 50Ω RF cable.

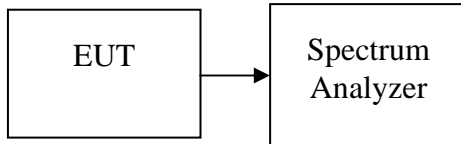

TEST PROCEDURE

Set span to encompass the entire emission bandwidth (EBW) of the signal.

Set RBW = 1 MHz / Set VBW = 3 MHz.

Use sample detector mode if bin width (i.e., span/number of points in spectrum display) < 0.5 RBW. Otherwise use peak detector mode. Use a video trigger with the trigger level set to enable triggering only on full power pulses. Transmitter must operate at full control power for entire sweep of every sweep. If the device transmits continuously, with no off intervals or reduced power intervals, the trigger may be set to “free run”. Trace average 100 traces in power averaging mode. Compute power by integrating the spectrum across the 26 dB EBW of the signal. The integration can be performed using the spectrum analyzer’s band power measurement function with band limits set equal to the EBW band edges or by summing power levels in each 1 MHz band in linear power terms. The 1 MHz band power levels to be summed can be obtained by averaging, in linear power terms, power levels in each frequency bin across the 1 MHz.

TEST RESULTS

No non-compliance noted

**Test Data****Test mode: IEEE 802.11a mode / 5180 ~ 5240MHz**

Channel	Frequency (MHz)	Maximum Conducted Output Power (dBm)	Limit (dBm)
Low	5180	12.15	17.00
Mid	5220	12.31	17.00
High	5240	12.97	17.00

Test mode: IEEE 802.11n HT 20 MHz mode / 5180 ~ 5240MHz

Channel	Frequency (MHz)	Chain 0 Output Power (dBm)	Chain 1 Output Power (dBm)	Chain 2 Output Power (dBm)	Total Maximum Conducted Output Power (dBm)	Limit (dBm)
Low	5180	5.33	3.78	7.39	10.52	17.00
Mid	5220	6.47	5.73	7.07	11.23	17.00
High	5240	6.70	6.82	6.74	11.52	17.00

Test mode: IEEE 802.11n HT 40 MHz mode / 5190 ~ 5230MHz

Channel	Frequency (MHz)	Chain 0 Output Power (dBm)	Chain 1 Output Power (dBm)	Chain 2 Output Power (dBm)	Total Maximum Conducted Output Power (dBm)	Limit (dBm)
Low	5190	8.96	3.91	7.61	12.07	19.98
High	5230	8.53	8.50	6.86	12.80	19.99

Remark:

1. Total Output Power (w) = Chain 0 ($10^{(\text{Output Power} / 10) / 1000}$) + Chain 1 ($10^{(\text{Output Power} / 10) / 1000}$) + Chain 2 ($10^{(\text{Output Power} / 10) / 1000}$)



Test Plot

IEEE 802.11a mode / 5180 ~ 5240MHz

CH Low

Agilent 16:41:51 Jul 20, 2011

R T

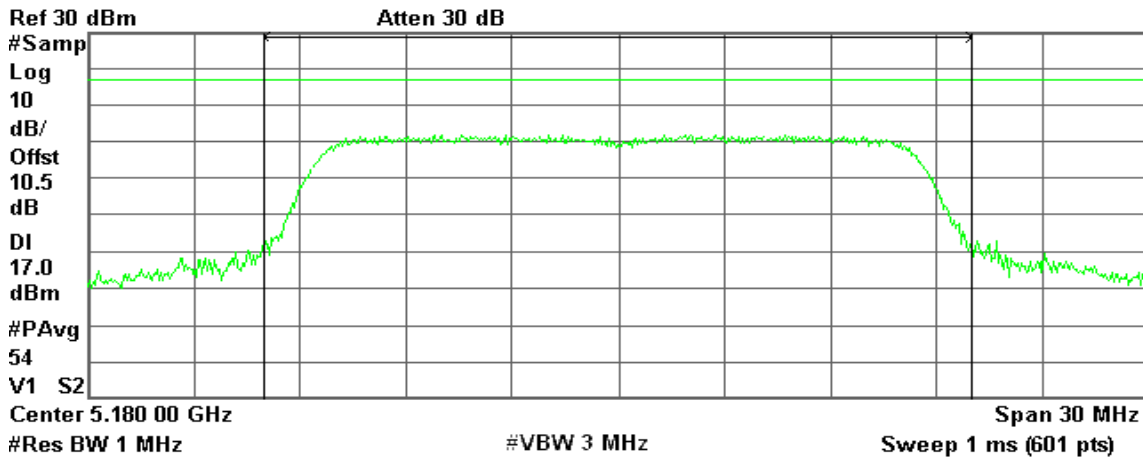

Channel Power

12.15 dBm / 20.0000 MHz

Power Spectral Density

-60.86 dBm/Hz

CH Mid

Agilent 16:47:02 Jul 20, 2011

R T

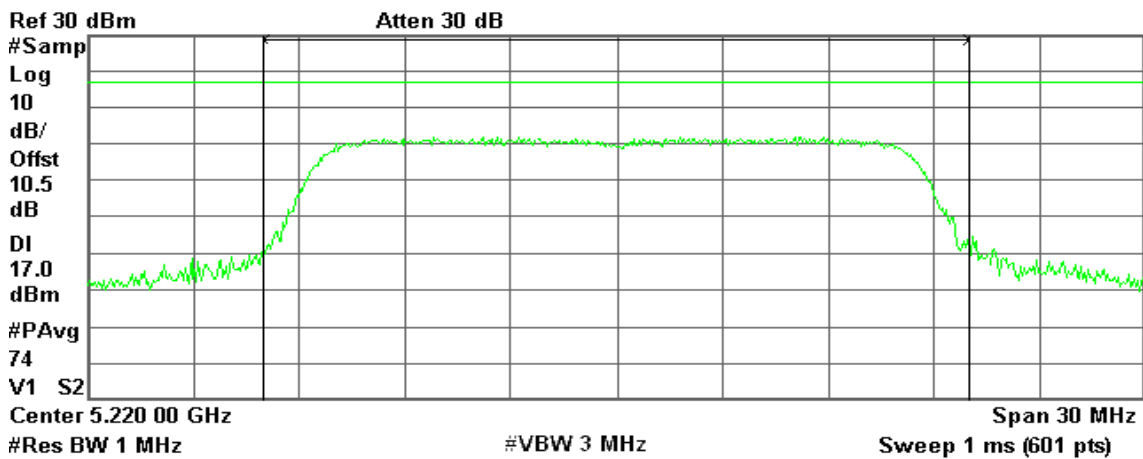

Channel Power

12.31 dBm / 20.0000 MHz

Power Spectral Density

-60.70 dBm/Hz



CH High

Agilent 16:50:12 Jul 20, 2011

R T

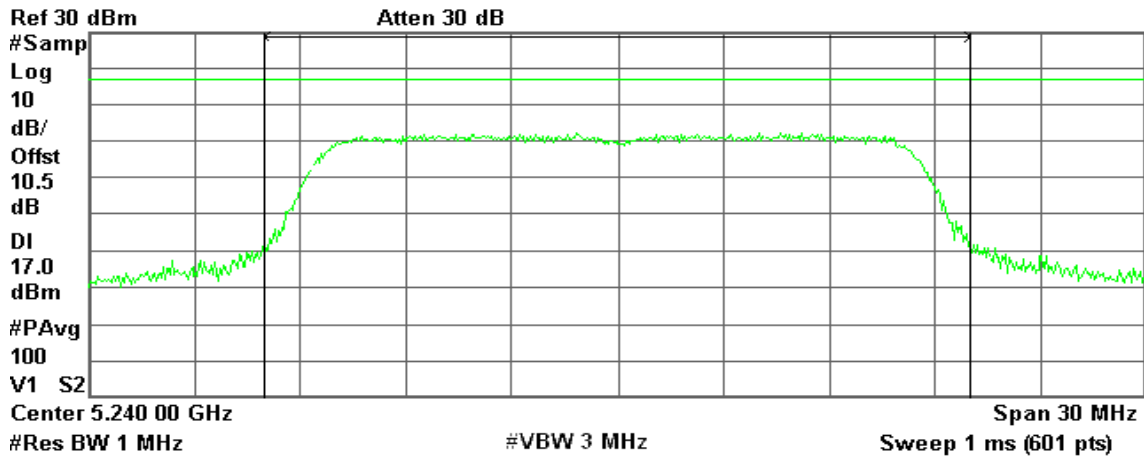

Channel Power

12.97 dBm / 20.0000 MHz

Power Spectral Density

-60.04 dBm/Hz



IEEE 802.11n HT 20 MHz mode / 5180 ~ 5240MHz / Chain 0

CH Low

Agilent 17:48:26 Jul 20, 2011

R T

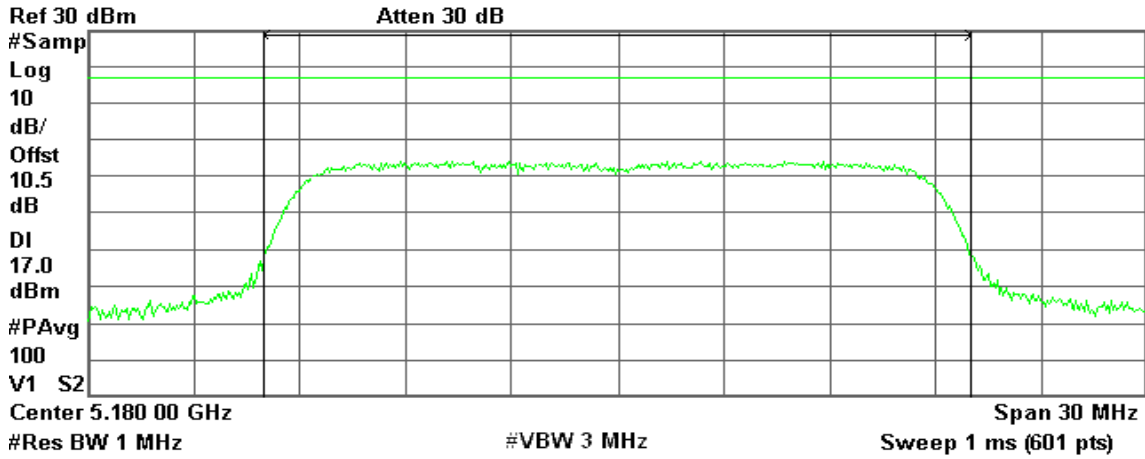

Channel Power

5.33 dBm / 20.0000 MHz

Power Spectral Density

-67.68 dBm/Hz

CH Mid

Agilent 17:54:13 Jul 20, 2011

R T

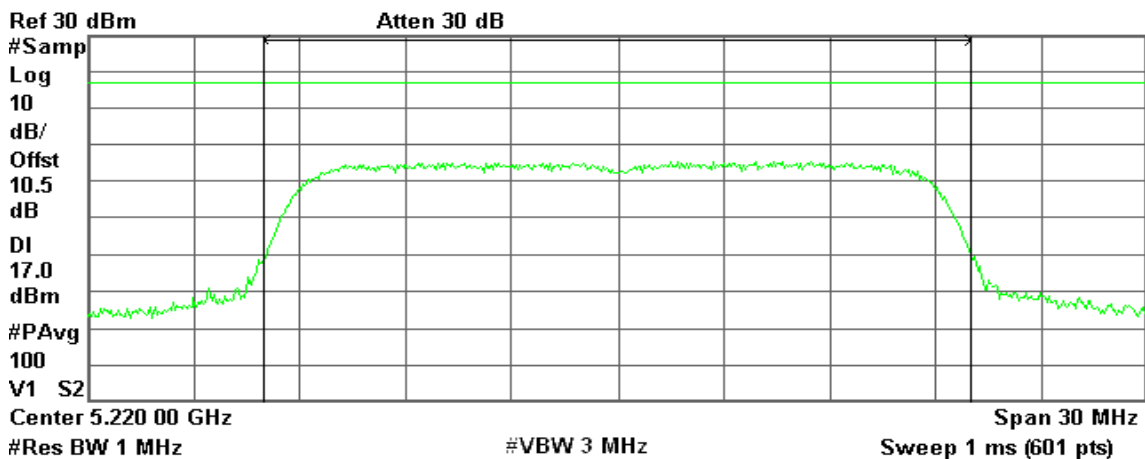

Channel Power

6.47 dBm / 20.0000 MHz

Power Spectral Density

-66.54 dBm/Hz



CH High

Agilent 18:09:00 Jul 20, 2011

R L

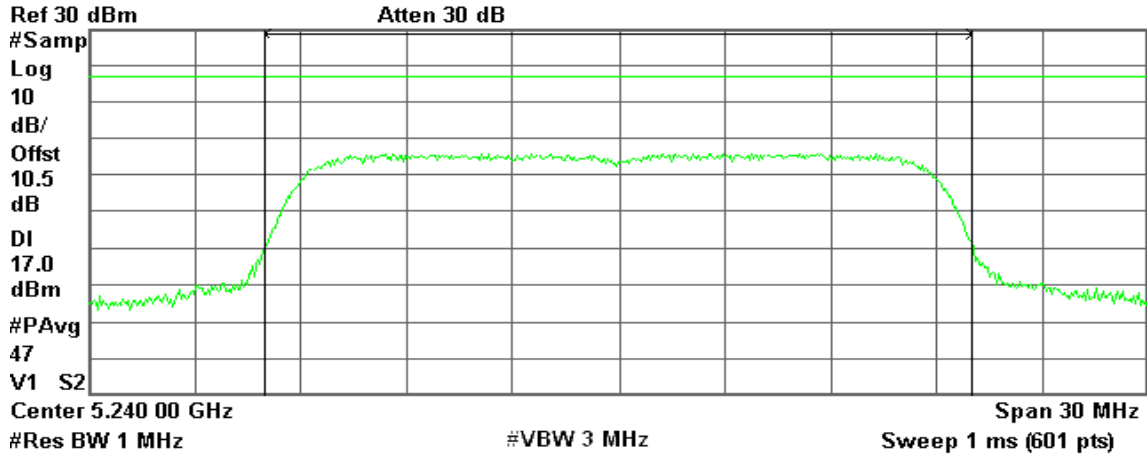

Channel Power

6.70 dBm /20.0000 MHz

Power Spectral Density

-66.31 dBm/Hz



IEEE 802.11n HT 20 MHz mode / 5180 ~ 5240MHz / Chain 1

CH Low

* Agilent 18:19:08 Jul 20, 2011

R T

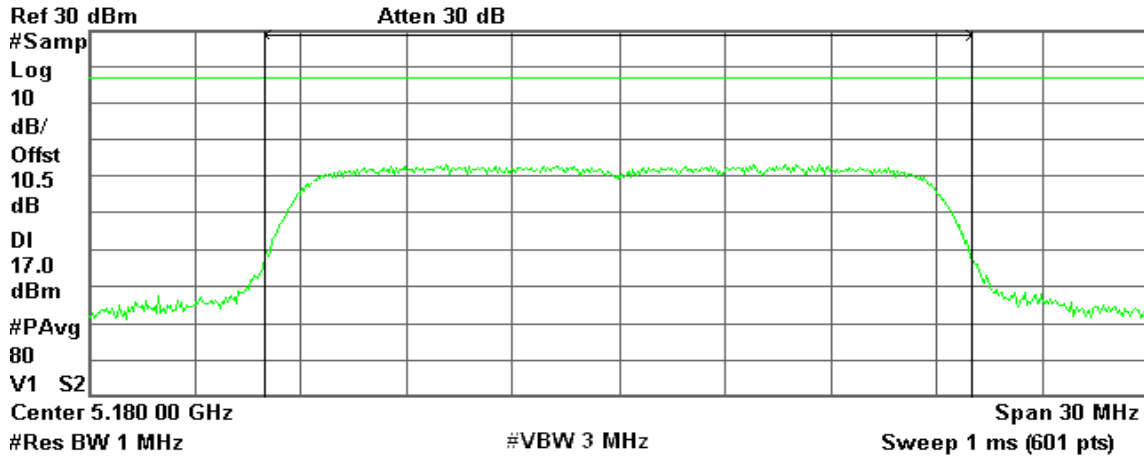

Channel Power

3.78 dBm / 20.0000 MHz

Power Spectral Density

-69.23 dBm/Hz

CH Mid

* Agilent 18:16:21 Jul 20, 2011

R T

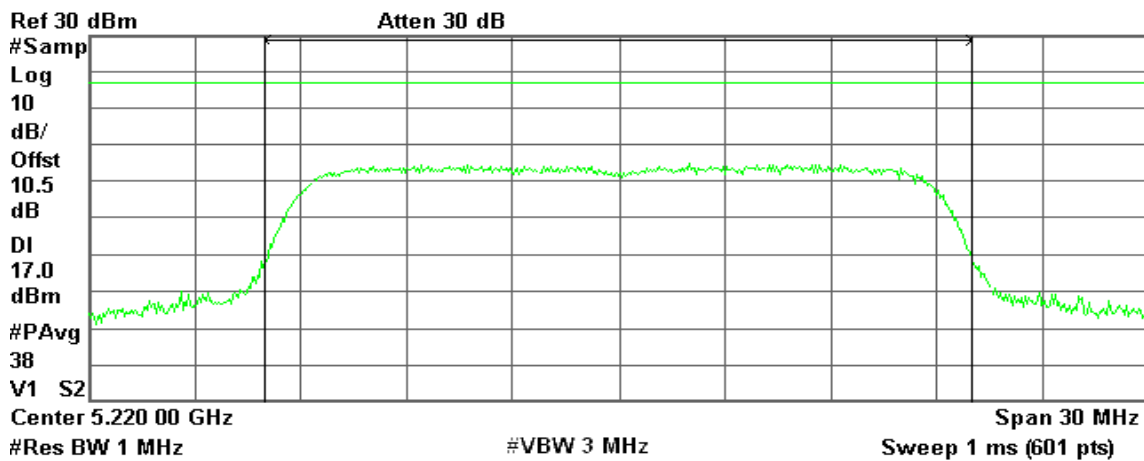

Channel Power

5.73 dBm / 20.0000 MHz

Power Spectral Density

-67.28 dBm/Hz



CH High

Agilent 18:13:26 Jul 20, 2011

R T

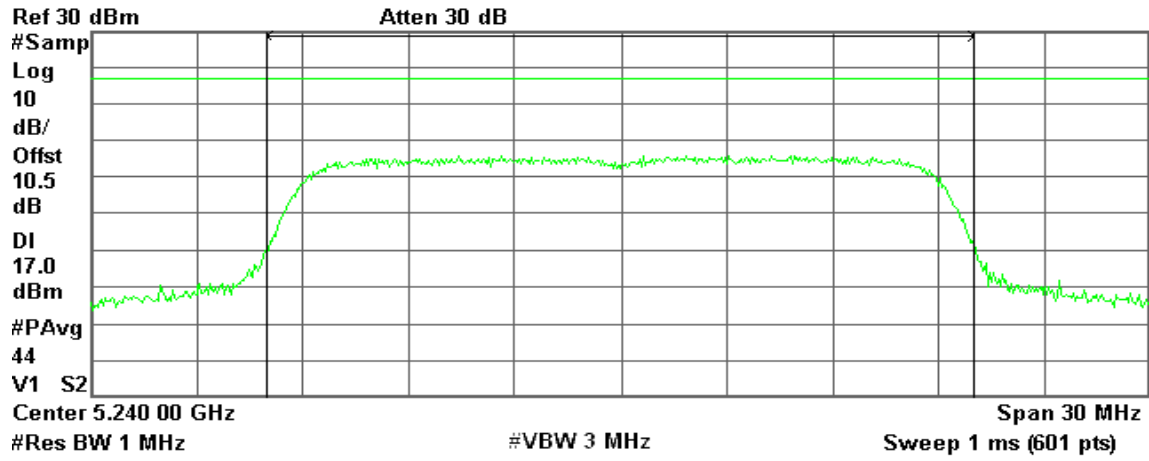

Channel Power

6.82 dBm / 20.0000 MHz

Power Spectral Density

-66.19 dBm/Hz



IEEE 802.11n HT 20 MHz mode / 5180 ~ 5240MHz / Chain 2

CH Low

Agilent 18:45:18 Jul 20, 2011

R L

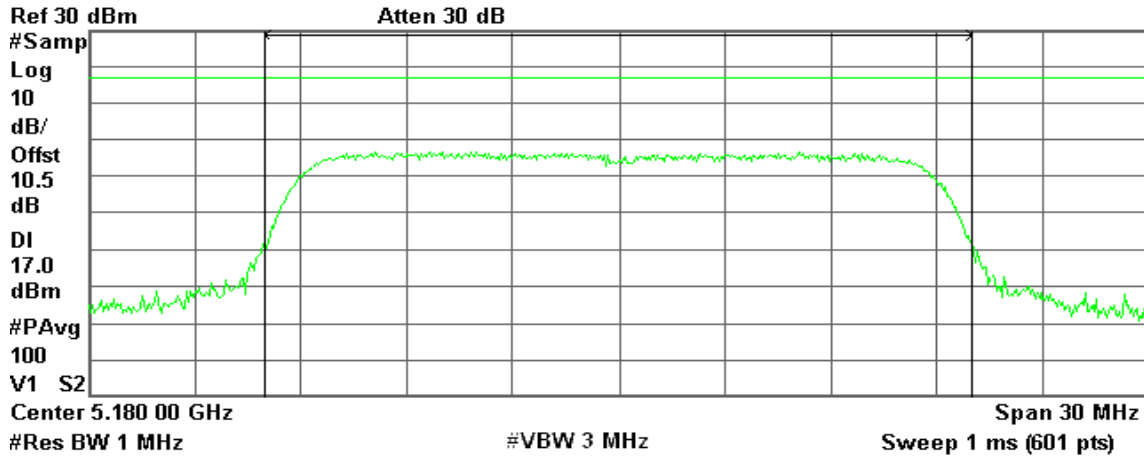

Channel Power

7.39 dBm /20.0000 MHz

Power Spectral Density

-65.62 dBm/Hz

CH Mid

Agilent 18:50:26 Jul 20, 2011

R L

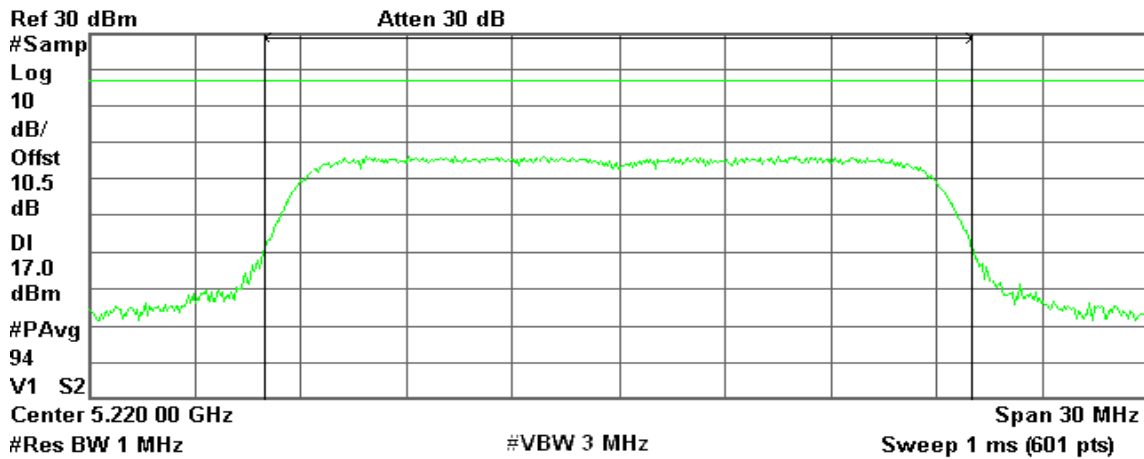

Channel Power

7.07 dBm /20.0000 MHz

Power Spectral Density

-65.94 dBm/Hz



CH High

Agilent 18:54:53 Jul 20, 2011

R L T

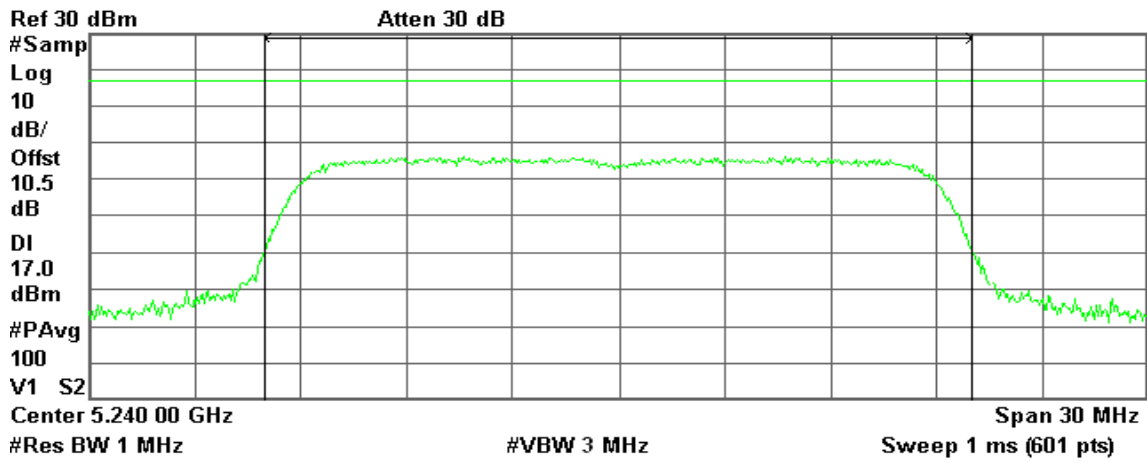

Channel Power

6.74 dBm / 20.0000 MHz

Power Spectral Density

-66.28 dBm/Hz



IEEE 802.11n HT 40 MHz mode / 5190 ~ 5230MHz / Chain 0

CH Low

Agilent 12:17:39 Jul 21, 2011

R T

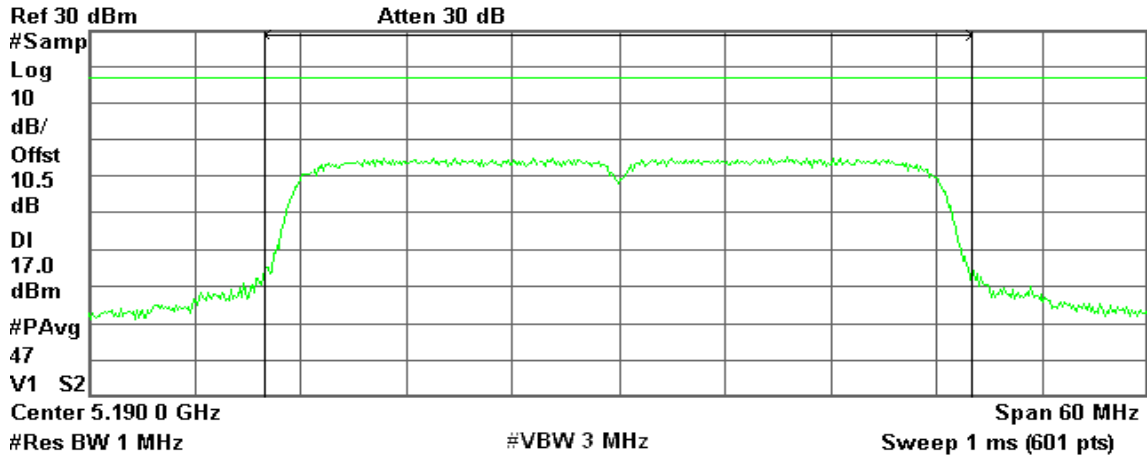

Channel Power

8.96 dBm / 40.0000 MHz

Power Spectral Density

-67.06 dBm/Hz

CH High

Agilent 12:20:34 Jul 21, 2011

R T

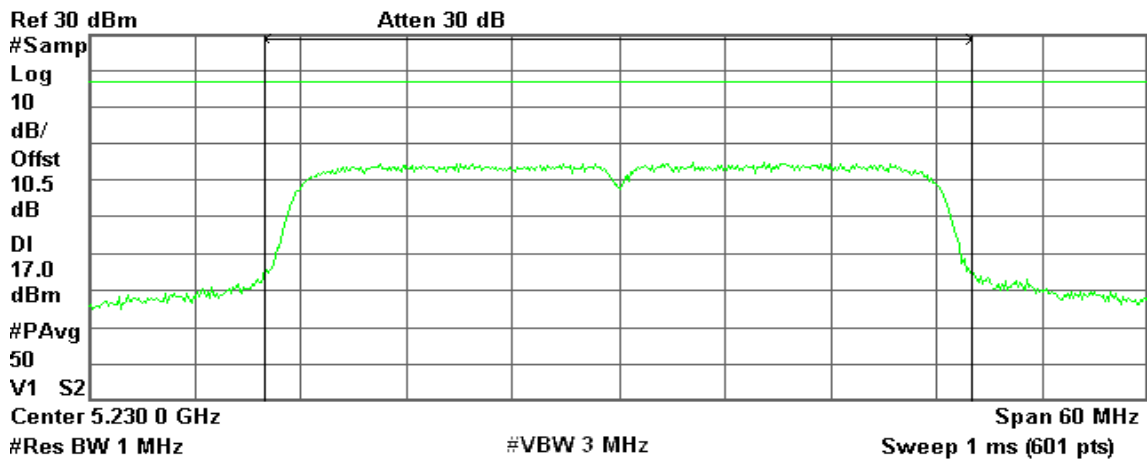

Channel Power

8.53 dBm / 40.0000 MHz

Power Spectral Density

-67.49 dBm/Hz



IEEE 802.11n HT 40 MHz mode / 5190 ~ 5230MHz / Chain 1

CH Low

Agilent 12:14:17 Jul 21, 2011

R T

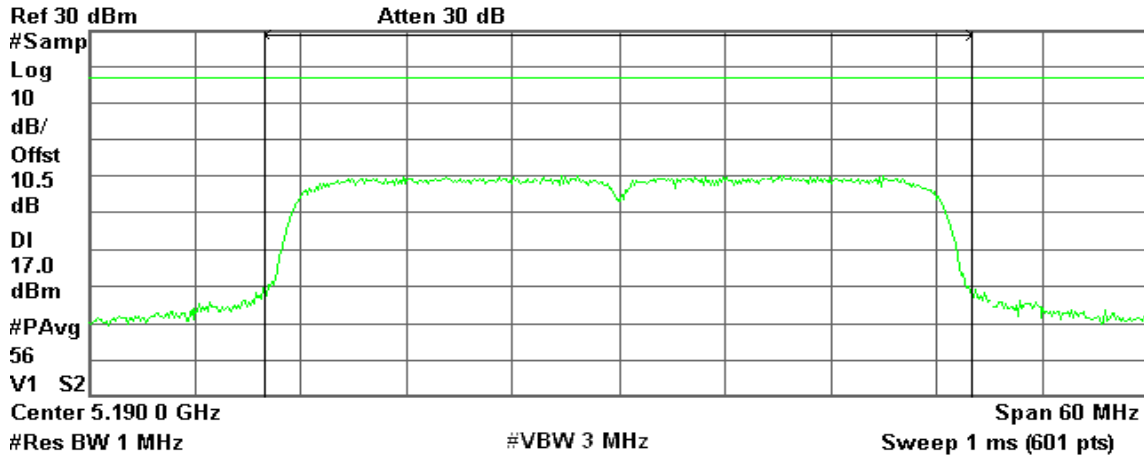

Channel Power

Power Spectral Density

3.91 dBm / 40.0000 MHz

-72.11 dBm/Hz

CH High

Agilent 12:11:48 Jul 21, 2011

R T

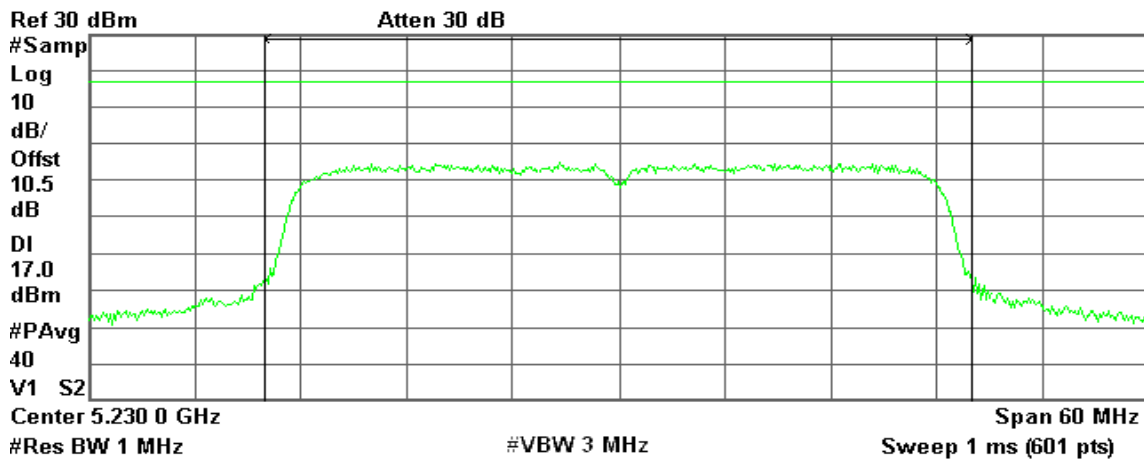

Channel Power

Power Spectral Density

8.50 dBm / 40.0000 MHz

-67.52 dBm/Hz



IEEE 802.11n HT 40 MHz mode / 5190 ~ 5230MHz / Chain 2

CH Low

Agilent 11:47:47 Jul 21, 2011

R T

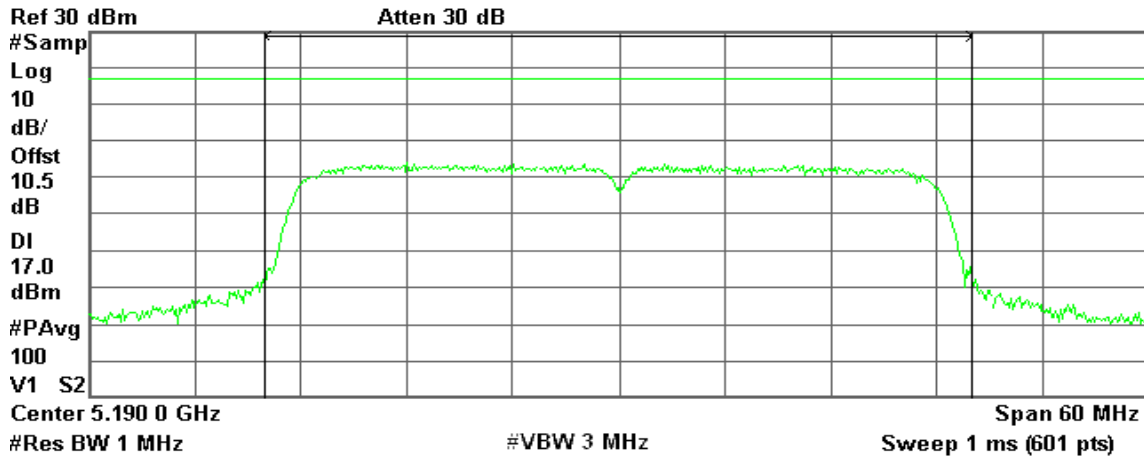

Channel Power

7.61 dBm / 40.0000 MHz

Power Spectral Density

-68.41 dBm/Hz

CH High

Agilent 12:07:15 Jul 21, 2011

R T

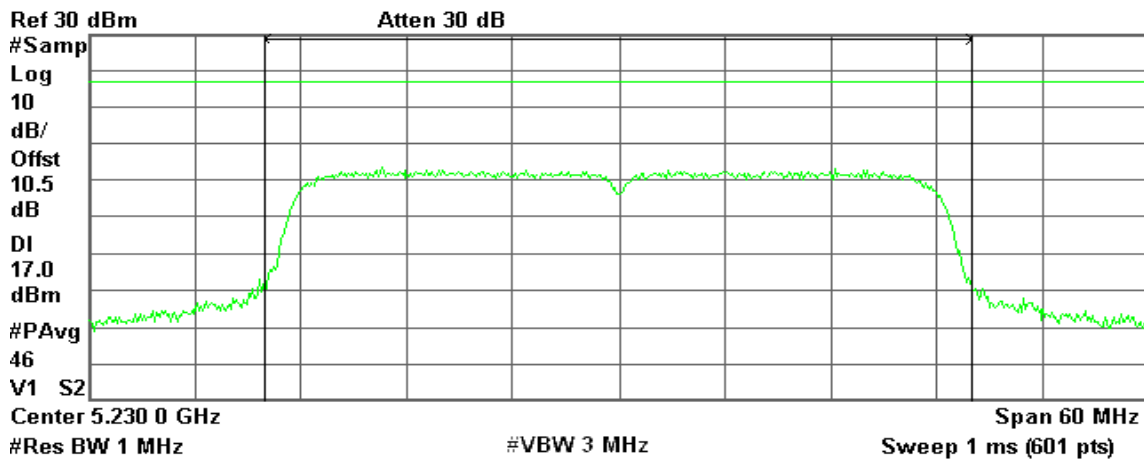

Channel Power

6.86 dBm / 40.0000 MHz

Power Spectral Density

-69.16 dBm/Hz



7.3 BAND EDGES MEASUREMENT

LIMIT

According to §15.407(b),

- (1) The provisions of Section 15.205 of this part apply to intentional radiators operating under this section.
- (2) When measuring the emission limits, the nominal carrier frequency shall be adjusted as close to the upper and lower frequency block edges as the design of the equipment permits.

Test Configuration

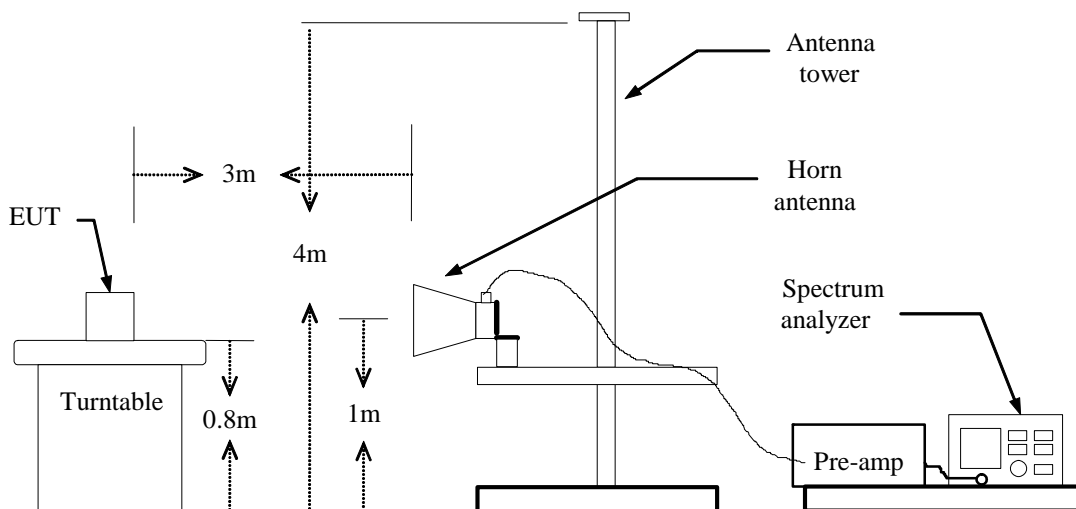

TEST PROCEDURE

1. The EUT is placed on a turntable, which is 0.8m above the ground plane.
2. The turntable shall be rotated for 360 degrees to determine the position of maximum emission level.
3. EUT is set 3m away from the receiving antenna, which is varied from 1m to 4m to find out the highest emission.
4. Set the spectrum analyzer in the following setting in order to capture the lower and upper band-edges of the emission:
 - (a) PEAK: RBW=VBW=1MHz / Sweep=AUTO
 - (b) AVERAGE: RBW=1MHz / VBW=10Hz / Sweep=AUTO
5. Repeat the procedures until all the PEAK and AVERAGE versus POLARIZATION are measured.

TEST RESULTS

Refer to attach spectrum analyzer data chart.



Band Edges (IEEE 802.11a mode / 5180 MHz)

Detector mode: Peak

Polarity: Vertical

Agilent 15:55:21 Jul 9, 2011

R T

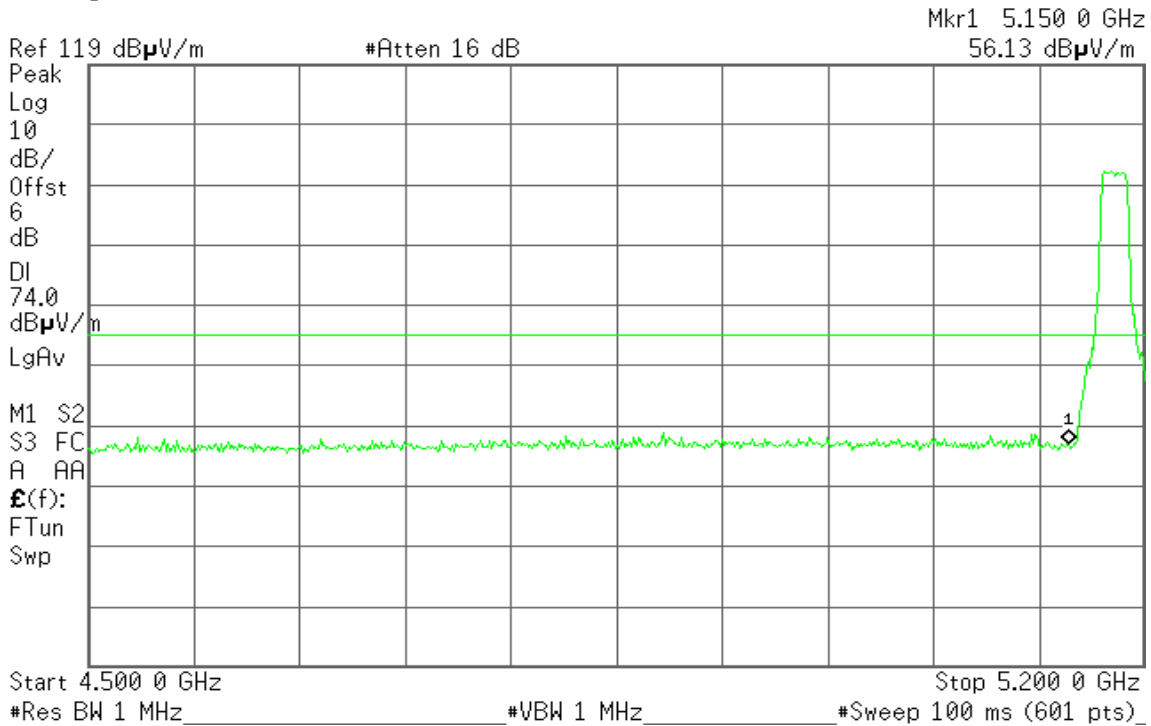

Detector mode: Average

Polarity: Vertical

Agilent 15:56:46 Jul 9, 2011

R T

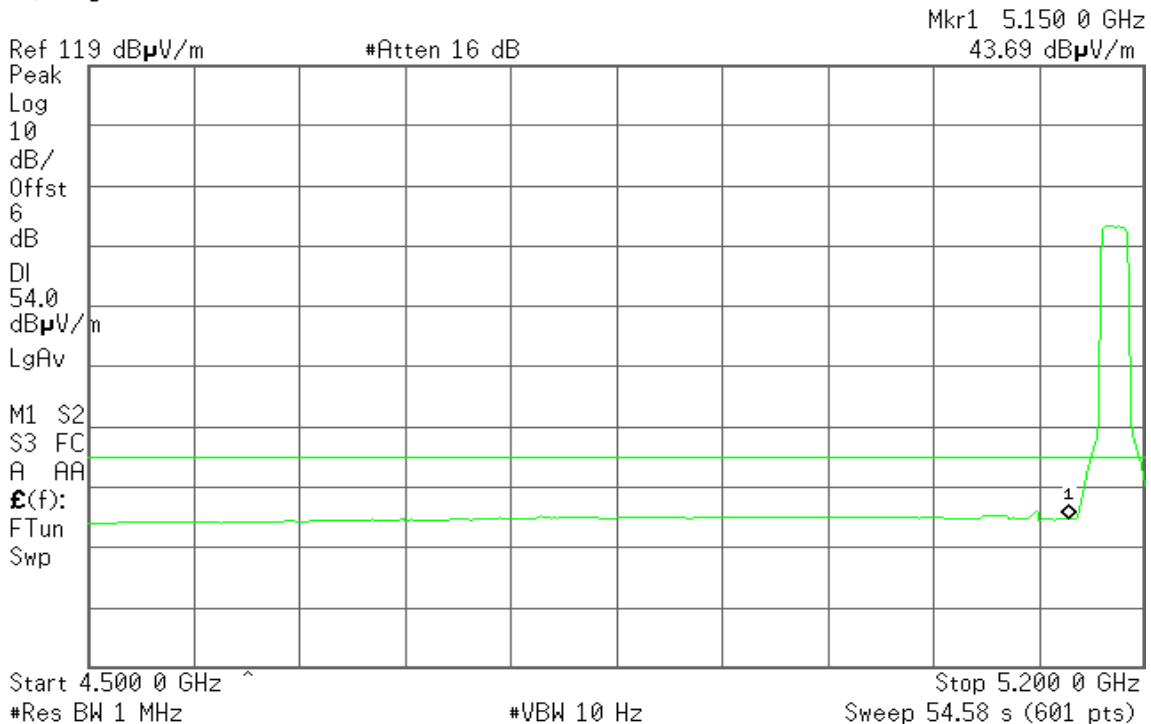



Detector mode: Peak

Polarity: Horizontal

Agilent 16:01:50 Jul 9, 2011

R T

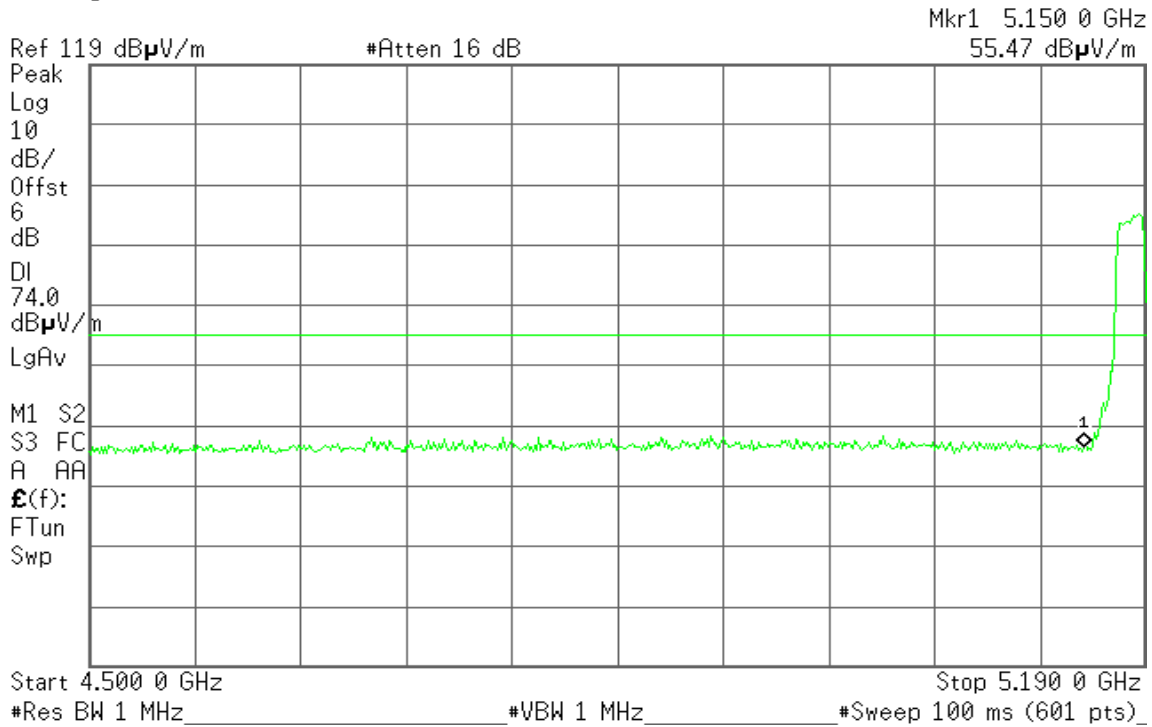

Detector mode: Average

Polarity: Horizontal

Agilent 16:04:04 Jul 9, 2011

R T

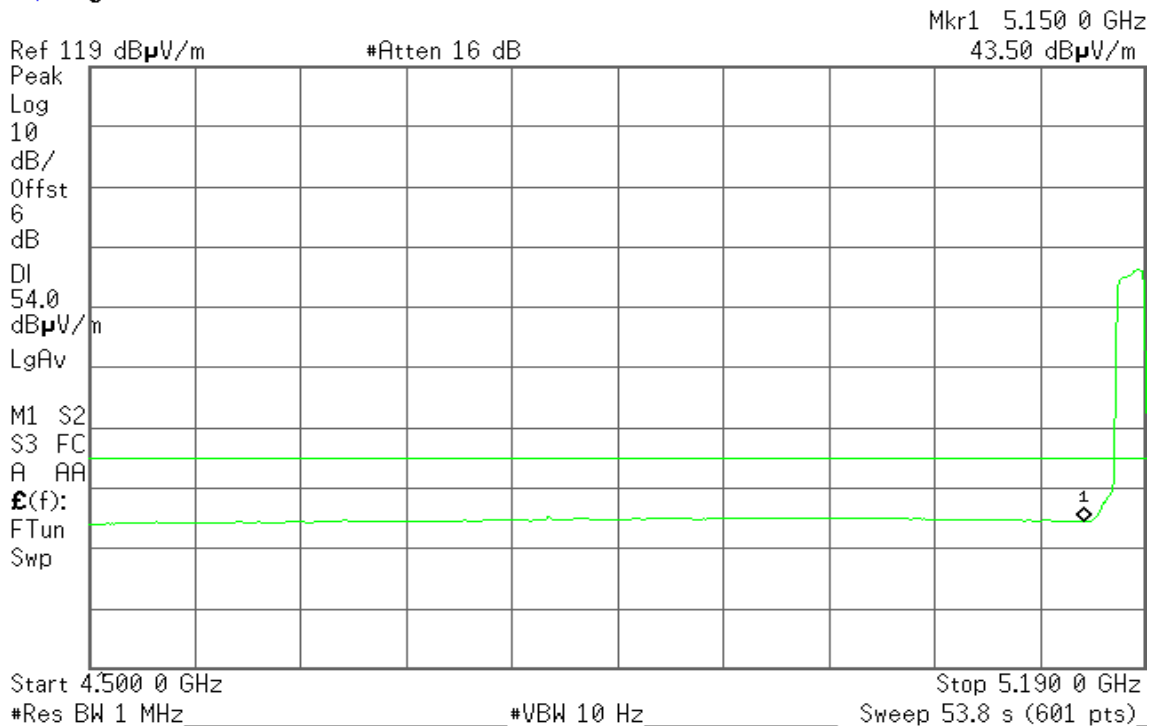



Band Edges (IEEE 802.11a mode / 5240 MHz)

Detector mode: Peak

Polarity: Vertical

Agilent 16:18:47 Jul 9, 2011

R T

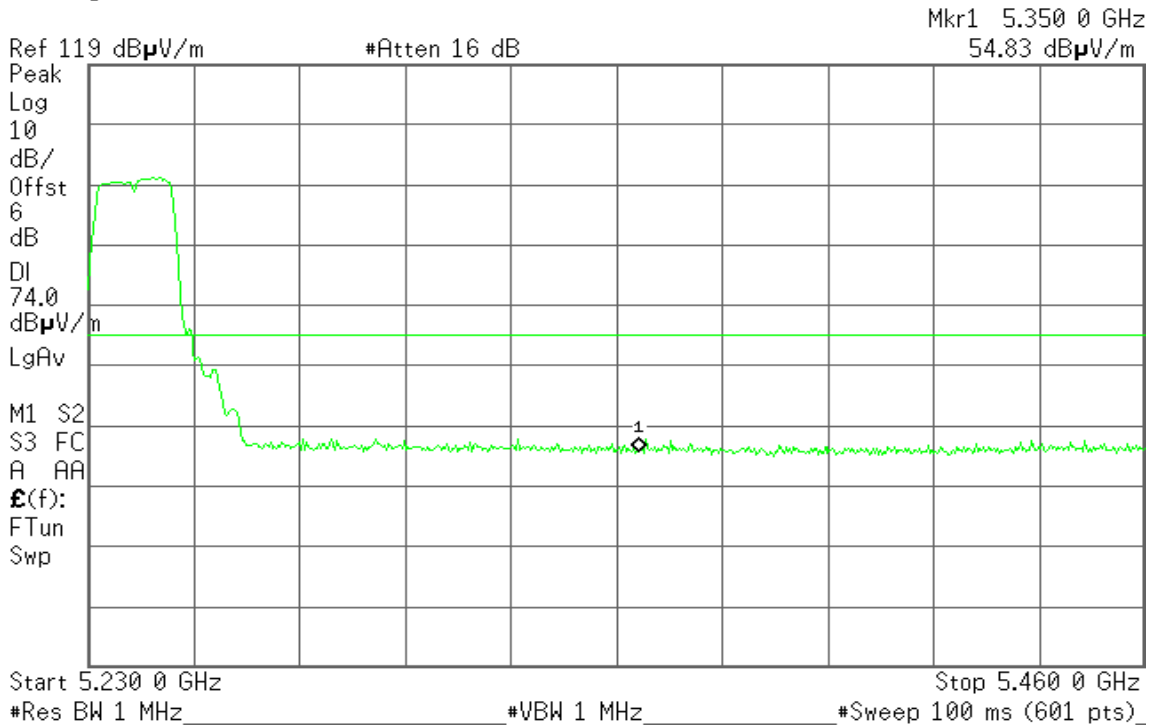

Detector mode: Average

Polarity: Vertical

Agilent 16:19:54 Jul 9, 2011

R T

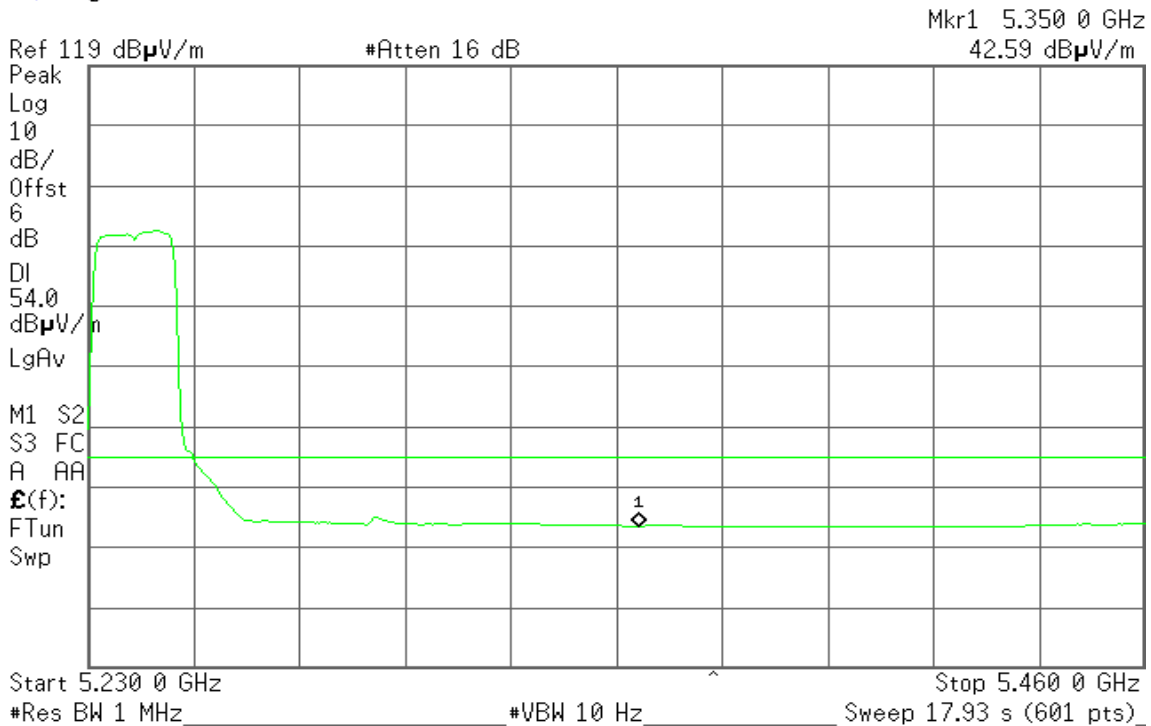



Detector mode: Peak

Polarity: Horizontal

Agilent 16:26:13 Jul 9, 2011

R T

Mkr1 5.350 0 GHz
54.37 dBµV/m

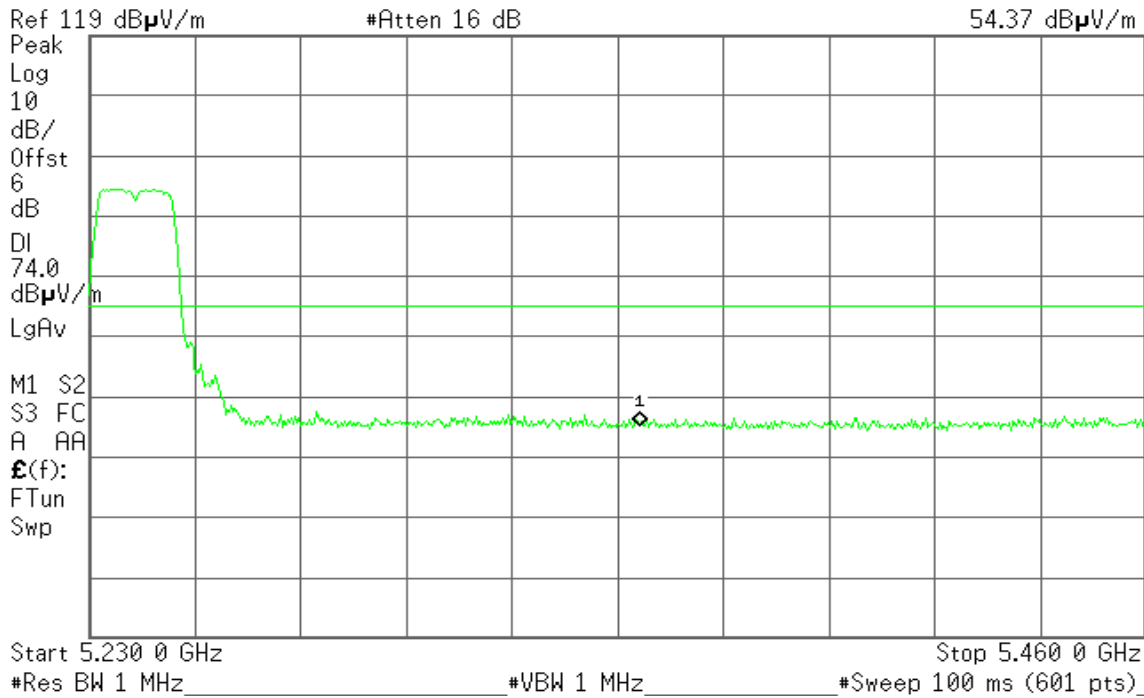

Detector mode: Average

Polarity: Horizontal

Agilent 16:27:10 Jul 9, 2011

R T

Mkr1 5.350 0 GHz
42.56 dBµV/m

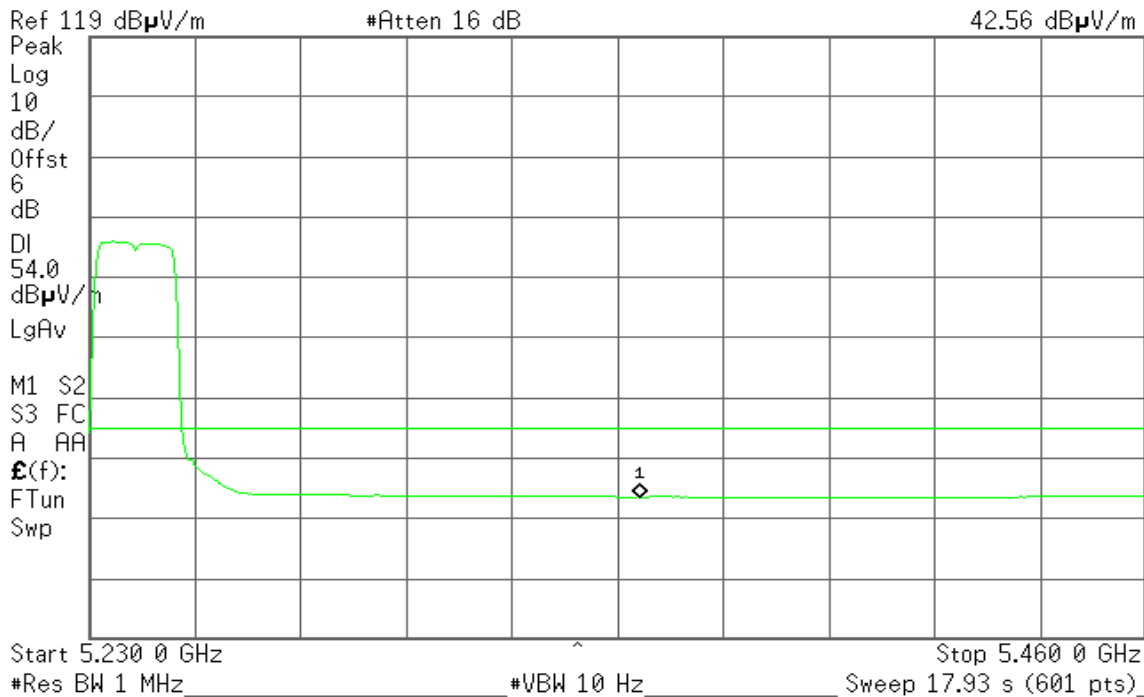



Band Edges (IEEE 802.11n HT 20 MHz mode / 5180 MHz)

Detector mode: Peak

Polarity: Vertical

Agilent 16:49:33 Jul 9, 2011

R T

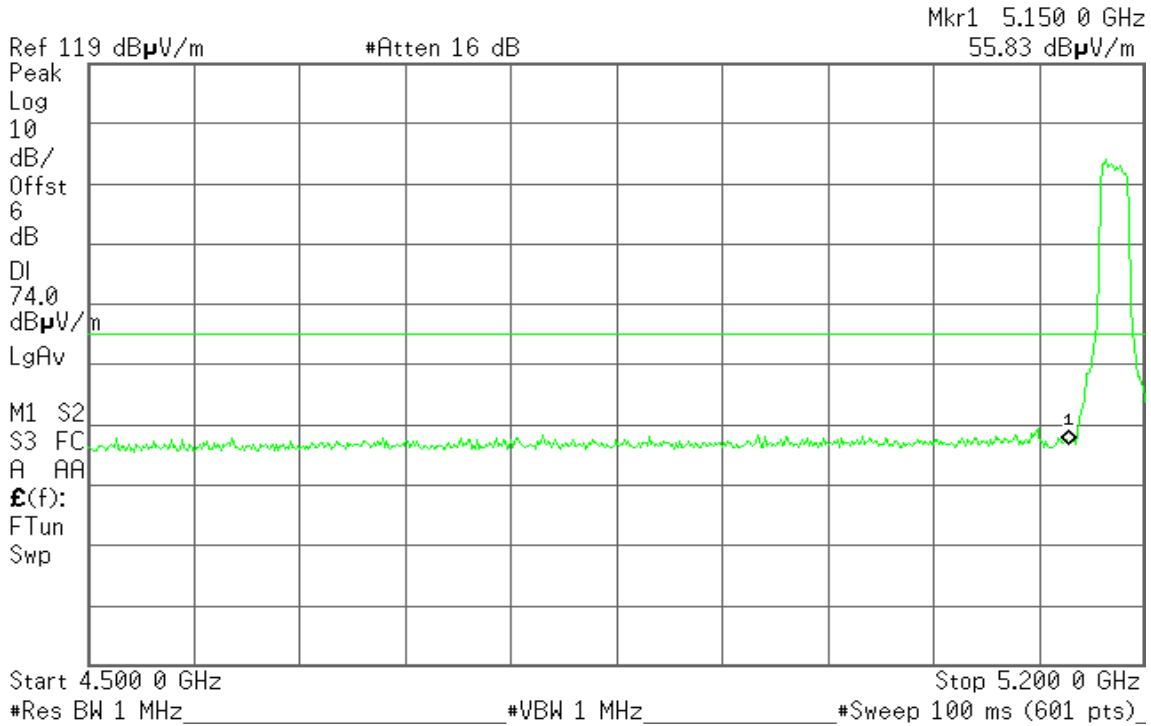

Detector mode: Average

Polarity: Vertical

Agilent 16:52:41 Jul 9, 2011

R T

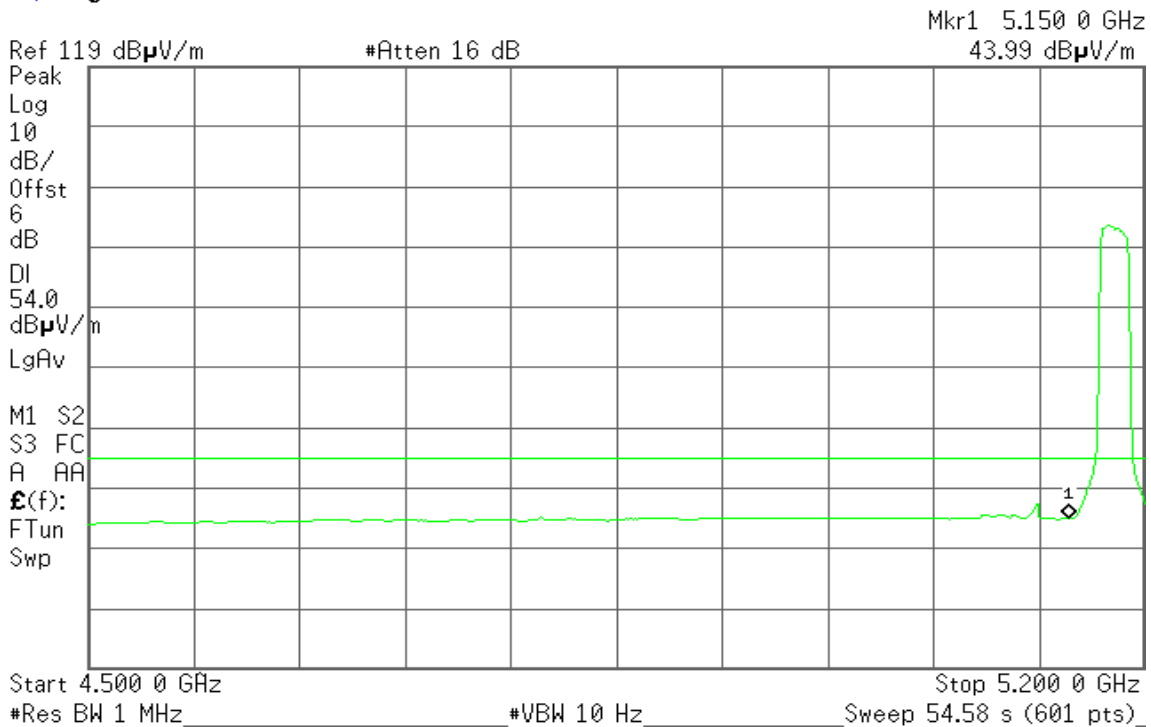



Detector mode: Peak

Polarity: Horizontal

Agilent 17:03:36 Jul 9, 2011

R T

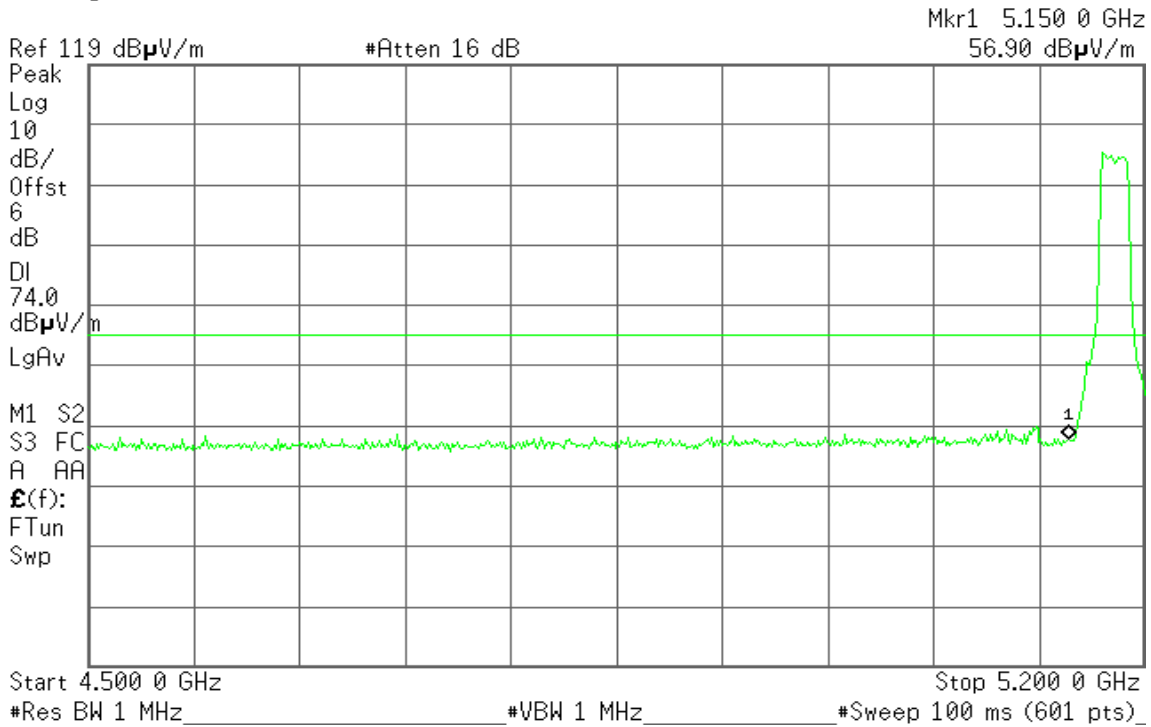

Detector mode: Average

Polarity: Horizontal

Agilent 17:01:32 Jul 9, 2011

R T

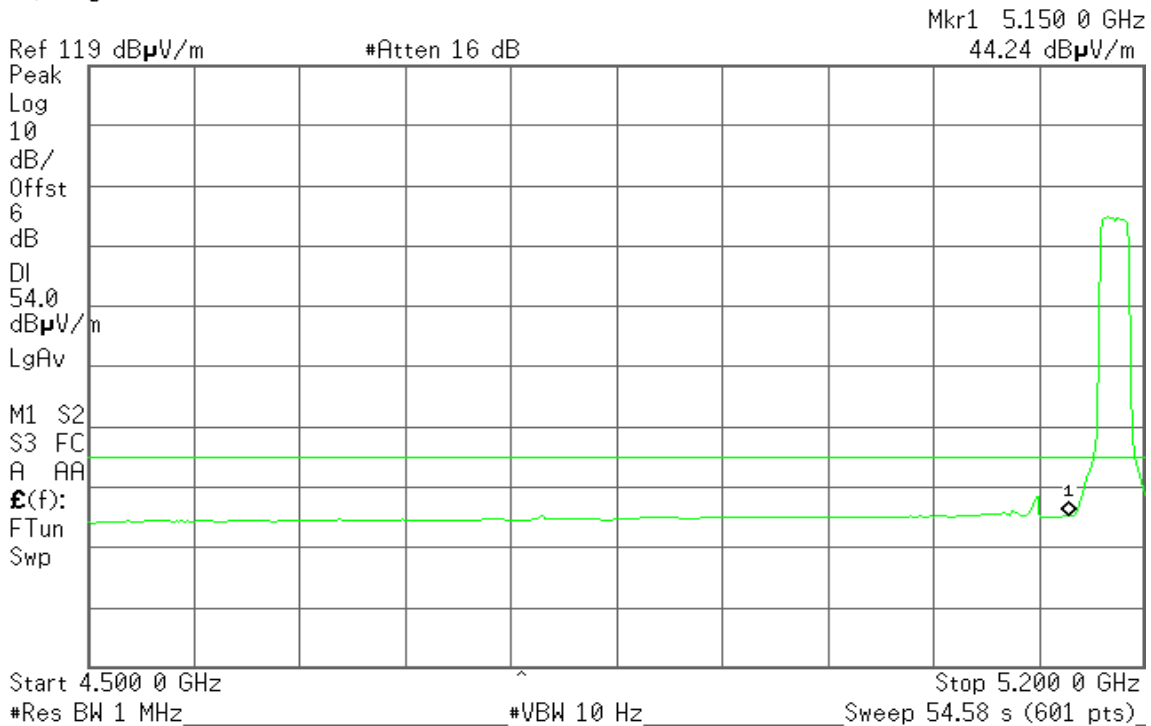



Band Edges (IEEE 802.11n HT 20 MHz mode / 5240 MHz)

Detector mode: Peak

Polarity: Vertical

Agilent 17:16:00 Jul 9, 2011

R T

Mkr1 5.350 0 GHz
54.76 dBµV/m

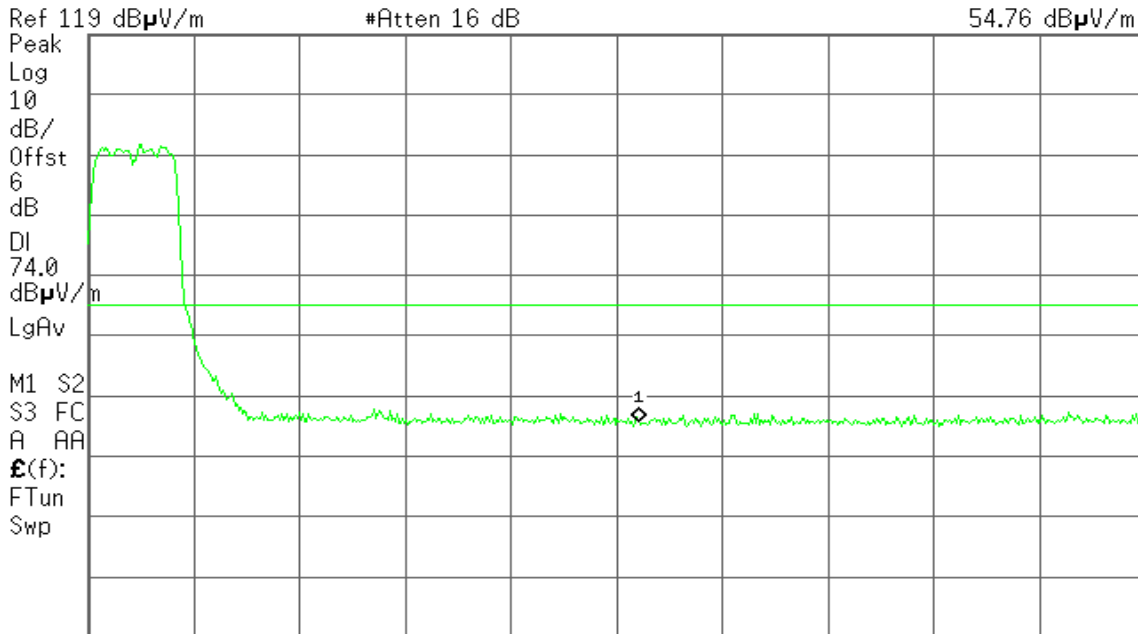

Start 5.230 0 GHz #Res BW 1 MHz #VBW 1 MHz Stop 5.460 0 GHz #Sweep 100 ms (601 pts)

Detector mode: Average

Polarity: Vertical

Agilent 17:16:41 Jul 9, 2011

R T

Mkr1 5.350 0 GHz
42.70 dBµV/m

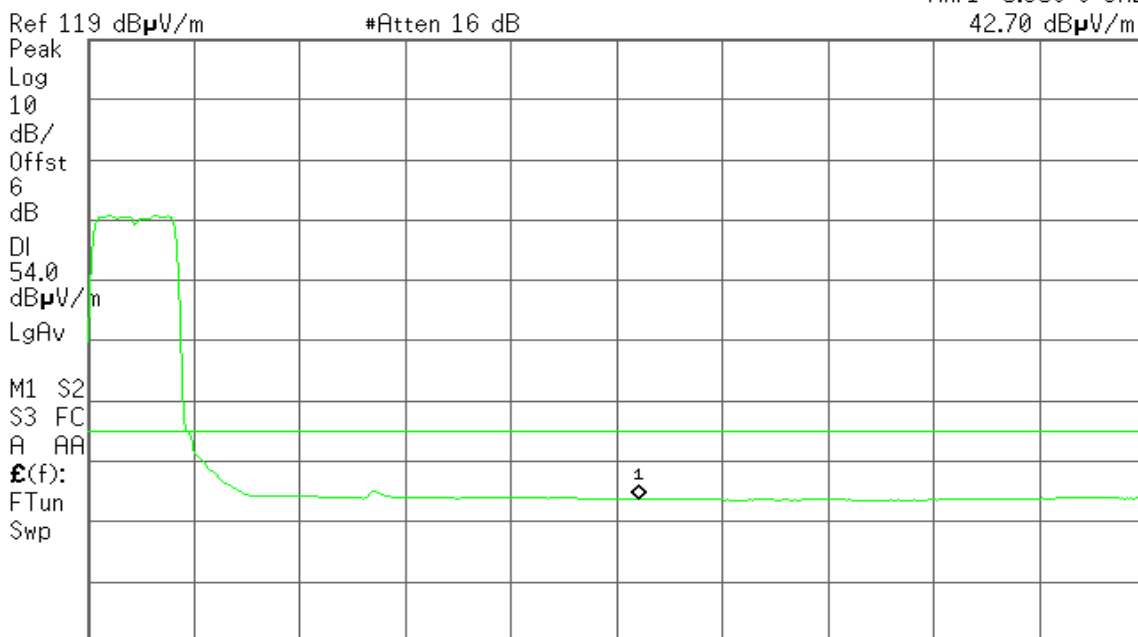

Start 5.230 0 GHz #Res BW 1 MHz #VBW 10 Hz Stop 5.460 0 GHz Sweep 17.93 s (601 pts)



Detector mode: Peak

Polarity: Horizontal

Agilent 17:22:28 Jul 9, 2011

R T

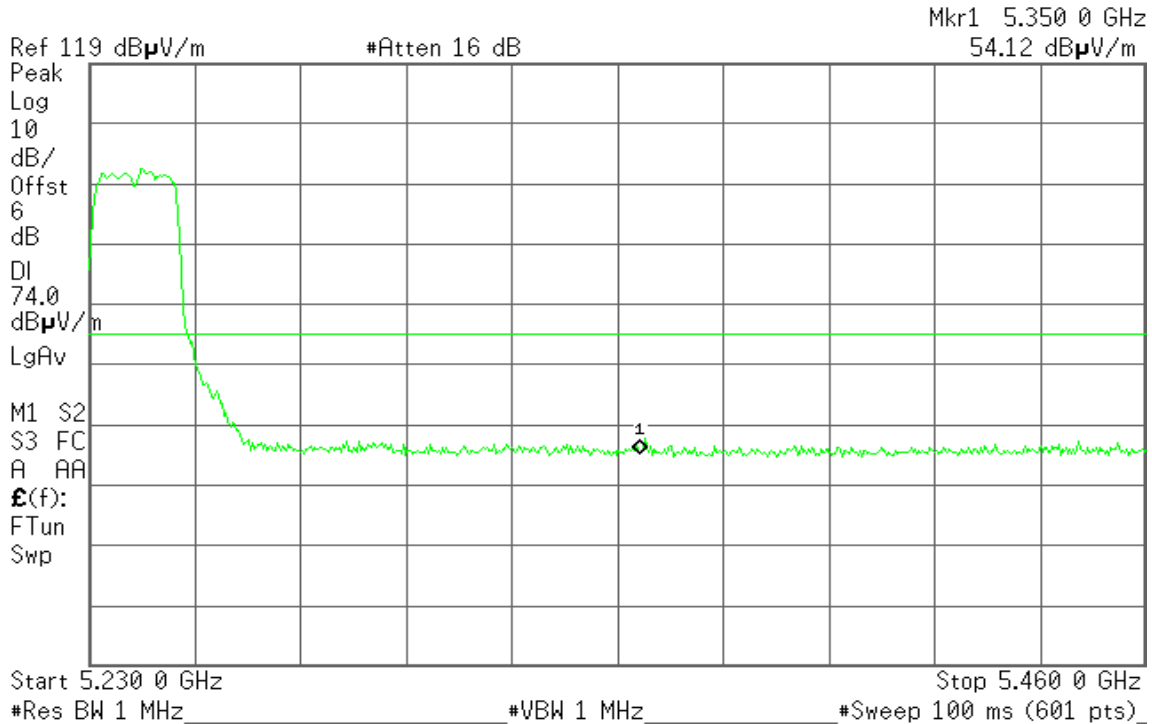

Detector mode: Average

Polarity: Horizontal

Agilent 10:10:23 Jul 11, 2011

R L

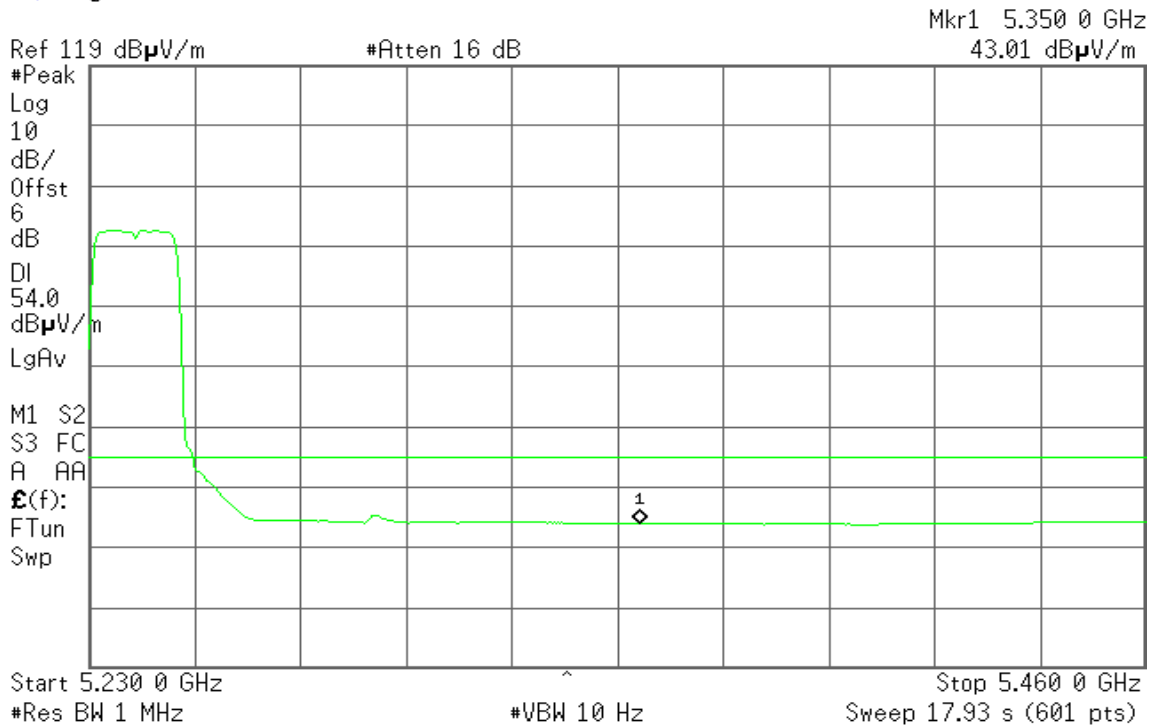



Band Edges (IEEE 802.11n HT 40 MHz mode / 5190 MHz)

Detector mode: Peak

Polarity: Vertical

Agilent 18:10:54 Jul 9, 2011

R T

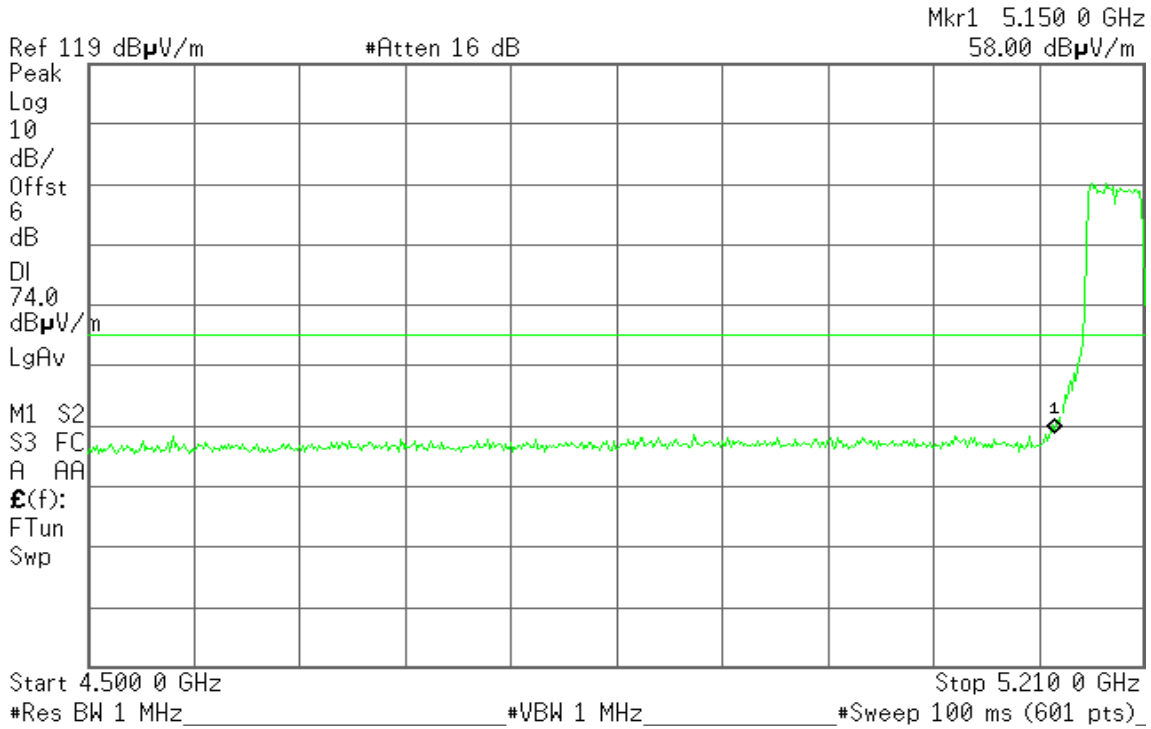

Detector mode: Average

Polarity: Vertical

Agilent 18:13:29 Jul 9, 2011

R T

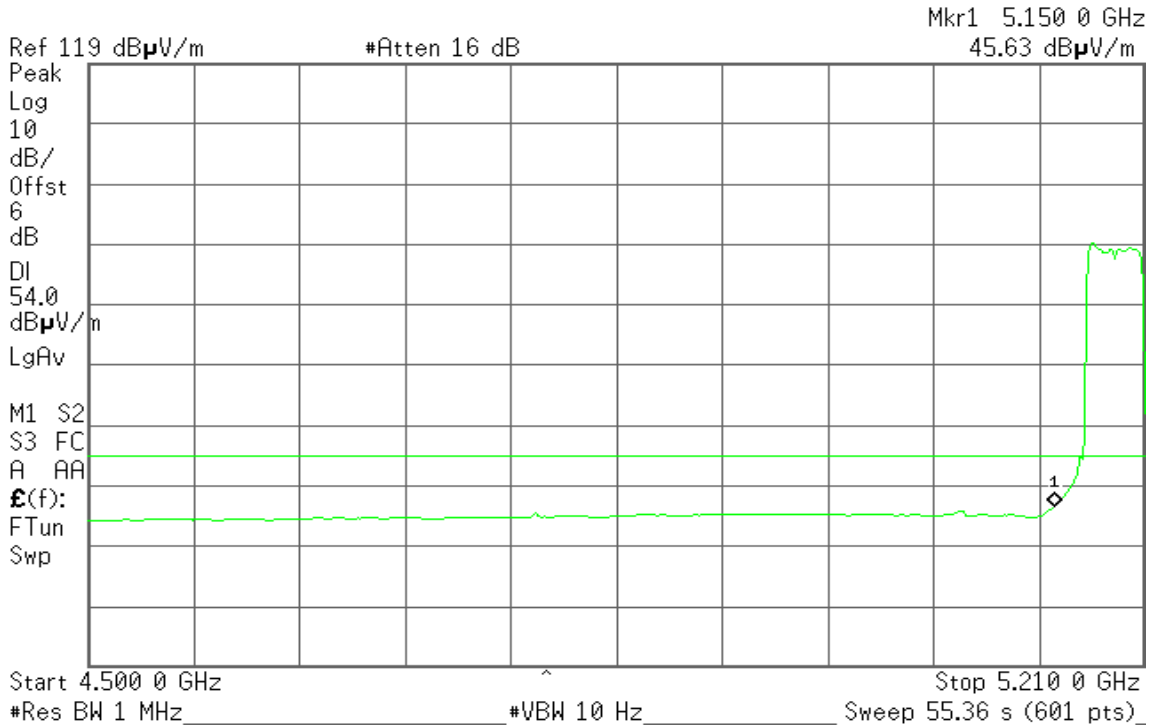



Detector mode: Peak

Polarity: Horizontal

Agilent 18:04:00 Jul 9, 2011

R T

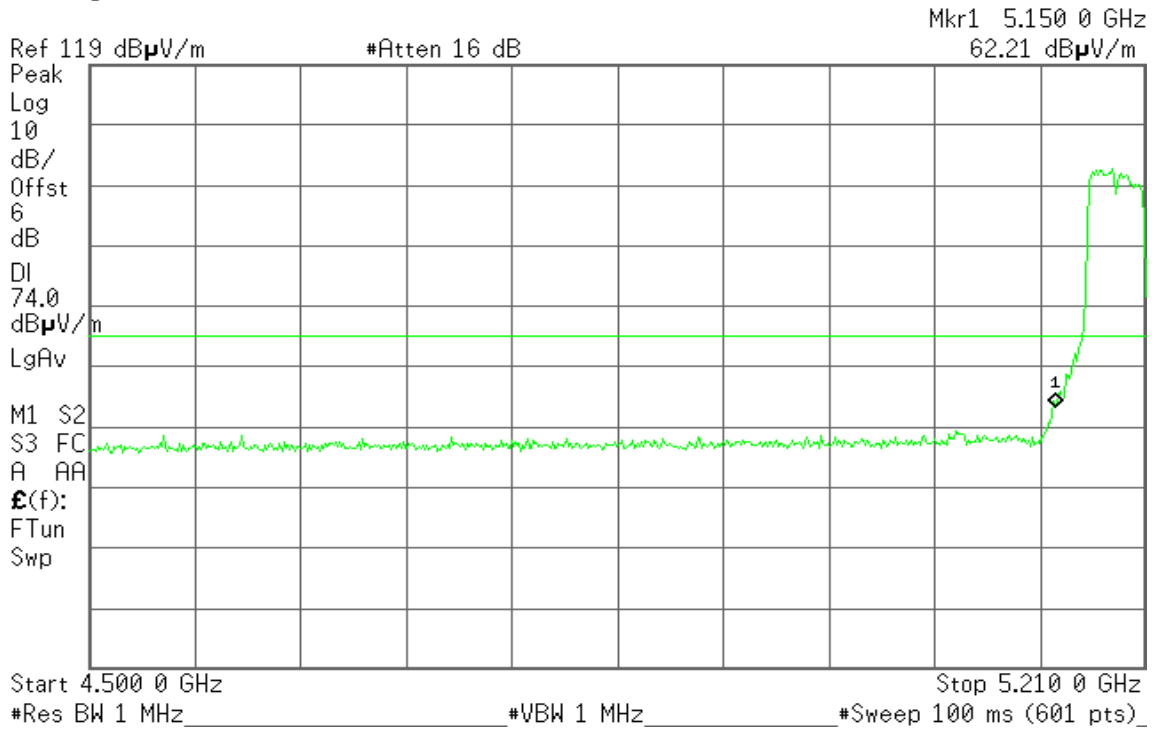

Detector mode: Average

Polarity: Horizontal

Agilent 18:06:54 Jul 9, 2011

R T

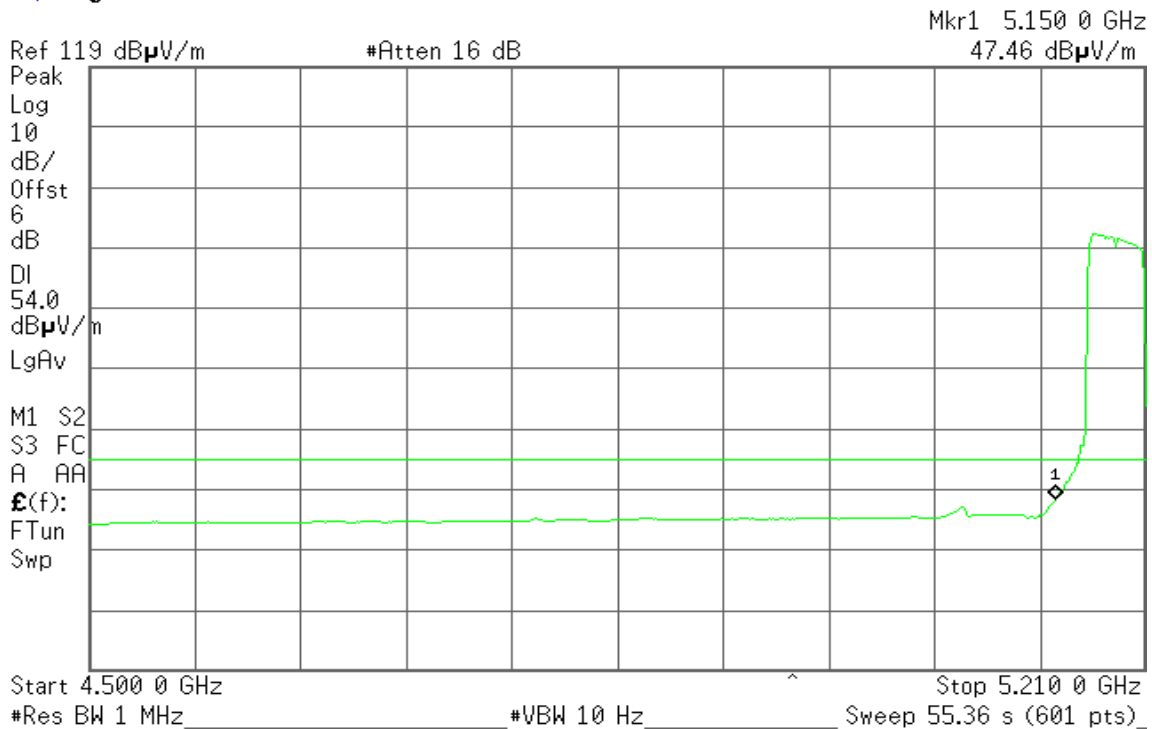



Band Edges (IEEE 802.11n HT 40 MHz mode / CH 5230 MHz)

Detector mode: Peak

Polarity: Vertical

Agilent 18:19:14 Jul 9, 2011

R T

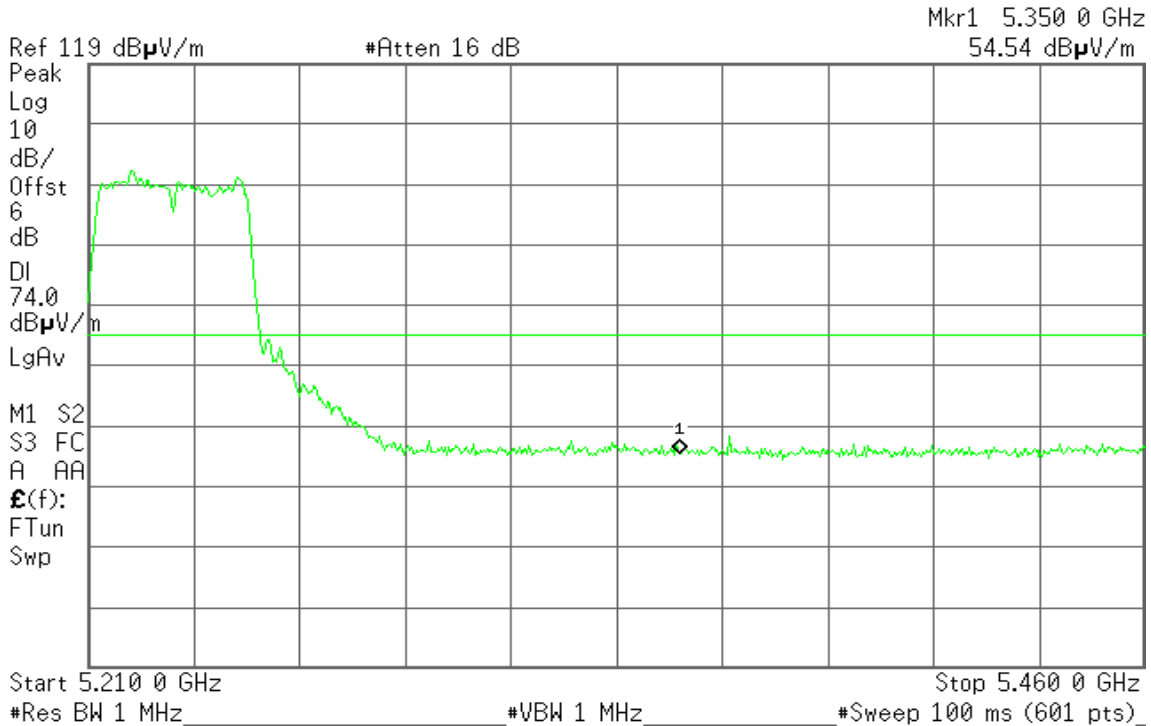

Detector mode: Average

Polarity: Vertical

Agilent 18:20:02 Jul 9, 2011

R T

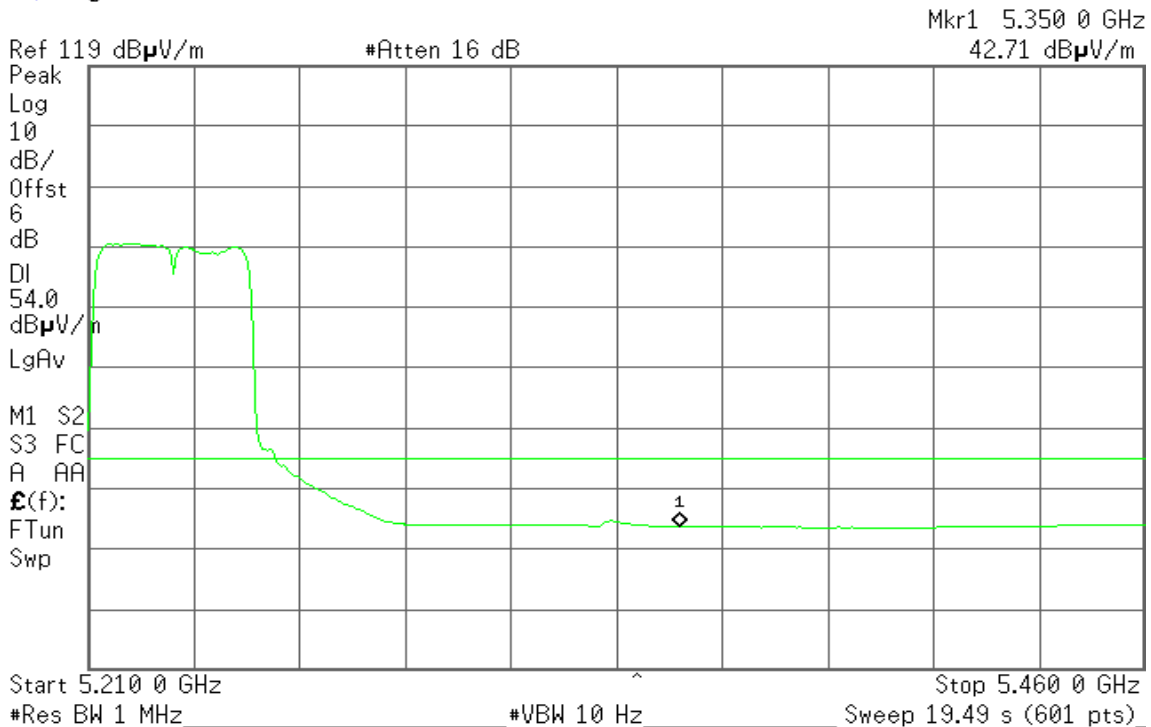



Detector mode: Peak

Polarity: Horizontal

Agilent 18:24:40 Jul 9, 2011

R T

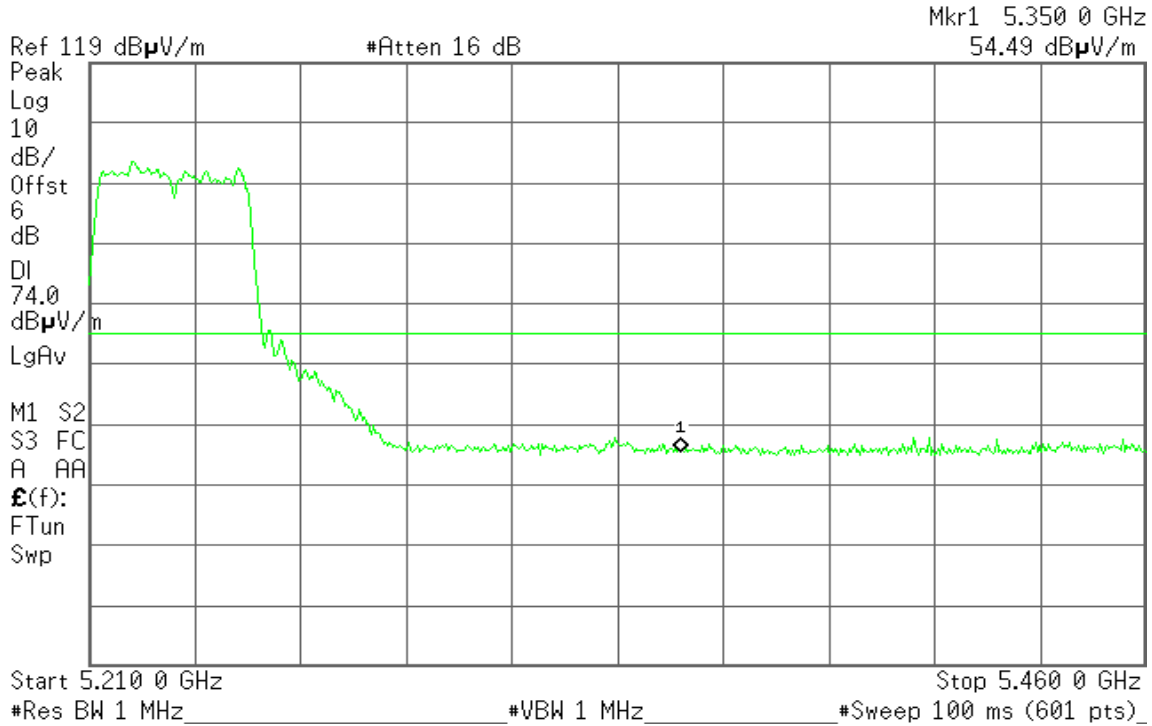

Detector mode: Average

Polarity: Horizontal

Agilent 18:25:31 Jul 9, 2011

R T

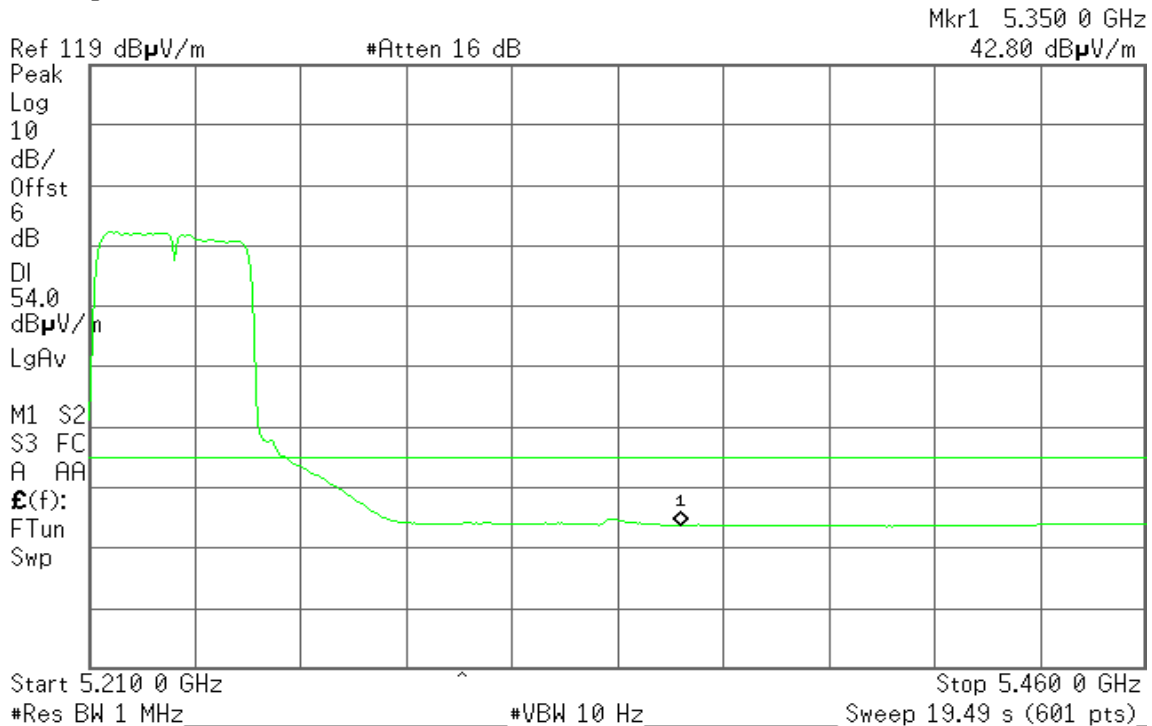



7.4 PEAK POWER SPECTRAL DENSITY

LIMIT

According to §15.407(a),

- (1) For the band 5.15-5.25 GHz, the peak power spectral density shall not exceed 4dBm in any 1MHz band.
- (2) For the band 5.25-5.35 GHz, the peak power spectral density shall not exceed 11dBm in any 1MHz band.

If transmitting antennas of directional gain greater than 6dBi are used, both the peak transmit power and the peak power spectral density shall be reduced by the amount in dB that the directional gain of the antenna exceeds 6dBi.

Test Configuration

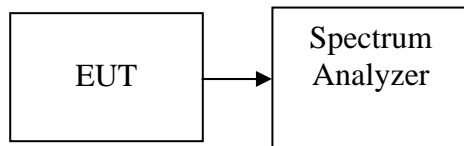

TEST PROCEDURE

1. Place the EUT on the table and set it in transmitting mode.
Remove the antenna from the EUT and then connect a low loss RF cable from the antenna port to the spectrum analyzer.
2. Set the spectrum analyzer as RBW = 1MHz, VBW = 3MHz, Span = 30MHz, Sweep=1ms
3. Record the max. reading.
4. Repeat the above procedure until the measurements for all frequencies are completed

TEST RESULTS

No non-compliance noted



Test Data

Test mode: IEEE 802.11a mode / 5180 ~ 5240MHz

Channel	Frequency (MHz)	PPSD (dBm)	Limit (dBm)	Margin	Result
Low	5180	2.209	4.00	-1.79	PASS
Mid	5220	2.013	4.00	-1.99	PASS
High	5240	2.255	4.00	-1.75	PASS

Test mode: IEEE 802.11n HT 20 MHz mode / 5180 ~ 5240MHz

Channel	Frequency (MHz)	Chain 0 PPSD (dBm)	Chain 1 PPSD (dBm)	Chain 2 PPSD (dBm)	PPSD (dBm)	Limit (dBm)	Margin	Result
Low	5180	-5.735	-6.675	-3.130	-0.14	4.00	-4.14	PASS
Mid	5220	-4.535	-5.149	-3.660	0.37	4.00	-3.63	PASS
High	5240	-4.002	-4.055	-3.924	0.78	4.00	-3.22	PASS

Test mode: IEEE 802.11n HT 40 MHz mode / 5190 ~ 5230MHz

Channel	Frequency (MHz)	Chain 0 PPSD (dBm)	Chain 1 PPSD (dBm)	Chain 2 PPSD (dBm)	PPSD (dBm)	Limit (dBm)	Margin	Result
Low	5190	-4.835	-9.608	-6.023	-1.63	4.00	-5.63	PASS
High	5230	-4.983	-5.262	-6.573	-0.78	4.00	-4.78	PASS

Remark:

1. Total PPSD (dBm) = $10 * \text{LOG}(10^{(\text{Chain 0 PPSD} / 10)} + 10^{(\text{Chain 1 PPSD} / 10)} + 10^{(\text{Chain 2 PPSD} / 10)})$



Test Plot

IEEE 802.11a mode / 5180 ~ 5240MHz

CH Low

Agilent 16:42:04 Jul 20, 2011

R T

Mkr1 5.184 70 GHz
2.029 dBm

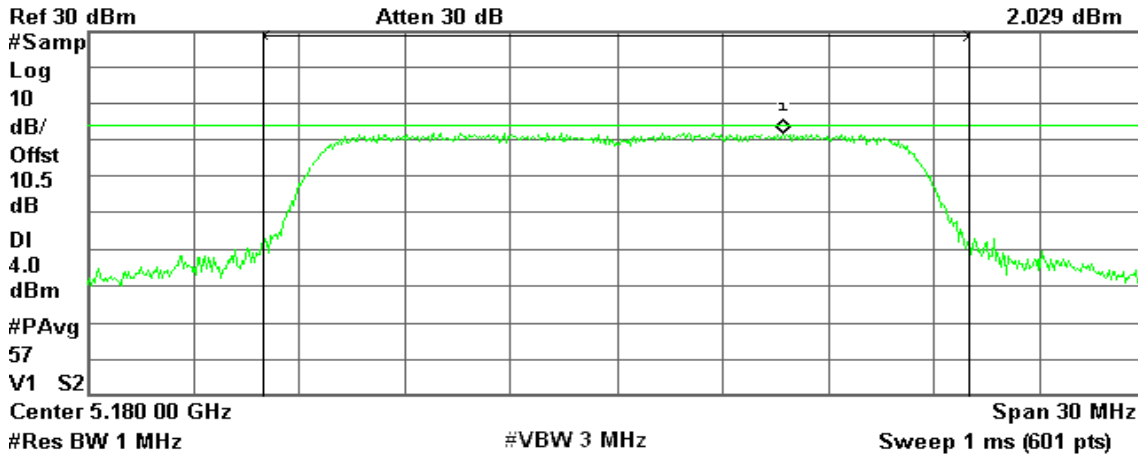

Channel Power

12.34 dBm / 20.0000 MHz

Power Spectral Density

-60.67 dBm/Hz

CH Mid

Agilent 16:47:12 Jul 20, 2011

R L

Mkr1 5.216 25 GHz
2.013 dBm

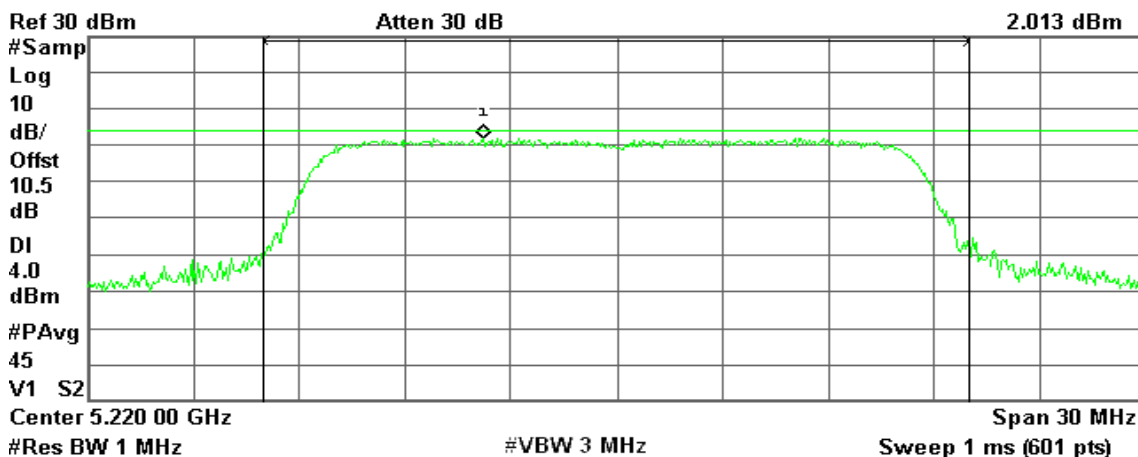

Channel Power

12.47 dBm / 20.0000 MHz

Power Spectral Density

-60.54 dBm/Hz



CH High

Agilent 16:50:28 Jul 20, 2011

R T

Mkr1 5.244 60 GHz
2.255 dBm

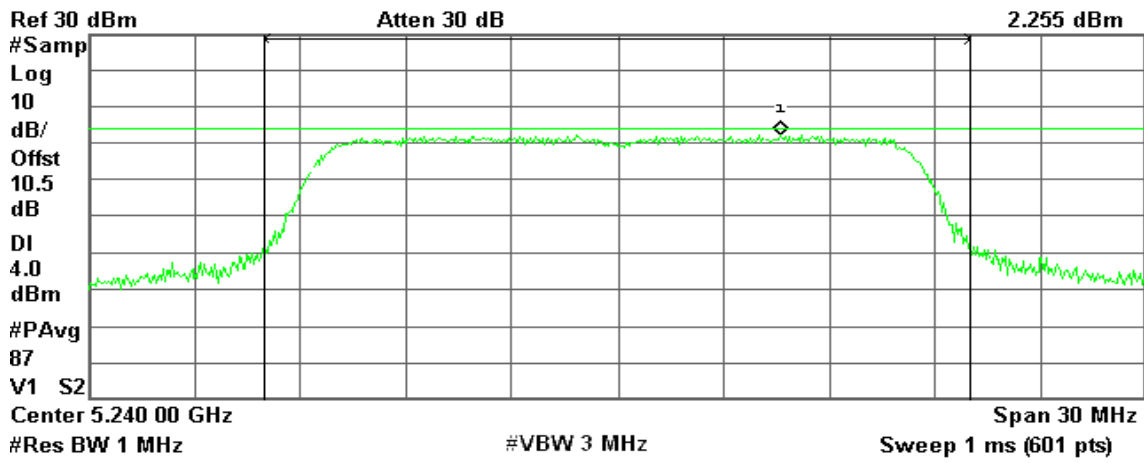

Channel Power

12.62 dBm / 20.0000 MHz

Power Spectral Density

-60.39 dBm/Hz



IEEE 802.11n HT 20 MHz mode / 5180 ~ 5240MHz / Chain 0

CH Low

Agilent 17:48:42 Jul 20, 2011

R L

Mkr1 5.175 35 GHz
5.735 dBm

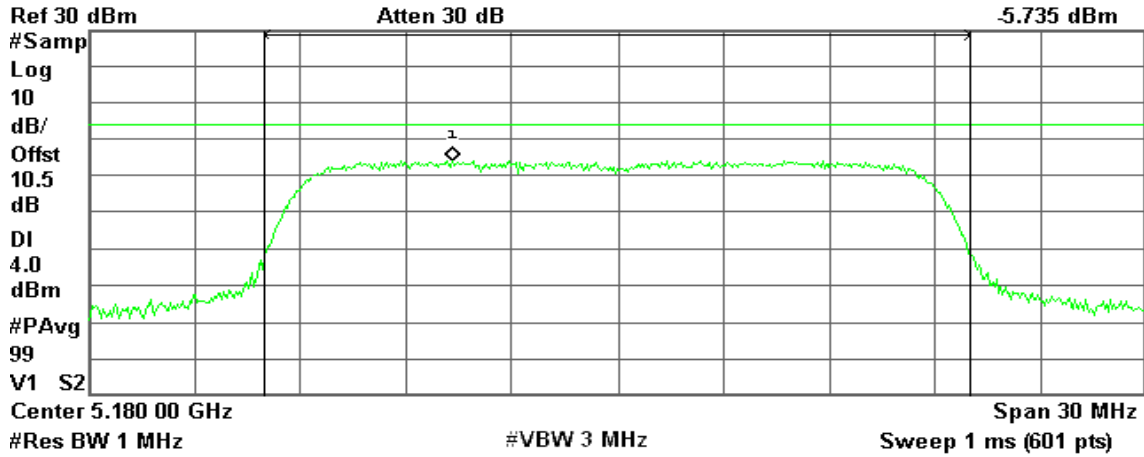

Channel Power

4.99 dBm / 20.0000 MHz

Power Spectral Density

-68.02 dBm/Hz

CH Mid

Agilent 17:54:24 Jul 20, 2011

R L

Mkr1 5.221 50 GHz
4.535 dBm

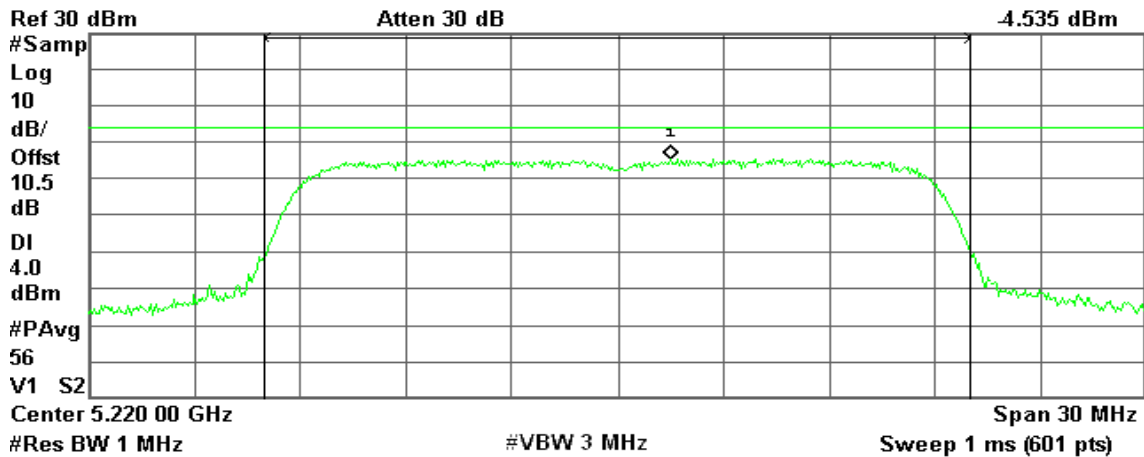

Channel Power

5.92 dBm / 20.0000 MHz

Power Spectral Density

-67.09 dBm/Hz



CH High

Agilent 18:09:09 Jul 20, 2011

R T

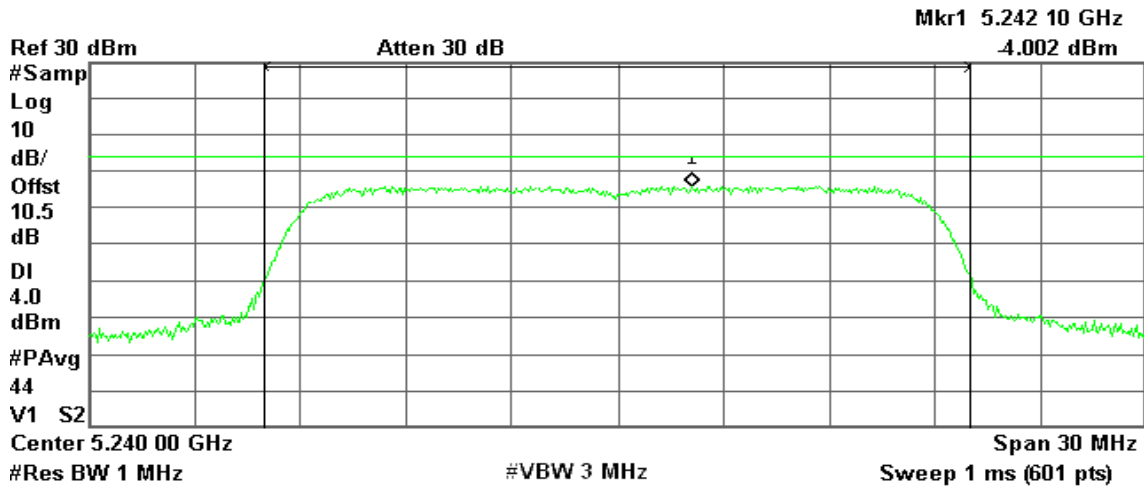

Channel Power

6.93 dBm / 20.0000 MHz

Power Spectral Density

-66.08 dBm/Hz



IEEE 802.11n HT 20 MHz mode / 5180 ~ 5240MHz / Chain 1

CH Low

Agilent 18:19:17 Jul 20, 2011

R L

Mkr1 5.185 65 GHz
-6.675 dBm

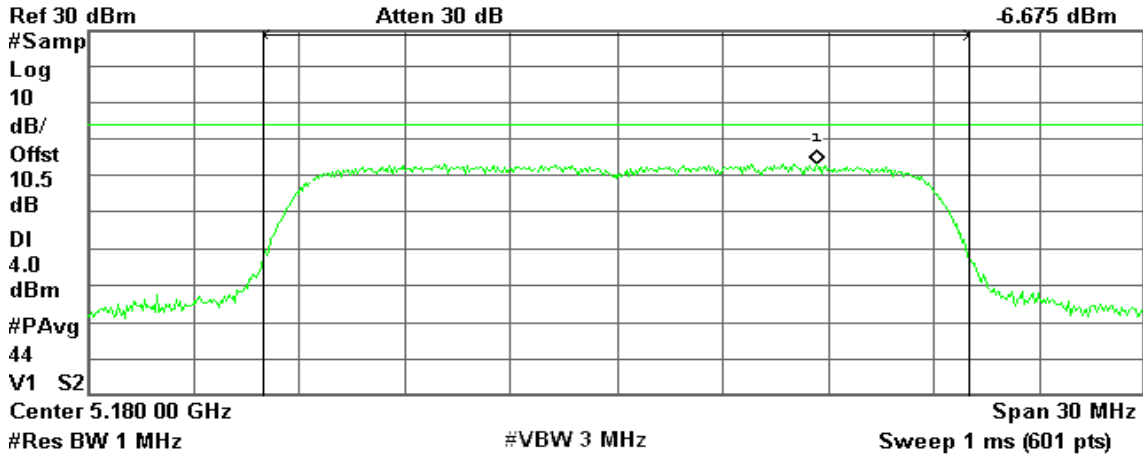

Channel Power

3.94 dBm /20.0000 MHz

Power Spectral Density

-69.07 dBm/Hz

CH Mid

Agilent 18:16:31 Jul 20, 2011

R T

Mkr1 5.222 00 GHz
-5.149 dBm

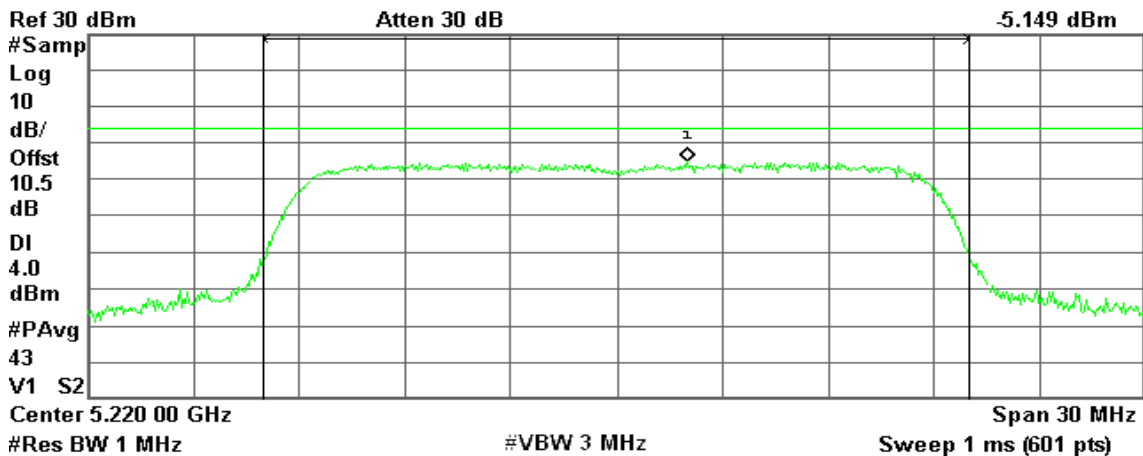

Channel Power

5.11 dBm /20.0000 MHz

Power Spectral Density

-67.90 dBm/Hz



CH High

Agilent 18:13:35 Jul 20, 2011

R T

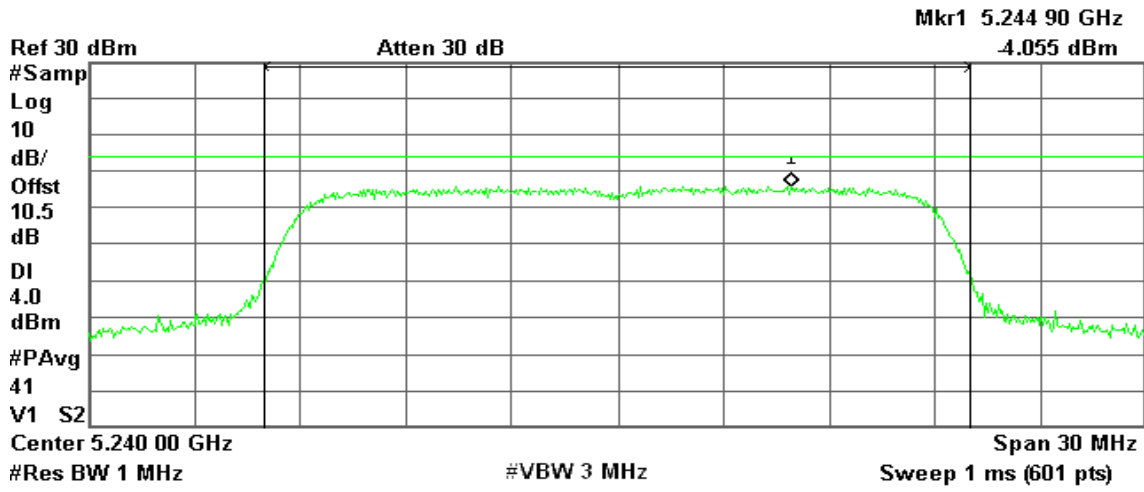

Channel Power

6.47 dBm / 20.0000 MHz

Power Spectral Density

-66.54 dBm/Hz



IEEE 802.11n HT 20 MHz mode / 5180 ~ 5240MHz / Chain 2

CH Low

Agilent 18:45:47 Jul 20, 2011

R L

Mkr1 5.175 05 GHz
-3.130 dBm

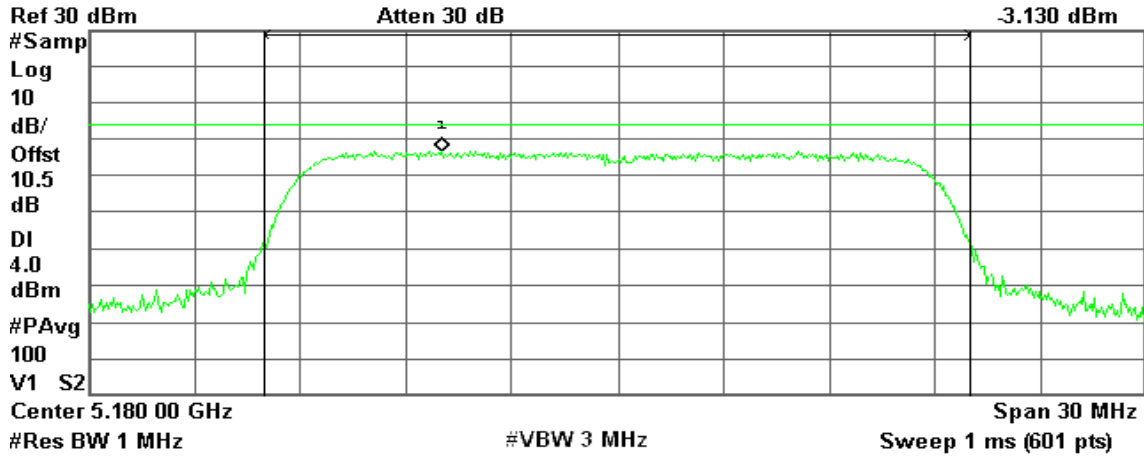

Channel Power

7.38 dBm /20.0000 MHz

Power Spectral Density

-65.63 dBm/Hz

CH Mid

Agilent 18:50:50 Jul 20, 2011

R T

Mkr1 5.215 40 GHz
-3.660 dBm

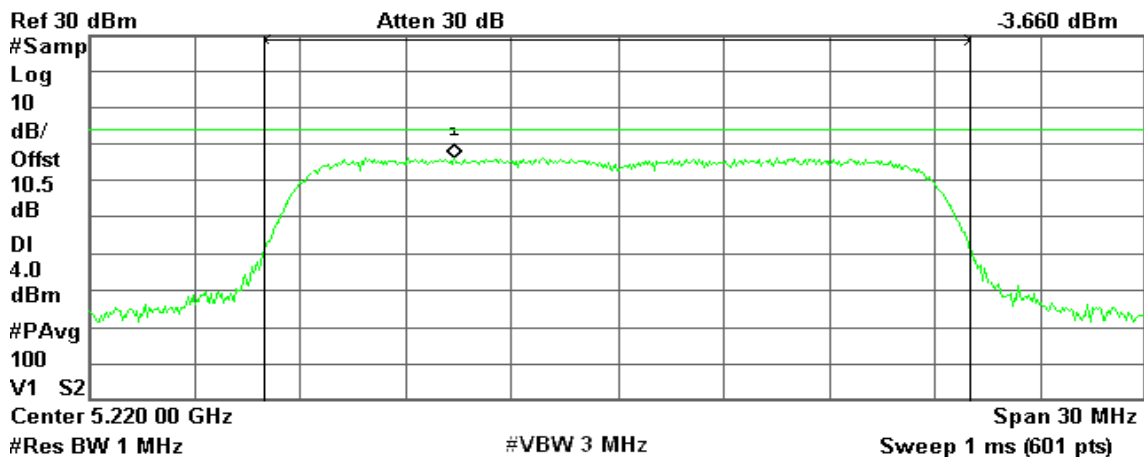

Channel Power

7.03 dBm /20.0000 MHz

Power Spectral Density

-65.98 dBm/Hz



CH High

Agilent 18:55:14 Jul 20, 2011

R T

Mkr1 5.235 65 GHz
-3.924 dBm

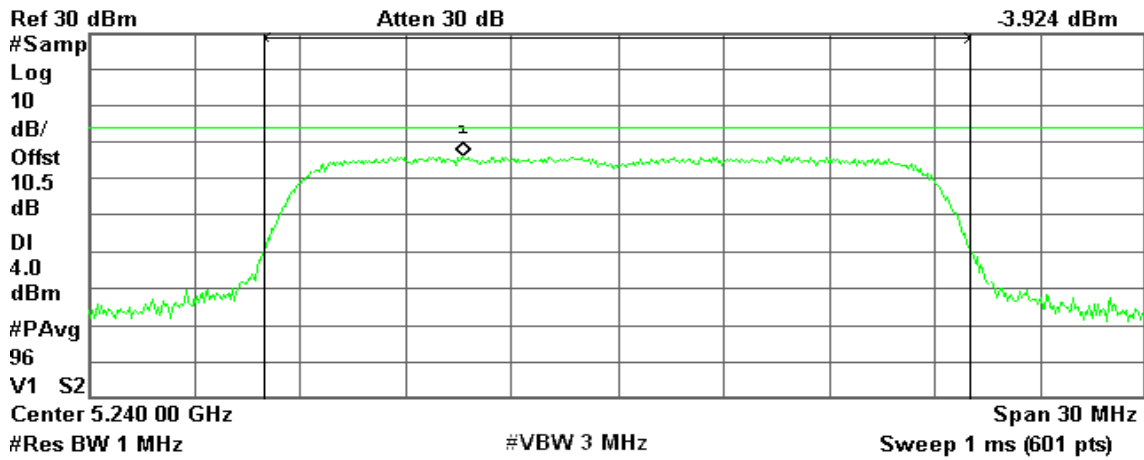

Channel Power

7.01 dBm /20.0000 MHz

Power Spectral Density

-66.00 dBm/Hz



IEEE 802.11n HT 40 MHz mode / 5190 ~ 5230MHz / Chain 0

CH Low

Agilent 12:17:48 Jul 21, 2011

R T

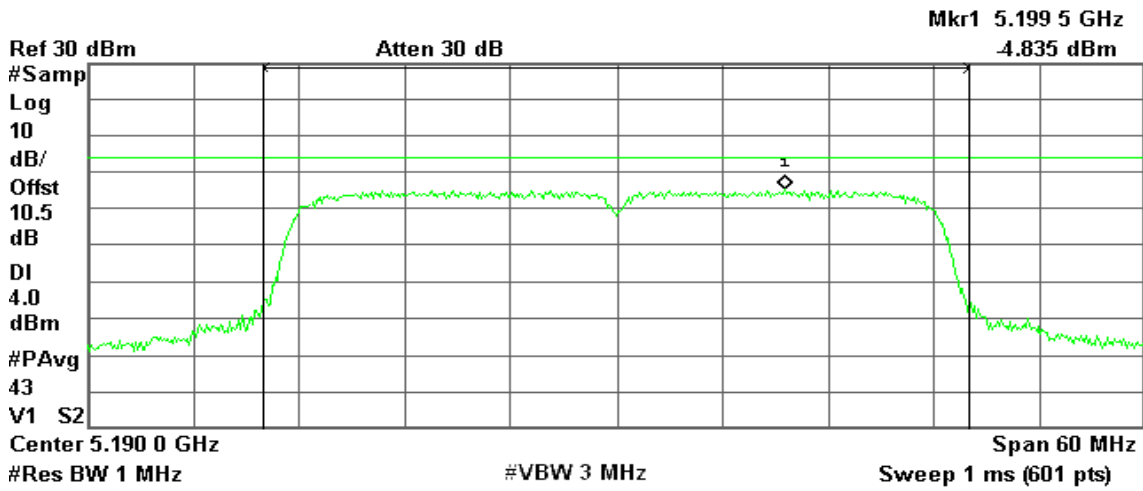

Channel Power

8.95 dBm / 40.0000 MHz

Power Spectral Density

-67.08 dBm/Hz

CH High

Agilent 12:20:43 Jul 21, 2011

R T

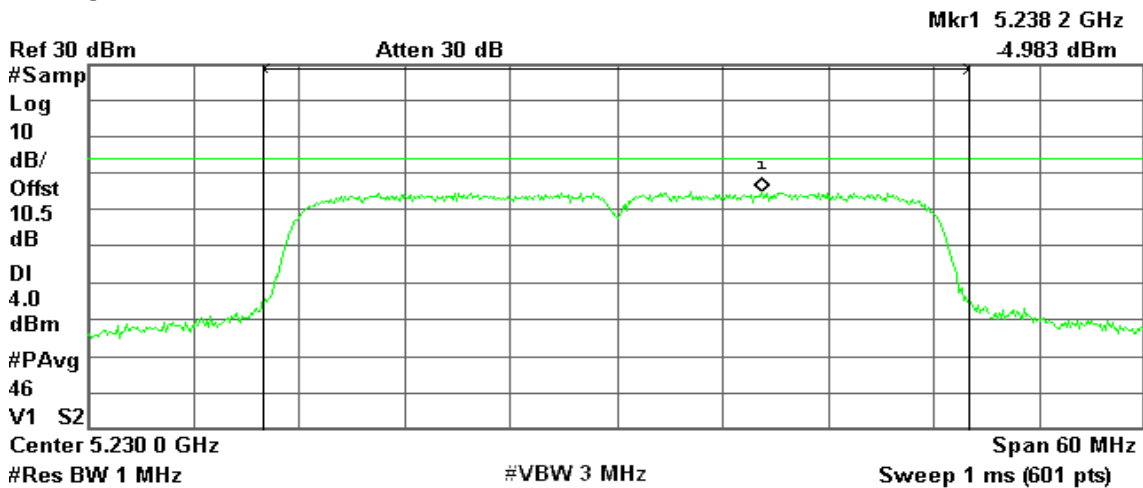

Channel Power

8.57 dBm / 40.0000 MHz

Power Spectral Density

-67.45 dBm/Hz



IEEE 802.11n HT 40 MHz mode / 5190 ~ 5230MHz / Chain 1

CH Low

Agilent 12:14:27 Jul 21, 2011

R T

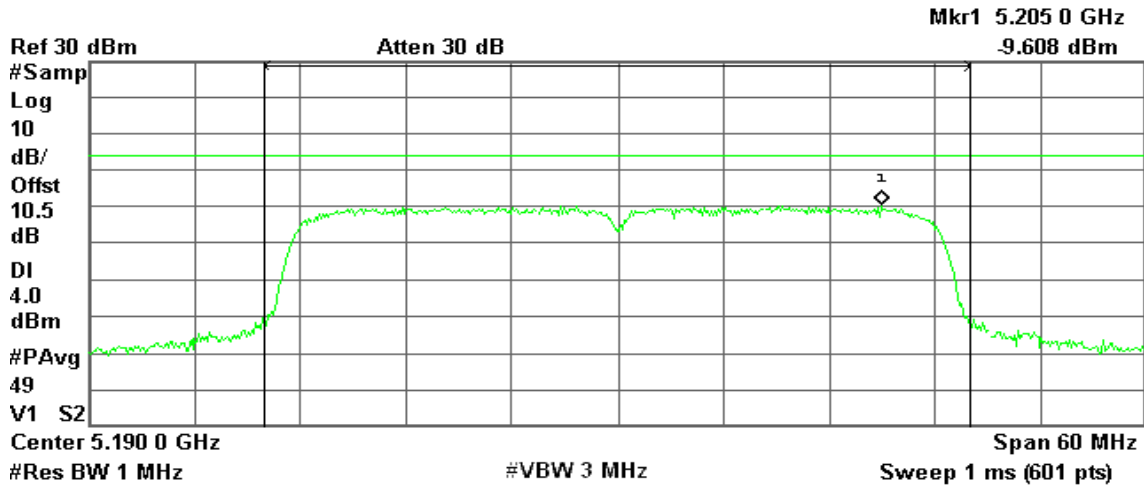

Channel Power

4.29 dBm / 40.0000 MHz

Power Spectral Density

-71.73 dBm/Hz

CH High

Agilent 12:12:00 Jul 21, 2011

R L

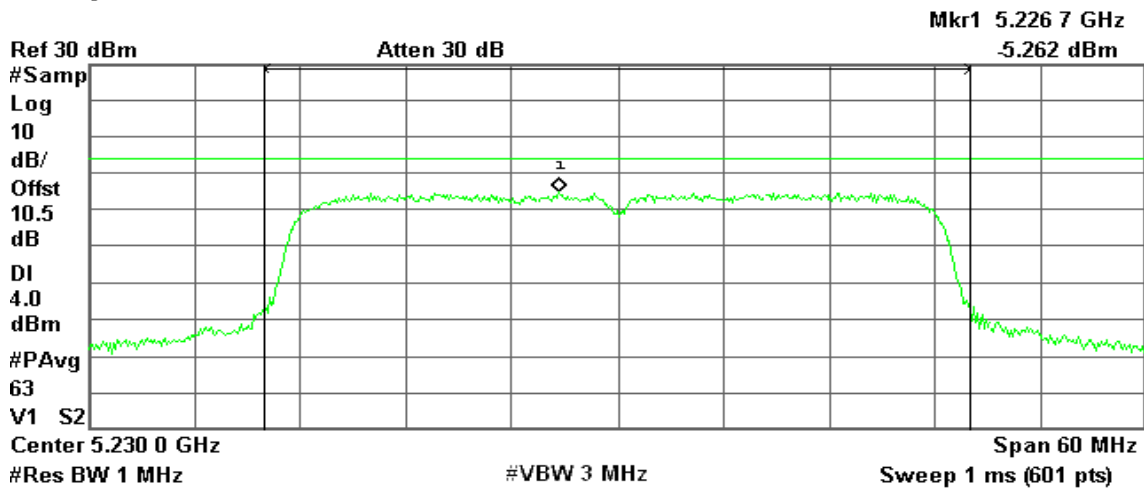

Channel Power

8.04 dBm / 40.0000 MHz

Power Spectral Density

-67.98 dBm/Hz



IEEE 802.11n HT 40 MHz mode / 5190 ~ 5230MHz / Chain 2

CH Low

Agilent 11:47:59 Jul 21, 2011

R T

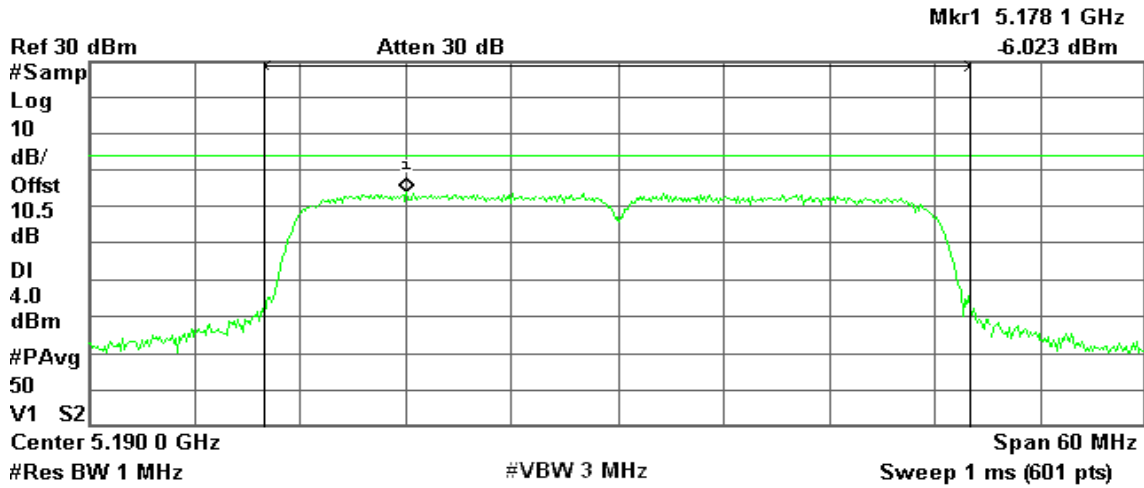

Channel Power

7.12 dBm / 40.0000 MHz

Power Spectral Density

-68.90 dBm/Hz

CH High

Agilent 12:07:24 Jul 21, 2011

R T

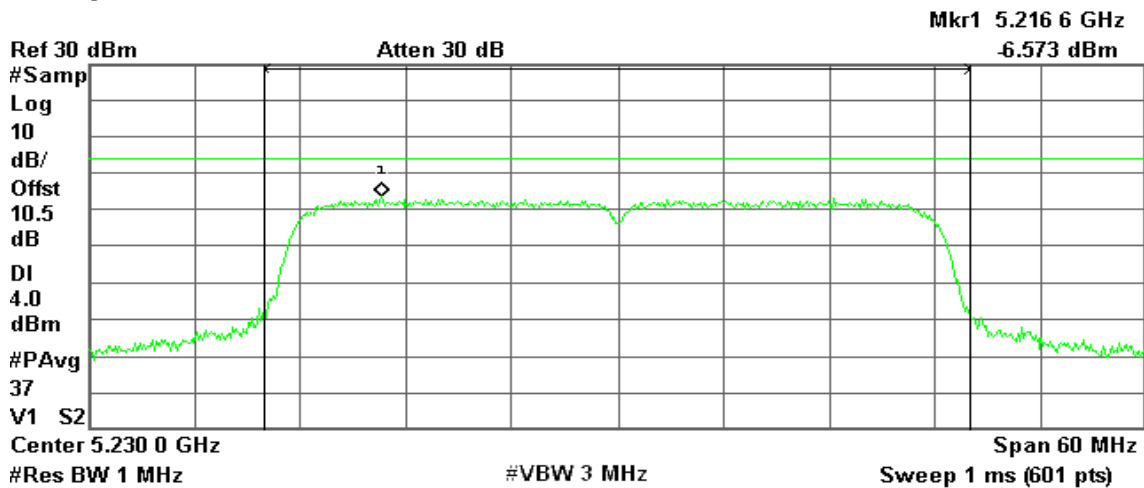

Channel Power

6.34 dBm / 40.0000 MHz

Power Spectral Density

-69.68 dBm/Hz



7.5 PEAK EXCURSION

LIMIT

According to §15.407(a)(6), the ratio of the peak excursion of the modulation envelope (measured using a peak hold function) to the maximum conducted output power (measured as specified above) shall not exceed 13 dB across any 1 MHz bandwidth or the emission bandwidth whichever is less.

Test Configuration

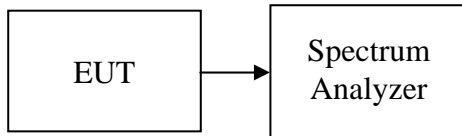

TEST PROCEDURE

The test is performed in accordance with <FCC Public Notice: APPENDIX A Guidelines for Assessing Unlicensed National Information Infrastructure (U-NII) Devices> – Part 15, Subpart E, August 2002.

1. Place the EUT on the table and set it in transmitting mode.
2. Remove the antenna from the EUT and then connect a low loss RF cable from the antenna port to spectrum.
3. Trace A, Set RBW = 1MHz, VBW = 3MHz, Span >26dB bandwidth, Max. hold.
4. Delta Mark trace A Maximum frequency and trace B same frequency.
5. Repeat the above procedure until measurements for all frequencies were complete.

TEST RESULTS

No non-compliance noted



Test Data

Test mode: IEEE 802.11a mode / 5180 ~ 5240MHz

Channel	Frequency (MHz)	Peak Excursion (dB)	Limit (dB)	Margin (dB)
Low	5180	7.73	13.00	-5.27
Mid	5220	8.82	13.00	-4.18
High	5240	7.11	13.00	-5.89

Test mode: IEEE 802.11n HT 20 MHz mode / 5180 ~ 5240MHz / Chain 0

Channel	Frequency (MHz)	Peak Excursion (dB)	Limit (dB)	Margin (dB)
Low	5180	8.07	13.00	-4.93
Mid	5220	8.38	13.00	-4.62
High	5240	7.23	13.00	-5.77

Test mode: IEEE 802.11n HT 20 MHz mode / 5180 ~ 5240MHz / Chain 1

Channel	Frequency (MHz)	Peak Excursion (dB)	Limit (dB)	Margin (dB)
Low	5180	9.73	13.00	-3.27
Mid	5220	9.28	13.00	-3.72
High	5240	8.27	13.00	-4.73

Test mode: IEEE 802.11n HT 20 MHz mode / 5180 ~ 5240MHz / Chain 2

Channel	Frequency (MHz)	Peak Excursion (dB)	Limit (dB)	Margin (dB)
Low	5180	9.23	13.00	-3.77
Mid	5220	9.04	13.00	-3.96
High	5240	9.94	13.00	-3.06



Test mode: IEEE 802.11n HT 40 MHz mode / 5190 ~ 5230MHz / Chain 0

Channel	Frequency (MHz)	Peak Excursion (dB)	Limit (dB)	Margin (dB)
Low	5190	9.00	13.00	-4.00
High	5230	8.83	13.00	-4.17

Test mode: IEEE 802.11n HT 40 MHz mode / 5190 ~ 5230MHz / Chain 1

Channel	Frequency (MHz)	Peak Excursion (dB)	Limit (dB)	Margin (dB)
Low	5190	10.34	13.00	-2.66
High	5230	9.18	13.00	-3.82

Test mode: IEEE 802.11n HT 40 MHz mode / 5190 ~ 5230MHz / Chain 2

Channel	Frequency (MHz)	Peak Excursion (dB)	Limit (dB)	Margin (dB)
Low	5190	10.25	13.00	-2.75
High	5230	9.77	13.00	-3.23



Test Plot

IEEE 802.11a mode / 5180 ~ 5240MHz

CH Low

Agilent 16:42:41 Jul 20, 2011

R L

Δ Mkr1 0 Hz
7.73 dB

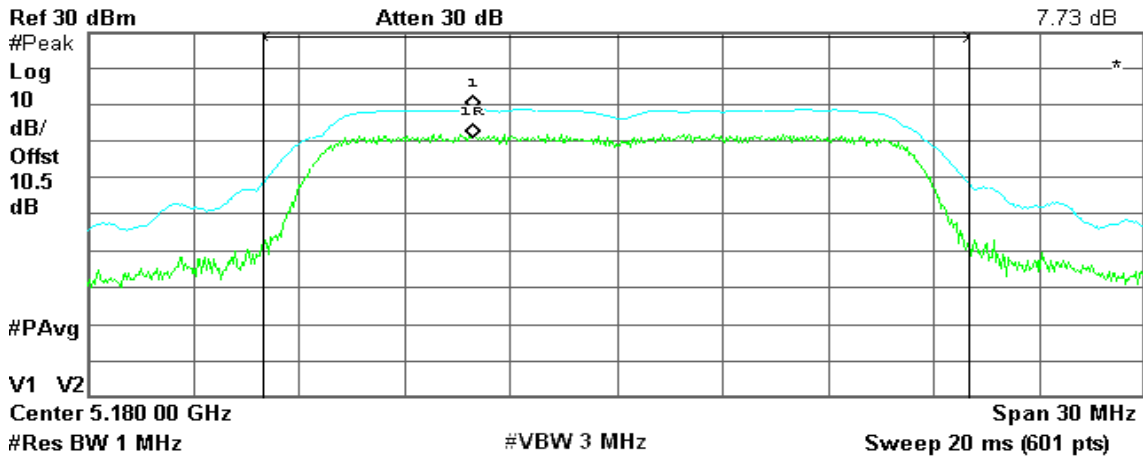

Channel Power

18.65 dBm / 20.0000 MHz

Power Spectral Density

-54.36 dBm/Hz

CH Mid

Agilent 16:47:43 Jul 20, 2011

R T

Δ Mkr1 0 Hz
8.82 dB

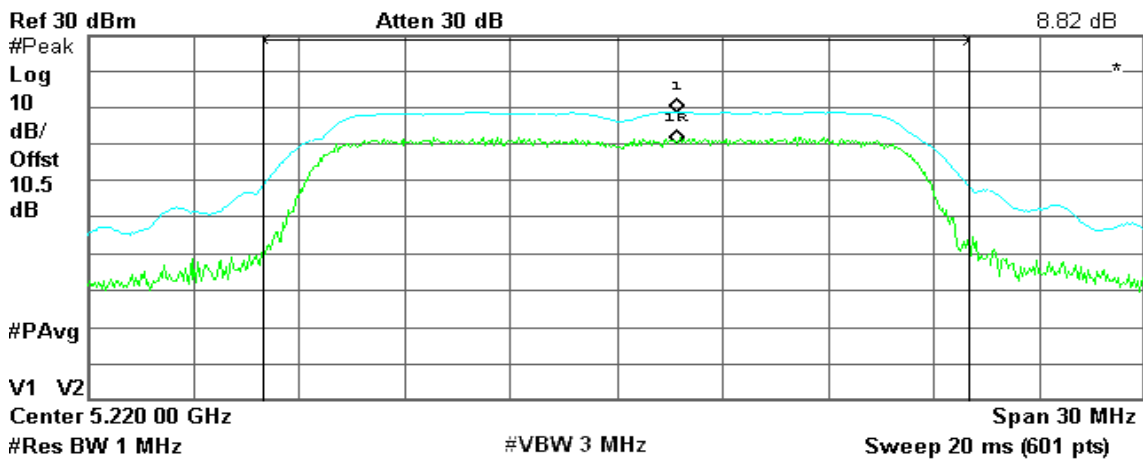

Channel Power

18.79 dBm / 20.0000 MHz

Power Spectral Density

-54.22 dBm/Hz



CH High

Agilent 16:50:59 Jul 20, 2011

R T

Δ Mkr1 0 Hz
7.11 dB

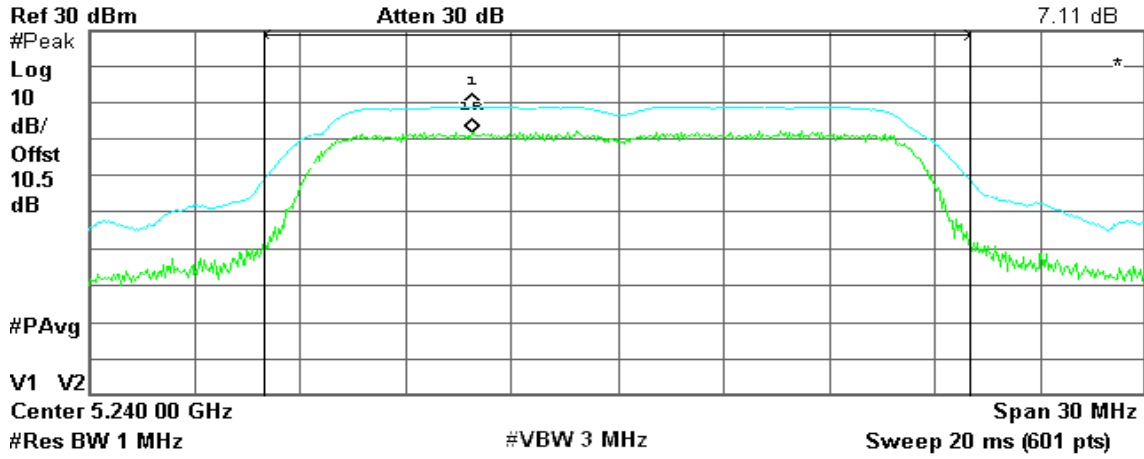

Channel Power

19.05 dBm / 20.0000 MHz

Power Spectral Density

-53.96 dBm/Hz



IEEE 802.11n HT 20 MHz mode / 5180 ~ 5240MHz / Chain 0

CH Low

Agilent 17:49:07 Jul 20, 2011

R T

Δ Mkr1 0 Hz
8.07 dB

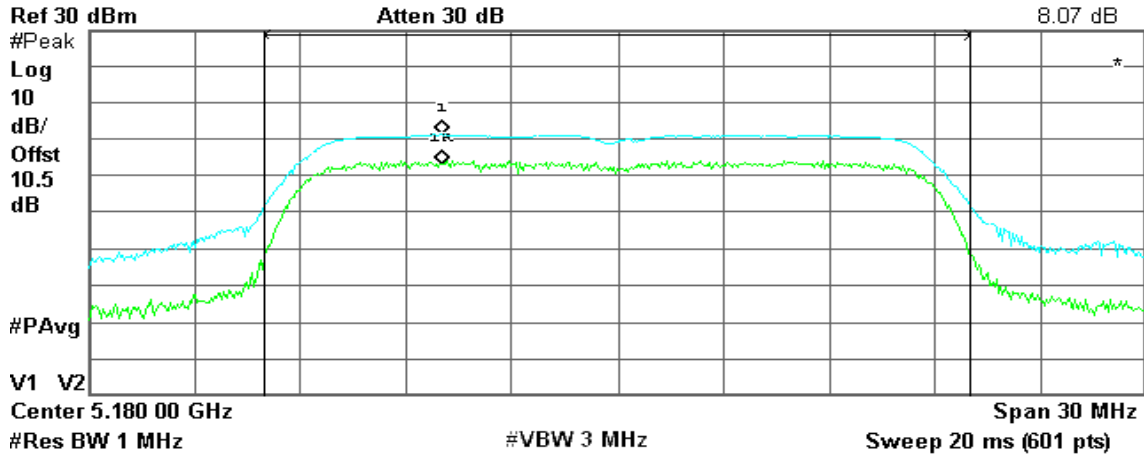

Channel Power

11.23 dBm / 20.0000 MHz

Power Spectral Density

-61.78 dBm/Hz

CH Mid

Agilent 17:54:57 Jul 20, 2011

R T

Δ Mkr1 0 Hz
8.38 dB

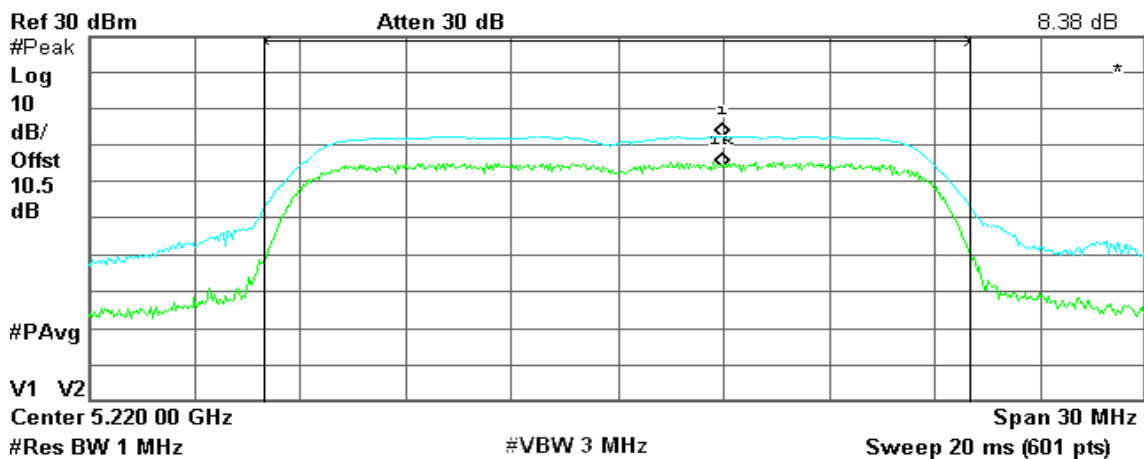

Channel Power

12.41 dBm / 20.0000 MHz

Power Spectral Density

-60.60 dBm/Hz



CH High

Agilent 18:09:30 Jul 20, 2011

R L

Δ Mkr1 0 Hz
7.23 dB

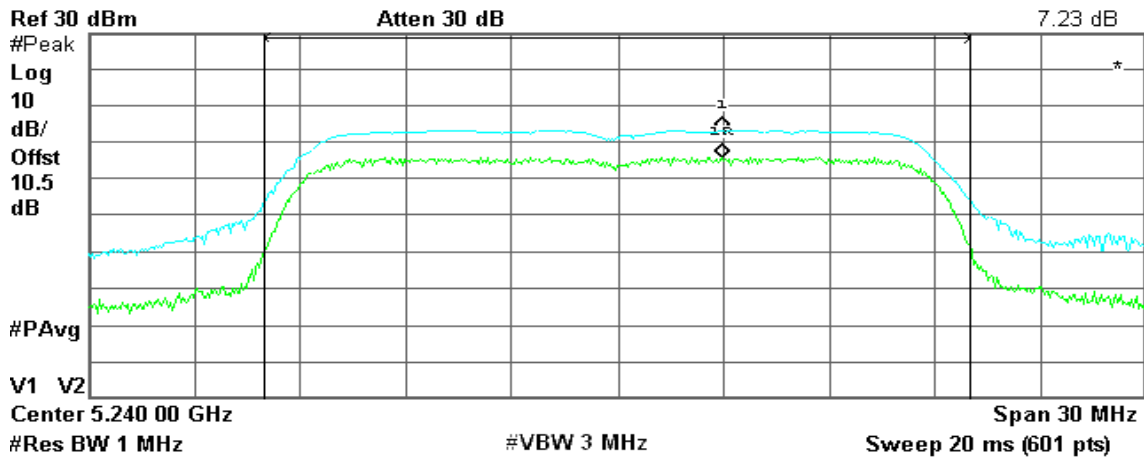

Channel Power

13.27 dBm / 20.0000 MHz

Power Spectral Density

-59.74 dBm/Hz



IEEE 802.11n HT 20 MHz mode / 5180 ~ 5240MHz / Chain 1

CH Low

Agilent 18:19:39 Jul 20, 2011

R T

Δ Mkr1 0 Hz
9.73 dB

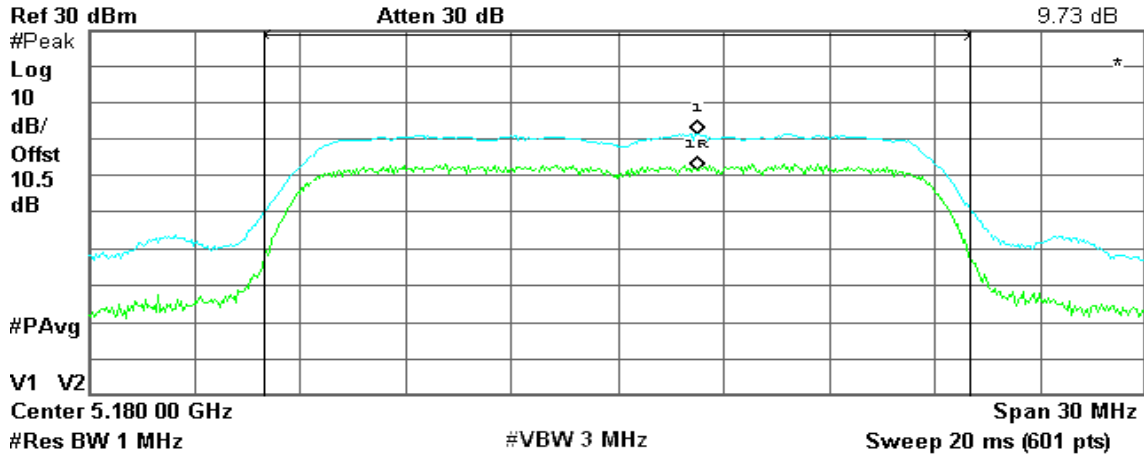

Channel Power

10.30 dBm / 20.0000 MHz

Power Spectral Density

-62.71 dBm/Hz

CH Mid

Agilent 18:16:55 Jul 20, 2011

R T

Δ Mkr1 0 Hz
9.28 dB

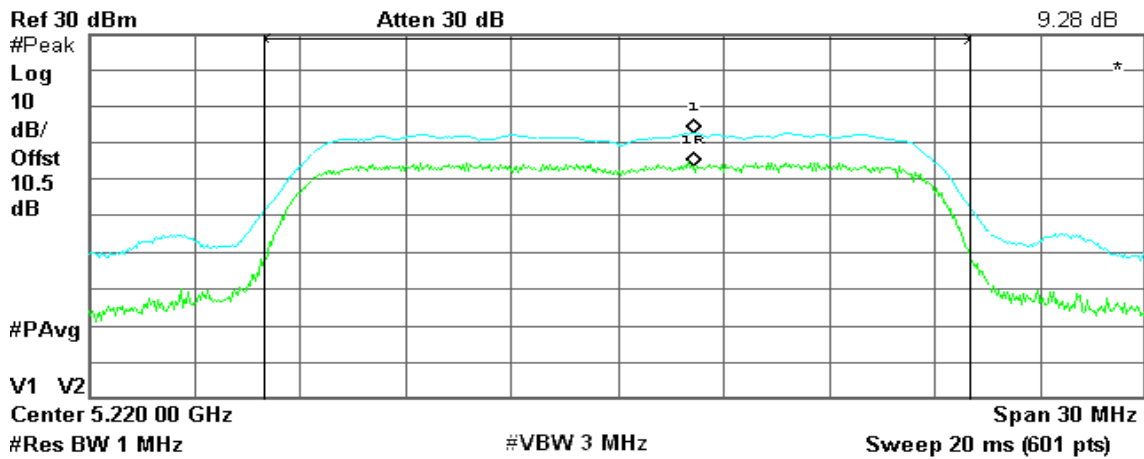

Channel Power

11.62 dBm / 20.0000 MHz

Power Spectral Density

-61.39 dBm/Hz



CH High

Agilent 18:13:59 Jul 20, 2011

R T

Δ Mkr1 0 Hz
8.27 dB

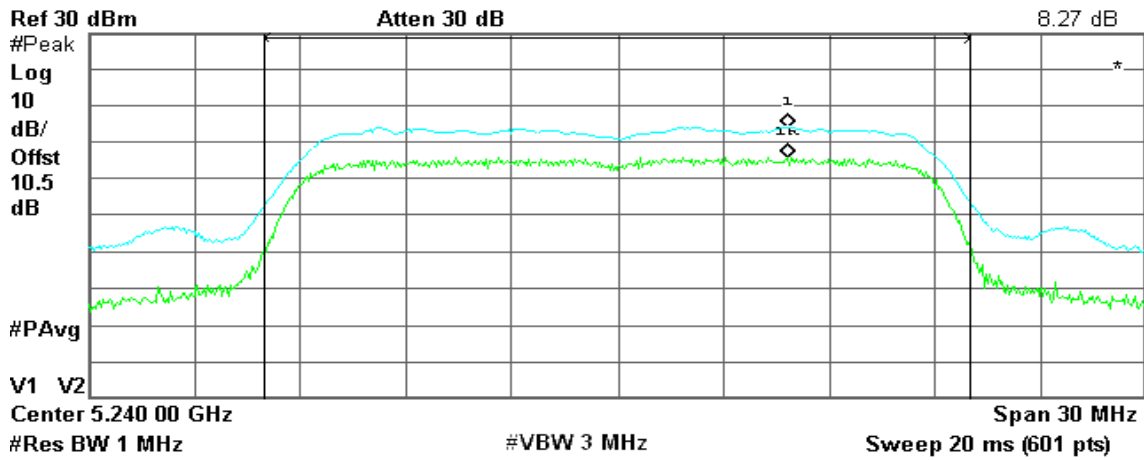

Channel Power

12.96 dBm / 20.0000 MHz

Power Spectral Density

-60.05 dBm/Hz



IEEE 802.11n HT 20 MHz mode / 5180 ~ 5240MHz / Chain 2

CH Low

Agilent 18:46:39 Jul 20, 2011

R T

Δ Mkr1 0 Hz
9.23 dB

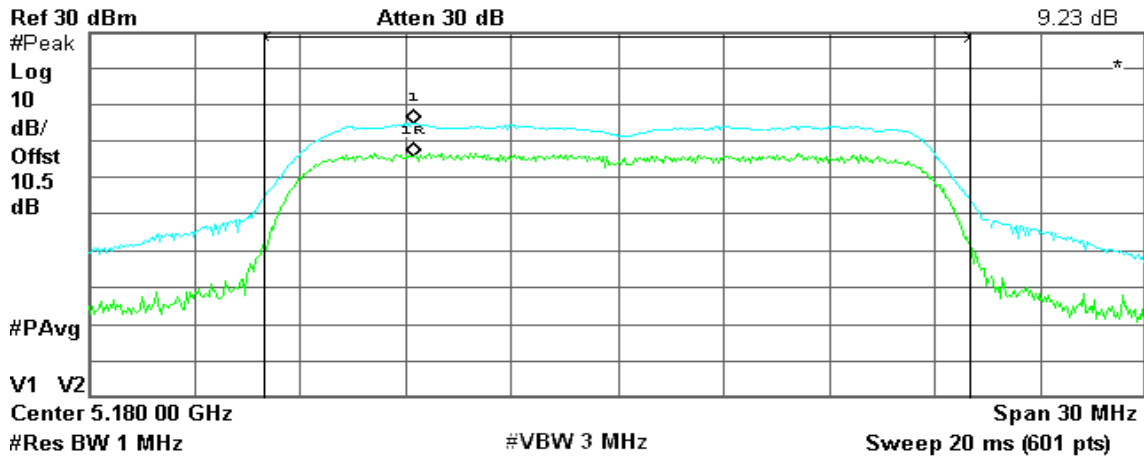

Channel Power

13.83 dBm / 20.0000 MHz

Power Spectral Density

-59.18 dBm/Hz

CH Mid

Agilent 18:51:23 Jul 20, 2011

R T

Δ Mkr1 0 Hz
9.04 dB

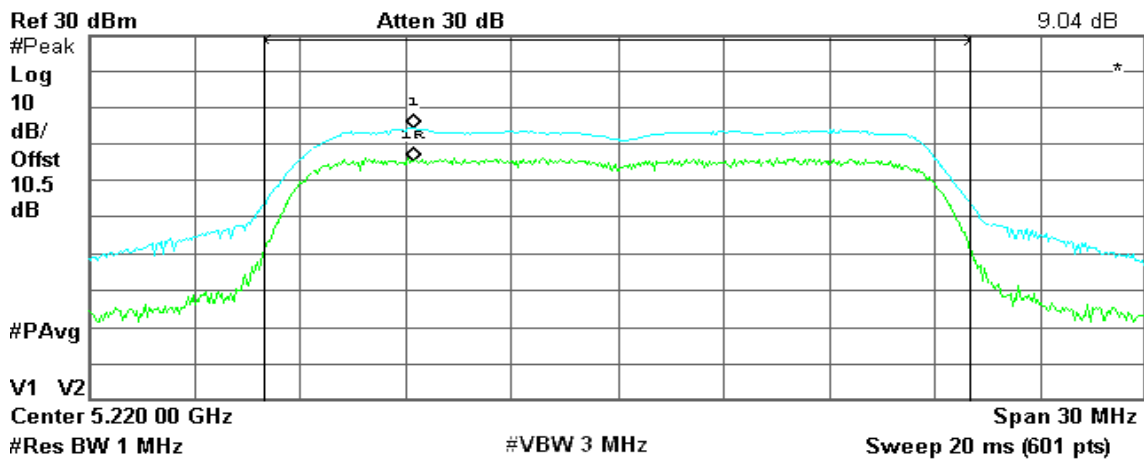

Channel Power

13.38 dBm / 20.0000 MHz

Power Spectral Density

-59.63 dBm/Hz



CH High

Agilent 18:55:44 Jul 20, 2011

R T

Δ Mkr1 0 Hz
9.94 dB

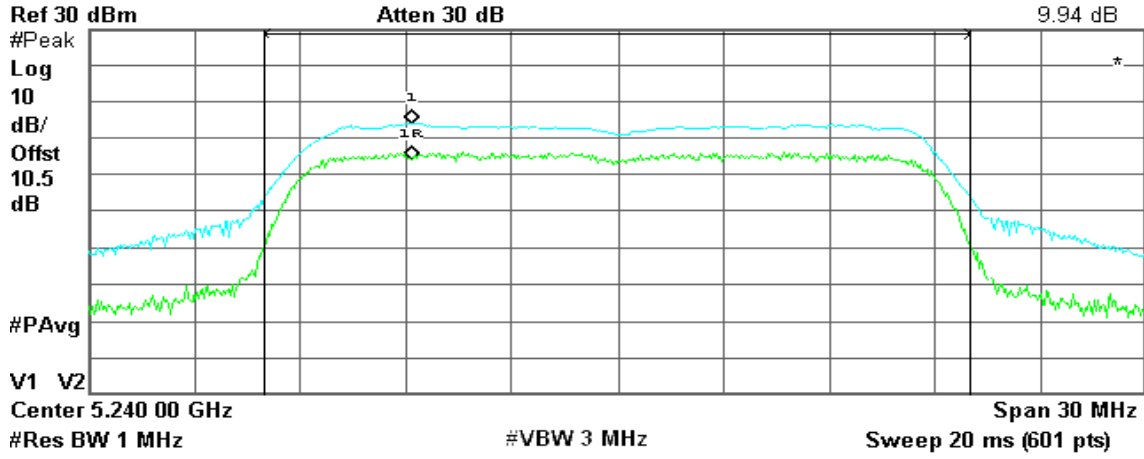

Channel Power

13.28 dBm / 20.0000 MHz

Power Spectral Density

-59.73 dBm/Hz



IEEE 802.11n HT 40 MHz mode / 5190 ~ 5230MHz / Chain 0

CH Low

Agilent 12:18:14 Jul 21, 2011

R T

Δ Mkr1 0 Hz
9.00 dB

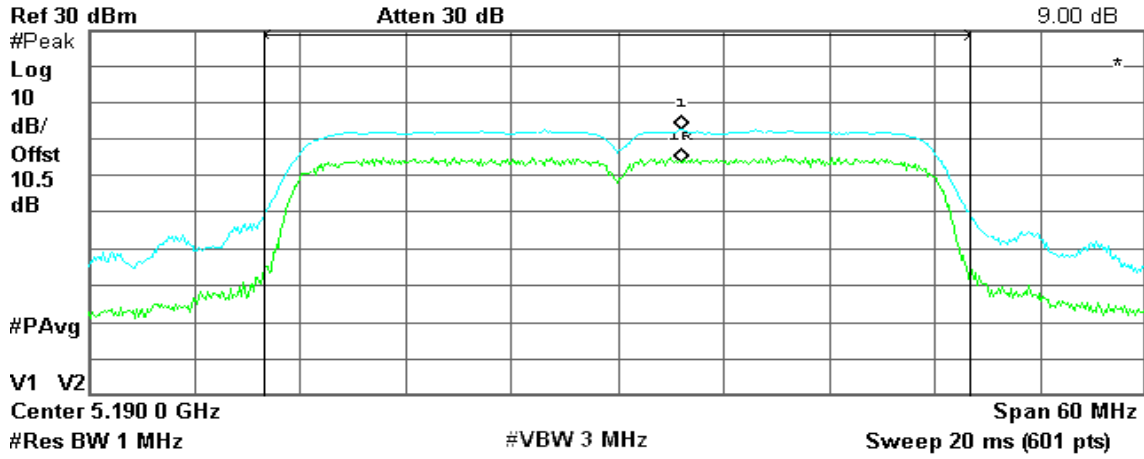

Channel Power

15.37 dBm / 40.0000 MHz

Power Spectral Density

-60.65 dBm/Hz

CH High

Agilent 12:21:05 Jul 21, 2011

R T

Δ Mkr1 0 Hz
8.83 dB

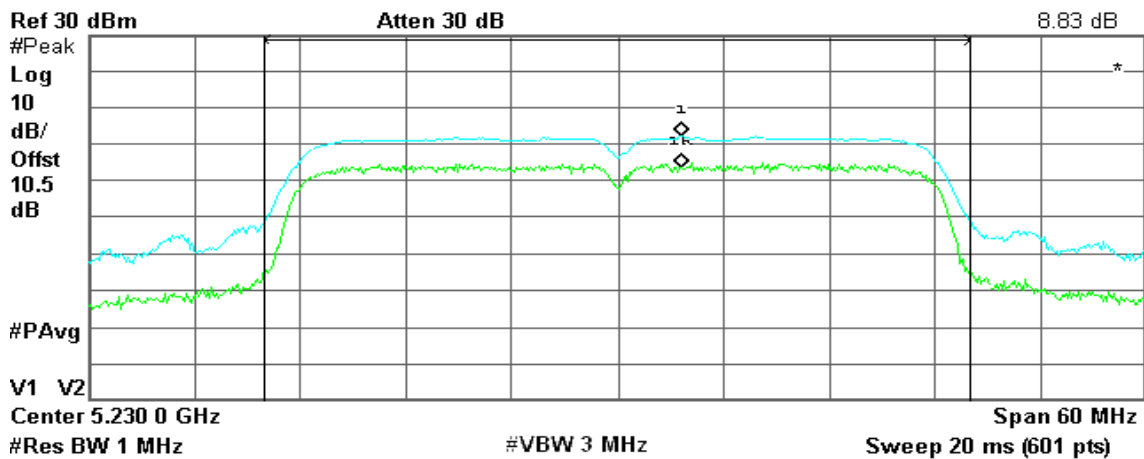

Channel Power

14.76 dBm / 40.0000 MHz

Power Spectral Density

-61.26 dBm/Hz



IEEE 802.11n HT 40 MHz mode / 5190 ~ 5230MHz / Chain 1

CH Low

Agilent 12:14:49 Jul 21, 2011

R T

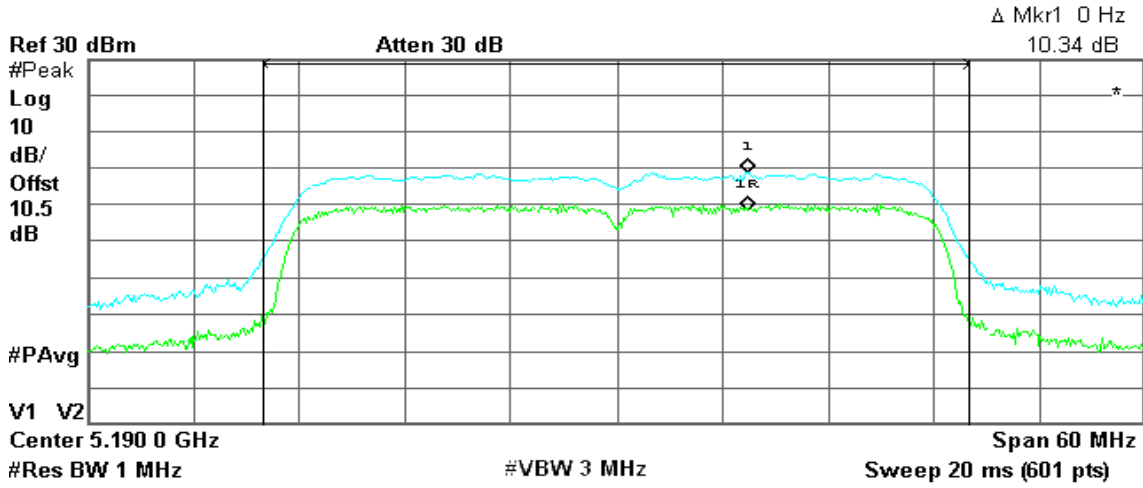

Channel Power

10.54 dBm / 40.0000 MHz

Power Spectral Density

-65.48 dBm/Hz

CH High

Agilent 12:12:22 Jul 21, 2011

R T

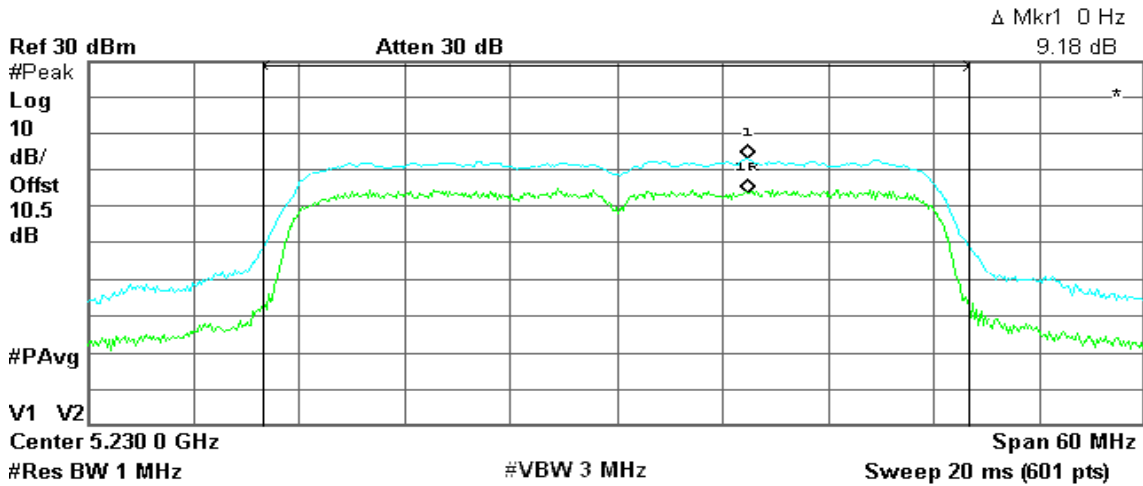

Channel Power

14.51 dBm / 40.0000 MHz

Power Spectral Density

-61.51 dBm/Hz



IEEE 802.11n HT 40 MHz mode / 5190 ~ 5230MHz / Chain 2

CH Low

Agilent 11:48:59 Jul 21, 2011

R L

Δ Mkr1 0 Hz
10.25 dB

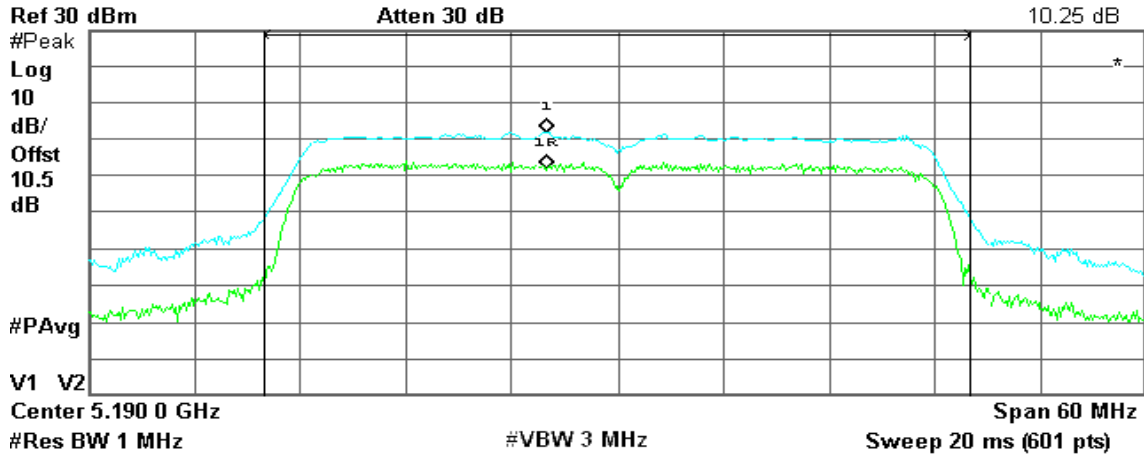

Channel Power

13.73 dBm / 40.0000 MHz

Power Spectral Density

-62.29 dBm/Hz

CH High

Agilent 12:07:46 Jul 21, 2011

R T

Δ Mkr1 0 Hz
9.77 dB

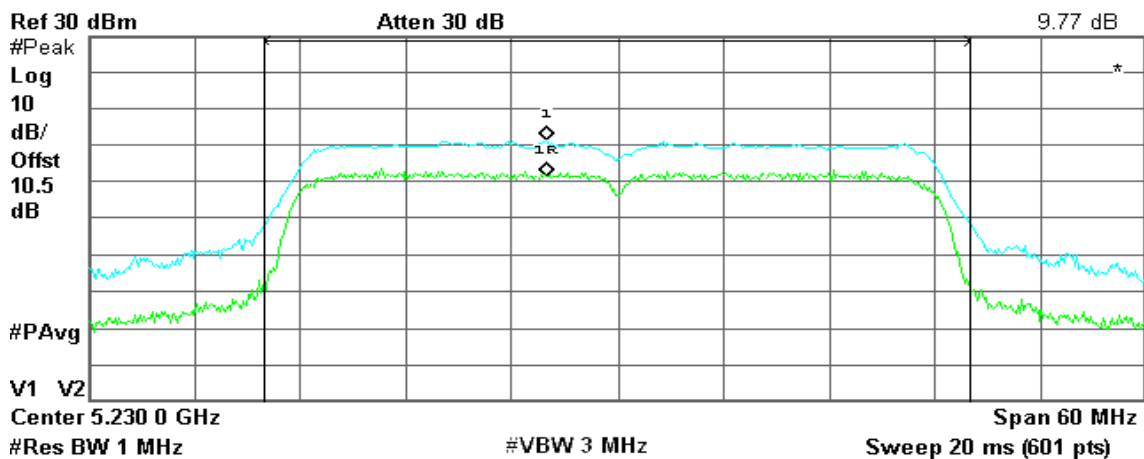

Channel Power

13.12 dBm / 40.0000 MHz

Power Spectral Density

-62.91 dBm/Hz



7.6 RADIATED UNDESIRABLE EMISSION

1. According to §15.209(a), except as provided elsewhere in this Subpart, the emissions from an intentional radiator shall not exceed the field strength levels specified in the following table:

Frequency (MHz)	Field Strength ($\mu\text{V/m}$)	Measurement Distance (m)
30-88	100*	3
88-216	150*	3
216-960	200*	3
Above 960	500	3

Remark: Except as provided in paragraph (g), fundamental emissions from intentional radiators operating under this Section shall not be located in the frequency bands 54-72 MHz, 76-88 MHz, 174-216 MHz or 470-806 MHz. However, operation within these frequency bands is permitted under other sections of this Part, e.g., Sections 15.231 and 15.241.

2. In the emission table above, the tighter limit applies at the band edges.

Frequency (MHz)	Field Strength ($\mu\text{V/m}$ at 3-meter)	Field Strength (dB $\mu\text{V/m}$ at 3-meter)
30-88	100	40
88-216	150	43.5
216-960	200	46
Above 960	500	54



Test Configuration

9kHz ~ 30MHz

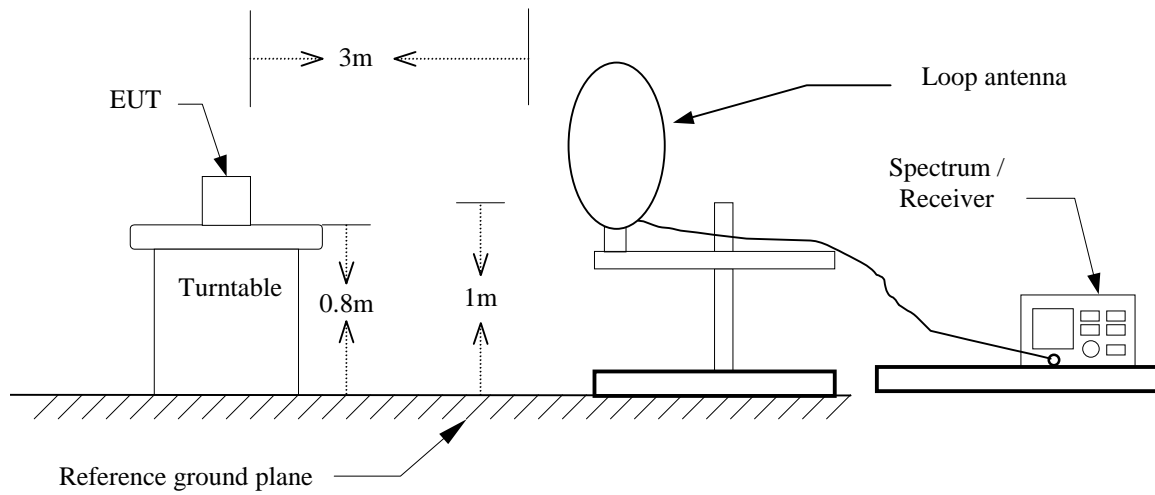

30MHz ~ 1GHz

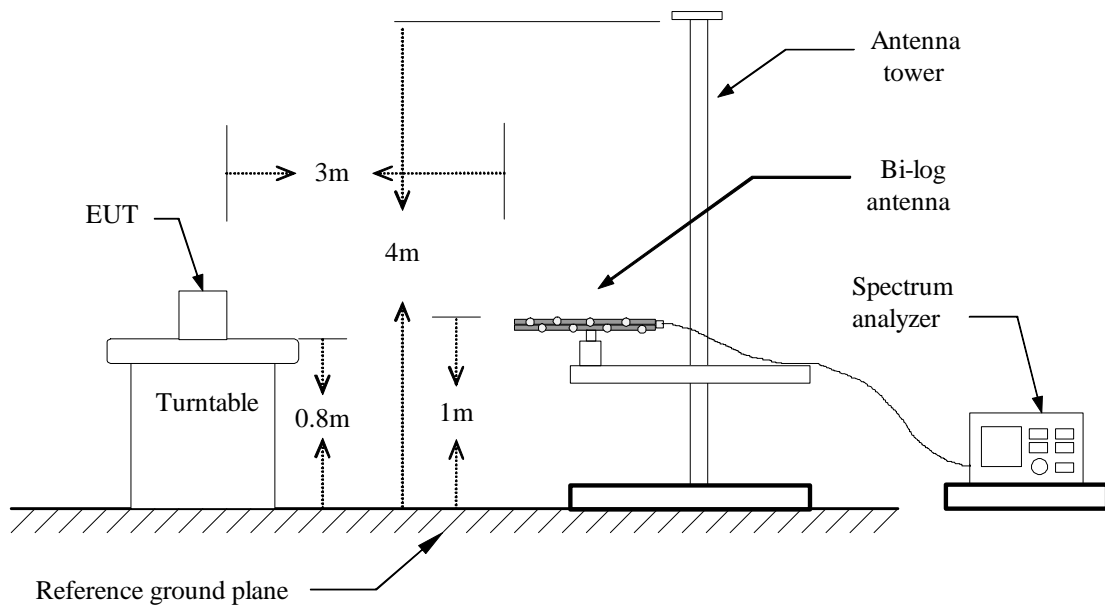



Above 1 GHz

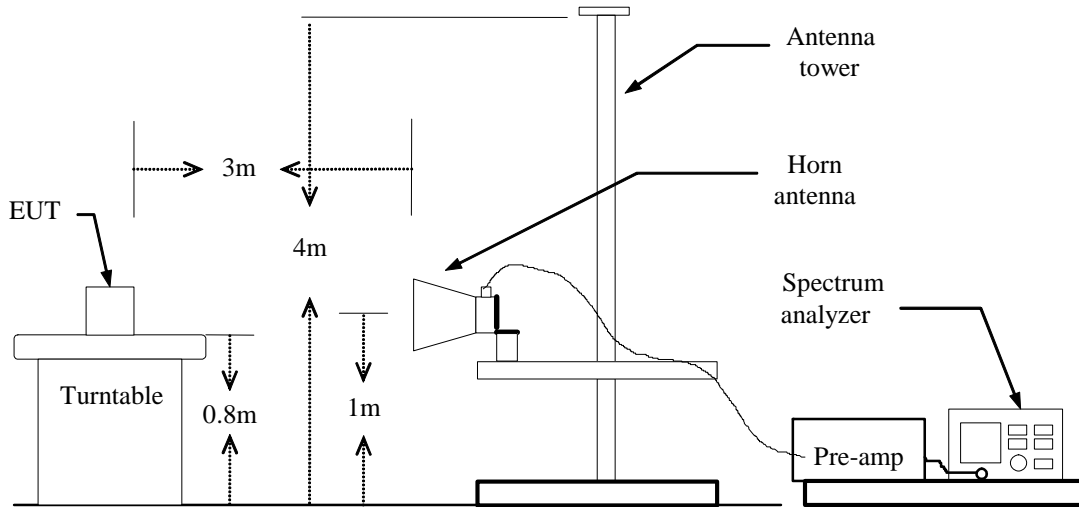



TEST PROCEDURE

1. The EUT is placed on a turntable, which is 0.8m above ground plane.
2. The turntable shall be rotated for 360 degrees to determine the position of maximum emission level.
3. EUT is set 3m away from the receiving antenna, which is varied from 1m to 4m to find out the highest emissions.
4. Maximum procedure was performed on the six highest emissions to ensure EUT compliance.
5. And also, each emission was to be maximized by changing the polarization of receiving antenna both horizontal and vertical.
6. Set the spectrum analyzer in the following setting as:

Below 1GHz:

RBW=100kHz / VBW=300kHz / Sweep=AUTO

Above 1GHz:

(a) PEAK: RBW=VBW=1MHz / Sweep=AUTO

(b) AVERAGE: RBW=1MHz / VBW=10Hz / Sweep=AUTO

7. Repeat above procedures until the measurements for all frequencies are complete.

**Below 1GHz****Operation Mode:** Normal Link**Test Date:** July 11, 2011**Temperature:** 25°C**Tested by:** Sehni Hu**Humidity:** 50% RH**Polarity:** Ver. / Hor.

Frequency (MHz)	Reading (dBuV)	Correction Factor (dB/m)	Result (dBuV/m)	Limit (dBuV/m)	Margin (dB)	Remark	Ant. Pol. (H/V)
84.97	45.12	-15.31	29.81	40.00	-10.19	QP	V
249.87	42.17	-10.90	31.26	46.00	-14.74	Peak	V
374.35	39.63	-7.58	32.05	46.00	-13.95	Peak	V
500.45	35.38	-5.14	30.24	46.00	-15.76	Peak	V
624.93	37.88	-3.48	34.41	46.00	-11.59	Peak	V
875.52	31.51	-0.73	30.78	46.00	-15.22	Peak	V
160.95	40.93	-10.60	30.33	43.50	-13.17	Peak	H
249.87	46.51	-10.90	35.61	46.00	-10.39	Peak	H
374.35	43.59	-7.58	36.01	46.00	-9.99	Peak	H
624.93	38.30	-3.48	34.82	46.00	-11.18	Peak	H
749.42	34.25	-1.83	32.42	46.00	-13.58	Peak	H
875.52	33.06	-0.73	32.32	46.00	-13.68	Peak	H

Remark:

1. No emission found between lowest internal used/generated frequency to 30MHz (9kHz~30MHz)
2. Radiated emissions measured in frequency range from 30 MHz to 1000MHz were made with an instrument using peak/quasi-peak detector mode.
3. Quasi-peak test would be performed if the peak result were greater than the quasi-peak limit.
4. Data of measurement within this frequency range shown " --- " in the table above means the reading of emissions are attenuated more than 20dB below the permissible limits or the field strength is too small to be measured.
5. Measurements above show only up to 6 maximum emissions noted, or would be lesser; with " N/A " remark, if no specific emissions from the EUT are recorded (ie: margin > 20dB from the applicable limit) and considered that's already beyond the background noise floor.
6. Margin (dB) = Remark result (dBuV/m) – Quasi-peak limit (dBuV/m).



Above 1 GHz

Operation Mode: Tx / IEEE 802.11a mode / 5180 ~ 5240MHz / CH Low **Test Date:** July 9, 2011

Temperature: 25°C **Tested by:** Sehni Hu

Humidity: 50% RH **Polarity:** Ver. / Hor.

Frequency (MHz)	Reading (Peak) (dBuV)	Reading (Average) (dBuV)	Correction Factor (dB/m)	Result (Peak) (dBuV/m)	Result (Average) (dBuV/m)	Limit (Peak) (dBuV/m)	Limit (Average) (dBuV/m)	Margin (dB)	Remark	Ant.Pol. (H/V)
2038.33	56.16	---	-5.37	50.79	---	74.00	54.00	-3.21	Peak	V
N/A										
2038.33	55.16	---	-5.37	49.79	---	74.00	54.00	-4.21	Peak	H
N/A										

Remark:

1. Measuring frequencies from 1 GHz to the 10th harmonic of highest fundamental frequency.
2. Radiated emissions measured in frequency above 1000MHz were made with an instrument using peak/average detector mode.
3. Average test would be performed if the peak result were greater than the average limit.
4. Data of measurement within this frequency range shown " --- " in the table above means the reading of emissions are attenuated more than 20dB below the permissible limits or the field strength is too small to be measured.
5. Measurements above show only up to 6 maximum emissions noted, or would be lesser, with " N/A " remark, if no specific emissions from the EUT are recorded (ie: margin>20dB from the applicable limit) and considered that's already beyond the background noise floor.
6. Margin (dB) = Remark result (dBuV/m) – Average limit (dBuV/m).



Operation Mode: Tx / IEEE 802.11a mode / 5180 ~ 5240MHz / CH Mid **Test Date:** July 9, 2011
Temperature: 25°C **Tested by:** Sehni Hu
Humidity: 50% RH **Polarity:** Ver. / Hor.

Frequency (MHz)	Reading (Peak) (dBuV)	Reading (Average) (dBuV)	Correction Factor (dB/m)	Result (Peak) (dBuV/m)	Result (Average) (dBuV/m)	Limit (Peak) (dBuV/m)	Limit (Average) (dBuV/m)	Margin (dB)	Remark	Ant.Pol. (H/V)
2330.00	56.10	---	-4.57	51.54	---	74.00	54.00	-2.46	Peak	V
N/A										
1980.00	55.85	---	-5.67	50.18	---	74.00	54.00	-3.82	Peak	H
N/A										

Remark:

1. Measuring frequencies from 1 GHz to the 10th harmonic of highest fundamental frequency.
2. Radiated emissions measured in frequency above 1000MHz were made with an instrument using peak/average detector mode.
3. Average test would be performed if the peak result were greater than the average limit.
4. Data of measurement within this frequency range shown " --- " in the table above means the reading of emissions are attenuated more than 20dB below the permissible limits or the field strength is too small to be measured.
5. Measurements above show only up to 6 maximum emissions noted, or would be lesser, with " N/A " remark, if no specific emissions from the EUT are recorded (ie: margin>20dB from the applicable limit) and considered that's already beyond the background noise floor.
6. Margin (dB) = Remark result (dBuV/m) – Average limit (dBuV/m).



Operation Mode: Tx / IEEE 802.11a mode / 5180 ~ 5240MHz /CH High

Test Date: July 9, 2011

Temperature: 25°C

Tested by: Sehni Hu

Humidity: 50% RH

Polarity: Ver. / Hor.

Frequency (MHz)	Reading (Peak) (dBuV)	Reading (Average) (dBuV)	Correction Factor (dB/m)	Result (Peak) (dBuV/m)	Result (Average) (dBuV/m)	Limit (Peak) (dBuV/m)	Limit (Average) (dBuV/m)	Margin (dB)	Remark	Ant.Pol. (H/V)
2330.00	55.07	---	-4.57	50.50	---	74.00	54.00	-3.50	Peak	V
N/A										
1933.33	56.62	---	-6.15	50.47	---	74.00	54.00	-3.53	Peak	H
N/A										

Remark:

1. Measuring frequencies from 1 GHz to the 10th harmonic of highest fundamental frequency.
2. Radiated emissions measured in frequency above 1000MHz were made with an instrument using peak/average detector mode.
3. Average test would be performed if the peak result were greater than the average limit.
4. Data of measurement within this frequency range shown “ --- ” in the table above means the reading of emissions are attenuated more than 20dB below the permissible limits or the field strength is too small to be measured.
5. Measurements above show only up to 6 maximum emissions noted, or would be lesser, with “ N/A ” remark, if no specific emissions from the EUT are recorded (ie: margin>20dB from the applicable limit) and considered that's already beyond the background noise floor.
6. Margin (dB) = Remark result (dBuV/m) – Average limit (dBuV/m).



Operation Mode: Tx / IEEE 802.11n HT 20 MHz mode / 5180 ~ 5240MHz / CH Low **Test Date:** July 9, 2011

Temperature: 25°C **Tested by:** Sehni Hu

Humidity: 50% RH **Polarity:** Ver. / Hor.

Frequency (MHz)	Reading (Peak) (dBuV)	Reading (Average) (dBuV)	Correction Factor (dB/m)	Result (Peak) (dBuV/m)	Result (Average) (dBuV/m)	Limit (Peak) (dBuV/m)	Limit (Average) (dBuV/m)	Margin (dB)	Remark	Ant.Pol. (H/V)
2096.67	56.52	---	-5.22	51.30	---	74.00	54.00	-2.70	Peak	V
N/A										
2306.67	55.76	---	-4.66	51.10	---	74.00	54.00	-2.90	Peak	H
N/A										

Remark:

1. Measuring frequencies from 1 GHz to the 10th harmonic of highest fundamental frequency.
2. Radiated emissions measured in frequency above 1000MHz were made with an instrument using peak/average detector mode.
3. Average test would be performed if the peak result were greater than the average limit.
4. Data of measurement within this frequency range shown “ --- ” in the table above means the reading of emissions are attenuated more than 20dB below the permissible limits or the field strength is too small to be measured.
5. Measurements above show only up to 6 maximum emissions noted, or would be lesser, with “ N/A ” remark, if no specific emissions from the EUT are recorded (ie: margin>20dB from the applicable limit) and considered that's already beyond the background noise floor.
6. Margin (dB) = Remark result (dBuV/m) – Average limit (dBuV/m).



Operation Mode: Tx / IEEE 802.11n HT 20 MHz mode / 5180 ~ 5240MHz / CH Mid **Test Date:** July 9, 2011

Temperature: 25°C **Tested by:** Sehni Hu

Humidity: 50% RH **Polarity:** Ver. / Hor.

Frequency (MHz)	Reading (Peak) (dBuV)	Reading (Average) (dBuV)	Correction Factor (dB/m)	Result (Peak) (dBuV/m)	Result (Average) (dBuV/m)	Limit (Peak) (dBuV/m)	Limit (Average) (dBuV/m)	Margin (dB)	Remark	Ant.Pol. (H/V)
2050.00	55.68	---	-5.34	50.34	---	74.00	54.00	-3.66	Peak	V
N/A										
2435.00	55.77	---	-4.14	51.63	---	74.00	54.00	-2.37	Peak	H
N/A										

Remark:

1. Measuring frequencies from 1 GHz to the 10th harmonic of highest fundamental frequency.
2. Radiated emissions measured in frequency above 1000MHz were made with an instrument using peak/average detector mode.
3. Average test would be performed if the peak result were greater than the average limit.
4. Data of measurement within this frequency range shown " --- " in the table above means the reading of emissions are attenuated more than 20dB below the permissible limits or the field strength is too small to be measured.
5. Measurements above show only up to 6 maximum emissions noted, or would be lesser, with " N/A " remark, if no specific emissions from the EUT are recorded (ie: margin>20dB from the applicable limit) and considered that's already beyond the background noise floor.
6. Margin (dB) = Remark result (dBuV/m) – Average limit (dBuV/m).



Operation Mode: Tx / IEEE 802.11n HT 20 MHz mode / 5180 ~ 5240MHz / CH High **Test Date:** July 9, 2011

Temperature: 25°C **Tested by:** Sehni Hu

Humidity: 50% RH **Polarity:** Ver. / Hor.

Frequency (MHz)	Reading (Peak) (dBuV)	Reading (Average) (dBuV)	Correction Factor (dB/m)	Result (Peak) (dBuV/m)	Result (Average) (dBuV/m)	Limit (Peak) (dBuV/m)	Limit (Average) (dBuV/m)	Margin (dB)	Remark	Ant.Pol. (H/V)
2073.33	56.48	---	-5.28	51.20	---	74.00	54.00	-2.80	Peak	V
N/A										
2178.33	56.78	---	-5.01	51.77	---	74.00	54.00	-2.23	AVG	H
N/A										

Remark:

1. Measuring frequencies from 1 GHz to the 10th harmonic of highest fundamental frequency.
2. Radiated emissions measured in frequency above 1000MHz were made with an instrument using peak/average detector mode.
3. Average test would be performed if the peak result were greater than the average limit.
4. Data of measurement within this frequency range shown " --- " in the table above means the reading of emissions are attenuated more than 20dB below the permissible limits or the field strength is too small to be measured.
5. Measurements above show only up to 6 maximum emissions noted, or would be lesser, with " N/A " remark, if no specific emissions from the EUT are recorded (ie: margin>20dB from the applicable limit) and considered that's already beyond the background noise floor.
6. Margin (dB) = Remark result (dBuV/m) – Average limit (dBuV/m).



Operation Mode: Tx / IEEE 802.11n HT 40 MHz mode / 5190 ~ 5230MHz / CH Low **Test Date:** July 9, 2011

Temperature: 25°C **Tested by:** Sehni Hu

Humidity: 50% RH **Polarity:** Ver. / Hor.

Frequency (MHz)	Reading (Peak) (dBuV)	Reading (Average) (dBuV)	Correction Factor (dB/m)	Result (Peak) (dBuV/m)	Result (Average) (dBuV/m)	Limit (Peak) (dBuV/m)	Limit (Average) (dBuV/m)	Margin (dB)	Remark	Ant.Pol. (H/V)
2493.33	55.49	---	-3.90	51.60	---	74.00	54.00	-2.40	Peak	V
N/A										
2808.33	54.75	---	-2.82	51.93	---	74.00	54.00	-2.07	Peak	H
N/A										

Remark:

1. Measuring frequencies from 1 GHz to the 10th harmonic of highest fundamental frequency.
2. Radiated emissions measured in frequency above 1000MHz were made with an instrument using peak/average detector mode.
3. Average test would be performed if the peak result were greater than the average limit.
4. Data of measurement within this frequency range shown “ --- ” in the table above means the reading of emissions are attenuated more than 20dB below the permissible limits or the field strength is too small to be measured.
5. Measurements above show only up to 6 maximum emissions noted, or would be lesser, with “ N/A ” remark, if no specific emissions from the EUT are recorded (ie: margin>20dB from the applicable limit) and considered that's already beyond the background noise floor.
6. Margin (dB) = Remark result (dBuV/m) – Average limit (dBuV/m).



Operation Mode: Tx / IEEE 802.11n HT 40 MHz mode / 5190 ~ 5230MHz / CH High **Test Date:** July 9, 2011

Temperature: 25°C **Tested by:** Sehni Hu

Humidity: 50% RH **Polarity:** Ver. / Hor.

Frequency (MHz)	Reading (Peak) (dBuV)	Reading (Average) (dBuV)	Correction Factor (dB/m)	Result (Peak) (dBuV/m)	Result (Average) (dBuV/m)	Limit (Peak) (dBuV/m)	Limit (Average) (dBuV/m)	Margin (dB)	Remark	Ant.Pol. (H/V)
2038.33	56.32	---	-5.37	50.95	---	74.00	54.00	-3.05	Peak	V
N/A										
2283.33	56.49	---	-4.73	51.76	---	74.00	54.00	-2.24	Peak	H
N/A										

Remark:

1. Measuring frequencies from 1 GHz to the 10th harmonic of highest fundamental frequency.
2. Radiated emissions measured in frequency above 1000MHz were made with an instrument using peak/average detector mode.
3. Average test would be performed if the peak result were greater than the average limit.
4. Data of measurement within this frequency range shown “ --- ” in the table above means the reading of emissions are attenuated more than 20dB below the permissible limits or the field strength is too small to be measured.
5. Measurements above show only up to 6 maximum emissions noted, or would be lesser, with “ N/A ” remark, if no specific emissions from the EUT are recorded (ie: margin>20dB from the applicable limit) and considered that's already beyond the background noise floor.
6. Margin (dB) = Remark result (dBuV/m) – Average limit (dBuV/m).



7.7 CONDUCTED UNDESIRABLE EMISSION

LIMIT

According to 15.407(b),

- (1) For transmitters operating in the 5.15-5.25 GHz band: all emissions outside of the 5.15-5.35 GHz band shall not exceed an EIRP of -27 dBm/MHz.
- (2) For transmitters operating in the 5.25-5.35 GHz band: all emissions outside of the 5.15-5.35 GHz band shall not exceed an EIRP of -27 dBm/MHz. Devices operating in the 5.25-5.35 GHz band that generate emissions in the 5.15-5.25 GHz band must meet all applicable technical requirements for operation in the 5.15-5.25 GHz band (including indoor use) or alternatively meet an out-of-band emission EIRP limit of -27 dBm/MHz in the 5.15-5.25 GHz band.

The provisions of §15.205 apply to intentional radiators operating under this section.

Test Configuration

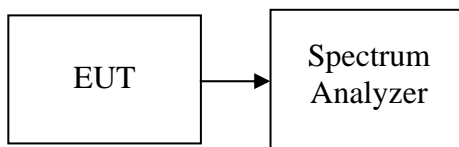

TEST PROCEDURE

Conducted RF measurements of the transmitter output were made to confirm that the EUT antenna port conducted emissions meet the specified limit and to identify any spurious signals that require further investigation or measurements on the radiated emissions site.

The transmitter output is connected to the spectrum analyzer. The resolution bandwidth is set to 1 MHz. The video bandwidth is set to 1 MHz. Peak detection measurements are compared to the average EIRP limit, adjusted for the maximum antenna gain. If necessary, additional average detection measurements are made.

Measurements are made over the 30 MHz to 40 GHz range with the transmitter set to the lowest, middle, and highest channels.

TEST RESULTS

No non-compliance noted



Test Plot

IEEE 802.11a mode / 5180 ~ 5240MHz

CH Low

Agilent 16:43:43 Jul 20, 2011

R T

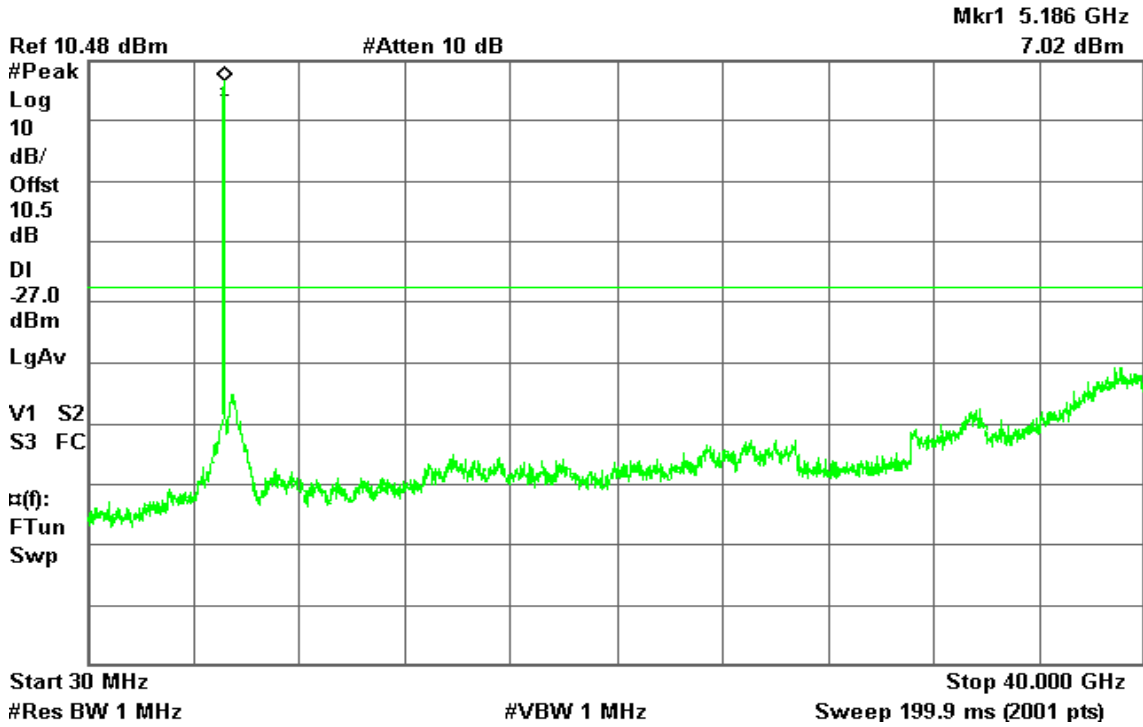

CH Mid

Agilent 16:48:10 Jul 20, 2011

R T

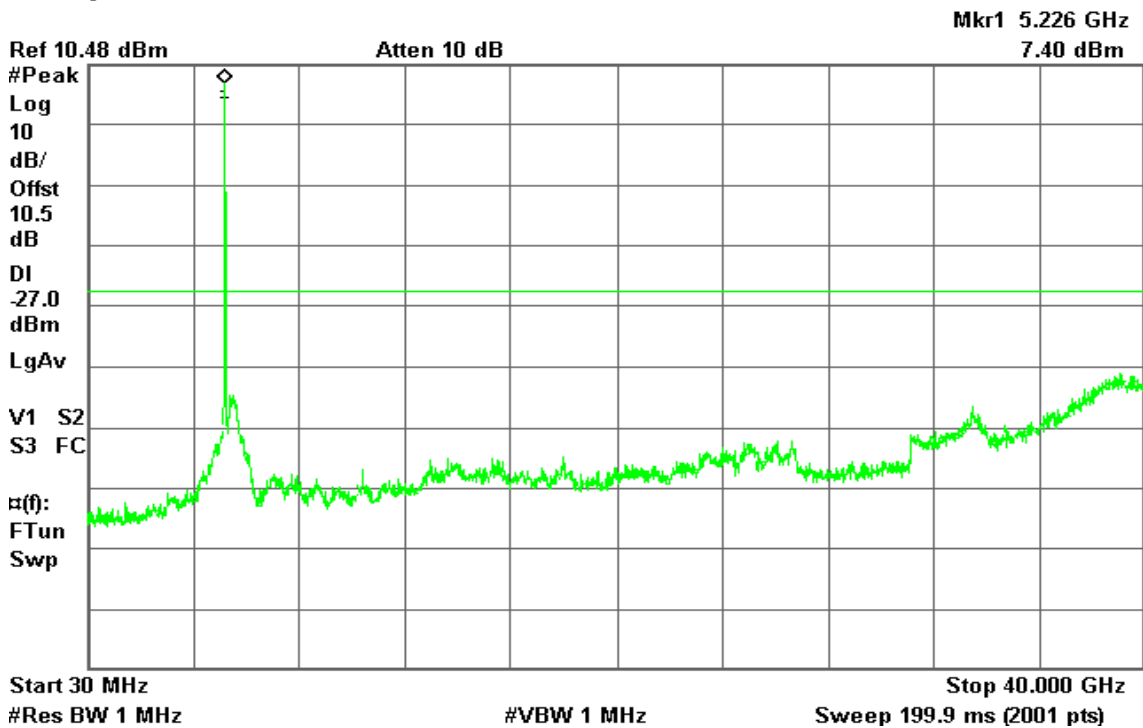



CH High

Agilent 16:51:28 Jul 20, 2011

R T

Mkr1 5.246 GHz
7.41 dBm

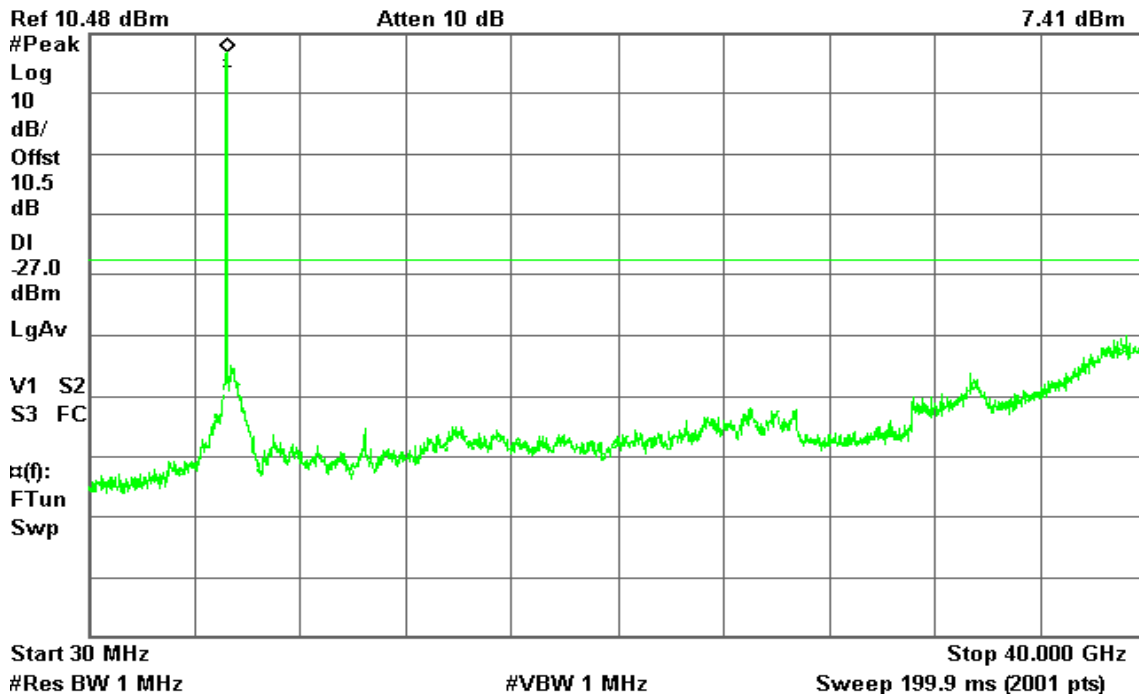



IEEE 802.11n HT 20 MHz mode / 5180 ~ 5240MHz / Chain 0

CH Low

Agilent 17:49:36 Jul 20, 2011

R T

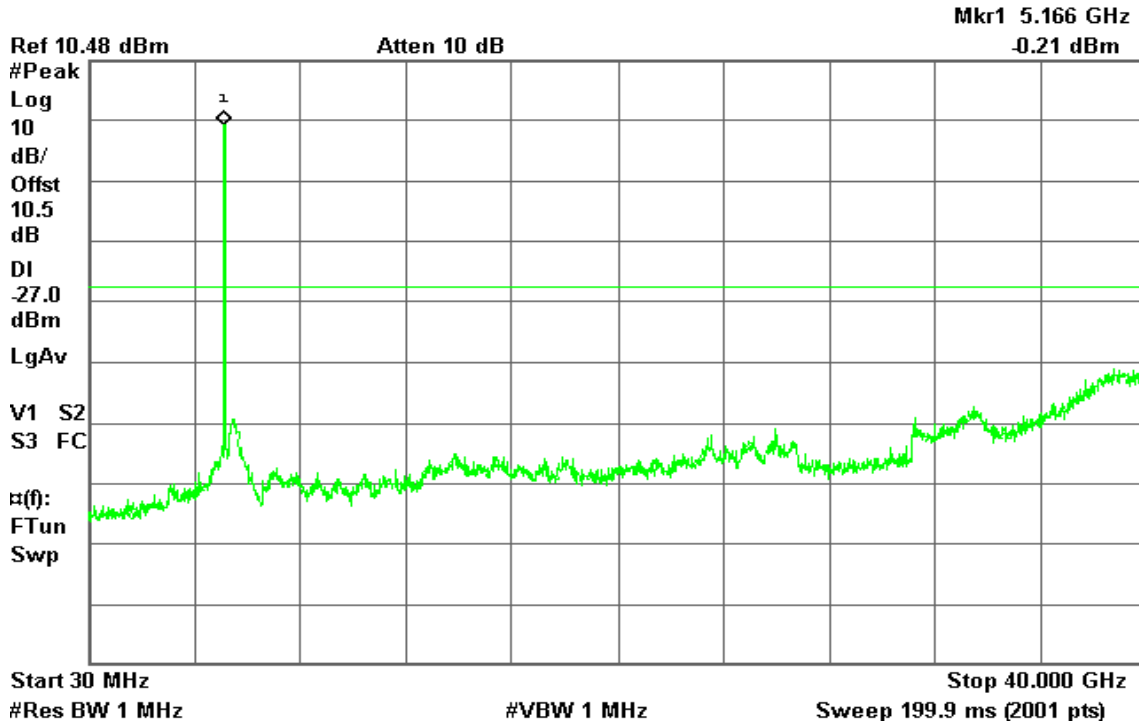

CH Mid

Agilent 18:07:09 Jul 20, 2011

R L

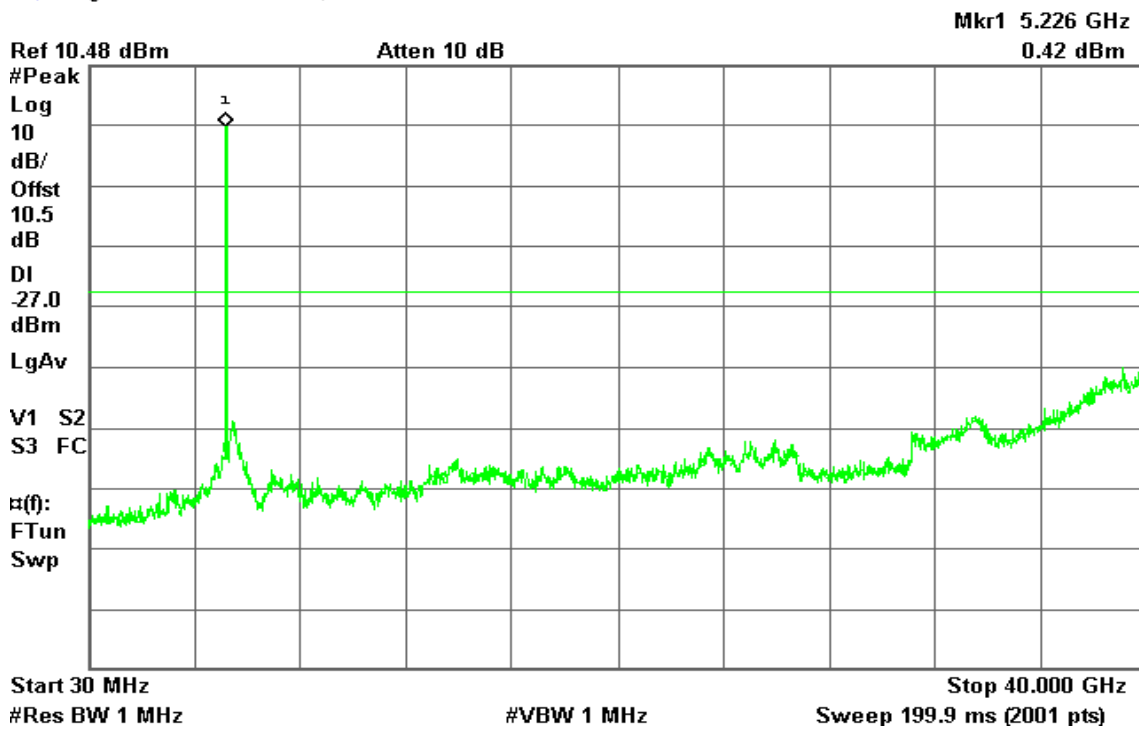



CH High

Agilent 18:09:58 Jul 20, 2011

R T

Mkr1 5.246 GHz
1.74 dBm

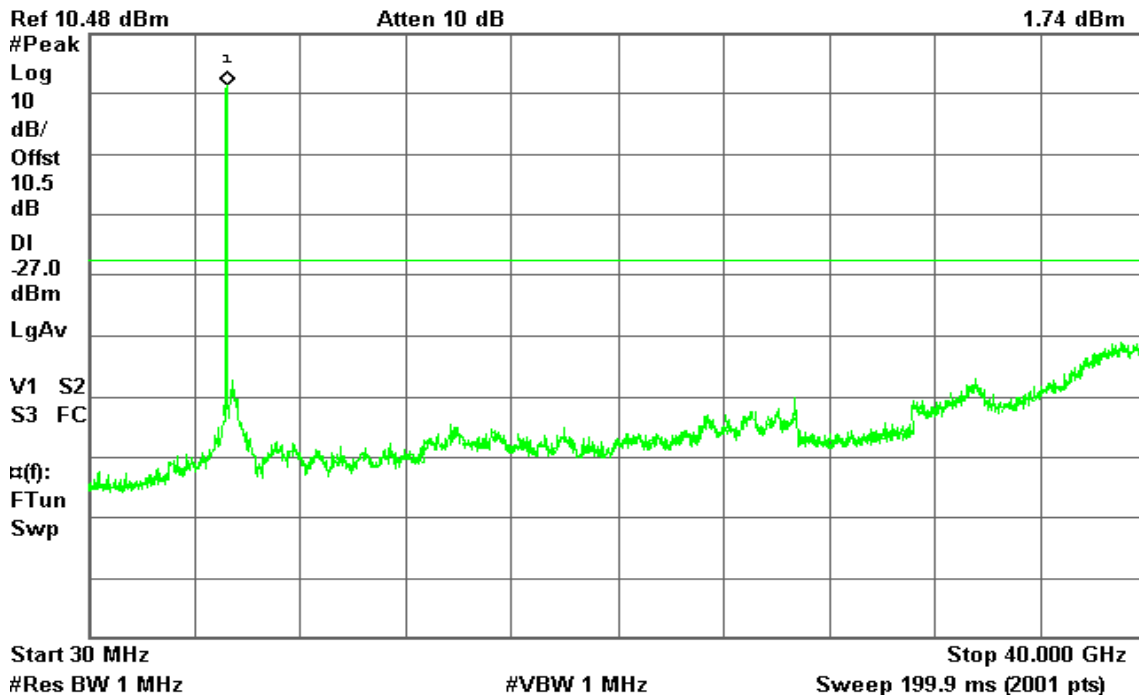



IEEE 802.11n HT 20 MHz mode / 5180 ~ 5240MHz / Chain 1

CH Low

Agilent 18:20:01 Jul 20, 2011

R L

Mkr1 5.186 GHz
-0.70 dBm

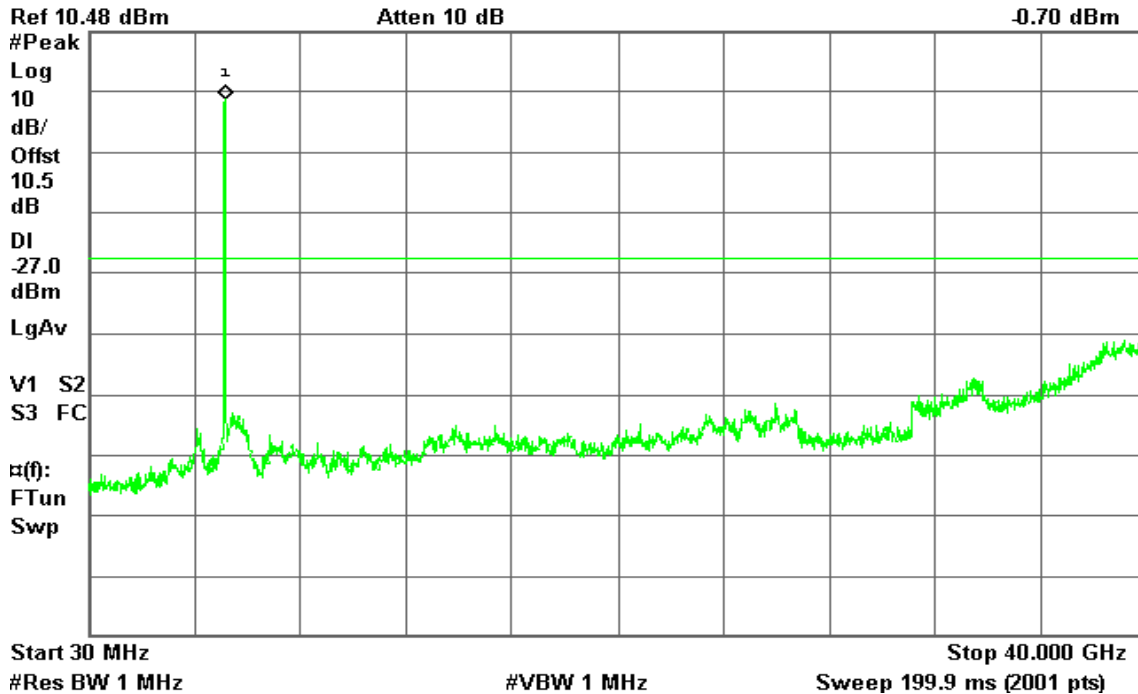

CH Mid

Agilent 18:17:18 Jul 20, 2011

R T

Mkr1 5.226 GHz
0.46 dBm

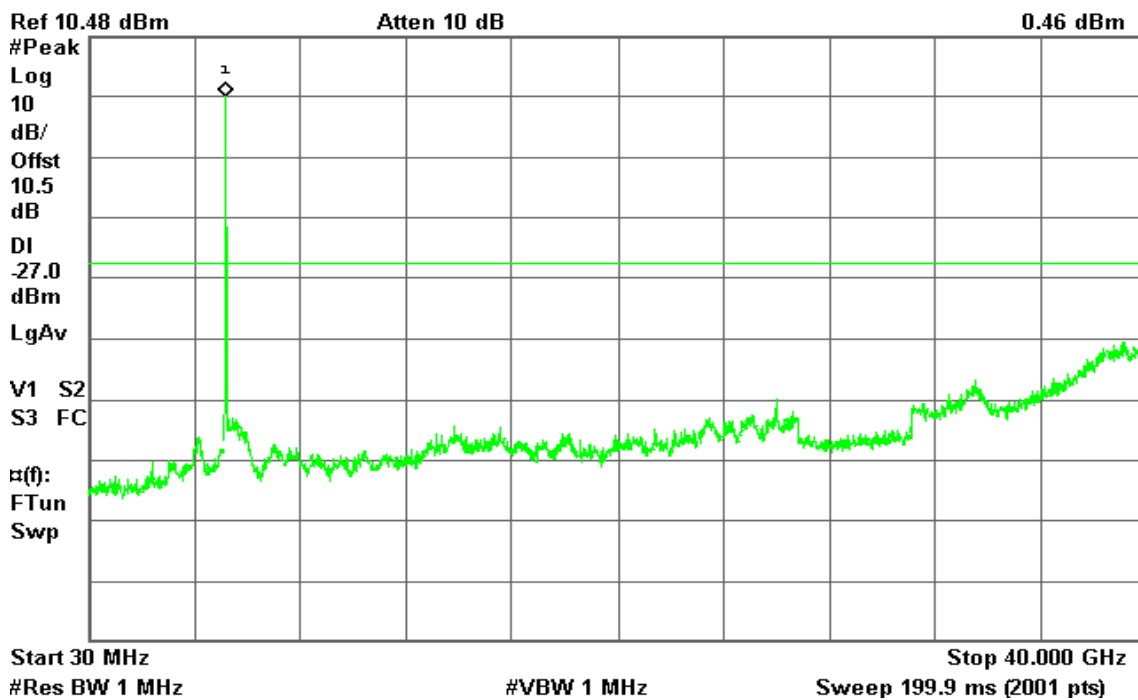



CH High

Agilent 18:14:26 Jul 20, 2011

R T

Mkr1 5.246 GHz
2.11 dBm

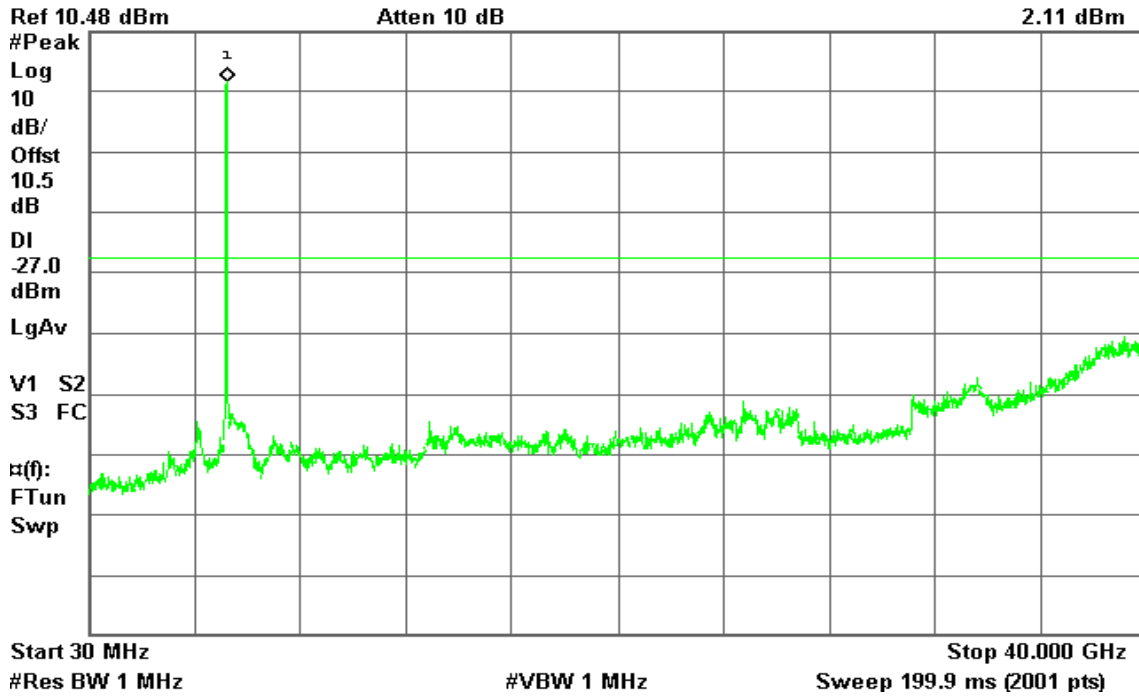



IEEE 802.11n HT 20 MHz mode / 5180 ~ 5240MHz / Chain 2

CH Low

Agilent 16:37:46 Aug 2, 2011

R T

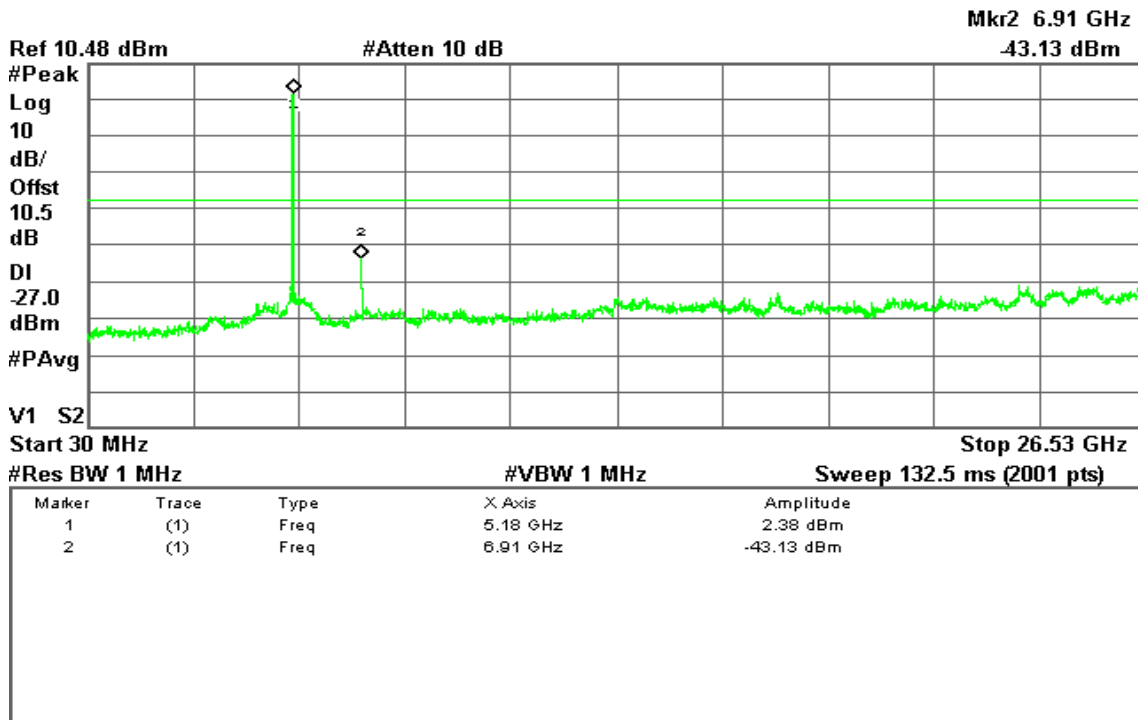

CH Mid

Agilent 16:42:10 Aug 2, 2011

R T

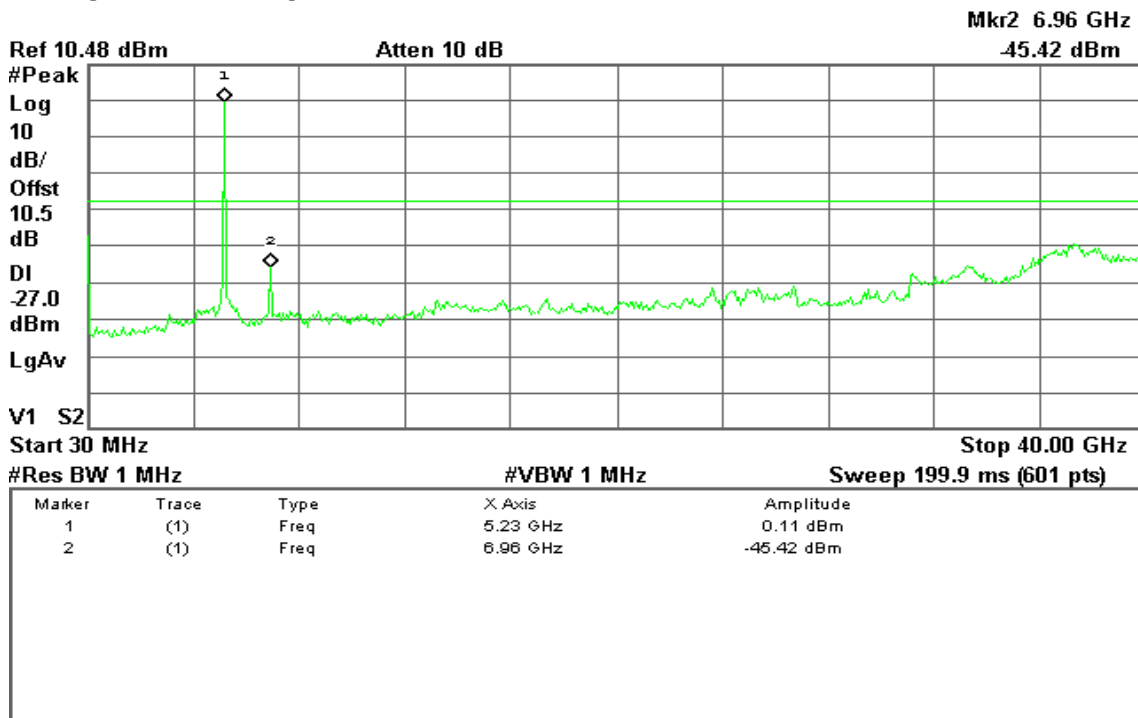



CH High

Agilent 16:43:01 Aug 2, 2011

R T

Mkr1 5.23 GHz

Ref 10.48 dBm

Atten 10 dB

0.67 dBm

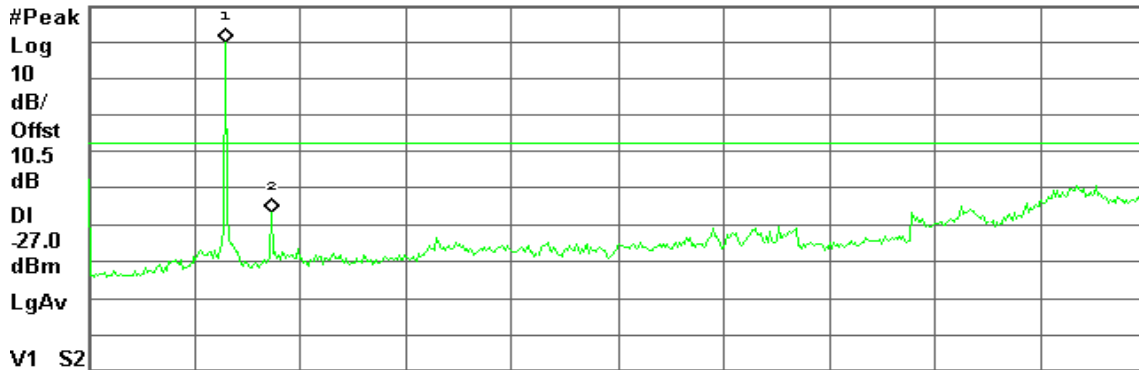

V1 S2

Start 30 MHz

Stop 40.00 GHz

#Res BW 1 MHz

#VBW 1 MHz

Sweep 199.9 ms (601 pts)

Marker	Trace	Type	X Axis	Amplitude
1	(1)	Freq	5.23 GHz	0.67 dBm
2	(1)	Freq	6.96 GHz	-46.33 dBm



IEEE 802.11n HT 20 MHz Channel mode

Channel	Frequency (MHz)	Chain2 (dBm)	Total (dBm)	Limit (dBm)	Margin (dBm)
Low	6910	-43.13	-38.36	-27	-11.36
Mid	6960	-45.42	-40.65	-27	-13.65
High	6960	-46.33	-41.56	-27	-14.56

Remark:

1. Total (dBm) = Measure + 10 log(3) dB,
Measure=Choose the max chain value



IEEE 802.11n HT 40 MHz mode / 5190 ~ 5230MHz / Chain 1

CH Low

Agilent 12:15:28 Jul 21, 2011

R T

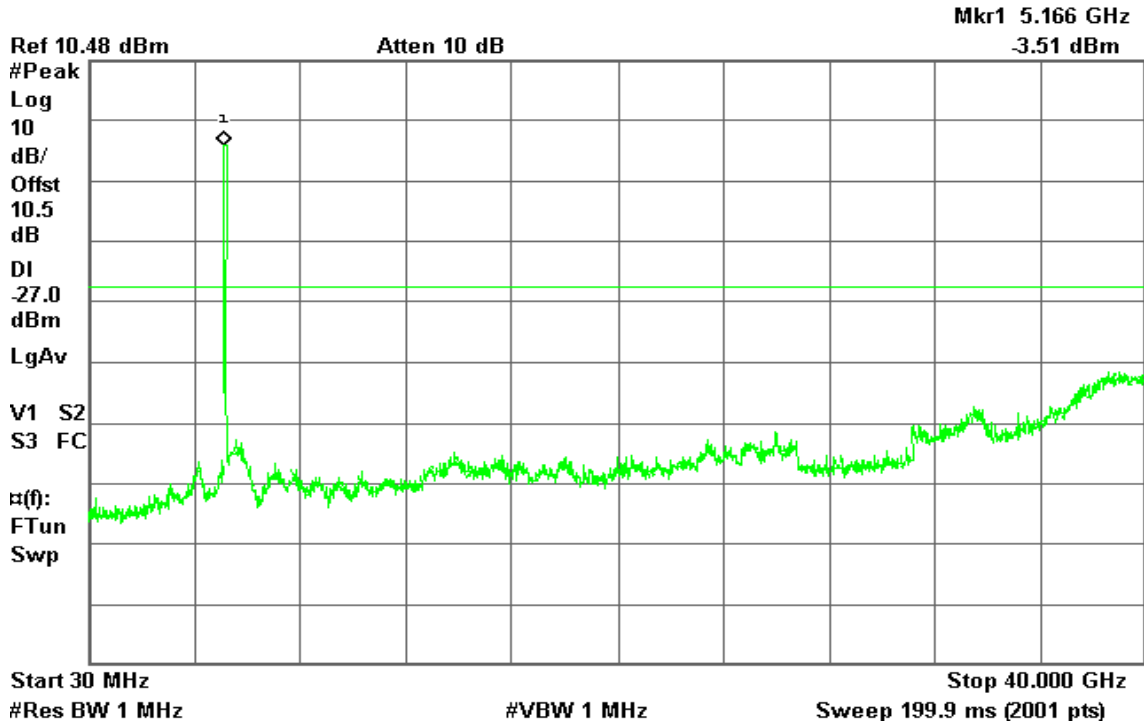

CH High

Agilent 12:12:53 Jul 21, 2011

R L

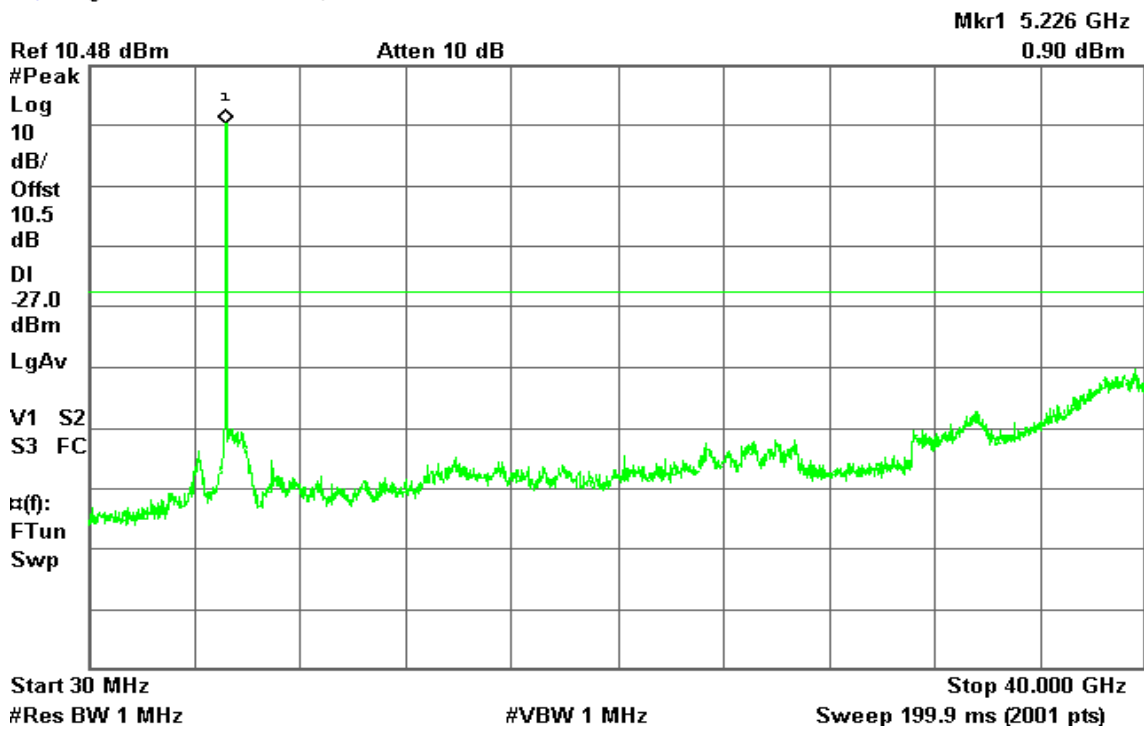



IEEE 802.11n HT 40 MHz mode / 5190 ~ 5230MHz / Chain 2

CH Low

Agilent 16:47:25 Aug 2, 2011

R T

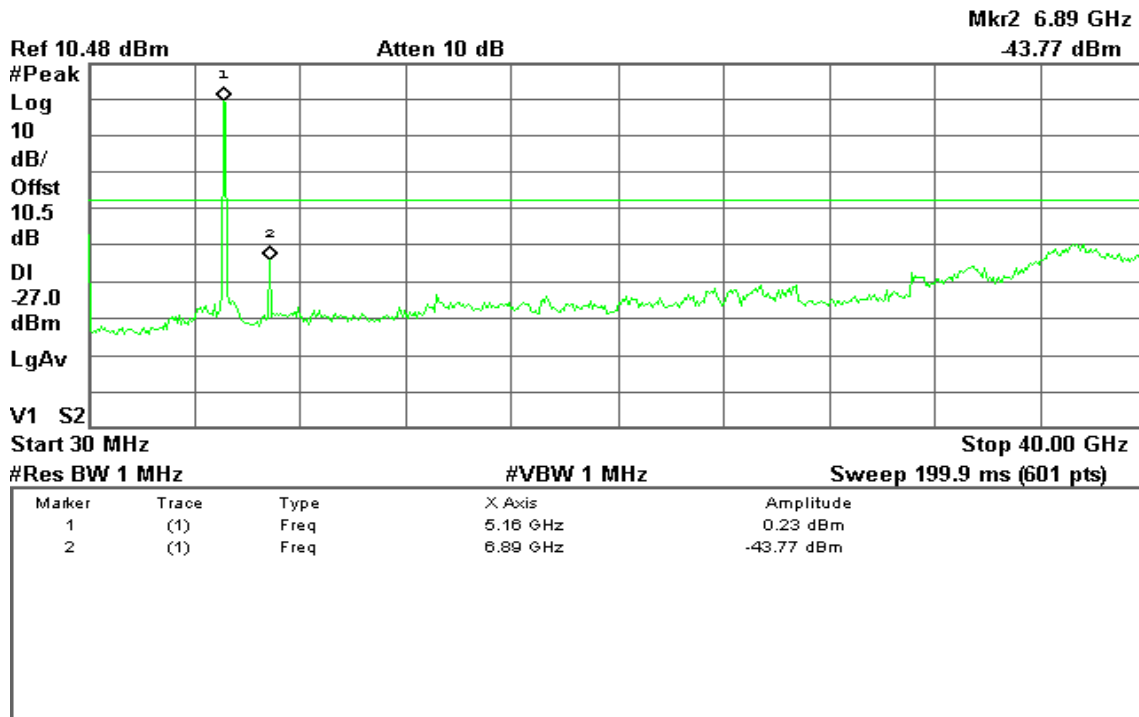

CH High

Agilent 16:48:09 Aug 2, 2011

R T

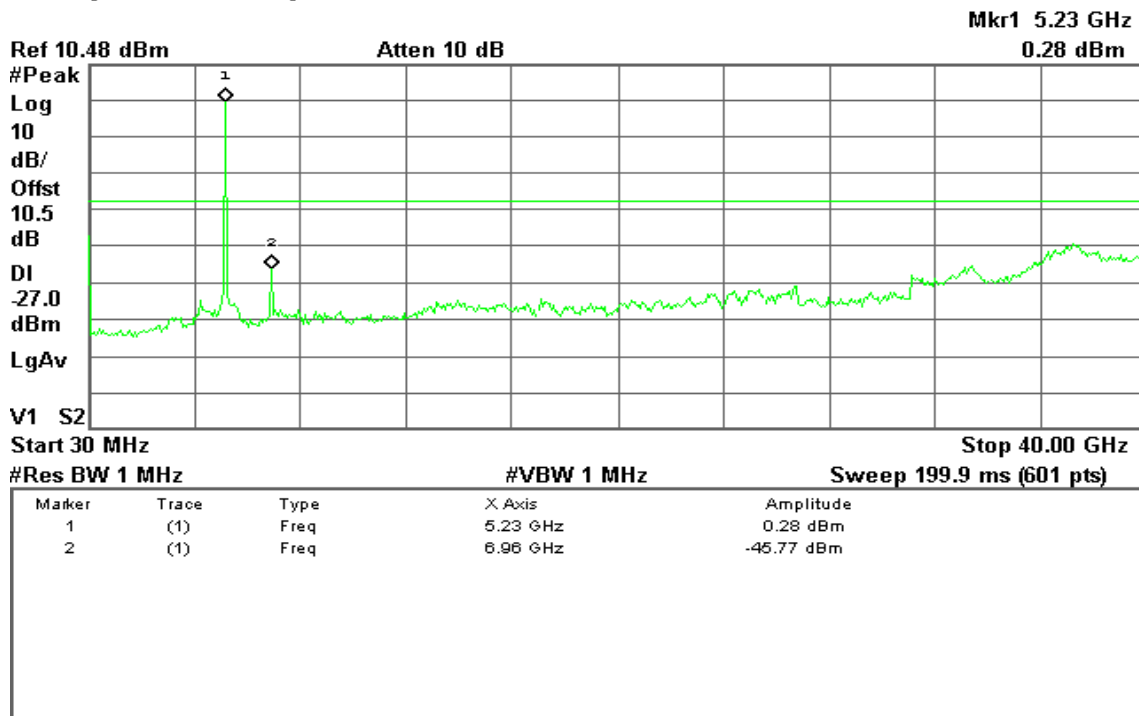



IEEE 802.11n HT 40 MHz Channel mode

Channel	Frequency (MHz)	Chain2 (dBm)	Total (dBm)	Limit (dBm)	Margin (dBm)
Low	6890	-43.77	-39.00	-27	-12.00
High	6960	-45.77	-41.00	-27	-14.00

Remark:

1. Total (dBm) = Measure + 10 log(3) dB,
Measure=Choose the max chain value



7.8 POWERLINE CONDUCTED EMISSIONS

LIMIT

According to §15.207(a), except as shown in paragraphs (b) and (c) of this section, for an intentional radiator that is designed to be connected to the public utility (AC) power line, the radio frequency voltage that is conducted back onto the AC power line on any frequency or frequencies within the band 150 kHz to 30 MHz shall not exceed the limits in the following table, as measured using a 50 μ H/50 ohms line impedance stabilization network (LISN). Compliance with the provisions of this paragraph shall be based on the measurement of the radio frequency voltage between each power line and ground at the power terminal. The lower limit applies at the boundary between the frequency ranges.

Frequency Range (MHz)	Limits (dB μ V)	
	Quasi-peak	Average
0.15 to 0.50	66 to 56*	56 to 46*
0.50 to 5	56	46
5 to 30	60	50

* Decreases with the logarithm of the frequency.

TEST CONFIGURATION

See test photographs attached in Appendix 1 for the actual connections between EUT and support equipment.

TEST PROCEDURE

1. The EUT was placed on a table, which is 0.8m above ground plane.
2. Maximum procedure was performed on the six highest emissions to ensure EUT compliance.
3. Repeat above procedures until all frequency measured were complete.

**test results**

The initial step in collecting conducted data is a spectrum analyzer peak scan of the measurement range. Significant peaks are then marked as shown on the following data page, and these signals are then quasi-peaked.

Test Data

Operation Mode: Normal Link **Test Date:** July 26, 2011
Temperature: 26°C **Tested by:** David Lee
Humidity: 60% RH

Freq. (MHz)	QP Reading (dBuV)	AV Reading (dBuV)	Corr. factor (dB/m)	QP Result (dBuV/m)	AV Result (dBuV/m)	QP Limit (dBuV)	AV Limit (dBuV)	QP Margin (dB)	AV Margin (dB)	Note
0.1680	42.13	29.33	0.17	42.30	29.50	65.06	55.06	-22.76	-25.56	L1
0.2117	35.74	25.24	0.16	35.90	25.40	63.14	53.14	-27.24	-27.74	L1
0.5370	36.04	24.54	0.16	36.20	24.70	56.00	46.00	-19.80	-21.30	L1
0.7084	38.63	28.63	0.17	38.80	28.80	56.00	46.00	-17.20	-17.20	L1
6.2025	23.75	11.25	0.35	24.10	11.60	60.00	50.00	-35.90	-38.40	L1
8.5965	27.47	15.47	0.43	27.90	15.90	60.00	50.00	-32.10	-34.10	L1
0.1680	33.14	17.64	0.26	33.40	17.90	65.06	55.06	-31.66	-37.16	L2
0.2175	42.15	25.95	0.25	42.40	26.20	62.91	52.91	-20.51	-26.71	L2
0.4065	33.35	18.15	0.25	33.60	18.40	57.72	47.72	-24.12	-29.32	L2
0.6990	26.95	12.95	0.25	27.20	13.20	56.00	46.00	-28.80	-32.80	L2
9.4065	24.36	15.86	0.44	24.80	16.30	60.00	50.00	-35.20	-33.70	L2
12.1965	33.71	27.71	0.49	34.20	28.20	60.00	50.00	-25.80	-21.80	L2

Remark:

1. Measuring frequencies from 0.15 MHz to 30MHz.
2. The emissions measured in frequency range from 0.15 MHz to 30MHz were made with an instrument using Quasi-peak detector and average detector.
3. The IF bandwidth of SPA between 0.15MHz and 30MHz was 10 kHz; the IF bandwidth of Test Receiver between 0.15MHz and 30MHz was 9 kHz;
4. L1 = Line One (Live Line) / L2 = Line Two (Neutral Line)



Test Plots

Conducted emissions (Line 1)

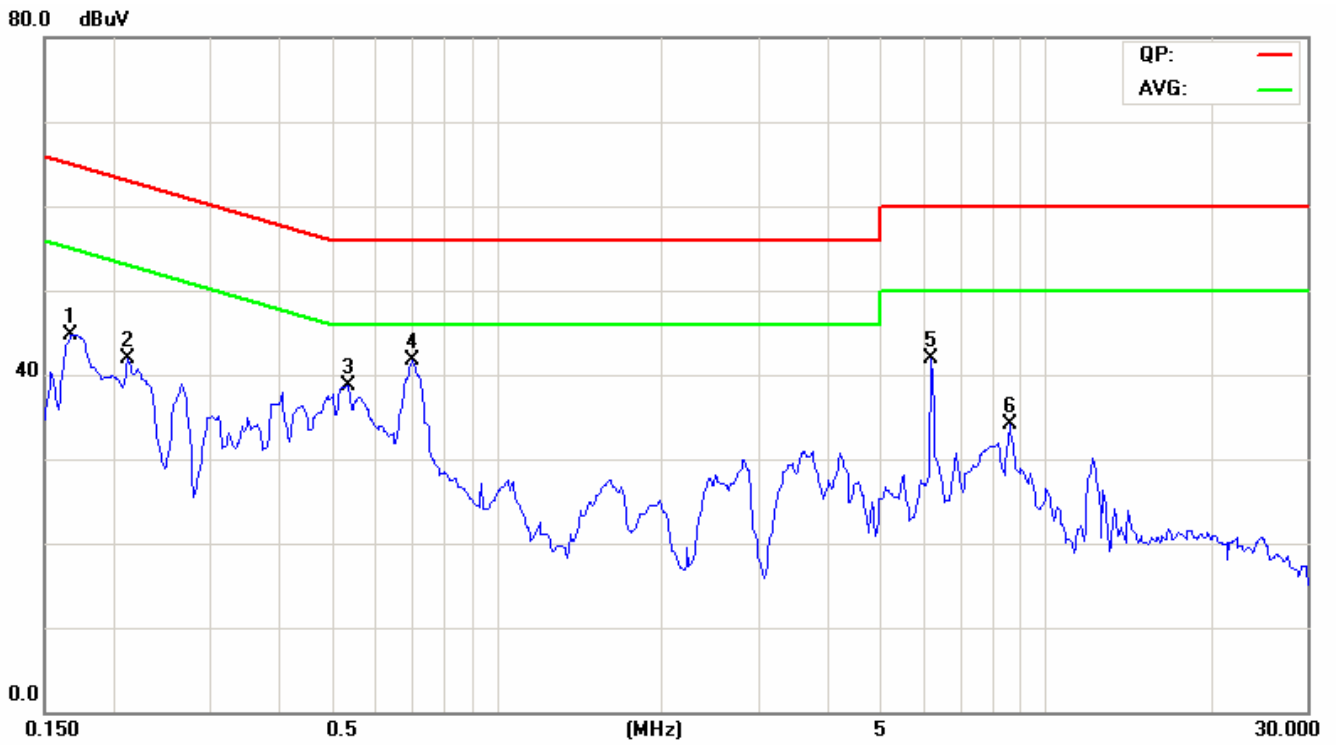

Conducted emissions (Line 2)

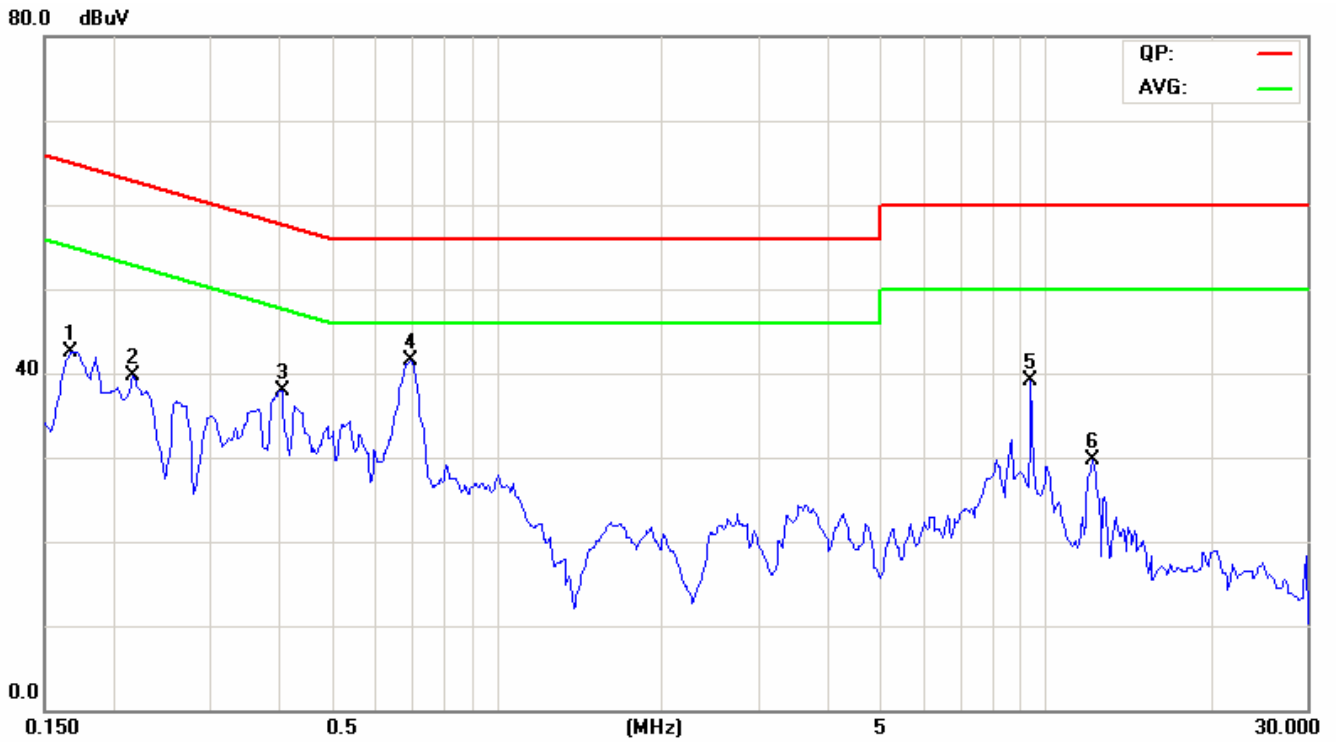



7.9 FREQUENCY STABILITY

LIMIT

According to §15.407(g), manufacturers of U-NII devices are responsible for ensuring frequency stability such that an emission is maintained within the band of operation under all conditions of normal operation as specified in the user's manual.

Test Configuration

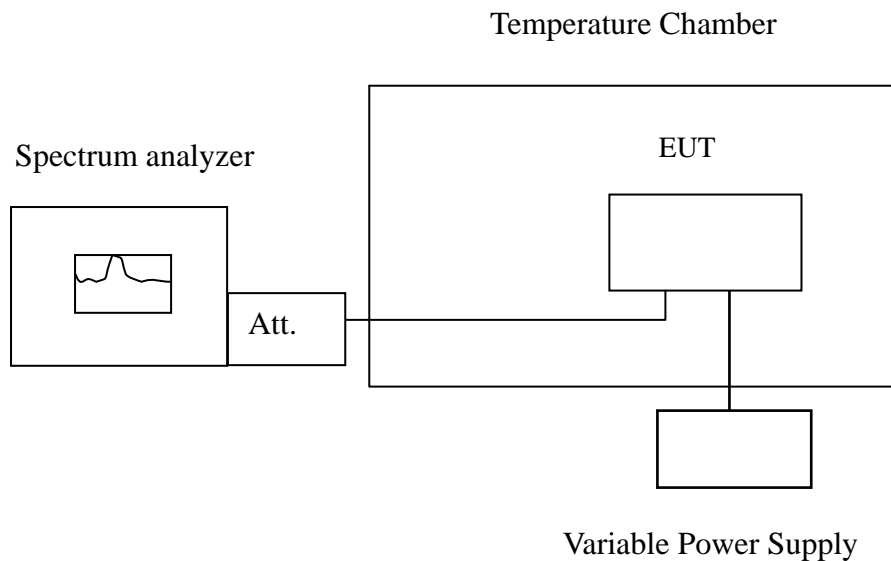

Remark: Measurement setup for testing on Antenna connector



TEST PROCEDURE

The equipment under test was connected to an external AC or DC power supply and input rated voltage. RF output was connected to a frequency counter or spectrum analyzer via feed through attenuators. The EUT was placed inside the temperature chamber. Set the spectrum analyzer RBW low enough to obtain the desired frequency resolution and measure EUT 20°C operating frequency as reference frequency. Turn EUT off and set the chamber temperature to -20°C. After the temperature stabilized for approximately 30 minutes recorded the frequency. Repeat step measure with 10°C increased per stage until the highest temperature of +50°C reached.

TEST RESULTS

No non-compliance noted.

IEEE 802.11a mode / 5180 ~ 5240 MHz:

CH Low

Operating Frequency: 5180 MHz				
Environment Temperature (°C)	Voltage (V)	Measured Frequency (MHz)	Limit Range	Test Result
50	110	5179.998808	5150~5250	Pass
40	110	5180.014375	5150~5250	Pass
30	110	5179.973808	5150~5250	Pass
20	110	5180.007254	5150~5250	Pass
10	110	5180.002132	5150~5250	Pass
0	110	5179.998356	5150~5250	Pass
-10	110	5180.012475	5150~5250	Pass
-20	110	5179.995433	5150~5250	Pass

Operating Frequency: 5180 MHz				
Environment Temperature (°C)	Voltage (V)	Measured Frequency (MHz)	Limit Range	Test Result
20	99	5179.977433	5150~5250	Pass
	110	5180.019681	5150~5250	Pass
	121	5180.020677	5150~5250	Pass



CH High

Operating Frequency: 5240 MHz				
Environment Temperature (°C)	Voltage (V)	Measured Frequency (MHz)	Limit Range	Test Result
50	110	5239.980335	5150~5250	Pass
40	110	5239.971358	5150~5250	Pass
30	110	5240.010354	5150~5250	Pass
20	110	5240.020850	5150~5250	Pass
10	110	5239.982451	5150~5250	Pass
0	110	5239.970906	5150~5250	Pass
-10	110	5240.008299	5150~5250	Pass
-20	110	5239.986217	5150~5250	Pass

Operating Frequency: 5240 MHz				
Environment Temperature (°C)	Voltage (V)	Measured Frequency (MHz)	Limit Range	Test Result
20	99	5239.985235	5150~5250	Pass
	110	5240.005411	5150~5250	Pass
	121	5239.983621	5150~5250	Pass



IEEE 802.11n HT 20 MHz mode / 5180 ~ 5240 MHz:

CH Low

Operating Frequency: 5180 MHz				
Environment Temperature (°C)	Voltage (V)	Measured Frequency (MHz)	Limit Range	Test Result
50	110	5180.003402	5150~5250	Pass
40	110	5179.999979	5150~5250	Pass
30	110	5179.981280	5150~5250	Pass
20	110	5179.993042	5150~5250	Pass
10	110	5179.994528	5150~5250	Pass
0	110	5179.996979	5150~5250	Pass
-10	110	5179.998471	5150~5250	Pass
-20	110	5180.016147	5150~5250	Pass

Operating Frequency: 5180 MHz				
Environment Temperature (°C)	Voltage (V)	Measured Frequency (MHz)	Limit Range	Test Result
20	99	5180.006633	5150~5250	Pass
	110	5180.010595	5150~5250	Pass
	121	5179.99174	5150~5250	Pass



CH High

Operating Frequency: 5240 MHz				
Environment Temperature (°C)	Voltage (V)	Measured Frequency (MHz)	Limit Range	Test Result
50	110	5239.999660	5150~5250	Pass
40	110	5240.016944	5150~5250	Pass
30	110	5239.978218	5150~5250	Pass
20	110	5240.007512	5150~5250	Pass
10	110	5240.014110	5150~5250	Pass
0	110	5239.983447	5150~5250	Pass
-10	110	5240.006186	5150~5250	Pass
-20	110	5239.989730	5150~5250	Pass

Operating Frequency: 5240 MHz				
Environment Temperature (°C)	Voltage (V)	Measured Frequency (MHz)	Limit Range	Test Result
20	99	5239.9749	5150~5250	Pass
	110	5239.995497	5150~5250	Pass
	121	5239.974512	5150~5250	Pass



IEEE 802.11n HT 40 MHz mode / 5190 ~ 5230 MHz:

CH Low

Operating Frequency: 5190 MHz				
Environment Temperature (°C)	Voltage (V)	Measured Frequency (MHz)	Limit Range	Test Result
50	110	5189.982195	5150~5250	Pass
40	110	5189.977859	5150~5250	Pass
30	110	5190.004471	5150~5250	Pass
20	110	5189.977926	5150~5250	Pass
10	110	5190.000605	5150~5250	Pass
0	110	5190.010704	5150~5250	Pass
-10	110	5189.998254	5150~5250	Pass
-20	110	5190.019547	5150~5250	Pass

Operating Frequency: 5190 MHz				
Environment Temperature (°C)	Voltage (V)	Measured Frequency (MHz)	Limit Range	Test Result
20	99	5190.00823	5150~5250	Pass
	110	5189.981132	5150~5250	Pass
	121	5190.020416	5150~5250	Pass



CH High

Operating Frequency: 5230 MHz				
Environment Temperature (°C)	Voltage (V)	Measured Frequency (MHz)	Limit Range	Test Result
50	110	5229.986939	5150~5250	Pass
40	110	5229.986007	5150~5250	Pass
30	110	5230.001498	5150~5250	Pass
20	110	5230.005783	5150~5250	Pass
10	110	5230.010780	5150~5250	Pass
0	110	5229.979372	5150~5250	Pass
-10	110	5229.975405	5150~5250	Pass
-20	110	5229.973334	5150~5250	Pass

Operating Frequency: 5230 MHz				
Environment Temperature (°C)	Voltage (V)	Measured Frequency (MHz)	Limit Range	Test Result
20	99	5230.011467	5150~5250	Pass
	110	5229.996428	5150~5250	Pass
	121	5229.991741	5150~5250	Pass