



# FCC TEST REPORT (CO-LOCATED)

**REPORT NO.:** RF981022L16A-2

**MODEL NO.:** TEW-673GRU

**RECEIVED:** Sep. 08, 2009

**TESTED:** Jan. 12 ~ Jan. 13, 2010

**ISSUED:** Jan. 19, 2010

**APPLICANT:** TRENDNET, Inc.

**ADDRESS:** 20675 Manhattan Place, Torrance, CA 90501,  
USA

**ISSUED BY:** Bureau Veritas Consumer Products Services  
(H.K.) Ltd., Taoyuan Branch

**LAB ADDRESS:** No. 47, 14th Ling, Chia Pau Tsuen, Lin Kou  
Hsiang, Taipei Hsien 244, Taiwan, R.O.C.

**TEST LOCATION:** No. 19, Hwa Ya 2nd Rd, Wen Hwa Tsuen, Kwei  
Shan Hsiang, Taoyuan Hsien 333, Taiwan,  
R.O.C.

This test report consists of 44 pages in total. It may be duplicated completely for legal use with the approval of the applicant. It should not be reproduced except in full, without the written approval of our laboratory. The client should not use it to claim product endorsement by TAF or any government agencies. The test results in the report only apply to the tested sample.





## TABLE OF CONTENTS

1.	CERTIFICATION .....	3
2.	SUMMARY OF TEST RESULTS .....	4
2.1	MEASUREMENT UNCERTAINTY .....	4
3.	GENERAL INFORMATION .....	5
3.1	GENERAL DESCRIPTION OF EUT .....	5
3.2	DESCRIPTION OF TEST MODES .....	7
3.2.1	CONFIGURATION OF SYSTEM UNDER TEST .....	8
3.2.2	TEST MODE APPLICABILITY AND TESTED CHANNEL DETAIL .....	9
3.3	GENERAL DESCRIPTION OF APPLIED STANDARDS .....	11
3.4	DESCRIPTION OF SUPPORT UNITS .....	11
4.	TEST TYPES AND RESULTS .....	12
4.1	RADIATED EMISSION MEASUREMENT .....	12
4.1.1	LIMITS OF RADIATED EMISSION MEASUREMENT .....	12
4.1.2	LIMITS OF UNWANTED EMISSION OUT OF THE RESTRICTED BANDS .....	12
4.1.3	TEST INSTRUMENTS .....	13
4.1.4	TEST PROCEDURES .....	14
4.1.5	DEVIATION FROM TEST STANDARD .....	14
4.1.6	TEST SETUP .....	15
4.1.7	EUT OPERATING CONDITIONS .....	15
4.1.8	TEST RESULTS .....	16
4.2	CONDUCTED EMISSION MEASUREMENT .....	22
4.2.1	LIMITS OF CONDUCTED EMISSION MEASUREMENT .....	22
4.2.2	TEST INSTRUMENTS .....	22
4.2.3	TEST PROCEDURES .....	23
4.2.4	DEVIATION FROM TEST STANDARD .....	23
4.2.5	TEST SETUP .....	24
4.2.6	EUT OPERATING CONDITIONS .....	24
4.2.7	TEST RESULTS .....	25
4.3	OUTBAND EMISSION MEASUREMENT .....	29
4.3.1	TEST INSTRUMENTS .....	29
4.3.2	TEST PROCEDURE .....	29
4.3.3	DEVIATION FROM TEST STANDARD .....	29
4.3.4	TEST SETUP .....	29
4.3.5	EUT OPERATING CONDITIONS .....	29
4.3.6	TEST RESULTS .....	30
5.	PHOTOGRAPHS OF THE TEST CONFIGURATION .....	42
6.	INFORMATION ON THE TESTING LABORATORIES .....	43
7.	APPENDIX A - MODIFICATIONS RECORDERS FOR ENGINEERING CHANGES TO THE EUT BY THE LAB .....	44



# 1. CERTIFICATION

**PRODUCT:** 300Mbps Concurrent Dual Band Wireless N Gigabit Router  
**MODEL:** TEW-673GRU  
**BRAND:** TRENDnet  
**APPLICANT:** TRENDNET, Inc.  
**TEST SAMPLE:** ENGINEERING SAMPLE  
**TESTED:** Jan. 12 ~ Jan. 13, 2010  
**STANDARDS:** FCC Part 15, Subpart C (Section 15.247)  
FCC Part 15, Subpart E (Section 15.407)  
ANSI C63.4-2003

The above equipment (Model: TEW-673GRU) has been tested by **Bureau Veritas Consumer Products Services (H.K.) Ltd., Taoyuan Branch**, and found compliance with the requirement of the above standards. The test record, data evaluation & Equipment Under Test (EUT) configurations represented herein are true and accurate accounts of the measurements of the sample's EMC characteristics under the conditions specified in this report.

**PREPARED BY** : Ivy Lin , **DATE:** Jan. 19, 2010  
Ivy Lin / Specialist

**TECHNICAL ACCEPTANCE** : Long Chen , **DATE:** Jan. 19, 2010  
Responsible for RF Long Chen / Senior Engineer

**APPROVED BY** : Gary Chang , **DATE:** Jan. 19, 2010  
Gary Chang / Assistant Manager

## 2. SUMMARY OF TEST RESULTS

The EUT has been tested according to the following specifications:

APPLIED STANDARD: FCC PART 15, SUBPART C (SECTION 15.247) FCC PART 15, SUBPART E (SECTION 15.407)			
STANDARD SECTION	TEST TYPE AND LIMIT	RESULT	REMARK
15.247(d)	Radiated Emissions Limit: Table 15.209	PASS	Meet the requirement of limit. Minimum passing margin is -1.3dB at 389.59MHz
15.407(b)/1/2 /3) (b)(5)	Electric Field Strength Spurious Emissions, 30MHz ~ 40000MHz		
15.207 15.407(b)(5)	AC Power Conducted Emission	PASS	Meet the requirement of limit. Minimum passing margin is -7.98dB at 0.180MHz

### 2.1 MEASUREMENT UNCERTAINTY

Where relevant, the following measurement uncertainty levels have been estimated for tests performed on the EUT as specified in CISPR 16-4-2:

MEASUREMENT	FREQUENCY	UNCERTAINTY
Conducted emissions	150kHz~30MHz	2.44dB
Radiated emissions	30MHz ~ 200MHz	2.93 dB
	200MHz ~1000MHz	2.95 dB
	1GHz ~ 18GHz	2.26 dB
	18GHz ~ 40GHz	1.94 dB

This uncertainty represents an expanded uncertainty expressed at approximately the 95% confidence level using a coverage factor of  $k = 2$ .



### 3. GENERAL INFORMATION

#### 3.1 GENERAL DESCRIPTION OF EUT

<b>EUT</b>	300Mbps Concurrent Dual Band Wireless N Gigabit Router
<b>MODEL NO.</b>	TEW-673GRU
<b>FCC ID</b>	XU8TEW673GRU
<b>POWER SUPPLY</b>	12Vdc
<b>MODULATION TYPE</b>	CCK, DQPSK, DBPSK for DSSS 64QAM, 16QAM, QPSK, BPSK for OFDM
<b>MODULATION TECHNOLOGY</b>	DSSS, OFDM
<b>TRANSFER RATE</b>	802.11b: 11.0/ 5.5/ 2.0/ 1.0Mbps 802.11g: 54.0/ 48.0/ 36.0/ 24.0/ 18.0/ 12.0/ 9.0/ 6.0Mbps 802.11a: 54.0/ 48.0/ 36.0/ 24.0/ 18.0/ 12.0/ 9.0/ 6.0Mbps Draft 802.11n: up to 300.0Mbps
<b>FREQUENCY RANGE</b>	2.4GHz: 2412 ~ 2462MHz 5.0GHz: 5180 ~ 5240MHz, 5745 ~ 5825MHz
<b>NUMBER OF CHANNEL</b>	2.4GHz: 11 for 802.11b, 802.11g, 802.11n (20MHz) 7 for 802.11n (40MHz) 5.0GHz: 5180 ~ 5240MHz: 4 for 802.11a, 802.11n (20MHz) 2 for 802.11n (40MHz) 5745 ~ 5825MHz: 5 for 802.11a, 802.11n (20MHz) 2 for 802.11n (40MHz)
<b>OUTPUT POWER</b>	422.9mW for 2412 ~ 2462MHz 31.1mW for 5180 ~ 5240MHz 381.5mW for 5745 ~ 5825MHz
<b>ANTENNA TYPE</b>	Dipole antenna with 2dBi gain (for 2.4GHz) Dipole antenna with 3dBi gain (for 5.0GHz)
<b>ANTENNA CONNECTOR</b>	R-SMA
<b>I/O PORTS</b>	USB, RJ45
<b>DATA CABLE</b>	NA
<b>ACCESSORY DEVICES</b>	AC adapter

**NOTE:**

1. This is a duplicate report of RF981022L16-2. The differences compared with original report are changing the applicant, model name and brand name.
2. The frequency bands used in this EUT are listed as follows:

Frequency Band (MHz)	2412~2462	5180~5240	5745~5825
802.11b	√		
802.11g	√		
802.11a		√	√
802.11n (20MHz)	√	√	√
802.11n (40MHz)	√	√	√

3. The EUT was powered by the following adapter:

<b>BRAND:</b>	JENTEC TECHNOLOGY CO., LTD.
<b>MODEL:</b>	CG2412-B
<b>INPUT:</b>	100-120Vac, 0.5A, 50-60Hz
<b>OUTPUT:</b>	12Vdc, 2A
<b>POWER LINE:</b>	1.8m non-shielded cable with one core

4. The EUT incorporates a MIMO function. Physically, the EUT provides two completed transmitters and two receivers.

MODULATION MODE	TX FUNCTION
802.11b	2TX
802.11g	2TX
802.11a	2TX
802.11n (20MHz)	2TX
802.11n (40MHz)	2TX

5. The above EUT information was declared by manufacturer and for more detailed features description, please refer to the manufacturer's specifications or user's manual.

### 3.2 DESCRIPTION OF TEST MODES

#### FOR 2.4GHz:

11 channels are provided for 802.11b, 802.11g, 802.11n (20MHz):

CHANNEL	FREQUENCY	CHANNEL	FREQUENCY
1	2412MHz	7	2442MHz
2	2417MHz	8	2447MHz
3	2422MHz	9	2452MHz
4	2427MHz	10	2457MHz
5	2432MHz	11	2462MHz
6	2437MHz		

7 channels are provided for 802.11n (40MHz):

CHANNEL	FREQUENCY	CHANNEL	FREQUENCY
1	2422MHz	5	2442MHz
2	2427MHz	6	2447MHz
3	2432MHz	7	2452MHz
4	2437MHz		

#### FOR 5.0GHz (5180 ~ 5240MHz):

4 channels are provided for 802.11a, 802.11n (20MHz):

CHANNEL	FREQUENCY	CHANNEL	FREQUENCY
36	5180MHz	44	5220MHz
40	5200MHz	48	5240MHz

2 channels are provided for 802.11n (40MHz):

CHANNEL	FREQUENCY	CHANNEL	FREQUENCY
38	5190MHz	46	5230MHz

#### FOR 5.0GHz (5745 ~ 5825MHz):

5 channels are provided for 802.11a, 802.11n (20MHz):

CHANNEL	FREQUENCY	CHANNEL	FREQUENCY
149	5745MHz	161	5805MHz
153	5765MHz	165	5825MHz
157	5785MHz		

2 channels are provided for 802.11n (40MHz):

CHANNEL	FREQUENCY	CHANNEL	FREQUENCY
151	5755MHz	159	5795MHz

### 3.2.1 CONFIGURATION OF SYSTEM UNDER TEST

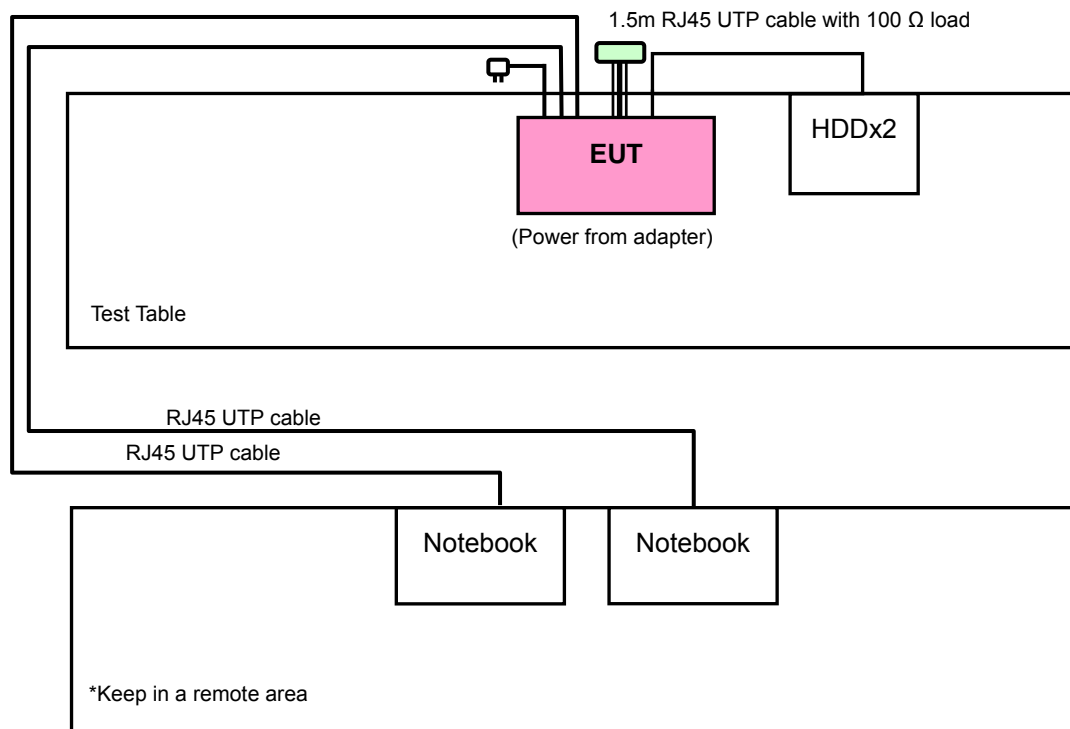



### 3.2.2 TEST MODE APPLICABILITY AND TESTED CHANNEL DETAIL

EUT CONFIGURE MODE	APPLICABLE TO			DESCRIPTION
	RE≥1G	RE<1G	PLC	
-	√	√	√	-

Where **RE≥1G**: Radiated Emission above 1GHz      **RE<1G**: Radiated Emission below 1GHz  
**PLC**: Power Line Conducted Emission

#### **RADIATED EMISSION TEST (ABOVE 1GHz):**

- Pre-Scan has been conducted to determine the worst-case mode from all possible combinations between available modulations, data rates and antenna ports (if EUT with antenna diversity architecture).
- Following channel(s) was (were) selected for the final test as listed below.

MODE	FREQ. RANGE (MHz)	AVAILABLE CHANNEL	TESTED CHANNEL	MODULATION TECHNOLOGY	MODULATION TYPE	DATA RATE (Mbps)
802.11g + 802.11an (20MHz)	2412-2462 5180-5240	1 to 11 36 to 46	6 + 36	OFDM OFDM	BPSK BPSK	6.0 7.2
802.11g + 802.11an (40MHz)	2412-2462 5190-5230	1 to 11 38 to 46	6 + 46	OFDM OFDM	BPSK BPSK	6.0 15.0
802.11g + 802.11an (20MHz)	2412-2462 5745-5825	1 to 11 149 to 165	6 + 165	OFDM OFDM	BPSK BPSK	6.0 7.2
802.11g + 802.11an (40MHz)	2412-2462 5755-5795	1 to 11 151 to 159	6 + 159	OFDM OFDM	BPSK BPSK	6.0 15.0

#### **RADIATED EMISSION TEST (BELOW 1GHz):**

- Pre-Scan has been conducted to determine the worst-case mode from all possible combinations between available modulations, data rates and antenna ports (if EUT with antenna diversity architecture).
- Following channel(s) was (were) selected for the final test as listed below.

MODE	FREQ. RANGE (MHz)	AVAILABLE CHANNEL	TESTED CHANNEL	MODULATION TECHNOLOGY	MODULATION TYPE	DATA RATE (Mbps)
802.11g + 802.11an (40MHz)	2412-2462 5190-5230	1 to 11 38 to 46	6 + 46	OFDM OFDM	BPSK BPSK	6.0 15.0
802.11g + 802.11an (20MHz)	2412-2462 5755-5795	1 to 11 149 to 165	6 + 165	OFDM OFDM	BPSK BPSK	6.0 7.2



**POWER LINE CONDUCTED EMISSION TEST:**

- Pre-Scan has been conducted to determine the worst-case mode from all possible combinations between available modulations, data rates and antenna ports (if EUT with antenna diversity architecture).
- Following channel(s) was (were) selected for the final test as listed below.

MODE	FREQ. RANGE (MHz)	AVAILABLE CHANNEL	TESTED CHANNEL	MODULATION TECHNOLOGY	MODULATION TYPE	DATA RATE (Mbps)
802.11g + 802.11an (40MHz)	2412-2462 5190-5230	1 to 11 38 to 46	6 + 46	OFDM OFDM	BPSK BPSK	6.0 15.0
802.11g + 802.11an (20MHz)	2412-2462 5755-5795	1 to 11 149 to 165	6 + 165	OFDM OFDM	BPSK BPSK	6.0 7.2

**TEST CONDITION:**

APPLICABLE TO	ENVIRONMENTAL CONDITIONS	INPUT POWER (SYSTEM)	TESTED BY
RE≥1G	27deg. C, 65%RH, 993 hPa	120Vac, 60Hz	Brad Wu
RE<1G	26deg. C, 66%RH, 993 hPa	120Vac, 60Hz	Mark Liao
PLC	25deg. C, 65%RH, 1008 hPa	120Vac, 60Hz	Mark Liao



### 3.3 GENERAL DESCRIPTION OF APPLIED STANDARDS

The EUT is a RF Product. According to the specifications of the manufacturer, it must comply with the requirements of the following standards:

**FCC Part 15, Subpart C (Section 15.247)**

**FCC Part 15, Subpart E (Section 15.407)**

**ANSI C63.4-2003**

All test items have been performed and recorded as per the above standards.

**NOTE:** The EUT is also considered as a kind of computer peripheral, because the connection to computer is necessary for typical use. It has been verified to comply with the requirements of FCC Part 15, Subpart B, Class B (DoC). The test report has been issued separately.

### 3.4 DESCRIPTION OF SUPPORT UNITS

The EUT has been tested as an independent unit together with other necessary accessories or support units. The following support units or accessories were used to form a representative test configuration during the tests.

NO.	PRODUCT	BRAND	MODEL NO.	SERIAL NO.	FCC ID
1	EXTERNAL HARD DISK	Terasys	F12-UF	A0100222-4860009	FCC DoC Approved
2	EXTERNAL HARD DISK	Terasys	F12-UF	A0100222-4A71004	FCC DoC Approved
3	NOTEBOOK COMPUTER	DELL	PP05L	12130898320	E2K24CLNS
4	NOTEBOOK COMPUTER	DELL	PP05L	25191592336	E2K24CLNS

NO.	SIGNAL CABLE DESCRIPTION OF THE ABOVE SUPPORT UNITS
1	1.5m shielded cable, terminated with USB connector, w/o core.
2	1.5m shielded cable, terminated with USB connector, w/o core.
3	10m non-shielded RJ45 UTP cable.
4	10m non-shielded RJ45 UTP cable.

**NOTE:** 1. All power cords of the above support units are non shielded (1.8m).  
2. Items 3 ~ 4 acted as communication partners to transfer data.

## 4. TEST TYPES AND RESULTS

### 4.1 RADIATED EMISSION MEASUREMENT

#### 4.1.1 LIMITS OF RADIATED EMISSION MEASUREMENT

Emissions radiated outside of the specified bands, shall be according to the general radiated limits in 15.209 as following:

FREQUENCIES (MHz)	FIELD STRENGTH (microvolts/meter)	MEASUREMENT DISTANCE (meters)
0.009 ~ 0.490	2400/F(kHz)	300
0.490 ~ 1.705	24000/F(kHz)	30
1.705 ~ 30.0	30	30
30 ~ 88	100	3
88 ~ 216	150	3
216 ~ 960	200	3
Above 960	500	3

**NOTE:**

1. The lower limit shall apply at the transition frequencies.
2. Emission level (dBuV/m) = 20 log Emission level (uV/m).
3. As shown in 15.35(b), for frequencies above 1000MHz, the field strength limits are based on average detector, however, the peak field strength of any emission shall not exceed the maximum permitted average limits, specified above by more than 20dB under any condition of modulation.

#### 4.1.2 LIMITS OF UNWANTED EMISSION OUT OF THE RESTRICTED BANDS

FREQUENCIES (MHz)	EIRP LIMIT (dBm)	EQUIVALENT FIELD STRENGTH AT 3m (dBµV/m) *NOTE 3
	PK	PK
5150 ~ 5250	-27	68.3

**NOTE:**

The following formula is used to convert the equipment isotropic radiated power (eirp) to field strength:

$$E = \frac{1000000\sqrt{30P}}{3} \mu\text{V/m, where } P \text{ is the eirp (Watts).}$$



A D T

## 4.1.3 TEST INSTRUMENTS

DESCRIPTION & MANUFACTURER	MODEL NO.	SERIAL NO.	DATE OF CALIBRATION	DUE DATE OF CALIBRATION
Test Receiver ROHDE & SCHWARZ	ESIB7	100212	May 25, 2009	May 24, 2010
Spectrum Analyzer ROHDE & SCHWARZ	FSP40	100040	Jul. 07, 2009	Jul. 06, 2010
BILOG Antenna SCHWARZBECK	VULB9168	9168-156	Apr. 30, 2009	Apr. 29, 2010
HORN Antenna SCHWARZBECK	BBHA 9120 D	9120D-563	Aug. 10, 2009	Aug. 09, 2010
HORN Antenna SCHWARZBECK	BBHA 9170	BBHA9170242	Jan. 06, 2009	Jan. 05, 2010
Preamplifier Agilent	8449B	3008A01910	Sep. 11, 2009	Sep. 10, 2010
Preamplifier Agilent	8447D	2944A10638	Dec. 21, 2009	Dec. 20, 2010
RF signal cable HUBER+SUHNNER	SUCOFLEX 104	218190/4 231241/4	May 13, 2009	May 12, 2010
RF signal cable Worken	8D-FB	Cable-HYCH9-01	Aug. 17, 2009	Aug. 16, 2010
Software	ADT_Radiated_ V7.6.15.9.2	NA	NA	NA
Antenna Tower EMCO	2070/2080	512.835.4684	NA	NA
Turn Table EMCO	2087-2.03	NA	NA	NA
Antenna Tower & Turn Table Controller EMCO	2090	NA	NA	NA
26GHz ~ 40GHz Amplifier	EM26400	07026401	Aug. 27, 2009	Aug. 26, 2010

- NOTE:** 1. The calibration interval of the above test instruments is 12 months and the calibrations are traceable to NML/ROC and NIST/USA.
2. The test was performed in HwaYa Chamber 9.
3. The horn antenna and HP preamplifier (model: 8449B) are used only for the measurement of emission frequency above 1GHz if tested.
4. The FCC Site Registration No. is 460141.
5. The IC Site Registration No. is IC 7450F-4.

#### 4.1.4 TEST PROCEDURES

- a. The EUT was placed on the top of a rotating table 0.8 meters above the ground at a 3 meters semi-anechoic chamber. The table was rotated 360 degrees to determine the position of the highest radiation.
- b. The EUT was set 3 meters away from the interference-receiving antenna, which was mounted on the top of a variable-height antenna tower.
- c. The antenna is a broadband antenna, and its height is varied from one meter to four meters above the ground to determine the maximum value of the field strength. Both horizontal and vertical polarizations of the antenna are set to make the measurement.
- d. For each suspected emission, the EUT was arranged to its worst case and then the antenna was tuned to heights from 1 meter to 4 meters and the rotatable table was turned from 0 degrees to 360 degrees to find the maximum reading.
- e. The test-receiver system was set to Peak Detect Function and Specified Bandwidth with Maximum Hold Mode.
- f. If the emission level of the EUT in peak mode was lower than the limit specified, then testing could be stopped and the peak values of the EUT would be reported. Otherwise the emissions would be re-tested one by one using peak, quasi-peak or average method as specified and then reported in a data sheet.

**NOTE:**

1. The resolution bandwidth and video bandwidth of test receiver/spectrum analyzer is 120kHz for Quasi-peak detection at frequency below 1GHz.
2. The resolution bandwidth of test receiver/spectrum analyzer is 1MHz and video bandwidth is 3MHz for Peak detection at frequency above 1GHz.
3. All modes of operation were investigated and the worst-case emissions are reported.

#### 4.1.5 DEVIATION FROM TEST STANDARD

No deviation

#### 4.1.6 TEST SETUP

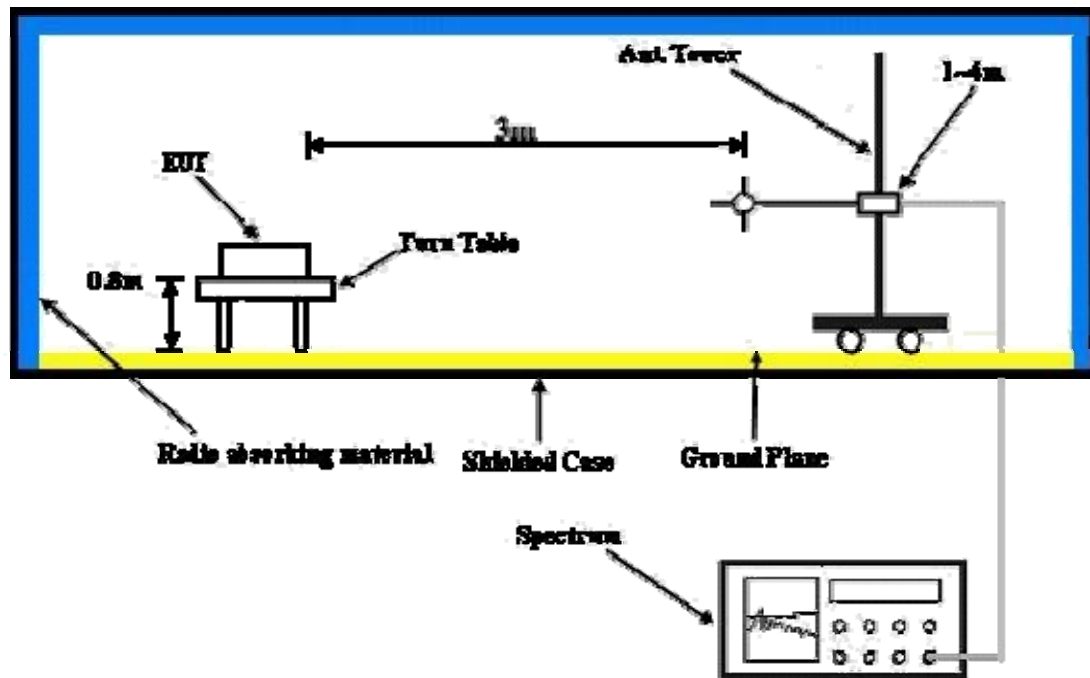

For the actual test configuration, please refer to the attached file (Test Setup Photo).

#### 4.1.7 EUT OPERATING CONDITIONS

- a. Placed the EUT on the testing table.
- b. Prepared notebook system outside of testing area to act as a communication partners.
- c. The communication partner connected with EUT via a RJ45 UTP cable and run a test program (provided by manufacturer) to enable EUT under transmission condition continuously at specific channel frequency.
- d. The communication partner sent data to EUT by command "PING".



A D T

### 4.1.8 TEST RESULTS

For 2.4GHz & 5.18 ~ 5.24GHz

802.11g + 802.11an (20MHz)

EUT TEST CONDITION		MEASUREMENT DETAIL	
CHANNEL	CH 6 + CH 36	FREQUENCY RANGE	1 ~ 40GHz
INPUT POWER (SYSTEM)	120Vac, 60 Hz	DETECTOR FUNCTION	Peak (PK) Average (AV)
ENVIRONMENTAL CONDITIONS	27deg. C, 65%RH 993hPa	TESTED BY	Brad Wu

ANTENNA POLARITY & TEST DISTANCE: HORIZONTAL AT 3 M								
No.	Freq. (MHz)	Emission Level (dBuV/m)	Limit (dBuV/m)	Margin (dB)	Antenna Height (m)	Table Angle (Degree)	Raw Value (dBuV)	Correction Factor (dB/m)
1	*2437.00	103.7 PK			1.05 H	111	71.30	32.40
2	*2437.00	91.9 AV			1.05 H	111	59.50	32.40
3	4874.00	49.8 PK	74.0	-24.2	1.41 H	219	11.30	38.50
4	4874.00	37.9 AV	54.0	-16.1	1.41 H	219	-0.60	38.50
5	5150.00	61.0 PK	74.0	-13.0	1.20 H	258	22.00	39.00
6	5150.00	45.7 AV	54.0	-8.3	1.20 H	258	6.70	39.00
7	*5180.00	102.1 PK			1.20 H	258	63.10	39.00
8	*5180.00	90.9 AV			1.20 H	258	51.90	39.00
9	#10360.00	65.2 PK	68.3	-3.1	1.24 H	220	16.50	48.70
ANTENNA POLARITY & TEST DISTANCE: VERTICAL AT 3 M								
No.	Freq. (MHz)	Emission Level (dBuV/m)	Limit (dBuV/m)	Margin (dB)	Antenna Height (m)	Table Angle (Degree)	Raw Value (dBuV)	Correction Factor (dB/m)
1	*2437.00	115.4 PK			1.11 V	180	83.00	32.40
2	*2437.00	102.7 AV			1.11 V	180	70.30	32.40
3	4874.00	50.7 PK	74.0	-23.3	1.00 V	277	12.20	38.50
4	4874.00	38.2 AV	54.0	-15.8	1.00 V	277	-0.30	38.50
5	5150.00	65.2 PK	74.0	-8.8	1.09 V	100	26.20	39.00
6	5150.00	50.0 AV	54.0	-4.0	1.09 V	100	11.00	39.00
7	*5180.00	110.4 PK			1.09 V	100	71.40	39.00
8	*5180.00	99.3 AV			1.09 V	100	60.30	39.00
9	#10360.00	66.9 PK	68.3	-1.4	1.23 V	36	18.20	48.70

- REMARKS:**
1. Emission level (dBuV/m) = Raw Value (dBuV) + Correction Factor (dB/m).
  2. Correction Factor (dB/m) = Antenna Factor (dB/m) + Cable Factor (dB).
  3. The other emission levels were very low against the limit.
  4. Margin value = Emission level – Limit value.
  5. “ \* “: Fundamental frequency.
  6. The limit value is defined as per 15.247 & 15.407.
  7. “ # ”: The radiated frequency is out of the restricted band.





A D T

802.11g + 802.11an (40MHz)

EUT TEST CONDITION		MEASUREMENT DETAIL	
CHANNEL	CH 6 + CH 46	FREQUENCY RANGE	1 ~ 40GHz
INPUT POWER (SYSTEM)	120Vac, 60 Hz	DETECTOR FUNCTION	Peak (PK) Average (AV)
ENVIRONMENTAL CONDITIONS	27deg. C, 65%RH 993hPa	TESTED BY	Brad Wu

ANTENNA POLARITY & TEST DISTANCE: HORIZONTAL AT 3 M								
No.	Freq. (MHz)	Emission Level (dBuV/m)	Limit (dBuV/m)	Margin (dB)	Antenna Height (m)	Table Angle (Degree)	Raw Value (dBuV)	Correction Factor (dB/m)
1	*2437.00	103.7 PK			1.26 H	310	71.30	32.40
2	*2437.00	91.8 AV			1.26 H	310	59.40	32.40
3	4874.00	49.9 PK	74.0	-24.1	1.01 H	168	11.40	38.50
4	4874.00	37.6 AV	54.0	-16.4	1.01 H	168	-0.90	38.50
5	*5230.00	102.6 PK			1.11 H	154	63.50	39.10
6	*5230.00	80.8 AV			1.11 H	154	41.70	39.10
7	5350.00	54.7 PK	74.0	-19.3	1.11 H	154	15.40	39.30
8	5350.00	44.0 AV	54.0	-10.0	1.11 H	154	4.70	39.30
9	#10460.00	65.5 PK	68.3	-2.8	1.37 H	225	16.60	48.90
ANTENNA POLARITY & TEST DISTANCE: VERTICAL AT 3 M								
No.	Freq. (MHz)	Emission Level (dBuV/m)	Limit (dBuV/m)	Margin (dB)	Antenna Height (m)	Table Angle (Degree)	Raw Value (dBuV)	Correction Factor (dB/m)
1	*2437.00	115.5 PK			1.22 V	215	83.10	32.40
2	*2437.00	102.8 AV			1.22 V	215	70.40	32.40
3	4874.00	50.7 PK	74.0	-23.3	1.01 V	2	12.20	38.50
4	4874.00	37.9 AV	54.0	-16.1	1.01 V	2	-0.60	38.50
5	*5230.00	108.8 PK			1.25 V	351	69.70	39.10
6	*5230.00	96.9 AV			1.25 V	351	57.80	39.10
7	5350.00	56.1 PK	74.0	-17.9	1.23 V	351	16.80	39.30
8	5350.00	44.7 AV	54.0	-9.3	1.23 V	351	5.40	39.30
9	#10460.00	65.2 PK	68.3	-3.1	1.00 V	218	16.30	48.90

- REMARKS:**
1. Emission level (dBuV/m) = Raw Value (dBuV) + Correction Factor (dB/m).
  2. Correction Factor (dB/m) = Antenna Factor (dB/m) + Cable Factor (dB).
  3. The other emission levels were very low against the limit.
  4. Margin value = Emission level – Limit value.
  5. “ \* “: Fundamental frequency.
  6. The limit value is defined as per 15.247 & 15.407.
  7. “ # “: The radiated frequency is out of the restricted band.



A D T

For 2.4GHz & 5.745 ~ 5.825GHz

802.11g + 802.11an (20MHz)

EUT TEST CONDITION		MEASUREMENT DETAIL	
CHANNEL	CH 6 + CH 165	FREQUENCY RANGE	1 ~ 40GHz
INPUT POWER (SYSTEM)	120Vac, 60 Hz	DETECTOR FUNCTION	Peak (PK) Average (AV)
ENVIRONMENTAL CONDITIONS	27deg. C, 65%RH 993hPa	TESTED BY	Brad Wu

ANTENNA POLARITY & TEST DISTANCE: HORIZONTAL AT 3 M								
No.	Freq. (MHz)	Emission Level (dBuV/m)	Limit (dBuV/m)	Margin (dB)	Antenna Height (m)	Table Angle (Degree)	Raw Value (dBuV)	Correction Factor (dB/m)
1	*2437.00	103.9 PK			1.01 H	113	71.50	32.40
2	*2437.00	92.0 AV			1.01 H	113	59.60	32.40
3	4874.00	49.9 PK	74.0	-24.10	1.00 H	202	11.40	38.50
4	4874.00	38.1 AV	54.0	-15.90	1.00 H	202	-0.40	38.50
5	*5825.00	102.8 PK			1.10 H	213	62.70	40.10
6	*5825.00	90.2 AV			1.10 H	213	50.10	40.10
7	#5850.00	59.7 PK	82.8	-23.1	1.10 H	213	19.60	40.10
8	#5850.00	43.3 AV	70.2	-26.9	1.10 H	213	3.20	40.10
9	11650.00	62.3 PK	74.0	-11.70	1.50 H	349	11.90	50.40
10	11650.00	50.4 AV	54.0	-3.60	1.50 H	349	0.00	50.40
ANTENNA POLARITY & TEST DISTANCE: VERTICAL AT 3 M								
No.	Freq. (MHz)	Emission Level (dBuV/m)	Limit (dBuV/m)	Margin (dB)	Antenna Height (m)	Table Angle (Degree)	Raw Value (dBuV)	Correction Factor (dB/m)
1	*2437.00	115.9 PK			1.08 V	255	83.50	32.40
2	*2437.00	103.0 AV			1.08 V	255	70.60	32.40
3	4874.00	50.8 PK	74.0	-23.2	1.01 V	119	12.30	38.50
4	4874.00	38.2 AV	54.0	-15.8	1.01 V	119	-0.30	38.50
5	*5825.00	113.9 PK			1.11 V	346	73.80	40.10
6	*5825.00	101.7 AV			1.11 V	346	61.60	40.10
7	#5850.00	70.8 PK	93.9	-23.1	1.11 V	346	30.70	40.10
8	#5850.00	54.4 AV	81.7	-27.3	1.11 V	346	14.30	40.10
9	11650.00	61.9 PK	74.0	-12.1	1.01 V	156	11.50	50.40
10	11650.00	49.9 AV	54.0	-4.1	1.01 V	156	-0.50	50.40

- REMARKS:**
1. Emission level (dBuV/m) = Raw Value (dBuV) + Correction Factor (dB/m).
  2. Correction Factor (dB/m) = Antenna Factor (dB/m) + Cable Factor (dB).
  3. The other emission levels were very low against the limit.
  4. Margin value = Emission level – Limit value.
  5. “ \* ”: Fundamental frequency.
  6. The limit value is defined as per 15.247.
  7. “ # ”: The radiated frequency is out of the restricted band.



A D T

## 802.11g + 802.11an (40MHz)

EUT TEST CONDITION		MEASUREMENT DETAIL	
CHANNEL	CH 6 + CH 159	FREQUENCY RANGE	1 ~ 40GHz
INPUT POWER (SYSTEM)	120Vac, 60 Hz	DETECTOR FUNCTION	Peak (PK) Average (AV)
ENVIRONMENTAL CONDITIONS	27deg. C, 65%RH 993hPa	TESTED BY	Brad Wu

## ANTENNA POLARITY &amp; TEST DISTANCE: HORIZONTAL AT 3 M

No.	Freq. (MHz)	Emission Level (dBuV/m)	Limit (dBuV/m)	Margin (dB)	Antenna Height (m)	Table Angle (Degree)	Raw Value (dBuV)	Correction Factor (dB/m)
1	*2437.00	103.9 PK			1.00 H	280	71.50	32.40
2	*2437.00	92.1 AV			1.00 H	280	59.70	32.40
3	4874.00	50.2 PK	74.0	-23.8	1.31 H	216	11.70	38.50
4	4874.00	38.1 AV	54.0	-15.9	1.31 H	216	-0.40	38.50
5	*5795.00	104.9 PK			1.16 H	203	64.90	40.00
6	*5795.00	83.5 AV			1.16 H	203	43.50	40.00
7	#5850.00	65.1 PK	84.9	-19.8	1.16 H	203	25.00	40.10
8	#5850.00	47.4 AV	63.5	-16.1	1.16 H	203	7.30	40.10
9	11590.00	61.9 PK	74.0	-12.1	1.46 H	211	11.40	50.50
10	11590.00	49.8 AV	54.0	-4.2	1.46 H	211	-0.70	50.50

## ANTENNA POLARITY &amp; TEST DISTANCE: VERTICAL AT 3 M

No.	Freq. (MHz)	Emission Level (dBuV/m)	Limit (dBuV/m)	Margin (dB)	Antenna Height (m)	Table Angle (Degree)	Raw Value (dBuV)	Correction Factor (dB/m)
1	*2437.00	115.8 PK			1.22 V	155	83.40	32.40
2	*2437.00	103.2 AV			1.22 V	155	70.80	32.40
3	4874.00	51.0 PK	74.0	-23.0	1.46 V	200	12.50	38.50
4	4874.00	38.5 AV	54.0	-15.5	1.46 V	200	0.00	38.50
5	*5795.00	111.2 PK			1.30 V	170	71.20	40.00
6	*5795.00	100.3 AV			1.30 V	170	60.30	40.00
7	#5850.00	66.2 PK	91.2	-25.0	1.30 V	170	26.10	40.10
8	#5850.00	49.1 AV	80.3	-31.2	1.30 V	170	9.00	40.10
9	11590.00	63.9 PK	74.0	-10.1	1.00 V	111	13.40	50.50
10	11590.00	51.3 AV	54.0	-2.70	1.00 V	111	0.80	50.50

- REMARKS:**
1. Emission level (dBuV/m) = Raw Value (dBuV) + Correction Factor (dB/m).
  2. Correction Factor (dB/m) = Antenna Factor (dB/m) + Cable Factor (dB).
  3. The other emission levels were very low against the limit.
  4. Margin value = Emission level – Limit value.
  5. “ \* ”: Fundamental frequency.
  6. The limit value is defined as per 15.247.
  7. “ # ”: The radiated frequency is out of the restricted band.



A D T

**BELOW 1GHz WORST-CASE DATA**

802.11g + 802.11an (40MHz)

EUT TEST CONDITION		MEASUREMENT DETAIL	
CHANNEL	CH 6 + CH 46	FREQUENCY RANGE	Below 1000MHz
INPUT POWER (SYSTEM)	120Vac, 60 Hz	DETECTOR FUNCTION	Quasi-Peak
ENVIRONMENTAL CONDITIONS	26deg. C, 66%RH 993hPa	TESTED BY	Mark Liao

ANTENNA POLARITY & TEST DISTANCE: HORIZONTAL AT 3 M								
NO.	FREQ. (MHz)	EMISSION LEVEL (dBuV/m)	LIMIT (dBuV/m)	MARGIN (dB)	ANTENNA HEIGHT (m)	TABLE ANGLE (Degree)	RAW VALUE (dBuV)	CORRECTION FACTOR (dB/m)
1	133.33	41.3 QP	43.5	-2.2	2.00 H	116	29.00	12.30
2	185.00	41.0 QP	43.5	-2.5	1.50 H	116	29.20	11.80
3	222.38	44.1 QP	46.0	-1.9	1.50 H	295	32.50	11.60
4	240.00	44.3 QP	46.0	-1.7	1.52 H	269	31.90	12.40
5	<b>389.59</b>	<b>44.7 QP</b>	<b>46.0</b>	<b>-1.3</b>	<b>1.00 H</b>	<b>322</b>	<b>28.80</b>	<b>15.90</b>
6	500.42	42.1 QP	46.0	-3.9	1.75 H	310	22.80	19.30
ANTENNA POLARITY & TEST DISTANCE: VERTICAL AT 3 M								
NO.	FREQ. (MHz)	EMISSION LEVEL (dBuV/m)	LIMIT (dBuV/m)	MARGIN (dB)	ANTENNA HEIGHT (m)	TABLE ANGLE (Degree)	RAW VALUE (dBuV)	CORRECTION FACTOR (dB/m)
1	115.14	41.6 QP	43.5	-1.9	1.00 V	32	30.40	11.20
2	158.22	40.8 QP	43.5	-2.7	1.00 V	55	27.00	13.80
3	226.00	43.7 QP	46.0	-2.3	1.01 V	291	31.90	11.80
4	239.88	41.6 QP	46.0	-4.4	1.00 V	82	29.20	12.40
5	500.42	43.3 QP	46.0	-2.7	1.25 V	10	24.00	19.30
6	626.80	38.4 QP	46.0	-7.6	1.50 V	295	16.20	22.20

- REMARKS:**
1. Emission level (dBuV/m) = Raw Value (dBuV) + Correction Factor (dB/m).
  2. Correction Factor (dB/m) = Antenna Factor (dB/m) + Cable Factor (dB).
  3. The other emission levels were very low against the limit.
  4. Margin value = Emission level – Limit value.



A D T

## 802.11g + 802.11an (20MHz)

EUT TEST CONDITION		MEASUREMENT DETAIL	
CHANNEL	CH 6 + CH 165	FREQUENCY RANGE	Below 1000MHz
INPUT POWER (SYSTEM)	120Vac, 60 Hz	DETECTOR FUNCTION	Quasi-Peak
ENVIRONMENTAL CONDITIONS	26deg. C, 66%RH 993hPa	TESTED BY	Mark Liao

ANTENNA POLARITY & TEST DISTANCE: HORIZONTAL AT 3 M								
NO.	FREQ. (MHz)	EMISSION LEVEL (dBuV/m)	LIMIT (dBuV/m)	MARGIN (dB)	ANTENNA HEIGHT (m)	TABLE ANGLE (Degree)	RAW VALUE (dBuV)	CORRECTION FACTOR (dB/m)
1	115.45	39.5 QP	43.5	-4.0	1.00 H	304	28.30	11.20
2	166.00	41.3 QP	43.5	-2.2	1.25 H	112	28.00	13.30
3	222.38	43.7 QP	46.0	-2.3	1.00 H	286	32.10	11.60
4	235.99	43.5 QP	46.0	-2.5	1.00 H	277	31.20	12.30
5	389.59	44.2 QP	46.0	-1.8	1.00 H	328	28.30	15.90
6	613.19	39.8 QP	46.0	-6.2	1.25 H	73	17.70	22.10
ANTENNA POLARITY & TEST DISTANCE: VERTICAL AT 3 M								
NO.	FREQ. (MHz)	EMISSION LEVEL (dBuV/m)	LIMIT (dBuV/m)	MARGIN (dB)	ANTENNA HEIGHT (m)	TABLE ANGLE (Degree)	RAW VALUE (dBuV)	CORRECTION FACTOR (dB/m)
1	115.00	41.1 QP	43.5	-2.4	1.27 V	32	29.90	11.20
2	158.22	40.9 QP	43.5	-2.6	1.00 V	67	27.10	13.80
3	226.00	43.9 QP	46.0	-2.1	1.05 V	293	32.10	11.80
4	243.77	40.8 QP	46.0	-5.2	1.00 V	106	28.20	12.60
5	500.42	42.6 QP	46.0	-3.4	1.25 V	37	23.30	19.30
6	626.80	38.5 QP	46.0	-7.5	1.50 V	277	16.30	22.20

- REMARKS:**
1. Emission level (dBuV/m) = Raw Value (dBuV) + Correction Factor (dB/m).
  2. Correction Factor (dB/m) = Antenna Factor (dB/m) + Cable Factor (dB).
  3. The other emission levels were very low against the limit.
  4. Margin value = Emission level – Limit value.

## 4.2 CONDUCTED EMISSION MEASUREMENT

### 4.2.1 LIMITS OF CONDUCTED EMISSION MEASUREMENT

FREQUENCY OF EMISSION (MHz)	CONDUCTED LIMIT (dB $\mu$ V)	
	Quasi-peak	Average
0.15 ~ 0.5	66 to 56	56 to 46
0.5 ~ 5	56	46
5 ~ 30	60	50

- NOTE:** 1. The lower limit shall apply at the transition frequencies.
2. The limit decreases in line with the logarithm of the frequency in the range of 0.15 to 0.50MHz.
3. All emanations from a class A/B digital device or system, including any network of conductors and apparatus connected thereto, shall not exceed the level of field strengths specified above.

### 4.2.2 TEST INSTRUMENTS

DESCRIPTION & MANUFACTURER	MODEL NO.	SERIAL NO.	DATE OF CALIBRATION	DUE DATE OF CALIBRATION
Test Receiver ROHDE & SCHWARZ	ESCS30	100288	Sep. 24, 2009	Sep. 23, 2010
RF signal cable Woken	5D-FB	Cable-HYCO2-01	Dec. 31, 2008	Dec. 30, 2009
LISN ROHDE & SCHWARZ	ESH2-Z5	100100	Dec. 29, 2008	Dec. 28, 2009
LISN ROHDE & SCHWARZ	ESH3-Z5	100311	Jul. 29, 2009	Jul. 28, 2010
Software ADT	ADT_Cond_ V7.3.7	NA	NA	NA

- NOTE:** 1. The calibration interval of the above test instruments is 12 months and the calibrations are traceable to NML/ROC and NIST/USA.
2. The test was performed in HwaYa Shielded Room 2.
3. The VCCI Site Registration No. is C-2047.

#### 4.2.3 TEST PROCEDURES

- a. The EUT was placed 0.4 meters from the conducting wall of the shielded room with EUT being connected to the power mains through a line impedance stabilization network (LISN). Other support units were connected to the power mains through another LISN. The two LISNs provide 50 ohm/ 50uH of coupling impedance for the measuring instrument.
- b. Both lines of the power mains connected to the EUT were checked for maximum conducted interference.
- c. The frequency range from 150kHz to 30MHz was searched. Emission levels under (Limit - 20dB) was not recorded.

**NOTE:** All modes of operation were investigated and the worst-case emissions are reported.

#### 4.2.4 DEVIATION FROM TEST STANDARD

No deviation.

#### 4.2.5 TEST SETUP

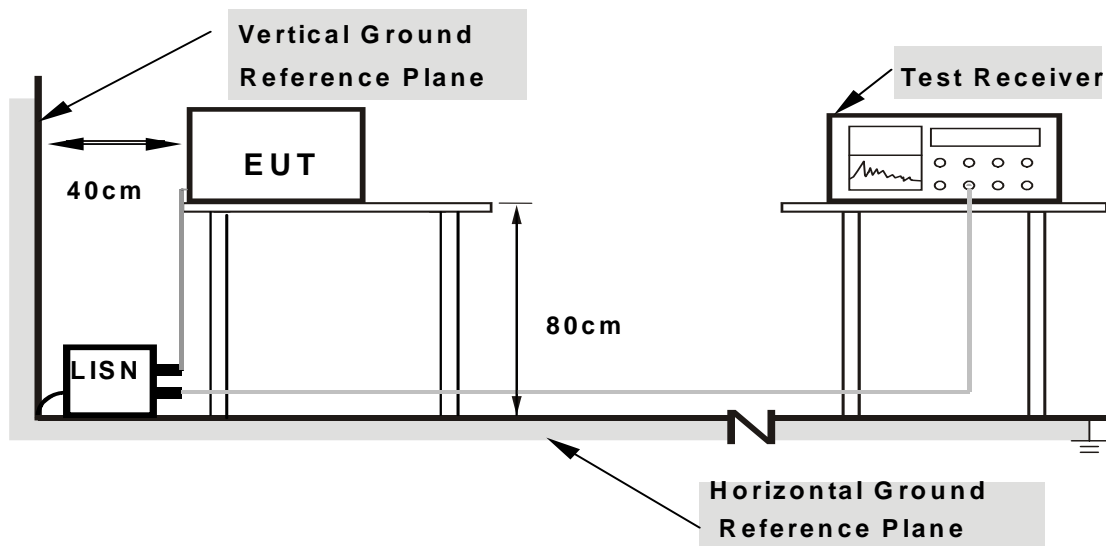

- Note:**
1. Support units were connected to second LISN.
  2. Both of LISNs (AMN) are 80 cm from EUT and at least 80 from other units and other metal planes

For the actual test configuration, please refer to the attached file (Test Setup Photo).

#### 4.2.6 EUT OPERATING CONDITIONS

Same as 4.1.6.



### 4.2.7 TEST RESULTS

For 2.4GHz & 5.18 ~ 5.24GHz

CONDUCTED WORST-CASE DATA : 802.11g + 802.11an (40MHz)

<b>PHASE</b>	Line 1	<b>6dB BANDWIDTH</b>	9kHz
--------------	--------	----------------------	------

No	Freq. [MHz]	Corr.	Reading Value		Emission Level		Limit		Margin	
		Factor (dB)	Q.P. [dB (uV)]	AV. [dB (uV)]	Q.P. [dB (uV)]	AV. [dB (uV)]	Q.P. [dB (uV)]	AV. [dB (uV)]	Q.P. (dB)	AV. (dB)
1	0.180	0.13	56.36	45.44	56.49	45.57	64.47	54.47	-7.98	-8.90
2	0.245	0.13	46.21	-	46.34	-	61.92	51.92	-15.58	-
3	0.373	0.14	37.92	-	38.06	-	58.44	48.44	-20.38	-
4	0.480	0.14	36.52	-	36.66	-	56.34	46.34	-19.68	-
5	4.695	0.30	24.79	-	25.09	-	56.00	46.00	-30.91	-
6	18.874	0.64	33.97	-	34.61	-	60.00	50.00	-25.39	-

- REMARKS:**
1. Q.P. and AV. are abbreviations of quasi-peak and average individually.
  2. "-": The Quasi-peak reading value also meets average limit and measurement with the average detector is unnecessary.
  3. The emission levels of other frequencies were very low against the limit.
  4. Margin value = Emission level - Limit value
  5. Correction factor = Insertion loss + Cable loss
  6. Emission Level = Correction Factor + Reading Value.

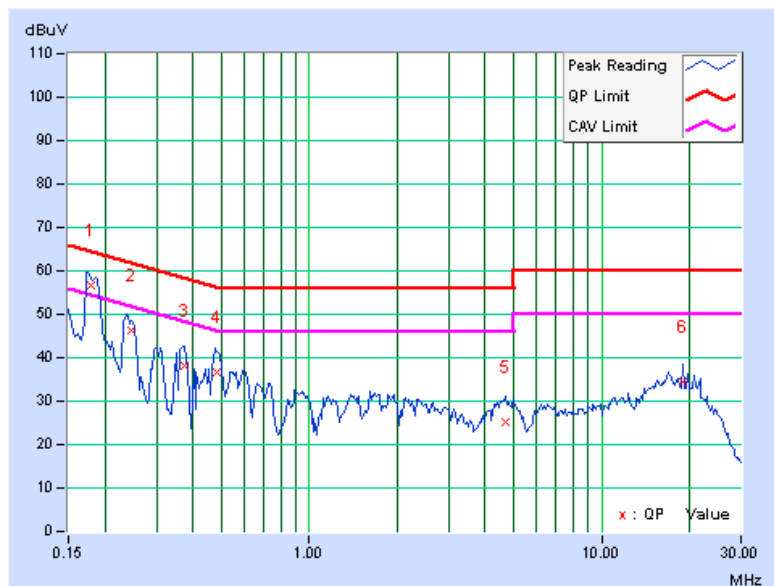



A D T

PHASE	Line 2	6dB BANDWIDTH	9kHz
-------	--------	---------------	------

No	Freq. [MHz]	Corr. Factor (dB)	Reading Value [dB (uV)]		Emission Level [dB (uV)]		Limit [dB (uV)]		Margin (dB)	
			Q.P.	AV.	Q.P.	AV.	Q.P.	AV.	Q.P.	AV.
1	0.181	0.13	56.10	44.70	56.23	44.83	64.43	54.43	-8.20	-9.60
2	0.247	0.13	45.37	-	45.50	-	61.84	51.84	-16.34	-
3	0.369	0.15	39.46	-	39.61	-	58.53	48.53	-18.92	-
4	0.478	0.15	35.85	-	36.00	-	56.37	46.37	-20.37	-
5	5.406	0.35	25.39	-	25.74	-	60.00	50.00	-34.26	-
6	20.753	0.81	33.97	-	34.78	-	60.00	50.00	-25.22	-

- REMARKS:**
1. Q.P. and AV. are abbreviations of quasi-peak and average individually.
  2. "-": The Quasi-peak reading value also meets average limit and measurement with the average detector is unnecessary.
  3. The emission levels of other frequencies were very low against the limit.
  4. Margin value = Emission level - Limit value
  5. Correction factor = Insertion loss + Cable loss
  6. Emission Level = Correction Factor + Reading Value.

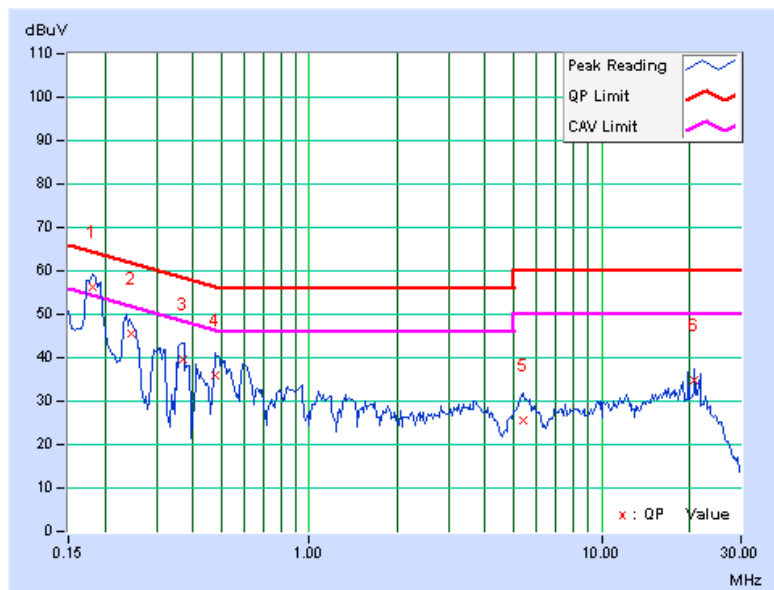



A D T

For 2.4GHz & 5.745 ~ 5.825GHz

CONDUCTED WORST-CASE DATA : 802.11g + 802.11an (20MHz)

PHASE	Line 1	6dB BANDWIDTH	9kHz
-------	--------	---------------	------

No	Freq. [MHz]	Corr.	Reading Value		Emission Level		Limit		Margin	
		Factor (dB)	Q.P. [dB (uV)]	AV. [dB (uV)]	Q.P. [dB (uV)]	AV. [dB (uV)]	Q.P. [dB (uV)]	AV. [dB (uV)]	Q.P. (dB)	AV. (dB)
1	0.181	0.13	55.47	43.34	55.60	43.47	64.43	54.43	-8.83	-10.96
2	0.240	0.13	44.72	-	44.85	-	62.10	52.10	-17.25	-
3	0.314	0.14	37.85	-	37.99	-	59.86	49.86	-21.88	-
4	0.373	0.14	38.39	-	38.53	-	58.44	48.44	-19.91	-
5	4.609	0.30	25.25	-	25.55	-	56.00	46.00	-30.45	-
6	21.680	0.66	37.32	-	37.98	-	60.00	50.00	-22.02	-

- REMARKS:**
1. Q.P. and AV. are abbreviations of quasi-peak and average individually.
  2. "-": The Quasi-peak reading value also meets average limit and measurement with the average detector is unnecessary.
  3. The emission levels of other frequencies were very low against the limit.
  4. Margin value = Emission level - Limit value
  5. Correction factor = Insertion loss + Cable loss
  6. Emission Level = Correction Factor + Reading Value.

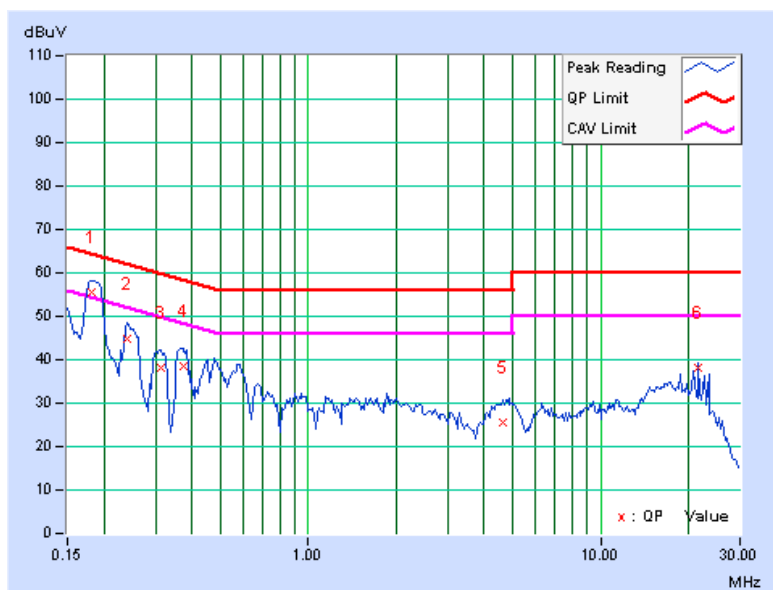

PHASE	Line 2	6dB BANDWIDTH	9kHz
-------	--------	---------------	------

No	Freq. [MHz]	Corr. Factor (dB)	Reading Value [dB (uV)]		Emission Level [dB (uV)]		Limit [dB (uV)]		Margin (dB)	
			Q.P.	AV.	Q.P.	AV.	Q.P.	AV.	Q.P.	AV.
1	0.181	0.13	55.89	43.44	56.02	43.57	64.43	54.43	-8.41	-10.86
2	0.244	0.13	45.45	-	45.58	-	61.97	51.97	-16.38	-
3	0.380	0.15	37.88	-	38.03	-	58.27	48.27	-20.24	-
4	0.482	0.15	36.28	-	36.43	-	56.30	46.30	-19.87	-
5	5.516	0.35	25.28	-	25.63	-	60.00	50.00	-34.37	-
6	21.685	0.81	36.46	-	37.27	-	60.00	50.00	-22.73	-

- REMARKS:**
1. Q.P. and AV. are abbreviations of quasi-peak and average individually.
  2. "-": The Quasi-peak reading value also meets average limit and measurement with the average detector is unnecessary.
  3. The emission levels of other frequencies were very low against the limit.
  4. Margin value = Emission level - Limit value
  5. Correction factor = Insertion loss + Cable loss
  6. Emission Level = Correction Factor + Reading Value.

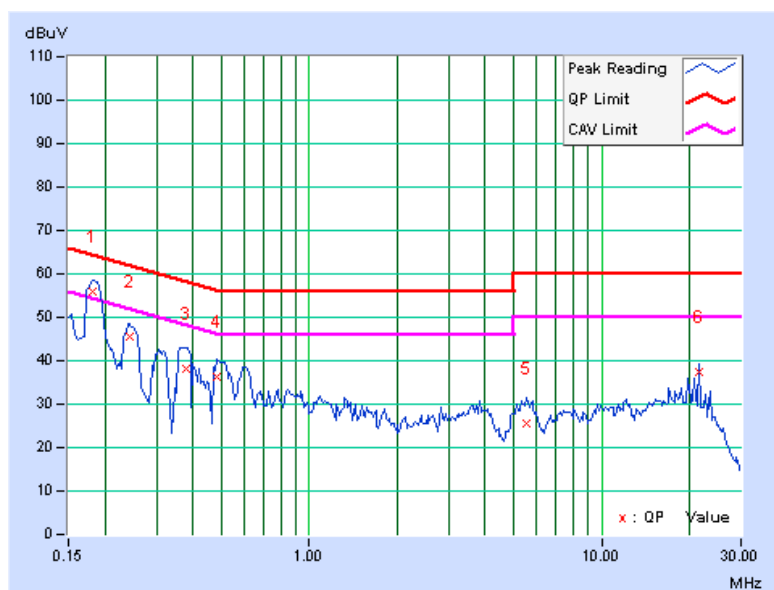

### **4.3 OUTBAND EMISSION MEASUREMENT**

#### **4.3.1 TEST INSTRUMENTS**

Same as item 4.1.3

#### **4.3.2 TEST PROCEDURE**

Same as item 4.1.4

#### **4.3.3 DEVIATION FROM TEST STANDARD**

No deviation

#### **4.3.4 TEST SETUP**

Same as item 4.1.6

#### **4.3.5 EUT OPERATING CONDITIONS**

The software provided by client to enable the EUT under transmission condition continuously at specific channel frequencies individually.



A D T

### 4.3.6 TEST RESULTS

For 2.4GHz & 5.18 ~ 5.24GHz

802.11g + 802.11an (20MHz)

CH 6 + CH 36

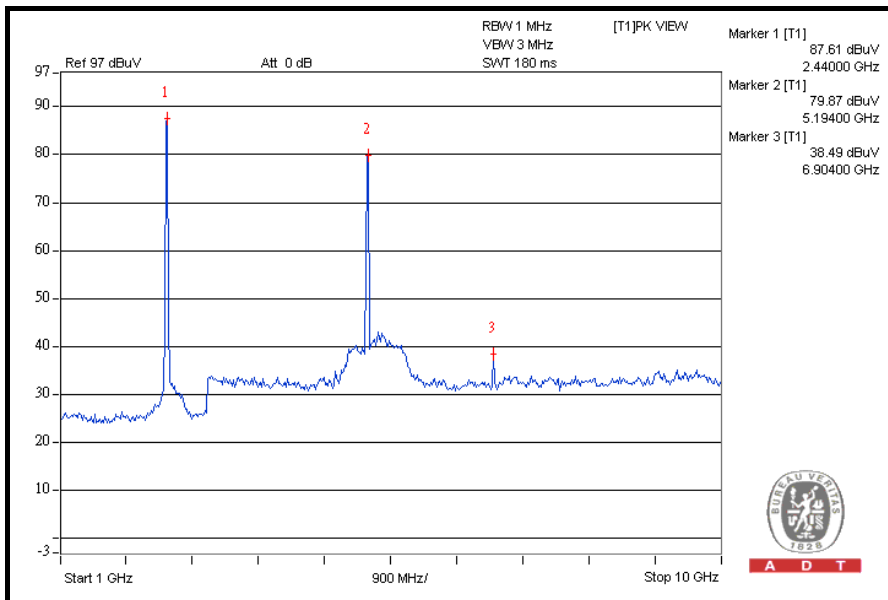
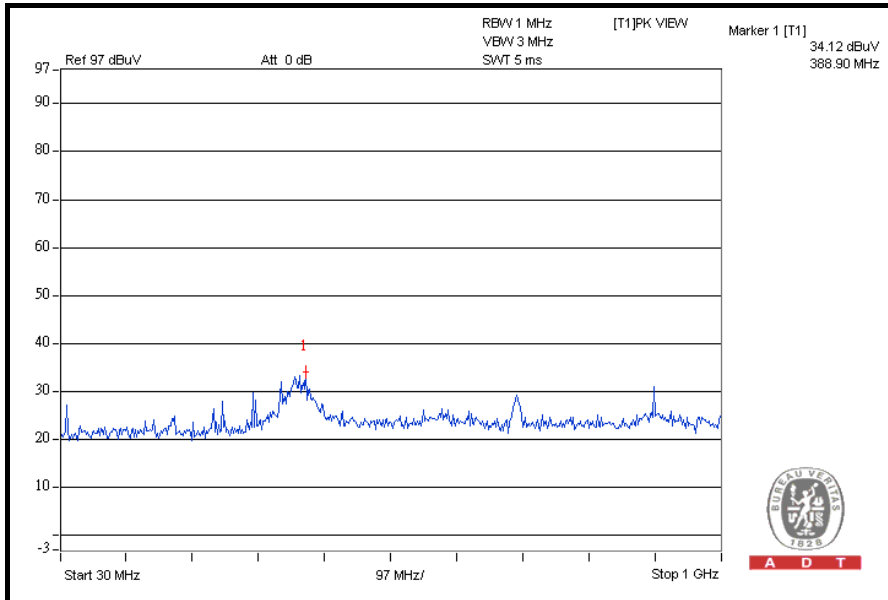



A D T

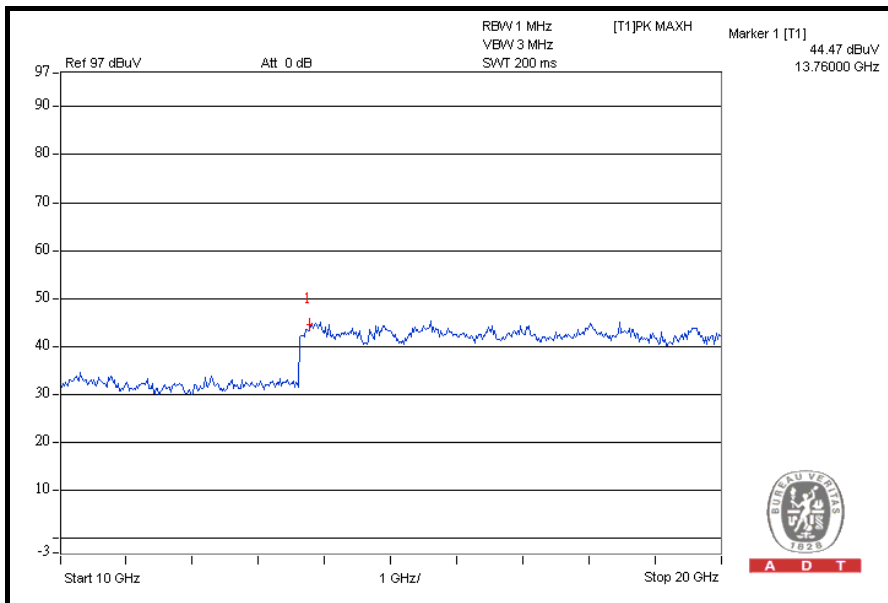

A D T

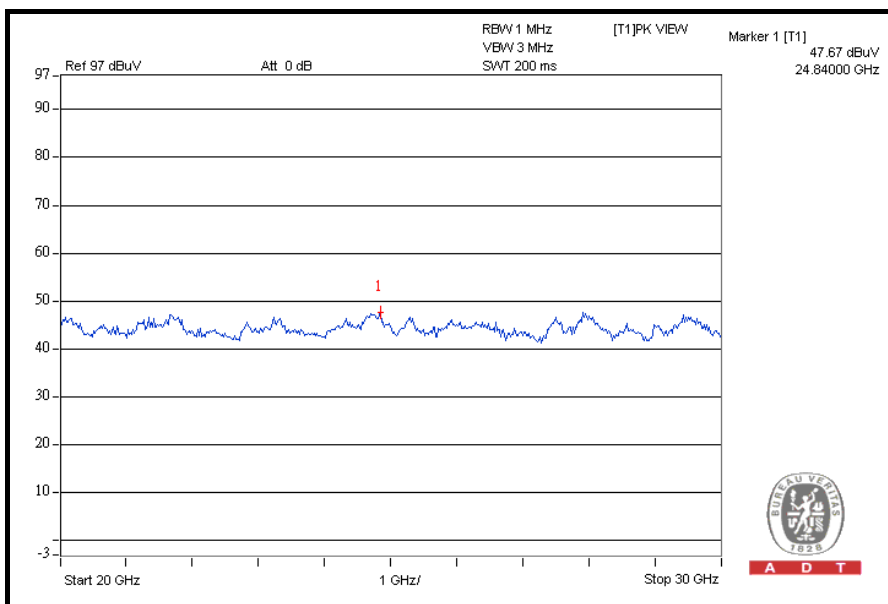

A D T



A D T

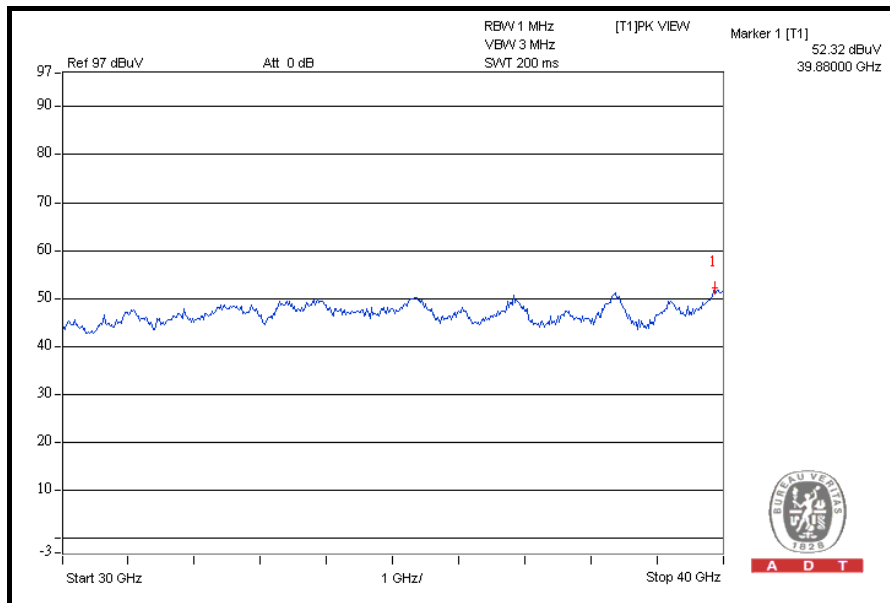





A D T

## 802.11g + 802.11an (40MHz)

### CH 6 + CH 46

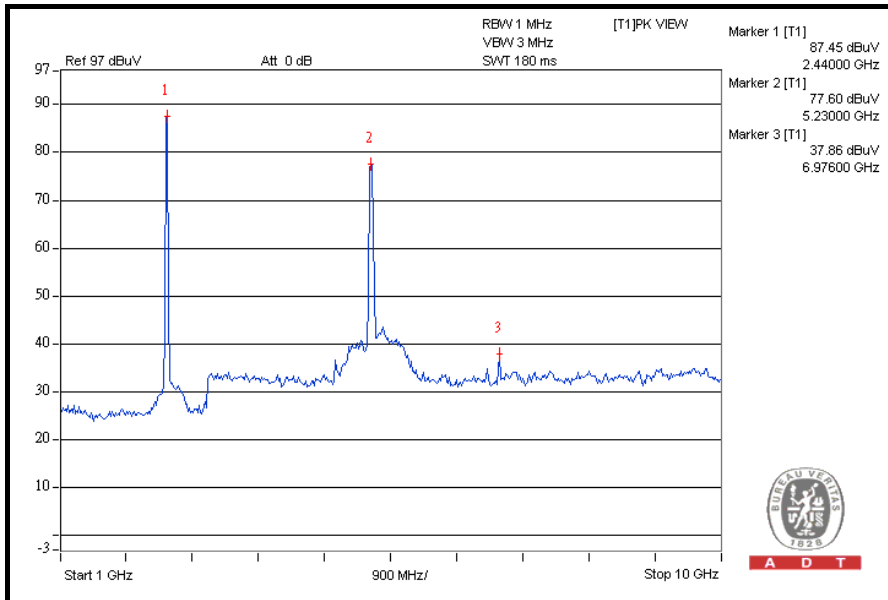
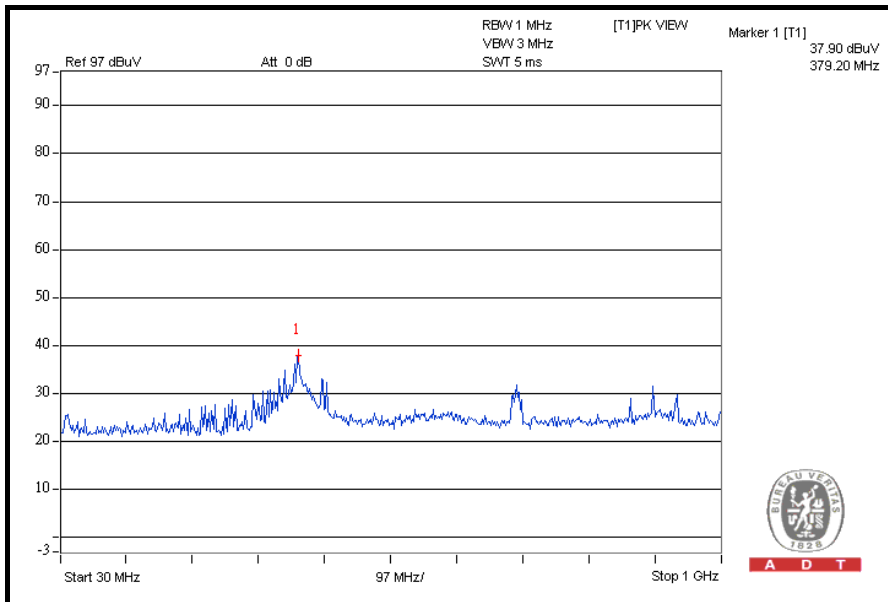



A D T

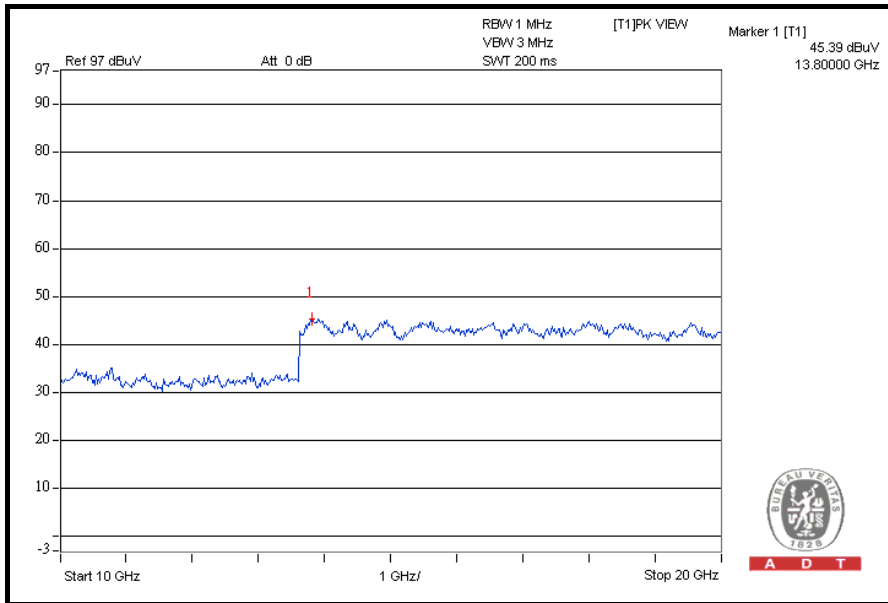

A D T

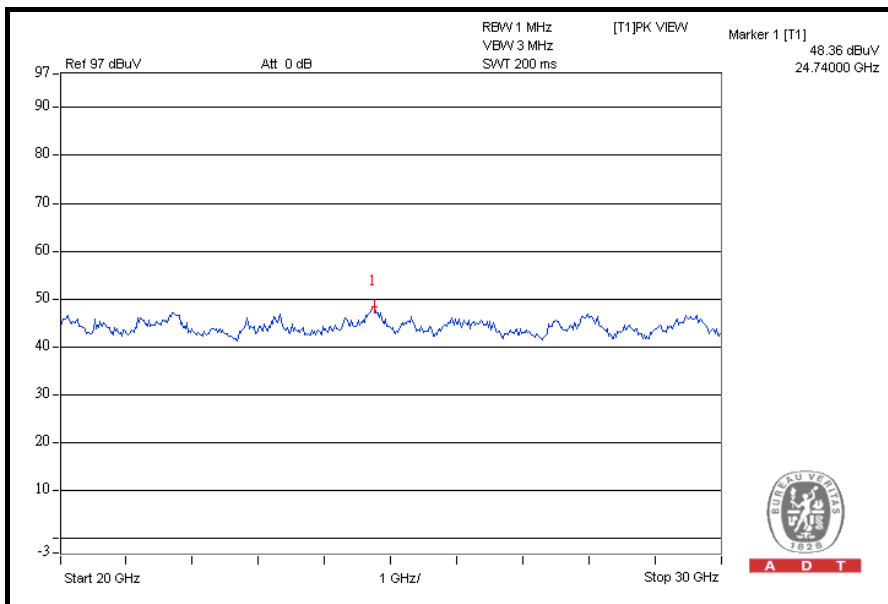

A D T



A D T

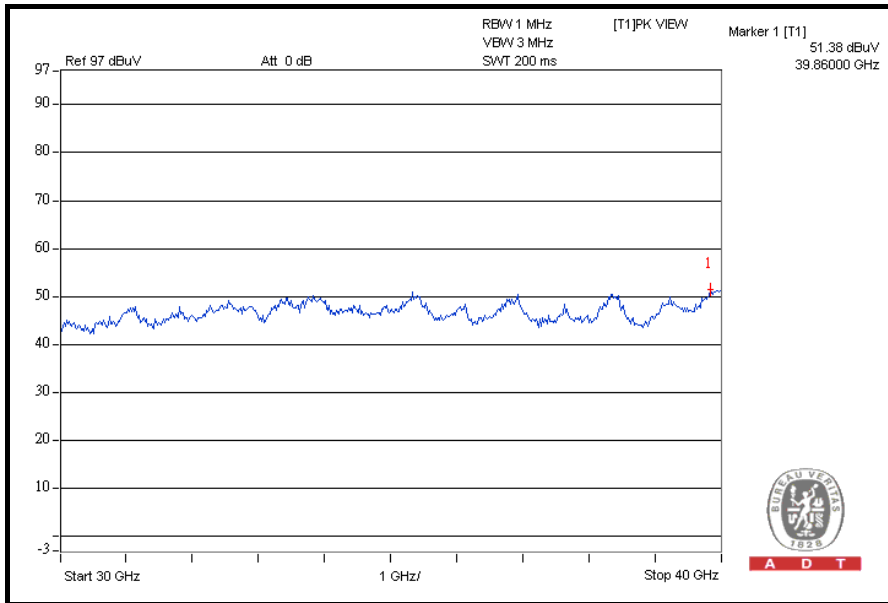



A D T

For 2.4GHz & 5.745 ~ 5.825GHz

802.11g + 802.11an (20MHz)

CH 6 + CH 165

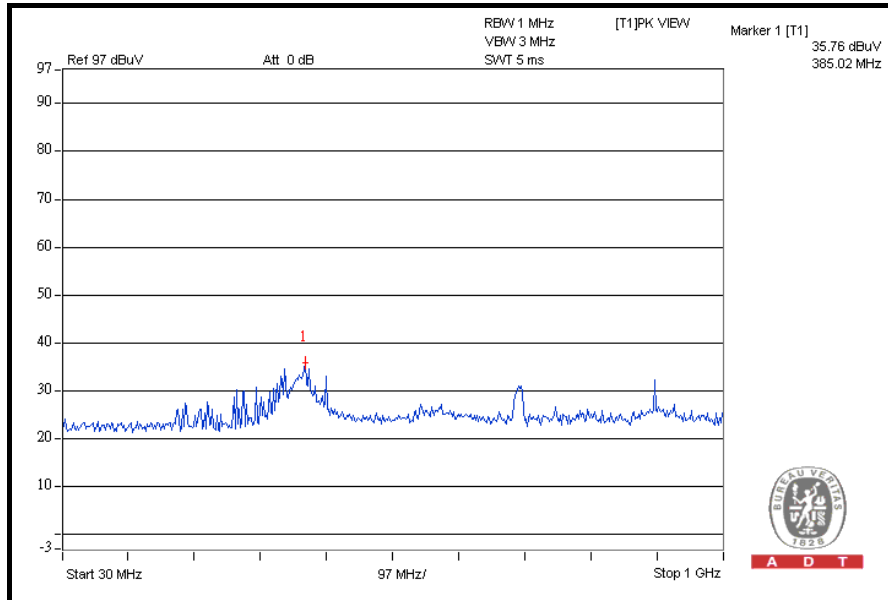

A D T

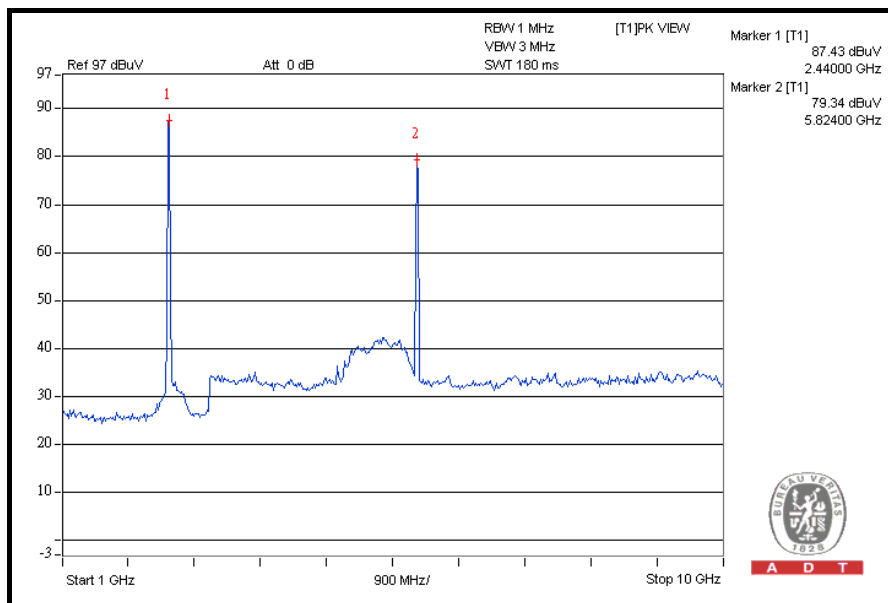

A D T



A D T

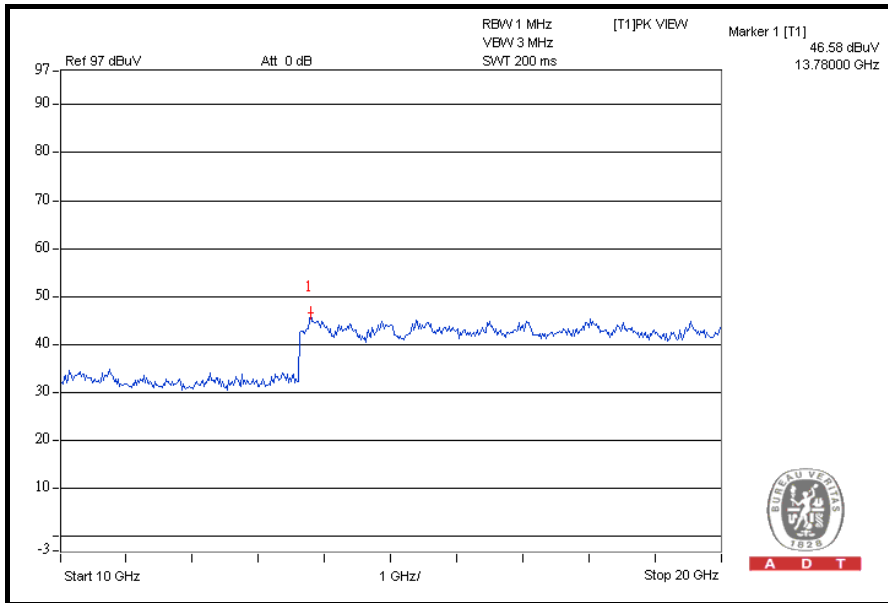

A D T

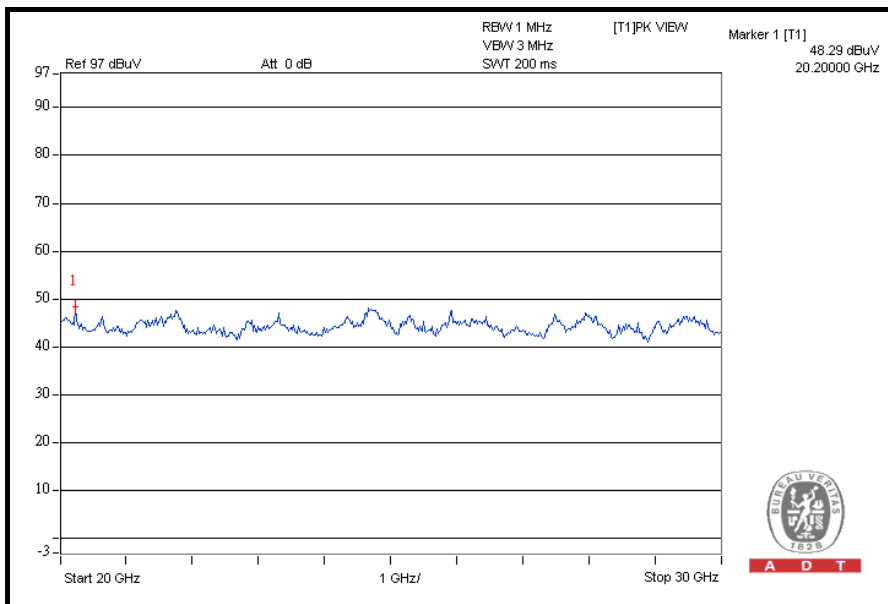

A D T



A D T

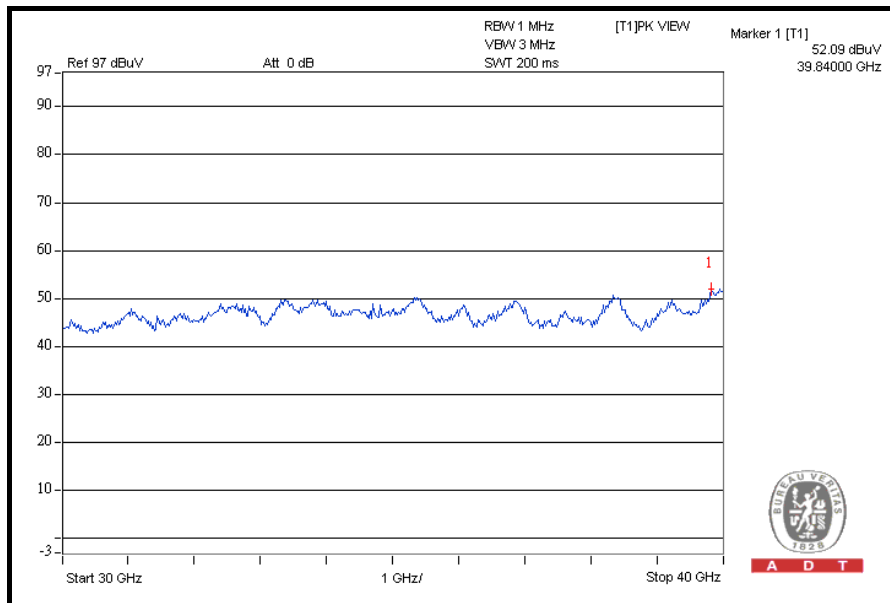



A D T

## 802.11g + 802.11an (40MHz)

### CH 6 + CH 159

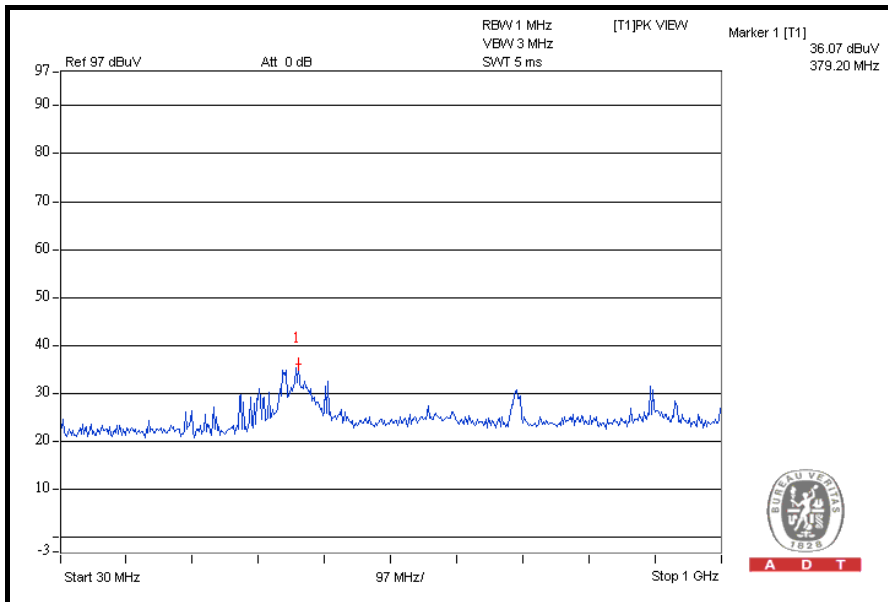

A D T

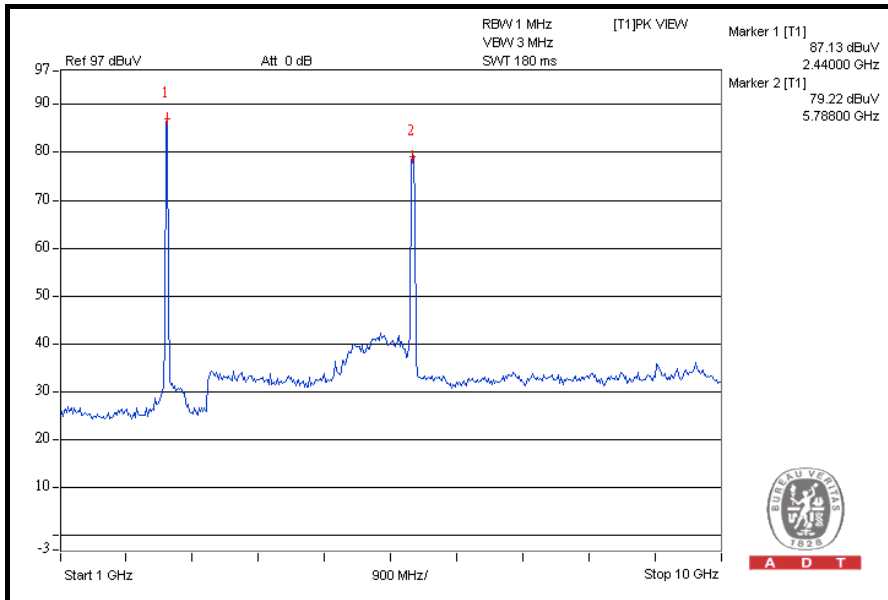

A D T



A D T

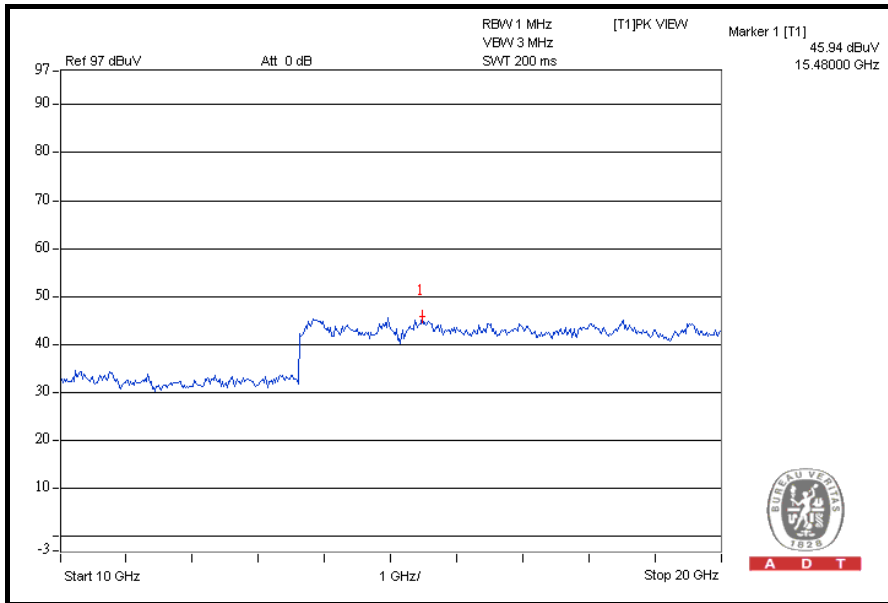

A D T

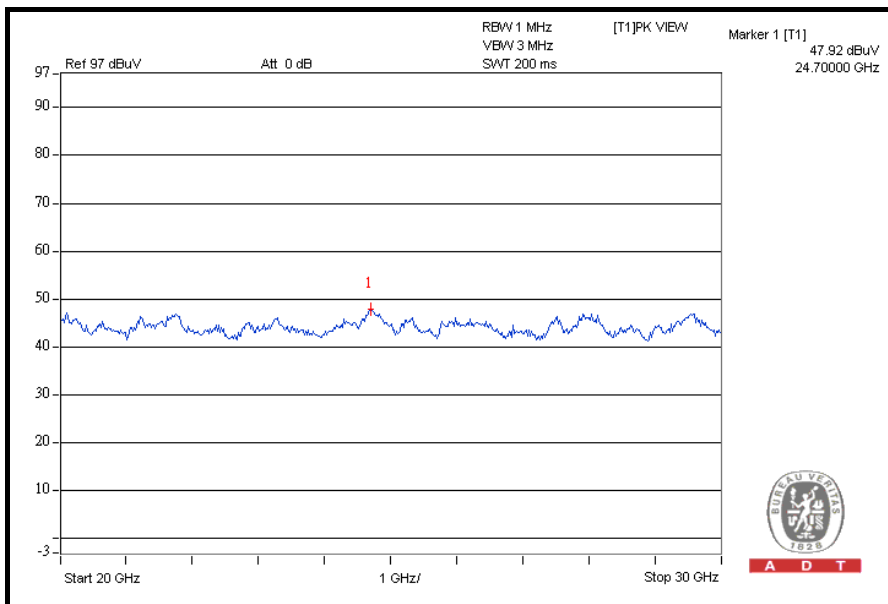

A D T







A D T

## 5. PHOTOGRAPHS OF THE TEST CONFIGURATION

Please refer to the attached file (Test Setup Photo).



## 6. INFORMATION ON THE TESTING LABORATORIES

We, Bureau Veritas Consumer Products Services (H.K.) Ltd., Taoyuan Branch, were founded in 1988 to provide our best service in EMC, Radio, Telecom and Safety consultation. Our laboratories are accredited and approved according to ISO/IEC 17025.

Copies of accreditation certificates of our laboratories obtained from approval agencies can be downloaded from our web site: [www.adt.com.tw/index.5/phtml](http://www.adt.com.tw/index.5/phtml).  
If you have any comments, please feel free to contact us at the following:

**Linko EMC/RF Lab:**

Tel: 886-2-26052180

Fax: 886-2-26051924

**Hsin Chu EMC/RF Lab:**

Tel: 886-3-5935343

Fax: 886-3-5935342

**Hwa Ya EMC/RF/Safety Telecom Lab:**

Tel: 886-3-3183232

Fax: 886-3-3185050

**Web Site:** [www.adt.com.tw](http://www.adt.com.tw)

The address and road map of all our labs can be found in our web site also.

## **7. APPENDIX A - MODIFICATIONS RECORDERS FOR ENGINEERING CHANGES TO THE EUT BY THE LAB**

No any modifications are made to the EUT by the lab during the test.

**---END---**