



FCC TEST REPORT (15.407)

REPORT NO.: RF130725E03-1

MODEL NO.: TEW-812DRU, TEW-815DAP

FCC ID: XU8TEW1750ACV2

RECEIVED: July 25, 2013

TESTED: July 26 to Aug. 09, 2013

ISSUED: Aug. 13, 2013

APPLICANT: TRENDnet, Inc.

ADDRESS: 20675 Manhattan Place, Torrance, CA
90501

ISSUED BY: Bureau Veritas Consumer Products Services
(H.K.) Ltd., Taoyuan Branch Hsin Chu Laboratory

LAB ADDRESS : No. 81-1, Lu Liao Keng, 9th Ling, Wu Lung Tsuen,
Chiung Lin Hsiang, Hsin Chu Hsien 307, Taiwan,
R.O.C.

TEST LOCATION (1): No. 81-1, Lu Liao Keng, 9th Ling, Wu Lung Tsuen,
Chiung Lin Hsiang, Hsin Chu Hsien 307, Taiwan,
R.O.C.

TEST LOCATION (2): No. 49, Ln. 206, Wende Rd., Shangshan Tsuen,
Chiung Lin Hsiang, Hsin Chu Hsien 307, Taiwan,
R.O.C.

This report should not be used by the client to claim product certification, approval, or endorsement by TAF or any government agencies.



This report is for your exclusive use. Any copying or replication of this report to or for any other person or entity, or use of our name or trademark, is permitted only with our prior written permission. This report sets forth our findings solely with respect to the test samples identified herein. The results set forth in this report are not indicative or representative of the quality or characteristics of the lot from which a test sample was taken or any similar or identical product unless specifically and expressly noted. Our report includes all of the tests requested by you and the results thereof based upon the information that you provided to us. You have 60 days from date of issuance of this report to notify us of any material error or omission caused by our negligence, provided, however, that such notice shall be in writing and shall specifically address the issue you wish to raise. A failure to raise such issue within the prescribed time shall constitute your unqualified acceptance of the completeness of this report, the tests conducted and the correctness of the report contents. Unless specific mention, the uncertainty of measurement has been explicitly taken into account to declare the compliance or non-compliance to the specification



A D T

Table of Contents

RELEASE CONTROL RECORD	4
1. CERTIFICATION	5
2. SUMMARY OF TEST RESULTS	6
2.1 MEASUREMENT UNCERTAINTY	7
3. GENERAL INFORMATION	8
3.1 GENERAL DESCRIPTION OF EUT	8
3.2 DESCRIPTION OF TEST MODES	12
3.2.1 TEST MODE APPLICABILITY AND TESTED CHANNEL DETAIL	13
3.3 GENERAL DESCRIPTION OF APPLIED STANDARDS	15
3.4 DUTY CYCLE OF TEST SIGNAL	16
3.5 DESCRIPTION OF SUPPORT UNITS.....	17
3.6 CONFIGURATION OF SYSTEM UNDER TEST	18
4. TEST TYPES AND RESULTS	20
4.1 CONDUCTED EMISSION MEASUREMENT	20
4.1.1 LIMITS OF CONDUCTED EMISSION MEASUREMENT	20
4.1.2 TEST INSTRUMENTS.....	20
4.1.3 TEST PROCEDURES	21
4.1.4 DEVIATION FROM TEST STANDARD	21
4.1.5 TEST SETUP	21
4.1.6 EUT OPERATING CONDITIONS	22
4.1.7 TEST RESULTS (MODE 1)	23
4.1.8 TEST RESULTS (MODE 2)	25
4.1.9 TEST RESULTS (MODE 3)	27
4.1.10 TEST RESULTS (MODE 4)	29
4.2 RADIATED EMISSION AND BANDEDGE MEASUREMENT	31
4.2.1 LIMITS OF RADIATED EMISSION AND BANDEDGE MEASUREMENT.....	31
4.2.2 LIMITS OF UNWANTED EMISSION OUT OF THE RESTRICTED BANDS.....	31
4.2.3 TEST INSTRUMENTS.....	32
4.2.4 TEST PROCEDURES	34
4.2.5 DEVIATION FROM TEST STANDARD	34
4.2.6 TEST SETUP	35
4.2.7 EUT OPERATING CONDITION.....	35
4.2.8 TEST RESULTS	36
4.3 TRANSMIT POWER MEASUREMENT	47
4.3.1 LIMITS OF TRANSMIT POWER MEASUREMENT	47
4.3.2 TEST INSTRUMENTS.....	47
4.3.3 TEST PROCEDURE.....	48
4.3.4 DEVIATION FROM TEST STANDARD	48



A D T

4.3.5	TEST SETUP	49
4.3.6	EUT OPERATING CONDITIONS	49
4.3.7	TEST RESULTS	50
4.4	PEAK POWER SPECTRAL DENSITY MEASUREMENT	54
4.4.1	LIMITS OF PEAK POWER SPECTRAL DENSITY MEASUREMENT	54
4.4.2	TEST INSTRUMENTS.....	54
4.4.3	TEST PROCEDURES	54
4.4.4	DEVIATION FROM TEST STANDARD	54
4.4.5	TEST SETUP	55
4.4.6	EUT OPERATING CONDITIONS	55
4.4.7	TEST RESULTS	56
4.5	PEAK POWER EXCURSION MEASUREMENT	58
4.5.1	LIMITS OF PEAK POWER EXCURSION MEASUREMENT	58
4.5.2	TEST INSTRUMENTS.....	58
4.5.3	TEST PROCEDURE.....	58
4.5.4	DEVIATION FROM TEST STANDARD	58
4.5.5	TEST SETUP	58
4.5.6	EUT OPERATING CONDITIONS	58
4.5.7	TEST RESULTS	59
4.6	FREQUENCY STABILITY.....	60
4.6.1	LIMITS OF FREQUENCY STABILITY MEASUREMENT	60
4.6.2	TEST INSTRUMENTS.....	60
4.6.3	TEST PROCEDURE.....	60
4.6.4	DEVIATION FROM TEST STANDARD	61
4.6.5	TEST SETUP	61
4.6.6	EUT OPERATING CONDITION.....	61
4.6.7	TEST RESULTS	62
5.	PHOTOGRAPHS OF THE TEST CONFIGURATION.....	63
6.	INFORMATION ON THE TESTING LABORATORIES	64
7.	APPENDIX A - MODIFICATIONS RECORDERS FOR ENGINEERING CHANGES TO THE EUT BY THE LAB.....	65



A D T

RELEASE CONTROL RECORD

ISSUE NO.	REASON FOR CHANGE	DATE ISSUED
RF130725E03-1	Original release	Aug. 13, 2013



A D T

1. CERTIFICATION

PRODUCT: AC1750 Dual Band Wireless Router, AC1750 Dual Band Wireless Access Point

BRAND NAME: TRENDnet

MODEL NO.: TEW-812DRU, TEW-815DAP

TEST SAMPLE: ENGINEERING SAMPLE

APPLICANT: TRENDnet, Inc.

TESTED: July 26 to Aug. 09, 2013

STANDARDS: FCC Part 15, Subpart E (Section 15.407)
ANSI C63.10-2009

The above equipment (Model: TEW-812DRU, TEW-815DAP) have been tested by **Bureau Veritas Consumer Products Services (H.K.) Ltd., Taoyuan Branch**, and found compliance with the requirement of the above standards. The test record, data evaluation & Equipment Under Test (EUT) configurations represented herein are true and accurate accounts of the measurements of the sample's EMC characteristics under the conditions specified in this report.

PREPARED BY : Phoenix Huang , **DATE:** Aug. 13, 2013
(Phoenix Huang, Specialist)

APPROVED BY : May Chen , **DATE:** Aug. 13, 2013
(May Chen, Manager)



A D T

2. SUMMARY OF TEST RESULTS

The EUT has been tested according to the following specifications:

For 5GHz, 5150~5250MHz

APPLIED STANDARD: FCC PART 15, SUBPART E (SECTION 15.407)			
STANDARD SECTION	TEST TYPE	RESULT	REMARK
15.407(b)(6)	AC Power Conducted Emission	PASS	Meet the requirement of limit. Minimum passing margin is -8.63dB at 0.48984MHz
15.407(b/1/2/3) (b)(5)	Spurious Emissions	PASS	Meet the requirement of limit. Minimum passing margin is -0.2dB at 5020.00MHz, 5070.00MHz & 5080.00MHz
15.407(a/1/2/3)	Transmit Power	PASS	Meet the requirement of limit.
15.407(a)(6)	Peak Power Excursion	PASS	Meet the requirement of limit.
15.407(a/1/2/3)	Peak Power Spectral Density	PASS	Meet the requirement of limit.
15.407(g)	Frequency Stability	PASS	Meet the requirement of limit.
15.203	Antenna Requirement	PASS	Antenna connector is I-PEX not a standard connector.

NOTE: The EUT was operating in 2.400 ~ 2.4835GHz, 5.15~5.25GHz and 5.725~5.850GHz frequencies band. This report was recorded the RF parameters including 5.15~5.25GHz. For the 2.400 ~ 2.4835GHz and 5.725~5.850GHz RF parameters was recorded in another test report.



A D T

2.1 MEASUREMENT UNCERTAINTY

Where relevant, the following measurement uncertainty levels have been estimated for tests performed on the EUT as specified in CISPR 16-4-2:

This uncertainty represents an expanded uncertainty expressed at approximately the 95% confidence level using a coverage factor of $k=2$.

Measurement	Value
Conducted emissions	2.98 dB
Radiated emissions (30MHz-1GHz)	5.46 dB
Radiated emissions (1GHz -6GHz)	3.73 dB
Radiated emissions (6GHz -18GHz)	3.90 dB
Radiated emissions (18GHz -40GHz)	4.11 dB



A D T

3. GENERAL INFORMATION

3.1 GENERAL DESCRIPTION OF EUT

PRODUCT	AC1750 Dual Band Wireless Router, AC1750 Dual Band Wireless Access Point
MODEL NO.	TEW-812DRU, TEW-815DAP
POWER SUPPLY	DC 12V from power adapter
MODULATION TYPE	CCK, DQPSK, DBPSK for DSSS 64QAM, 16QAM, QPSK, BPSK for OFDM 256QAM for OFDM in 11ac mode only.
MODULATION TECHNOLOGY	DSSS,OFDM
TRANSFER RATE	802.11b: up to 11Mbps 802.11a / g: up to 54Mbps 802.11n: up to 450Mbps 802.11ac: up to 1300Mbps
OPERATING FREQUENCY	For 15.407 5GHz: 5.18 ~ 5.24GHz For 15.247 2.4GHz: 2.412 ~ 2.462GHz 5GHz: 5.745 ~ 5.825GHz
NUMBER OF CHANNEL	For 15.407 4 for 802.11a, 802.11n (HT20), 802.11ac (VHT20) 2 for 802.11n (HT40), 802.11ac (VHT40) 1 for 802.11ac (VHT80) For 15.247 (2.4GHz) 11 for 802.11b, 802.11g, 802.11n (HT20) 7 for 802.11n (HT40) For 15.247 (5GHz) 5 for 802.11a, 802.11n (HT20), 802.11ac (VHT20) 2 for 802.11n (HT40), 802.11ac (VHT40) 1 for 802.11ac (VHT80)

MAXIMUM OUTPUT POWER	For 15.407
	802.11a: 26.424mW
	802.11n (HT20): 24.699mW
	802.11n (HT40): 24.049mW
	802.11ac (VHT80): 21.326mW
	For 15.247 (2.4GHz)
	802.11b: 116.681mW
	802.11g: 402.717mW
	802.11n (HT20): 968.597mW
	802.11n (HT40): 155.250mW
ANTENNA TYPE	For 15.247 (5GHz)
	802.11a: 227.510mW
	802.11n (HT20): 439.897mW
	802.11n (HT40): 705.163mW
	802.11ac (VHT80): 283.146mW
ANTENNA TYPE	Please see NOTE
DATA CABLE	RJ-45 Cable (unshielded, 1.5m) x1
I/O PORTS	Refer to user's manual
ASSOCIATED DEVICES	Adapter x1

NOTE:

1. The EUT is a 2.4GHz & 5GHz WLAN device.
2. The EUT has two product names and model names, which are identical to each other in all aspects except for the following table:

Product	Brand	Model No.	Difference
AC1750 Dual Band Wireless Router	TRENDnet	TEW-812DRU	LAN x 4 WAN x 1 USB x 1 DC-JACK x 1
AC1750 Dual Band Wireless Access Point	TRENDnet	TEW-815DAP	LAN x 1 DC-JACK x 1

From the above models, the worst case was found in model: **TEW-812DRU** and was selected as representative model for the test (except for AC Power Conducted Emission)and its data was recorded in this report.



A D T

3. The EUT must be supplied with a power adapter and following two different models could be chosen as following table:

No	Brand	Model No.	Spec.	Plug
1	HON-KWANG	HK-AX-120A200-US	Input: 100-240V, 0.8A, 50/60Hz Output: 12V, 2A DC output cable (Unshielded, 1.5m)	US
2	Ktec	KSASB0241200200HU	Input: 100-240V, 0.6A, 50/60Hz Output: 12V, 2A DC output cable (Unshielded, 1.5m)	US

1. For radiated emissions test, the EUT was pre-tested with above adapters 1 & 2, the worst case was found in adapter 1. Therefore only the test data of the adapter was recorded in this report.

4. The antenna provided to the EUT, please refer to the following table:

For 2.4GHz					
Transmitter Circuit	Antenna Type	Peak Gain(dBi) (Include cable loss)	Connector Type	Frequency range (MHz to MHz)	Cable Length (mm)
Chain (0)	Dipole	2.5	i-pex	2400~2500	78
Chain (1)	Dipole	6	i-pex	2400~2500	90
Chain (2)	Dipole	5.5	i-pex	2400~2500	185

For 5GHz (Band 1)					
Transmitter Circuit	Antenna Type	Peak Gain(dBi) (Include cable loss)	Connector Type	Frequency range (MHz to MHz)	Cable Length (mm)
Chain (0)	Dipole	4.8	i-pex	5150~5825	78
Chain (1)	Dipole	6	i-pex	5150~5825	90
Chain (2)	Dipole	6	i-pex	5150~5825	185

Note:

1. For 802.11b mode will fix transmission on Chain (0).
2. For 802.11g, the worst case was found in Chain (1) Therefore only the test data of the mode was recorded in this report.
3. For 802.11a, the worst case was found in Chain (1) Therefore only the test data of the mode was recorded in this report.

5. The EUT incorporates a MIMO function without beam forming.

MODULATION MODE	TX/RX FUNCTION
802.11b	1TX/3RX
802.11g	1TX (Diversity)/3RX
802.11n (HT20) <2.4GHz>	3TX/3RX
802.11n (HT40) <2.4GHz>	3TX/3RX
802.11a	1TX (Diversity)/3Rx
802.11n (HT20) <5GHz>	3TX/3RX
802.11n (HT40) <5GHz>	3TX/3RX
802.11ac (VHT20)	3TX/3RX
802.11ac (VHT40)	3TX/3RX
802.11ac (VHT80)	3TX/3RX

Note: The modulation and bandwidth are similar for 802.11n mode for 20MHz (40MHz) and 802.11ac mode for 20MHz (40MHz), therefore investigated worst case to representative mode in test report. (Final test mode refer section 3.2.1)

6. The emission of the simultaneous operation (2.4GHz & 5GHz) has been evaluated and no non-compliance was found.
7. When the EUT operating in 802.11n, the software operation, which is defined by manufacturer, MCS (Modulation and Coding Schemes) from 0 to 23.
8. When the EUT operating in 802.11ac, the software operation, which is defined by manufacturer, MCS (Modulation and Coding Schemes) from 0 to 9.
9. The above EUT information was declared by the manufacturer and for more detailed features description, please refer to the manufacturer's specifications or User's Manual.



A D T

3.2 DESCRIPTION OF TEST MODES

Operated in 5150 ~ 5250MHz band:

4 channels are provided for 802.11a, 802.11n (HT20), 802.11ac (VHT20):

CHANNEL	FREQUENCY	CHANNEL	FREQUENCY
36	5180 MHz	44	5220 MHz
40	5200 MHz	48	5240 MHz

2 channels are provided for 802.11n (HT40), 802.11ac (VHT40):

CHANNEL	FREQUENCY
38	5190 MHz
46	5230 MHz

1 channel is provided for 802.11ac (VHT80):

CHANNEL	FREQUENCY
42	5210 MHz



A D T

3.2.1 TEST MODE APPLICABILITY AND TESTED CHANNEL DETAIL

EUT CONFIGURE MODE	APPLICABLE TO				DESCRIPTION
	PLC	RE < 1G	RE ≥ 1G	APCM	
1	√	√	√	√	Model No.: TEW-812DRU with adapter 1
2	√	-	-	-	Model No.: TEW-812DRU with adapter 2
3	√	-	-	-	Model No.: TEW-815DAP with adapter 1
4	√	-	-	-	Model No.: TEW-815DAP with adapter 2

Where **PLC**: Power Line Conducted Emission **RE < 1G**: Radiated Emission below 1GHz
RE ≥ 1G: Radiated Emission above 1GHz **APCM**: Antenna Port Conducted Measurement

POWER LINE CONDUCTED EMISSION TEST:

- Pre-Scan has been conducted to determine the worst-case mode from all possible combinations between available modulations, data rates and antenna ports (if EUT with antenna diversity architecture).
- Following channel(s) was (were) selected for the final test as listed below.

MODE	AVAILABLE CHANNEL	TESTED CHANNEL	MODULATION TECHNOLOGY	MODULATION TYPE	DATA RATE (MBPS)
802.11a	36 to 48	36	OFDM	BPSK	6

RADIATED EMISSION TEST (BELOW 1 GHz):

- Pre-Scan has been conducted to determine the worst-case mode from all possible combinations between available modulations, data rates and antenna ports (if EUT with antenna diversity architecture).
- Following channel(s) was (were) selected for the final test as listed below.

MODE	AVAILABLE CHANNEL	TESTED CHANNEL	MODULATION TECHNOLOGY	MODULATION TYPE	DATA RATE (Mbps)
802.11a	36 to 48	36	OFDM	BPSK	6



A D T

RADIATED EMISSION TEST (ABOVE 1 GHz):

- Pre-Scan has been conducted to determine the worst-case mode from all possible combinations between available modulations, data rates and antenna ports (if EUT with antenna diversity architecture).
- Following channel(s) was (were) selected for the final test as listed below.

MODE	AVAILABLE CHANNEL	TESTED CHANNEL	MODULATION TECHNOLOGY	MODULATION TYPE	DATA RATE (Mbps)
802.11a	36 to 48	36, 40, 48	OFDM	BPSK	6
802.11n (HT20)	36 to 48	36, 40, 48	OFDM	BPSK	6.5
802.11n (HT40)	38 to 46	38, 46	OFDM	BPSK	13.5
802.11ac (VHT80)	42	42	OFDM	BPSK	29.3

ANTENNA PORT CONDUCTED MEASUREMENT:

- Pre-Scan has been conducted to determine the worst-case mode from all possible combinations between available modulations, data rates and antenna ports (if EUT with antenna diversity architecture).
- Following channel(s) was (were) selected for the final test as listed below.

MODE	AVAILABLE CHANNEL	TESTED CHANNEL	MODULATION TECHNOLOGY	MODULATION TYPE	DATA RATE (Mbps)
802.11a	36 to 48	36, 40, 48	OFDM	BPSK	6
802.11n (HT20)	36 to 48	36, 40, 48	OFDM	BPSK	6.5
802.11n (HT40)	38 to 46	38, 46	OFDM	BPSK	13.5
802.11ac (VHT80)	42	42	OFDM	BPSK	29.3

TEST CONDITION:

APPLICABLE TO	ENVIRONMENTAL CONDITIONS	INPUT POWER	TESTED BY
PLC	26deg. C, 66%RH	120Vac, 60Hz	JyunChun Lin
	25deg. C, 58%RH	120Vac, 60Hz	Scott Chen
RE<1G	25deg. C, 70%RH	120Vac, 60Hz	Andy Ho
RE ³ 1G	30deg. C, 70%RH	120Vac, 60Hz	Chilin Lee
APCM	25deg. C, 60%RH	120Vac, 60Hz	Robert Cheng

3.3 GENERAL DESCRIPTION OF APPLIED STANDARDS

The EUT is a RF product. According to the specifications of the manufacturer, it must comply with the requirements of the following standards:

FCC Part 15, Subpart E (15.407)

789033 D01 General UNII Test Procedures v01 r03

662911 D01 Multiple Transmitter Output v01 r02

ANSI C63.10-2009

All test items have been performed and recorded as per the above standards.

Note: The EUT has been verified to comply with the requirements of FCC Part 15, Subpart B, Class B (DoC). The test report has been issued separately.

3.4 DUTY CYCLE OF TEST SIGNAL

If duty cycle of test signal is > 98 %, duty factor is not required.

If duty cycle of test signal is < 98%, duty factor shall be considered.

802.11a: Duty cycle = 2.056 ms/2.076 ms = 0.99

802.11n (HT20): Duty cycle = 1.915 ms/1.941 ms = 0.987

802.11n (HT40): Duty cycle = 0.937 ms/0.964 ms = 0.972, Duty factor = $10 * \log(1/0.972) = 0.12$

802.11ac (VHT80): Duty cycle = 0.46 ms/0.477 ms = 0.964, Duty factor = $10 * \log(1/0.964) = 0.16$

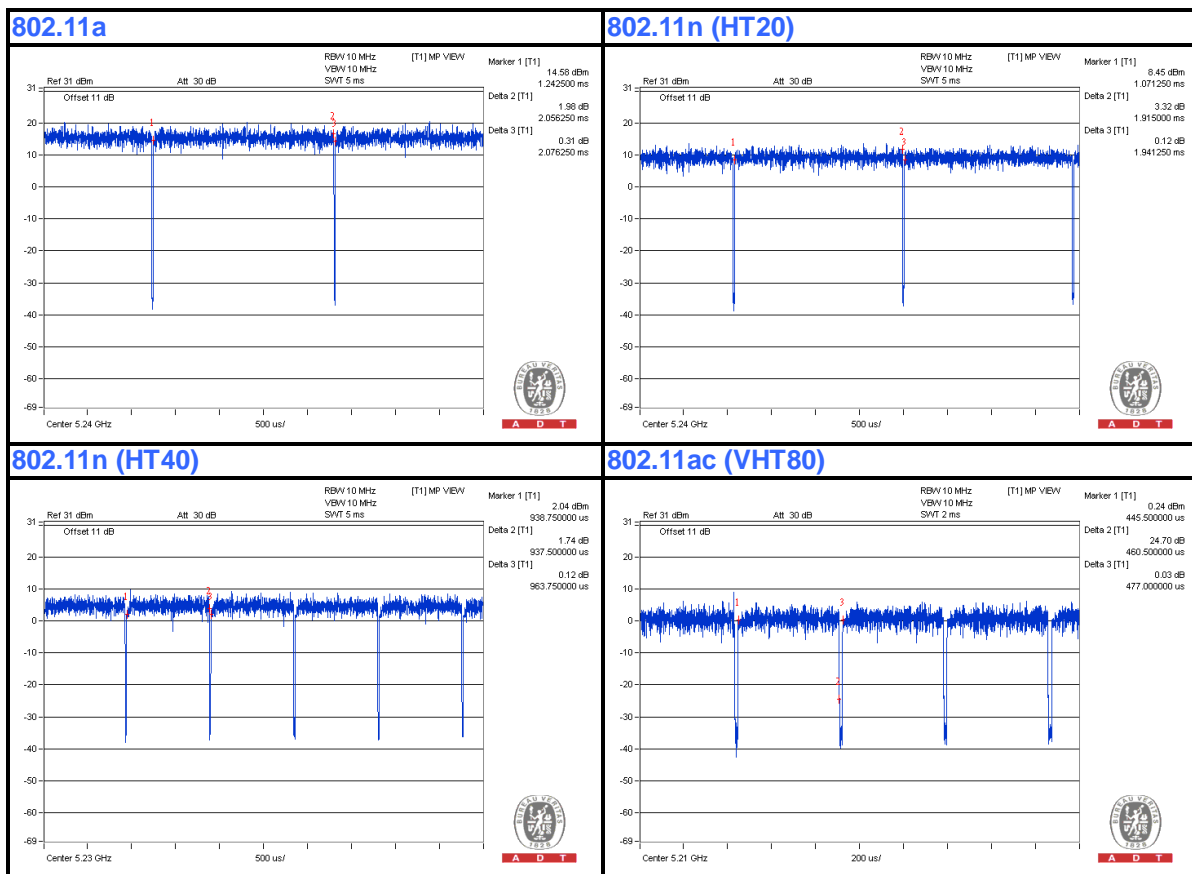



A D T

3.5 DESCRIPTION OF SUPPORT UNITS

The EUT has been tested as an independent unit together with other necessary accessories or support units. The following support units or accessories were used to form a representative test configuration during the tests.

NO.	PRODUCT	BRAND	MODEL NO.	SERIAL NO.	FCC ID
1	NOTEBOOK COMPUTER	DELL	PP32LA	FSLB32S	FCC DoC
2	NOTEBOOK COMPUTER	DELL	PP32LA	GSLB32S	FCC DoC
3	External Hard Drive	WD	WDBACW0010H BK-SESN	WXK1A51E5819	FCC DoC
4	HUB	ZyXEL	ES-116P	S060H02000215	FCC DoC

NO.	SIGNAL CABLE DESCRIPTION OF THE ABOVE SUPPORT UNITS
1	UTP Cable, 10m
2	UTP Cable, 10m
3	USB Cable, 0.6m
4	UTP Cable, 10m

NOTE: All power cords of the above support units are non shielded (1.8m).

3.6 CONFIGURATION OF SYSTEM UNDER TEST

For Conducted Emission (Mode 1~2) / Radiated Emission test:

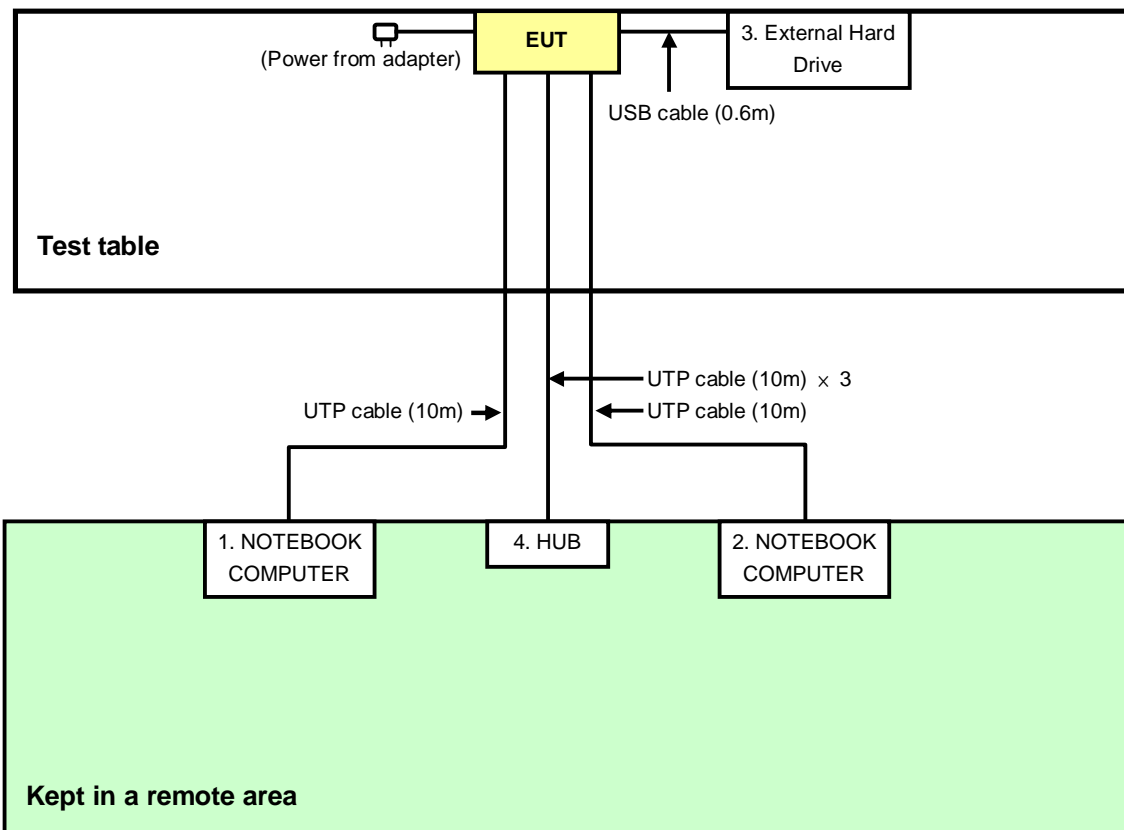

For Conducted Emission (Mode 3~4) test:

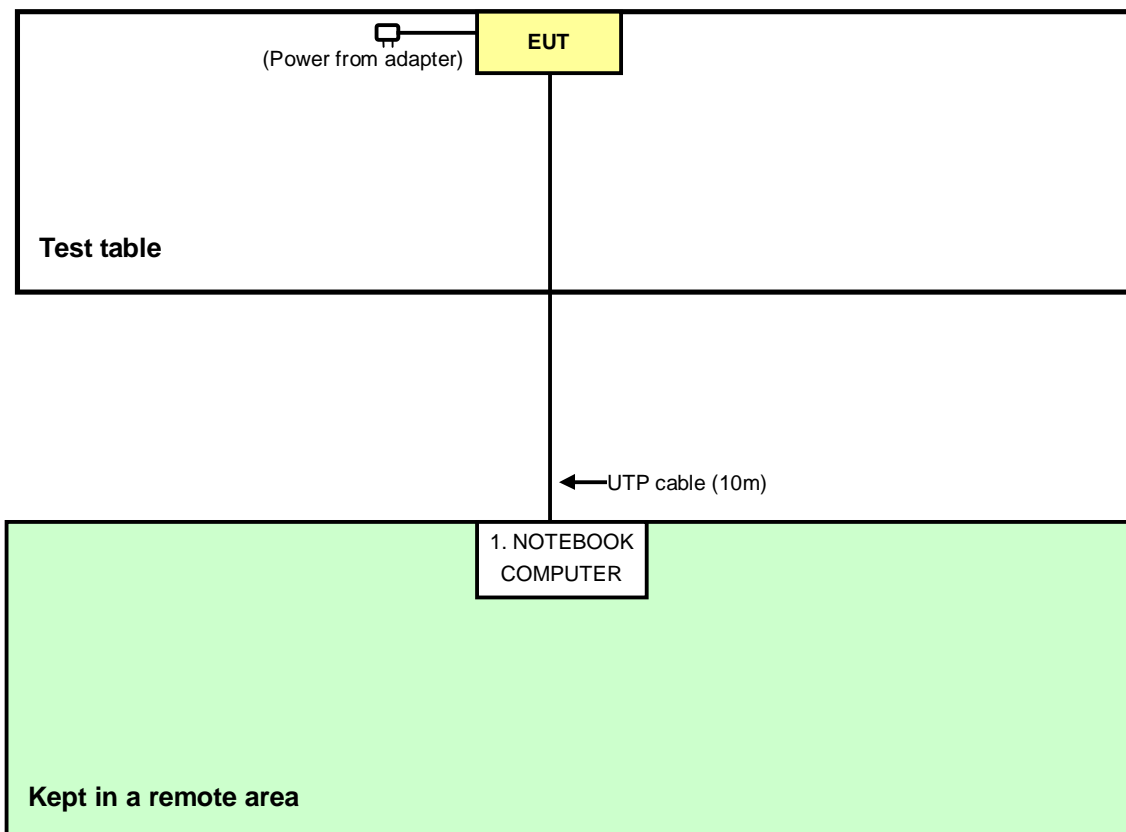

4. TEST TYPES AND RESULTS

4.1 CONDUCTED EMISSION MEASUREMENT

4.1.1 LIMITS OF CONDUCTED EMISSION MEASUREMENT

FREQUENCY OF EMISSION (MHz)	CONDUCTED LIMIT (dB μ V)	
	Quasi-peak	Average
0.15-0.5	66 to 56	56 to 46
0.5-5	56	46
5-30	60	50

- NOTE:**
1. The lower limit shall apply at the transition frequencies.
 2. The limit decreases in line with the logarithm of the frequency in the range of 0.15 to 0.50 MHz.

4.1.2 TEST INSTRUMENTS

DESCRIPTION & MANUFACTURER	MODEL NO.	SERIAL NO.	CALIBRATED DATE	CALIBRATED UNTIL
Test Receiver	ESCS 30	100375	Mar. 08, 2013	Mar. 07, 2014
Line-Impedance Stabilization Network (for EUT) SCHWARZBECK	NSLK8127	8127-522	Sep. 06, 2012	Sep. 05, 2013
Line-Impedance Stabilization Network (for Peripheral)	ENV216	100072	June 07, 2013	June 06, 2014
RF Cable (JYEBAO)	5DFB	COCCAB-001	Mar. 11, 2013	Mar. 10, 2014
50 ohms Terminator	50	EMC-3	Sep. 25, 2012	Sep. 24, 2013
Software ADT	BV ADT_Cond_V7.3.7.3	NA	NA	NA

Note:

1. The calibration interval of the above test instruments is 12 months and the calibrations are traceable to NML/ROC and NIST/USA.
2. The test was performed in Shielded Room No. C.
- 3 The VCCI Con C Registration No. is C-3611.
- 4 Tested Date: July 29 and Aug. 07, 2013

4.1.3 TEST PROCEDURES

- a. The EUT was placed 0.4 meters from the conducting wall of the shielded room with EUT being connected to the power mains through a line impedance stabilization network (LISN). Other support units were connected to the power mains through another LISN.
- b. The two LISNs provide 50 ohm/ 50uH of coupling impedance for the measuring instrument.
- c. Both lines of the power mains connected to the EUT were checked for maximum conducted interference.
- d. The frequency range from 150kHz to 30MHz was searched. Emission level under (Limit – 20dB) was not recorded.

NOTE:

1. The resolution bandwidth of test receiver is 9kHz for Quasi-peak detection (QP) & Average detection (AV).

4.1.4 DEVIATION FROM TEST STANDARD

No deviation

4.1.5 TEST SETUP

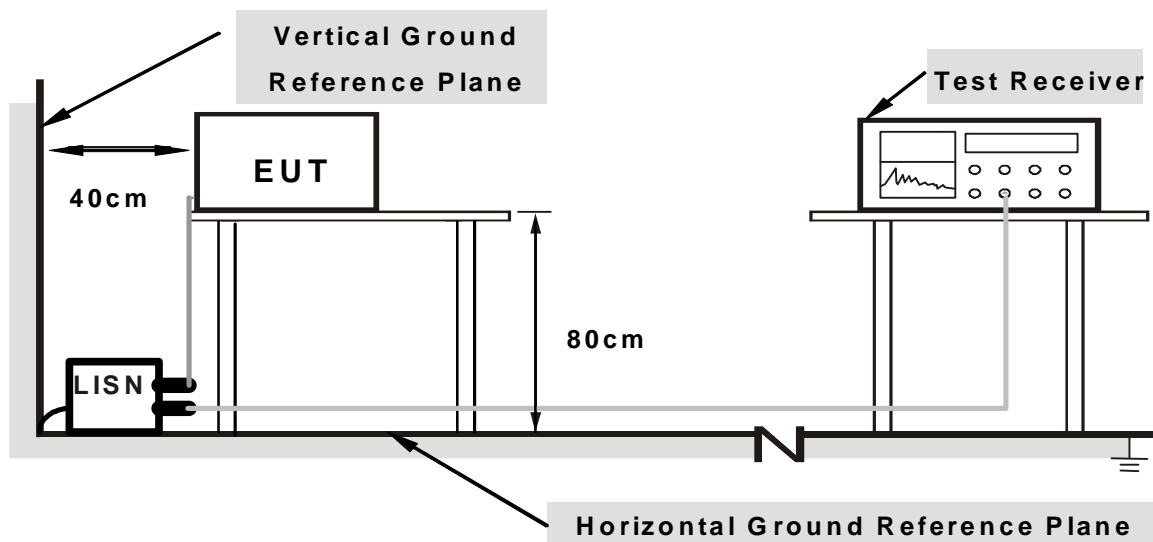

Note: 1.Support units were connected to second LISN.

For the actual test configuration, please refer to the related item – Photographs of the Test Configuration.

4.1.6 EUT OPERATING CONDITIONS

1. Turn on the power of EUT.
2. The communication partner run test program “Mtool 1.0.0.9.exe” to enable EUT under transmission/receiving condition continuously at specific channel frequency.

4.1.7 TEST RESULTS (MODE 1)

PHASE	Line (L)	DETECTOR FUNCTION	Quasi-Peak (QP) / Average (AV)
--------------	----------	--------------------------	--------------------------------

No	Freq. [MHz]	Corr. Factor (dB)	Reading Value [dB (uV)]		Emission Level [dB (uV)]		Limit [dB (uV)]		Margin (dB)	
			Q.P.	AV.	Q.P.	AV.	Q.P.	AV.	Q.P.	AV.
1	0.15391	0.13	50.22	32.01	50.35	32.14	65.79	55.79	-15.43	-23.64
2	0.41563	0.20	39.63	30.16	39.83	30.36	57.54	47.54	-17.70	-17.17
3	0.48984	0.21	45.46	37.33	45.67	37.54	56.17	46.17	-10.50	-8.63
4	0.67344	0.22	40.00	32.89	40.22	33.11	56.00	46.00	-15.78	-12.89
5	0.87656	0.24	40.14	33.17	40.38	33.41	56.00	46.00	-15.62	-12.59
6	1.38281	0.28	37.78	30.47	38.06	30.75	56.00	46.00	-17.94	-15.25

REMARKS:

1. Q.P. and AV. are abbreviations of quasi-peak and average individually.
2. The emission levels of other frequencies were very low against the limit.
3. Margin value = Emission Level – Limit value
4. Correction Factor = Insertion loss + Cable loss
5. Emission Level = Correction Factor + Reading Value

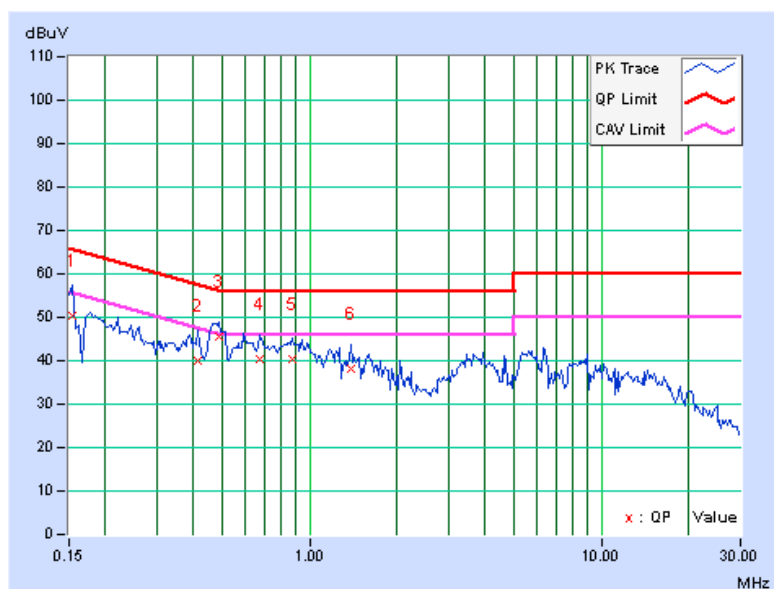

PHASE	Neutral (N)	DETECTOR FUNCTION	Quasi-Peak (QP) / Average (AV)
--------------	-------------	--------------------------	--------------------------------

No	Freq.	Corr.	Reading Value		Emission Level		Limit		Margin	
	[MHz]	Factor (dB)	Q.P. [dB (uV)]	AV. [dB (uV)]	Q.P. [dB (uV)]	AV. [dB (uV)]	Q.P. [dB (uV)]	AV. [dB (uV)]	Q.P. (dB)	AV. (dB)
	1	0.15000	0.11	53.54	38.59	53.65	38.70	66.00	56.00	-12.35
2	0.18516	0.12	47.66	39.19	47.78	39.31	64.25	54.25	-16.47	-14.94
3	0.46250	0.19	39.86	31.14	40.05	31.33	56.65	46.65	-16.59	-15.31
4	0.54453	0.20	39.59	31.40	39.79	31.60	56.00	46.00	-16.21	-14.40
5	2.57813	0.34	35.19	28.32	35.53	28.66	56.00	46.00	-20.47	-17.34
6	14.64844	0.94	38.29	32.93	39.23	33.87	60.00	50.00	-20.77	-16.13

REMARKS:

1. Q.P. and AV. are abbreviations of quasi-peak and average individually.
2. The emission levels of other frequencies were very low against the limit.
3. Margin value = Emission Level – Limit value
4. Correction Factor = Insertion loss + Cable loss
5. Emission Level = Correction Factor + Reading Value

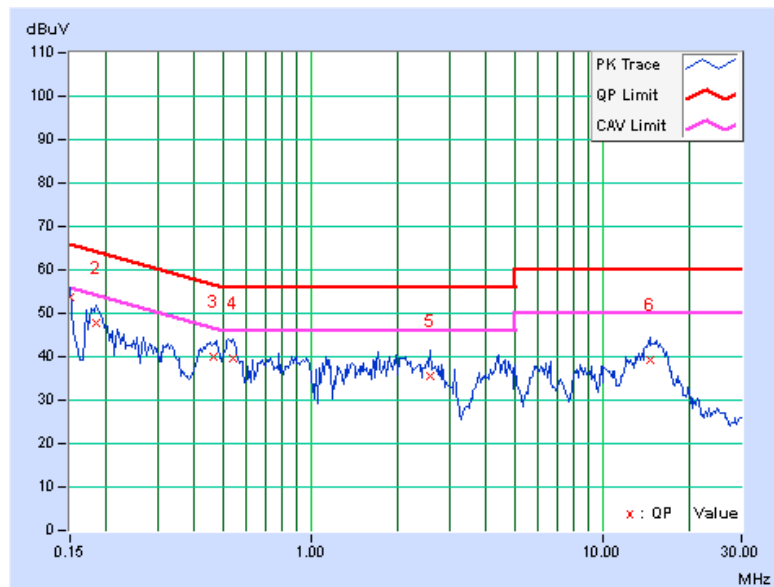

4.1.8 TEST RESULTS (MODE 2)

PHASE	Line (L)	DETECTOR FUNCTION	Quasi-Peak (QP) / Average (AV)
--------------	----------	--------------------------	--------------------------------

No	Freq. [MHz]	Corr. Factor [dB]	Reading Value [dB (uV)]		Emission Level [dB (uV)]		Limit [dB (uV)]		Margin (dB)	
			Q.P.	AV.	Q.P.	AV.	Q.P.	AV.	Q.P.	AV.
1	0.15000	0.13	56.13	46.02	56.26	46.15	66.00	56.00	-9.74	-9.85
2	0.19687	0.15	49.81	39.25	49.96	39.40	63.74	53.74	-13.78	-14.34
3	0.26719	0.17	43.44	23.99	43.61	24.16	61.20	51.20	-17.60	-27.05
4	0.49766	0.21	35.21	21.83	35.42	22.04	56.04	46.04	-20.62	-24.00
5	3.64844	0.45	29.15	21.17	29.60	21.62	56.00	46.00	-26.40	-24.38
6	16.75391	1.29	33.12	25.89	34.41	27.18	60.00	50.00	-25.59	-22.82

REMARKS:

1. Q.P. and AV. are abbreviations of quasi-peak and average individually.
2. The emission levels of other frequencies were very low against the limit.
3. Margin value = Emission Level – Limit value
4. Correction Factor = Insertion loss + Cable loss
5. Emission Level = Correction Factor + Reading Value

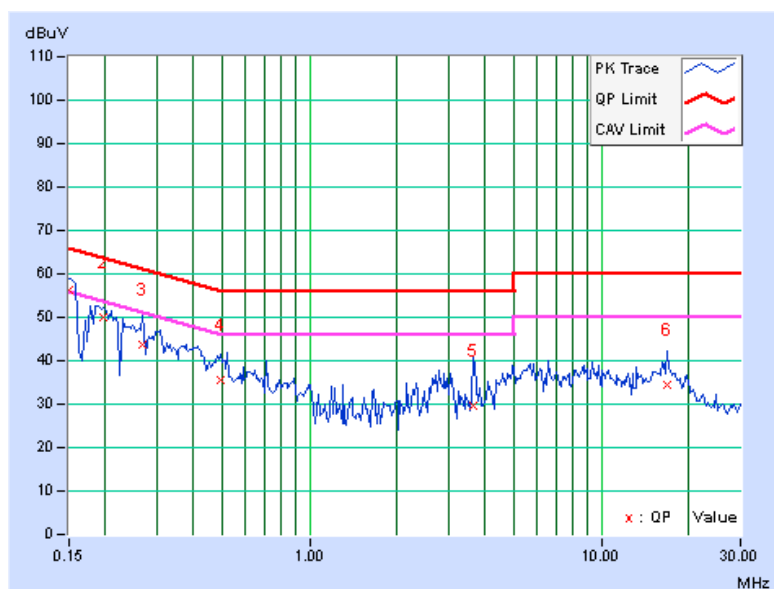

PHASE	Neutral (N)	DETECTOR FUNCTION	Quasi-Peak (QP) / Average (AV)
--------------	-------------	--------------------------	--------------------------------

No	Freq.	Corr.	Reading Value		Emission Level		Limit		Margin	
	[MHz]	Factor	[dB (uV)]		[dB (uV)]		[dB (uV)]		(dB)	
		(dB)	Q.P.	AV.	Q.P.	AV.	Q.P.	AV.	Q.P.	AV.
1	0.15000	0.11	55.71	45.03	55.82	45.14	66.00	56.00	-10.18	-10.86
2	0.19687	0.13	49.03	38.48	49.16	38.61	63.74	53.74	-14.58	-15.13
3	0.26719	0.15	43.71	24.05	43.86	24.20	61.20	51.20	-17.34	-27.00
4	0.37656	0.18	39.78	25.64	39.96	25.82	58.35	48.35	-18.39	-22.53
5	0.49375	0.19	33.94	21.36	34.13	21.55	56.10	46.10	-21.97	-24.55
6	9.43359	0.71	29.01	21.96	29.72	22.67	60.00	50.00	-30.28	-27.33

REMARKS:

1. Q.P. and AV. are abbreviations of quasi-peak and average individually.
2. The emission levels of other frequencies were very low against the limit.
3. Margin value = Emission Level – Limit value
4. Correction Factor = Insertion loss + Cable loss
5. Emission Level = Correction Factor + Reading Value

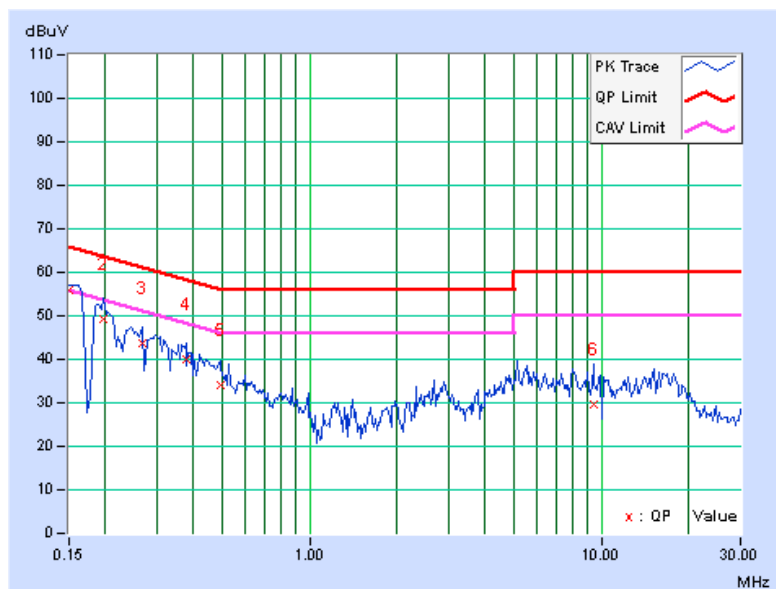

4.1.9 TEST RESULTS (MODE 3)

PHASE	Line (L)	DETECTOR FUNCTION	Quasi-Peak (QP) / Average (AV)
--------------	----------	--------------------------	--------------------------------

No	Freq. [MHz]	Corr. Factor [dB]	Reading Value [dB (uV)]		Emission Level [dB (uV)]		Limit [dB (uV)]		Margin (dB)	
			Q.P.	AV.	Q.P.	AV.	Q.P.	AV.	Q.P.	AV.
1	0.15000	0.13	53.55	40.74	53.68	40.87	66.00	56.00	-12.32	-15.13
2	0.47031	0.21	38.96	30.88	39.17	31.09	56.51	46.51	-17.34	-15.42
3	0.81016	0.23	31.55	18.91	31.78	19.14	56.00	46.00	-24.22	-26.86
4	1.81250	0.32	36.22	29.20	36.54	29.52	56.00	46.00	-19.46	-16.48
5	9.58984	0.87	33.76	28.19	34.63	29.06	60.00	50.00	-25.37	-20.94
6	14.63672	1.18	35.66	30.28	36.84	31.46	60.00	50.00	-23.16	-18.54

REMARKS:

1. Q.P. and AV. are abbreviations of quasi-peak and average individually.
2. The emission levels of other frequencies were very low against the limit.
3. Margin value = Emission Level – Limit value
4. Correction Factor = Insertion loss + Cable loss
5. Emission Level = Correction Factor + Reading Value

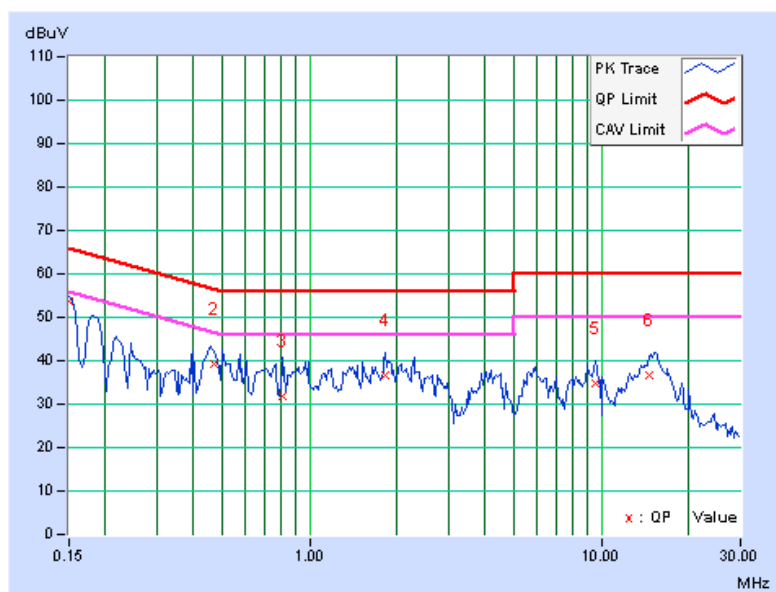

PHASE	Neutral (N)	DETECTOR FUNCTION	Quasi-Peak (QP) / Average (AV)
--------------	-------------	--------------------------	--------------------------------

No	Freq.	Corr.	Reading Value		Emission Level		Limit		Margin	
	[MHz]	Factor	[dB (uV)]		[dB (uV)]		[dB (uV)]		(dB)	
		(dB)	Q.P.	AV.	Q.P.	AV.	Q.P.	AV.	Q.P.	AV.
1	0.15000	0.11	53.29	42.01	53.40	42.12	66.00	56.00	-12.60	-13.88
2	0.44688	0.19	39.25	21.62	39.44	21.81	56.93	46.93	-17.49	-25.12
3	0.64609	0.20	39.16	31.55	39.36	31.75	56.00	46.00	-16.64	-14.25
4	5.42969	0.50	37.18	31.92	37.68	32.42	60.00	50.00	-22.32	-17.58
5	6.27734	0.55	33.72	23.59	34.27	24.14	60.00	50.00	-25.73	-25.86
6	8.53516	0.66	31.45	22.54	32.11	23.20	60.00	50.00	-27.89	-26.80

REMARKS:

1. Q.P. and AV. are abbreviations of quasi-peak and average individually.
2. The emission levels of other frequencies were very low against the limit.
3. Margin value = Emission Level – Limit value
4. Correction Factor = Insertion loss + Cable loss
5. Emission Level = Correction Factor + Reading Value

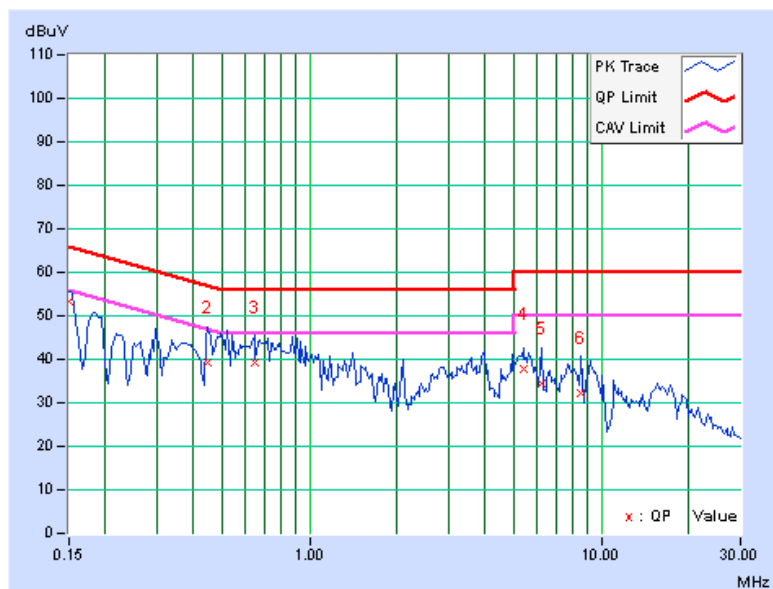

4.1.10 TEST RESULTS (MODE 4)

PHASE	Line (L)	DETECTOR FUNCTION	Quasi-Peak (QP) / Average (AV)
--------------	----------	--------------------------	--------------------------------

No	Freq. [MHz]	Corr. Factor [dB]	Reading Value [dB (uV)]		Emission Level [dB (uV)]		Limit [dB (uV)]		Margin (dB)	
			Q.P.	AV.	Q.P.	AV.	Q.P.	AV.	Q.P.	AV.
1	0.16953	0.14	52.31	39.34	52.45	39.48	64.98	54.98	-12.54	-15.51
2	0.26719	0.17	41.27	27.81	41.44	27.98	61.20	51.20	-19.77	-23.23
3	0.95469	0.25	26.09	15.90	26.34	16.15	56.00	46.00	-29.66	-29.85
4	2.83203	0.39	34.81	26.07	35.20	26.46	56.00	46.00	-20.80	-19.54
5	6.54688	0.65	35.26	27.37	35.91	28.02	60.00	50.00	-24.09	-21.98
6	15.72266	1.24	32.07	25.01	33.31	26.25	60.00	50.00	-26.69	-23.75

REMARKS:

1. Q.P. and AV. are abbreviations of quasi-peak and average individually.
2. The emission levels of other frequencies were very low against the limit.
3. Margin value = Emission Level – Limit value
4. Correction Factor = Insertion loss + Cable loss
5. Emission Level = Correction Factor + Reading Value

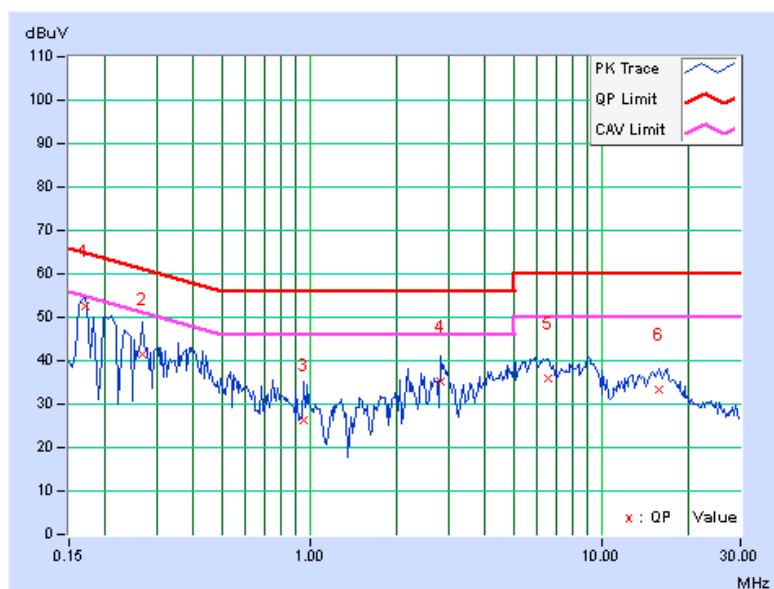



A D T

PHASE	Neutral (N)	DETECTOR FUNCTION	Quasi-Peak (QP) / Average (AV)
--------------	-------------	--------------------------	--------------------------------

No	Freq. [MHz]	Corr. Factor (dB)	Reading Value [dB (uV)]		Emission Level [dB (uV)]		Limit [dB (uV)]		Margin (dB)	
			Q.P.	AV.	Q.P.	AV.	Q.P.	AV.	Q.P.	AV.
1	0.15781	0.11	53.41	37.93	53.52	38.04	65.58	55.58	-12.06	-17.54
2	0.18125	0.12	48.63	33.44	48.75	33.56	64.43	54.43	-15.68	-20.87
3	0.34531	0.17	35.65	19.59	35.82	19.76	59.07	49.07	-23.25	-29.31
4	0.91953	0.22	22.92	11.56	23.14	11.78	56.00	46.00	-32.86	-34.22
5	2.83594	0.35	29.13	21.34	29.48	21.69	56.00	46.00	-26.52	-24.31
6	9.49219	0.71	27.13	19.81	27.84	20.52	60.00	50.00	-32.16	-29.48

REMARKS:

1. Q.P. and AV. are abbreviations of quasi-peak and average individually.
2. The emission levels of other frequencies were very low against the limit.
3. Margin value = Emission Level – Limit value
4. Correction Factor = Insertion loss + Cable loss
5. Emission Level = Correction Factor + Reading Value

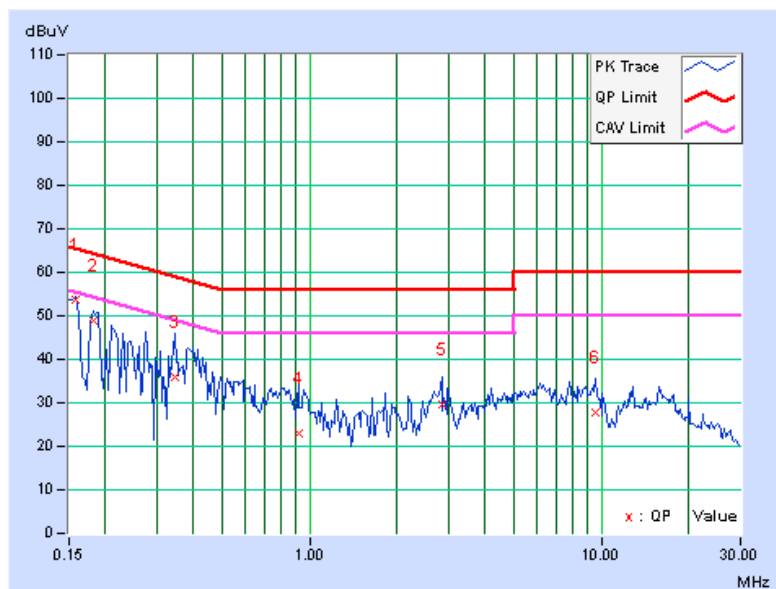



4.2 RADIATED EMISSION AND BANDEGE MEASUREMENT

4.2.1 LIMITS OF RADIATED EMISSION AND BANDEGE MEASUREMENT

Radiated emissions which fall in the restricted bands must comply with the radiated emission limits specified as below table:

Frequencies (MHz)	Field strength (microvolts/meter)	Measurement distance (meters)
0.009-0.490	2400/F(kHz)	300
0.490-1.705	24000/F(kHz)	30
1.705-30.0	30	30
30-88	100	3
88-216	150	3
216-960	200	3
Above 960	500	3

NOTE:

1. The lower limit shall apply at the transition frequencies.
2. Emission level (dBuV/m) = 20 log Emission level (uV/m).
3. For frequencies above 1000MHz, the field strength limits are based on average detector, however, the peak field strength of any emission shall not exceed the maximum permitted average limits, specified above by more than 20dB under any condition of modulation.

4.2.2 LIMITS OF UNWANTED EMISSION OUT OF THE RESTRICTED BANDS

APPLICABLE TO	LIMIT	
√	FIELD STRENGTH AT 3m (dBµV/m)	
	PK	AV
	74	54
-	EIRP LIMIT (dBm)	EQUIVALENT FIELD STRENGTH AT 3m (dBµV/m)
	PK	PK
	-27	68.3

NOTE:

1. The following formula is used to convert the equipment isotropic radiated power (eirp) to field strength:

$$E = \frac{1000000\sqrt{30P}}{3} \mu\text{V/m, where P is the eirp (Watts).$$



A D T

4.2.3 TEST INSTRUMENTS

For below 1GHz test:

DESCRIPTION & MANUFACTURER	MODEL NO.	SERIAL NO.	CALIBRATED DATE	CALIBRATED UNTIL
Spectrum Analyzer Agilent	E4446A	MY48250253	Sep. 03, 2012	Sep. 02, 2013
MXE EMI Receiver Agilent	N9038A	MY50010156	Jan. 16, 2013	Jan. 15, 2014
Pre-Amplifier Mini-Circuits	ZFL-1000VH2 B	AMP-ZFL-04	Nov. 14, 2012	Nov. 13, 2013
Pre-Amplifier Agilent	8449B	3008A01923	Oct. 30, 2012	Oct. 29, 2013
Pre-Amplifier SPACEK LABS	SLKKa-48-6	9K16	Nov. 14, 2012	Nov. 13, 2013
Trilog Broadband Antenna SCHWARZBECK	VULB 9168	9168-361	Mar. 25, 2013	Mar. 24, 2014
Horn_Antenna AISI	AIH.8018	0000220091110	Nov. 27, 2012	Nov. 26, 2013
Horn_Antenna SCHWARZBECK	BBHA 9170	9170-424	Oct. 12, 2012	Oct. 11, 2013
RF Cable	NA	RF104-205 RF104-207 RF104-202	Dec. 26, 2012	Dec. 25, 2013
RF Cable	NA	CHHCAB_001	Oct. 07, 2012	Oct. 06, 2013
Software	ADT_Radiated _V8.7.05	NA	NA	NA
Antenna Tower & Turn Table CT	NA	NA	NA	NA

Note:

1. The calibration interval of the above test instruments is 12 months and the calibrations are traceable to NML/ROC and NIST/USA.
2. The horn antenna, preamplifier (model: 8449B) are used only for the measurement of emission frequency above 1GHz if tested.
- 3 The test was performed in 966 Chamber No. H.
4. The FCC Site Registration No. is 797305.
- 5 The CANADA Site Registration No. is IC 7450H-3.
- 6 Tested Date: July 26, 2013



A D T

For above 1GHz test:

DESCRIPTION & MANUFACTURER	MODEL NO.	SERIAL NO.	CALIBRATED DATE	CALIBRATED UNTIL
Spectrum Analyzer Agilent	E4446A	MY48250253	Sep. 03, 2012	Sep. 02, 2013
MXE EMI Receiver Agilent	N9038A	MY51210105	Jan. 29,2013	Jan. 28,2014
Pre-Amplifier Mini-Circuits	ZFL-1000VH2 B	AMP-ZFL-03	Nov. 14, 2012	Nov. 13, 2013
Pre-Amplifier Agilent	8449B	3008A02578	June 25, 2013	June 24, 2014
Pre-Amplifier SPACEK LABS	SLKKa-48-6	9K16	Nov. 14, 2012	Nov. 13, 2013
Trilog Broadband Antenna SCHWARZBECK	VULB 9168	9168-360	Mar. 19, 2013	Mar. 18, 2014
Horn_Antenna AISI	AIH.8018	0000320091110	Nov. 19, 2012	Nov. 18, 2013
Horn_Antenna SCHWARZBECK	BBHA 9170	9170-424	Oct. 12, 2012	Oct. 11, 2013
RF Cable	NA	RF104-201 RF104-203 RF104-204	Dec. 25, 2012	Dec. 24, 2013
RF Cable	NA	CHGCAB_001	Oct. 06, 2012	Oct. 05, 2013
Software	ADT_Radiated _V8.7.05	NA	NA	NA
Antenna Tower & Turn Table CT	NA	NA	NA	NA

Note:

1. The calibration interval of the above test instruments is 12 months and the calibrations are traceable to NML/ROC and NIST/USA.
2. The horn antenna, preamplifier (model: 8449B) are used only for the measurement of emission frequency above 1GHz if tested.
3. The test was performed in 966 Chamber No. G.
4. The FCC Site Registration No. is 966073.
5. The VCCI Site Registration No. is G-137.
6. The CANADA Site Registration No. is IC 7450H-2.
7. Tested Date: Aug. 09, 2013

4.2.4 TEST PROCEDURES

- a. The EUT was placed on the top of a rotating table 0.8 meters above the ground at 3 meter chamber room for test. The table was rotated 360 degrees to determine the position of the highest radiation.
- b. The EUT was set 3 meters away from the interference-receiving antenna, which was mounted on the top of a variable-height antenna tower.
- c. The height of antenna is varied from one meter to four meters above the ground to determine the maximum value of the field strength. Both horizontal and vertical polarizations of the antenna are set to make the measurement.
- d. For each suspected emission, the EUT was arranged to its worst case and then the antenna was tuned to heights from 1 meter to 4 meters and the rotatable table was turned from 0 degrees to 360 degrees to find the maximum reading.
- e. The test-receiver system was set to quasi-peak detect function and specified bandwidth with maximum hold mode when the test frequency is below 1 GHz.
- f. The test-receiver system was set to peak and average detect function and specified bandwidth with maximum hold mode when the test frequency is above 1 GHz. If the peak reading value also meets average limit, measurement with the average detector is unnecessary.

NOTE:

1. The resolution bandwidth and video bandwidth of test receiver/spectrum analyzer is 120kHz for Quasi-peak detection (QP) at frequency below 1GHz.
2. The resolution bandwidth of test receiver/spectrum analyzer is 1 MHz and the video bandwidth is 3 MHz for Peak detection (PK) at frequency above 1GHz.
3. The resolution bandwidth of test receiver/spectrum analyzer is 1 MHz and the video bandwidth is 10 Hz for Average detection (AV) at frequency above 1GHz.
4. All modes of operation were investigated and the worst-case emissions are reported.

4.2.5 DEVIATION FROM TEST STANDARD

No deviation

4.2.6 TEST SETUP

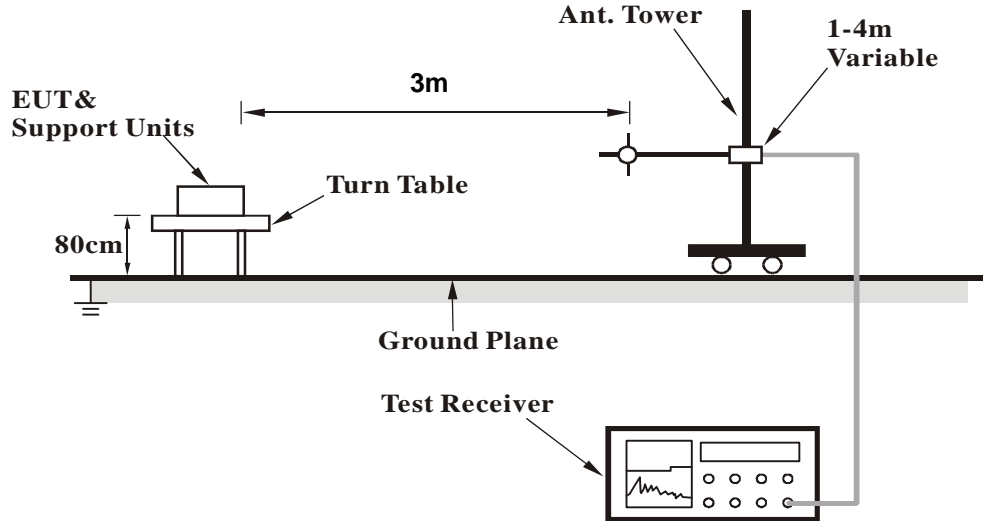

For the actual test configuration, please refer to the related item – Photographs of the Test Configuration.

4.2.7 EUT OPERATING CONDITION

Same as 4.1.6



A D T

4.2.8 TEST RESULTS

BELOW 1GHz WORST-CASE DATA

802.11a

CHANNEL	TX Channel 36	DETECTOR FUNCTION	Quasi-Peak (QP)
FREQUENCY RANGE	Below 1GHz		

ANTENNA POLARITY & TEST DISTANCE: HORIZONTAL AT 3 M

NO.	FREQ. (MHz)	EMISSION LEVEL (dBuV/m)	LIMIT (dBuV/m)	MARGIN (dB)	ANTENNA HEIGHT (m)	TABLE ANGLE (Degree)	RAW VALUE (dBuV)	CORRECTION FACTOR (dB/m)
1	55.32	33.6 QP	40.0	-6.4	1.00 H	174	46.84	-13.22
2	106.44	33.5 QP	43.5	-10.0	1.00 H	125	50.14	-16.63
3	275.56	37.7 QP	46.0	-8.3	1.00 H	266	50.83	-13.13
4	293.94	40.6 QP	46.0	-5.4	1.00 H	147	53.02	-12.42
5	408.74	35.1 QP	46.0	-10.9	1.50 H	22	44.86	-9.74
6	799.99	31.6 QP	46.0	-14.4	1.00 H	118	33.56	-1.96

ANTENNA POLARITY & TEST DISTANCE: VERTICAL AT 3 M

NO.	FREQ. (MHz)	EMISSION LEVEL (dBuV/m)	LIMIT (dBuV/m)	MARGIN (dB)	ANTENNA HEIGHT (m)	TABLE ANGLE (Degree)	RAW VALUE (dBuV)	CORRECTION FACTOR (dB/m)
1	49.27	35.6 QP	40.0	-4.4	1.09 V	208	49.19	-13.58
2	65.94	36.6 QP	40.0	-3.4	1.00 V	137	51.79	-15.18
3	272.01	39.0 QP	46.0	-7.0	1.00 V	109	52.28	-13.25
4	395.45	41.8 QP	46.0	-4.2	1.00 V	96	51.81	-10.01
5	408.93	38.8 QP	46.0	-7.2	1.00 V	4	48.51	-9.73
6	523.00	35.1 QP	46.0	-10.9	1.00 V	286	42.31	-7.21

REMARKS:

1. Emission Level(dBuV/m) = Raw Value(dBuV) + Correction Factor(dB/m)
2. Correction Factor(dB/m) = Antenna Factor(dB/m) + Cable Factor(dB) – Pre-Amplifier Factor(dB)
3. The other emission levels were very low against the limit.
4. Margin value = Emission Level – Limit value



A D T

ABOVE 1GHz DATA

802.11a

CHANNEL	TX Channel 36	DETECTOR FUNCTION	Peak (PK)
FREQUENCY RANGE	1GHz ~ 40GHz		Average (AV)

ANTENNA POLARITY & TEST DISTANCE: HORIZONTAL AT 3 M

NO.	FREQ. (MHz)	EMISSION LEVEL (dBuV/m)	LIMIT (dBuV/m)	MARGIN (dB)	ANTENNA HEIGHT (m)	TABLE ANGLE (Degree)	RAW VALUE (dBuV)	CORRECTION FACTOR (dB/m)
1	5020.00	56.7 PK	74.0	-17.3	1.00 H	330	15.37	41.33
2	5020.00	45.9 AV	54.0	-8.1	1.00 H	330	4.57	41.33
3	5100.00	54.9 PK	74.0	-19.1	1.55 H	327	13.35	41.55
4	5100.00	43.4 AV	54.0	-10.6	1.55 H	327	1.85	41.55
5	*5180.00	97.3 PK			1.09 H	190	55.38	41.92
6	*5180.00	87.8 AV			1.09 H	190	45.88	41.92
7	#10360.00	55.2 PK	74.0	-18.8	1.05 H	211	6.49	48.71
8	#10360.00	43.3 AV	54.0	-10.7	1.05 H	211	-5.41	48.71
9	15540.00	62.2 PK	74.0	-11.8	1.00 H	132	7.58	54.62
10	15540.00	50.2 AV	54.0	-3.8	1.00 H	132	-4.42	54.62

ANTENNA POLARITY & TEST DISTANCE: VERTICAL AT 3 M

NO.	FREQ. (MHz)	EMISSION LEVEL (dBuV/m)	LIMIT (dBuV/m)	MARGIN (dB)	ANTENNA HEIGHT (m)	TABLE ANGLE (Degree)	RAW VALUE (dBuV)	CORRECTION FACTOR (dB/m)
1	5020.00	63.4 PK	74.0	-10.6	1.43 V	227	22.07	41.33
2	5020.00	53.8 AV	54.0	-0.2	1.43 V	227	12.47	41.33
3	5100.00	62.9 PK	74.0	-11.1	1.41 V	231	21.35	41.55
4	5100.00	51.7 AV	54.0	-2.3	1.41 V	231	10.15	41.55
5	*5180.00	109.7 PK			1.38 V	232	67.78	41.92
6	*5180.00	100.0 AV			1.38 V	232	58.08	41.92
7	#10360.00	55.6 PK	74.0	-18.4	1.21 V	105	6.89	48.71
8	#10360.00	43.1 AV	54.0	-10.9	1.21 V	105	-5.61	48.71
9	15540.00	61.9 PK	74.0	-12.1	1.05 V	216	7.28	54.62
10	15540.00	50.1 AV	54.0	-3.9	1.05 V	216	-4.52	54.62

REMARKS:

1. Emission Level(dBuV/m) = Raw Value(dBuV) + Correction Factor(dB/m)
2. Correction Factor(dB/m) = Antenna Factor(dB/m) + Cable Factor(dB) – Pre-Amplifier Factor(dB)
3. The other emission levels were very low against the limit.
4. Margin value = Emission Level – Limit value
5. " * ": Fundamental frequency.
6. " # ": The radiated frequency is out of the restricted band.



A D T

CHANNEL	TX Channel 40	DETECTOR FUNCTION	Peak (PK)
FREQUENCY RANGE	1GHz ~ 40GHz		Average (AV)

ANTENNA POLARITY & TEST DISTANCE: HORIZONTAL AT 3 M

NO.	FREQ. (MHz)	EMISSION LEVEL (dBuV/m)	LIMIT (dBuV/m)	MARGIN (dB)	ANTENNA HEIGHT (m)	TABLE ANGLE (Degree)	RAW VALUE (dBuV)	CORRECTION FACTOR (dB/m)
1	5040.00	57.9 PK	74.0	-16.1	1.10 H	184	16.51	41.39
2	5040.00	48.5 AV	54.0	-5.5	1.10 H	184	7.11	41.39
3	*5200.00	95.9 PK			1.13 H	281	53.89	42.01
4	*5200.00	87.3 AV			1.13 H	281	45.29	42.01
5	#10400.00	55.6 PK	74.0	-18.4	1.09 H	207	7.27	48.33
6	#10400.00	43.7 AV	54.0	-10.3	1.09 H	207	-4.63	48.33
7	15600.00	62.1 PK	74.0	-11.9	1.01 H	141	7.59	54.51
8	15600.00	50.3 AV	54.0	-3.7	1.01 H	141	-4.21	54.51

ANTENNA POLARITY & TEST DISTANCE: VERTICAL AT 3 M

NO.	FREQ. (MHz)	EMISSION LEVEL (dBuV/m)	LIMIT (dBuV/m)	MARGIN (dB)	ANTENNA HEIGHT (m)	TABLE ANGLE (Degree)	RAW VALUE (dBuV)	CORRECTION FACTOR (dB/m)
1	5000.00	54.9 PK	74.0	-19.1	1.06 V	84	13.63	41.27
2	5000.00	46.8 AV	54.0	-7.2	1.06 V	84	5.53	41.27
3	5040.00	63.2 PK	74.0	-10.8	1.42 V	230	21.81	41.39
4	5040.00	53.7 AV	54.0	-0.3	1.42 V	230	12.31	41.39
5	5121.00	61.3 PK	74.0	-12.7	1.40 V	231	19.65	41.65
6	5121.00	51.2 AV	54.0	-2.8	1.40 V	231	9.55	41.65
7	5150.00	54.7 PK	74.0	-19.3	1.37 V	230	12.92	41.78
8	5150.00	41.6 AV	54.0	-12.4	1.37 V	230	-0.18	41.78
9	*5200.00	108.8 PK			1.38 V	230	66.79	42.01
10	*5200.00	99.0 AV			1.38 V	230	56.99	42.01
11	5360.00	56.8 PK	74.0	-17.2	1.33 V	230	14.47	42.33
12	5360.00	47.0 AV	54.0	-7.0	1.33 V	230	4.67	42.33
13	#10400.00	55.7 PK	74.0	-18.3	1.23 V	116	7.37	48.33
14	#10400.00	43.1 AV	54.0	-10.9	1.23 V	116	-5.23	48.33
15	15600.00	61.5 PK	74.0	-12.5	1.10 V	222	6.99	54.51
16	15600.00	49.8 AV	54.0	-4.2	1.10 V	222	-4.71	54.51

REMARKS:

- Emission Level(dBuV/m) = Raw Value(dBuV) + Correction Factor(dB/m)
- Correction Factor(dB/m) = Antenna Factor(dB/m) + Cable Factor(dB) – Pre-Amplifier Factor(dB)
- The other emission levels were very low against the limit.
- Margin value = Emission Level – Limit value
- " * ": Fundamental frequency.
- " # ": The radiated frequency is out of the restricted band.



A D T

CHANNEL	TX Channel 48	DETECTOR FUNCTION	Peak (PK)
FREQUENCY RANGE	1GHz ~ 40GHz		Average (AV)

ANTENNA POLARITY & TEST DISTANCE: HORIZONTAL AT 3 M

NO.	FREQ. (MHz)	EMISSION LEVEL (dBuV/m)	LIMIT (dBuV/m)	MARGIN (dB)	ANTENNA HEIGHT (m)	TABLE ANGLE (Degree)	RAW VALUE (dBuV)	CORRECTION FACTOR (dB/m)
1	*5240.00	96.5 PK			1.09 H	281	54.39	42.11
2	*5240.00	88.5 AV			1.09 H	281	46.39	42.11
3	5400.00	54.0 PK	74.0	-20.0	1.09 H	281	11.61	42.39
4	5400.00	42.5 AV	54.0	-11.5	1.09 H	281	0.11	42.39
5	#10480.00	54.7 PK	74.0	-19.3	1.06 H	210	5.81	48.89
6	#10480.00	43.2 AV	54.0	-10.8	1.06 H	210	-5.69	48.89
7	15720.00	62.1 PK	74.0	-11.9	1.00 H	134	7.81	54.29
8	15720.00	50.1 AV	54.0	-3.9	1.00 H	134	-4.19	54.29

ANTENNA POLARITY & TEST DISTANCE: VERTICAL AT 3 M

NO.	FREQ. (MHz)	EMISSION LEVEL (dBuV/m)	LIMIT (dBuV/m)	MARGIN (dB)	ANTENNA HEIGHT (m)	TABLE ANGLE (Degree)	RAW VALUE (dBuV)	CORRECTION FACTOR (dB/m)
1	5000.00	55.6 PK	74.0	-18.4	1.06 V	85	14.33	41.27
2	5000.00	46.3 AV	54.0	-7.7	1.06 V	85	5.03	41.27
3	5021.00	59.2 PK	74.0	-14.8	1.42 V	225	17.87	41.33
4	5021.00	48.3 AV	54.0	-5.7	1.42 V	225	6.97	41.33
5	5080.00	62.5 PK	74.0	-11.5	1.40 V	230	21.01	41.49
6	5080.00	53.7 AV	54.0	-0.3	1.40 V	230	12.21	41.49
7	5150.00	54.6 PK	74.0	-19.4	1.38 V	230	12.82	41.78
8	5150.00	41.6 AV	54.0	-12.4	1.38 V	230	-0.18	41.78
9	*5240.00	108.7 PK			1.38 V	130	66.59	42.11
10	*5240.00	99.1 AV			1.38 V	130	56.99	42.11
11	5400.00	57.5 PK	74.0	-16.5	1.31 V	231	15.11	42.39
12	5400.00	47.3 AV	54.0	-6.7	1.31 V	231	4.91	42.39
13	#10480.00	55.4 PK	74.0	-18.6	1.22 V	115	6.51	48.89
14	#10480.00	43.1 AV	54.0	-10.9	1.22 V	115	-5.79	48.89
15	15720.00	61.6 PK	74.0	-12.4	1.07 V	219	7.31	54.29
16	15720.00	50.0 AV	54.0	-4.0	1.07 V	219	-4.29	54.29

REMARKS:

1. Emission Level(dBuV/m) = Raw Value(dBuV) + Correction Factor(dB/m)
2. Correction Factor(dB/m) = Antenna Factor(dB/m) + Cable Factor(dB)
– Pre-Amplifier Factor(dB)
3. The other emission levels were very low against the limit.
4. Margin value = Emission Level – Limit value
5. " * ": Fundamental frequency.
6. " # ": The radiated frequency is out of the restricted band.



A D T

802.11n (HT20)

CHANNEL	TX Channel 36	DETECTOR FUNCTION	Peak (PK)
FREQUENCY RANGE	1GHz ~ 40GHz		Average (AV)

ANTENNA POLARITY & TEST DISTANCE: HORIZONTAL AT 3 M

NO.	FREQ. (MHz)	EMISSION LEVEL (dBuV/m)	LIMIT (dBuV/m)	MARGIN (dB)	ANTENNA HEIGHT (m)	TABLE ANGLE (Degree)	RAW VALUE (dBuV)	CORRECTION FACTOR (dB/m)
1	5020.00	59.3 PK	74.0	-14.7	1.00 H	189	17.97	41.33
2	5020.00	51.7 AV	54.0	-2.3	1.00 H	189	10.37	41.33
3	*5180.00	104.0 PK			1.13 H	281	62.08	41.92
4	*5180.00	95.6 AV			1.13 H	281	53.68	41.92
5	#10360.00	55.7 PK	74.0	-18.3	1.08 H	215	6.99	48.71
6	#10360.00	44.0 AV	54.0	-10.0	1.08 H	215	-4.71	48.71
7	15540.00	61.3 PK	74.0	-12.7	1.07 H	128	6.68	54.62
8	15540.00	49.8 AV	54.0	-4.2	1.07 H	128	-4.82	54.62

ANTENNA POLARITY & TEST DISTANCE: VERTICAL AT 3 M

NO.	FREQ. (MHz)	EMISSION LEVEL (dBuV/m)	LIMIT (dBuV/m)	MARGIN (dB)	ANTENNA HEIGHT (m)	TABLE ANGLE (Degree)	RAW VALUE (dBuV)	CORRECTION FACTOR (dB/m)
1	5000.00	59.5 PK	74.0	-14.5	1.08 V	215	18.23	41.27
2	5000.00	51.0 AV	54.0	-3.0	1.08 V	215	9.73	41.27
3	5020.00	61.6 PK	74.0	-12.4	1.18 V	231	20.27	41.33
4	5020.00	53.5 AV	54.0	-0.5	1.18 V	231	12.17	41.33
5	5100.00	60.4 PK	74.0	-13.6	1.25 V	244	18.85	41.55
6	5100.00	50.1 AV	54.0	-3.9	1.25 V	244	8.55	41.55
7	5148.00	55.1 PK	74.0	-18.9	1.38 V	231	13.32	41.78
8	5148.00	41.9 AV	54.0	-12.1	1.38 V	231	0.12	41.78
9	*5180.00	110.1 PK			1.38 V	231	68.18	41.92
10	*5180.00	100.5 AV			1.38 V	231	58.58	41.92
11	5350.00	53.6 PK	74.0	-20.4	1.38 V	231	11.28	42.32
12	5350.00	41.1 AV	54.0	-12.9	1.38 V	231	-1.22	42.32
13	#10360.00	55.7 PK	74.0	-18.3	1.26 V	114	6.99	48.71
14	#10360.00	43.1 AV	54.0	-10.9	1.26 V	114	-5.61	48.71
15	15540.00	61.5 PK	74.0	-12.5	1.04 V	203	6.88	54.62
16	15540.00	49.7 AV	54.0	-4.3	1.04 V	203	-4.92	54.62

REMARKS:

1. Emission Level(dBuV/m) = Raw Value(dBuV) + Correction Factor(dB/m)
2. Correction Factor(dB/m) = Antenna Factor(dB/m) + Cable Factor(dB) – Pre-Amplifier Factor(dB)
3. The other emission levels were very low against the limit.
4. Margin value = Emission Level – Limit value
5. " * ": Fundamental frequency.
6. " # ": The radiated frequency is out of the restricted band.



A D T

CHANNEL	TX Channel 40	DETECTOR FUNCTION	Peak (PK)
FREQUENCY RANGE	1GHz ~ 40GHz		Average (AV)

ANTENNA POLARITY & TEST DISTANCE: HORIZONTAL AT 3 M

NO.	FREQ. (MHz)	EMISSION LEVEL (dBuV/m)	LIMIT (dBuV/m)	MARGIN (dB)	ANTENNA HEIGHT (m)	TABLE ANGLE (Degree)	RAW VALUE (dBuV)	CORRECTION FACTOR (dB/m)
1	5040.00	57.9 PK	74.0	-16.1	1.00 H	179	16.51	41.39
2	5040.00	49.4 AV	54.0	-4.6	1.00 H	179	8.01	41.39
3	*5200.00	103.6 PK			1.13 H	281	61.59	42.01
4	*5200.00	94.5 AV			1.13 H	281	52.49	42.01
5	#10400.00	55.7 PK	74.0	-18.3	1.10 H	196	7.37	48.33
6	#10400.00	44.0 AV	54.0	-10.0	1.10 H	196	-4.33	48.33
7	15600.00	61.8 PK	74.0	-12.2	1.02 H	145	7.29	54.51
8	15600.00	49.8 AV	54.0	-4.2	1.02 H	145	-4.71	54.51

ANTENNA POLARITY & TEST DISTANCE: VERTICAL AT 3 M

NO.	FREQ. (MHz)	EMISSION LEVEL (dBuV/m)	LIMIT (dBuV/m)	MARGIN (dB)	ANTENNA HEIGHT (m)	TABLE ANGLE (Degree)	RAW VALUE (dBuV)	CORRECTION FACTOR (dB/m)
1	5000.00	58.4 PK	74.0	-15.6	1.08 V	214	17.13	41.27
2	5000.00	50.8 AV	54.0	-3.2	1.08 V	214	9.53	41.27
3	5040.00	62.1 PK	74.0	-11.9	1.19 V	193	20.71	41.39
4	5040.00	53.3 AV	54.0	-0.7	1.19 V	193	11.91	41.39
5	5120.00	58.7 PK	74.0	-15.3	1.24 V	242	17.06	41.64
6	5120.00	48.8 AV	54.0	-5.2	1.24 V	242	7.16	41.64
7	5150.00	54.7 PK	74.0	-19.3	1.39 V	230	12.92	41.78
8	5150.00	40.8 AV	54.0	-13.2	1.39 V	230	-0.98	41.78
9	*5200.00	108.3 PK			1.39 V	230	66.29	42.01
10	*5200.00	98.7 AV			1.39 V	230	56.69	42.01
11	5360.00	57.1 PK	74.0	-16.9	1.00 V	190	14.77	42.33
12	5360.00	47.3 AV	54.0	-6.7	1.00 V	190	4.97	42.33
13	#10400.00	55.8 PK	74.0	-18.2	1.17 V	120	7.47	48.33
14	#10400.00	43.4 AV	54.0	-10.6	1.17 V	120	-4.93	48.33
15	15600.00	61.3 PK	74.0	-12.7	1.00 V	211	6.79	54.51
16	15600.00	49.7 AV	54.0	-4.3	1.00 V	211	-4.81	54.51

REMARKS:

1. Emission Level(dBuV/m) = Raw Value(dBuV) + Correction Factor(dB/m)
2. Correction Factor(dB/m) = Antenna Factor(dB/m) + Cable Factor(dB)
– Pre-Amplifier Factor(dB)
3. The other emission levels were very low against the limit.
4. Margin value = Emission Level – Limit value
5. " * ": Fundamental frequency.
6. " # ": The radiated frequency is out of the restricted band.



A D T

CHANNEL	TX Channel 48	DETECTOR FUNCTION	Peak (PK)
FREQUENCY RANGE	1GHz ~ 40GHz		Average (AV)

ANTENNA POLARITY & TEST DISTANCE: HORIZONTAL AT 3 M

NO.	FREQ. (MHz)	EMISSION LEVEL (dBuV/m)	LIMIT (dBuV/m)	MARGIN (dB)	ANTENNA HEIGHT (m)	TABLE ANGLE (Degree)	RAW VALUE (dBuV)	CORRECTION FACTOR (dB/m)
1	*5240.00	102.7 PK			1.21 H	276	60.59	42.11
2	*5240.00	93.8 AV			1.21 H	276	51.69	42.11
3	5401.37	53.7 PK	74.0	-20.3	1.21 H	276	11.31	42.39
4	5401.37	43.2 AV	54.0	-10.8	1.21 H	276	0.81	42.39
5	#10480.00	55.3 PK	74.0	-18.7	1.10 H	205	6.41	48.89
6	#10480.00	43.5 AV	54.0	-10.5	1.10 H	205	-5.39	48.89
7	15720.00	62.6 PK	74.0	-11.4	1.00 H	146	8.31	54.29
8	15720.00	50.7 AV	54.0	-3.3	1.00 H	146	-3.59	54.29

ANTENNA POLARITY & TEST DISTANCE: VERTICAL AT 3 M

NO.	FREQ. (MHz)	EMISSION LEVEL (dBuV/m)	LIMIT (dBuV/m)	MARGIN (dB)	ANTENNA HEIGHT (m)	TABLE ANGLE (Degree)	RAW VALUE (dBuV)	CORRECTION FACTOR (dB/m)
1	5000.00	59.2 PK	74.0	-14.8	1.08 V	212	17.93	41.27
2	5000.00	50.4 AV	54.0	-3.6	1.08 V	212	9.13	41.27
3	5080.00	60.7 PK	74.0	-13.3	1.18 V	198	19.21	41.49
4	5080.00	53.8 AV	54.0	-0.2	1.18 V	198	12.31	41.49
5	5150.00	54.5 PK	74.0	-19.5	1.39 V	196	12.72	41.78
6	5150.00	40.6 AV	54.0	-13.4	1.39 V	196	-1.18	41.78
7	*5240.00	109.2 PK			1.39 V	196	67.09	42.11
8	*5240.00	98.9 AV			1.39 V	196	56.79	42.11
9	5400.00	58.7 PK	74.0	-15.3	1.00 V	184	16.31	42.39
10	5400.00	48.0 AV	54.0	-6.0	1.00 V	184	5.61	42.39
11	5458.00	57.2 PK	74.0	-16.8	1.09 V	184	14.54	42.66
12	5458.00	47.5 AV	54.0	-6.5	1.09 V	184	4.84	42.66
13	#10480.00	55.5 PK	74.0	-18.5	1.27 V	98	6.61	48.89
14	#10480.00	42.9 AV	54.0	-11.1	1.27 V	98	-5.99	48.89
15	15720.00	61.6 PK	74.0	-12.4	1.07 V	202	7.31	54.29
16	15720.00	49.7 AV	54.0	-4.3	1.07 V	202	-4.59	54.29

REMARKS:

1. Emission Level(dBuV/m) = Raw Value(dBuV) + Correction Factor(dB/m)
2. Correction Factor(dB/m) = Antenna Factor(dB/m) + Cable Factor(dB)
– Pre-Amplifier Factor(dB)
3. The other emission levels were very low against the limit.
4. Margin value = Emission Level – Limit value
5. " * ": Fundamental frequency.
6. " # ": The radiated frequency is out of the restricted band.



A D T

802.11n (HT40)

CHANNEL	TX Channel 38	DETECTOR FUNCTION	Peak (PK)
FREQUENCY RANGE	1GHz ~ 40GHz		Average (AV)

ANTENNA POLARITY & TEST DISTANCE: HORIZONTAL AT 3 M

NO.	FREQ. (MHz)	EMISSION LEVEL (dBuV/m)	LIMIT (dBuV/m)	MARGIN (dB)	ANTENNA HEIGHT (m)	TABLE ANGLE (Degree)	RAW VALUE (dBuV)	CORRECTION FACTOR (dB/m)
1	5030.00	56.0 PK	74.0	-18.0	1.21 H	6	14.65	41.35
2	5030.00	47.2 AV	54.0	-6.8	1.21 H	6	5.85	41.35
3	*5190.00	101.6 PK			1.28 H	7	59.63	41.97
4	*5190.00	92.2 AV			1.28 H	7	50.23	41.97
5	#10380.00	56.1 PK	74.0	-17.9	1.07 H	201	7.57	48.53
6	#10380.00	44.1 AV	54.0	-9.9	1.07 H	201	-4.43	48.53
7	15570.00	62.5 PK	74.0	-11.5	1.01 H	134	7.94	54.56
8	15570.00	50.7 AV	54.0	-3.3	1.01 H	134	-3.86	54.56

ANTENNA POLARITY & TEST DISTANCE: VERTICAL AT 3 M

NO.	FREQ. (MHz)	EMISSION LEVEL (dBuV/m)	LIMIT (dBuV/m)	MARGIN (dB)	ANTENNA HEIGHT (m)	TABLE ANGLE (Degree)	RAW VALUE (dBuV)	CORRECTION FACTOR (dB/m)
1	5000.00	58.9 PK	74.0	-15.1	1.00 V	197	17.63	41.27
2	5000.00	50.3 AV	54.0	-3.7	1.00 V	197	9.03	41.27
3	5030.00	59.3 PK	74.0	-14.7	1.15 V	228	17.95	41.35
4	5030.00	53.6 AV	54.0	-0.4	1.15 V	228	12.25	41.35
5	5116.00	50.2 PK	74.0	-23.8	1.17 V	211	8.57	41.63
6	5116.00	45.1 AV	54.0	-8.9	1.17 V	211	3.47	41.63
7	5150.00	51.2 PK	74.0	-22.8	1.27 V	206	9.42	41.78
8	5150.00	43.2 AV	54.0	-10.8	1.27 V	206	1.42	41.78
9	*5190.00	105.4 PK			1.27 V	206	63.43	41.97
10	*5190.00	95.5 AV			1.27 V	206	53.53	41.97
11	5350.00	53.8 PK	74.0	-20.2	1.27 V	206	11.48	42.32
12	5350.00	41.2 AV	54.0	-12.8	1.27 V	206	-1.12	42.32
13	#10380.00	56.1 PK	74.0	-17.9	1.22 V	116	7.57	48.53
14	#10380.00	43.3 AV	54.0	-10.7	1.22 V	116	-5.23	48.53
15	15570.00	61.7 PK	74.0	-12.3	1.03 V	204	7.14	54.56
16	15570.00	50.1 AV	54.0	-3.9	1.03 V	204	-4.46	54.56

REMARKS:

1. Emission Level(dBuV/m) = Raw Value(dBuV) + Correction Factor(dB/m)
2. Correction Factor(dB/m) = Antenna Factor(dB/m) + Cable Factor(dB) – Pre-Amplifier Factor(dB)
3. The other emission levels were very low against the limit.
4. Margin value = Emission Level – Limit value
5. " * ": Fundamental frequency.
6. " # ": The radiated frequency is out of the restricted band.



A D T

CHANNEL	TX Channel 46	DETECTOR FUNCTION	Peak (PK)
FREQUENCY RANGE	1GHz ~ 40GHz		Average (AV)

ANTENNA POLARITY & TEST DISTANCE: HORIZONTAL AT 3 M

NO.	FREQ. (MHz)	EMISSION LEVEL (dBuV/m)	LIMIT (dBuV/m)	MARGIN (dB)	ANTENNA HEIGHT (m)	TABLE ANGLE (Degree)	RAW VALUE (dBuV)	CORRECTION FACTOR (dB/m)
1	*5230.00	98.1 PK			1.21 H	272	56.02	42.08
2	*5230.00	90.1 AV			1.21 H	272	48.02	42.08
3	5390.00	53.9 PK	74.0	-20.1	1.19 H	255	11.52	42.38
4	5390.00	43.7 AV	54.0	-10.3	1.19 H	255	1.32	42.38
5	#10460.00	55.5 PK	74.0	-18.5	1.15 H	195	6.75	48.75
6	#10460.00	43.4 AV	54.0	-10.6	1.15 H	195	-5.35	48.75
7	15690.00	61.7 PK	74.0	-12.3	1.06 H	145	7.45	54.25
8	15690.00	49.8 AV	54.0	-4.2	1.06 H	145	-4.45	54.25

ANTENNA POLARITY & TEST DISTANCE: VERTICAL AT 3 M

NO.	FREQ. (MHz)	EMISSION LEVEL (dBuV/m)	LIMIT (dBuV/m)	MARGIN (dB)	ANTENNA HEIGHT (m)	TABLE ANGLE (Degree)	RAW VALUE (dBuV)	CORRECTION FACTOR (dB/m)
1	5000.00	59.4 PK	74.0	-14.6	1.03 V	213	18.13	41.27
2	5000.00	50.8 AV	54.0	-3.2	1.03 V	213	9.53	41.27
3	5070.00	59.5 PK	74.0	-14.5	1.15 V	231	18.03	41.47
4	5070.00	53.8 AV	54.0	-0.2	1.15 V	231	12.33	41.47
5	5150.00	55.0 PK	74.0	-19.0	1.35 V	187	13.22	41.78
6	5150.00	41.0 AV	54.0	-13.0	1.35 V	187	-0.78	41.78
7	*5230.00	104.6 PK			1.26 V	201	62.52	42.08
8	*5230.00	95.1 AV			1.26 V	201	53.02	42.08
9	5350.00	53.6 PK	74.0	-20.4	1.00 V	170	11.28	42.32
10	5350.00	41.2 AV	54.0	-12.8	1.00 V	170	-1.12	42.32
11	5390.00	53.1 PK	74.0	-20.9	1.00 V	172	10.72	42.38
12	5390.00	41.1 AV	54.0	-12.9	1.00 V	172	-1.28	42.38
13	#10460.00	55.2 PK	74.0	-18.8	1.24 V	96	6.45	48.75
14	#10460.00	42.8 AV	54.0	-11.2	1.24 V	96	-5.95	48.75
15	15690.00	62.0 PK	74.0	-12.0	1.00 V	217	7.75	54.25
16	15690.00	50.2 AV	54.0	-3.8	1.00 V	217	-4.05	54.25

REMARKS:

1. Emission Level(dBuV/m) = Raw Value(dBuV) + Correction Factor(dB/m)
2. Correction Factor(dB/m) = Antenna Factor(dB/m) + Cable Factor(dB)
– Pre-Amplifier Factor(dB)
3. The other emission levels were very low against the limit.
4. Margin value = Emission Level – Limit value
5. " * ": Fundamental frequency.
6. " # ": The radiated frequency is out of the restricted band.

802.11ac (VHT80)

CHANNEL	TX Channel 42	DETECTOR FUNCTION	Peak (PK)
FREQUENCY RANGE	1GHz ~ 40GHz		Average (AV)

ANTENNA POLARITY & TEST DISTANCE: HORIZONTAL AT 3 M								
NO.	FREQ. (MHz)	EMISSION LEVEL (dBuV/m)	LIMIT (dBuV/m)	MARGIN (dB)	ANTENNA HEIGHT (m)	TABLE ANGLE (Degree)	RAW VALUE (dBuV)	CORRECTION FACTOR (dB/m)
1	5000.00	56.7 PK	74.0	-17.3	1.00 H	218	15.43	41.27
2	5000.00	49.0 AV	54.0	-5.0	1.00 H	218	7.73	41.27
3	5050.00	55.1 PK	74.0	-18.9	1.22 H	5	13.69	41.41
4	5050.00	46.1 AV	54.0	-7.9	1.22 H	5	4.69	41.41
5	5148.00	56.9 PK	74.0	-17.1	1.11 H	282	15.12	41.78
6	5148.00	44.1 AV	54.0	-9.9	1.11 H	282	2.32	41.78
7	*5210.00	97.3 PK			1.11 H	282	55.27	42.03
8	*5210.00	87.2 AV			1.11 H	282	45.17	42.03
9	5350.00	54.7 PK	74.0	-19.3	1.11 H	282	12.38	42.32
10	5350.00	41.4 AV	54.0	-12.6	1.11 H	282	-0.92	42.32
11	#6946.00	61.1 PK	74.0	-12.9	1.21 H	358	12.47	48.63
12	#6946.00	49.5 AV	54.0	-4.5	1.21 H	358	0.87	48.63
13	#10420.00	55.3 PK	74.0	-18.7	1.05 H	218	6.83	48.47
14	#10420.00	43.5 AV	54.0	-10.5	1.05 H	218	-4.97	48.47
15	15630.00	62.0 PK	74.0	-12.0	1.03 H	143	7.57	54.43
16	15630.00	50.4 AV	54.0	-3.6	1.03 H	143	-4.03	54.43

REMARKS:

1. Emission Level(dBuV/m) = Raw Value(dBuV) + Correction Factor(dB/m)
2. Correction Factor(dB/m) = Antenna Factor(dB/m) + Cable Factor(dB) – Pre-Amplifier Factor(dB)
3. The other emission levels were very low against the limit.
4. Margin value = Emission Level – Limit value
5. " * ": Fundamental frequency.
6. " # ": The radiated frequency is out of the restricted band.



A D T

ANTENNA POLARITY & TEST DISTANCE: VERTICAL AT 3 M								
NO.	FREQ. (MHz)	EMISSION LEVEL (dBuV/m)	LIMIT (dBuV/m)	MARGIN (dB)	ANTENNA HEIGHT (m)	TABLE ANGLE (Degree)	RAW VALUE (dBuV)	CORRECTION FACTOR (dB/m)
1	5000.00	58.3 PK	74.0	-15.7	1.20 V	211	17.03	41.27
2	5000.00	50.0 AV	54.0	-4.0	1.20 V	211	8.73	41.27
3	5050.00	60.1 PK	74.0	-13.9	1.29 V	230	18.69	41.41
4	5050.00	53.7 AV	54.0	-0.3	1.29 V	230	12.29	41.41
5	5148.00	63.9 PK	74.0	-10.1	1.04 V	220	22.12	41.78
6	5148.00	47.9 AV	54.0	-6.1	1.04 V	220	6.12	41.78
7	*5210.00	102.8 PK			1.04 V	220	60.77	42.03
8	*5210.00	92.9 AV			1.04 V	220	50.87	42.03
9	5350.00	53.6 PK	74.0	-20.4	1.04 V	220	11.28	42.32
10	5350.00	42.5 AV	54.0	-11.5	1.04 V	220	0.18	42.32
11	#6946.00	62.2 PK	74.0	-11.8	1.63 V	143	13.57	48.63
12	#6946.00	52.4 AV	54.0	-1.6	1.63 V	143	3.77	48.63
13	#10420.00	56.1 PK	74.0	-17.9	1.24 V	120	7.63	48.47
14	#10420.00	43.5 AV	54.0	-10.5	1.24 V	120	-4.97	48.47
15	15630.00	61.5 PK	74.0	-12.5	1.07 V	211	7.07	54.43
16	15630.00	49.9 AV	54.0	-4.1	1.07 V	211	-4.53	54.43

REMARKS:

1. Emission Level(dBuV/m) = Raw Value(dBuV) + Correction Factor(dB/m)
2. Correction Factor(dB/m) = Antenna Factor(dB/m) + Cable Factor(dB) – Pre-Amplifier Factor(dB)
3. The other emission levels were very low against the limit.
4. Margin value = Emission Level – Limit value
5. " * ": Fundamental frequency.
6. " # ": The radiated frequency is out of the restricted band.

4.3 TRANSMIT POWER MEASUREMENT

4.3.1 LIMITS OF TRANSMIT POWER MEASUREMENT

Frequency Band	Limit
5.15 – 5.25GHz	The lesser of 50mW (17dBm) or 4dBm + 10logB
5.25 – 5.35GHz	The lesser of 250mW (24dBm) or 11dBm + 10logB
5.47 – 5.725GHz	The lesser of 250mW (24dBm) or 11dBm + 10logB
5.725 – 5.825GHz	The lesser of 1W (30dBm) or 17dBm + 10logB

Note: Where B is the 26dB emission bandwidth in MHz.

Per KDB 662911 D01 Multiple Transmitter Output v01r02 Method of conducted output power measurement on IEEE 802.11 devices,

Array Gain = 0 dB (i.e., no array gain) for NANT ≤ 4;

Array Gain = 0 dB (i.e., no array gain) for channel widths ≥ 40 MHz for any NANT;

Array Gain = 5 log(NANT/NSS) dB or 3 dB, whichever is less for 20-MHz channel widths with NANT ≥ 5.

For power measurements on all other devices: Array Gain = 10 log(NANT/NSS) dB.

4.3.2 TEST INSTRUMENTS

FOR POWER OUTPUT MEASUREMENT

DESCRIPTION & MANUFACTURER	MODEL NO.	SERIAL NO.	CALIBRATED DATE	CALIBRATED UNTIL
Power meter Anritsu	ML2495A	0824006	May 20, 2013	May 19, 2014
Power sensor Anritsu	MA2411B	0738172	May 20, 2013	May 19, 2014

Note:

1. The calibration interval of the above test instruments is 12 months and the calibrations are traceable to NML/ROC and NIST/USA.
2. Tested date : Aug. 08, 2013



A D T

FOR 26dB OCCUPIED BANDWIDTH

DESCRIPTION & MANUFACTURER	MODEL NO.	SERIAL NO.	CALIBRATED DATE	CALIBRATED UNTIL
Spectrum Analyzer R&S	FSP 40	100036	Jan. 21, 2013	Jan. 20, 2014

Note:

1. The calibration interval of the above test instruments is 12 months and the calibrations are traceable to NML/ROC and NIST/USA.
2. Tested date : Aug. 08, 2013

4.3.3 TEST PROCEDURE

FOR POWER OUTPUT MEASUREMENT

Method PM is used to perform output power measurement, trigger and gating function of wide band power meter is enabled to measure max output power of TX on burst. Duty factor is not added to measured value.

Duty cycle of test signal is < 98 %. Method PM is used to perform output power measurement, trigger and gating function of wide band power meter is enabled to measure max output power of TX on burst. Duty factor is not added to measured value.

FOR 26dB OCCUPIED BANDWIDTH

1. Set RBW = approximately 1% of the emission bandwidth.
2. Set the VBW > RBW.
3. Detector = Peak.
4. Trace mode = max hold.
5. Measure the maximum width of the emission that is 26 dB down from the peak of the emission. Compare this with the RBW setting of the analyzer. Readjust RBW and repeat measurement as needed until the RBW/EBW ratio is approximately 1%.

4.3.4 DEVIATION FROM TEST STANDARD

No deviation

4.3.5 TEST SETUP

FOR POWER OUTPUT MEASUREMENT

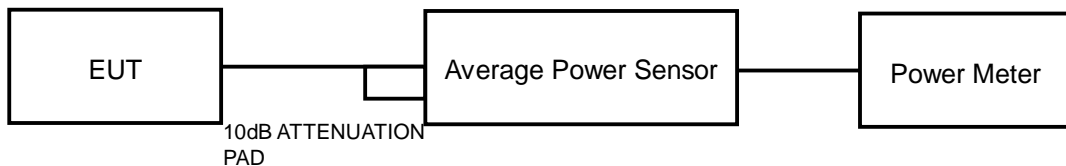

FOR 26dB OCCUPIED BANDWIDTH

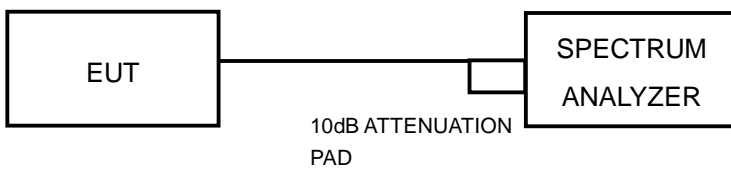

4.3.6 EUT OPERATING CONDITIONS

The software provided by client to enable the EUT under transmission condition continuously at specific channel frequencies individually.

4.3.7 TEST RESULTS

POWER OUTPUT:

802.11a

CHANNEL	CHANNEL FREQUENCY (MHz)	AVERAGE POWER (mW)	AVERAGE POWER (dBm)	POWER LIMIT (dBm)	PASS/FAIL
36	5180	26.424	14.22	17	PASS
40	5200	23.714	13.75	17	PASS
48	5240	25.177	14.01	17	PASS

26dB OCCUPIED BANDWIDTH:

CHANNEL	CHANNEL FREQUENCY (MHz)	26dBc BANDWIDTH (MHz)
36	5180	20.43
40	5200	20.47
48	5240	20.60

Note: For FCC output power limitation is determined based on 26dBc bandwidth.

Power Limit = 4dBm + 10logB < Band 1 >			
Channel Number	Freq.(MHz)	Min. B(MHz)	Determined Limit (dBm)
36	5180	20.43	17.1 > 17
40	5200	20.47	17.11 > 17
48	5240	20.60	17.13 > 17



A D T

802.11n (HT20)

CHAN.	CHAN. FREQ. (MHz)	AVERAGE POWER (dBm)			TOTAL POWER (mW)	TOTAL POWER (dBm)	POWER LIMIT (dBm)	PASS / FAIL
		CHAIN 0	CHAIN 1	CHAIN 2				
36	5180	9.01	9.11	9.34	24.699	13.93	17	PASS
40	5200	8.37	8.52	9.24	22.378	13.50	17	PASS
48	5240	8.19	8.42	9.28	22.014	13.43	17	PASS

26dB OCCUPIED BANDWIDTH:

CHANNEL	CHANNEL FREQUENCY (MHz)	26dBc BANDWIDTH (MHz)		
		CHAIN 0	CHAIN 1	CHAIN 2
36	5180	20.98	20.60	20.70
40	5200	21.01	20.52	20.67
48	5240	20.78	20.66	20.69

Note: For FCC output power limitation is determined based on 26dBc bandwidth.

Power Limit = 4dBm + 10logB < Band 1 >			
Channel Number	Freq.(MHz)	Min. B(MHz)	Determined Limit (dBm)
36	5180	20.60	17.13 > 17
40	5200	20.52	17.12 > 17
48	5240	20.66	17.15 > 17



A D T

802.11n (HT40)

CHAN.	CHAN. FREQ. (MHz)	AVERAGE POWER (dBm)			TOTAL POWER (mW)	TOTAL POWER (dBm)	POWER LIMIT (dBm)	PASS / FAIL
		CHAIN 0	CHAIN 1	CHAIN 2				
38	5190	8.61	8.94	9.52	24.049	13.81	17	PASS
46	5230	7.01	7.23	8.01	16.631	12.21	17	PASS

26dB OCCUPIED BANDWIDTH:

CHANNEL	CHANNEL FREQUENCY (MHz)	26dBc BANDWIDTH (MHz)		
		CHAIN 0	CHAIN 1	CHAIN 2
38	5190	41.79	41.37	41.18
46	5230	41.59	41.15	41.06

Note: For FCC output power limitation is determined based on 26dBc bandwidth.

Power Limit = 4dBm + 10logB < Band 1 >			
Channel Number	Freq.(MHz)	Min. B(MHz)	Determined Limit (dBm)
38	5190	41.18	20.14 > 17
46	5230	41.06	20.13 > 17



A D T

802.11ac (VHT80)

CHAN.	CHAN. FREQ. (MHz)	AVERAGE POWER (dBm)			TOTAL POWER (mW)	TOTAL POWER (dBm)	POWER LIMIT (dBm)	PASS / FAIL
		CHAIN 0	CHAIN 1	CHAIN 2				
42	5210	7.82	8.54	9.10	21.326	13.29	17	PASS

26dB OCCUPIED BANDWIDTH:

CHANNEL	CHANNEL FREQUENCY (MHz)	26dBc BANDWIDTH (MHz)		
		CHAIN 0	CHAIN 1	CHAIN 2
42	5210	83.36	82.67	82.07

Note: For output power limitation is determined based on 26dBc bandwidth.

Power Limit = $4\text{dBm} + 10\log B$ < Band 1 >			
Channel Number	Freq.(MHz)	Min. B(MHz)	Determined Limit (dBm)
42	5210	82.07	23.14 > 17



A D T

4.4 PEAK POWER SPECTRAL DENSITY MEASUREMENT

4.4.1 LIMITS OF PEAK POWER SPECTRAL DENSITY MEASUREMENT

Frequency Band	Limit
5.15 ~ 5.25GHz	4dBm
5.25 ~ 5.35GHz	11dBm
5.47 ~ 5.725GHz	11dBm
5.725 ~ 5.825GHz	17dBm

4.4.2 TEST INSTRUMENTS

DESCRIPTION & MANUFACTURER	MODEL NO.	SERIAL NO.	CALIBRATED DATE	CALIBRATED UNTIL
Spectrum Analyzer R&S	FSP 40	100036	Jan. 21, 2013	Jan. 20, 2014

Note:

1. The calibration interval of the above test instruments is 12 months and the calibrations are traceable to NML/ROC and NIST/USA.
2. Tested date : Aug. 08, 2013

4.4.3 TEST PROCEDURES

1. Set span to encompass the entire emission bandwidth (EBW) of the signal.
2. Set RBW = 1 MHz, Set VBW \geq 3 MHz, Detector = RMS
3. Sweep time = auto, trigger set to "free run".
4. Trace average at least 100 traces in power averaging mode.
5. Record the max value and for duty cycle of test signal is $< 98\%$ add $10 \log (1/\text{duty cycle})$

4.4.4 DEVIATION FROM TEST STANDARD

No deviation



A D T

4.4.5 TEST SETUP

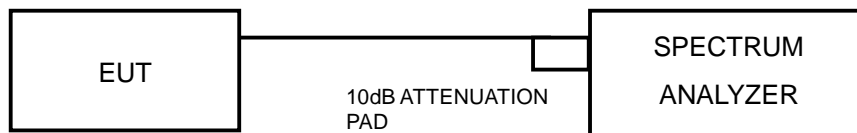

4.4.6 EUT OPERATING CONDITIONS

Same as 4.3.6



4.4.7 TEST RESULTS

802.11a

CHANNEL	CHANNEL FREQUENCY (MHz)	PSD (dBm)	MAXIMUM LIMIT (dBm)	PASS/FAIL
36	5180	0.31	4	PASS
40	5200	0.03	4	PASS
48	5240	0.52	4	PASS

802.11n (HT20)

CHANNEL	CHANNEL FREQUENCY (MHz)	PSD (dBm)			TOTAL POWER DENSITY (dBm)	MAX. LIMIT (dBm)	PASS/FAIL
		CHAIN 0	CHAIN 1	CHAIN 2			
36	5180	-5.57	-5.55	-4.79	-0.52	-0.39	PASS
40	5200	-6.05	-6.15	-5.15	-0.99	-0.39	PASS
48	5240	-5.88	-6.03	-5.19	-0.91	-0.39	PASS

NOTE: 1. Method 1 of power density measurement of KDB 662911 is using for calculating total power density. Total power density is summing entire spectra across corresponding frequency bins on the various outputs by computer.

2. Directional gain = $10 \log[(10^{G1/20} + 10^{G2/20} + 10^{G3/20})^2 / 3] = 10.39\text{dBi} > 6\text{dBi}$, so the power density limit shall be reduced to $4-(10.39-6) = -0.39\text{dBm}$.

802.11n (HT40)

CHANNEL	CHANNEL FREQUENCY (MHz)	PSD W/O DUTY FACTOR (dBm)			DUTY FACTOR (dB)	TOTAL PSD WITH DUTY FACTOR (dBm)	MAX. LIMIT (dBm)	PASS/FAIL
		CHAIN 0	CHAIN 1	CHAIN 2				
38	5190	-8.86	-8.82	-8.00	0.12	-3.65	-0.39	PASS
46	5230	-10.41	-10.61	-9.33	0.12	-5.19	-0.39	PASS

NOTE: 1. Method 1 of power density measurement of KDB 662911 is using for calculating total power density. Total power density is summing entire spectra across corresponding frequency bins on the various outputs by computer.

2. Directional gain = $10 \log[(10^{G1/20} + 10^{G2/20} + 10^{G3/20})^2 / 3] = 10.39\text{dBi} > 6\text{dBi}$, so the power density limit shall be reduced to $4-(10.39-6) = -0.39\text{dBm}$.

3. Refer to section 3.4 for duty cycle spectrum plot.



A D T

802.11ac (VHT80)

CHANNEL	CHANNEL FREQUENCY (MHz)	PSD W/O DUTY FACTOR (dBm)			DUTY FACTOR (dBm)	TOTAL PSD WITH DUTY FACTOR (dBm)	MAX. LIMIT (dBm)	PASS/FAIL
		CHAIN 0	CHAIN 1	CHAIN 2				
42	5210	-12.42	-12.23	-11.18	0.16	-6.98	-0.39	PASS

NOTE: 1. Method 1 of power density measurement of KDB 662911 is using for calculating total power density. Total power density is summing entire spectra across corresponding frequency bins on the various outputs by computer.

2. Directional gain = $10 \log[(10^{G1/20} + 10^{G2/20} + 10^{G3/20})^2 / 3] = 10.39\text{dBi} > 6\text{dBi}$, so the power density limit shall be reduced to $4-(10.39-6) = -0.39\text{dBm}$.

3. Refer to section 3.4 for duty cycle spectrum plot.

4.5 PEAK POWER EXCURSION MEASUREMENT

4.5.1 LIMITS OF PEAK POWER EXCURSION MEASUREMENT

Shall not exceed 13 dB

4.5.2 TEST INSTRUMENTS

DESCRIPTION & MANUFACTURER	MODEL NO.	SERIAL NO.	CALIBRATED DATE	CALIBRATED UNTIL
Spectrum Analyzer R&S	FSP 40	100036	Jan. 21, 2013	Jan. 20, 2014

Note:

1. The calibration interval of the above test instruments is 12 months and the calibrations are traceable to NML/ROC and NIST/USA.
2. Tested date : Aug. 08, 2013

4.5.3 TEST PROCEDURE

1. Set RBW = 1 MHz, VBW \geq 3 MHz, Detector = peak.
2. Trace mode = max-hold. Allow the sweeps to continue until the trace stabilizes.
3. Use the peak search function to find the peak of the spectrum.
4. Measure the PPSD.
5. Compute the ratio of the maximum of the peak-max-hold spectrum to the PPSD.

4.5.4 DEVIATION FROM TEST STANDARD

No deviation

4.5.5 TEST SETUP

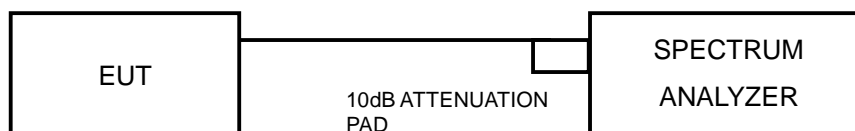

4.5.6 EUT OPERATING CONDITIONS

The software provided by client to enable the EUT under transmission condition continuously at specific channel frequencies individually.



A D T

4.5.7 TEST RESULTS

802.11a

CHANNEL	CHANNEL FREQUENCY (MHz)	PEAK VALUE (dBm)	PPSD (dBm)	PEAK EXCURSION (dB)	LIMIT (dB)	PASS/FAIL
36	5180	9.26	0.31	8.95	13	PASS
40	5200	8.95	0.03	8.92	13	PASS
48	5240	9.22	0.52	8.70	13	PASS

802.11n (HT20)

CHAN.	CHAN. FREQ. (MHz)	PEAK VALUE (dBm)			PPSD (dBm)			PEAK EXCURSION (dB)			LIMIT (dB)	PASS/FAIL
		CHAIN 0	CHAIN 1	CHAIN 2	CHAIN 0	CHAIN 1	CHAIN 2	CHAIN 0	CHAIN 1	CHAIN 2		
36	5180	3.54	4.93	4.75	-5.57	-5.55	-4.79	9.11	10.48	9.54	13	PASS
40	5200	3.25	4.46	4.29	-6.05	-6.15	-5.15	9.30	10.61	9.44	13	PASS
48	5240	3.17	4.13	5.12	-5.88	-6.03	-5.19	9.05	10.16	10.31	13	PASS

802.11n (HT40)

CHAN.	CHAN. FREQ. (MHz)	PEAK VALUE (dBm)			DUTY FACTOR (dB)	PPSD WITH DUTY FACTOR (dBm)			PEAK EXCURSION (dB)			LIMIT (dB)	PASS/FAIL
		CHAIN 0	CHAIN 1	CHAIN 2		CHAIN 0	CHAIN 1	CHAIN 2	CHAIN 0	CHAIN 1	CHAIN 2		
38	5190	0.41	1.51	1.61	0.12	-8.74	-8.70	-7.88	9.15	10.21	9.49	13	PASS
46	5230	-1.07	0.20	0.21	0.12	-10.29	-10.49	-9.21	9.22	10.69	9.42	13	PASS

802.11ac (VHT80)

CHAN.	CHAN. FREQ. (MHz)	PEAK VALUE (dBm)			DUTY FACTOR (dB)	PPSD WITH DUTY FACTOR (dBm)			PEAK EXCURSION (dB)			LIMIT (dB)	PASS/FAIL
		CHAIN 0	CHAIN 1	CHAIN 2		CHAIN 0	CHAIN 1	CHAIN 2	CHAIN 0	CHAIN 1	CHAIN 2		
42	5210	-2.69	-1.58	-0.60	0.16	-12.26	-12.07	-11.02	9.57	10.49	10.42	13	PASS



A D T

4.6 FREQUENCY STABILITY

4.6.1 LIMITS OF FREQUENCY STABILITY MEASUREMENT

The frequency of the carrier signal shall be maintained within band of operation

4.6.2 TEST INSTRUMENTS

DESCRIPTION & MANUFACTURER	MODEL NO.	SERIAL NO.	CALIBRATED DATE	CALIBRATED UNTIL
Spectrum Analyzer R&S	FSP 40	100036	Jan. 21, 2013	Jan. 20, 2014
Temperature & Humidity Chamber GIANTFORCE	GTH-150-40 -SP-AR	MAA0812-008	Jan. 17, 2013	Jan. 16, 2014

Note:

1. The calibration interval of the above test instruments is 12 months and the calibrations are traceable to NML/ROC and NIST/USA.
2. Tested date : Aug. 08, 2013

4.6.3 TEST PROCEDURE

1. The EUT was placed inside the environmental test chamber and powered by nominal AC voltage.
2. Turn the EUT on and couple its output to a spectrum analyzer.
3. Turn the EUT off and set the chamber to the highest temperature specified.
4. Allow sufficient time (approximately 30 min) for the temperature of the chamber to stabilize, turn the EUT on and measure the operating frequency after 2, 5, and 10 minutes.
5. Repeat step 2 and 3 with the temperature chamber set to the lowest temperature.
6. The test chamber was allowed to stabilize at +20 degree C for a minimum of 30 minutes. The supply voltage was then adjusted on the EUT from 85% to 115% and the frequency record.

4.6.4 DEVIATION FROM TEST STANDARD

No deviation

4.6.5 TEST SETUP

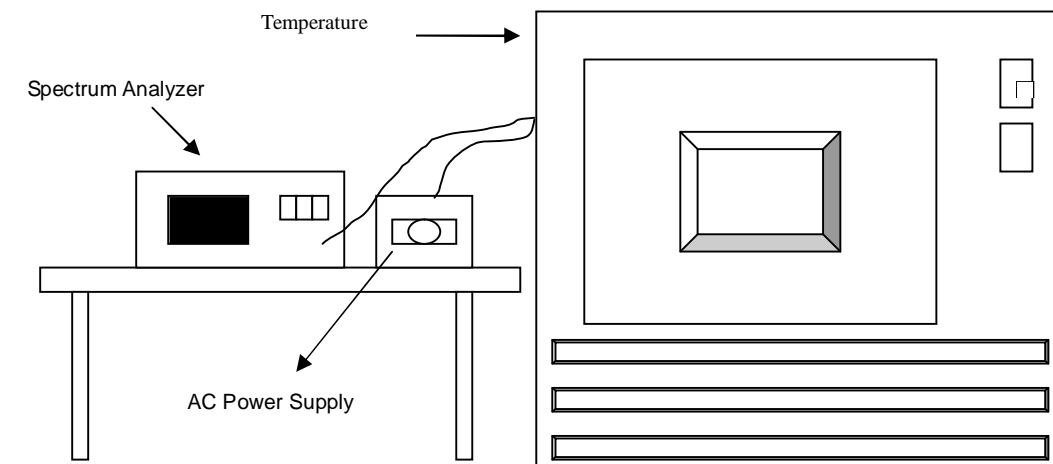

4.6.6 EUT OPERATING CONDITION

Set the EUT transmit at un-modulation mode to test frequency stability.



A D T

4.6.7 TEST RESULTS

FREQUENCY STABILITY VERSUS TEMP.									
OPERATING FREQUENCY: 5240MHz									
TEMP. (°C)	POWER SUPPLY (Vac)	0 MINUTE		2 MINUTE		5 MINUTE		10 MINUTE	
		Measured Frequency	Frequency Drift	Measured Frequency	Frequency Drift	Measured Frequency	Frequency Drift	Measured Frequency	Frequency Drift
		(MHz)	%	(MHz)	%	(MHz)	%	(MHz)	%
50	120	5239.9812	-0.00036	5239.9818	-0.00035	5239.9842	-0.00030	5239.977	-0.00044
40	120	5239.9891	-0.00021	5239.9961	-0.00007	5239.9889	-0.00021	5239.9921	-0.00015
30	120	5240.0112	0.00021	5240.0045	0.00009	5240.0085	0.00016	5240.0108	0.00021
20	120	5240.0259	0.00049	5240.0184	0.00035	5240.0232	0.00044	5240.0184	0.00035
10	120	5239.9994	-0.00001	5240.0026	0.00005	5239.9964	-0.00007	5239.9976	-0.00005
0	120	5240.0009	0.00002	5240.0048	0.00009	5240.0026	0.00005	5240.0058	0.00011
-10	120	5240.0243	0.00046	5240.0256	0.00049	5240.0284	0.00054	5240.0218	0.00042
-20	120	5239.9883	-0.00022	5239.9827	-0.00033	5239.9851	-0.00028	5239.9832	-0.00032
-30	120	5239.9991	-0.00002	5239.9985	-0.00003	5239.9993	-0.00001	5240.0023	0.00004

FREQUENCY STABILITY VERSUS VOLTAGE									
OPERATING FREQUENCY: 5240MHz									
TEMP. (°C)	POWER SUPPLY (Vac)	0 MINUTE		2 MINUTE		5 MINUTE		10 MINUTE	
		Measured Frequency	Frequency Drift	Measured Frequency	Frequency Drift	Measured Frequency	Frequency Drift	Measured Frequency	Frequency Drift
		(MHz)	%	(MHz)	%	(MHz)	%	(MHz)	%
20	138	5240.0261	0.00050	5240.0175	0.00033	5240.0229	0.00044	5240.0192	0.00037
	120	5240.0259	0.00049	5240.0184	0.00035	5240.0232	0.00044	5240.0184	0.00035
	102	5240.0256	0.00049	5240.0188	0.00036	5240.0224	0.00043	5240.0179	0.00034



A D T

5. PHOTOGRAPHS OF THE TEST CONFIGURATION

Please refer to the attached file (Test Setup Photo).

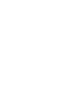



6. INFORMATION ON THE TESTING LABORATORIES

We, Bureau Veritas Consumer Products Services (H.K.) Ltd., Taoyuan Branch, were founded in 1988 to provide our best service in EMC, Radio, Telecom and Safety consultation. Our laboratories are accredited and approved according to ISO/IEC 17025.

If you have any comments, please feel free to contact us at the following:

Linko EMC/RF Lab:

Tel: 886-2-26052180

Fax: 886-2-26052943

Hsin Chu EMC/RF Lab:

Tel: 886-3-5935343

Fax: 886-3-5935342

Hwa Ya EMC/RF/Safety/Telecom Lab:

Tel: 886-3-3183232

Fax: 886-3-3270892

Email: service.adt@tw.bureauveritas.com

Web Site: www.bureauveritas-adt.com

The address and road map of all our labs can be found in our web site also.



A D T

7.APPENDIX A - MODIFICATIONS RECORDERS FOR ENGINEERING CHANGES TO THE EUT BY THE LAB

No modifications were made to the EUT by the lab during the test.

--- END ---