



# FCC TEST REPORT (15.247)

**REPORT NO.:** RF130725E03  
**MODEL NO.:** TEW-812DRU, TEW-815DAP  
**FCC ID:** XU8TEW1750ACV2  
**RECEIVED:** July 25, 2013  
**TESTED:** July 26 to Aug. 09, 2013  
**ISSUED:** Aug. 13, 2013

**APPLICANT:** TRENDnet, Inc.

**ADDRESS:** 20675 Manhattan Place, Torrance, CA  
90501

**ISSUED BY:** Bureau Veritas Consumer Products Services  
(H.K.) Ltd., Taoyuan Branch Hsin Chu Laboratory

**LAB ADDRESS :** No. 81-1, Lu Liao Keng, 9th Ling, Wu Lung Tsuen,  
Chiung Lin Hsiang, Hsin Chu Hsien 307, Taiwan,  
R.O.C.

**TEST LOCATION (1):** No. 81-1, Lu Liao Keng, 9th Ling, Wu Lung Tsuen,  
Chiung Lin Hsiang, Hsin Chu Hsien 307, Taiwan,  
R.O.C.

**TEST LOCATION (2):** No. 49, Ln. 206, Wende Rd., Shangshan Tsuen,  
Chiung Lin Hsiang, Hsin Chu Hsien 307, Taiwan,  
R.O.C.

This report should not be used by the client to claim product certification, approval, or endorsement by TAF or any government agencies.



This report is for your exclusive use. Any copying or replication of this report to or for any other person or entity, or use of our name or trademark, is permitted only with our prior written permission. This report sets forth our findings solely with respect to the test samples identified herein. The results set forth in this report are not indicative or representative of the quality or characteristics of the lot from which a test sample was taken or any similar or identical product unless specifically and expressly noted. Our report includes all of the tests requested by you and the results thereof based upon the information that you provided to us. You have 60 days from date of issuance of this report to notify us of any material error or omission caused by our negligence, provided, however, that such notice shall be in writing and shall specifically address the issue you wish to raise. A failure to raise such issue within the prescribed time shall constitute your unqualified acceptance of the completeness of this report, the tests conducted and the correctness of the report contents. Unless specific mention, the uncertainty of measurement has been explicitly taken into account to declare the compliance or non-compliance to the specification



A D T

## Table of Contents

RELEASE CONTROL RECORD .....	5
1. CERTIFICATION .....	6
2. SUMMARY OF TEST RESULTS .....	7
2.1 MEASUREMENT UNCERTAINTY .....	8
3. GENERAL INFORMATION .....	9
3.1 GENERAL DESCRIPTION OF EUT .....	9
3.2 DESCRIPTION OF TEST MODES .....	13
3.2.1 TEST MODE APPLICABILITY AND TESTED CHANNEL DETAIL .....	14
3.3 GENERAL DESCRIPTION OF APPLIED STANDARDS .....	17
3.4 DUTY CYCLE OF TEST SIGNAL .....	18
3.5 DESCRIPTION OF SUPPORT UNITS .....	20
3.6 CONFIGURATION OF SYSTEM UNDER TEST .....	21
4. TEST TYPES AND RESULTS (FOR 2.4GHz, 2.400 ~ 2.4835GHz BAND) .....	23
4.1 CONDUCTED EMISSION MEASUREMENT .....	23
4.1.1 LIMITS OF CONDUCTED EMISSION MEASUREMENT .....	23
4.1.2 TEST INSTRUMENTS .....	23
4.1.3 TEST PROCEDURES .....	24
4.1.4 DEVIATION FROM TEST STANDARD .....	24
4.1.5 TEST SETUP .....	24
4.1.6 EUT OPERATING CONDITIONS .....	25
4.1.7 TEST RESULTS (MODE 1) .....	26
4.1.8 TEST RESULTS (MODE 2) .....	28
4.1.9 TEST RESULTS (MODE 3) .....	30
4.1.10 TEST RESULTS (MODE 4) .....	32
4.2 RADIATED EMISSION AND BANDEDGE MEASUREMENT .....	34
4.2.1 LIMITS OF RADIATED EMISSION AND BANDEDGE MEASUREMENT .....	34
4.2.2 TEST INSTRUMENTS .....	35
4.2.3 TEST PROCEDURES .....	37
4.2.4 DEVIATION FROM TEST STANDARD .....	37
4.2.5 TEST SETUP .....	38
4.2.6 EUT OPERATING CONDITIONS .....	38
4.2.7 TEST RESULTS .....	39
4.3 6DB BANDWIDTH MEASUREMENT .....	52
4.3.1 LIMITS OF 6DB BANDWIDTH MEASUREMENT .....	52
4.3.2 TEST INSTRUMENTS .....	52
4.3.3 TEST PROCEDURE .....	52
4.3.4 DEVIATION FROM TEST STANDARD .....	52
4.3.5 TEST SETUP .....	52
4.3.6 EUT OPERATING CONDITIONS .....	52
4.3.7 TEST RESULTS .....	53
4.4 CONDUCTED OUTPUT POWER MEASUREMENT .....	54
4.4.1 LIMITS OF MAXIMUM PEAK OUTPUT POWER MEASUREMENT .....	54
4.4.2 INSTRUMENTS .....	54
4.4.3 TEST PROCEDURES .....	54
4.4.4 DEVIATION FROM TEST STANDARD .....	55
4.4.5 TEST SETUP .....	55
4.4.6 EUT OPERATING CONDITIONS .....	55
4.4.7 TEST RESULTS .....	56
4.5 POWER SPECTRAL DENSITY MEASUREMENT .....	57
4.5.1 LIMITS OF POWER SPECTRAL DENSITY MEASUREMENT .....	57



A D T

4.5.2	TEST INSTRUMENTS.....	57
4.5.3	TEST PROCEDURE.....	57
4.5.4	DEVIATION FROM TEST STANDARD.....	57
4.5.5	TEST SETUP.....	57
4.5.6	EUT OPERATING CONDITION.....	57
4.5.7	TEST RESULTS.....	58
4.6	CONDUCTED OUT-BAND EMISSION MEASUREMENT.....	60
4.6.1	LIMITS OF CONDUCTED OUT-BAND EMISSION MEASUREMENT.....	60
4.6.2	TEST INSTRUMENTS.....	60
4.6.3	TEST PROCEDURE.....	60
4.6.4	DEVIATION FROM TEST STANDARD.....	61
4.6.5	TEST SETUP.....	61
4.6.6	EUT OPERATING CONDITION.....	61
4.6.7	TEST RESULTS.....	61
5.	TEST TYPES AND RESULTS (FOR 5GHz, 5.725~5.850GHz BAND).....	70
5.1	CONDUCTED EMISSION MEASUREMENT.....	70
5.1.1	LIMITS OF CONDUCTED EMISSION MEASUREMENT.....	70
5.1.2	TEST INSTRUMENTS.....	70
5.1.3	TEST PROCEDURES.....	71
5.1.4	DEVIATION FROM TEST STANDARD.....	71
5.1.5	TEST SETUP.....	71
5.1.6	EUT OPERATING CONDITIONS.....	72
5.1.7	TEST RESULTS (MODE 1).....	73
5.1.8	TEST RESULTS (MODE 2).....	75
5.1.9	TEST RESULTS (MODE 3).....	77
5.1.10	TEST RESULTS (MODE 4).....	79
5.2	RADIATED AND BANDEDGE EMISSION MEASUREMENT.....	81
5.2.1	LIMITS OF RADIATED AND BANDEDGE EMISSION MEASUREMENT.....	81
5.2.2	TEST INSTRUMENTS.....	82
5.2.3	TEST PROCEDURES.....	84
5.2.4	DEVIATION FROM TEST STANDARD.....	84
5.2.5	TEST SETUP.....	85
5.2.6	EUT OPERATING CONDITIONS.....	85
5.2.7	TEST RESULTS.....	86
5.3	6DB BANDWIDTH MEASUREMENT.....	96
5.3.1	LIMITS OF 6DB BANDWIDTH MEASUREMENT.....	96
5.3.2	TEST INSTRUMENTS.....	96
5.3.3	TEST PROCEDURE.....	96
5.3.4	DEVIATION FROM TEST STANDARD.....	96
5.3.5	TEST SETUP.....	96
5.3.6	EUT OPERATING CONDITIONS.....	96
5.3.7	TEST RESULTS.....	97
5.4	CONDUCTED OUTPUT POWER MEASUREMENT.....	98
5.4.1	LIMITS OF CONDUCTED OUTPUT POWER MEASUREMENT.....	98
5.4.2	INSTRUMENTS.....	98
5.4.3	TEST PROCEDURES.....	98
5.4.4	DEVIATION FROM TEST STANDARD.....	99
5.4.5	TEST SETUP.....	99
5.4.6	EUT OPERATING CONDITIONS.....	99
5.4.7	TEST RESULTS.....	100
5.5	POWER SPECTRAL DENSITY MEASUREMENT.....	101
5.5.1	LIMITS OF POWER SPECTRAL DENSITY MEASUREMENT.....	101



A D T

5.5.2	TEST INSTRUMENTS.....	101
5.5.3	TEST PROCEDURE.....	101
5.5.4	DEVIATION FROM TEST STANDARD.....	101
5.5.5	TEST SETUP .....	101
5.5.6	EUT OPERATING CONDITION.....	101
5.5.7	TEST RESULTS .....	102
5.6	CONDUCTED OUT-BAND EMISSION MEASUREMENT.....	104
5.6.1	LIMITS OF CONDUCTED OUT-BAND EMISSION MEASUREMENT.....	104
5.6.2	TEST INSTRUMENTS.....	104
5.6.3	TEST PROCEDURE.....	104
5.6.4	DEVIATION FROM TEST STANDARD.....	105
5.6.5	TEST SETUP .....	105
5.6.6	EUT OPERATING CONDITION.....	105
5.6.7	TEST RESULTS .....	105
6.	PHOTOGRAPHS OF THE TEST CONFIGURATION.....	113
7.	INFORMATION ON THE TESTING LABORATORIES .....	114
8.	APPENDIX A - MODIFICATIONS RECORDERS FOR ENGINEERING CHANGES TO THE EUT BY THE LAB.....	115



A D T

## RELEASE CONTROL RECORD

ISSUE NO.	REASON FOR CHANGE	DATE ISSUED
RF130725E03	Original release	Aug. 13, 2013



## 1. CERTIFICATION

**PRODUCT:** AC1750 Dual Band Wireless Router, AC1750 Dual Band Wireless Access Point

**BRAND NAME:** TRENDnet

**MODEL NO.:** TEW-812DRU, TEW-815DAP

**TEST SAMPLE:** ENGINEERING SAMPLE

**APPLICANT:** TRENDnet, Inc.

**TESTED:** July 26 to Aug. 09, 2013

**STANDARDS:** FCC Part 15, Subpart C (Section 15.247)  
ANSI C63.10-2009

The above equipment (Model: TEW-812DRU, TEW-815DAP) have been tested by **Bureau Veritas Consumer Products Services (H.K.) Ltd., Taoyuan Branch**, and found compliance with the requirement of the above standards. The test record, data evaluation & Equipment Under Test (EUT) configurations represented herein are true and accurate accounts of the measurements of the sample's EMC characteristics under the conditions specified in this report.

**PREPARED BY :** Phoenix Huang , **DATE:** Aug. 13, 2013  
( Phoenix Huang, Specialist )

**APPROVED BY :** May Chen , **DATE:** Aug. 13, 2013  
( May Chen, Manager )



A D T

## 2. SUMMARY OF TEST RESULTS

The EUT has been tested according to the following specifications:

For 2.4GHz, 2400~2483.5MHz Band

APPLIED STANDARD: FCC PART 15, SUBPART C (SECTION 15.247)			
STANDARD SECTION	TEST TYPE	RESULT	REMARK
15.207	AC Power Conducted Emission	PASS	Meet the requirement of limit. Minimum passing margin is -8.83dB at 0.48984MHz
15.247(d) 15.209	Radiated Emissions	PASS	Meet the requirement of limit. Minimum passing margin is -0.1dB at 7311.00MHz
15.247(d)	Band Edge Measurement	PASS	Meet the requirement of limit.
15.247(a)(2)	6dB bandwidth	PASS	Meet the requirement of limit.
15.247(b)	Conducted output power	PASS	Meet the requirement of limit.
15.247(e)	Power Spectral Density	PASS	Meet the requirement of limit.
15.203	Antenna Requirement	PASS	Antenna connector is I-PEX not a standard connector.

For 5GHz, 5725~5850MHz Band

APPLIED STANDARD: FCC PART 15, SUBPART C (SECTION 15.247)			
STANDARD SECTION	TEST TYPE	RESULT	REMARK
15.207	AC Power Conducted Emission	PASS	Meet the requirement of limit. Minimum passing margin is -7.99dB at 0.15000MHz
15.247(d) 15.209	Radiated Emissions	PASS	Meet the requirement of limit. Minimum passing margin is -0.3dB at 11490.00MHz
15.247(d)	Band Edge Measurement	PASS	Meet the requirement of limit.
15.247(a)(2)	6dB bandwidth	PASS	Meet the requirement of limit.
15.247(b)	Conducted output power	PASS	Meet the requirement of limit.
15.247(e)	Power Spectral Density	PASS	Meet the requirement of limit.
15.203	Antenna Requirement	PASS	Antenna connector is I-PEX not a standard connector.

### NOTE:

The EUT was operating in 2.400 ~ 2.4835GHz, 5.15~5.25GHz and 5.725~5.850GHz frequencies band. This report was recorded the RF parameters including 2.400 ~ 2.4835GHz and 5.725~5.850GHz. For the 5.15~5.25GHz RF parameters was recorded in another test report.



A D T

## 2.1 MEASUREMENT UNCERTAINTY

Where relevant, the following measurement uncertainty levels have been estimated for tests performed on the EUT as specified in CISPR 16-4-2:

This uncertainty represents an expanded uncertainty expressed at approximately the 95% confidence level using a coverage factor of  $k=2$ .

Measurement	Value
Conducted emissions	2.98 dB
Radiated emissions (30MHz-1GHz)	5.46 dB
Radiated emissions (1GHz -6GHz)	3.73 dB
Radiated emissions (6GHz -18GHz)	3.90 dB
Radiated emissions (18GHz -40GHz)	4.11 dB





A D T

### 3. GENERAL INFORMATION

#### 3.1 GENERAL DESCRIPTION OF EUT

<b>PRODUCT</b>	AC1750 Dual Band Wireless Router, AC1750 Dual Band Wireless Access Point
<b>MODEL NO.</b>	TEW-812DRU, TEW-815DAP
<b>POWER SUPPLY</b>	DC 12V from power adapter
<b>MODULATION TYPE</b>	CCK, DQPSK, DBPSK for DSSS 64QAM, 16QAM, QPSK, BPSK for OFDM 256QAM for OFDM in 11ac mode only.
<b>MODULATION TECHNOLOGY</b>	DSSS,OFDM
<b>TRANSFER RATE</b>	802.11b: up to 11Mbps 802.11a / g: up to 54Mbps 802.11n: up to 450Mbps 802.11ac: up to 1300Mbps
<b>OPERATING FREQUENCY</b>	<b>For 15.407</b> 5GHz: 5.18 ~ 5.24GHz
	<b>For 15.247</b> 2.4GHz: 2.412 ~ 2.462GHz 5GHz: 5.745 ~ 5.825GHz
<b>NUMBER OF CHANNEL</b>	<b>For 15.407</b> 4 for 802.11a, 802.11n (HT20), 802.11ac (VHT20) 2 for 802.11n (HT40), 802.11ac (VHT40) 1 for 802.11ac (VHT80)
	<b>For 15.247 (2.4GHz)</b> 11 for 802.11b, 802.11g, 802.11n (HT20) 7 for 802.11n (HT40) <b>For 15.247 (5GHz)</b> 5 for 802.11a, 802.11n (HT20), 802.11ac (VHT20) 2 for 802.11n (HT40), 802.11ac (VHT40) 1 for 802.11ac (VHT80)

<b>MAXIMUM OUTPUT POWER</b>	<p><b>For 15.407</b></p> <p>802.11a: 26.424mW              802.11n (HT20): 24.699mW              802.11n (HT40): 24.049mW              802.11ac (VHT80): 21.326mW</p> <p><b>For 15.247 (2.4GHz)</b></p> <p>802.11b: 116.681mW              802.11g: 402.717mW              802.11n (HT20): 968.597mW              802.11n (HT40): 155.250mW</p> <p><b>For 15.247 (5GHz)</b></p> <p>802.11a: 227.510mW              802.11n (HT20): 439.897mW              802.11n (HT40): 705.163mW              802.11ac (VHT80): 283.146mW</p>
<b>ANTENNA TYPE</b>	Please see NOTE
<b>DATA CABLE</b>	RJ-45 Cable (unshielded, 1.5m) x1
<b>I/O PORTS</b>	Refer to user's manual
<b>ASSOCIATED DEVICES</b>	Adapter x1

**NOTE:**

1. The EUT is a 2.4GHz & 5GHz WLAN device.
2. The EUT has two product names and model names, which are identical to each other in all aspects except for the following table:

Product	Brand	Model No.	Difference
AC1750 Dual Band Wireless Router	TRENDnet	TEW-812DRU	LAN x 4 WAN x 1 USB x 1 DC-JACK x 1
AC1750 Dual Band Wireless Access Point	TRENDnet	TEW-815DAP	LAN x 1 DC-JACK x 1

From the above models, the worst case was found in model: **TEW-812DRU** and was selected as representative model for the test (except for AC Power Conducted Emission) and its data was recorded in this report.



A D T

3. The EUT must be supplied with a power adapter and following two different models could be chosen as following table:

No	Brand	Model No.	Spec.	Plug
1	HON-KWANG	HK-AX-120A200-US	Input: 100-240V, 0.8A, 50/60Hz Output: 12V, 2A DC output cable (Unshielded, 1.5m)	US
2	Ktec	KSASB0241200200HU	Input: 100-240V, 0.6A, 50/60Hz Output: 12V, 2A DC output cable (Unshielded, 1.5m)	US

1. For radiated emissions test, the EUT was pre-tested with above adapters 1 & 2, the worst case was found in adapter 1. Therefore only the test data of the adapter was recorded in this report.

4. The antenna provided to the EUT, please refer to the following table:

For 2.4GHz					
Transmitter Circuit	Antenna Type	Peak Gain(dBi) (Include cable loss)	Connector Type	Frequency range (MHz to MHz)	Cable Length (mm)
Chain (0)	Dipole	2.5	i-pex	2400~2500	78
Chain (1)	Dipole	6	i-pex	2400~2500	90
Chain (2)	Dipole	5.5	i-pex	2400~2500	185
For 5GHz (Band 1)					
Transmitter Circuit	Antenna Type	Peak Gain(dBi) (Include cable loss)	Connector Type	Frequency range (MHz to MHz)	Cable Length (mm)
Chain (0)	Dipole	4.8	i-pex	5150~5825	78
Chain (1)	Dipole	6	i-pex	5150~5825	90
Chain (2)	Dipole	6	i-pex	5150~5825	185

**Note:**

1. For 802.11b mode will fix transmission on Chain (0).
2. For 802.11g, the worst case was found in Chain (1) Therefore only the test data of the mode was recorded in this report.
3. For 802.11a, the worst case was found in Chain (1) Therefore only the test data of the mode was recorded in this report.

5. The EUT incorporates a MIMO function without beam forming.

<b>MODULATION MODE</b>	<b>TX/RX FUNCTION</b>
<b>802.11b</b>	1TX/3RX
<b>802.11g</b>	1TX (Diversity)/3RX
<b>802.11n (HT20) &lt;2.4GHz&gt;</b>	3TX/3RX
<b>802.11n (HT40) &lt;2.4GHz&gt;</b>	3TX/3RX
<b>802.11a</b>	1TX (Diversity)/3Rx
<b>802.11n (HT20) &lt;5GHz&gt;</b>	3TX/3RX
<b>802.11n (HT40) &lt;5GHz&gt;</b>	3TX/3RX
<b>802.11ac (VHT20)</b>	3TX/3RX
<b>802.11ac (VHT40)</b>	3TX/3RX
<b>802.11ac (VHT80)</b>	3TX/3RX

Note: The modulation and bandwidth are similar for 802.11n mode for 20MHz (40MHz) and 802.11ac mode for 20MHz (40MHz), therefore investigated worst case to representative mode in test report. (Final test mode refer section 3.2.1)

6. The emission of the simultaneous operation (2.4GHz & 5GHz) has been evaluated and no non-compliance was found.
7. When the EUT operating in 802.11n, the software operation, which is defined by manufacturer, MCS (Modulation and Coding Schemes) from 0 to 23.
8. When the EUT operating in 802.11ac, the software operation, which is defined by manufacturer, MCS (Modulation and Coding Schemes) from 0 to 9.
9. The above EUT information was declared by the manufacturer and for more detailed features description, please refer to the manufacturer's specifications or User's Manual.

### 3.2 DESCRIPTION OF TEST MODES

#### Operated in 2400 ~ 2483.5MHz band:

11 channels are provided for 802.11b, 802.11g, 802.11n (HT20):

CHANNEL	FREQUENCY	CHANNEL	FREQUENCY
1	2412MHz	7	2442MHz
2	2417MHz	8	2447MHz
3	2422MHz	9	2452MHz
4	2427MHz	10	2457MHz
5	2432MHz	11	2462MHz
6	2437MHz		

7 channels are provided for 802.11n (HT40):

CHANNEL	FREQUENCY	CHANNEL	FREQUENCY
3	2422MHz	7	2442MHz
4	2427MHz	8	2447MHz
5	2432MHz	9	2452MHz
6	2437MHz		

#### Operated in 5725 ~ 5850MHz band:

5 channels are provided for 802.11a, 802.11n (HT20), 802.11ac (VHT20):

CHANNEL	FREQUENCY	CHANNEL	FREQUENCY
149	5745 MHz	161	5805 MHz
153	5765 MHz	165	5825 MHz
157	5785 MHz		

2 channels are provided for 802.11n (HT40), 802.11ac (VHT40):

CHANNEL	FREQUENCY
151	5755 MHz
159	5795 MHz

1 channel is provided for 802.11ac (VHT80):

CHANNEL	FREQUENCY
155	5775 MHz



A D T

### 3.2.1 TEST MODE APPLICABILITY AND TESTED CHANNEL DETAIL

EUT CONFIGURE MODE	APPLICABLE TO					DESCRIPTION
	PLC	RE < 1G	RE ≥ 1G	APCM	OB	
1	√	√	√	√	√	Model No.: TEW-812DRU with adapter 1
2	√	-	-	-	-	Model No.: TEW-812DRU with adapter 2
3	√	-	-	-	-	Model No.: TEW-815DAP with adapter 1
4	√	-	-	-	-	Model No.: TEW-815DAP with adapter 2

Where **PLC**: Power Line Conducted Emission      **RE < 1G**: Radiated Emission below 1GHz  
**RE ≥ 1G**: Radiated Emission above 1GHz      **APCM**: Antenna Port Conducted Measurement  
**OB**: Conducted Out-Band Emission Measurement

#### **POWER LINE CONDUCTED EMISSION TEST:**

- Pre-Scan has been conducted to determine the worst-case mode from all possible combinations between available modulations, data rates and antenna ports (if EUT with antenna diversity architecture).
- Following channel(s) was (were) selected for the final test as listed below.

MODE	AVAILABLE CHANNEL	TESTED CHANNEL	MODULATION TECHNOLOGY	MODULATION TYPE	DATA RATE (Mbps)
For 2.4 GHz 802.11n (HT20)	1 to 11	6	OFDM	BPSK	6.5
For 5 GHz 802.11n (HT40)	151 to 159	159	OFDM	BPSK	13.5

#### **RADIATED EMISSION TEST (BELOW 1 GHz):**

- Pre-Scan has been conducted to determine the worst-case mode from all possible combinations between available modulations, data rates and antenna ports (if EUT with antenna diversity architecture).
- Following channel(s) was (were) selected for the final test as listed below.

MODE	AVAILABLE CHANNEL	TESTED CHANNEL	MODULATION TECHNOLOGY	MODULATION TYPE	DATA RATE (Mbps)
For 2.4 GHz 802.11n (HT20)	1 to 11	6	OFDM	BPSK	6.5
For 5 GHz 802.11n (HT40)	151 to 159	159	OFDM	BPSK	13.5



A D T

### **RADIATED EMISSION TEST (ABOVE 1 GHz):**

- Pre-Scan has been conducted to determine the worst-case mode from all possible combinations between available modulations, data rates and antenna ports (if EUT with antenna diversity architecture).
- Following channel(s) was (were) selected for the final test as listed below.

MODE	AVAILABLE CHANNEL	TESTED CHANNEL	MODULATION TECHNOLOGY	MODULATION TYPE	DATA RATE (Mbps)
802.11b	1 to 11	1, 6, 11	DSSS	DBPSK	1
802.11g	1 to 11	1, 6, 11	OFDM	BPSK	6
For 2.4 GHz 802.11n (HT20)	1 to 11	1, 6, 11	OFDM	BPSK	6.5
For 2.4 GHz 802.11n (HT40)	3 to 9	3, 6, 9	OFDM	BPSK	13.5
802.11a	149 to 165	149, 157, 165	OFDM	BPSK	6
For 5 GHz 802.11n (HT20)	149 to 165	149, 157, 165	OFDM	BPSK	6.5
For 5 GHz 802.11n (HT40)	151 to 159	151, 159	OFDM	BPSK	13.5
For 5 GHz 802.11ac (VHT80)	155	155	OFDM	BPSK	29.3

### **ANTENNA PORT CONDUCTED MEASUREMENT:**

- Pre-Scan has been conducted to determine the worst-case mode from all possible combinations between available modulations, data rates and antenna ports (if EUT with antenna diversity architecture).
- Following channel(s) was (were) selected for the final test as listed below.

MODE	AVAILABLE CHANNEL	TESTED CHANNEL	MODULATION TECHNOLOGY	MODULATION TYPE	DATA RATE (Mbps)
802.11b	1 to 11	1, 6, 11	DSSS	DBPSK	1
802.11g	1 to 11	1, 6, 11	OFDM	BPSK	6
For 2.4 GHz 802.11n (HT20)	1 to 11	1, 6, 11	OFDM	BPSK	6.5
For 2.4 GHz 802.11n (HT40)	3 to 9	3, 6, 9	OFDM	BPSK	13.5
802.11a	149 to 165	149, 157, 165	OFDM	BPSK	6
For 5 GHz 802.11n (HT20)	149 to 165	149, 157, 165	OFDM	BPSK	6.5
For 5 GHz 802.11n (HT40)	151 to 159	151, 159	OFDM	BPSK	13.5
For 5 GHz 802.11ac (VHT80)	155	155	OFDM	BPSK	29.3



A D T

**CONDUCTED OUT-BAND EMISSION MEASUREMENT:**

- Pre-Scan has been conducted to determine the worst-case mode from all possible combinations between available modulations, data rates and antenna ports (if EUT with antenna diversity architecture).
- Following channel(s) was (were) selected for the final test as listed below.

MODE	AVAILABLE CHANNEL	TESTED CHANNEL	MODULATION TECHNOLOGY	MODULATION TYPE	DATA RATE (Mbps)
802.11b	1 to 11	1, 6, 11	DSSS	DBPSK	1
802.11g	1 to 11	1, 6, 11	OFDM	BPSK	6
For 2.4 GHz 802.11n (HT20)	1 to 11	1, 6, 11	OFDM	BPSK	6.5
For 2.4 GHz 802.11n (HT40)	3 to 9	3, 6, 9	OFDM	BPSK	13.5
802.11a	149 to 165	149, 157, 165	OFDM	BPSK	6
For 5 GHz 802.11n (HT20)	149 to 165	149, 157, 165	OFDM	BPSK	6.5
For 5 GHz 802.11n (HT40)	151 to 159	151, 159	OFDM	BPSK	13.5
For 5 GHz 802.11ac (VHT80)	155	155	OFDM	BPSK	29.3

**TEST CONDITION:**

APPLICABLE TO	ENVIRONMENTAL CONDITIONS	INPUT POWER	TESTED BY
PLC	26deg. C, 66%RH	120Vac, 60Hz	JyunChun Lin
	25deg. C, 58%RH	120Vac, 60Hz	Scott Chen
RE<1G	25deg. C, 70%RH	120Vac, 60Hz	Andy Ho
RE <sup>3</sup> 1G	30deg. C, 70%RH	120Vac, 60Hz	Chilin Lee
APCM	25deg. C, 60%RH	120Vac, 60Hz	James Chan
OB	25deg. C, 60%RH	120Vac, 60Hz	James Chan



### 3.3 GENERAL DESCRIPTION OF APPLIED STANDARDS

The EUT is a RF product. According to the specifications of the manufacturer, it must comply with the requirements of the following standards:

**FCC Part 15, Subpart C. (15.247)**

**558074 D01 DTS Meas Guidance v03r01**

**662911 D01 Multiple Transmitter Output v01 r02**

**ANSI C63.10-2009**

All test items have been performed and recorded as per the above standards.

**Note:** The EUT has been verified to comply with the requirements of FCC Part 15, Subpart B, Class B (DoC). The test report has been issued separately.

### 3.4 DUTY CYCLE OF TEST SIGNAL

If duty cycle of test signal is > 98 %, duty factor is not required.

If duty cycle of test signal is < 98%, duty factor shall be considered.

**802.11b**: Duty cycle = 1.422 ms/1.438 ms = 0.989

**802.11g**: Duty cycle = 2.46 ms/2.438 ms = 0.991

**802.11n (HT20)**: Duty cycle = 1.917 ms/1.936 ms = 0.99

**802.11n (HT40)**: Duty cycle = 0.941 ms/0.962 ms = 0.978, Duty factor =  $10 * \log(1/0.978) = 0.1$

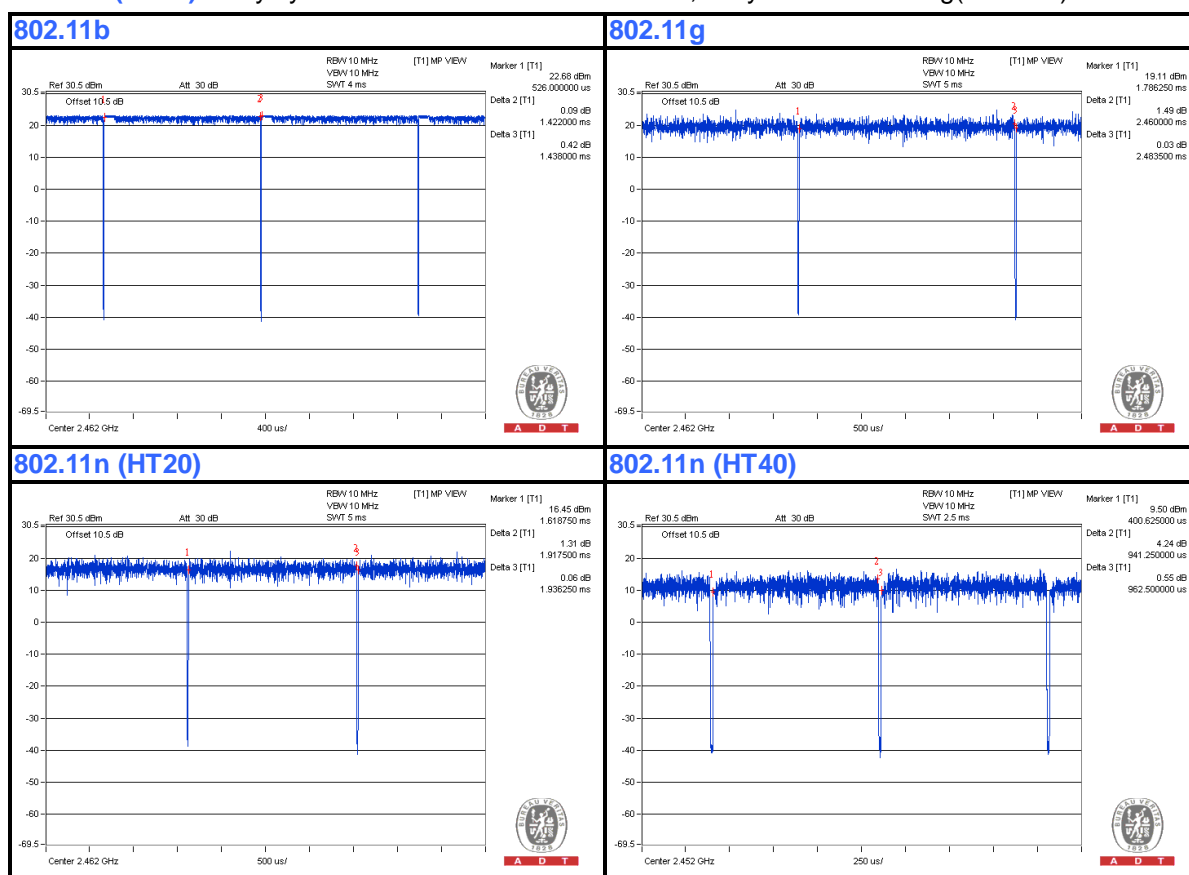



A D T

**802.11a:** Duty cycle = 2.059 ms/2.077 ms = 0.991

**802.11n (HT20):** Duty cycle = 2.041 ms/2.062 ms = 0.99

**802.11n (HT40):** Duty cycle = 1.002 ms/1.021 ms = 0.981

**802.11ac (VHT80):** Duty cycle = 0.487 ms/0.505 ms = 0.964, Duty factor =  $10 * \log(1/0.964) = 0.16$

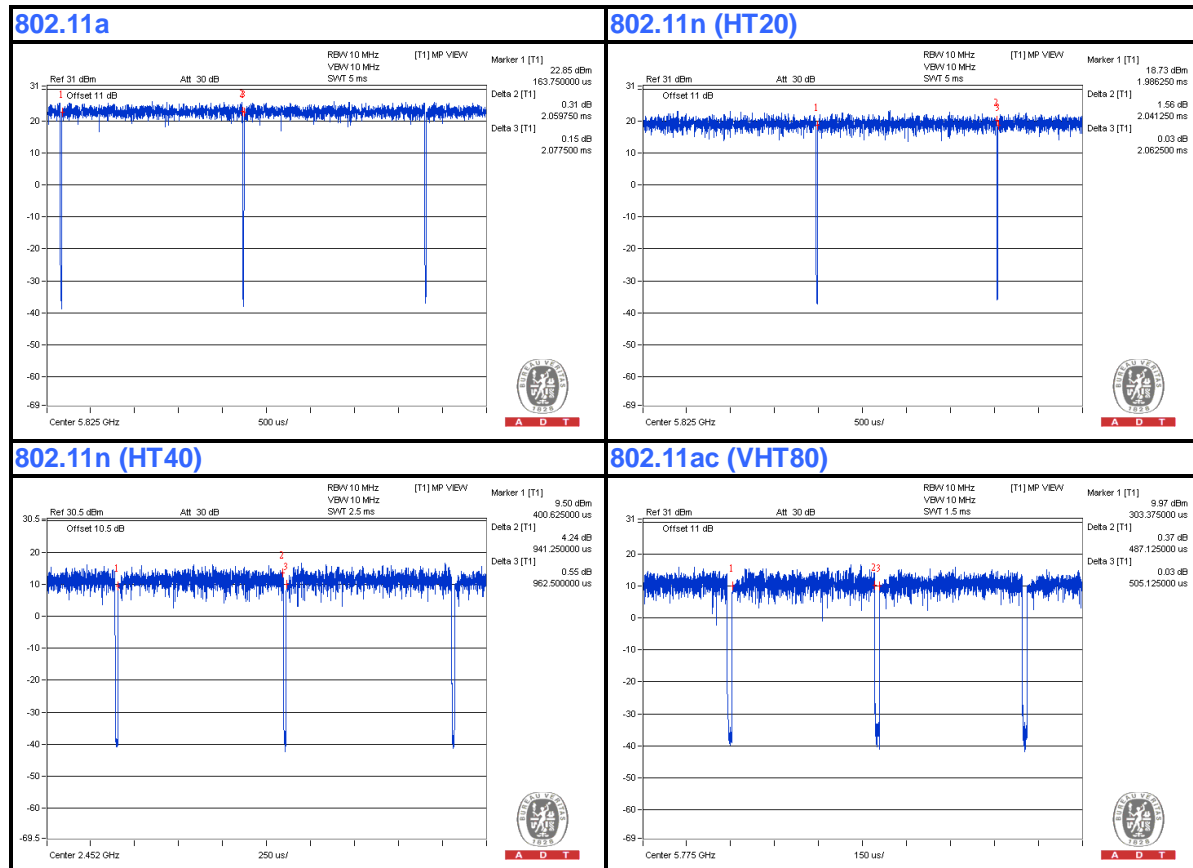



A D T

### 3.5 DESCRIPTION OF SUPPORT UNITS

The EUT has been tested as an independent unit together with other necessary accessories or support units. The following support units or accessories were used to form a representative test configuration during the tests.

NO.	PRODUCT	BRAND	MODEL NO.	SERIAL NO.	FCC ID
1	NOTEBOOK COMPUTER	DELL	PP32LA	FSLB32S	FCC DoC
2	NOTEBOOK COMPUTER	DELL	PP32LA	GSLB32S	FCC DoC
3	External Hard Drive	WD	WDBACW0010H BK-SESN	WXK1A51E5819	FCC DoC
4	HUB	ZyXEL	ES-116P	S060H02000215	FCC DoC

NO.	SIGNAL CABLE DESCRIPTION OF THE ABOVE SUPPORT UNITS
1	UTP Cable, 10m
2	UTP Cable, 10m
3	USB Cable, 0.6m
4	UTP Cable, 10m

**NOTE:** All power cords of the above support units are non shielded (1.8m).

### 3.6 CONFIGURATION OF SYSTEM UNDER TEST

For Conducted Emission (Mode 1~2) / Radiated Emission test:

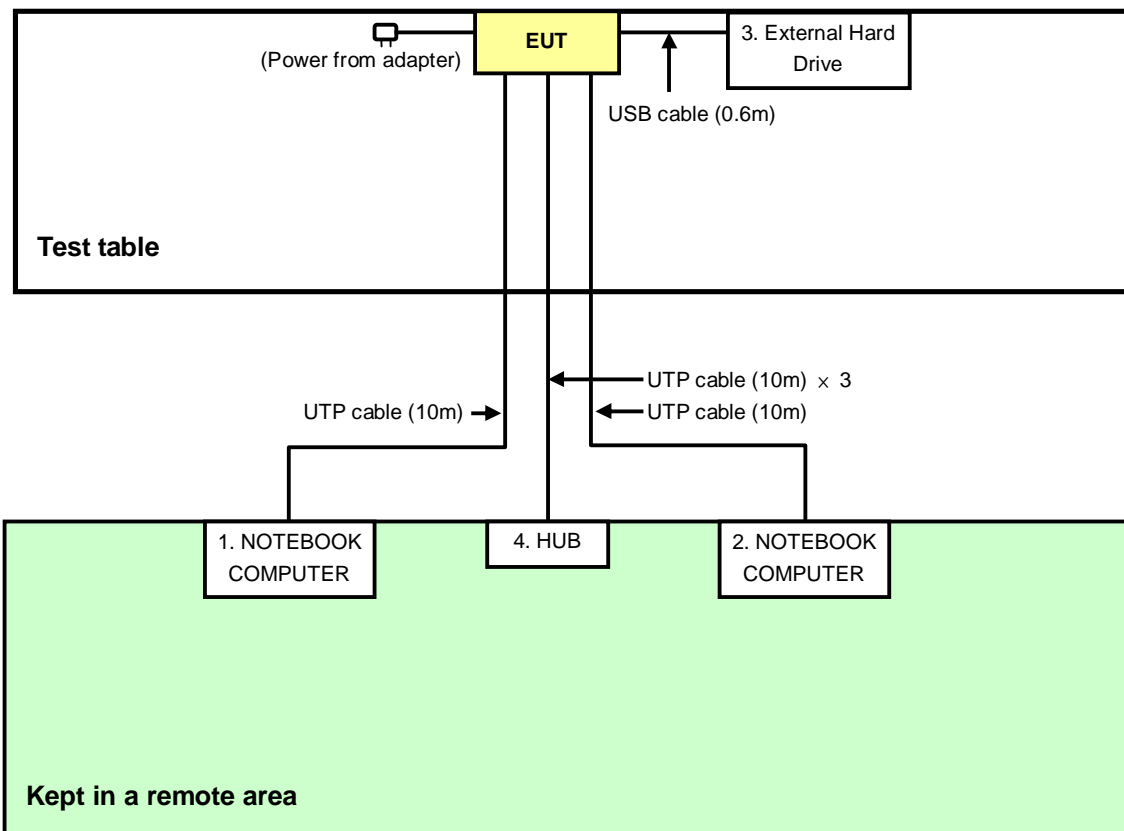

**For Conducted Emission (Mode 3~4) test:**

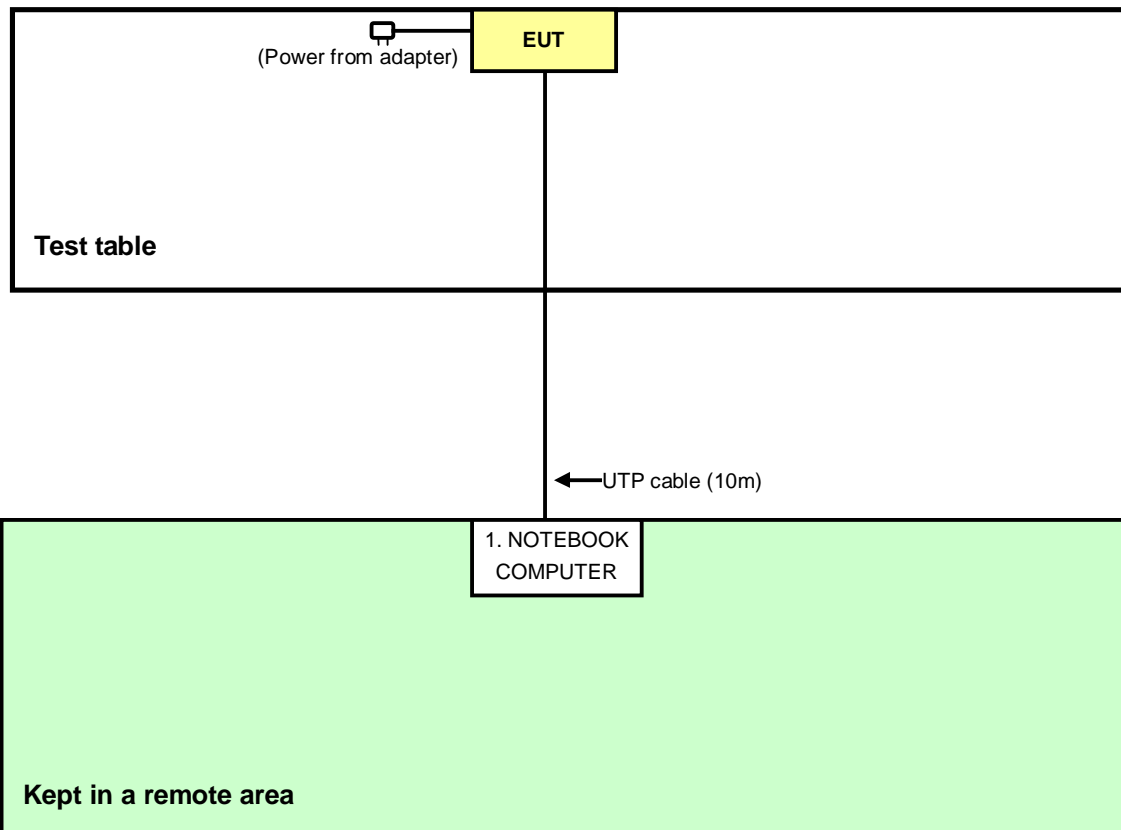

## 4. TEST TYPES AND RESULTS (FOR 2.4GHz, 2.400 ~ 2.4835GHz Band)

### 4.1 CONDUCTED EMISSION MEASUREMENT

#### 4.1.1 LIMITS OF CONDUCTED EMISSION MEASUREMENT

FREQUENCY OF EMISSION (MHz)	CONDUCTED LIMIT (dB $\mu$ V)	
	Quasi-peak	Average
0.15-0.5	66 to 56	56 to 46
0.5-5	56	46
5-30	60	50

- NOTE:**
1. The lower limit shall apply at the transition frequencies.
  2. The limit decreases in line with the logarithm of the frequency in the range of 0.15 to 0.50 MHz.

#### 4.1.2 TEST INSTRUMENTS

DESCRIPTION & MANUFACTURER	MODEL NO.	SERIAL NO.	CALIBRATED DATE	CALIBRATED UNTIL
Test Receiver	ESCS 30	100375	Mar. 08, 2013	Mar. 07, 2014
Line-Impedance Stabilization Network (for EUT) SCHWARZBECK	NSLK8127	8127-522	Sep. 06, 2012	Sep. 05, 2013
Line-Impedance Stabilization Network (for Peripheral)	ENV216	100072	June 07, 2013	June 06, 2014
RF Cable (JYEBAO)	5DFB	COCCAB-001	Mar. 11, 2013	Mar. 10, 2014
50 ohms Terminator	50	EMC-3	Sep. 25, 2012	Sep. 24, 2013
Software ADT	BV ADT_Cond_V7.3.7.3	NA	NA	NA

**Note:**

1. The calibration interval of the above test instruments is 12 months and the calibrations are traceable to NML/ROC and NIST/USA.
2. The test was performed in Shielded Room No. C.
3. The VCCI Con C Registration No. is C-3611.
4. Tested Date: July 29 and Aug. 07, 2013

#### 4.1.3 TEST PROCEDURES

- a. The EUT was placed 0.4 meters from the conducting wall of the shielded room with EUT being connected to the power mains through a line impedance stabilization network (LISN). Other support units were connected to the power mains through another LISN.
- b. The two LISNs provide 50 ohm/ 50uH of coupling impedance for the measuring instrument.
- c. Both lines of the power mains connected to the EUT were checked for maximum conducted interference.
- d. The frequency range from 150kHz to 30MHz was searched. Emission levels under (Limit - 20dB) were not recorded.

#### NOTE:

1. The resolution bandwidth of test receiver is 9kHz for Quasi-peak detection (QP) & Average detection (AV).

#### 4.1.4 DEVIATION FROM TEST STANDARD

No deviation

#### 4.1.5 TEST SETUP

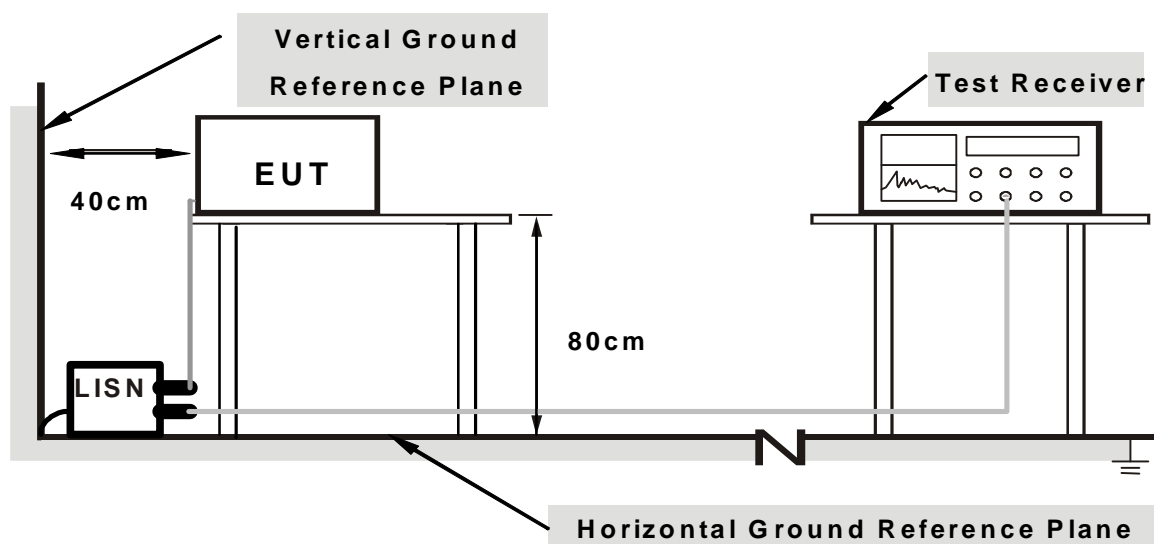

**Note: 1. Support units were connected to second LISN.**

For the actual test configuration, please refer to the related item – Photographs of the Test Configuration.





A D T

#### 4.1.6 EUT OPERATING CONDITIONS

1. Turn on the power of EUT.
2. The communication partner run test program “Mtool 1.0.0.9.exe” to enable EUT under transmission/receiving condition continuously at specific channel frequency.

### 4.1.7 TEST RESULTS (MODE 1)

<b>PHASE</b>	Line (L)	<b>DETECTOR FUNCTION</b>	Quasi-Peak (QP) / Average (AV)
--------------	----------	--------------------------	--------------------------------

No	Freq. [MHz]	Corr. Factor (dB)	Reading Value [dB (uV)]		Emission Level [dB (uV)]		Limit [dB (uV)]		Margin (dB)	
			Q.P.	AV.	Q.P.	AV.	Q.P.	AV.	Q.P.	AV.
1	0.15000	0.13	53.89	41.21	54.02	41.34	66.00	56.00	-11.98	-14.66
2	0.40391	0.20	40.44	30.53	40.64	30.73	57.77	47.77	-17.13	-17.04
<b>3</b>	<b>0.48984</b>	<b>0.21</b>	<b>45.42</b>	<b>37.13</b>	<b>45.63</b>	<b>37.34</b>	<b>56.17</b>	<b>46.17</b>	<b>-10.54</b>	<b>-8.83</b>
4	0.66563	0.22	40.35	31.90	40.57	32.12	56.00	46.00	-15.43	-13.88
5	0.96641	0.25	38.04	29.84	38.29	30.09	56.00	46.00	-17.71	-15.91
6	4.28906	0.49	35.26	29.00	35.75	29.49	56.00	46.00	-20.25	-16.51

#### REMARKS:

1. Q.P. and AV. are abbreviations of quasi-peak and average individually.
2. The emission levels of other frequencies were very low against the limit.
3. Margin value = Emission Level – Limit value
4. Correction Factor = Insertion loss + Cable loss
5. Emission Level = Correction Factor + Reading Value

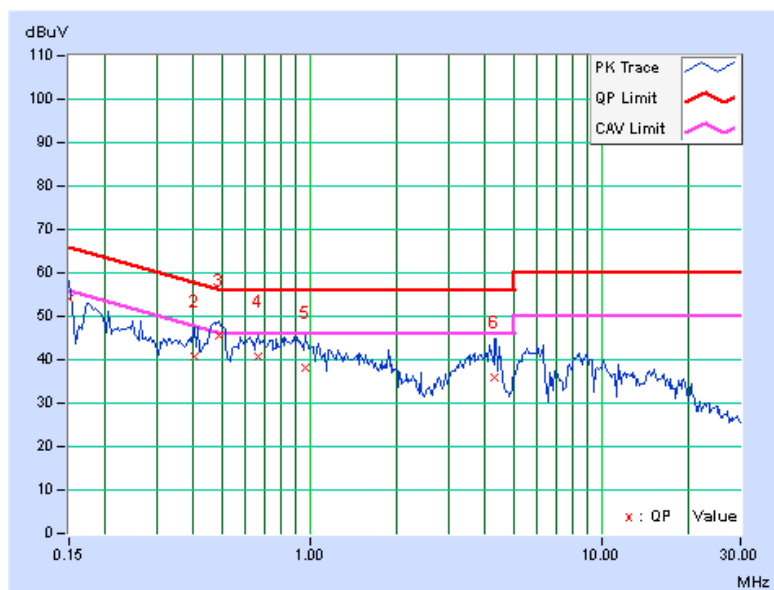

<b>PHASE</b>	Neutral (N)	<b>DETECTOR FUNCTION</b>	Quasi-Peak (QP) / Average (AV)
--------------	-------------	--------------------------	--------------------------------

No	Freq.	Corr.	Reading Value		Emission Level		Limit		Margin	
	[MHz]	Factor	[dB (uV)]		[dB (uV)]		[dB (uV)]		(dB)	
		(dB)	Q.P.	AV.	Q.P.	AV.	Q.P.	AV.	Q.P.	AV.
1	0.15000	0.11	53.48	38.92	53.59	39.03	66.00	56.00	-12.41	-16.97
2	0.18125	0.12	48.68	39.42	48.80	39.54	64.43	54.43	-15.63	-14.89
3	0.45078	0.19	39.32	30.49	39.51	30.68	56.86	46.86	-17.35	-16.18
4	0.53672	0.20	40.24	32.75	40.44	32.95	56.00	46.00	-15.56	-13.05
5	1.69141	0.28	36.26	30.15	36.54	30.43	56.00	46.00	-19.46	-15.57
6	14.89453	0.96	38.37	33.25	39.33	34.21	60.00	50.00	-20.67	-15.79

**REMARKS:**

1. Q.P. and AV. are abbreviations of quasi-peak and average individually.
2. The emission levels of other frequencies were very low against the limit.
3. Margin value = Emission Level – Limit value
4. Correction Factor = Insertion loss + Cable loss
5. Emission Level = Correction Factor + Reading Value

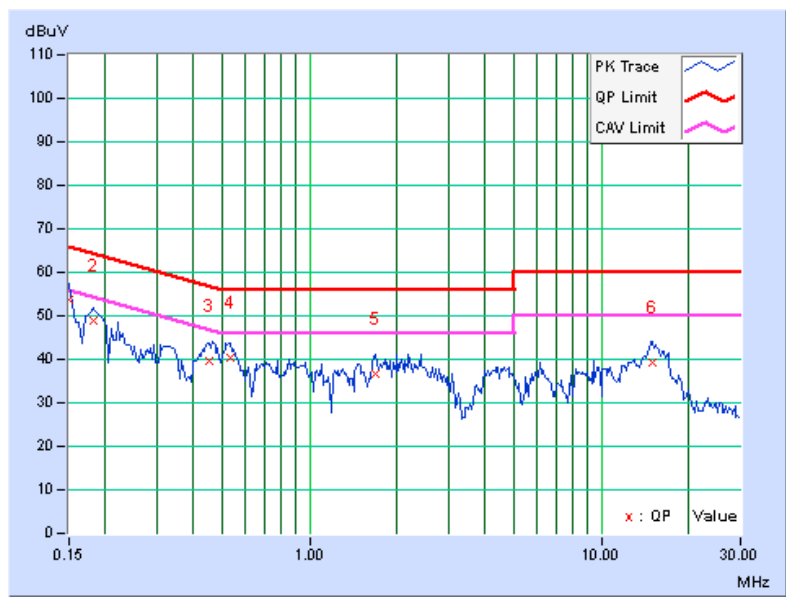

#### 4.1.8 TEST RESULTS (MODE 2)

<b>PHASE</b>	Line (L)	<b>DETECTOR FUNCTION</b>	Quasi-Peak (QP) / Average (AV)
--------------	----------	--------------------------	--------------------------------

No	Freq. [MHz]	Corr. Factor (dB)	Reading Value [dB (uV)]		Emission Level [dB (uV)]		Limit [dB (uV)]		Margin (dB)	
			Q.P.	AV.	Q.P.	AV.	Q.P.	AV.	Q.P.	AV.
1	0.15000	0.13	54.88	44.77	55.01	44.90	66.00	56.00	-10.99	-11.10
2	0.19687	0.15	48.58	37.91	48.73	38.06	63.74	53.74	-15.01	-15.68
3	0.25547	0.16	43.41	27.68	43.57	27.84	61.58	51.58	-18.00	-23.73
4	0.31797	0.18	40.44	23.90	40.62	24.08	59.76	49.76	-19.14	-25.68
5	0.40781	0.20	37.48	22.55	37.68	22.75	57.69	47.69	-20.01	-24.94
6	5.60156	0.58	34.04	25.42	34.62	26.00	60.00	50.00	-25.38	-24.00

#### REMARKS:

1. Q.P. and AV. are abbreviations of quasi-peak and average individually.
2. The emission levels of other frequencies were very low against the limit.
3. Margin value = Emission Level – Limit value
4. Correction Factor = Insertion loss + Cable loss
5. Emission Level = Correction Factor + Reading Value

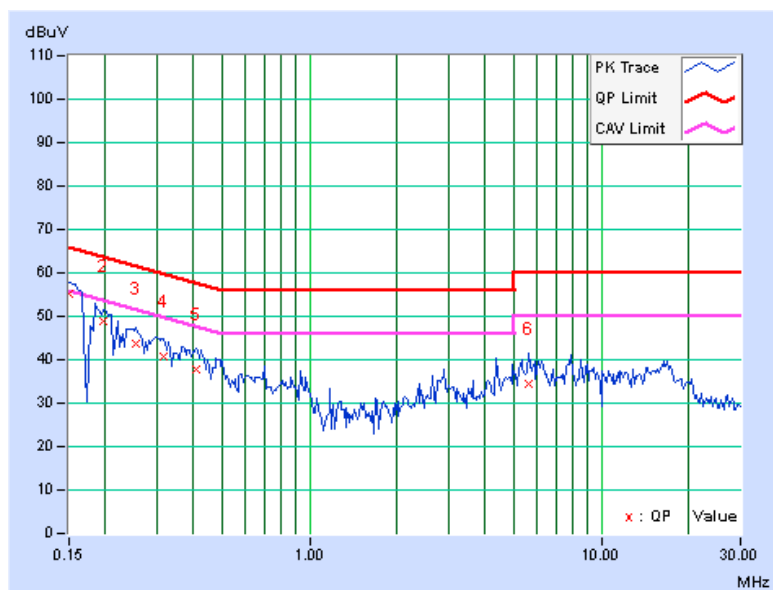

<b>PHASE</b>	Neutral (N)	<b>DETECTOR FUNCTION</b>	Quasi-Peak (QP) / Average (AV)
--------------	-------------	--------------------------	--------------------------------

No	Freq.	Corr.	Reading Value		Emission Level		Limit		Margin	
	[MHz]	(dB)	Q.P.	AV.	Q.P.	AV.	Q.P.	AV.	Q.P.	AV.
1	0.15000	0.11	55.29	44.33	55.40	44.44	66.00	56.00	-10.60	-11.56
2	0.18125	0.12	46.45	25.32	46.57	25.44	64.43	54.43	-17.86	-28.99
3	0.25156	0.15	43.64	30.53	43.79	30.68	61.71	51.71	-17.92	-21.03
4	0.32188	0.17	39.45	22.21	39.62	22.38	59.66	49.66	-20.04	-27.28
5	2.60547	0.34	29.56	21.24	29.90	21.58	56.00	46.00	-26.10	-24.42
6	6.25781	0.55	30.33	22.40	30.88	22.95	60.00	50.00	-29.12	-27.05

**REMARKS:**

1. Q.P. and AV. are abbreviations of quasi-peak and average individually.
2. The emission levels of other frequencies were very low against the limit.
3. Margin value = Emission Level – Limit value
4. Correction Factor = Insertion loss + Cable loss
5. Emission Level = Correction Factor + Reading Value

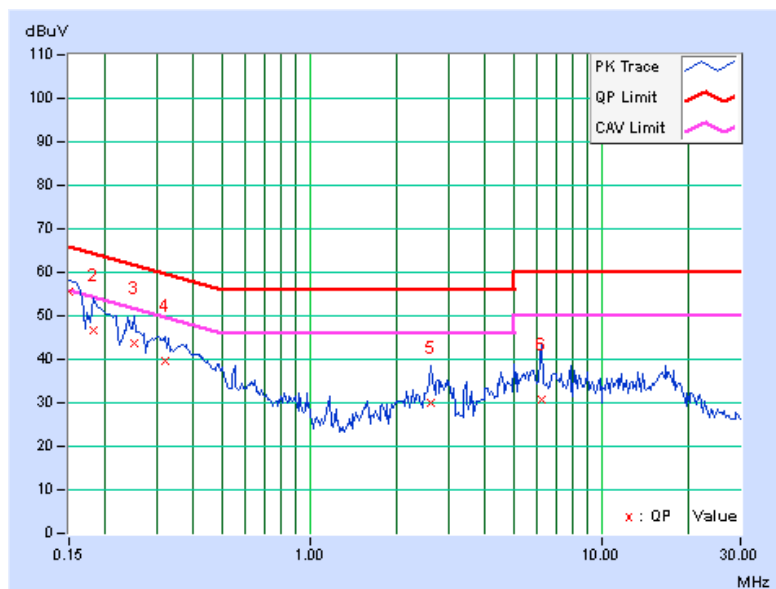



A D T

#### 4.1.9 TEST RESULTS (MODE 3)

<b>PHASE</b>	Line (L)	<b>DETECTOR FUNCTION</b>	Quasi-Peak (QP) / Average (AV)
--------------	----------	--------------------------	--------------------------------

No	Freq. [MHz]	Corr. Factor (dB)	Reading Value [dB (uV)]		Emission Level [dB (uV)]		Limit [dB (uV)]		Margin (dB)	
			Q.P.	AV.	Q.P.	AV.	Q.P.	AV.	Q.P.	AV.
1	0.15000	0.13	52.23	38.16	52.36	38.29	66.00	56.00	-13.64	-17.71
2	0.17734	0.14	46.08	30.82	46.22	30.96	64.61	54.61	-18.39	-23.65
3	0.24375	0.16	34.23	16.55	34.39	16.71	61.97	51.97	-27.58	-35.26
4	0.49375	0.21	33.07	22.75	33.28	22.96	56.10	46.10	-22.83	-23.15
5	5.07813	0.55	28.08	19.78	28.63	20.33	60.00	50.00	-31.37	-29.67
6	14.83594	1.19	33.38	27.94	34.57	29.13	60.00	50.00	-25.43	-20.87

#### REMARKS:

1. Q.P. and AV. are abbreviations of quasi-peak and average individually.
2. The emission levels of other frequencies were very low against the limit.
3. Margin value = Emission Level – Limit value
4. Correction Factor = Insertion loss + Cable loss
5. Emission Level = Correction Factor + Reading Value

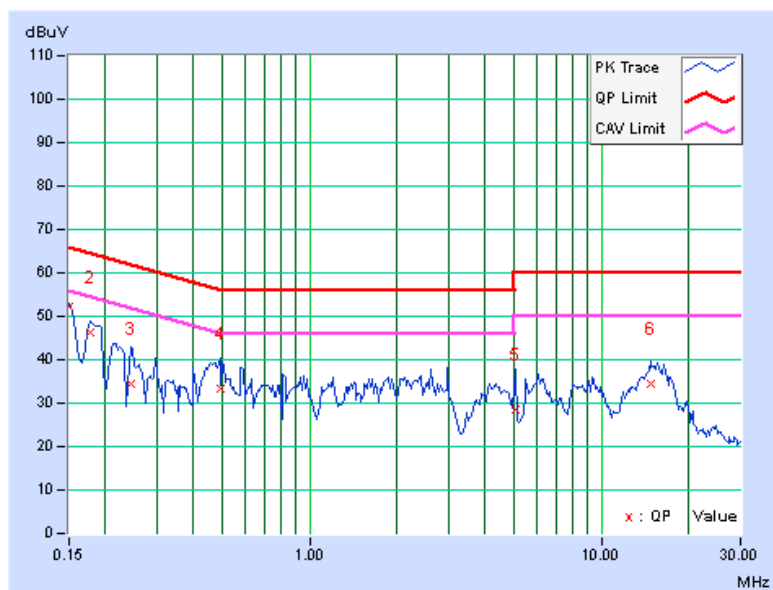

<b>PHASE</b>	Neutral (N)	<b>DETECTOR FUNCTION</b>	Quasi-Peak (QP) / Average (AV)
--------------	-------------	--------------------------	--------------------------------

No	Freq.	Corr.	Reading Value		Emission Level		Limit		Margin	
	[MHz]	(dB)	Q.P.	AV.	Q.P.	AV.	Q.P.	AV.	Q.P.	AV.
1	0.15000	0.11	55.20	42.79	55.31	42.90	66.00	56.00	-10.69	-13.10
2	0.44297	0.19	38.20	24.44	38.39	24.63	57.01	47.01	-18.61	-22.37
3	0.54453	0.20	37.31	27.41	37.51	27.61	56.00	46.00	-18.49	-18.39
4	3.91406	0.42	34.89	28.43	35.31	28.85	56.00	46.00	-20.69	-17.15
5	6.16016	0.54	33.83	25.70	34.37	26.24	60.00	50.00	-25.63	-23.76
6	9.09375	0.69	33.64	26.25	34.33	26.94	60.00	50.00	-25.67	-23.06

**REMARKS:**

1. Q.P. and AV. are abbreviations of quasi-peak and average individually.
2. The emission levels of other frequencies were very low against the limit.
3. Margin value = Emission Level – Limit value
4. Correction Factor = Insertion loss + Cable loss
5. Emission Level = Correction Factor + Reading Value

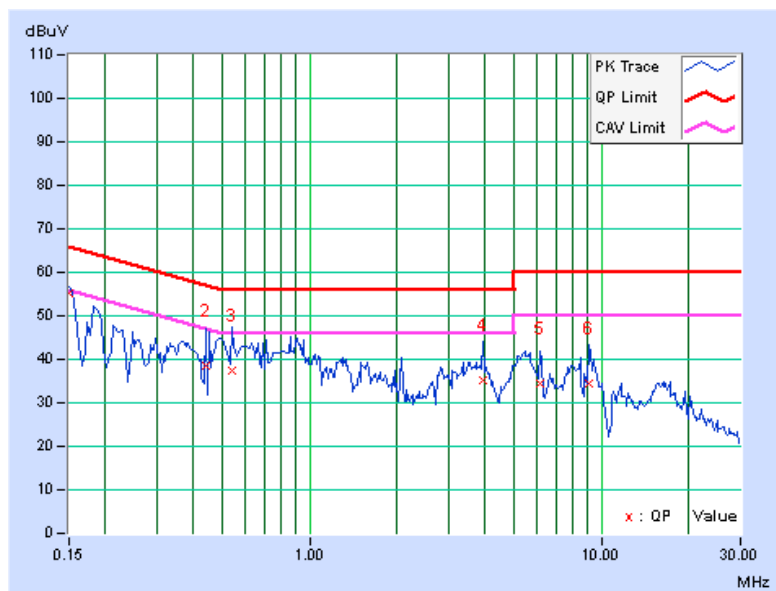



A D T

#### 4.1.10 TEST RESULTS (MODE 4)

<b>PHASE</b>	Line (L)	<b>DETECTOR FUNCTION</b>	Quasi-Peak (QP) / Average (AV)
--------------	----------	--------------------------	--------------------------------

No	Freq. [MHz]	Corr. Factor (dB)	Reading Value [dB (uV)]		Emission Level [dB (uV)]		Limit [dB (uV)]		Margin (dB)	
			Q.P.	AV.	Q.P.	AV.	Q.P.	AV.	Q.P.	AV.
1	0.16172	0.13	51.56	34.78	51.69	34.91	65.38	55.38	-13.68	-20.46
2	0.18125	0.14	47.58	32.73	47.72	32.87	64.43	54.43	-16.71	-21.56
3	0.38438	0.20	36.51	20.75	36.71	20.95	58.18	48.18	-21.48	-27.24
4	2.91797	0.40	34.78	26.55	35.18	26.95	56.00	46.00	-20.82	-19.05
5	6.05078	0.62	34.80	25.70	35.42	26.32	60.00	50.00	-24.58	-23.68
6	16.28906	1.27	32.10	25.15	33.37	26.42	60.00	50.00	-26.63	-23.58

#### REMARKS:

1. Q.P. and AV. are abbreviations of quasi-peak and average individually.
2. The emission levels of other frequencies were very low against the limit.
3. Margin value = Emission Level – Limit value
4. Correction Factor = Insertion loss + Cable loss
5. Emission Level = Correction Factor + Reading Value

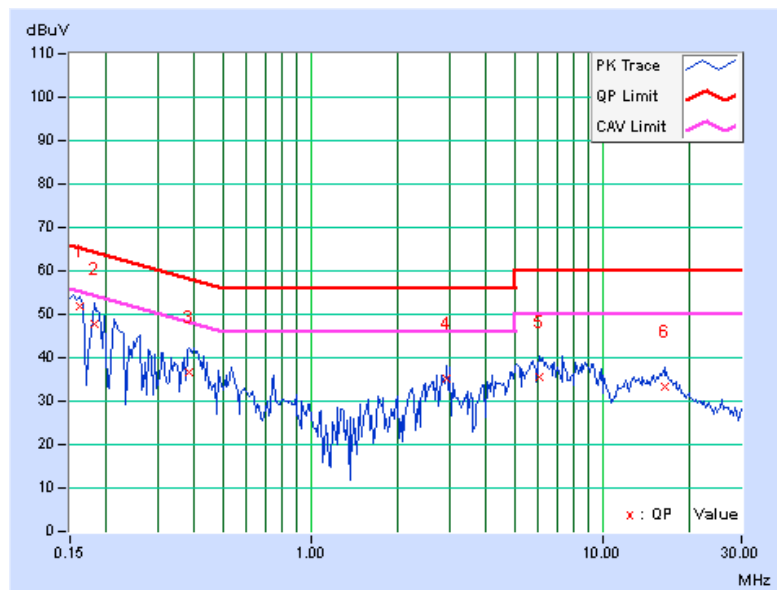



<b>PHASE</b>	Neutral (N)	<b>DETECTOR FUNCTION</b>	Quasi-Peak (QP) / Average (AV)
--------------	-------------	--------------------------	--------------------------------

No	Freq. [MHz]	Corr. Factor (dB)	Reading Value [dB (uV)]		Emission Level [dB (uV)]		Limit [dB (uV)]		Margin (dB)	
			Q.P.	AV.	Q.P.	AV.	Q.P.	AV.	Q.P.	AV.
1	0.15781	0.11	52.27	37.51	52.38	37.62	65.58	55.58	-13.20	-17.96
2	0.18516	0.12	48.95	35.78	49.07	35.90	64.25	54.25	-15.18	-18.35
3	0.25547	0.15	39.15	18.75	39.30	18.90	61.58	51.58	-22.28	-32.68
4	0.38828	0.19	36.07	20.67	36.26	20.86	58.10	48.10	-21.84	-27.24
5	0.74375	0.21	28.43	15.86	28.64	16.07	56.00	46.00	-27.36	-29.93
6	6.25391	0.55	28.64	20.06	29.19	20.61	60.00	50.00	-30.81	-29.39

**REMARKS:**

1. Q.P. and AV. are abbreviations of quasi-peak and average individually.
2. The emission levels of other frequencies were very low against the limit.
3. Margin value = Emission Level – Limit value
4. Correction Factor = Insertion loss + Cable loss
5. Emission Level = Correction Factor + Reading Value

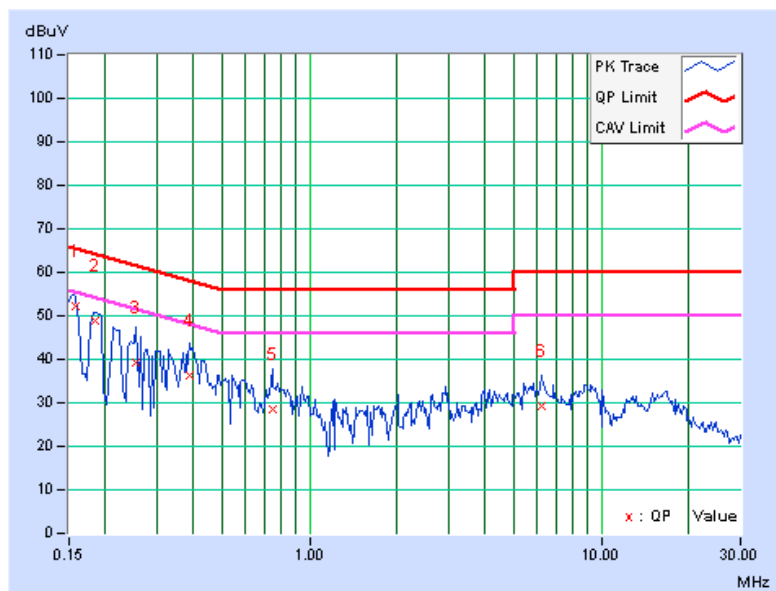

## 4.2 RADIATED EMISSION AND BANDEGE MEASUREMENT

### 4.2.1 LIMITS OF RADIATED EMISSION AND BANDEGE MEASUREMENT

Radiated emissions which fall in the restricted bands must comply with the radiated emission limits specified as below table. Other emissions shall be at least 30dB below the highest level of the desired power:

Frequencies (MHz)	Field strength (microvolts/meter)	Measurement distance (meters)
0.009-0.490	2400/F(kHz)	300
0.490-1.705	24000/F(kHz)	30
1.705-30.0	30	30
30-88	100	3
88-216	150	3
216-960	200	3
Above 960	500	3

**NOTE:**

1. The lower limit shall apply at the transition frequencies.
2. Emission level (dBuV/m) = 20 log Emission level (uV/m).
3. For frequencies above 1000MHz, the field strength limits are based on average detector, however, the peak field strength of any emission shall not exceed the maximum permitted average limits, specified above by more than 20dB under any condition of modulation.

## 4.2.2 TEST INSTRUMENTS

For below 1GHz test:

DESCRIPTION & MANUFACTURER	MODEL NO.	SERIAL NO.	CALIBRATED DATE	CALIBRATED UNTIL
Spectrum Analyzer Agilent	E4446A	MY48250253	Sep. 03, 2012	Sep. 02, 2013
MXE EMI Receiver Agilent	N9038A	MY50010156	Jan. 16, 2013	Jan. 15, 2014
Pre-Amplifier Mini-Circuits	ZFL-1000VH2 B	AMP-ZFL-04	Nov. 14, 2012	Nov. 13, 2013
Pre-Amplifier Agilent	8449B	3008A01923	Oct. 30, 2012	Oct. 29, 2013
Pre-Amplifier SPACEK LABS	SLKKa-48-6	9K16	Nov. 14, 2012	Nov. 13, 2013
Trilog Broadband Antenna SCHWARZBECK	VULB 9168	9168-361	Mar. 25, 2013	Mar. 24, 2014
Horn_Antenna AISI	AIH.8018	0000220091110	Nov. 27, 2012	Nov. 26, 2013
Horn_Antenna SCHWARZBECK	BBHA 9170	9170-424	Oct. 12, 2012	Oct. 11, 2013
RF Cable	NA	RF104-205 RF104-207 RF104-202	Dec. 26, 2012	Dec. 25, 2013
RF Cable	NA	CHHCAB_001	Oct. 07, 2012	Oct. 06, 2013
Software	ADT_Radiated _V8.7.05	NA	NA	NA
Antenna Tower & Turn Table CT	NA	NA	NA	NA

**Note:**

1. The calibration interval of the above test instruments is 12 months and the calibrations are traceable to NML/ROC and NIST/USA.
2. The horn antenna, preamplifier (model: 8449B) are used only for the measurement of emission frequency above 1GHz if tested.
- 3 The test was performed in 966 Chamber No. H.
4. The FCC Site Registration No. is 797305.
- 5 The CANADA Site Registration No. is IC 7450H-3.
- 6 Tested Date: July 26, 2013



A D T

**For above 1GHz test:**

DESCRIPTION & MANUFACTURER	MODEL NO.	SERIAL NO.	CALIBRATED DATE	CALIBRATED UNTIL
Spectrum Analyzer Agilent	E4446A	MY48250253	Sep. 03, 2012	Sep. 02, 2013
MXE EMI Receiver Agilent	N9038A	MY51210105	Jan. 29,2013	Jan. 28,2014
Pre-Amplifier Mini-Circuits	ZFL-1000VH2 B	AMP-ZFL-03	Nov. 14, 2012	Nov. 13, 2013
Pre-Amplifier Agilent	8449B	3008A02578	June 25, 2013	June 24, 2014
Pre-Amplifier SPACEK LABS	SLKKa-48-6	9K16	Nov. 14, 2012	Nov. 13, 2013
Trilog Broadband Antenna SCHWARZBECK	VULB 9168	9168-360	Mar. 19, 2013	Mar. 18, 2014
Horn_Antenna AISI	AIH.8018	0000320091110	Nov. 19, 2012	Nov. 18, 2013
Horn_Antenna SCHWARZBECK	BBHA 9170	9170-424	Oct. 12, 2012	Oct. 11, 2013
RF Cable	NA	RF104-201 RF104-203 RF104-204	Dec. 25, 2012	Dec. 24, 2013
RF Cable	NA	CHGCAB_001	Oct. 06, 2012	Oct. 05, 2013
Software	ADT_Radiated _V8.7.05	NA	NA	NA
Antenna Tower & Turn Table CT	NA	NA	NA	NA

**Note:**

1. The calibration interval of the above test instruments is 12 months and the calibrations are traceable to NML/ROC and NIST/USA.
2. The horn antenna, preamplifier (model: 8449B) are used only for the measurement of emission frequency above 1GHz if tested.
3. The test was performed in 966 Chamber No. G.
4. The FCC Site Registration No. is 966073.
5. The VCCI Site Registration No. is G-137.
6. The CANADA Site Registration No. is IC 7450H-2.
7. Tested Date: Aug. 09, 2013

#### 4.2.3 TEST PROCEDURES

- a. The EUT was placed on the top of a rotating table 0.8 meters above the ground at 3 meter chamber room for test. The table was rotated 360 degrees to determine the position of the highest radiation.
- b. The EUT was set 3 meters away from the interference-receiving antenna, which was mounted on the top of a variable-height antenna tower.
- c. The height of antenna is varied from one meter to four meters above the ground to determine the maximum value of the field strength. Both horizontal and vertical polarizations of the antenna are set to make the measurement.
- d. For each suspected emission, the EUT was arranged to its worst case and then the antenna was tuned to heights from 1 meter to 4 meters and the rotatable table was turned from 0 degrees to 360 degrees to find the maximum reading.
- e. The test-receiver system was set to quasi-peak detect function and specified bandwidth with maximum hold mode when the test frequency is below 1 GHz.
- f. The test-receiver system was set to peak and average detect function and specified bandwidth with maximum hold mode when the test frequency is above 1 GHz. If the peak reading value also meets average limit, measurement with the average detector is unnecessary.

**NOTE:**

1. The resolution bandwidth and video bandwidth of test receiver/spectrum analyzer is 120kHz for Quasi-peak detection (QP) at frequency below 1GHz.
2. The resolution bandwidth of test receiver/spectrum analyzer is 1 MHz and the video bandwidth is 3 MHz for Peak detection (PK) at frequency above 1GHz.
3. The resolution bandwidth of test receiver/spectrum analyzer is 1 MHz and the video bandwidth is 10 Hz for Average detection (AV) at frequency above 1GHz.
4. All modes of operation were investigated and the worst-case emissions are reported.

#### 4.2.4 DEVIATION FROM TEST STANDARD

No deviation

#### 4.2.5 TEST SETUP

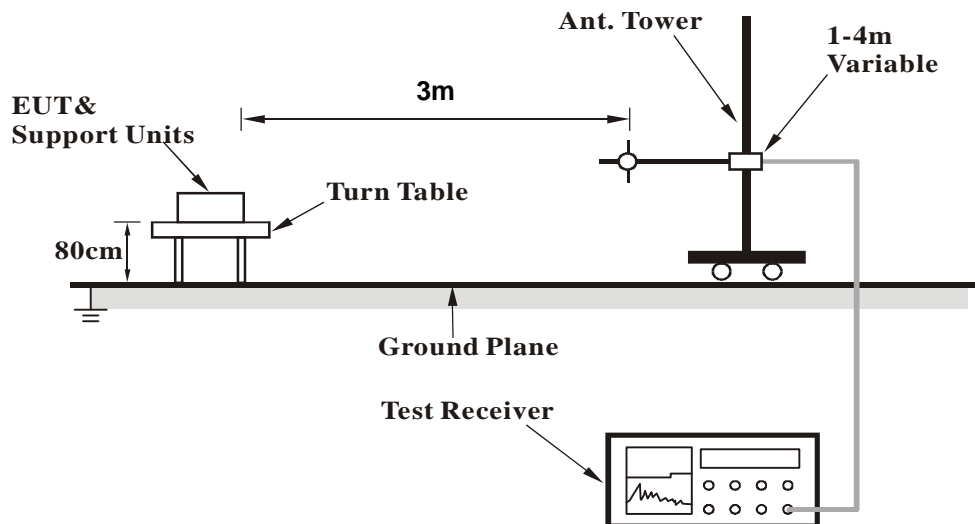

For the actual test configuration, please refer to the related item – Photographs of the Test Configuration.

#### 4.2.6 EUT OPERATING CONDITIONS

Same as 4.1.6

## 4.2.7 TEST RESULTS

### BELOW 1GHz WORST-CASE DATA

#### 802.11n (HT20)

<b>CHANNEL</b>	TX Channel 6	<b>DETECTOR FUNCTION</b>	Quasi-Peak (QP)
<b>FREQUENCY RANGE</b>	Below 1GHz		

ANTENNA POLARITY & TEST DISTANCE: HORIZONTAL AT 3 M								
NO.	FREQ. (MHz)	EMISSION LEVEL (dBuV/m)	LIMIT (dBuV/m)	MARGIN (dB)	ANTENNA HEIGHT (m)	TABLE ANGLE (Degree)	RAW VALUE (dBuV)	CORRECTION FACTOR (dB/m)
1	55.32	33.6 QP	40.0	-6.4	1.50 H	0	46.85	-13.21
2	106.44	33.5 QP	43.5	-10.0	1.00 H	111	50.11	-16.63
3	171.28	33.1 QP	43.5	-10.4	1.00 H	47	46.67	-13.56
4	275.56	37.8 QP	46.0	-8.3	1.00 H	55	50.88	-13.13
5	293.94	40.6 QP	46.0	-5.4	1.00 H	116	52.98	-12.42
6	408.74	35.1 QP	46.0	-10.9	1.50 H	22	44.87	-9.74
ANTENNA POLARITY & TEST DISTANCE: VERTICAL AT 3 M								
NO.	FREQ. (MHz)	EMISSION LEVEL (dBuV/m)	LIMIT (dBuV/m)	MARGIN (dB)	ANTENNA HEIGHT (m)	TABLE ANGLE (Degree)	RAW VALUE (dBuV)	CORRECTION FACTOR (dB/m)
1	41.19	32.8 QP	40.0	-7.2	1.00 V	246	46.61	-13.84
2	50.39	35.0 QP	40.0	-5.0	1.00 V	225	48.45	-13.49
3	300.58	39.0 QP	46.0	-7.0	1.00 V	106	51.22	-12.19
4	388.95	41.8 QP	46.0	-4.2	1.50 V	78	51.90	-10.08
5	407.43	41.0 QP	46.0	-5.0	1.50 V	102	50.81	-9.78
6	940.54	38.0 QP	46.0	-8.0	1.00 V	54	37.52	0.49

#### REMARKS:

1. Emission Level(dBuV/m) = Raw Value(dBuV) + Correction Factor(dB/m)
2. Correction Factor(dB/m) = Antenna Factor(dB/m) + Cable Factor(dB) – Pre-Amplifier Factor(dB)
3. The other emission levels were very low against the limit.
4. Margin value = Emission Level – Limit value



## ABOVE 1GHz DATA

### 802.11b

<b>CHANNEL</b>	TX Channel 1	<b>DETECTOR FUNCTION</b>	Peak (PK)
<b>FREQUENCY RANGE</b>	1GHz ~ 25GHz		Average (AV)

#### ANTENNA POLARITY & TEST DISTANCE: HORIZONTAL AT 3 M

NO.	FREQ. (MHz)	EMISSION LEVEL (dBuV/m)	LIMIT (dBuV/m)	MARGIN (dB)	ANTENNA HEIGHT (m)	TABLE ANGLE (Degree)	RAW VALUE (dBuV)	CORRECTION FACTOR (dB/m)
1	2331.00	58.4 PK	74.0	-15.6	1.02 H	277	25.74	32.66
2	2331.00	49.3 AV	54.0	-4.7	1.02 H	277	16.64	32.66
3	*2412.00	100.7 PK			1.01 H	323	67.73	32.97
4	*2412.00	98.2 AV			1.01 H	323	65.23	32.97
5	2500.00	49.9 PK	74.0	-24.1	1.77 H	128	16.63	33.27
6	2500.00	42.1 AV	54.0	-11.9	1.77 H	128	8.83	33.27
7	4824.00	54.4 PK	74.0	-19.6	1.40 H	315	13.62	40.78
8	4824.00	49.1 AV	54.0	-4.9	1.40 H	315	8.32	40.78

#### ANTENNA POLARITY & TEST DISTANCE: VERTICAL AT 3 M

NO.	FREQ. (MHz)	EMISSION LEVEL (dBuV/m)	LIMIT (dBuV/m)	MARGIN (dB)	ANTENNA HEIGHT (m)	TABLE ANGLE (Degree)	RAW VALUE (dBuV)	CORRECTION FACTOR (dB/m)
1	2331.00	61.8 PK	74.0	-12.2	1.00 V	178	29.14	32.66
2	2331.00	53.1 AV	54.0	-0.9	1.00 V	178	20.44	32.66
3	2390.00	59.9 PK	74.0	-14.1	1.18 V	222	27.01	32.89
4	2390.00	48.9 AV	54.0	-5.1	1.18 V	222	16.01	32.89
5	*2412.00	111.7 PK			1.18 V	222	78.73	32.97
6	*2412.00	109.3 AV			1.18 V	222	76.33	32.97
7	2500.00	57.1 PK	74.0	-16.9	1.08 V	85	23.83	33.27
8	2500.00	52.1 AV	54.0	-1.9	1.08 V	85	18.83	33.27
9	4824.00	56.5 PK	74.0	-17.5	1.17 V	277	15.72	40.78
10	4824.00	53.6 AV	54.0	-0.4	1.17 V	277	12.82	40.78

#### REMARKS:

1. Emission Level(dBuV/m) = Raw Value(dBuV) + Correction Factor(dB/m)
2. Correction Factor(dB/m) = Antenna Factor(dB/m) + Cable Factor(dB)  
– Pre-Amplifier Factor(dB)
3. The other emission levels were very low against the limit.
4. Margin value = Emission Level – Limit value
5. " \* ": Fundamental frequency.





<b>CHANNEL</b>	TX Channel 6	<b>DETECTOR FUNCTION</b>	Peak (PK)
<b>FREQUENCY RANGE</b>	1GHz ~ 25GHz		Average (AV)

**ANTENNA POLARITY & TEST DISTANCE: HORIZONTAL AT 3 M**

NO.	FREQ. (MHz)	EMISSION LEVEL (dBuV/m)	LIMIT (dBuV/m)	MARGIN (dB)	ANTENNA HEIGHT (m)	TABLE ANGLE (Degree)	RAW VALUE (dBuV)	CORRECTION FACTOR (dB/m)
1	*2437.00	101.5 PK			1.05 H	282	68.45	33.05
2	*2437.00	99.2 AV			1.05 H	282	66.15	33.05
3	4874.00	54.1 PK	74.0	-19.9	1.45 H	315	13.14	40.96
4	4874.00	48.9 AV	54.0	-5.1	1.45 H	315	7.94	40.96
5	7311.00	55.3 PK	74.0	-18.7	1.06 H	345	6.44	48.86
6	7311.00	44.4 AV	54.0	-9.6	1.06 H	345	-4.46	48.86

**ANTENNA POLARITY & TEST DISTANCE: VERTICAL AT 3 M**

NO.	FREQ. (MHz)	EMISSION LEVEL (dBuV/m)	LIMIT (dBuV/m)	MARGIN (dB)	ANTENNA HEIGHT (m)	TABLE ANGLE (Degree)	RAW VALUE (dBuV)	CORRECTION FACTOR (dB/m)
1	2357.00	62.4 PK	74.0	-11.6	1.00 V	167	29.64	32.76
2	2357.00	53.6 AV	54.0	-0.4	1.00 V	167	20.84	32.76
3	*2437.00	113.3 PK			1.17 V	223	80.25	33.05
4	*2437.00	110.6 AV			1.17 V	223	77.55	33.05
5	2483.50	57.2 PK	74.0	-16.8	1.17 V	223	23.99	33.21
6	2483.50	44.7 AV	54.0	-9.3	1.17 V	223	11.49	33.21
7	2500.00	57.5 PK	74.0	-16.5	1.08 V	86	24.23	33.27
8	2500.00	52.0 AV	54.0	-2.0	1.08 V	86	18.73	33.27
9	4874.00	56.4 PK	74.0	-17.6	1.17 V	260	15.44	40.96
10	4874.00	53.7 AV	54.0	-0.3	1.17 V	260	12.74	40.96
11	7311.00	57.2 PK	74.0	-16.8	1.25 V	265	8.34	48.86
12	7311.00	46.1 AV	54.0	-7.9	1.25 V	265	-2.76	48.86

**REMARKS:**

1. Emission Level(dBuV/m) = Raw Value(dBuV) + Correction Factor(dB/m)
2. Correction Factor(dB/m) = Antenna Factor(dB/m) + Cable Factor(dB)  
– Pre-Amplifier Factor(dB)
3. The other emission levels were very low against the limit.
4. Margin value = Emission Level – Limit value
5. " \* ": Fundamental frequency.



A D T

<b>CHANNEL</b>	TX Channel 11	<b>DETECTOR FUNCTION</b>	Peak (PK)
<b>FREQUENCY RANGE</b>	1GHz ~ 25GHz		Average (AV)

**ANTENNA POLARITY & TEST DISTANCE: HORIZONTAL AT 3 M**

NO.	FREQ. (MHz)	EMISSION LEVEL (dBuV/m)	LIMIT (dBuV/m)	MARGIN (dB)	ANTENNA HEIGHT (m)	TABLE ANGLE (Degree)	RAW VALUE (dBuV)	CORRECTION FACTOR (dB/m)
1	*2462.00	101.4 PK			1.06 H	281	68.26	33.14
2	*2462.00	99.0 AV			1.06 H	281	65.86	33.14
3	2500.00	49.1 PK	74.0	-24.9	1.71 H	112	15.83	33.27
4	2500.00	42.0 AV	54.0	-12.0	1.71 H	112	8.73	33.27
5	3600.00	53.3 PK	74.0	-20.7	1.21 H	219	17.12	36.18
6	3600.00	50.4 AV	54.0	-3.6	1.21 H	219	14.22	36.18
7	4924.00	53.4 PK	74.0	-20.6	1.48 H	226	12.29	41.11
8	4924.00	47.3 AV	54.0	-6.7	1.48 H	226	6.19	41.11
9	7386.00	55.2 PK	74.0	-18.8	1.05 H	359	6.35	48.85
10	7386.00	44.3 AV	54.0	-9.7	1.05 H	359	-4.55	48.85

**ANTENNA POLARITY & TEST DISTANCE: VERTICAL AT 3 M**

NO.	FREQ. (MHz)	EMISSION LEVEL (dBuV/m)	LIMIT (dBuV/m)	MARGIN (dB)	ANTENNA HEIGHT (m)	TABLE ANGLE (Degree)	RAW VALUE (dBuV)	CORRECTION FACTOR (dB/m)
1	2382.00	62.9 PK	74.0	-11.1	1.00 V	205	30.04	32.86
2	2382.00	53.6 AV	54.0	-0.4	1.00 V	205	20.74	32.86
3	*2462.00	112.5 PK			1.18 V	196	79.36	33.14
4	*2462.00	109.8 AV			1.18 V	196	76.66	33.14
5	2483.50	62.1 PK	74.0	-11.9	1.18 V	196	28.89	33.21
6	2483.50	49.7 AV	54.0	-4.3	1.18 V	196	16.49	33.21
7	2500.00	57.9 PK	74.0	-16.1	1.08 V	86	24.63	33.27
8	2500.00	52.1 AV	54.0	-1.9	1.08 V	86	18.83	33.27
9	3600.00	47.9 PK	74.0	-26.1	1.00 V	84	11.72	36.18
10	3600.00	42.1 AV	54.0	-11.9	1.00 V	84	5.92	36.18
11	4924.00	55.3 PK	74.0	-18.7	1.14 V	261	14.19	41.11
12	4924.00	52.5 AV	54.0	-1.5	1.14 V	261	11.39	41.11
13	7386.00	56.7 PK	74.0	-17.3	1.21 V	245	7.85	48.85
14	7386.00	45.9 AV	54.0	-8.1	1.21 V	245	-2.95	48.85

**REMARKS:**

1. Emission Level(dBuV/m) = Raw Value(dBuV) + Correction Factor(dB/m)
2. Correction Factor(dB/m) = Antenna Factor(dB/m) + Cable Factor(dB)  
– Pre-Amplifier Factor(dB)
3. The other emission levels were very low against the limit.
4. Margin value = Emission Level – Limit value
5. " \* ": Fundamental frequency.



A D T

802.11g

<b>CHANNEL</b>	TX Channel 1	<b>DETECTOR FUNCTION</b>	Peak (PK)
<b>FREQUENCY RANGE</b>	1GHz ~ 25GHz		Average (AV)

**ANTENNA POLARITY & TEST DISTANCE: HORIZONTAL AT 3 M**

NO.	FREQ. (MHz)	EMISSION LEVEL (dBuV/m)	LIMIT (dBuV/m)	MARGIN (dB)	ANTENNA HEIGHT (m)	TABLE ANGLE (Degree)	RAW VALUE (dBuV)	CORRECTION FACTOR (dB/m)
1	2390.00	56.0 PK	74.0	-18.0	1.68 H	294	23.11	32.89
2	2390.00	42.3 AV	54.0	-11.7	1.68 H	294	9.41	32.89
3	*2412.00	101.4 PK			1.68 H	294	68.43	32.97
4	*2412.00	90.7 AV			1.68 H	294	57.73	32.97
5	2500.00	55.7 PK	74.0	-18.3	1.18 H	118	22.43	33.27
6	2500.00	52.8 AV	54.0	-1.2	1.18 H	118	19.53	33.27
7	4824.00	48.5 PK	74.0	-25.5	1.42 H	321	7.72	40.78
8	4824.00	35.9 AV	54.0	-18.1	1.42 H	321	-4.88	40.78

**ANTENNA POLARITY & TEST DISTANCE: VERTICAL AT 3 M**

NO.	FREQ. (MHz)	EMISSION LEVEL (dBuV/m)	LIMIT (dBuV/m)	MARGIN (dB)	ANTENNA HEIGHT (m)	TABLE ANGLE (Degree)	RAW VALUE (dBuV)	CORRECTION FACTOR (dB/m)
1	2390.00	59.5 PK	74.0	-14.5	1.20 V	223	26.61	32.89
2	2390.00	53.5 AV	54.0	-0.5	1.20 V	223	20.61	32.89
3	*2412.00	112.6 PK			1.20 V	223	79.63	32.97
4	*2412.00	100.5 AV			1.20 V	223	67.53	32.97
5	2500.00	56.9 PK	74.0	-17.1	1.08 V	97	23.63	33.27
6	2500.00	53.3 AV	54.0	-0.7	1.08 V	97	20.03	33.27
7	4824.00	51.0 PK	74.0	-23.0	1.14 V	273	10.22	40.78
8	4824.00	38.3 AV	54.0	-15.7	1.14 V	273	-2.48	40.78

**REMARKS:**

1. Emission Level(dBuV/m) = Raw Value(dBuV) + Correction Factor(dB/m)
2. Correction Factor(dB/m) = Antenna Factor(dB/m) + Cable Factor(dB) – Pre-Amplifier Factor(dB)
3. The other emission levels were very low against the limit.
4. Margin value = Emission Level – Limit value
5. " \* ": Fundamental frequency.



A D T

<b>CHANNEL</b>	TX Channel 6	<b>DETECTOR FUNCTION</b>	Peak (PK)
<b>FREQUENCY RANGE</b>	1GHz ~ 25GHz		Average (AV)

**ANTENNA POLARITY & TEST DISTANCE: HORIZONTAL AT 3 M**

NO.	FREQ. (MHz)	EMISSION LEVEL (dBuV/m)	LIMIT (dBuV/m)	MARGIN (dB)	ANTENNA HEIGHT (m)	TABLE ANGLE (Degree)	RAW VALUE (dBuV)	CORRECTION FACTOR (dB/m)
1	*2437.00	109.3 PK			1.07 H	281	76.25	33.05
2	*2437.00	99.8 AV			1.07 H	281	66.75	33.05
3	4874.00	54.3 PK	74.0	-19.7	1.38 H	311	13.34	40.96
4	4874.00	39.3 AV	54.0	-14.7	1.38 H	311	-1.66	40.96
5	7311.00	55.8 PK	74.0	-18.2	1.13 H	297	6.94	48.86
6	7311.00	43.3 AV	54.0	-10.7	1.13 H	297	-5.56	48.86

**ANTENNA POLARITY & TEST DISTANCE: VERTICAL AT 3 M**

NO.	FREQ. (MHz)	EMISSION LEVEL (dBuV/m)	LIMIT (dBuV/m)	MARGIN (dB)	ANTENNA HEIGHT (m)	TABLE ANGLE (Degree)	RAW VALUE (dBuV)	CORRECTION FACTOR (dB/m)
1	2390.00	65.9 PK	74.0	-8.1	1.20 V	216	33.01	32.89
2	2390.00	53.2 AV	54.0	-0.8	1.20 V	216	20.31	32.89
3	*2437.00	123.3 PK			1.16 V	224	90.25	33.05
4	*2437.00	112.0 AV			1.16 V	224	78.95	33.05
5	2483.50	63.0 PK	74.0	-11.0	1.17 V	208	29.79	33.21
6	2483.50	50.3 AV	54.0	-3.7	1.17 V	208	17.09	33.21
7	2500.00	60.8 PK	74.0	-13.2	1.07 V	96	27.53	33.27
8	2500.00	53.4 AV	54.0	-0.6	1.07 V	96	20.13	33.27
9	4874.00	60.2 PK	74.0	-13.8	1.14 V	265	19.24	40.96
10	4874.00	43.4 AV	54.0	-10.6	1.14 V	265	2.44	40.96
11	7311.00	63.3 PK	74.0	-10.7	1.24 V	277	14.44	48.86
12	7311.00	49.5 AV	54.0	-4.5	1.24 V	277	0.64	48.86

**REMARKS:**

1. Emission Level(dBuV/m) = Raw Value(dBuV) + Correction Factor(dB/m)
2. Correction Factor(dB/m) = Antenna Factor(dB/m) + Cable Factor(dB)  
– Pre-Amplifier Factor(dB)
3. The other emission levels were very low against the limit.
4. Margin value = Emission Level – Limit value
5. " \* ": Fundamental frequency.



A D T

<b>CHANNEL</b>	TX Channel 11	<b>DETECTOR FUNCTION</b>	Peak (PK)
<b>FREQUENCY RANGE</b>	1GHz ~ 25GHz		Average (AV)

**ANTENNA POLARITY & TEST DISTANCE: HORIZONTAL AT 3 M**

NO.	FREQ. (MHz)	EMISSION LEVEL (dBuV/m)	LIMIT (dBuV/m)	MARGIN (dB)	ANTENNA HEIGHT (m)	TABLE ANGLE (Degree)	RAW VALUE (dBuV)	CORRECTION FACTOR (dB/m)
1	*2462.00	101.1 PK			1.07 H	281	67.96	33.14
2	*2462.00	92.3 AV			1.07 H	281	59.16	33.14
3	2483.50	57.2 PK	74.0	-16.8	1.07 H	281	23.99	33.21
4	2483.50	43.4 AV	54.0	-10.6	1.07 H	281	10.19	33.21
5	4924.00	49.0 PK	74.0	-25.0	1.40 H	313	7.89	41.11
6	4924.00	36.4 AV	54.0	-17.6	1.40 H	313	-4.71	41.11
7	7386.00	55.9 PK	74.0	-18.1	1.18 H	287	7.05	48.85
8	7386.00	43.4 AV	54.0	-10.6	1.18 H	287	-5.45	48.85

**ANTENNA POLARITY & TEST DISTANCE: VERTICAL AT 3 M**

NO.	FREQ. (MHz)	EMISSION LEVEL (dBuV/m)	LIMIT (dBuV/m)	MARGIN (dB)	ANTENNA HEIGHT (m)	TABLE ANGLE (Degree)	RAW VALUE (dBuV)	CORRECTION FACTOR (dB/m)
1	*2462.00	112.0 PK			1.18 V	186	78.86	33.14
2	*2462.00	101.7 AV			1.18 V	186	68.56	33.14
3	2483.50	71.4 PK	74.0	-2.6	1.18 V	186	38.19	33.21
4	2483.50	53.6 AV	54.0	-0.4	1.18 V	186	20.39	33.21
5	2500.00	58.2 PK	74.0	-15.8	1.08 V	95	24.93	33.27
6	2500.00	53.4 AV	54.0	-0.6	1.08 V	95	20.13	33.27
7	4924.00	51.3 PK	74.0	-22.7	1.15 V	249	10.19	41.11
8	4924.00	38.5 AV	54.0	-15.5	1.15 V	249	-2.61	41.11
9	7386.00	56.5 PK	74.0	-17.5	1.15 V	259	7.65	48.85
10	7386.00	43.9 AV	54.0	-10.1	1.15 V	259	-4.95	48.85

**REMARKS:**

1. Emission Level(dBuV/m) = Raw Value(dBuV) + Correction Factor(dB/m)
2. Correction Factor(dB/m) = Antenna Factor(dB/m) + Cable Factor(dB)  
– Pre-Amplifier Factor(dB)
3. The other emission levels were very low against the limit.
4. Margin value = Emission Level – Limit value
5. " \* ": Fundamental frequency.



A D T

802.11n (HT20)

<b>CHANNEL</b>	TX Channel 1	<b>DETECTOR FUNCTION</b>	Peak (PK)
<b>FREQUENCY RANGE</b>	1GHz ~ 25GHz		Average (AV)

**ANTENNA POLARITY & TEST DISTANCE: HORIZONTAL AT 3 M**

NO.	FREQ. (MHz)	EMISSION LEVEL (dBuV/m)	LIMIT (dBuV/m)	MARGIN (dB)	ANTENNA HEIGHT (m)	TABLE ANGLE (Degree)	RAW VALUE (dBuV)	CORRECTION FACTOR (dB/m)
1	2390.00	60.9 PK	74.0	-13.1	1.20 H	14	28.01	32.89
2	2390.00	48.4 AV	54.0	-5.6	1.20 H	14	15.51	32.89
3	*2412.00	108.1 PK			1.20 H	14	75.13	32.97
4	*2412.00	97.9 AV			1.20 H	14	64.93	32.97
5	2500.00	55.6 PK	74.0	-18.4	1.22 H	119	22.33	33.27
6	2500.00	52.6 AV	54.0	-1.4	1.22 H	119	19.33	33.27
7	4824.00	51.8 PK	74.0	-22.2	1.34 H	320	11.02	40.78
8	4824.00	38.1 AV	54.0	-15.9	1.34 H	320	-2.68	40.78

**ANTENNA POLARITY & TEST DISTANCE: VERTICAL AT 3 M**

NO.	FREQ. (MHz)	EMISSION LEVEL (dBuV/m)	LIMIT (dBuV/m)	MARGIN (dB)	ANTENNA HEIGHT (m)	TABLE ANGLE (Degree)	RAW VALUE (dBuV)	CORRECTION FACTOR (dB/m)
1	2390.00	69.0 PK	74.0	-5.0	1.14 V	202	36.11	32.89
2	2390.00	53.3 AV	54.0	-0.7	1.14 V	202	20.41	32.89
3	*2412.00	113.1 PK			1.14 V	202	80.13	32.97
4	*2412.00	102.1 AV			1.14 V	202	69.13	32.97
5	2500.00	65.0 PK	74.0	-9.0	1.07 V	98	31.73	33.27
6	2500.00	53.7 AV	54.0	-0.3	1.07 V	98	20.43	33.27
7	4824.00	52.7 PK	74.0	-21.3	1.16 V	273	11.92	40.78
8	4824.00	40.3 AV	54.0	-13.7	1.16 V	273	-0.48	40.78

**REMARKS:**

1. Emission Level(dBuV/m) = Raw Value(dBuV) + Correction Factor(dB/m)
2. Correction Factor(dB/m) = Antenna Factor(dB/m) + Cable Factor(dB)  
– Pre-Amplifier Factor(dB)
3. The other emission levels were very low against the limit.
4. Margin value = Emission Level – Limit value
5. " \* ": Fundamental frequency.



A D T

<b>CHANNEL</b>	TX Channel 6	<b>DETECTOR FUNCTION</b>	Peak (PK)
<b>FREQUENCY RANGE</b>	1GHz ~ 25GHz		Average (AV)

ANTENNA POLARITY & TEST DISTANCE: HORIZONTAL AT 3 M								
NO.	FREQ. (MHz)	EMISSION LEVEL (dBuV/m)	LIMIT (dBuV/m)	MARGIN (dB)	ANTENNA HEIGHT (m)	TABLE ANGLE (Degree)	RAW VALUE (dBuV)	CORRECTION FACTOR (dB/m)
1	2390.00	65.1 PK	74.0	-8.9	1.00 H	356	32.21	32.89
2	2390.00	52.2 AV	54.0	-1.8	1.00 H	356	19.31	32.89
3	*2437.00	117.9 PK			1.00 H	356	84.85	33.05
4	*2437.00	109.6 AV			1.00 H	356	76.55	33.05
5	4874.00	60.6 PK	74.0	-13.4	1.38 H	312	19.64	40.96
6	4874.00	46.0 AV	54.0	-8.0	1.38 H	312	5.04	40.96
7	7311.00	63.7 PK	74.0	-10.3	1.34 H	333	14.84	48.86
8	7311.00	49.1 AV	54.0	-4.9	1.34 H	333	0.24	48.86

ANTENNA POLARITY & TEST DISTANCE: VERTICAL AT 3 M								
NO.	FREQ. (MHz)	EMISSION LEVEL (dBuV/m)	LIMIT (dBuV/m)	MARGIN (dB)	ANTENNA HEIGHT (m)	TABLE ANGLE (Degree)	RAW VALUE (dBuV)	CORRECTION FACTOR (dB/m)
1	2320.00	64.6 PK	74.0	-9.4	1.08 V	274	31.99	32.61
2	2320.00	53.1 AV	54.0	-0.9	1.08 V	274	20.49	32.61
3	2390.00	69.5 PK	74.0	-4.5	1.10 V	268	36.61	32.89
4	2390.00	53.3 AV	54.0	-0.7	1.10 V	268	20.41	32.89
5	*2437.00	122.9 PK			1.10 V	268	89.85	33.05
6	*2437.00	111.8 AV			1.10 V	268	78.75	33.05
7	2487.85	66.6 PK	74.0	-7.4	1.09 V	275	33.37	33.23
8	2487.85	49.8 AV	54.0	-4.2	1.09 V	275	16.57	33.23
9	2500.00	64.9 PK	74.0	-9.1	1.06 V	98	31.63	33.27
10	2500.00	53.5 AV	54.0	-0.5	1.06 V	98	20.23	33.27
11	4874.00	65.1 PK	74.0	-8.9	1.15 V	265	24.14	40.96
12	4874.00	48.4 AV	54.0	-5.6	1.15 V	265	7.44	40.96
13	7311.00	68.0 PK	74.0	-6.0	1.15 V	260	19.14	48.86
14	<b>7311.00</b>	<b>53.9 AV</b>	<b>54.0</b>	<b>-0.1</b>	<b>1.15 V</b>	<b>260</b>	<b>5.04</b>	<b>48.86</b>

**REMARKS:**

1. Emission Level(dBuV/m) = Raw Value(dBuV) + Correction Factor(dB/m)
2. Correction Factor(dB/m) = Antenna Factor(dB/m) + Cable Factor(dB) – Pre-Amplifier Factor(dB)
3. The other emission levels were very low against the limit.
4. Margin value = Emission Level – Limit value
5. " \* ": Fundamental frequency.



A D T

<b>CHANNEL</b>	TX Channel 11	<b>DETECTOR FUNCTION</b>	Peak (PK)
<b>FREQUENCY RANGE</b>	1GHz ~ 25GHz		Average (AV)

**ANTENNA POLARITY & TEST DISTANCE: HORIZONTAL AT 3 M**

NO.	FREQ. (MHz)	EMISSION LEVEL (dBuV/m)	LIMIT (dBuV/m)	MARGIN (dB)	ANTENNA HEIGHT (m)	TABLE ANGLE (Degree)	RAW VALUE (dBuV)	CORRECTION FACTOR (dB/m)
1	*2462.00	109.0 PK			1.20 H	7	75.86	33.14
2	*2462.00	101.0 AV			1.20 H	7	67.86	33.14
3	2485.20	64.9 PK	74.0	-9.1	1.20 H	7	31.68	33.22
4	2485.20	52.7 AV	54.0	-1.3	1.20 H	7	19.48	33.22
5	4924.00	51.8 PK	74.0	-22.2	1.35 H	320	10.69	41.11
6	4924.00	38.3 AV	54.0	-15.7	1.35 H	320	-2.81	41.11
7	7386.00	56.4 PK	74.0	-17.6	1.33 H	340	7.55	48.85
8	7386.00	42.9 AV	54.0	-11.1	1.33 H	340	-5.95	48.85

**ANTENNA POLARITY & TEST DISTANCE: VERTICAL AT 3 M**

NO.	FREQ. (MHz)	EMISSION LEVEL (dBuV/m)	LIMIT (dBuV/m)	MARGIN (dB)	ANTENNA HEIGHT (m)	TABLE ANGLE (Degree)	RAW VALUE (dBuV)	CORRECTION FACTOR (dB/m)
1	*2462.00	115.1 PK			1.16 V	197	81.96	33.14
2	*2462.00	103.7 AV			1.16 V	197	70.56	33.14
3	2485.20	69.4 PK	74.0	-4.6	1.16 V	197	36.18	33.22
4	2485.20	53.4 AV	54.0	-0.6	1.16 V	197	20.18	33.22
5	2500.00	64.8 PK	74.0	-9.2	1.07 V	98	31.53	33.27
6	2500.00	53.6 AV	54.0	-0.4	1.07 V	98	20.33	33.27
7	4924.00	52.2 PK	74.0	-21.8	1.17 V	251	11.09	41.11
8	4924.00	39.9 AV	54.0	-14.1	1.17 V	251	-1.21	41.11
9	7386.00	56.3 PK	74.0	-17.7	1.18 V	255	7.45	48.85
10	7386.00	43.7 AV	54.0	-10.3	1.18 V	255	-5.15	48.85

**REMARKS:**

1. Emission Level(dBuV/m) = Raw Value(dBuV) + Correction Factor(dB/m)
2. Correction Factor(dB/m) = Antenna Factor(dB/m) + Cable Factor(dB)  
– Pre-Amplifier Factor(dB)
3. The other emission levels were very low against the limit.
4. Margin value = Emission Level – Limit value
5. " \* ": Fundamental frequency.





A D T

802.11n (HT40)

<b>CHANNEL</b>	TX Channel 3	<b>DETECTOR FUNCTION</b>	Peak (PK)
<b>FREQUENCY RANGE</b>	1GHz ~ 25GHz		Average (AV)

**ANTENNA POLARITY & TEST DISTANCE: HORIZONTAL AT 3 M**

NO.	FREQ. (MHz)	EMISSION LEVEL (dBuV/m)	LIMIT (dBuV/m)	MARGIN (dB)	ANTENNA HEIGHT (m)	TABLE ANGLE (Degree)	RAW VALUE (dBuV)	CORRECTION FACTOR (dB/m)
1	2388.56	66.5 PK	74.0	-7.5	1.19 H	166	33.61	32.89
2	2388.56	52.8 AV	54.0	-1.2	1.19 H	166	19.91	32.89
3	*2422.00	103.8 PK			1.19 H	166	70.80	33.00
4	*2422.00	95.4 AV			1.19 H	166	62.40	33.00
5	4844.00	48.0 PK	74.0	-26.0	1.37 H	310	7.15	40.85
6	4844.00	35.0 AV	54.0	-19.0	1.37 H	310	-5.85	40.85
7	7266.00	55.8 PK	74.0	-18.2	1.29 H	351	6.95	48.85
8	7266.00	42.7 AV	54.0	-11.3	1.29 H	351	-6.15	48.85

**ANTENNA POLARITY & TEST DISTANCE: VERTICAL AT 3 M**

NO.	FREQ. (MHz)	EMISSION LEVEL (dBuV/m)	LIMIT (dBuV/m)	MARGIN (dB)	ANTENNA HEIGHT (m)	TABLE ANGLE (Degree)	RAW VALUE (dBuV)	CORRECTION FACTOR (dB/m)
1	2385.71	69.5 PK	74.0	-4.5	1.15 V	205	36.63	32.87
2	2385.71	53.3 AV	54.0	-0.7	1.15 V	205	20.43	32.87
3	*2422.00	107.8 PK			1.15 V	205	74.80	33.00
4	*2422.00	96.2 AV			1.15 V	205	63.20	33.00
5	2500.00	64.1 PK	74.0	-9.9	1.08 V	97	30.83	33.27
6	2500.00	53.4 AV	54.0	-0.6	1.08 V	97	20.13	33.27
7	4844.00	48.7 PK	74.0	-25.3	1.20 V	272	7.85	40.85
8	4844.00	36.2 AV	54.0	-17.8	1.20 V	272	-4.65	40.85
9	7266.00	55.6 PK	74.0	-18.4	1.13 V	251	6.75	48.85
10	7266.00	42.8 AV	54.0	-11.2	1.13 V	251	-6.05	48.85

**REMARKS:**

1. Emission Level(dBuV/m) = Raw Value(dBuV) + Correction Factor(dB/m)
2. Correction Factor(dB/m) = Antenna Factor(dB/m) + Cable Factor(dB)  
– Pre-Amplifier Factor(dB)
3. The other emission levels were very low against the limit.
4. Margin value = Emission Level – Limit value
5. " \* ": Fundamental frequency.



A D T

<b>CHANNEL</b>	TX Channel 6	<b>DETECTOR FUNCTION</b>	Peak (PK)
<b>FREQUENCY RANGE</b>	1GHz ~ 25GHz		Average (AV)

**ANTENNA POLARITY & TEST DISTANCE: HORIZONTAL AT 3 M**

NO.	FREQ. (MHz)	EMISSION LEVEL (dBuV/m)	LIMIT (dBuV/m)	MARGIN (dB)	ANTENNA HEIGHT (m)	TABLE ANGLE (Degree)	RAW VALUE (dBuV)	CORRECTION FACTOR (dB/m)
1	*2437.00	107.8 PK			1.21 H	185	74.75	33.05
2	*2437.00	100.0 AV			1.21 H	185	66.95	33.05
3	4874.00	49.4 PK	74.0	-24.6	1.34 H	329	8.44	40.96
4	4874.00	36.7 AV	54.0	-17.3	1.34 H	329	-4.26	40.96
5	7311.00	55.7 PK	74.0	-18.3	1.30 H	342	6.84	48.86
6	7311.00	42.9 AV	54.0	-11.1	1.30 H	342	-5.96	48.86

**ANTENNA POLARITY & TEST DISTANCE: VERTICAL AT 3 M**

NO.	FREQ. (MHz)	EMISSION LEVEL (dBuV/m)	LIMIT (dBuV/m)	MARGIN (dB)	ANTENNA HEIGHT (m)	TABLE ANGLE (Degree)	RAW VALUE (dBuV)	CORRECTION FACTOR (dB/m)
1	2390.00	70.2 PK	74.0	-3.8	1.08 V	267	37.31	32.89
2	2390.00	53.6 AV	54.0	-0.4	1.08 V	267	20.71	32.89
3	*2437.00	114.0 PK			1.08 V	267	80.95	33.05
4	*2437.00	102.2 AV			1.08 V	267	69.15	33.05
5	2483.50	66.9 PK	74.0	-7.1	1.08 V	267	33.69	33.21
6	2483.50	52.2 AV	54.0	-1.8	1.08 V	267	18.99	33.21
7	2500.00	64.0 PK	74.0	-10.0	1.07 V	97	30.73	33.27
8	2500.00	53.6 AV	54.0	-0.4	1.07 V	97	20.33	33.27
9	4874.00	51.4 PK	74.0	-22.6	1.20 V	255	10.44	40.96
10	4874.00	39.2 AV	54.0	-14.8	1.20 V	255	-1.76	40.96
11	7311.00	55.6 PK	74.0	-18.4	1.17 V	254	6.74	48.86
12	7311.00	43.1 AV	54.0	-10.9	1.17 V	254	-5.76	48.86

**REMARKS:**

1. Emission Level(dBuV/m) = Raw Value(dBuV) + Correction Factor(dB/m)
2. Correction Factor(dB/m) = Antenna Factor(dB/m) + Cable Factor(dB) – Pre-Amplifier Factor(dB)
3. The other emission levels were very low against the limit.
4. Margin value = Emission Level – Limit value
5. " \* ": Fundamental frequency.



A D T

<b>CHANNEL</b>	TX Channel 9	<b>DETECTOR FUNCTION</b>	Peak (PK)
<b>FREQUENCY RANGE</b>	1GHz ~ 25GHz		Average (AV)

**ANTENNA POLARITY & TEST DISTANCE: HORIZONTAL AT 3 M**

NO.	FREQ. (MHz)	EMISSION LEVEL (dBuV/m)	LIMIT (dBuV/m)	MARGIN (dB)	ANTENNA HEIGHT (m)	TABLE ANGLE (Degree)	RAW VALUE (dBuV)	CORRECTION FACTOR (dB/m)
1	*2452.00	105.0 PK			1.20 H	0	71.89	33.11
2	*2452.00	96.1 AV			1.20 H	0	62.99	33.11
3	2489.50	65.6 PK	74.0	-8.4	1.20 H	0	32.37	33.23
4	2489.50	53.4 AV	54.0	-0.6	1.20 H	0	20.17	33.23
5	4904.00	48.3 PK	74.0	-25.7	1.34 H	323	7.23	41.07
6	4904.00	35.2 AV	54.0	-18.8	1.34 H	323	-5.87	41.07
7	7356.00	55.6 PK	74.0	-18.4	1.35 H	331	6.75	48.85
8	7356.00	42.6 AV	54.0	-11.4	1.35 H	331	-6.25	48.85

**ANTENNA POLARITY & TEST DISTANCE: VERTICAL AT 3 M**

NO.	FREQ. (MHz)	EMISSION LEVEL (dBuV/m)	LIMIT (dBuV/m)	MARGIN (dB)	ANTENNA HEIGHT (m)	TABLE ANGLE (Degree)	RAW VALUE (dBuV)	CORRECTION FACTOR (dB/m)
1	*2452.00	109.9 PK			1.08 V	241	76.79	33.11
2	*2452.00	97.4 AV			1.08 V	241	64.29	33.11
3	2487.06	72.7 PK	74.0	-1.3	1.08 V	241	39.48	33.22
4	2487.06	53.7 AV	54.0	-0.3	1.08 V	241	20.48	33.22
5	2500.00	64.6 PK	74.0	-9.4	1.07 V	96	31.33	33.27
6	2500.00	53.7 AV	54.0	-0.3	1.07 V	96	20.43	33.27
7	4904.00	48.3 PK	74.0	-25.7	1.20 V	264	7.23	41.07
8	4904.00	35.8 AV	54.0	-18.2	1.20 V	264	-5.27	41.07
9	7356.00	55.9 PK	74.0	-18.1	1.15 V	247	7.05	48.85
10	7356.00	43.0 AV	54.0	-11.0	1.15 V	247	-5.85	48.85

**REMARKS:**

1. Emission Level(dBuV/m) = Raw Value(dBuV) + Correction Factor(dB/m)
2. Correction Factor(dB/m) = Antenna Factor(dB/m) + Cable Factor(dB)  
– Pre-Amplifier Factor(dB)
3. The other emission levels were very low against the limit.
4. Margin value = Emission Level – Limit value
5. " \* ": Fundamental frequency.

### 4.3 6dB BANDWIDTH MEASUREMENT

#### 4.3.1 LIMITS OF 6dB BANDWIDTH MEASUREMENT

The minimum of 6dB Bandwidth Measurement is 0.5 MHz.

#### 4.3.2 TEST INSTRUMENTS

DESCRIPTION & MANUFACTURER	MODEL NO.	SERIAL NO.	CALIBRATED DATE	CALIBRATED UNTIL
Spectrum Analyzer R&S	FSP 40	100036	Jan. 21, 2013	Jan. 20, 2014

**Note:**

1. The calibration interval of the above test instruments is 12 months and the calibrations are traceable to NML/ROC and NIST/USA.
2. Tested date : Aug. 08, 2013

#### 4.3.3 TEST PROCEDURE

1. Set resolution bandwidth (RBW) = 100kHz
2. Set the video bandwidth (VBW)  $\geq 3 \times$  RBW, Detector = Peak.
3. Trace mode = max hold.
4. Sweep = auto couple.
5. Measure the maximum width of the emission that is constrained by the frequencies associated with the two amplitude points (upper and lower) that are attenuated by 6 dB relative to the maximum level measured in the fundamental emission

#### 4.3.4 DEVIATION FROM TEST STANDARD

No deviation

#### 4.3.5 TEST SETUP

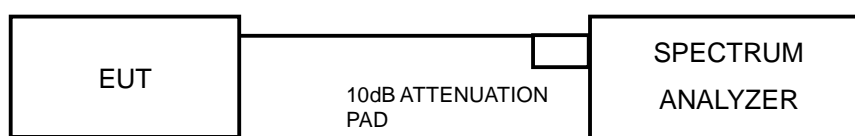

#### 4.3.6 EUT OPERATING CONDITIONS

The software provided by client to enable the EUT under transmission condition continuously at lowest, middle and highest channel frequencies individually.



A D T

### 4.3.7 TEST RESULTS

#### 802.11b

CHANNEL	FREQUENCY (MHz)	6dB BANDWIDTH (MHz)	MINIMUM LIMIT (MHz)	PASS / FAIL
1	2412	8.24	0.5	PASS
6	2437	8.45	0.5	PASS
11	2462	8.46	0.5	PASS

#### 802.11g

CHANNEL	FREQUENCY (MHz)	6dB BANDWIDTH (MHz)	MINIMUM LIMIT (MHz)	PASS / FAIL
1	2412	16.47	0.5	PASS
6	2437	16.49	0.5	PASS
11	2462	16.46	0.5	PASS

#### 802.11n (HT20)

CHANNEL	CHANNEL FREQUENCY (MHz)	6dB BANDWIDTH (MHz)			MINIMUM LIMIT (MHz)	PASS / FAIL
		CHAIN 0	CHAIN 1	CHAIN 2		
1	2412	17.67	17.70	17.68	0.5	PASS
6	2437	17.27	17.67	17.66	0.5	PASS
11	2462	17.62	17.68	17.69	0.5	PASS

#### 802.11n (HT40)

CHANNEL	CHANNEL FREQUENCY (MHz)	6dB BANDWIDTH (MHz)			MINIMUM LIMIT (MHz)	PASS / FAIL
		CHAIN 0	CHAIN 1	CHAIN 2		
3	2422	36.50	36.35	36.12	0.5	PASS
6	2437	36.48	36.49	35.86	0.5	PASS
9	2452	36.15	36.44	36.47	0.5	PASS

## 4.4 CONDUCTED OUTPUT POWER MEASUREMENT

### 4.4.1 LIMITS OF MAXIMUM PEAK OUTPUT POWER MEASUREMENT

For systems using digital modulation in the 2400–2483.5 MHz bands: 1 Watt (30dBm)

Per KDB 662911 D01 Multiple Transmitter Output v01r02 Method of conducted output power measurement on IEEE 802.11 devices,

Array Gain = 0 dB (i.e., no array gain) for NANT  $\leq$  4;

Array Gain = 0 dB (i.e., no array gain) for channel widths  $\geq$  40 MHz for any NANT;

Array Gain = 5 log(NANT/NSS) dB or 3 dB, whichever is less for 20-MHz channel widths with NANT  $\geq$  5.

For power measurements on all other devices: Array Gain = 10 log(NANT/NSS) dB.

### 4.4.2 INSTRUMENTS

DESCRIPTION & MANUFACTURER	MODEL NO.	SERIAL NO.	CALIBRATED DATE	CALIBRATED UNTIL
Power meter Anritsu	ML2495A	0824006	May 20, 2013	May 19, 2014
Power sensor Anritsu	MA2411B	0738172	May 20, 2013	May 19, 2014

**Note:**

1. The calibration interval of the above test instruments is 12 months and the calibrations are traceable to NML/ROC and NIST/USA.
2. Tested date : Aug. 08, 2013

### 4.4.3 TEST PROCEDURES

Method PM is used to perform output power measurement, trigger and gating function of wide band power meter is enabled to measure max output power of TX on burst. Duty factor is not added to measured value.

Duty cycle of test signal is < 98 %. Method PM is used to perform output power measurement, trigger and gating function of wide band power meter is enabled to measure max output power of TX on burst. Duty factor is not added to measured value.

#### 4.4.4 DEVIATION FROM TEST STANDARD

No deviation.

#### 4.4.5 TEST SETUP

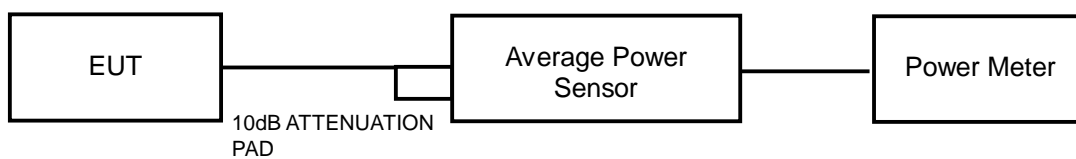

#### 4.4.6 EUT OPERATING CONDITIONS

Same as Item 4.3.6



A D T

#### 4.4.7 TEST RESULTS

##### 802.11b

CHANNEL	FREQUENCY (MHz)	AVERAGE POWER (mW)	AVERAGE POWER (dBm)	LIMIT (dBm)	PASS/FAIL
1	2412	98.628	19.94	30	PASS
6	2437	116.681	20.67	30	PASS
11	2462	111.173	20.46	30	PASS

##### 802.11g

CHANNEL	FREQUENCY (MHz)	AVERAGE POWER (mW)	AVERAGE POWER (dBm)	LIMIT (dBm)	PASS/FAIL
1	2412	55.335	17.43	30	PASS
6	2437	402.717	26.05	30	PASS
11	2462	66.222	18.21	30	PASS

##### 802.11n (HT20)

CHANNEL	FREQUENCY (MHz)	AVERAGE POWER (dBm)			TOTAL POWER (mW)	TOTAL POWER (dBm)	LIMIT (dBm)	PASS / FAIL
		CHAIN 0	CHAIN 1	CHAIN 2				
1	2412	14.27	15.19	14.33	86.869	19.39	30	PASS
6	2437	25.13	25.11	25.03	968.597	29.86	30	PASS
11	2462	16.42	16.12	15.52	120.424	20.81	30	PASS

##### 802.11n (HT40)

CHANNEL	FREQUENCY (MHz)	AVERAGE POWER (dBm)			TOTAL POWER (mW)	TOTAL POWER (dBm)	LIMIT (dBm)	PASS / FAIL
		CHAIN 0	CHAIN 1	CHAIN 2				
3	2422	13.45	13.06	12.27	59.227	17.73	30	PASS
6	2437	16.89	17.08	17.43	155.250	21.91	30	PASS
9	2452	12.07	13.15	13.04	56.897	17.55	30	PASS



## 4.5 POWER SPECTRAL DENSITY MEASUREMENT

### 4.5.1 LIMITS OF POWER SPECTRAL DENSITY MEASUREMENT

The Maximum of Power Spectral Density Measurement is 8dBm.

### 4.5.2 TEST INSTRUMENTS

DESCRIPTION & MANUFACTURER	MODEL NO.	SERIAL NO.	CALIBRATED DATE	CALIBRATED UNTIL
Spectrum Analyzer R&S	FSP 40	100036	Jan. 21, 2013	Jan. 20, 2014

**Note:**

1. The calibration interval of the above test instruments is 12 months and the calibrations are traceable to NML/ROC and NIST/USA.
2. Tested date : Aug. 08, 2013

### 4.5.3 TEST PROCEDURE

1. Set the RBW = 30 kHz, VBW =100 kHz, Detector = power averaging (RMS).
2. Ensure that the number of measurement points in the sweep  $\geq 2 \times$  span/RBW
3. Sweep time = auto couple,
4. Use the peak marker function to determine the maximum power level in any 30 kHz band segment within the fundamental EBW.
5. Scale the observed power level to an equivalent value in 3 kHz by adjusting (reducing) the measured power by a bandwidth correction factor (BWCF) where  $BWCF = 10\log(3 \text{ kHz}/30\text{kHz})$

### 4.5.4 DEVIATION FROM TEST STANDARD

No deviation

### 4.5.5 TEST SETUP

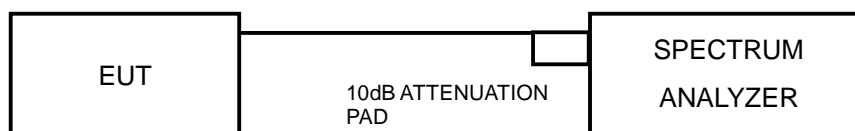

### 4.5.6 EUT OPERATING CONDITION

Same as Item 4.3.6



A D T

#### 4.5.7 TEST RESULTS

##### 802.11b

CHANNEL	FREQUENCY (MHz)	PSD (dBm/30kHz)	PSD (dBm/3kHz)	LIMIT (dBm/3kHz)	PASS /FAIL
1	2412	-5.64	-15.64	8	PASS
6	2437	-3.59	-13.59	8	PASS
11	2462	-4.97	-14.97	8	PASS

##### 802.11g

CHANNEL	FREQUENCY (MHz)	PSD (dBm/30kHz)	PSD (dBm/3kHz)	LIMIT (dBm/3kHz)	PASS /FAIL
1	2412	-9.14	-19.14	8	PASS
6	2437	-1.03	-11.03	8	PASS
11	2462	-8.37	-18.37	8	PASS

##### 802.11n (HT20)

TX chain	Channel	FREQ. (MHz)	PSD (dBm/30kHz)	PSD (dBm/3kHz)	10 log (N=3) dB	Total PSD (dBm/3kHz)	Limit (dBm/3kHz)	PASS /FAIL
0	1	2412	-10.23	-20.23	4.77	-15.46	4.43	PASS
	6	2437	-0.65	-10.65	4.77	-5.88	4.43	PASS
	11	2462	-10.06	-20.06	4.77	-15.29	4.43	PASS
1	1	2412	-11.51	-21.51	4.77	-16.74	4.43	PASS
	6	2437	-1.91	-11.91	4.77	-7.14	4.43	PASS
	11	2462	-10.28	-20.28	4.77	-15.51	4.43	PASS
2	1	2412	-13.22	-23.22	4.77	-18.45	4.43	PASS
	6	2437	-2.58	-12.58	4.77	-7.81	4.43	PASS
	11	2462	-11.47	-21.47	4.77	-16.70	4.43	PASS

**NOTE:** Directional gain =  $10 \log[(10^{G1/20} + 10^{G2/20} + 10^{G3/20})^2 / 3] = 9.57\text{dBi} > 6\text{dBi}$ , so the power density limit shall be reduced to  $8 - (9.57 - 6) = 4.43\text{dBm}$ .



A D T

### 802.11n (HT40)

TX chain	CHAN.	FREQ. (MHz)	PSD W/O DUTY FACTOR (dBm/30kHz)	PSD W/O DUTY FACTOR (dBm/3kHz)	10 log (N=3) dB	DUTY FACTOR (dB)	Total PSD WITH DUTY FACTOR (dBm/3kHz)	Limit (dBm/3kHz)	PASS /FAIL
0	3	2422	-14.81	-24.81	4.77	0.1	-19.94	4.43	PASS
	6	2437	-10.14	-20.14	4.77	0.1	-15.27	4.43	PASS
	9	2452	-13.92	-23.92	4.77	0.1	-19.05	4.43	PASS
1	3	2422	-15.43	-25.43	4.77	0.1	-20.56	4.43	PASS
	6	2437	-11.34	-21.34	4.77	0.1	-16.47	4.43	PASS
	9	2452	-14.72	-24.72	4.77	0.1	-19.85	4.43	PASS
2	3	2422	-17.05	-27.05	4.77	0.1	-22.18	4.43	PASS
	6	2437	-11.78	-21.78	4.77	0.1	-16.91	4.43	PASS
	9	2452	-15.99	-25.99	4.77	0.1	-21.12	4.43	PASS

- NOTE:**
1. Directional gain =  $10 \log[(10G1/20 + 10G2/20 + 10G3/20)^2 / 3] = 9.57\text{dBi} > 6\text{dBi}$  , so the power density limit shall be reduced to  $8-(9.57-6) = 4.43\text{dBm}$ .
  2. Refer to section 3.4 for duty cycle spectrum plot.

## 4.6 CONDUCTED OUT-BAND EMISSION MEASUREMENT

### 4.6.1 LIMITS OF CONDUCTED OUT-BAND EMISSION MEASUREMENT

Below 30dB of the highest emission level of operating band (in 100kHz Resolution Bandwidth).

### 4.6.2 TEST INSTRUMENTS

DESCRIPTION & MANUFACTURER	MODEL NO.	SERIAL NO.	CALIBRATED DATE	CALIBRATED UNTIL
Spectrum Analyzer R&S	FSP 40	100036	Jan. 21, 2013	Jan. 20, 2014

**Note:**

1. The calibration interval of the above test instruments is 12 months and the calibrations are traceable to NML/ROC and NIST/USA.
2. Tested date : Aug. 08, 2013

### 4.6.3 TEST PROCEDURE

#### Measurement Procedure - Reference Level

1. Set the RBW = 100 kHz.
2. Set the VBW  $\geq$  300 kHz.
3. Detector = peak.
4. Sweep time = auto couple.
5. Trace mode = max hold.
6. Allow trace to fully stabilize.
7. Use the peak marker function to determine the maximum power level in any 100 kHz band segment within the fundamental EBW.

#### Measurement Procedure –Unwanted Emission Level

1. Set RBW = 100 kHz.
2. Set VBW  $\geq$  300 kHz.
3. Set span to encompass the spectrum to be examined
4. Detector = peak.
5. Trace Mode = max hold.
6. Sweep = auto couple.

#### 4.6.4 DEVIATION FROM TEST STANDARD

No deviation

#### 4.6.5 TEST SETUP

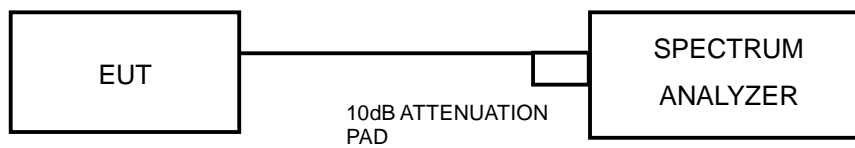

#### 4.6.6 EUT OPERATING CONDITION

Same as Item 4.3.6

#### 4.6.7 TEST RESULTS

The spectrum plots are attached on the following pages. D1 line indicates the highest level, and D2 line indicates the 30dB offset below D1. It shows compliance with the requirement.



A D T

802.11b:

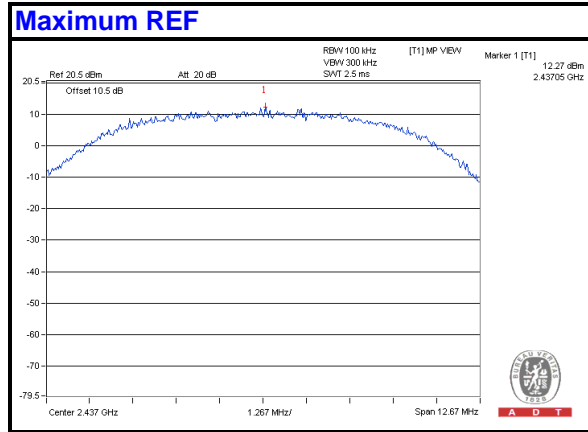

CH 1

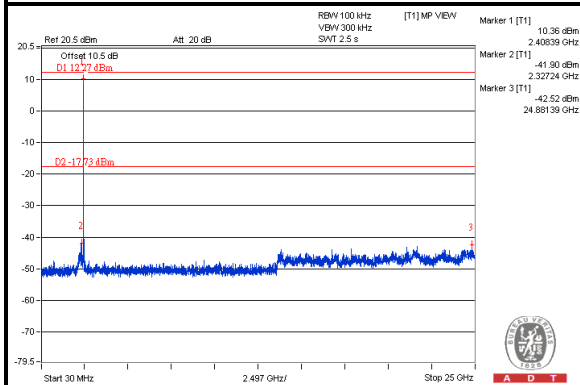

CH 6

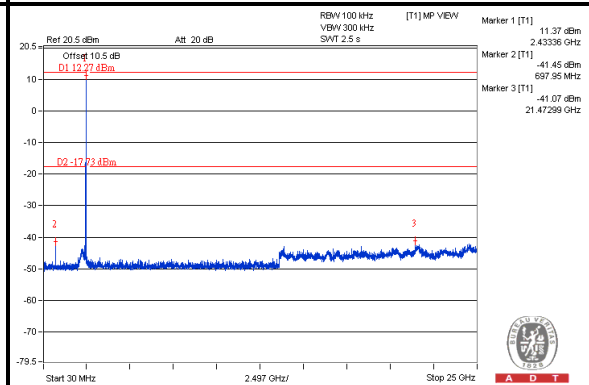

CH 11

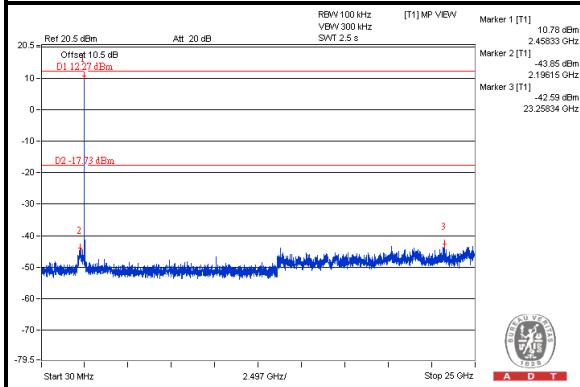



A D T

802.11g:

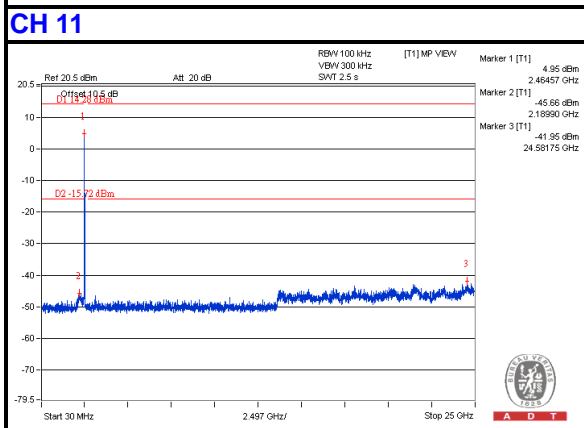
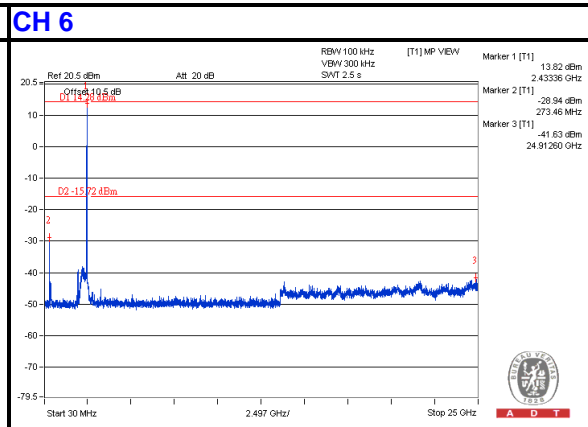
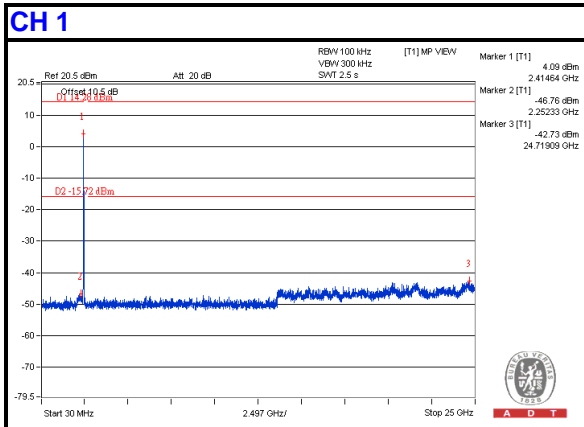
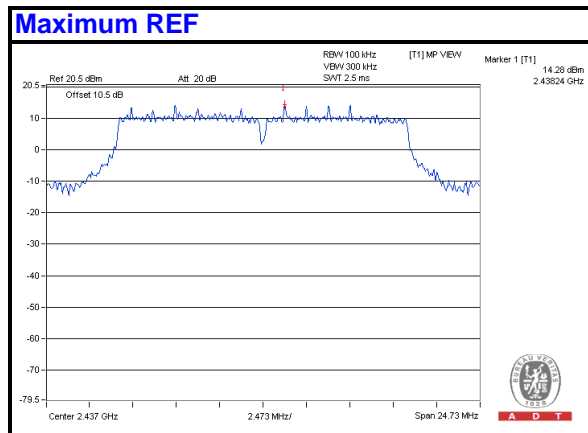



A D T

### 802.11n (HT20):

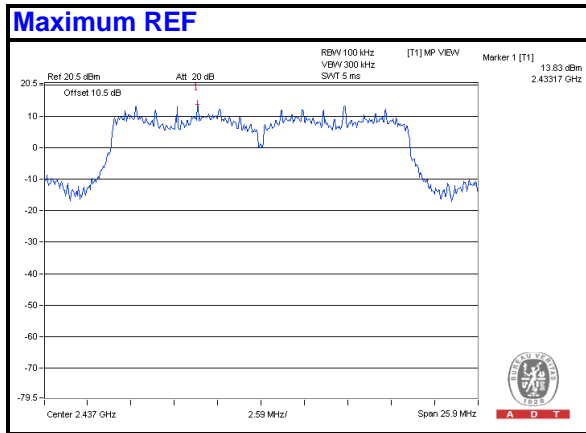

### For Chain 0

#### CH 1

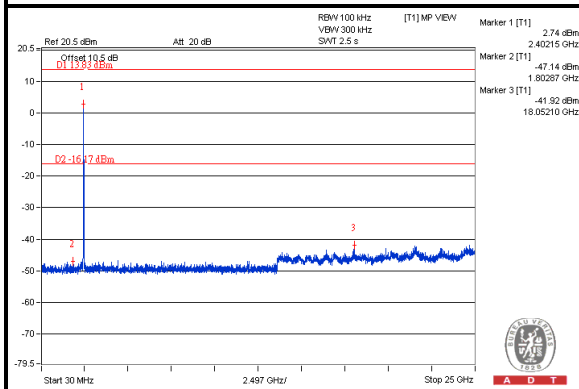

#### CH 6

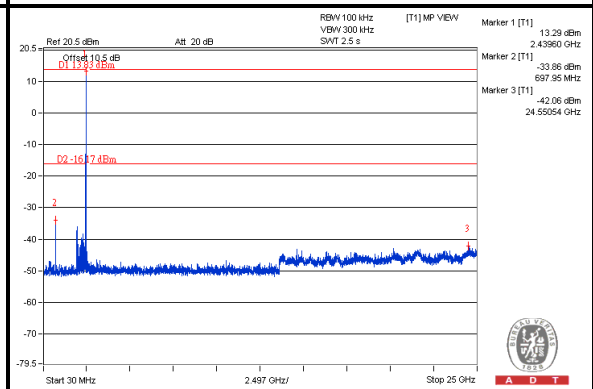

#### CH 11

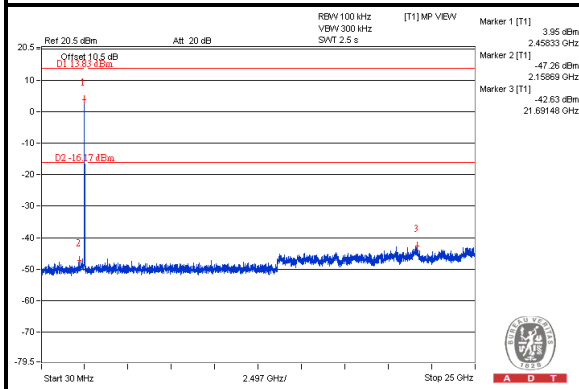





A D T

### For Chain 1

#### CH 1

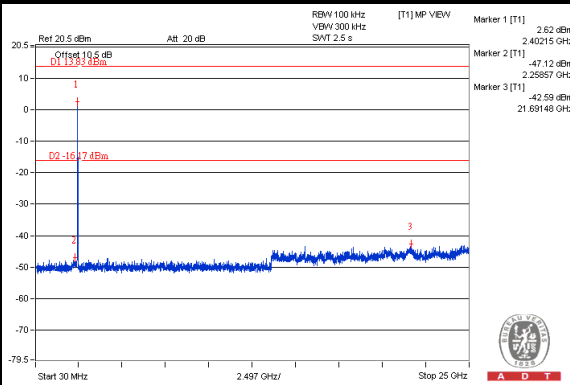

#### CH 6

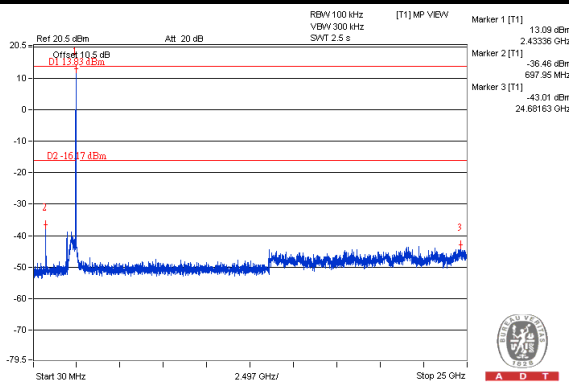

#### CH 11

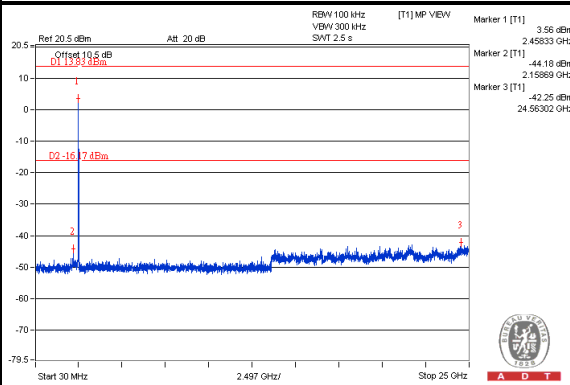



A D T

### For Chain 2

#### CH 1

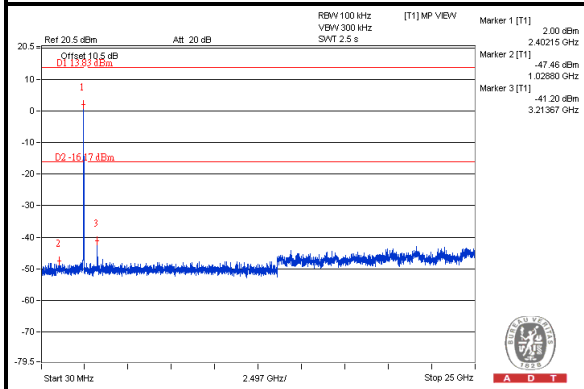

#### CH 6

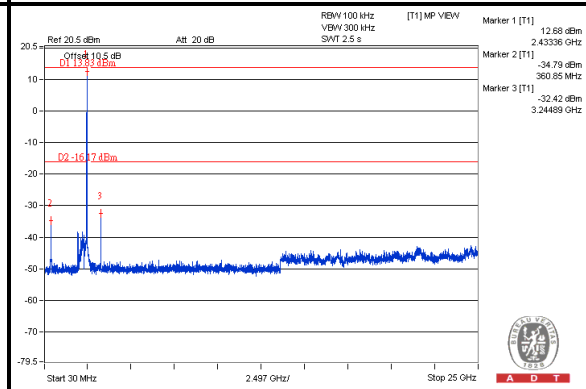

#### CH 11

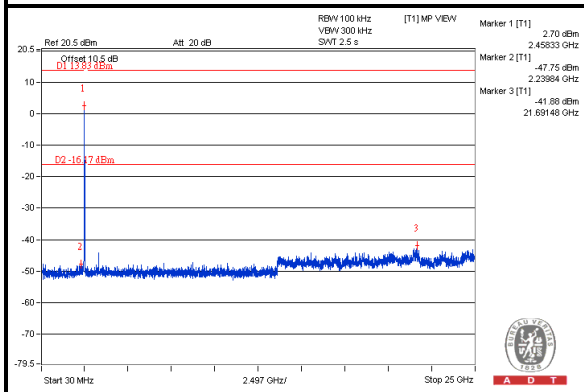



A D T

802.11n (HT40):

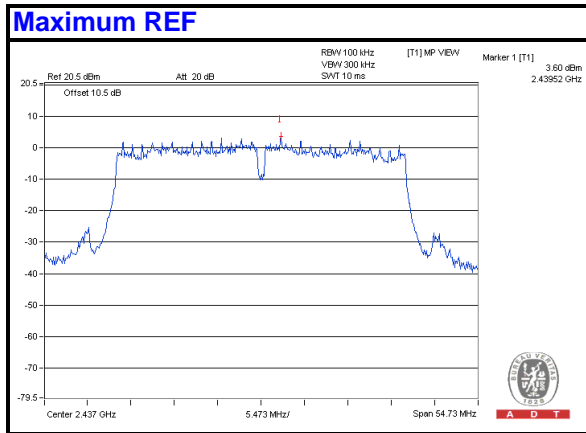

For Chain 0

CH 3

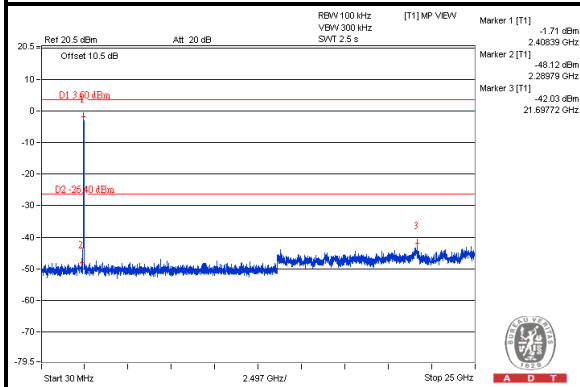

CH 6

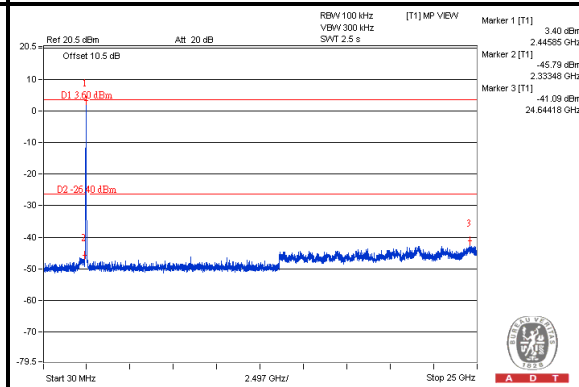

CH 9

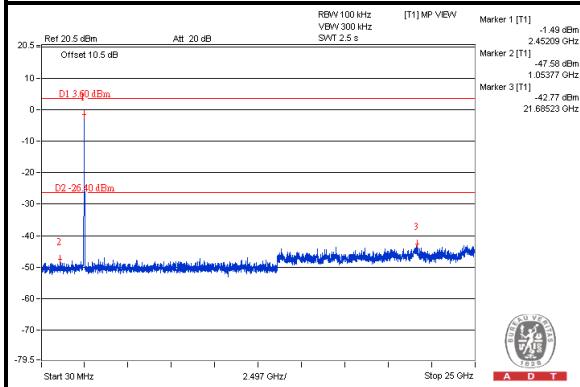



A D T

### For Chain 1

#### CH 3

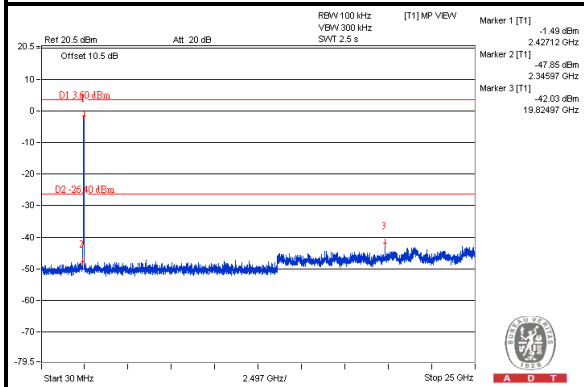

#### CH 6

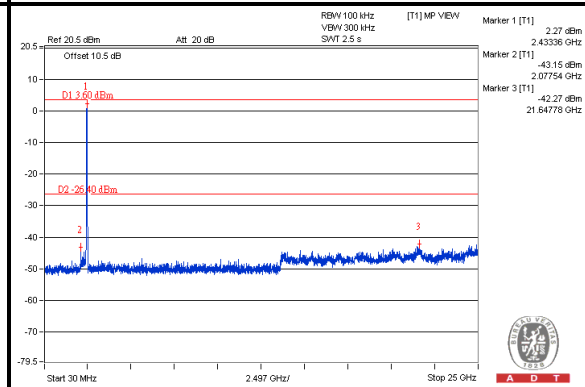

#### CH 9

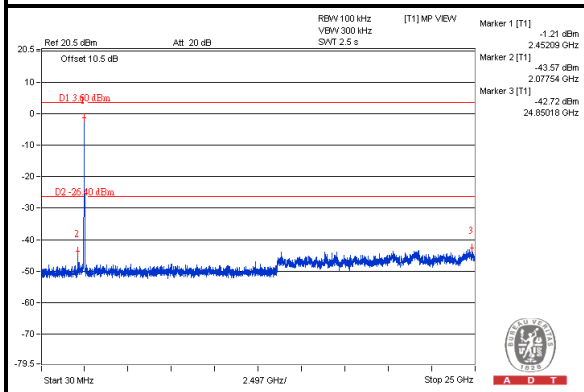



A D T

### For Chain 2

#### CH 3

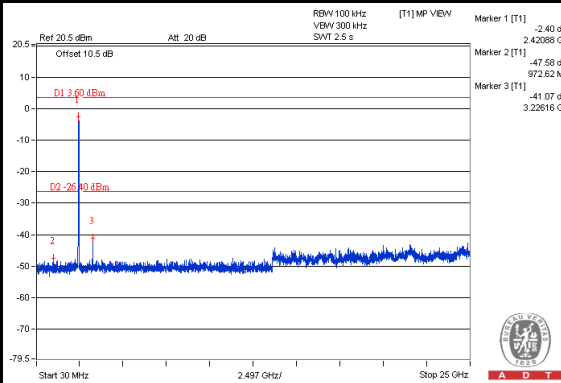

#### CH 6

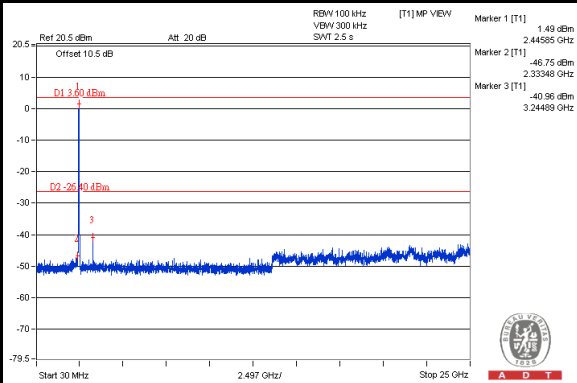

#### CH 9

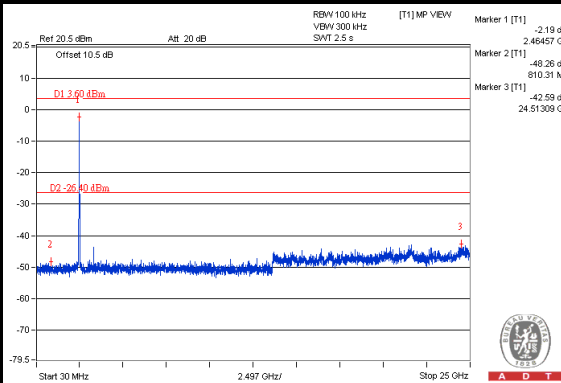



A D T

## 5. TEST TYPES AND RESULTS (FOR 5GHz, 5.725~5.850GHz Band)

### 5.1 CONDUCTED EMISSION MEASUREMENT

#### 5.1.1 LIMITS OF CONDUCTED EMISSION MEASUREMENT

FREQUENCY OF EMISSION (MHz)	CONDUCTED LIMIT (dB $\mu$ V)	
	Quasi-peak	Average
0.15-0.5	66 to 56	56 to 46
0.5-5	56	46
5-30	60	50

- NOTE:** 1. The lower limit shall apply at the transition frequencies.  
2. The limit decreases in line with the logarithm of the frequency in the range of 0.15 to 0.50 MHz.

#### 5.1.2 TEST INSTRUMENTS

DESCRIPTION & MANUFACTURER	MODEL NO.	SERIAL NO.	CALIBRATED DATE	CALIBRATED UNTIL
Test Receiver	ESCS 30	100375	Mar. 08, 2013	Mar. 07, 2014
Line-Impedance Stabilization Network (for EUT) SCHWARZBECK	NSLK8127	8127-522	Sep. 06, 2012	Sep. 05, 2013
Line-Impedance Stabilization Network (for Peripheral)	ENV216	100072	June 07, 2013	June 06, 2014
RF Cable (JYEBAO)	5DFB	COCCAB-001	Mar. 11, 2013	Mar. 10, 2014
50 ohms Terminator	50	EMC-3	Sep. 25, 2012	Sep. 24, 2013
Software ADT	BV ADT_Cond_V7.3.7.3	NA	NA	NA

**Note:**

1. The calibration interval of the above test instruments is 12 months and the calibrations are traceable to NML/ROC and NIST/USA.
2. The test was performed in Shielded Room No. C.
3. The VCCI Con C Registration No. is C-3611.
4. Tested Date: July 29 and Aug. 07, 2013

### 5.1.3 TEST PROCEDURES

- a. The EUT was placed 0.4 meters from the conducting wall of the shielded room with EUT being connected to the power mains through a line impedance stabilization network (LISN). Other support units were connected to the power mains through another LISN.
- b. The two LISNs provide 50 ohm/ 50uH of coupling impedance for the measuring instrument.
- c. Both lines of the power mains connected to the EUT were checked for maximum conducted interference.
- d. The frequency range from 150kHz to 30MHz was searched. Emission levels under (Limit – 20dB) were not recorded.

#### NOTE:

1. The resolution bandwidth of test receiver is 9kHz for Quasi-peak detection (QP) & Average detection (AV).

### 5.1.4 DEVIATION FROM TEST STANDARD

No deviation

### 5.1.5 TEST SETUP

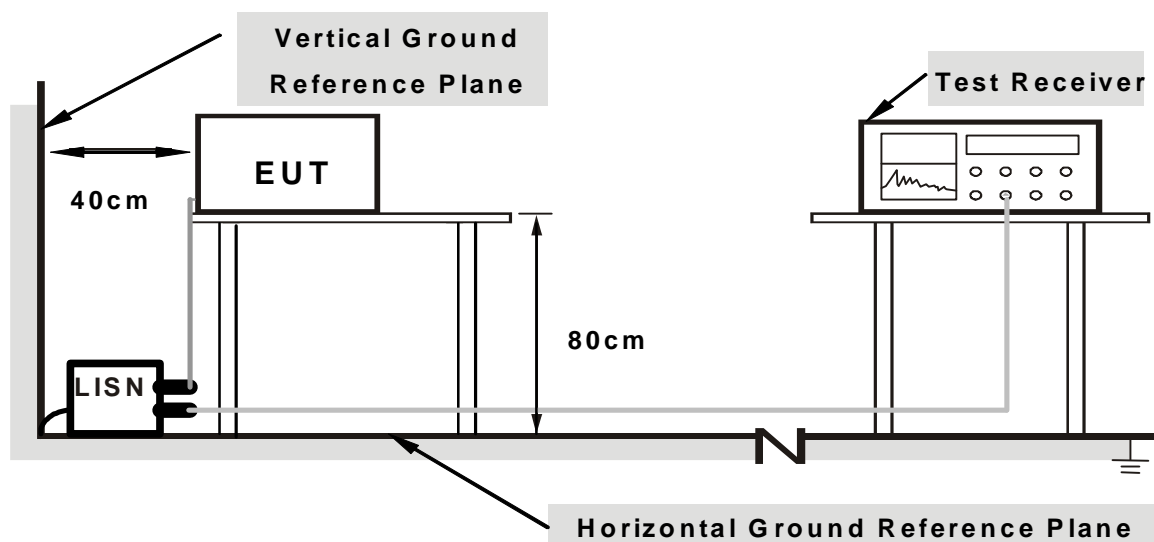

**Note: 1. Support units were connected to second LISN.**

For the actual test configuration, please refer to the related item – Photographs of the Test Configuration.

## 5.1.6 EUT OPERATING CONDITIONS

Same as the 4.1.6



### 5.1.7 TEST RESULTS (MODE 1)

<b>PHASE</b>	Line (L)	<b>DETECTOR FUNCTION</b>	Quasi-Peak (QP) / Average (AV)
--------------	----------	--------------------------	--------------------------------

No	Freq.	Corr.	Reading Value		Emission Level		Limit		Margin	
	[MHz]	Factor	[dB (uV)]		[dB (uV)]		[dB (uV)]		(dB)	
		(dB)	Q.P.	AV.	Q.P.	AV.	Q.P.	AV.	Q.P.	AV.
1	0.15000	0.13	53.12	39.00	53.25	39.13	66.00	56.00	-12.75	-16.87
2	0.38828	0.20	41.24	32.56	41.44	32.76	58.10	48.10	-16.66	-15.34
3	0.47031	0.21	45.08	36.87	45.29	37.08	56.51	46.51	-11.22	-9.43
4	0.65391	0.22	38.91	31.07	39.13	31.29	56.00	46.00	-16.87	-14.71
5	0.92734	0.24	38.11	30.84	38.35	31.08	56.00	46.00	-17.65	-14.92
6	4.41797	0.50	34.24	26.45	34.74	26.95	56.00	46.00	-21.26	-19.05

#### REMARKS:

1. Q.P. and AV. are abbreviations of quasi-peak and average individually.
2. The emission levels of other frequencies were very low against the limit.
3. Margin value = Emission Level – Limit value
4. Correction Factor = Insertion loss + Cable loss
5. Emission Level = Correction Factor + Reading Value

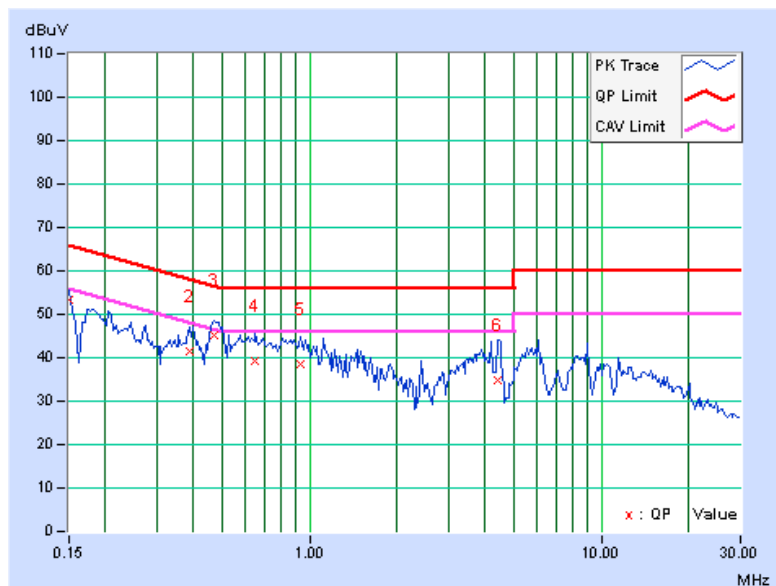

<b>PHASE</b>	Neutral (N)	<b>DETECTOR FUNCTION</b>	Quasi-Peak (QP) / Average (AV)
--------------	-------------	--------------------------	--------------------------------

No	Freq.	Corr.	Reading Value		Emission Level		Limit		Margin	
	[MHz]	(dB)	Q.P.	AV.	Q.P.	AV.	Q.P.	AV.	Q.P.	AV.
1	0.15000	0.11	53.36	39.24	53.47	39.35	66.00	56.00	-12.53	-16.65
2	0.18125	0.12	48.42	38.89	48.54	39.01	64.43	54.43	-15.89	-15.42
3	0.47031	0.19	39.55	31.58	39.74	31.77	56.51	46.51	-16.76	-14.73
4	0.56406	0.20	36.59	27.16	36.79	27.36	56.00	46.00	-19.21	-18.64
5	1.33594	0.25	35.37	28.21	35.62	28.46	56.00	46.00	-20.38	-17.54
6	14.92578	0.96	38.62	33.24	39.58	34.20	60.00	50.00	-20.42	-15.80

**REMARKS:**

1. Q.P. and AV. are abbreviations of quasi-peak and average individually.
2. The emission levels of other frequencies were very low against the limit.
3. Margin value = Emission Level – Limit value
4. Correction Factor = Insertion loss + Cable loss
5. Emission Level = Correction Factor + Reading Value

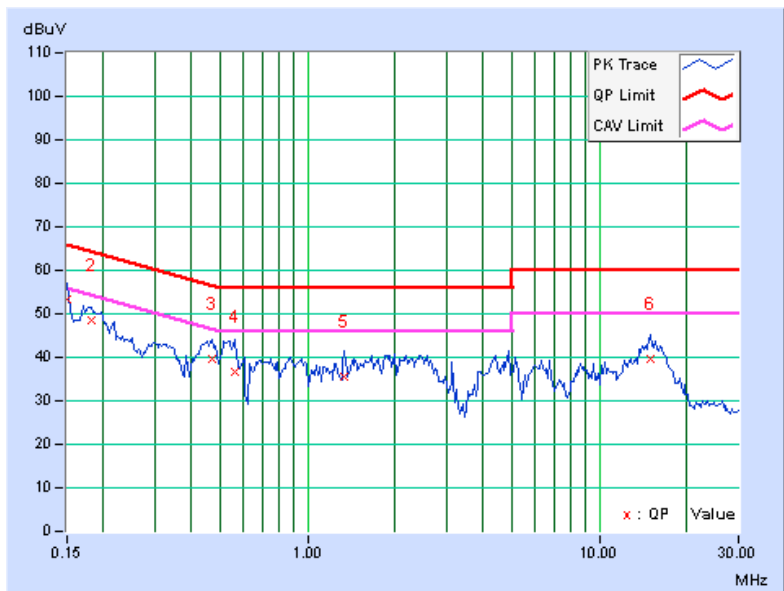



A D T

### 5.1.8 TEST RESULTS (MODE 2)

<b>PHASE</b>	Line (L)	<b>DETECTOR FUNCTION</b>	Quasi-Peak (QP) / Average (AV)
--------------	----------	--------------------------	--------------------------------

No	Freq. [MHz]	Corr. Factor (dB)	Reading Value [dB (uV)]		Emission Level [dB (uV)]		Limit [dB (uV)]		Margin (dB)	
			Q.P.	AV.	Q.P.	AV.	Q.P.	AV.	Q.P.	AV.
1	0.15000	0.13	56.52	46.64	56.65	46.77	66.00	56.00	-9.35	-9.23
2	0.18906	0.15	50.72	38.83	50.87	38.98	64.08	54.08	-13.21	-15.10
3	0.25156	0.16	45.25	31.24	45.41	31.40	61.71	51.71	-16.29	-20.30
4	0.31016	0.18	42.27	27.07	42.45	27.25	59.97	49.97	-17.52	-22.72
5	0.40000	0.20	38.37	25.60	38.57	25.80	57.85	47.85	-19.28	-22.05
6	16.36719	1.27	32.98	25.50	34.25	26.77	60.00	50.00	-25.75	-23.23

#### REMARKS:

1. Q.P. and AV. are abbreviations of quasi-peak and average individually.
2. The emission levels of other frequencies were very low against the limit.
3. Margin value = Emission Level – Limit value
4. Correction Factor = Insertion loss + Cable loss
5. Emission Level = Correction Factor + Reading Value

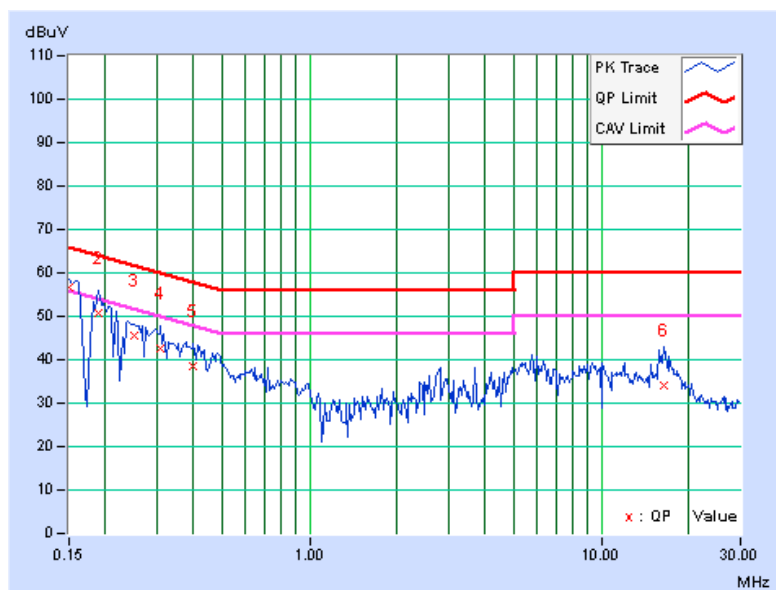

<b>PHASE</b>	Neutral (N)	<b>DETECTOR FUNCTION</b>	Quasi-Peak (QP) / Average (AV)
--------------	-------------	--------------------------	--------------------------------

No	Freq.	Corr.	Reading Value		Emission Level		Limit		Margin	
	[MHz]	(dB)	Q.P.	AV.	Q.P.	AV.	Q.P.	AV.	Q.P.	AV.
1	0.15000	0.11	57.90	47.36	58.01	47.47	66.00	56.00	-7.99	-8.53
2	0.18766	0.13	52.00	39.33	52.13	39.46	64.14	54.14	-12.01	-14.68
3	0.24403	0.14	47.22	35.92	47.36	36.06	61.96	51.96	-14.59	-15.89
4	0.29844	0.16	43.56	30.84	43.72	31.00	60.29	50.29	-16.57	-19.29
5	0.37266	0.18	40.90	25.18	41.08	25.36	58.44	48.44	-17.36	-23.08
6	9.16016	0.70	29.58	21.91	30.28	22.61	60.00	50.00	-29.72	-27.39

**REMARKS:**

1. Q.P. and AV. are abbreviations of quasi-peak and average individually.
2. The emission levels of other frequencies were very low against the limit.
3. Margin value = Emission Level – Limit value
4. Correction Factor = Insertion loss + Cable loss
5. Emission Level = Correction Factor + Reading Value

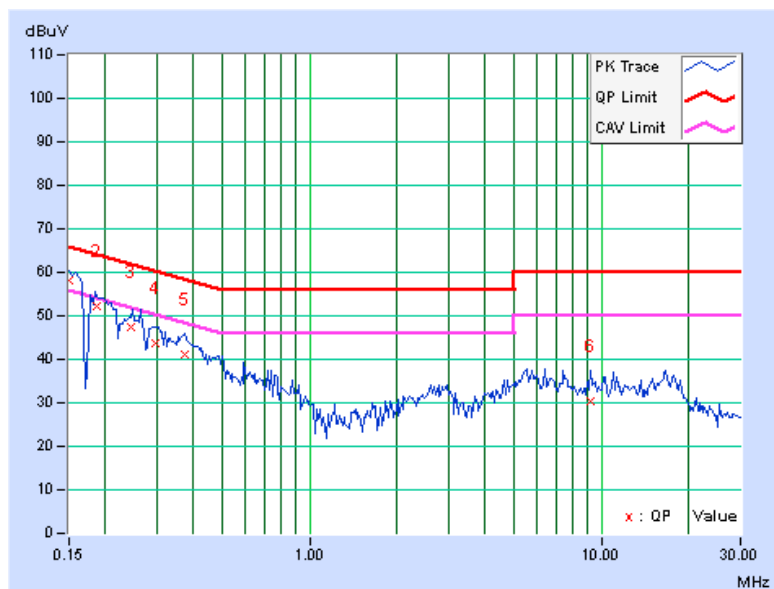



A D T

### 5.1.9 TEST RESULTS (MODE 3)

<b>PHASE</b>	Line (L)	<b>DETECTOR FUNCTION</b>	Quasi-Peak (QP) / Average (AV)
--------------	----------	--------------------------	--------------------------------

No	Freq. [MHz]	Corr. Factor (dB)	Reading Value [dB (uV)]		Emission Level [dB (uV)]		Limit [dB (uV)]		Margin (dB)	
			Q.P.	AV.	Q.P.	AV.	Q.P.	AV.	Q.P.	AV.
1	0.15000	0.13	54.08	41.22	54.21	41.35	66.00	56.00	-11.79	-14.65
2	0.19687	0.15	43.33	25.28	43.48	25.43	63.74	53.74	-20.26	-28.31
3	0.45859	0.20	40.11	30.93	40.31	31.13	56.72	46.72	-16.40	-15.58
4	0.98594	0.25	33.51	24.75	33.76	25.00	56.00	46.00	-22.24	-21.00
5	5.24219	0.56	29.02	21.62	29.58	22.18	60.00	50.00	-30.42	-27.82
6	15.54297	1.23	36.17	30.46	37.40	31.69	60.00	50.00	-22.60	-18.31

#### REMARKS:

1. Q.P. and AV. are abbreviations of quasi-peak and average individually.
2. The emission levels of other frequencies were very low against the limit.
3. Margin value = Emission Level – Limit value
4. Correction Factor = Insertion loss + Cable loss
5. Emission Level = Correction Factor + Reading Value

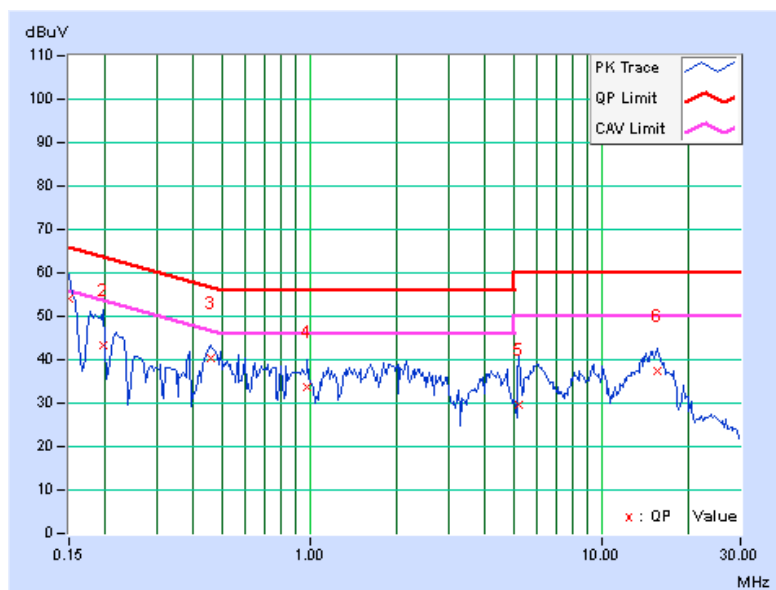

<b>PHASE</b>	Neutral (N)	<b>DETECTOR FUNCTION</b>	Quasi-Peak (QP) / Average (AV)
--------------	-------------	--------------------------	--------------------------------

No	Freq.	Corr.	Reading Value		Emission Level		Limit		Margin	
	[MHz]	(dB)	Q.P.	AV.	Q.P.	AV.	Q.P.	AV.	Q.P.	AV.
1	0.15000	0.11	53.51	41.95	53.62	42.06	66.00	56.00	-12.38	-13.94
2	0.52500	0.20	41.29	30.21	41.49	30.41	56.00	46.00	-14.51	-15.59
3	0.90000	0.21	38.24	30.36	38.45	30.57	56.00	46.00	-17.55	-15.43
4	1.70703	0.28	35.38	23.79	35.66	24.07	56.00	46.00	-20.34	-21.93
5	6.09375	0.54	35.81	24.51	36.35	25.05	60.00	50.00	-23.65	-24.95
6	9.25391	0.70	34.80	29.29	35.50	29.99	60.00	50.00	-24.50	-20.01

**REMARKS:**

1. Q.P. and AV. are abbreviations of quasi-peak and average individually.
2. The emission levels of other frequencies were very low against the limit.
3. Margin value = Emission Level – Limit value
4. Correction Factor = Insertion loss + Cable loss
5. Emission Level = Correction Factor + Reading Value

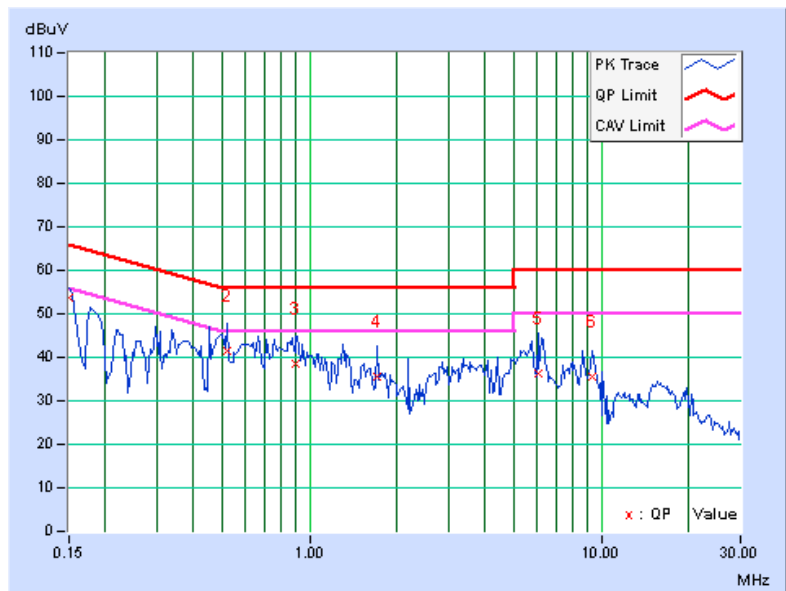



A D T

5.1.10 TEST RESULTS (MODE 4)

PHASE	Line (L)	DETECTOR FUNCTION	Quasi-Peak (QP) / Average (AV)
-------	----------	-------------------	--------------------------------

No	Freq. [MHz]	Corr. Factor (dB)	Reading Value [dB (uV)]		Emission Level [dB (uV)]		Limit [dB (uV)]		Margin (dB)	
			Q.P.	AV.	Q.P.	AV.	Q.P.	AV.	Q.P.	AV.
1	0.15781	0.13	46.47	25.64	46.60	25.77	65.58	55.58	-18.98	-29.81
2	0.20469	0.15	47.81	32.93	47.96	33.08	63.42	53.42	-15.46	-20.34
3	0.32188	0.18	38.43	20.05	38.61	20.23	59.66	49.66	-21.05	-29.43
4	0.42734	0.20	35.34	21.79	35.54	21.99	57.30	47.30	-21.76	-25.31
5	2.88281	0.40	36.55	27.71	36.95	28.11	56.00	46.00	-19.05	-17.89
6	5.92969	0.61	34.76	26.97	35.37	27.58	60.00	50.00	-24.63	-22.42

REMARKS:

1. Q.P. and AV. are abbreviations of quasi-peak and average individually.
2. The emission levels of other frequencies were very low against the limit.
3. Margin value = Emission Level – Limit value
4. Correction Factor = Insertion loss + Cable loss
5. Emission Level = Correction Factor + Reading Value

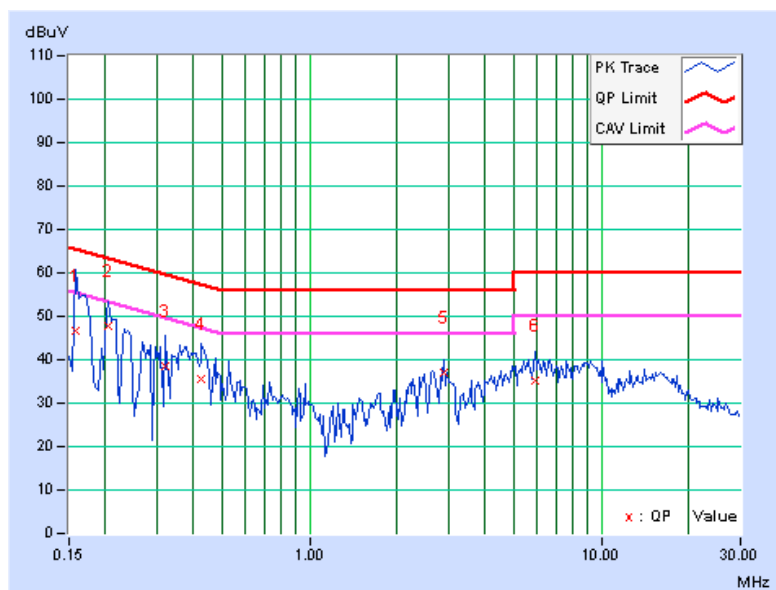

<b>PHASE</b>	Neutral (N)	<b>DETECTOR FUNCTION</b>	Quasi-Peak (QP) / Average (AV)
--------------	-------------	--------------------------	--------------------------------

No	Freq.	Corr.	Reading Value		Emission Level		Limit		Margin	
	[MHz]	(dB)	Q.P.	AV.	Q.P.	AV.	Q.P.	AV.	Q.P.	AV.
1	0.16694	0.12	53.53	38.89	53.65	39.01	65.11	55.11	-11.46	-16.10
2	0.20469	0.13	48.03	32.95	48.16	33.08	63.42	53.42	-15.26	-20.34
3	0.39219	0.19	38.97	25.17	39.16	25.36	58.02	48.02	-18.86	-22.66
4	0.68906	0.20	26.72	9.75	26.92	9.95	56.00	46.00	-29.08	-36.05
5	5.89453	0.53	28.99	21.70	29.52	22.23	60.00	50.00	-30.48	-27.77
6	15.35156	0.97	26.75	20.03	27.72	21.00	60.00	50.00	-32.28	-29.00

**REMARKS:**

1. Q.P. and AV. are abbreviations of quasi-peak and average individually.
2. The emission levels of other frequencies were very low against the limit.
3. Margin value = Emission Level – Limit value
4. Correction Factor = Insertion loss + Cable loss
5. Emission Level = Correction Factor + Reading Value

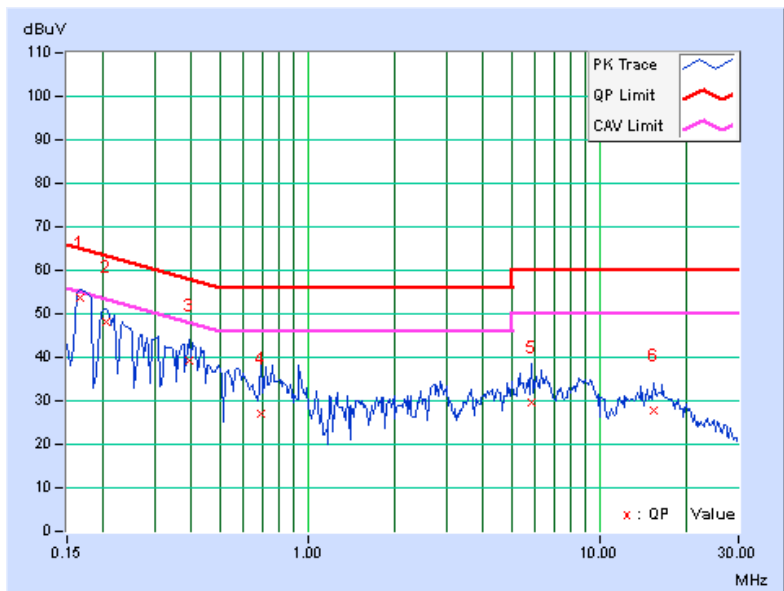





A D T

## 5.2 RADIATED AND BANDEGE EMISSION MEASUREMENT

### 5.2.1 LIMITS OF RADIATED AND BANDEGE EMISSION MEASUREMENT

Radiated emissions which fall in the restricted bands must comply with the radiated emission limits specified as below table. Other emissions shall be at least 30dB below the highest level of the desired power:

Frequencies (MHz)	Field strength (microvolts/meter)	Measurement distance (meters)
0.009-0.490	2400/F(kHz)	300
0.490-1.705	24000/F(kHz)	30
1.705-30.0	30	30
30-88	100	3
88-216	150	3
216-960	200	3
Above 960	500	3

**NOTE:**

1. The lower limit shall apply at the transition frequencies.
2. Emission level (dBuV/m) = 20 log Emission level (uV/m).
3. For frequencies above 1000MHz, the field strength limits are based on average detector, however, the peak field strength of any emission shall not exceed the maximum permitted average limits, specified above by more than 20dB under any condition of modulation.

## 5.2.2 TEST INSTRUMENTS

### For below 1GHz test:

DESCRIPTION & MANUFACTURER	MODEL NO.	SERIAL NO.	CALIBRATED DATE	CALIBRATED UNTIL
Spectrum Analyzer Agilent	E4446A	MY48250253	Sep. 03, 2012	Sep. 02, 2013
MXE EMI Receiver Agilent	N9038A	MY50010156	Jan. 16, 2013	Jan. 15, 2014
Pre-Amplifier Mini-Circuits	ZFL-1000VH2 B	AMP-ZFL-04	Nov. 14, 2012	Nov. 13, 2013
Pre-Amplifier Agilent	8449B	3008A01923	Oct. 30, 2012	Oct. 29, 2013
Pre-Amplifier SPACEK LABS	SLKKa-48-6	9K16	Nov. 14, 2012	Nov. 13, 2013
Trilog Broadband Antenna SCHWARZBECK	VULB 9168	9168-361	Mar. 25, 2013	Mar. 24, 2014
Horn_Antenna AISI	AIH.8018	0000220091110	Nov. 27, 2012	Nov. 26, 2013
Horn_Antenna SCHWARZBECK	BBHA 9170	9170-424	Oct. 12, 2012	Oct. 11, 2013
RF Cable	NA	RF104-205 RF104-207 RF104-202	Dec. 26, 2012	Dec. 25, 2013
RF Cable	NA	CHHCAB_001	Oct. 07, 2012	Oct. 06, 2013
Software	ADT_Radiated _V8.7.05	NA	NA	NA
Antenna Tower & Turn Table CT	NA	NA	NA	NA

### Note:

1. The calibration interval of the above test instruments is 12 months and the calibrations are traceable to NML/ROC and NIST/USA.
2. The horn antenna, preamplifier (model: 8449B) are used only for the measurement of emission frequency above 1GHz if tested.
- 3 The test was performed in 966 Chamber No. H.
4. The FCC Site Registration No. is 797305.
- 5 The CANADA Site Registration No. is IC 7450H-3.
- 6 Tested Date: July 26, 2013



A D T

**For above 1GHz test:**

DESCRIPTION & MANUFACTURER	MODEL NO.	SERIAL NO.	CALIBRATED DATE	CALIBRATED UNTIL
Spectrum Analyzer Agilent	E4446A	MY48250253	Sep. 03, 2012	Sep. 02, 2013
MXE EMI Receiver Agilent	N9038A	MY51210105	Jan. 29,2013	Jan. 28,2014
Pre-Amplifier Mini-Circuits	ZFL-1000VH2 B	AMP-ZFL-03	Nov. 14, 2012	Nov. 13, 2013
Pre-Amplifier Agilent	8449B	3008A02578	June 25, 2013	June 24, 2014
Pre-Amplifier SPACEK LABS	SLKKa-48-6	9K16	Nov. 14, 2012	Nov. 13, 2013
Trilog Broadband Antenna SCHWARZBECK	VULB 9168	9168-360	Mar. 19, 2013	Mar. 18, 2014
Horn_Antenna AISI	AIH.8018	0000320091110	Nov. 19, 2012	Nov. 18, 2013
Horn_Antenna SCHWARZBECK	BBHA 9170	9170-424	Oct. 12, 2012	Oct. 11, 2013
RF Cable	NA	RF104-201 RF104-203 RF104-204	Dec. 25, 2012	Dec. 24, 2013
RF Cable	NA	CHGCAB_001	Oct. 06, 2012	Oct. 05, 2013
Software	ADT_Radiated _V8.7.05	NA	NA	NA
Antenna Tower & Turn Table CT	NA	NA	NA	NA

**Note:**

1. The calibration interval of the above test instruments is 12 months and the calibrations are traceable to NML/ROC and NIST/USA.
2. The horn antenna, preamplifier (model: 8449B) are used only for the measurement of emission frequency above 1GHz if tested.
3. The test was performed in 966 Chamber No. G.
4. The FCC Site Registration No. is 966073.
5. The VCCI Site Registration No. is G-137.
6. The CANADA Site Registration No. is IC 7450H-2.
7. Tested Date: Aug. 09, 2013

### 5.2.3 TEST PROCEDURES

- a. The EUT was placed on the top of a rotating table 0.8 meters above the ground at 3 meter chamber room for test. The table was rotated 360 degrees to determine the position of the highest radiation.
- b. The EUT was set 3 meters away from the interference-receiving antenna, which was mounted on the top of a variable-height antenna tower.
- c. The height of antenna is varied from one meter to four meters above the ground to determine the maximum value of the field strength. Both horizontal and vertical polarizations of the antenna are set to make the measurement.
- d. For each suspected emission, the EUT was arranged to its worst case and then the antenna was tuned to heights from 1 meter to 4 meters and the rotatable table was turned from 0 degrees to 360 degrees to find the maximum reading.
- e. The test-receiver system was set to quasi-peak detect function and specified bandwidth with maximum hold mode when the test frequency is below 1 GHz.
- f. The test-receiver system was set to peak and average detect function and specified bandwidth with maximum hold mode when the test frequency is above 1 GHz. If the peak reading value also meets average limit, measurement with the average detector is unnecessary.

**NOTE:**

1. The resolution bandwidth and video bandwidth of test receiver/spectrum analyzer is 120kHz for Quasi-peak detection (QP) at frequency below 1GHz.
2. The resolution bandwidth of test receiver/spectrum analyzer is 1 MHz and the video bandwidth is 3 MHz for Peak detection (PK) at frequency above 1GHz.
3. The resolution bandwidth of test receiver/spectrum analyzer is 1 MHz and the video bandwidth is 10 Hz for Average detection (AV) at frequency above 1GHz.
4. All modes of operation were investigated and the worst-case emissions are reported.

### 5.2.4 DEVIATION FROM TEST STANDARD

No deviation

### 5.2.5 TEST SETUP

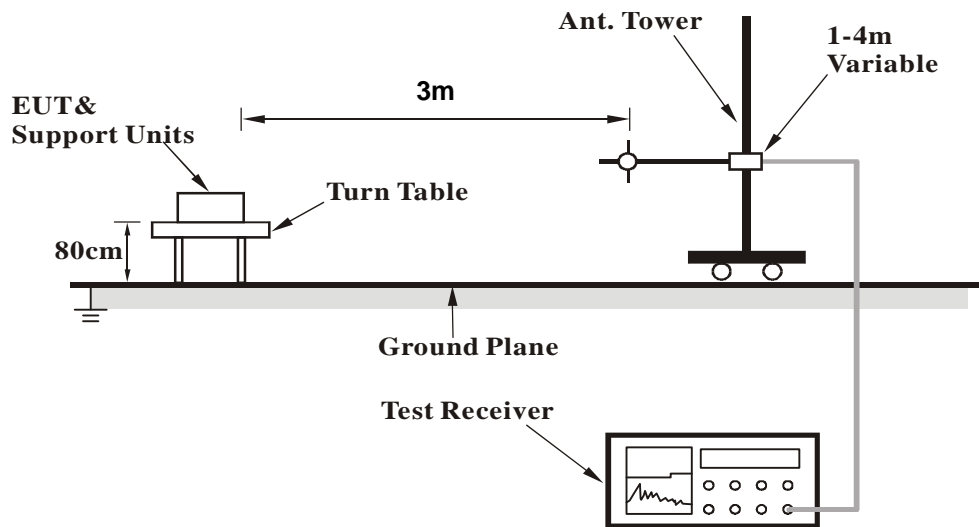

For the actual test configuration, please refer to the related item – Photographs of the Test Configuration.

### 5.2.6 EUT OPERATING CONDITIONS

Same as the 4.1.6



## 5.2.7 TEST RESULTS

### BELOW 1GHz WORST-CASE DATA

#### 802.11n (HT40)

<b>CHANNEL</b>	TX Channel 159	<b>DETECTOR FUNCTION</b>	Quasi-Peak (QP)
<b>FREQUENCY RANGE</b>	Below 1GHz		

#### ANTENNA POLARITY & TEST DISTANCE: HORIZONTAL AT 3 M

NO.	FREQ. (MHz)	EMISSION LEVEL (dBuV/m)	LIMIT (dBuV/m)	MARGIN (dB)	ANTENNA HEIGHT (m)	TABLE ANGLE (Degree)	RAW VALUE (dBuV)	CORRECTION FACTOR (dB/m)
1	55.32	33.6 QP	40.0	-6.4	1.00 H	246	46.82	-13.22
2	106.44	33.5 QP	43.5	-10.0	1.00 H	233	50.12	-16.63
3	171.28	33.1 QP	43.5	-10.4	1.00 H	226	46.66	-13.56
4	275.56	37.7 QP	46.0	-8.3	1.00 H	248	50.85	-13.13
5	293.94	40.5 QP	46.0	-5.5	1.00 H	263	52.96	-12.42
6	408.74	35.2 QP	46.0	-10.9	1.22 H	63	44.89	-9.74

#### ANTENNA POLARITY & TEST DISTANCE: VERTICAL AT 3 M

NO.	FREQ. (MHz)	EMISSION LEVEL (dBuV/m)	LIMIT (dBuV/m)	MARGIN (dB)	ANTENNA HEIGHT (m)	TABLE ANGLE (Degree)	RAW VALUE (dBuV)	CORRECTION FACTOR (dB/m)
1	49.26	35.6 QP	40.0	-4.4	1.00 V	241	49.18	-13.58
2	65.94	36.6 QP	40.0	-3.4	1.00 V	118	51.77	-15.18
3	272.01	39.0 QP	46.0	-7.0	1.00 V	109	52.28	-13.25
4	395.45	41.9 QP	46.0	-4.2	1.00 V	256	51.86	-10.01
5	408.92	38.8 QP	46.0	-7.2	1.00 V	225	48.49	-9.73
6	523.00	35.1 QP	46.0	-10.9	1.00 V	214	42.33	-7.21

#### REMARKS:

1. Emission Level(dBuV/m) = Raw Value(dBuV) + Correction Factor(dB/m)
2. Correction Factor(dB/m) = Antenna Factor(dB/m) + Cable Factor(dB)  
– Pre-Amplifier Factor(dB)
3. The other emission levels were very low against the limit.
4. Margin value = Emission Level – Limit value



## ABOVE 1GHz DATA

### 802.11a

<b>CHANNEL</b>	TX Channel 149	<b>DETECTOR FUNCTION</b>	Peak (PK)
<b>FREQUENCY RANGE</b>	1GHz ~ 40GHz		Average (AV)

ANTENNA POLARITY & TEST DISTANCE: HORIZONTAL AT 3 M								
NO.	FREQ. (MHz)	EMISSION LEVEL (dBuV/m)	LIMIT (dBuV/m)	MARGIN (dB)	ANTENNA HEIGHT (m)	TABLE ANGLE (Degree)	RAW VALUE (dBuV)	CORRECTION FACTOR (dB/m)
1	*5745.00	110.6 PK			1.38 H	43	67.03	43.57
2	*5745.00	100.7 AV			1.38 H	43	57.13	43.57
3	7660.00	57.4 PK	74.0	-16.6	1.04 H	112	8.77	48.63
4	7660.00	47.7 AV	54.0	-6.3	1.04 H	112	-0.93	48.63
5	11490.00	63.4 PK	74.0	-10.6	1.58 H	87	13.42	49.98
6	11490.00	50.9 AV	54.0	-3.1	1.58 H	87	0.92	49.98

ANTENNA POLARITY & TEST DISTANCE: VERTICAL AT 3 M								
NO.	FREQ. (MHz)	EMISSION LEVEL (dBuV/m)	LIMIT (dBuV/m)	MARGIN (dB)	ANTENNA HEIGHT (m)	TABLE ANGLE (Degree)	RAW VALUE (dBuV)	CORRECTION FACTOR (dB/m)
1	*5745.00	120.6 PK			1.02 V	188	77.03	43.57
2	*5745.00	111.2 AV			1.02 V	188	67.63	43.57
3	7660.00	56.9 PK	74.0	-17.1	1.57 V	91	8.27	48.63
4	7660.00	47.2 AV	54.0	-6.8	1.57 V	91	-1.43	48.63
5	11490.00	60.1 PK	74.0	-13.9	1.00 V	103	10.12	49.98
6	11490.00	47.3 AV	54.0	-6.7	1.00 V	103	-2.68	49.98

#### REMARKS:

1. Emission Level(dBuV/m) = Raw Value(dBuV) + Correction Factor(dB/m)
2. Correction Factor(dB/m) = Antenna Factor(dB/m) + Cable Factor(dB)  
– Pre-Amplifier Factor(dB)
3. The other emission levels were very low against the limit.
4. Margin value = Emission Level – Limit value
5. " \* ": Fundamental frequency.



A D T

<b>CHANNEL</b>	TX Channel 157	<b>DETECTOR FUNCTION</b>	Peak (PK)
<b>FREQUENCY RANGE</b>	1GHz ~ 40GHz		Average (AV)

**ANTENNA POLARITY & TEST DISTANCE: HORIZONTAL AT 3 M**

NO.	FREQ. (MHz)	EMISSION LEVEL (dBuV/m)	LIMIT (dBuV/m)	MARGIN (dB)	ANTENNA HEIGHT (m)	TABLE ANGLE (Degree)	RAW VALUE (dBuV)	CORRECTION FACTOR (dB/m)
1	*5785.00	110.3 PK			1.41 H	51	66.63	43.67
2	*5785.00	101.1 AV			1.41 H	51	57.43	43.67
3	7713.30	57.6 PK	74.0	-16.4	1.04 H	112	9.09	48.51
4	7713.30	48.5 AV	54.0	-5.5	1.04 H	112	-0.01	48.51
5	11570.00	66.1 PK	74.0	-7.9	1.59 H	85	16.07	50.03
6	11570.00	53.6 AV	54.0	-0.4	1.59 H	85	3.57	50.03

**ANTENNA POLARITY & TEST DISTANCE: VERTICAL AT 3 M**

NO.	FREQ. (MHz)	EMISSION LEVEL (dBuV/m)	LIMIT (dBuV/m)	MARGIN (dB)	ANTENNA HEIGHT (m)	TABLE ANGLE (Degree)	RAW VALUE (dBuV)	CORRECTION FACTOR (dB/m)
1	*5785.00	120.0 PK			1.04 V	187	76.33	43.67
2	*5785.00	111.1 AV			1.04 V	187	67.43	43.67
3	11570.00	59.6 PK	74.0	-14.4	1.03 V	100	9.57	50.03
4	11570.00	46.8 AV	54.0	-7.2	1.03 V	100	-3.23	50.03

**REMARKS:**

1. Emission Level(dBuV/m) = Raw Value(dBuV) + Correction Factor(dB/m)
2. Correction Factor(dB/m) = Antenna Factor(dB/m) + Cable Factor(dB) – Pre-Amplifier Factor(dB)
3. The other emission levels were very low against the limit.
4. Margin value = Emission Level – Limit value
5. " \* ": Fundamental frequency.





A D T

<b>CHANNEL</b>	TX Channel 165	<b>DETECTOR FUNCTION</b>	Peak (PK)
<b>FREQUENCY RANGE</b>	1GHz ~ 40GHz		Average (AV)

**ANTENNA POLARITY & TEST DISTANCE: HORIZONTAL AT 3 M**

NO.	FREQ. (MHz)	EMISSION LEVEL (dBuV/m)	LIMIT (dBuV/m)	MARGIN (dB)	ANTENNA HEIGHT (m)	TABLE ANGLE (Degree)	RAW VALUE (dBuV)	CORRECTION FACTOR (dB/m)
1	*5825.00	109.8 PK			1.42 H	37	65.97	43.83
2	*5825.00	100.1 AV			1.42 H	37	56.27	43.83
3	11650.00	66.4 PK	74.0	-7.6	1.57 H	86	16.09	50.31
4	11650.00	53.6 AV	54.0	-0.4	1.57 H	86	3.29	50.31

**ANTENNA POLARITY & TEST DISTANCE: VERTICAL AT 3 M**

NO.	FREQ. (MHz)	EMISSION LEVEL (dBuV/m)	LIMIT (dBuV/m)	MARGIN (dB)	ANTENNA HEIGHT (m)	TABLE ANGLE (Degree)	RAW VALUE (dBuV)	CORRECTION FACTOR (dB/m)
1	*5825.00	119.6 PK			1.00 V	176	75.77	43.83
2	*5825.00	110.5 AV			1.00 V	176	66.67	43.83
3	11650.00	60.0 PK	74.0	-14.0	1.05 V	104	9.69	50.31
4	11650.00	47.0 AV	54.0	-7.0	1.05 V	104	-3.31	50.31

**REMARKS:**

1. Emission Level(dBuV/m) = Raw Value(dBuV) + Correction Factor(dB/m)
2. Correction Factor(dB/m) = Antenna Factor(dB/m) + Cable Factor(dB)  
– Pre-Amplifier Factor(dB)
3. The other emission levels were very low against the limit.
4. Margin value = Emission Level – Limit value
5. " \* ": Fundamental frequency.

**802.11n (HT20)**

<b>CHANNEL</b>	TX Channel 149	<b>DETECTOR FUNCTION</b>	Peak (PK)
<b>FREQUENCY RANGE</b>	1GHz ~ 40GHz		Average (AV)

ANTENNA POLARITY & TEST DISTANCE: HORIZONTAL AT 3 M								
NO.	FREQ. (MHz)	EMISSION LEVEL (dBuV/m)	LIMIT (dBuV/m)	MARGIN (dB)	ANTENNA HEIGHT (m)	TABLE ANGLE (Degree)	RAW VALUE (dBuV)	CORRECTION FACTOR (dB/m)
1	*5745.00	110.1 PK			1.39 H	22	66.53	43.57
2	*5745.00	100.4 AV			1.39 H	22	56.83	43.57
3	11490.00	65.2 PK	74.0	-8.8	1.27 H	111	15.22	49.98
4	<b>11490.00</b>	<b>53.7 AV</b>	<b>54.0</b>	<b>-0.3</b>	<b>1.27 H</b>	<b>111</b>	<b>3.72</b>	<b>49.98</b>
ANTENNA POLARITY & TEST DISTANCE: VERTICAL AT 3 M								
NO.	FREQ. (MHz)	EMISSION LEVEL (dBuV/m)	LIMIT (dBuV/m)	MARGIN (dB)	ANTENNA HEIGHT (m)	TABLE ANGLE (Degree)	RAW VALUE (dBuV)	CORRECTION FACTOR (dB/m)
1	*5745.00	122.4 PK			1.02 V	176	78.83	43.57
2	*5745.00	112.6 AV			1.02 V	176	69.03	43.57
3	11490.00	60.8 PK	74.0	-13.2	1.00 V	103	10.82	49.98
4	11490.00	49.2 AV	54.0	-4.8	1.00 V	103	-0.78	49.98

**REMARKS:**

1. Emission Level(dBuV/m) = Raw Value(dBuV) + Correction Factor(dB/m)
2. Correction Factor(dB/m) = Antenna Factor(dB/m) + Cable Factor(dB) – Pre-Amplifier Factor(dB)
3. The other emission levels were very low against the limit.
4. Margin value = Emission Level – Limit value
5. " \* ": Fundamental frequency.



A D T

<b>CHANNEL</b>	TX Channel 157	<b>DETECTOR FUNCTION</b>	Peak (PK)
<b>FREQUENCY RANGE</b>	1GHz ~ 40GHz		Average (AV)

**ANTENNA POLARITY & TEST DISTANCE: HORIZONTAL AT 3 M**

NO.	FREQ. (MHz)	EMISSION LEVEL (dBuV/m)	LIMIT (dBuV/m)	MARGIN (dB)	ANTENNA HEIGHT (m)	TABLE ANGLE (Degree)	RAW VALUE (dBuV)	CORRECTION FACTOR (dB/m)
1	*5785.00	109.1 PK			1.43 H	22	65.43	43.67
2	*5785.00	99.6 AV			1.43 H	22	55.93	43.67
3	11570.00	66.8 PK	74.0	-7.2	1.26 H	113	16.77	50.03
4	11570.00	53.6 AV	54.0	-0.4	1.26 H	113	3.57	50.03

**ANTENNA POLARITY & TEST DISTANCE: VERTICAL AT 3 M**

NO.	FREQ. (MHz)	EMISSION LEVEL (dBuV/m)	LIMIT (dBuV/m)	MARGIN (dB)	ANTENNA HEIGHT (m)	TABLE ANGLE (Degree)	RAW VALUE (dBuV)	CORRECTION FACTOR (dB/m)
1	*5785.00	119.6 PK			1.03 V	188	75.93	43.67
2	*5785.00	111.0 AV			1.03 V	188	67.33	43.67
3	11570.00	61.0 PK	74.0	-13.0	1.01 V	116	10.97	50.03
4	11570.00	49.5 AV	54.0	-4.5	1.01 V	116	-0.53	50.03

**REMARKS:**

1. Emission Level(dBuV/m) = Raw Value(dBuV) + Correction Factor(dB/m)
2. Correction Factor(dB/m) = Antenna Factor(dB/m) + Cable Factor(dB) – Pre-Amplifier Factor(dB)
3. The other emission levels were very low against the limit.
4. Margin value = Emission Level – Limit value
5. " \* ": Fundamental frequency.



A D T

<b>CHANNEL</b>	TX Channel 165	<b>DETECTOR FUNCTION</b>	Peak (PK)
<b>FREQUENCY RANGE</b>	1GHz ~ 40GHz		Average (AV)

**ANTENNA POLARITY & TEST DISTANCE: HORIZONTAL AT 3 M**

NO.	FREQ. (MHz)	EMISSION LEVEL (dBuV/m)	LIMIT (dBuV/m)	MARGIN (dB)	ANTENNA HEIGHT (m)	TABLE ANGLE (Degree)	RAW VALUE (dBuV)	CORRECTION FACTOR (dB/m)
1	*5825.00	109.2 PK			1.46 H	30	65.37	43.83
2	*5825.00	99.4 AV			1.46 H	30	55.57	43.83
3	11650.00	65.3 PK	74.0	-8.7	1.27 H	108	14.99	50.31
4	11650.00	53.5 AV	54.0	-0.5	1.27 H	108	3.19	50.31

**ANTENNA POLARITY & TEST DISTANCE: VERTICAL AT 3 M**

NO.	FREQ. (MHz)	EMISSION LEVEL (dBuV/m)	LIMIT (dBuV/m)	MARGIN (dB)	ANTENNA HEIGHT (m)	TABLE ANGLE (Degree)	RAW VALUE (dBuV)	CORRECTION FACTOR (dB/m)
1	*5825.00	119.8 PK			1.10 V	197	75.97	43.83
2	*5825.00	110.6 AV			1.10 V	197	66.77	43.83
3	11650.00	60.9 PK	74.0	-13.1	1.04 V	121	10.59	50.31
4	11650.00	49.4 AV	54.0	-4.6	1.04 V	121	-0.91	50.31

**REMARKS:**

1. Emission Level(dBuV/m) = Raw Value(dBuV) + Correction Factor(dB/m)
2. Correction Factor(dB/m) = Antenna Factor(dB/m) + Cable Factor(dB) – Pre-Amplifier Factor(dB)
3. The other emission levels were very low against the limit.
4. Margin value = Emission Level – Limit value
5. " \* ": Fundamental frequency.



A D T

802.11n (HT40)

<b>CHANNEL</b>	TX Channel 151	<b>DETECTOR FUNCTION</b>	Peak (PK)
<b>FREQUENCY RANGE</b>	1GHz ~ 40GHz		Average (AV)

**ANTENNA POLARITY & TEST DISTANCE: HORIZONTAL AT 3 M**

NO.	FREQ. (MHz)	EMISSION LEVEL (dBuV/m)	LIMIT (dBuV/m)	MARGIN (dB)	ANTENNA HEIGHT (m)	TABLE ANGLE (Degree)	RAW VALUE (dBuV)	CORRECTION FACTOR (dB/m)
1	*5755.00	109.2 PK			1.38 H	61	65.61	43.59
2	*5755.00	100.3 AV			1.38 H	61	56.71	43.59
3	11510.00	66.2 PK	74.0	-7.8	1.29 H	108	16.23	49.97
4	11510.00	53.5 AV	54.0	-0.5	1.29 H	108	3.53	49.97

**ANTENNA POLARITY & TEST DISTANCE: VERTICAL AT 3 M**

NO.	FREQ. (MHz)	EMISSION LEVEL (dBuV/m)	LIMIT (dBuV/m)	MARGIN (dB)	ANTENNA HEIGHT (m)	TABLE ANGLE (Degree)	RAW VALUE (dBuV)	CORRECTION FACTOR (dB/m)
1	*5755.00	122.4 PK			1.01 V	175	78.81	43.59
2	*5755.00	111.9 AV			1.01 V	175	68.31	43.59
3	11510.00	60.3 PK	74.0	-13.7	1.04 V	106	10.33	49.97
4	11510.00	49.0 AV	54.0	-5.0	1.04 V	106	-0.97	49.97

**REMARKS:**

1. Emission Level(dBuV/m) = Raw Value(dBuV) + Correction Factor(dB/m)
2. Correction Factor(dB/m) = Antenna Factor(dB/m) + Cable Factor(dB) – Pre-Amplifier Factor(dB)
3. The other emission levels were very low against the limit.
4. Margin value = Emission Level – Limit value
5. " \* " : Fundamental frequency.



<b>CHANNEL</b>	TX Channel 159	<b>DETECTOR FUNCTION</b>	Peak (PK)
<b>FREQUENCY RANGE</b>	1GHz ~ 40GHz		Average (AV)

**ANTENNA POLARITY & TEST DISTANCE: HORIZONTAL AT 3 M**

NO.	FREQ. (MHz)	EMISSION LEVEL (dBuV/m)	LIMIT (dBuV/m)	MARGIN (dB)	ANTENNA HEIGHT (m)	TABLE ANGLE (Degree)	RAW VALUE (dBuV)	CORRECTION FACTOR (dB/m)
1	*5795.00	110.1 PK			1.42 H	37	66.40	43.70
2	*5795.00	101.0 AV			1.42 H	37	57.30	43.70
3	11590.00	65.8 PK	74.0	-8.2	1.28 H	113	15.75	50.05
4	11590.00	53.3 AV	54.0	-0.7	1.28 H	113	3.25	50.05

**ANTENNA POLARITY & TEST DISTANCE: VERTICAL AT 3 M**

NO.	FREQ. (MHz)	EMISSION LEVEL (dBuV/m)	LIMIT (dBuV/m)	MARGIN (dB)	ANTENNA HEIGHT (m)	TABLE ANGLE (Degree)	RAW VALUE (dBuV)	CORRECTION FACTOR (dB/m)
1	*5795.00	122.0 PK			1.06 V	171	78.30	43.70
2	*5795.00	111.4 AV			1.06 V	171	67.70	43.70
3	11590.00	60.8 PK	74.0	-13.2	1.05 V	107	10.75	50.05
4	11590.00	49.3 AV	54.0	-4.7	1.05 V	107	-0.75	50.05

**REMARKS:**

1. Emission Level(dBuV/m) = Raw Value(dBuV) + Correction Factor(dB/m)
2. Correction Factor(dB/m) = Antenna Factor(dB/m) + Cable Factor(dB)  
– Pre-Amplifier Factor(dB)
3. The other emission levels were very low against the limit.
4. Margin value = Emission Level – Limit value
5. " \* ": Fundamental frequency.

**802.11ac (VHT80)**

<b>CHANNEL</b>	TX Channel 155	<b>DETECTOR FUNCTION</b>	Peak (PK)
<b>FREQUENCY RANGE</b>	1GHz ~ 40GHz		Average (AV)

<b>ANTENNA POLARITY &amp; TEST DISTANCE: HORIZONTAL AT 3 M</b>								
<b>NO.</b>	<b>FREQ. (MHz)</b>	<b>EMISSION LEVEL (dBuV/m)</b>	<b>LIMIT (dBuV/m)</b>	<b>MARGIN (dB)</b>	<b>ANTENNA HEIGHT (m)</b>	<b>TABLE ANGLE (Degree)</b>	<b>RAW VALUE (dBuV)</b>	<b>CORRECTION FACTOR (dB/m)</b>
1	*5775.00	109.8 PK			1.38 H	53	66.15	43.65
2	*5775.00	100.8 AV			1.38 H	53	57.15	43.65
3	11550.00	64.5 PK	74.0	-9.5	1.32 H	105	14.49	50.01
4	11550.00	52.1 AV	54.0	-1.9	1.32 H	105	2.09	50.01
<b>ANTENNA POLARITY &amp; TEST DISTANCE: VERTICAL AT 3 M</b>								
<b>NO.</b>	<b>FREQ. (MHz)</b>	<b>EMISSION LEVEL (dBuV/m)</b>	<b>LIMIT (dBuV/m)</b>	<b>MARGIN (dB)</b>	<b>ANTENNA HEIGHT (m)</b>	<b>TABLE ANGLE (Degree)</b>	<b>RAW VALUE (dBuV)</b>	<b>CORRECTION FACTOR (dB/m)</b>
1	*5775.00	119.3 PK			1.02 V	170	75.65	43.65
2	*5775.00	109.4 AV			1.02 V	170	65.75	43.65
3	11550.00	60.9 PK	74.0	-13.1	1.01 V	111	10.89	50.01
4	11550.00	49.1 AV	54.0	-4.9	1.01 V	111	-0.91	50.01

**REMARKS:**

1. Emission Level(dBuV/m) = Raw Value(dBuV) + Correction Factor(dB/m)
2. Correction Factor(dB/m) = Antenna Factor(dB/m) + Cable Factor(dB)  
– Pre-Amplifier Factor(dB)
3. The other emission levels were very low against the limit.
4. Margin value = Emission Level – Limit value
5. " \* ": Fundamental frequency.

### 5.3 6dB BANDWIDTH MEASUREMENT

#### 5.3.1 LIMITS OF 6dB BANDWIDTH MEASUREMENT

The minimum of 6dB Bandwidth Measurement is 0.5 MHz.

#### 5.3.2 TEST INSTRUMENTS

DESCRIPTION & MANUFACTURER	MODEL NO.	SERIAL NO.	CALIBRATED DATE	CALIBRATED UNTIL
Spectrum Analyzer R&S	FSP 40	100036	Jan. 21, 2013	Jan. 20, 2014

**Note:**

1. The calibration interval of the above test instruments is 12 months and the calibrations are traceable to NML/ROC and NIST/USA.
2. Tested date : Aug. 08, 2013

#### 5.3.3 TEST PROCEDURE

1. Set resolution bandwidth (RBW) = 100kHz
2. Set the video bandwidth (VBW)  $\geq 3 \times$  RBW, Detector = Peak.
3. Trace mode = max hold.
4. Sweep = auto couple.
5. Measure the maximum width of the emission that is constrained by the frequencies associated with the two amplitude points (upper and lower) that are attenuated by 6 dB relative to the maximum level measured in the fundamental emission

#### 5.3.4 DEVIATION FROM TEST STANDARD

No deviation

#### 5.3.5 TEST SETUP

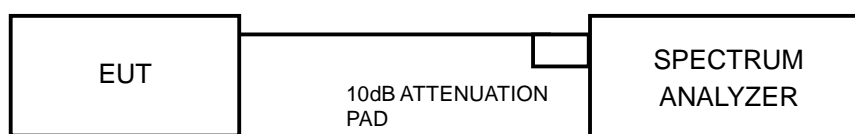

#### 5.3.6 EUT OPERATING CONDITIONS

The software provided by client to enable the EUT under transmission condition continuously at lowest, middle and highest channel frequencies individually.





A D T

### 5.3.7 TEST RESULTS

#### 802.11a

CHANNEL	CHANNEL FREQUENCY (MHz)	6dB BANDWIDTH (MHz)	MINIMUM LIMIT (MHz)	PASS / FAIL
149	5745	16.40	0.5	PASS
157	5785	16.37	0.5	PASS
165	5825	16.37	0.5	PASS

#### 802.11n (HT20)

CHANNEL	CHANNEL FREQUENCY (MHz)	6dB BANDWIDTH (MHz)			MINIMUM LIMIT (MHz)	PASS / FAIL
		CHAIN 0	CHAIN 1	CHAIN 2		
149	5745	17.65	17.66	17.65	0.5	PASS
157	5785	17.64	17.66	17.62	0.5	PASS
165	5825	17.63	17.67	17.64	0.5	PASS

#### 802.11n (HT40)

CHANNEL	CHANNEL FREQUENCY (MHz)	6dB BANDWIDTH (MHz)			MINIMUM LIMIT (MHz)	PASS / FAIL
		CHAIN 0	CHAIN 1	CHAIN 2		
151	5755	36.34	36.46	36.44	0.5	PASS
159	5795	36.23	36.44	36.46	0.5	PASS

#### 802.11ac (VHT80)

CHANNEL	CHANNEL FREQUENCY (MHz)	6dB BANDWIDTH (MHz)			MINIMUM LIMIT (MHz)	PASS / FAIL
		CHAIN 0	CHAIN 1	CHAIN 2		
155	5775	75.73	76.22	75.74	0.5	PASS

## 5.4 CONDUCTED OUTPUT POWER MEASUREMENT

### 5.4.1 LIMITS OF CONDUCTED OUTPUT POWER MEASUREMENT

For systems using digital modulation in the 5725 –5850 MHz band: 1 Watt (30dBm)

Per KDB 662911 D01 Multiple Transmitter Output v01r02 Method of conducted output power measurement on IEEE 802.11 devices,

Array Gain = 0 dB (i.e., no array gain) for NANT  $\leq$  4;

Array Gain = 0 dB (i.e., no array gain) for channel widths  $\geq$  40 MHz for any NANT;

Array Gain = 5 log(NANT/NSS) dB or 3 dB, whichever is less for 20-MHz channel widths with NANT  $\geq$  5.

For power measurements on all other devices: Array Gain = 10 log(NANT/NSS) dB.

### 5.4.2 INSTRUMENTS

DESCRIPTION & MANUFACTURER	MODEL NO.	SERIAL NO.	CALIBRATED DATE	CALIBRATED UNTIL
Power meter Anritsu	ML2495A	0824006	May 20, 2013	May 19, 2014
Power sensor Anritsu	MA2411B	0738172	May 20, 2013	May 19, 2014

**Note:**

1. The calibration interval of the above test instruments is 12 months and the calibrations are traceable to NML/ROC and NIST/USA.
2. Tested date : Aug. 08, 2013

### 5.4.3 TEST PROCEDURES

Method PM is used to perform output power measurement, trigger and gating function of wide band power meter is enabled to measure max output power of TX on burst. Duty factor is not added to measured value.

Duty cycle of test signal is < 98 %. Method PM is used to perform output power measurement, trigger and gating function of wide band power meter is enabled to measure max output power of TX on burst. Duty factor is not added to measured value.

#### 5.4.4 DEVIATION FROM TEST STANDARD

No deviation.

#### 5.4.5 TEST SETUP

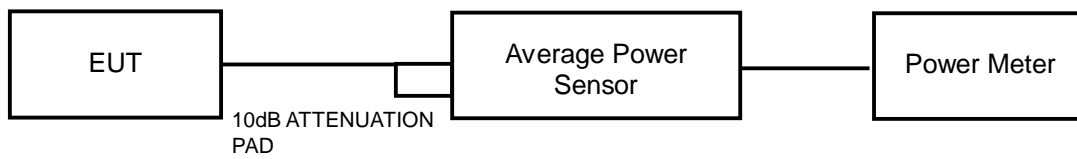

#### 5.4.6 EUT OPERATING CONDITIONS

Same as Item 5.3.6



A D T

## 5.4.7 TEST RESULTS

### 802.11a

CHANNEL	FREQUENCY (MHz)	AVERAGE POWER (mW)	AVERAGE POWER (dBm)	LIMIT (dBm)	PASS/FAIL
149	5745	187.932	22.74	30	PASS
157	5785	227.510	23.57	30	PASS
165	5825	195.884	22.92	30	PASS

### 802.11n (HT20)

CHANNEL	FREQUENCY (MHz)	AVERAGE POWER (dBm)			TOTAL POWER (mW)	TOTAL POWER (dBm)	LIMIT (dBm)	PASS / FAIL
		CHAIN 0	CHAIN 1	CHAIN 2				
149	5745	21.77	21.46	21.75	439.897	26.43	30	PASS
157	5785	20.67	20.31	20.57	338.105	25.29	30	PASS
165	5825	20.01	19.75	19.93	293.038	24.67	30	PASS

### 802.11n (HT40)

CHANNEL	FREQUENCY (MHz)	AVERAGE POWER (dBm)			TOTAL POWER (mW)	TOTAL POWER (dBm)	LIMIT (dBm)	PASS / FAIL
		CHAIN 0	CHAIN 1	CHAIN 2				
151	5755	20.88	20.75	20.93	365.192	25.63	30	PASS
159	5795	23.91	23.32	23.88	705.163	28.48	30	PASS

### 802.11ac (VHT80)

CHANNEL	FREQUENCY (MHz)	AVERAGE POWER (dBm)			TOTAL POWER (mW)	TOTAL POWER (dBm)	LIMIT (dBm)	PASS / FAIL
		CHAIN 0	CHAIN 1	CHAIN 2				
155	5775	19.91	19.57	19.76	283.146	24.52	30	PASS

## 5.5 POWER SPECTRAL DENSITY MEASUREMENT

### 5.5.1 LIMITS OF POWER SPECTRAL DENSITY MEASUREMENT

The Maximum of Power Spectral Density Measurement is 8dBm.

### 5.5.2 TEST INSTRUMENTS

DESCRIPTION & MANUFACTURER	MODEL NO.	SERIAL NO.	CALIBRATED DATE	CALIBRATED UNTIL
Spectrum Analyzer R&S	FSP 40	100036	Jan. 21, 2013	Jan. 20, 2014

**Note:**

1. The calibration interval of the above test instruments is 12 months and the calibrations are traceable to NML/ROC and NIST/USA.
2. Tested date : June 24, 2013

### 5.5.3 TEST PROCEDURE

1. Set the RBW = 3 kHz, VBW =10 kHz, Detector = peak.
2. Sweep time = auto couple, Trace mode = max hold, allow trace to fully stabilize.
3. Use the peak marker function to determine the maximum amplitude level.

### 5.5.4 DEVIATION FROM TEST STANDARD

No deviation

### 5.5.5 TEST SETUP

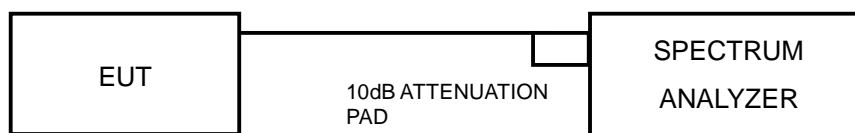

### 5.5.6 EUT OPERATING CONDITION

Same as Item 4.3.6



A D T

## 5.5.7 TEST RESULTS

### 802.11a

CHANNEL	FREQUENCY (MHz)	PSD (dBm/30kHz)	PSD (dBm/3kHz)	LIMIT (dBm/3kHz)	PASS /FAIL
149	5745	-4.49	-14.49	8	PASS
157	5785	-3.77	-13.77	8	PASS
165	5825	-4.64	-14.64	8	PASS

### 802.11n (HT20)

TX chain	Channel	FREQ. (MHz)	PSD (dBm/30kHz)	PSD (dBm/3kHz)	10 log (N=3) dB	Total PSD (dBm/3kHz)	Limit (dBm/3kHz)	PASS /FAIL
0	149	5745	-6.38	-16.38	4.77	-11.61	3.61	PASS
	157	5785	-7.51	-17.51	4.77	-12.74	3.61	PASS
	165	5825	-8.21	-18.21	4.77	-13.44	3.61	PASS
1	149	5745	-6.33	-16.33	4.77	-11.56	3.61	PASS
	157	5785	-7.69	-17.69	4.77	-12.92	3.61	PASS
	165	5825	-8.59	-18.59	4.77	-13.82	3.61	PASS
2	149	5745	-6.38	-16.38	4.77	-11.61	3.61	PASS
	157	5785	-7.37	-17.37	4.77	-12.60	3.61	PASS
	165	5825	-8.24	-18.24	4.77	-13.47	3.61	PASS

**NOTE:** 1. Directional gain =  $10 \log[(10^{G1/20} + 10^{G2/20} + 10^{G3/20})^2 / 3] = 10.39\text{dBi} > 6\text{dBi}$  , so the power density limit shall be reduced to  $8-(10.39-6) = 3.61\text{dBm}$ .



**802.11n (HT40)**

TX chain	Channel	FREQ. (MHz)	PSD (dBm/30kHz)	PSD (dBm/3kHz)	10 log (N=3) dB	Total PSD (dBm/3kHz)	Limit (dBm/3kHz)	PASS /FAIL
0	151	5755	-9.62	-19.62	4.77	-14.85	3.61	PASS
	159	5795	-6.74	-16.74	4.77	-11.97	3.61	PASS
1	151	5755	-10.00	-20.00	4.77	-15.23	3.61	PASS
	159	5795	-7.77	-17.77	4.77	-13.00	3.61	PASS
2	151	5755	-9.79	-19.79	4.77	-15.02	3.61	PASS
	159	5795	-6.37	-16.37	4.77	-11.60	3.61	PASS

**NOTE:** 1. Directional gain =  $10 \log[(10^{G1/20} + 10^{G2/20} + 10^{G3/20})^2 / 3] = 10.39\text{dBi} > 6\text{dBi}$  , so the power density limit shall be reduced to  $8-(10.39-6) = 3.61\text{dBm}$ .

**802.11ac (VHT80)**

TX chain	CHAN.	FREQ. (MHz)	PSD W/O DUTY FACTOR (dBm/30kHz)	PSD W/O DUTY FACTOR (dBm/3kHz)	10 log (N=3) dB	DUTY FACTOR (dB)	Total PSD WITH DUTY FACTOR (dBm/3kHz)	Limit (dBm/3kHz)	PASS /FAIL
0	155	5775	-13.93	-23.93	4.77	0.16	-19.00	3.61	PASS
1	155	5775	-13.25	-23.25	4.77	0.16	-18.32	3.61	PASS
2	155	5775	-13.37	-23.37	4.77	0.16	-18.44	3.61	PASS

**NOTE:** 1. Directional gain =  $10 \log[(10^{G1/20} + 10^{G2/20} + 10^{G3/20})^2 / 3] = 10.39\text{dBi} > 6\text{dBi}$  , so the power density limit shall be reduced to  $8-(10.39-6) = 3.61\text{dBm}$ .

2. Refer to section 3.4 for duty cycle spectrum plot.

## 5.6 CONDUCTED OUT-BAND EMISSION MEASUREMENT

### 5.6.1 LIMITS OF CONDUCTED OUT-BAND EMISSION MEASUREMENT

Below 30dB of the highest emission level of operating band (in 100kHz Resolution Bandwidth).

### 5.6.2 TEST INSTRUMENTS

DESCRIPTION & MANUFACTURER	MODEL NO.	SERIAL NO.	CALIBRATED DATE	CALIBRATED UNTIL
Spectrum Analyzer R&S	FSP 40	100036	Jan. 21, 2013	Jan. 20, 2014

**Note:**

1. The calibration interval of the above test instruments is 12 months and the calibrations are traceable to NML/ROC and NIST/USA.
2. Tested date : Aug. 08, 2013

### 5.6.3 TEST PROCEDURE

**Measurement Procedure - Reference Level**

1. Set the RBW = 100 kHz.
2. Set the VBW  $\geq$  300 kHz.
3. Detector = peak.
4. Sweep time = auto couple.
5. Trace mode = max hold.
6. Allow trace to fully stabilize.
7. Use the peak marker function to determine the maximum power level in any 100 kHz band segment within the fundamental EBW.

**Measurement Procedure –Unwanted Emission Level**

1. Set RBW = 100 kHz.
2. Set VBW  $\geq$  300 kHz.
3. Set span to encompass the spectrum to be examined
4. Detector = peak.
5. Trace Mode = max hold.
6. Sweep = auto couple.



#### 5.6.4 DEVIATION FROM TEST STANDARD

No deviation

#### 5.6.5 TEST SETUP

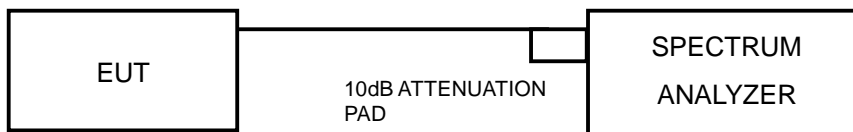

#### 5.6.6 EUT OPERATING CONDITION

Same as Item 4.3.6

#### 5.6.7 TEST RESULTS

The spectrum plots are attached on the following pages. D1 line indicates the highest level, and D2 line indicates the 30dB offset below D1. It shows compliance with the requirement.



A D T

802.11a

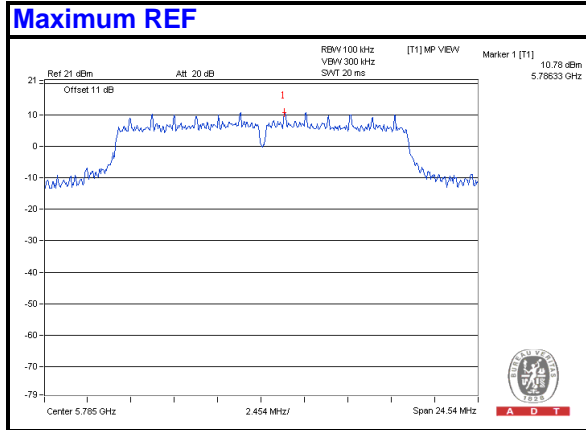

### CH 149

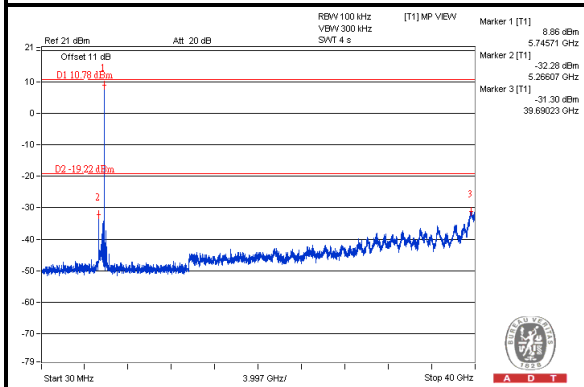

### CH 157

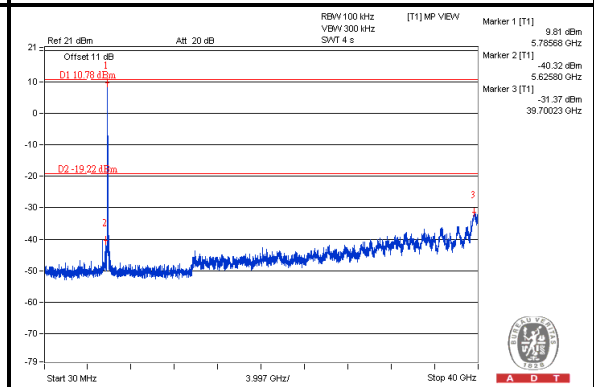

### CH 165

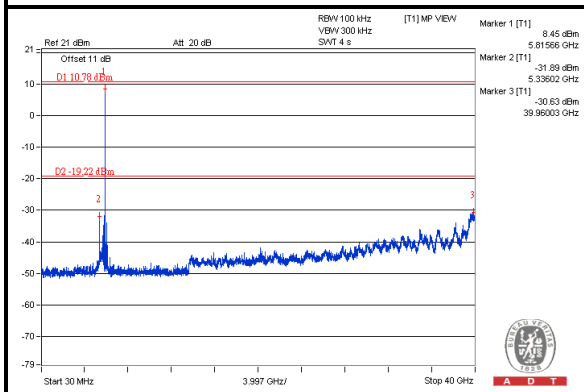



A D T

### 802.11n (HT20):

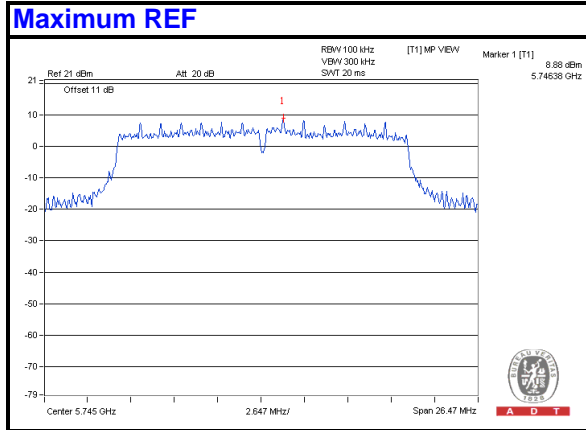

### For Chain 0

#### CH 149

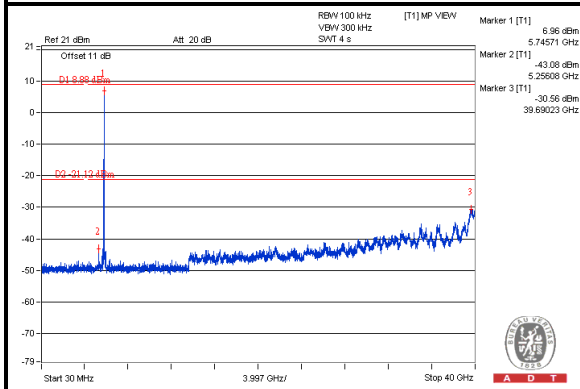

#### CH 157

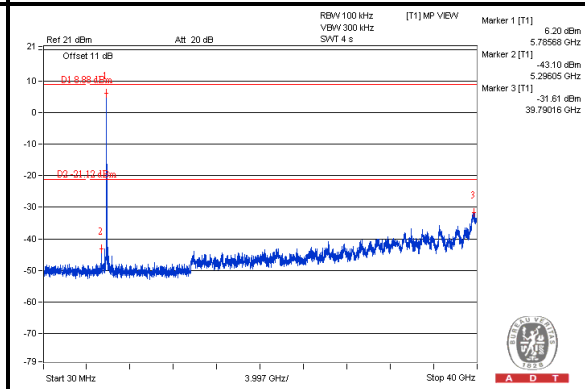

#### CH 165

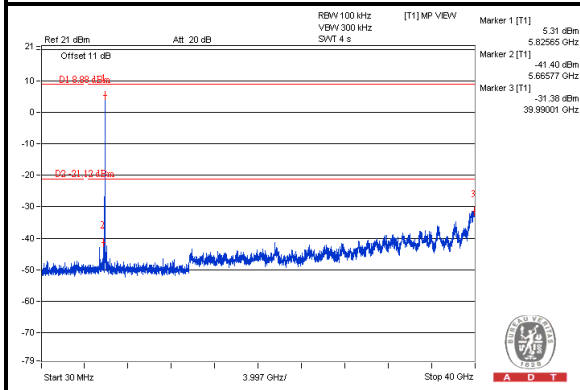



A D T

### For Chain 1

#### CH 149

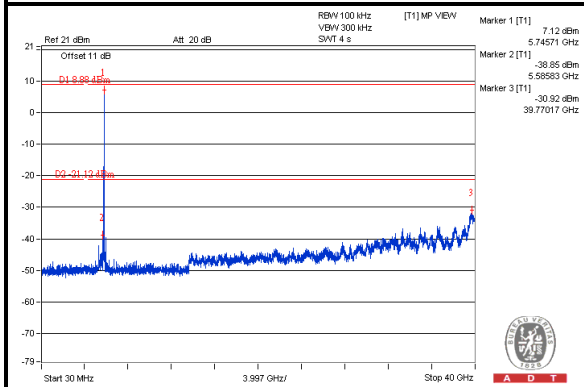

#### CH 157

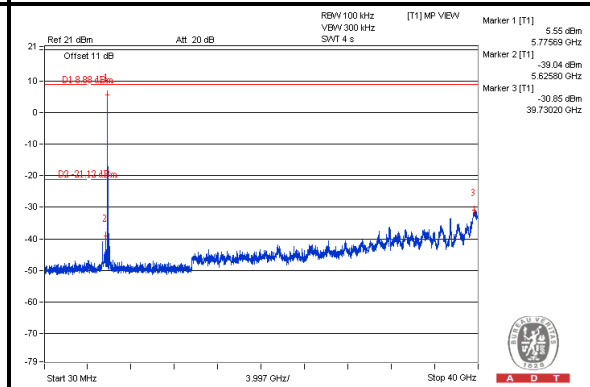

#### CH 165

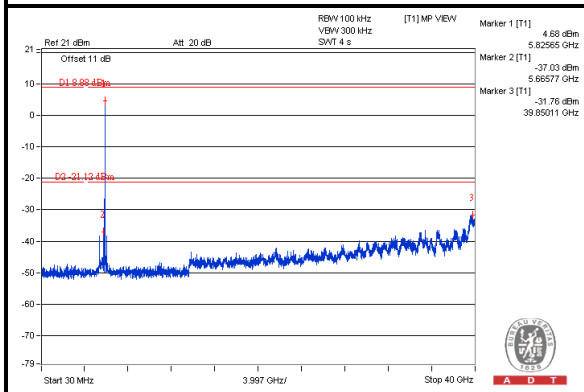



A D T

### For Chain 2

#### CH 149

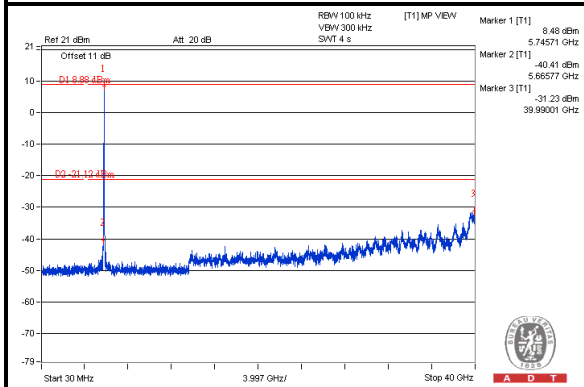

#### CH 157

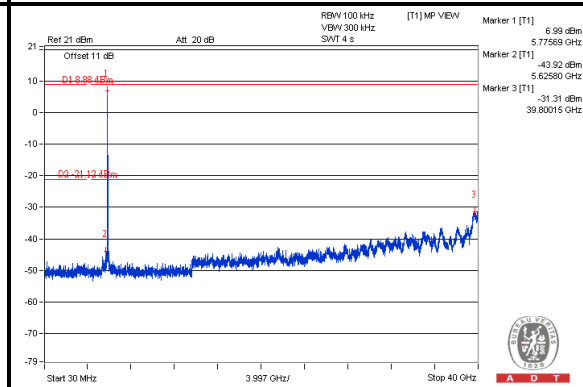

#### CH 165

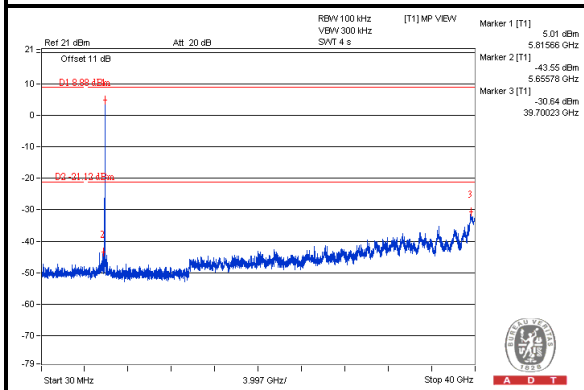



A D T

802.11n (HT40):

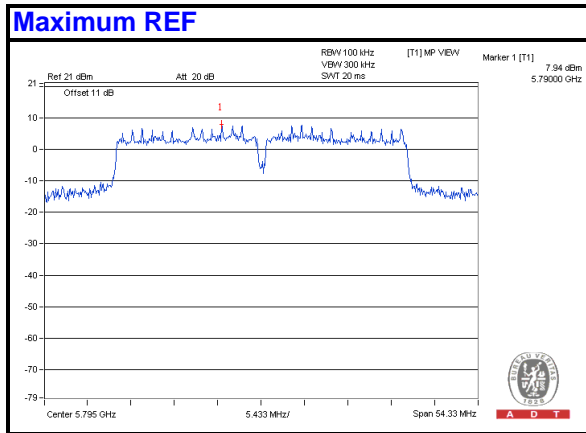

For Chain 0

CH 151

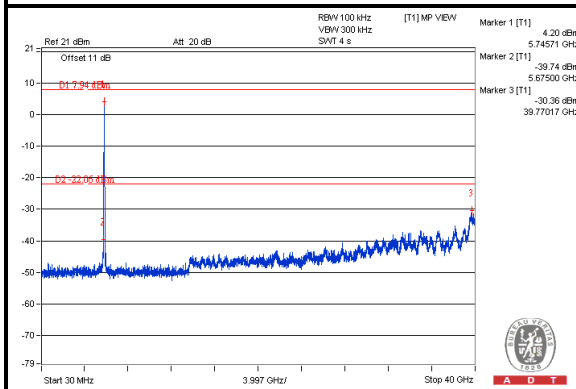

CH 159

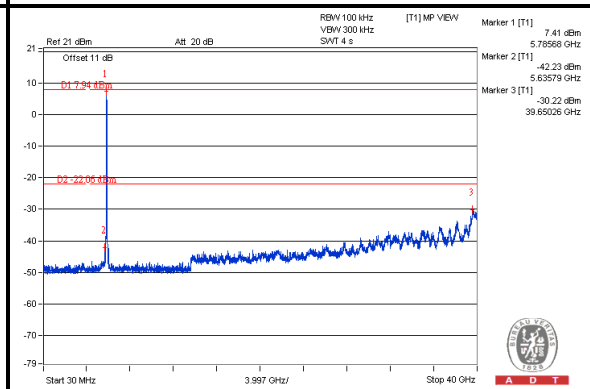

For Chain 1

CH 151

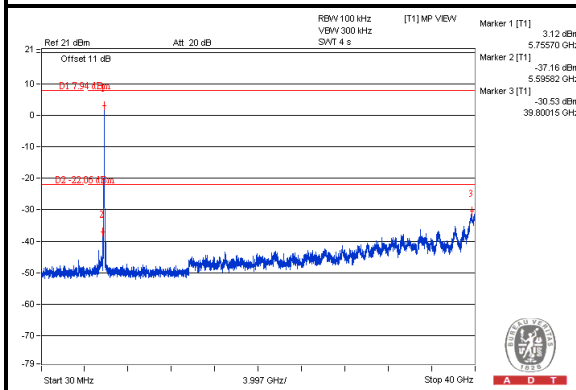

CH 159

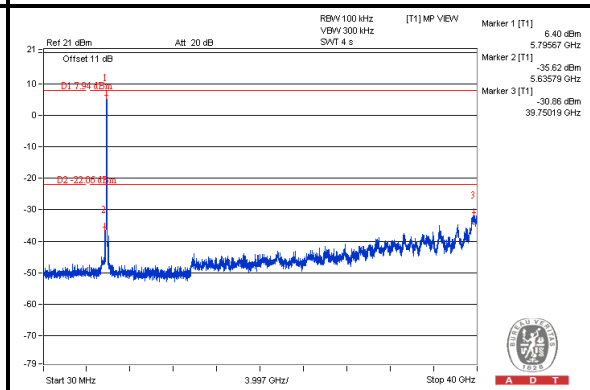



A D T

### For Chain 2

### CH 151

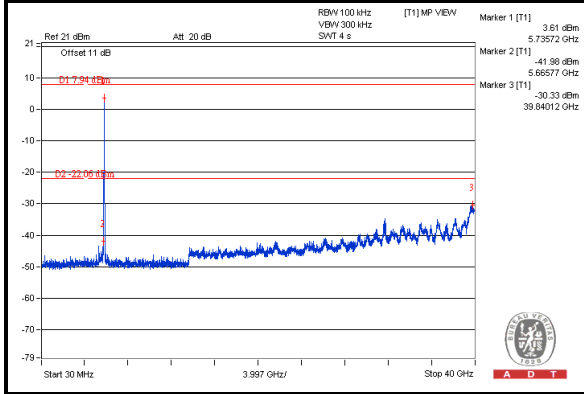

### CH 159

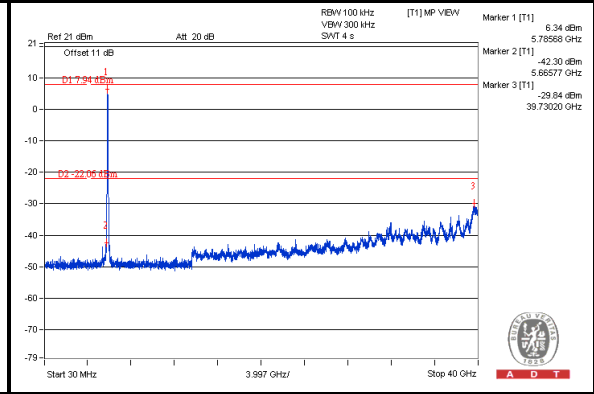



A D T

802.11ac (VHT80):

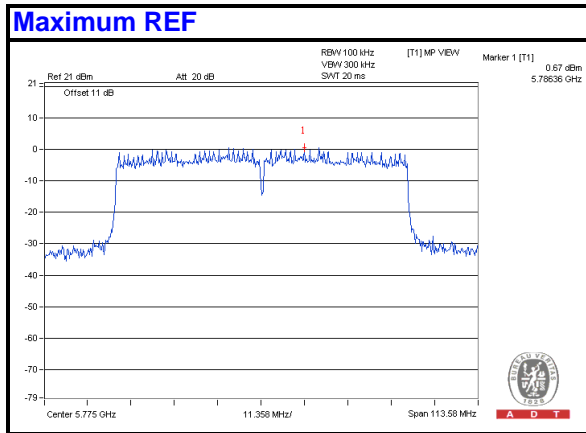

For Chain 0  
CH 155

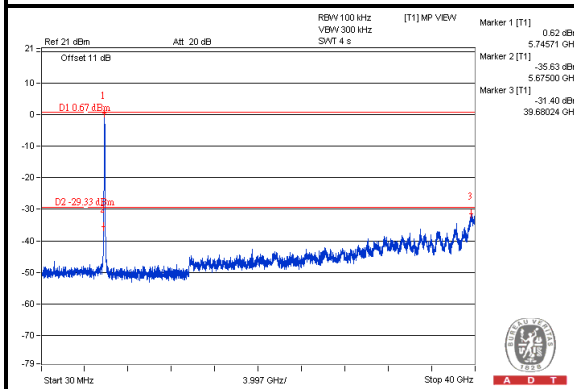

For Chain 1  
CH 155

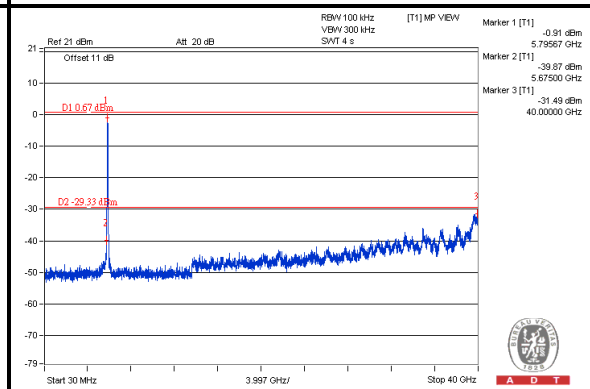

For Chain 2  
CH 155

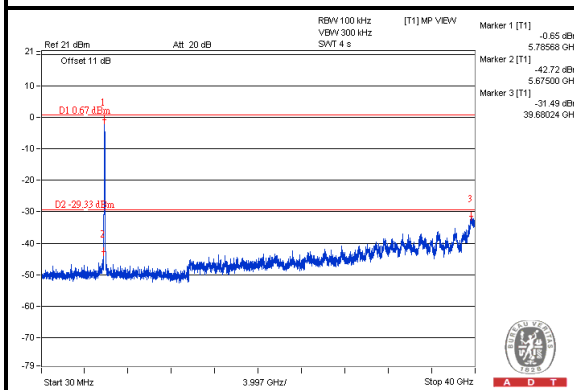





A D T

## 6. PHOTOGRAPHS OF THE TEST CONFIGURATION

Please refer to the attached file (Test Setup Photo).





## 7. INFORMATION ON THE TESTING LABORATORIES

We, Bureau Veritas Consumer Products Services (H.K.) Ltd., Taoyuan Branch, were founded in 1988 to provide our best service in EMC, Radio, Telecom and Safety consultation. Our laboratories are accredited and approved according to ISO/IEC 17025.

If you have any comments, please feel free to contact us at the following:

**Linko EMC/RF Lab:**

Tel: 886-2-26052180

Fax: 886-2-26052943

**Hsin Chu EMC/RF Lab:**

Tel: 886-3-5935343

Fax: 886-3-5935342

**Hwa Ya EMC/RF/Safety/Telecom Lab:**

Tel: 886-3-3183232

Fax: 886-3-3270892

**Email:** [service.adt@tw.bureauveritas.com](mailto:service.adt@tw.bureauveritas.com)

**Web Site:** [www.bureauveritas-adt.com](http://www.bureauveritas-adt.com)

The address and road map of all our labs can be found in our web site also.



A D T

## 8. APPENDIX A - MODIFICATIONS RECORDERS FOR ENGINEERING CHANGES TO THE EUT BY THE LAB

No modifications were made to the EUT by the lab during the test.

--- END ---