



Shenzhen Certification Technolgh Service Co., Ltd  
3F, Bldg27,Area A, Tanglang Industrial Zone, Xili Town,  
Nanshan District, ShenZhen, Guang dong, P.R.  
China.

# TEST REPORT

**FCC ID: XU4TLK-72BPTX**

**Applicant** : Audio Resource Group, Inc  
**Address** : 375 Langdon Ave P.O. Box 39 Hannaford, ND 58448 USA

**Equipment under Test (EUT):**

**Name** : 72MHz multi channel transmitter  
**Model** : TLK-72BPTX, TLK-72RMTX, TLK-72TTTTX, TLK-72BPRTX,  
TLK-72RMRTX, TLK-72MTTX

**Standards** : FCC PART 15, SUBPART C : 2008 (Section 15.237)

**Report No.** : STE091023597  
**Date of Test** : October 28-November 6, 2009  
**Date of Issue** : November 7, 2009

<b>Test Result :</b>	<b>PASS *</b>
----------------------	---------------

\* In the configuration tested, the EUT complied with the standards specified above

Authorized Signature

(Mark Zhu)  
General Manager

The manufacture should ensure that all the products in series production are in conformity with the product sample detailed in this report.

If the product in this report is used in any configuration other than that detailed in the report, the manufacturer must ensure the new system complies with all relevant standards. Any mention of Shenzhen Certification Technology Service Co., Ltd. Or test done by Shenzhen Certification Technology Service Co., Ltd. Approvals in connection with, distribution or use of the product described in this report must be approved by Shenzhen Certification Technology Service Co., Ltd. Approvals in writing.

## TABLE OF CONTENT

Description	Page
<b>1 General Information</b> -----	<b>3</b>
1.1 Description of Device (EUT)-----	3
1.2 Description of Test Facility-----	4
<b>2 EMC Equipment List</b> -----	<b>4</b>
<b>3 Test Procedure</b> -----	<b>5</b>
<b>4 Summary of Measurement</b> -----	<b>6</b>
<b>Occupied bandwidth</b> -----	<b>6</b>
<b>5 Radiation Emission</b> -----	<b>7</b>
5.1 Radiation Emission Limits(15.209&237 (c))-----	7
5.2 Test Setup-----	8
5.3 Test Procedure-----	9
5.4 Test Equipment Setting For emission test.est Result-----	10
5.5 Test Condition-----	10
5.6 Test Result-----	10
<b>6 Occupied bandwidth</b> -----	<b>15</b>
6.1 Test limit-----	15
6.2 Method of measurement-----	15
6.3 Test Setup-----	15
6.4 Test Results-----	15
<b>7 Antenna Requirement</b> -----	<b>19</b>
7.1 Standard Requirement-----	19
7.2 Antenna Connected Construction-----	19
7.3 Result-----	19
<b>8 Photographs of Test Setup</b> -----	<b>20</b>
<b>9 Photographs of EUT</b> -----	<b>21</b>

# 1 General Information

## 1.1 Description of Device (EUT)

Trade Name : N/A

EUT : 72MHz multi channel transmitter

Model No. : TLK-72BPTX, TLK-72RMTX, TLK-72TTTX,  
TLK-72BPRTX, TLK-72RMRTX, TLK-72MTTX

Type of Antenna : Integral Antenna

Operation Frequency : 72.0-73.0MHz, 74.6-74.8MHz, 75.2-76.0MHz

Channel number : 8 (CH1 72.1MHz, CH2 72.5MHz, CH3 72.7MHz,  
CH4 72.9MHz, CH5 74.7MHz, CH6 75.3MHz,  
CH7 75.7MHz, CH8 75.9MHz )

Modulation type : FM

Power Supply : DC 3V Supply by battery

Rated PF  
output Power : 88.97 dBuV(PK detector)

Applicant : Audio Resource Group, Inc  
Address : 375 Langdon Ave P.O. Box 39 Hannaford, ND 58448 USA

Manufacturer : SHENZHEN ALCORS TECHNOLOGY CO., LTD  
Address : Room0304, 3/F, 3063# Buxin dongxiao Road luohu  
shenzhen guangdong china

## 1.2 Description of Test Facility

Shenzhen Certification Technology Service Co.,Ltd.  
 3F, Bldg.27, Area A, Tanglang Industrial Zone, Xili Town, Nanshan District,  
 Shenzhen 518055, Guangdong, P.R. China  
 FCC Registered No.:305283

## 2 EMC Equipment List

Equipment	Manufacture	Model No.	Serial No.	Last cal.	Cal Interval
3m Semi-Anechoic	ETS-LINDGREN	N/A	SEL0017	16/06/2009	1Year
Spectrum analyzer	Agilent	E4443A	MY46185649	06/06/2009	1Year
Receiver	R&S	ESCI	100492	04/06/2009	1Year
Receiver	R&S	ESCI	101202	07/01/2009	1Year
Bilog Antenna	Sunol	JB3	A121206	04/06/2009	1Year
Horn Antenna	EMCO	3115	640201028-06	04/06/2009	1Year
Power Meter	Anritsu	ML2487A	6K00001491	02/23/2009	1Year
ETS Horn Antenna	ETS	3160	SEL0076	12/08/2009	1Year
Active Loop Antenna	Beijing Daze	ZN30900A	SEL0097	15/06/2009	1Year
Cable	Resenberger	N/A	No.1	04/06/2009	1Year
Cable	SCHWARZBECK	N/A	No.2	04/06/2009	1Year
Cable	SCHWARZBECK	N/A	No.3	04/06/2009	1Year
Pre-amplifier	R&S	AFS42-00101 800-25-S-42	SEL0081	18/06/2009	1Year
Pre-amplifier	R&S	AFS33-18002650 -30-8P-44	SEL0080	18/06/2009	1Year

### 3 Test Procedure

**POWER LINE CONDUCTED INTERFERENCE:** The test procedure used was ANSI Standard C63.4-2003 using a 50  $\mu$  H LISN. Both Lines were observed. The bandwidth of the receiver was 10kHz with an appropriate sweep speed. The ambient temperature of the EUT was 25°C with a humidity of 58%.

**RADIATION INTERFERENCE:** The test procedure used was ANSI Standard C63.4-2003 using a ANRITSU spectrum analyzer with a pre-selector. The analyzer was calibrated in dB above a micro volt at the output of the antenna. The resolution bandwidth was 100kHz and the video bandwidth was 300 kHz up to 1 GHz and 1 MHz with a video BW of 3MHz above 1 GHz. The ambient temperature of the EUT was 25°C with a humidity of 58%.

**FORMULA OF CONVERSION FACTORS:** The Field Strength at 3m was established by adding the meter reading of the spectrum analyzer (which is set to read in units of dBuV) to the antenna correction factor supplied by the antenna manufacturer and cable loss. The antenna correction factors and cable loss are stated in terms of dB. The gain of the Pre-selector was accounted for in the Spectrum Analyzer Meter Reading.

Example:

Freq (MHz) METER READING + ACF + CABLE = FS

33.20 dBuV + 10.36 dB + 0.9 dB= 44.46 dBuV/m @ 3m

**ANSI STANDARD C63.4-2003 10.1.7 MEASUREMENT PROCEDURES:** The EUT was placed on a table 80 cm high and with dimensions of 1m by 1.5m. The EUT was placed in the center of the table (1.5m side). The table used for radiated measurements is capable of continuous rotation. When an emission was found, the table was rotated to produce the maximum signal strength. At this point, the antenna was raised and lowered from 1m to 4m. The antenna was placed in both the horizontal and vertical planes. The situation was similar for the conducted measurement except that the table did not rotate. The EUT was setup as described in ANSI Standard C63.4-2003 10.1.7 with the EUT 40 cm from the vertical ground wall.

---

## 4 Summary of Measurement

Test Item	Test Requirement	Standard Paragraph	Result
Spurious Emission	FCC PART 15 : 2008	Section 15.237&15.209	Compliance
Conduction Emission	FCC PART 15: 2008	Section 15.207(c)	Not applicable
Occupied bandwidth	FCC PART 15:2008	Section 15.237(b)	Compliance
Antenna Requirement	FCC PART 15 : 2008	Section 15.203	Compliance

Note: The EUT has been tested as an independent unit. And Continual Transmitting in maximum power(The new battery be used during Test)

## 5 Radiation Emission

### 5.1 Radiation Emission Limits(15.209&237 (c))

Frequency (MHZ)	Field Strength Limits at 3 metres (watts,e.i.r.p.)		
	uV/m	dB uV/m	Measurement distance(m)
0.009-0.490	2400/F(kHz)	XX	300
0.490-1.705	24000/F(kHz)	XX	30
1.705-30	30	29.5	30
30~88	100(3nW)	40	3
88~216	150(6.8nW)	43.5	3
216~960	200(12nW)	46	3
Above960	500(75nW)	54	3
Carrier frequency		98.1(AV)	3
Carrier frequency		118.1(PK)	3
Harmonics frequency		63.5(AV)	3
Harmonics frequency		83.5(PK)	3

**NOTE:**

- a) The tighter limit applies at the band edges.
- b) Emission Level(dB uV/m)=20log Emission Level(Uv/m)

## 5.2 Test Setup

See the next page

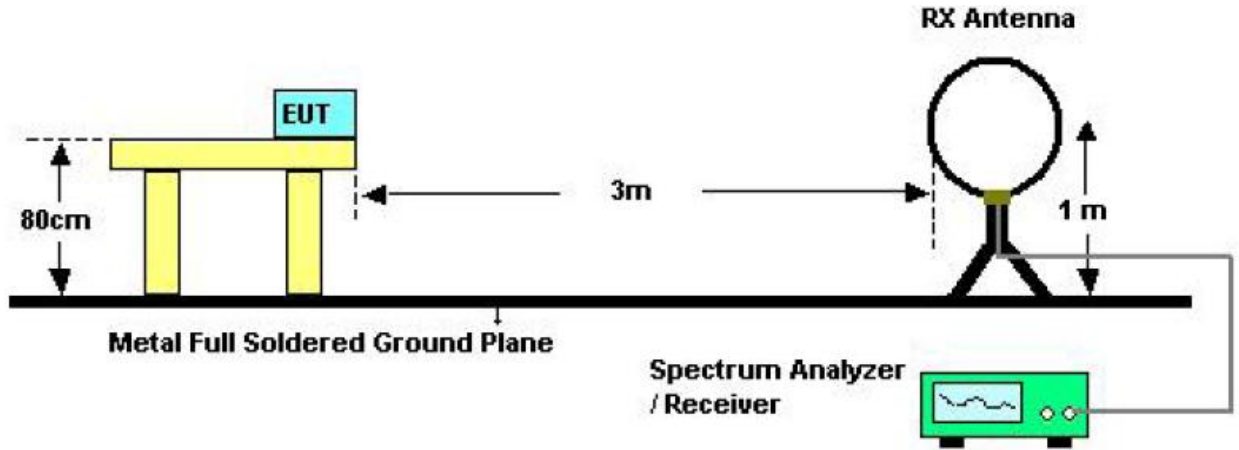

Below 30MHZ Test Setup

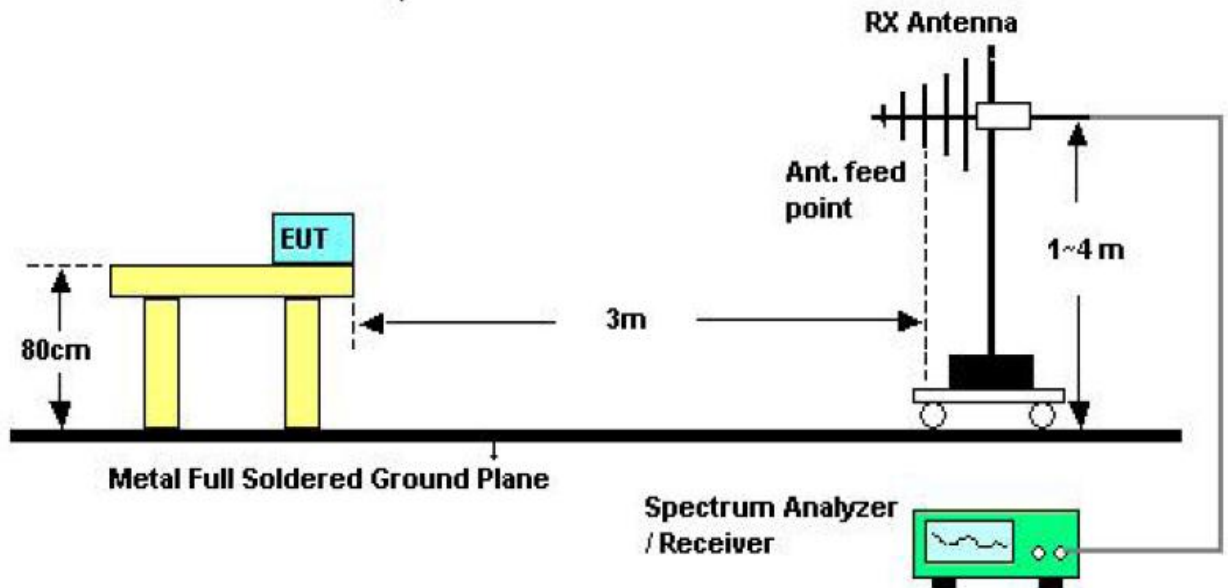

Above 30MHZ Test Setup



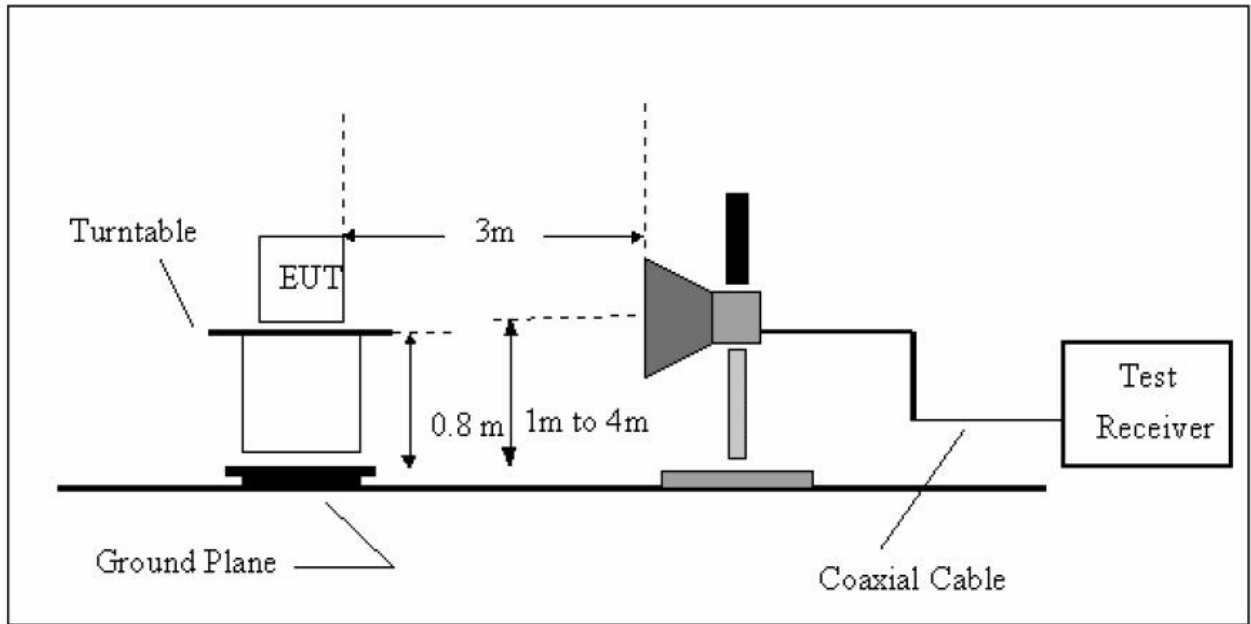

Above 1GHZ Test Setup

### 5.3 Test Procedure

- a) The measuring distance of 3m shall be used for measurements at frequency up to 1GHZ and above 1GHZ, The EUT was placed on a rotating 0.8 m high above ground,The table was rotated 360 degrees to determine the position of the highest radiation
- b) The Test antenna shall vary between 1m and 4m,Both Horizontal and Vertical antenna are set ot make measurement.
- c) The initial step in collecting conducted emission data is a spectrum analyzer Peak detector mode pre-scanning the measurement frequency range.Significant Peaks are then marked.and then Qusia Peak Detector mode remeasured
- d) If Peak value comply with QP limit Below 1GHZ.The EUT deemed to comply with QP limit.But the Peak value and average value both need to comply with applicable limit above 1GHZ.
- e) For the actual test configuration,please see the test setup photo.

#### 5.4 Test Equipment Setting For emission test.est Result

9KHZ~150KHZ	RBW 200HZ	VBW1KHZ
150KHZ~30MHZ	RBW 9KHZ	VBW 30KHZ
30MHZ~1GHZ	RBW 120KHZ	VBW 300KHZ
Above 1GHZ	RBW 1MHZ	VBW 3MHZ

#### 5.5 Test Condition

Continual Transmitting in maximum power(The new battery be used during Test)

#### 5.6 Test Result

Detailed information please see the following page.

**Radiated Emissions Result**

<b>EUT</b>	72MH multi channel transmitter	<b>Model Name</b>	TLK-72BPTX
<b>Temperature</b>	25°C	<b>Relative Humidity</b>	56%
<b>Pressure</b>	960hPa	<b>Test voltage</b>	DC 3V
<b>Test Mode</b>	TX		

Freq. (MHz)	Ant.Pol. H/V	Detector Mode (PK/OP)	Reading (dBuV)	Factor (dB)	Actual FS (dBuV/m)	Limits 3m (dBuV/m)	Margin (dBuV/m)
74.620	V	Peak	35.69	-5.20	30.49	40.00	-9.51
530.520	V	Peak	44.69	-12.80	31.89	43.50	-11.61
608.120	V	Peak	44.42	-13.35	31.07	43.50	-12.43
683.780	V	Peak	43.57	-12.63	30.94	43.50	-12.56
759.440	V	Peak	41.97	-8.30	33.67	46.00	-12.33
893.300	V	Peak	41.54	-2.00	39.54	54.00	-14.46

<b>EUT</b>	72MH multi channel transmitter	<b>Model Name</b>	TLK-72BPTX
<b>Temperature</b>	25°C	<b>Relative Humidity</b>	56%
<b>Pressure</b>	960hPa	<b>Test voltage</b>	DC 3V
<b>Test Mode</b>	TX		

Freq. (MHz)	Ant.Pol. H/V	Detector Mode (PK/OP)	Reading (dBuV)	Factor (dB)	Actual FS (dBuV/m)	Limits 3m (dBuV/m)	Margin (dBuV/m)
136.700	H	Peak	49.81	-18.03	31.78	40.00	-8.22
270.560	H	Peak	47.20	-13.07	34.13	43.50	-9.37
383.079	H	Peak	46.14	-13.72	32.42	46.00	-13.58
580.960	H	Peak	53.32	-23.65	29.67	46.00	-16.33
728.400	H	Peak	53.09	-18.99	34.10	46.00	-11.90
790.480	H	Peak	57.00	-12.50	44.50	54.00	-9.50

**Notes:** Above is Below 1GHZ test data

## Radiated Emissions Result of Inside band (72.10MHz)

<b>EUT</b>	72MH multi channel transmitter	<b>Model Name</b>	TLK-72BPTX
<b>Temperature</b>	25°C	<b>Relative Humidity</b>	56%
<b>Pressure</b>	960hPa	<b>Test voltage</b>	DC 3V
<b>Test Mode</b>	TX Low	<b>Antenna polarization</b>	Horizontal/Vertical

Channel Low(72.10MHz)									
Fre. MHz	Plority H/V	Reading dBuV	Antenna Factor dB	Cable Loss dB	Amplifier Gain dB	Correct Factor dB	Measure Result dBuV/m	Limit dBuV/m	Margin dB
72.10	H	107.34 (PK)	5.4	0.68	27.79	-21.71	85.63	118.1	-32.47
72.10	H	98.74 (AV)	5.4	0.68	27.79	-21.71	77.03	98.1	-21.07
--	H	--	--	--	--	--	--	--	--
72.10	V	104.52 (PK)	5.4	0.68	27.79	-21.71	82.81	118.1	-35.29
72.10	V	92.18 (AV)	5.4	0.68	27.79	-21.71	70.47	98.1	-27.63
--	V	--	--	--	--	--	--	--	--

Freq. (MHz)	Ant. Pol H/V	Peak Reading (dBuV)	AV Reading (dBuV)	Ant. / CL CF (dB)	Actual Fs		Peak Limit (dBuV/m)	AV Limit (dBuV/m)	Margin (dB)	Remark
					Peak (dBuV/m)	AV (dBuV/m)				
114.20	H	72.13	---	-18.94	53.19	---	83.50	63.50	-10.31	Peak
216.30	H	68.57	---	-14.53	54.04	---	83.50	63.50	-9.46	Peak
288.40	H	64.38	---	-13.49	50.89	---	83.50	63.50	-12.61	Peak
N/A										
114.20	V	70.89	---	-18.94	51.95	---	83.50	63.50	-11.55	Peak
216.30	V	69.52	---	-14.53	54.99	---	83.50	63.50	-8.51	Peak
288.40	V	65.37	---	-13.49	51.88	---	83.50	63.50	-11.62	Peak
N/A										

**Notes: 1** --Means other frequency and mode comply with standard requirements and at least have 20dB margin.

Correct Factor=Cable Loss+Antenna Factor-Amplifier Gain

Measurement Result=Reading + Correct Factor

Margin=Measurement Result-Limit

**2** –Spectrum setting:

a. Peak setting 30MHz-1GHz,RBW=120KHz,VBW=300KHz.

b. AV setting 30MHz-1GHz,RBW=1MHz,VBW=10Hz.

## Radiated Emissions Result of Inside band (74.70MHz)

<b>EUT</b>	72MH multi channel transmitter	<b>Model Name</b>	TLK-72BPTX
<b>Temperature</b>	26°C	<b>Relative Humidity</b>	56%
<b>Pressure</b>	960hPa	<b>Test voltage</b>	DC 3V
<b>Test Mode</b>	TX Middle	<b>Antenna polarization</b>	Horizontal/Vertical

Channel Middle(74.70MHz)									
Fre. MHz	Plority H/V	Reading dBuV	Antenna Factor dB	Cable Loss dB	Amplifier Gain dB	Correct Factor dB	Measure Result dBuV/m	Limit dBuV/m	Margin dB
74.70	H	110.57 (PK)	5.5	0.70	27.80	-21.60	88.97	118.1	-29.13
74.70	H	102.73 (AV)	5.5	0.70	27.80	-21.60	81.13	98.1	-16.97
--	H	--	--	--	--	--	--	--	--
74.70	V	107.59 (PK)	5.5	0.70	27.80	-21.60	85.99	118.1	-32.11
74.70	V	97.32 (AV)	5.5	0.70	27.80	-21.60	75.72	98.1	-22.38
--	V	--	--	--	--	--	--	--	--

Freq. (MHz)	Ant. Pol H/V	Peak Reading (dBuV)	AV Reading (dBuV)	Ant. / CL CF (dB)	Actual Fs		Peak Limit (dBuV/m)	AV Limit (dBuV/m)	Margin (dB)	Remark
					Peak (dBuV/m)	AV (dBuV/m)				
149.40	H	71.47	---	-17.52	53.95	---	83.50	63.50	-9.55	Peak
224.10	H	64.28	---	-14.17	50.11	---	83.50	63.50	-13.39	Peak
298.80	H	62.35	---	-13.29	49.06	---	83.50	63.50	-14.44	Peak
N/A										
149.40	V	70.89	---	-17.52	53.37	---	83.50	63.50	-10.13	Peak
224.10	V	63.35	---	-14.17	49.18	---	83.50	63.50	-14.32	Peak
298.80	V	60.81	---	-13.29	47.52	---	83.50	63.50	-15.98	Peak
N/A							83.50	63.50		

**Notes: 1** --Means other frequency and mode comply with standard requirements and at least have 20dB margin.

Correct Factor=Cable Loss+Antenna Factor-Amplifier Gain

Measurement Result=Reading + Correct Factor

Margin=Measurement Result-Limit

**2** –Spectrum setting:

a. Peak setting 30MHz-1GHz,RBW=120KHz,VBW=300KHz.

b. AV setting 30MHz-1GHz,RBW=1MHz,VBW=10Hz.

Radiated Emissions Result of Inside band (75.90MHz)

<b>EUT</b>	72MH multi channel transmitter	<b>Model Name</b>	TLK-72BPTX
<b>Temperature</b>	26°C	<b>Relative Humidity</b>	56%
<b>Pressure</b>	960hPa	<b>Test voltage</b>	DC 3V
<b>Test Mode</b>	TX High	<b>Antenna polarization</b>	Horizontal/Vertical

Channel High(75.90MHz)									
Fre. MHz	Plority H/V	Reading dBuV	Antenna Factor dB	Cable Loss dB	Amplifier Gain dB	Correct Factor dB	Measure Result dBuV/m	Limit dBuV/m	Margin dB
75.90	H	104.55 (PK)	5.7	0.71	27.82	-21.41	83.14	118.1	-34.96
75.90	H	95.61 (AV)	5.7	0.71	27.82	-21.41	74.20	98.1	-23.90
--	H	--	--	--	--	--	--	--	--
75.90	V	103.74 (PK)	5.7	0.71	27.82	-21.41	82.33	118.1	-35.77
75.90	V	94.27 (AV)	5.7	0.71	27.82	-21.41	72.86	98.1	-25.44
--	V	--	--	--	--	--	--	--	--

Freq. (MHz)	Ant. Pol H/V	Peak Reading (dBuV)	AV Reading (dBuV)	Ant. / CL CF (dB)	Actual Fs		Peak Limit (dBuV/m)	AV Limit (dBuV/m)	Margin (dB)	Remark
					Peak (dBuV/m)	AV (dBuV/m)				
151.80	H	73.22	---	-16.84	56.38	---	83.50	63.50	-7.12	Peak
227.70	H	63.53	---	-14.08	49.45	---	83.50	63.50	-14.05	Peak
303.60	H	60.76	---	-13.13	47.63	---	83.50	63.50	-15.87	Peak
N/A										
151.80	V	70.43	---	-16.84	53.59	---	83.50	63.50	-9.91	Peak
227.70	V	61.89	---	-14.08	47.81	---	83.50	63.50	-15.69	Peak
303.60	V	57.36	---	-13.13	44.23	---	83.50	63.50	-19.27	Peak
N/A										

**Notes: 1** --Means other frequency and mode comply with standard requirements and at least have 20dB margin.

Correct Factor=Cable Loss+Antenna Factor-Amplifier Gain

Measurement Result=Reading + Correct Factor

Margin=Measurement Result-Limit

**2** –Spectrum setting:

a. Peak setting 30MHz-1GHz,RBW=120KHz,VBW=300KHz.

b. AV setting 30MHz-1GHz,RBW=1MHz,VBW=10Hz.

## 6 Occupied bandwidth

### 6.1 Test limit

Please refer section 15.237

According to § 15.237(b), Emissions from the intentional radiator shall be confined within a band 200kHz wide centered on the operating frequency. The 200kHz band shall lie wholly within the above specified frequency ranges.

### 6.2 Method of measurement

a) The bandwidth is measured at an amplitude level reduced 20dB from the reference level. The reference level is the level of the highest amplitude signal observed from the transmitter at the fundamental frequency. Once the reference level is established, the equipment is conditioned with typical modulating signal to produce the worst-case (i.e. the widest) bandwidth.

b) The test receiver RBW set 30KHZ, VBW set 30KHZ, Sweep time set auto.

### 6.3 Test Setup

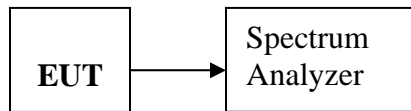

### 6.4 Test Results

**PASS.**

Detailed information please see the following page.

Frequency	Test Result	Limit	Result
72.10MHz	105KHz	<200kHz	Pass
74.70MHz	100KHz	<200kHz	Pass
75.90MHz	100KHz	<200kHz	Pass

# CH Low:

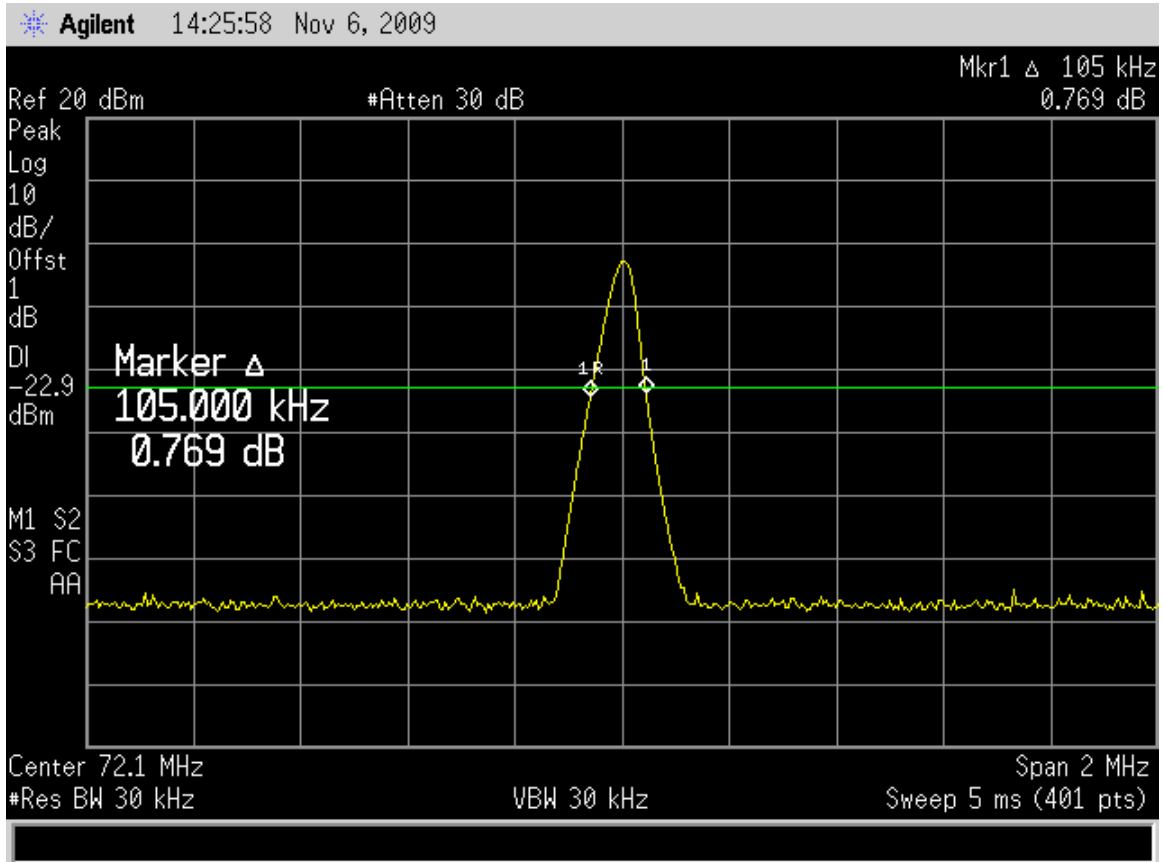



# CH Middle:

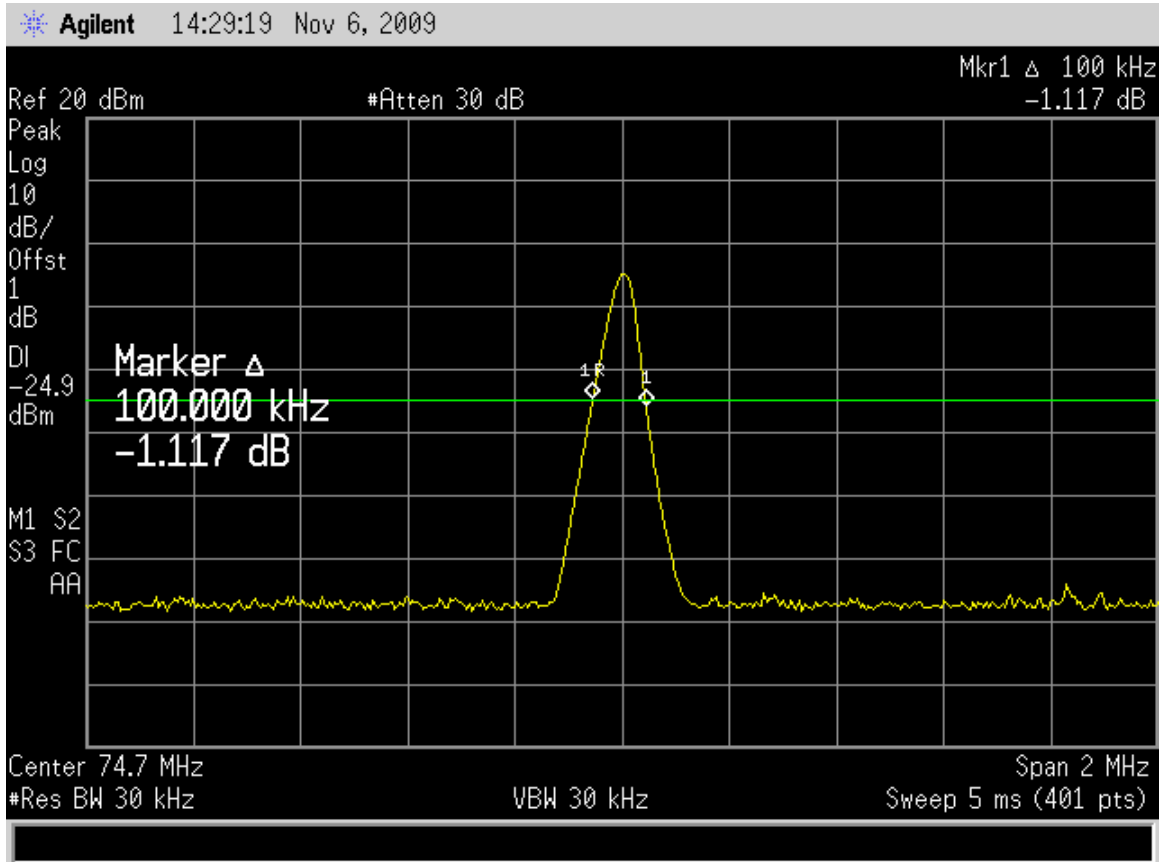

# CH High:

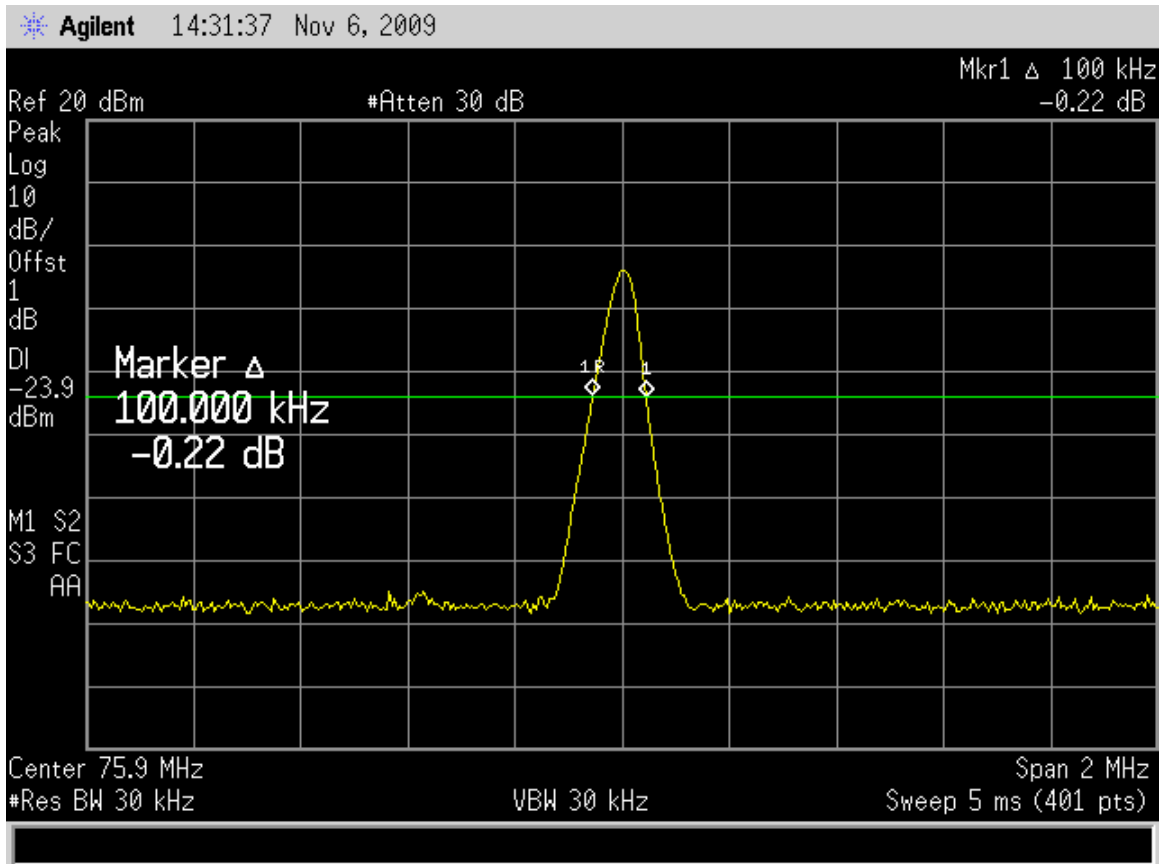

## 7 Antenna Requirement

### 7.1 Standard Requirement

An intentional radiator shall be designed to ensure that no antenna other than that furnished by the responsible party shall be used with the device. The use of a permanently attached antenna or of an antenna that uses a unique coupling to the intentional radiator shall be considered sufficient to comply with the provisions of this Section. The manufacturer may design the unit so that a broken antenna can be replaced by the user, but the use of a standard antenna jack or electrical connector is prohibited.

### 7.2 Antenna Connected Construction

The directional gains of antenna used for transmitting is 0 dBi, and the antenna connector is designed with permanent attachment and no consideration of replacement. Please see EUT photo for details.

### 7.3 Result

The EUT antenna is integral Antenna. It comply with the standard requirement.

## 8 Photographs of Test Setup

### Photographs-Radiated Emission Test Setup in Chamber

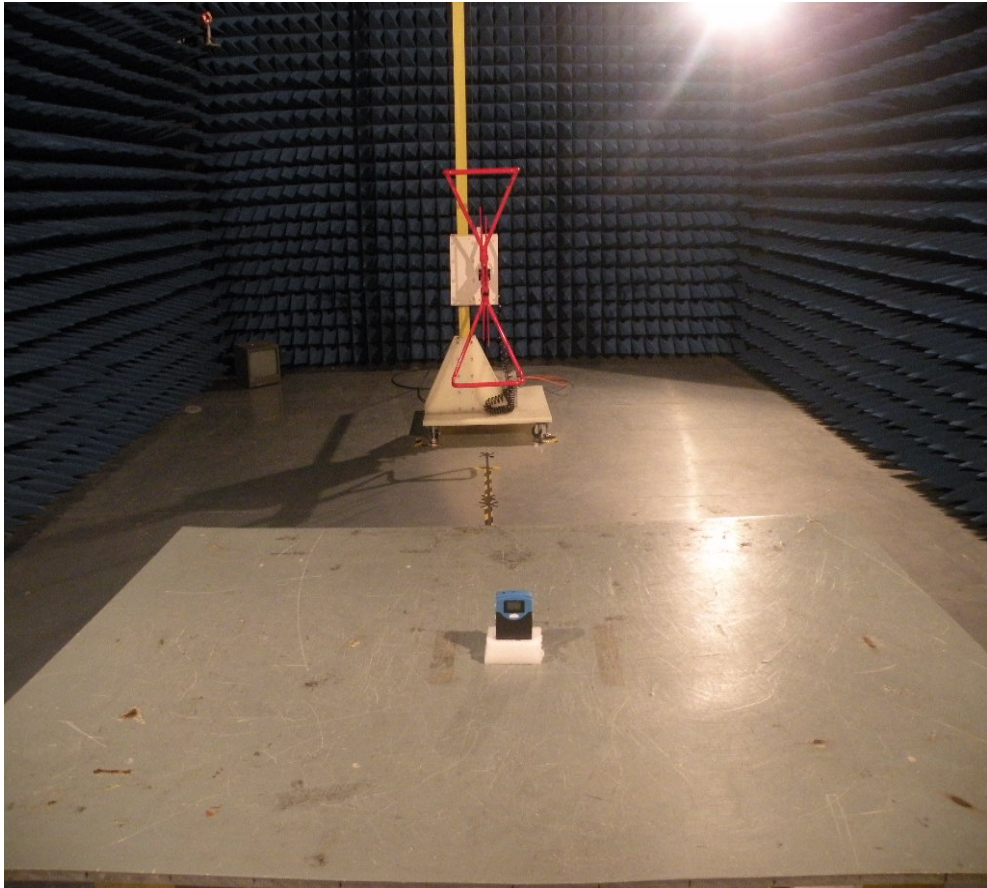

## 9 Photographs of EUT

**Figure 1**

Photo of EUT

Front View [ ]

Rear View [ ]

Top View [✓]

Bottom View [ ]

Left View [ ]

Right View [ ]

Full View [ ]



**Figure 2**

Photo of EUT

Front View [ ]

Rear View [ ]

Top View [ ]

Bottom View [✓]

Left View [ ]

Right View [ ]

Full View [ ]

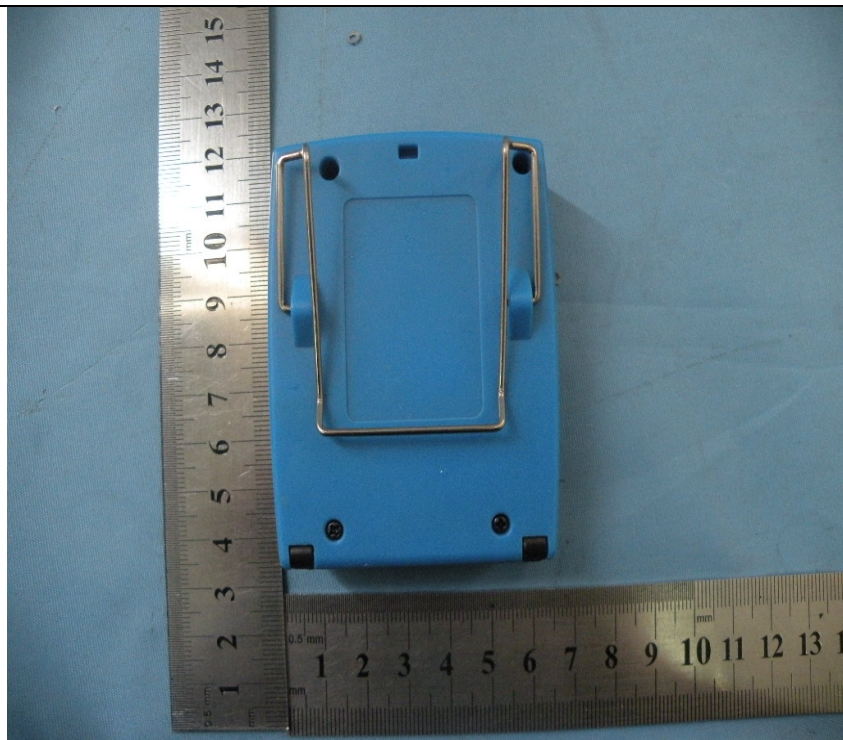

**Figure 3**

Photo of EUT

Front View

Rear View

Top View

Bottom View

Left View

Right View

Internal View

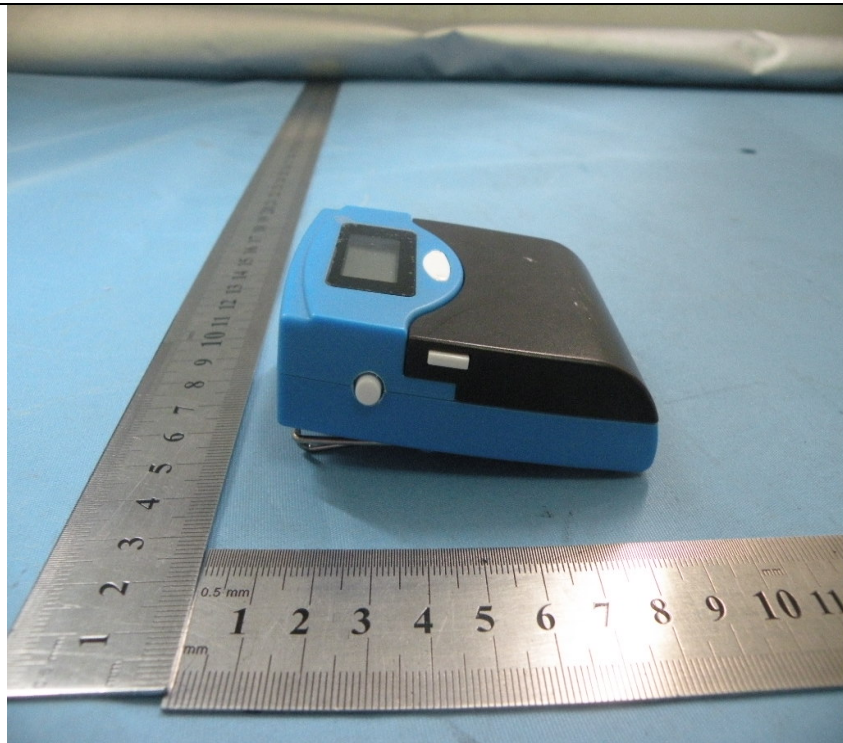

**Figure 4**

Photo of EUT

Front View

Rear View

Top View

Bottom View

Left View

Right View

Internal View

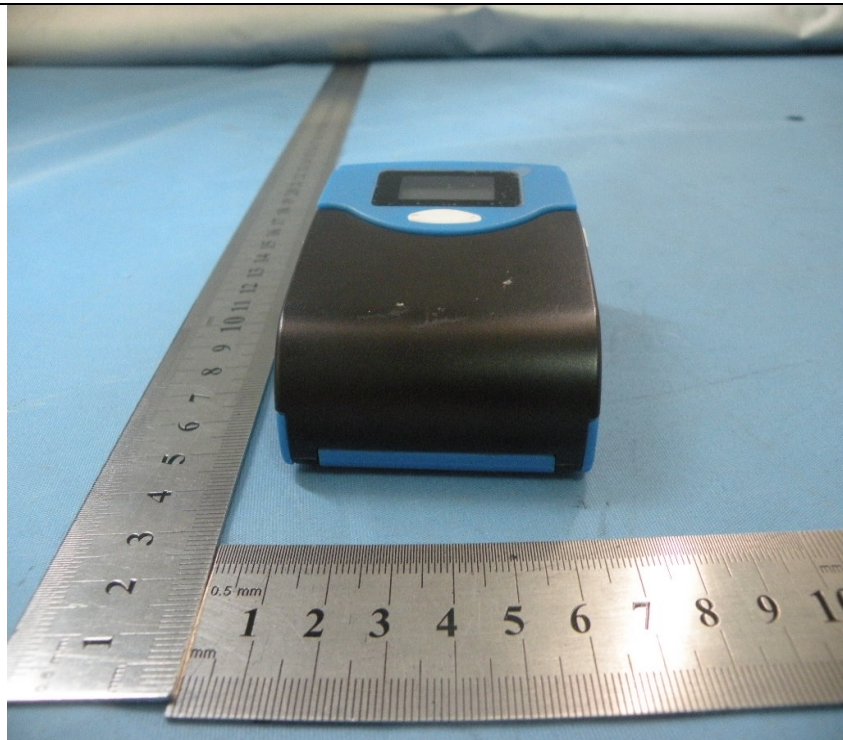

**Figure 5**

Photo of EUT

Front View [ ]

Rear View [  ]

Top View [ ]

Bottom View [ ]

Left View [ ]

Right View [ ]

Internal View [ ]

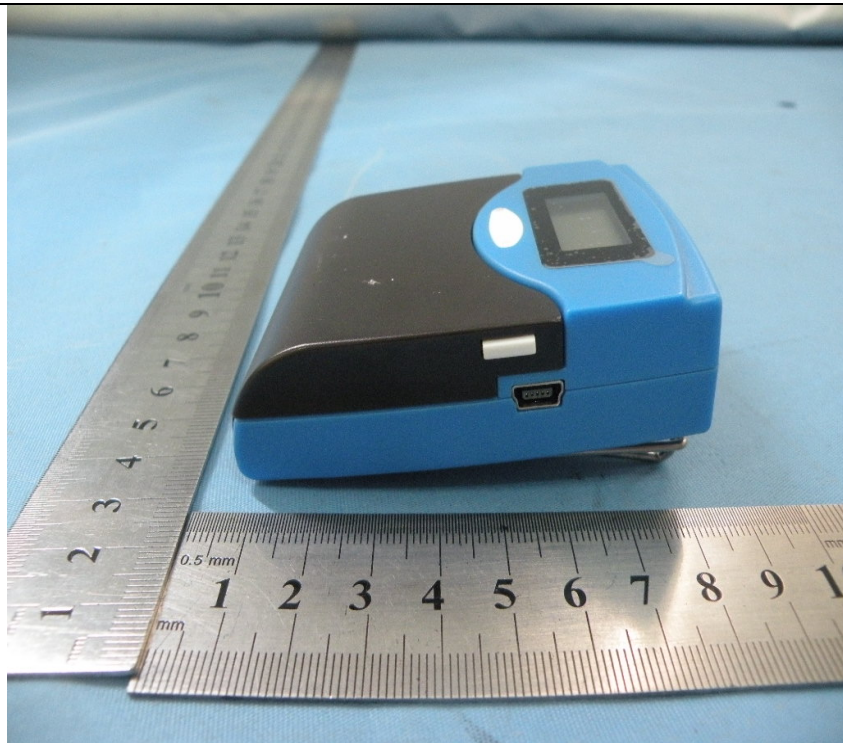

**Figure 6**

Photo of EUT

Front View [ ]

Rear View [ ]

Top View [ ]

Bottom View [ ]

Left View [ ]

Right View [  ]

Internal View [ ]

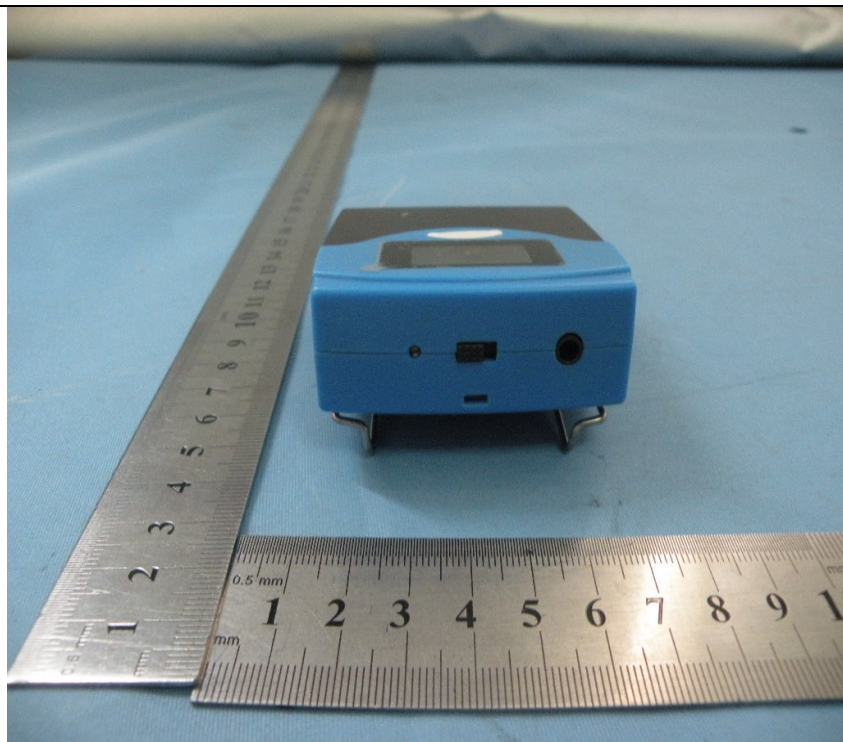

**Figure 7**

Photo of EUT

Front View [ ]

Rear View [ ]

Top View [ ]

Bottom View [ ]

Left View [ ]

Right View [ ]

Internal View [  ]

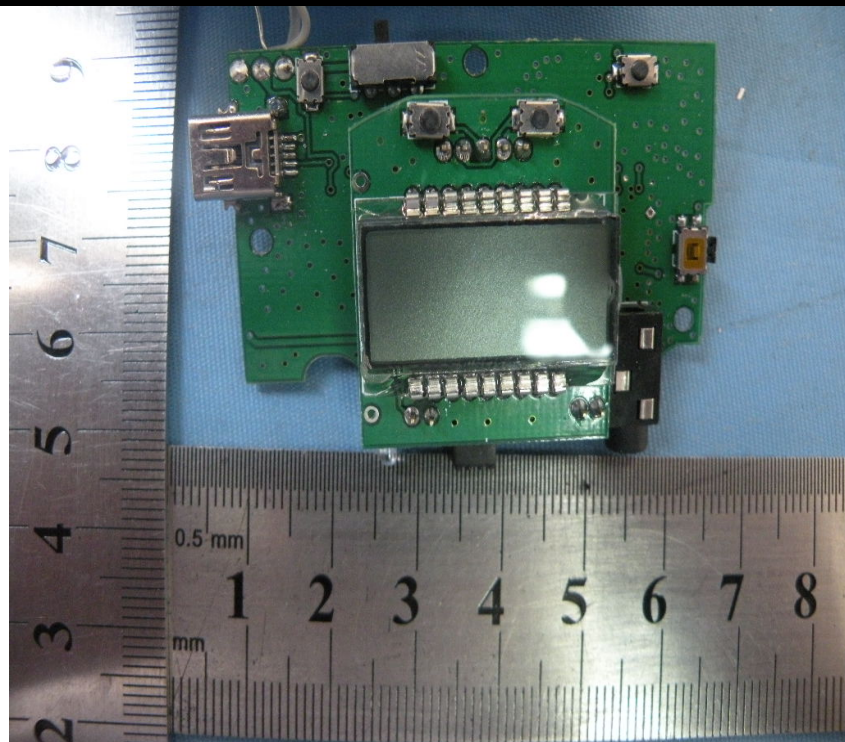

**Figure 8**

Photo of EUT

Front View [ ]

Rear View [ ]

Top View [ ]

Bottom View [ ]

Left View [ ]

Right View [ ]

Internal View [  ]

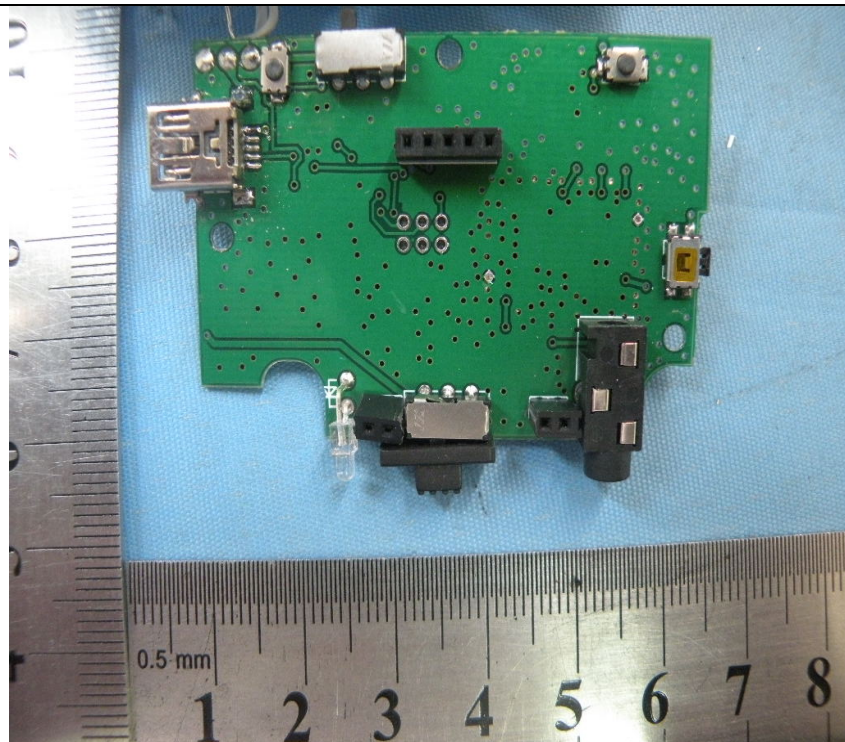



**Figure 9**

Photo of EUT

Front View [ ]

Rear View [ ]

Top View [ ]

Bottom View [ ]

Left View [ ]

Right View [ ]

Internal View [  ]

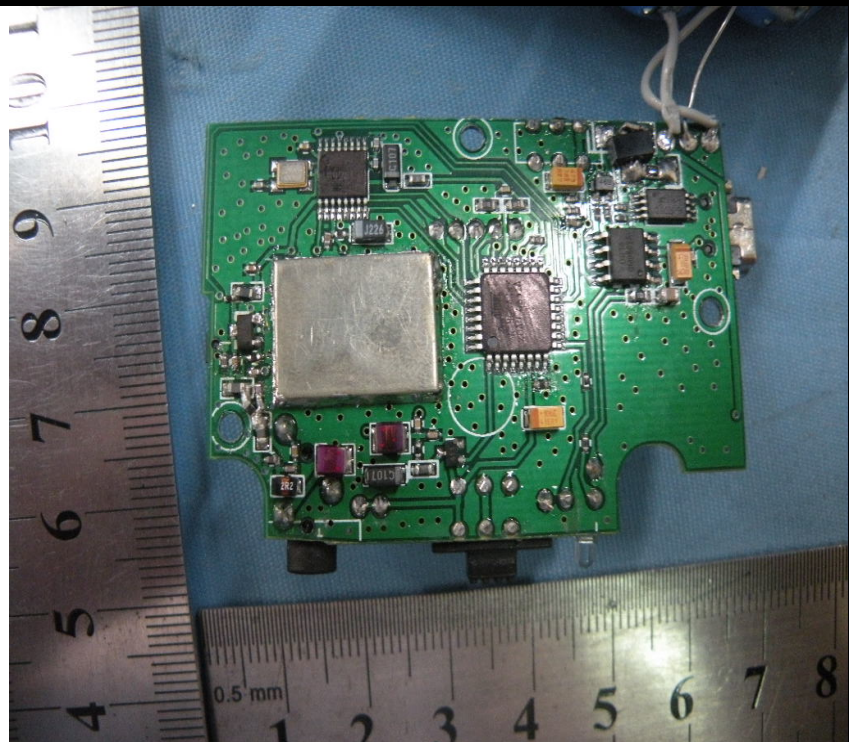

**Figure 10**

Photo of EUT

Front View [ ]

Rear View [ ]

Top View [ ]

Bottom View [ ]

Left View [ ]

Right View [ ]

Internal View [  ]

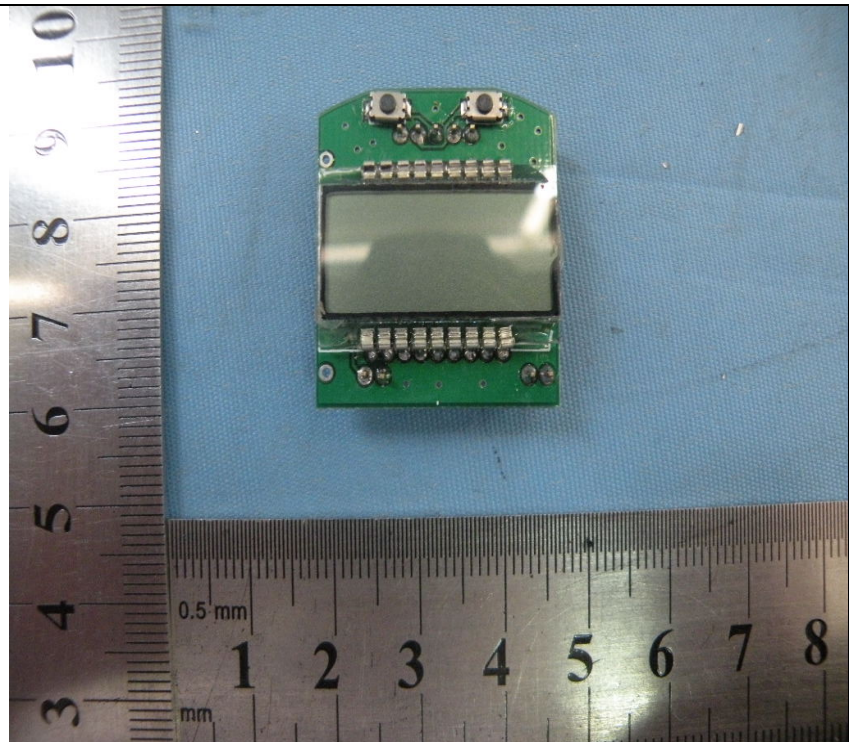

**Figure 11**

Photo of EUT

Front View [ ]

Rear View [ ]

Top View [ ]

Bottom View [ ]

Left View [ ]

Right View [ ]

Internal View [  ]

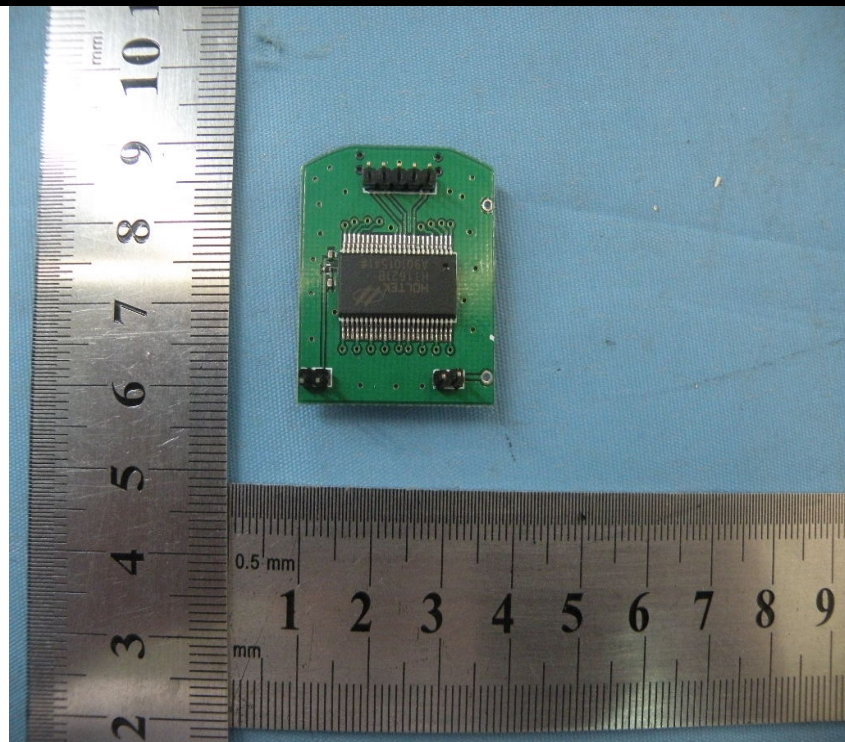

-----END OF THE REPORT-----