

FCC COMPLIANCE TEST REPORT

Technical Statement of Conformity
in accordance with 47 CFR Part 15 Subpart C

The product

Equipment Under Test	: Bluetooth Dongle
Model Number	: WTX-583-DUAL
Product Series	: WPTT-DUAL-M10
Report Number	: HA190471-RA
Issue Date	: 21-June-2019
Test Result	: Compliance

is produced by
Mobility Sound Technology LTD.
5F, No.100, Jian 1st Road, ZhongHe Dist., New Taipei City #23585, Taiwan



HongAn TECHNOLOGY CO., LTD.

NO.15-1, CWEISHUH KENG, CWEIPIN VILLAGE,
LINKOU, TAIPEI COUNTY,
TAIWAN, R. O. C.

TEL: +886-2-26030362

FAX: +886-2-26019259

E-mail: hatlab@ms19.hinet.net

BSMI Registration No.: SL2-IN-E-0023, SL2-A1-E-0023,
SL2-IS-E-0023, SL2-R1-E-0023,
SL2-R2-E-0023, SL2-L1-E-0023

FCC Designation No.: TW1071, TW1163

TAF Accreditation No.: 1163

VCCI Registration No.: R-2156, C-2329, T-219

Contents

1	General Description	6
1.1	Description of EUT	6
1.2	Test Instruments	7
1.3	Auxiliary Equipments	8
1.4	EUT SETUP	8
1.5	Identifying the Final Test Mode	8
1.6	Final Test Mode	9
1.7	Condition of Power Supply	9
1.8	EUT Configuration	9
1.9	Test Methodology	9
1.10	General Test Procedures	9
1.11	Modification	9
1.12	FCC Part 15.205 restricted bands of operations	10
1.13	Qualification of Test Facility	11
2	Power line Conducted Emission Measurement	12
2.1	Test Instruments	12
2.2	Test Arrangement and Procedure	12
2.3	Limit (§ 15.207)	12
2.4	Test Result	12
3	Radiated Emission Test	13
3.1	Test Instruments	13
3.2	Test Arrangement and Procedure	13
3.3	Limit of Field Strength of Fundamental (§ 15.249)	14
3.4	Limit of Spurious Emission (§ 15.209)	14
3.5	Test Result	14
4	Out of Band Emission Test	25
4.1	Test Instruments	25
4.2	Test Arrangement and Procedure	25
4.3	Limit of Field Strength of Fundamental (§ 15.249(d))	25
4.4	Test Result	25
5	20 dB Bandwidth	30
5.1	Test Instruments	30
5.2	Test Arrangement and Procedure	30
5.3	Limit	30
5.4	Test Result	30



6	Antenna requirement	34
6.1	Limit (§ 15.203)	34
6.2	Test Result	34
7	Photographs of the Tests	35
7.1	Radiated Disturbances Emission Test	35
8	Photographs of the EUT	36

Test Result Certification

Applicant : Mobility Sound Technology LTD.

Address of Applicant : 5F, No.100, Jian 1st Road, ZhongHe Dist., New Taipei City
#23585, Taiwan

Manufacturer : Mobility Sound Technology LTD.

Address of Manufacturer : 5F, No.100, Jian 1st Road, ZhongHe Dist., New Taipei City
#23585, Taiwan

Trade Name : MobilitySound

Equipment Under Test : Bluetooth Dongle

Model Number : WTX-583-DUAL

Product Series : WPTT-DUAL-M10

FCC ID : XTS-PTT-WTX

Filing Type : Certification

Sample Received Date : 23-May-2019

Test Standard :

FCC Part 15 Subpart C §15.249

Deviations from standard test methods & any other specifications : NONE

Remark:

1. This report details the results of the test carried out on one sample.
2. The test data, data evaluation, test procedures, and equipment configurations shown in this report were made in accordance with the procedures given in both ANSI C63.10 (2013) and the energy emitted by the sample EUT tested as described in this report is in compliance with the requirements of FCC Rules Part 15.203, 15.207, 15.209, 15.247.
3. This report applies to the above sample only and shall not be reproduced in part without written approval of HongAn Technology Co., Ltd.
4. Test Location: HongAn Technology Co., Ltd., No.15-1 Cweishuh Keng, Cweipin Village, Linkou Dist., New Taipei City, Taiwan, R.O.C. FCC Designation No.: TW1071, TW1163.

Tested by: Andrew Lin 2019-06-06
Andrew Lin / ENG. Dept. Staff

Approved by: Eason Hsieh **Date:** 2019-06-21
Eason Hsieh / Section Manager

Summary of Test Result

	Test Item	Applicable Standard	Test Result
1	Antenna Requirement	FCC part 15 subpart C §203	Compliance
2	Conducted Emission	FCC part 15 subpart C §207	N/A
3	Restricted Band of Operation	FCC part 15 subpart C §205	Compliance
4	Radiated Emission	FCC part 15 subpart C §209	Compliance
5	Field Strength	FCC part 15 subpart C §249(a)	Compliance
6	Out of Band Emission	FCC part 15 subpart C §249(d)	Compliance
7	20dB Bandwidth	FCC part 15 subpart C §215(c)	Compliance

1 General Description

1.1 Description of EUT

Equipment Under Test	:	Bluetooth Dongle							
Model Number of EUT	:	WTX-583-DUAL							
Product Series	:	WPTT-DUAL-M10							
Power Supply	:	Input: DC 5 V							
Frequency Range	:	2402~2480 MHz							
Number of Channels	:	40 Channels							
Carrier Frequency of Each Channel	:	00	2402	10	2422	20	2442	30	2462
		01	2404	11	2424	21	2444	31	2464
		02	2406	12	2426	22	2446	32	2466
		03	2408	13	2428	23	2448	33	2468
		04	2410	14	2430	24	2450	34	2470
		05	2412	15	2432	25	2452	35	2472
		06	2414	16	2434	26	2454	36	2474
		07	2416	17	2436	27	2456	37	2476
		08	2418	18	2438	28	2458	38	2478
		09	2420	19	2440	29	2460	39	2480
Antenna Specification	:	Chip Antenna/ Gain: 1.3 dBi							
Modulation Technique	:	Bluetooth : GFSK							
Transmit Data Rate	:	Bluetooth : 1Mbps							
Specification	:	Dimensions : 6 cm (L) X 3 cm (W) X 2.5 cm (H)							
		Weight : 30 g							
		Intended Function : The EUT is a Bluetooth Dongle.							
		Product Variance : N/A.							

1.2 Test Instruments

Instrument Name	Manufacturer Mode	Model Number	Serial Number	Last Cal. Date	Next Cal. Date
Spectrum Analyzer	R&S	FSV 30	101629	25-Dec-2018	24-Dec-2019
ESCI7 EMI Test Receiver	R&S	ESCI7	100931	09-Aug-2018	08-Aug-2019
Pre-Amplifier	Schaffner	CPA9231A	0405	24-Dec-2018	23-Dec-2019
Pre-Amplifier	Com-Power	PAM-118A	443027	27-Dec-2018	26-Dec-2019
Microwave Preamplifier	Com-Power	PAM-840	461269	17-May-2019	16-May-2020
Bilog Antenna	TESEQ	CBL6111D	25769	29-Jan-2019	28-Jan-2020
Horn Antenna	EMCO	3115	9912-5992	15-May-2019	14-May-2020
Horn Antenna	Com-Power	AH-840	101042	21-May-2019	20-May-2020
Four-Phase-V- Network	Rolf Heine Hochfrequenz- technik	NNB-4/32T	00001	10-Mar-2019	09-Mar-2020
LISN	EMCO	3810/2NM	9702-1819	09-Jul-2018	08-Jul-2019
Active Loop Antenna	EMCO	6502	9202-2717	21-Aug-2018	20-Aug-2019
Coaxial Cable	n/a	8D-FB	HA2-10MSI TE-01	24-Aug-2018	23-Aug-2019
Microflex Cable	HUBER SUHNER	SUCOFLEX 102	MY3368/2	17-May-2019	16-May-2020
Microflex Cable	HUBER SUHNER	SUCOFLEX 102	MY3367/2	17-May-2019	16-May-2020
Coaxial Cable	n/a	RG 223/U	HA2-CE-01	24-Aug-2018	23-Aug-2019

※ The test equipments used are calibrated and can be traced to National ITRI and International Standards.

1.3 Auxiliary Equipments

1.3.1. Provided by HongAn Technology Co., Ltd. for Test.

No.	Equipment	Model No.	Serial No.	EMC Approved	Brand	Power Cord
01	NoteBook	X1 Carbon	PF-0QGYKK	CE,FCC,	LENOVO	Adapter to Notebook Unshielded*1.95m
02	USB Cable	N/A	N/A	N/A	N/A	Non-Shielded; Detachable, 0.2m w/o core

1.3.2. Provided by the Manufacturer

No.	Equipment	Model No.	Serial No.	EMC Approved	Brand	Specification
01	BT Test Board	N/A	N/A	N/A	N/A	N/A
02	Audio Cable	N/A	N/A	N/A	N/A	Non-Shielded; Un-Detachable, 0.2m w/o core
03	Radio Intercom	N/A	N/A	N/A	N/A	N/A

1.4 EUT SETUP

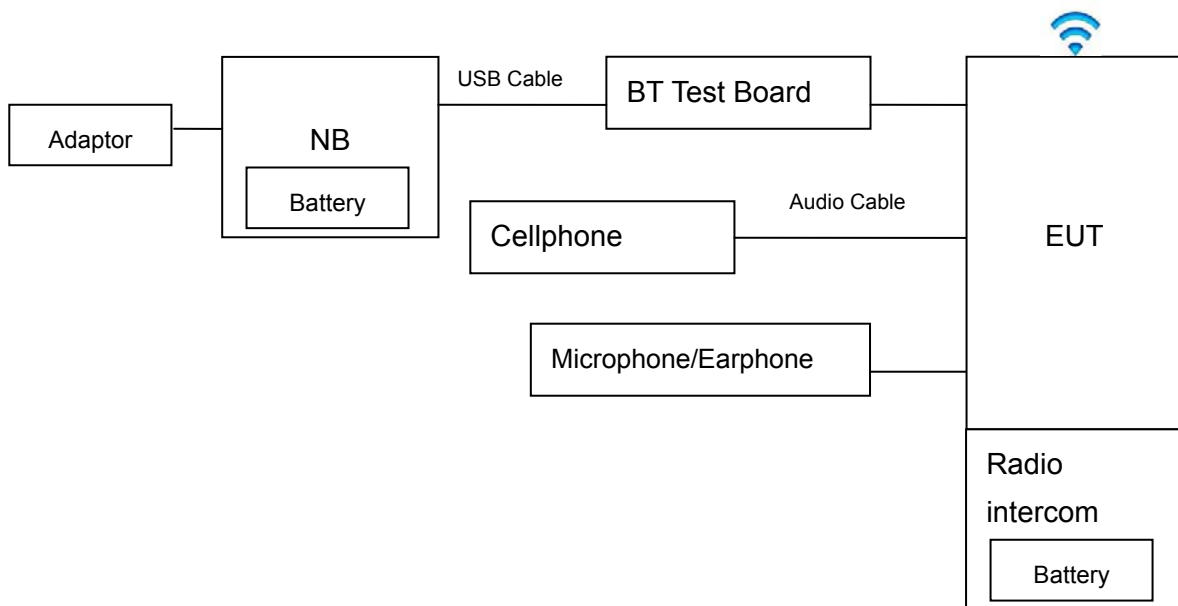

Note: Main Test Sample: WTX-583-DUAL

1.5 Identifying the Final Test Mode

1. Mode 1: TX BLE mode (1Mbps) CH 00.
2. Mode 2: TX BLE mode (1Mbps) CH 20.
3. Mode 3: TX BLE mode (1Mbps) CH 39.

Note:

1. After pre-test, we identified that the Test Mode 1 was most likely to produce the maximum transmitting power and cause maximum disturbance. Therefore, the Final Assessment was performed for the worst case.

2. The EUT was operated in the engineering mode to fix the TX frequency that was for the purpose of the measurements. During the tests, there was no Test Software has been used.
3. Channel Low (2402 MHz), Mid (2442 MHz) and High (2480 MHz) were chosen for full testing.
4. According to its specifications, the EUT must comply with the requirements of the Section 15.203, 15.207, 15.209 and 15.247 under the FCC Rules Part 15 Subpart C.
5. Test Software: AccessPort.exe v1.36; RF parameter setting : Channel : 02 , 42 , 80 / Data Rate : 1Mbps / TX POWER : 3.

1.6 Final Test Mode

Conducted Emission: N/A.

Radiated Emission (30~1000 MHz): Mode1.

Radiated Emission (1~26.5GHz): All Modes.

1.7 Condition of Power Supply

DC 5V through Radio intercom

1.8 EUT Configuration

1. Setup the EUT as shown in Sec.1.4 Block Diagram.
2. Turn on the power of all equipments.
3. Activate the selected Final Test Mode.

1.9 Test Methodology

The tests documented in this report were performed in accordance with ANSI C63.10 (2013) and FCC CFR 47 15.203, 15.207, 15.209 and 15.249.

1.10 General Test Procedures

Conducted Emissions

The EUT is set according to the requirements in Section 6.2 of ANSI C63.10 (2013).

Radiated Emissions

The EUT is set according to the requirements in Section 6.3 of ANSI C63.10 (2013).

1.11 Modification

N/A

1.12 FCC Part 15.205 restricted bands of operations

(a) Except as shown in paragraph (d) of this section, only spurious emissions are permitted in any of the frequency bands listed below:

MHz	MHz	MHz	GHz
0.090-0.110	16.42-16.423	399.9-410	4.5-5.15
¹ 0.495-0.505	16.69475-16.69525	608-614	5.35-5.46
2.1735-2.1905	16.80425-16.80475	960-1240	7.25-7.75
4.125-4.128	25.5-25.67	1300-1427	8.025-8.5
4.17725-4.17775	37.5-38.25	1435-1626.5	9.0-9.2
4.20725-4.20775	73-74.6	1645.5-1646.5	9.3-9.5
6.215-6.218	74.8-75.2	1660-1710	10.6-12.7
6.26775-6.26825	108-121.94	1718.8-1722.2	13.25-13.4
6.31175-6.31225	123-138	2200-2300	14.47-14.5
8.291-8.294	149.9-150.05	2310-2390	15.35-16.2
8.362-8.366	156.52475-156.52525	2483.5-2500	17.7-21.4
8.37635-8.38675	156.7-156.9	2690-2900	22.01-23.12
8.41425-8.41475	162.0125-167.17	3260-3267	23.6-24.0
12.29-12.293	167.72-173.2	3332-3339	31.2-31.8
12.51975-12.52025	240-285	3345.8-3358	36.43-36.5
12.57675-12.57725	322-335.4	3600-4400	(²)
13.36-13.41			

¹ Until February 1, 1999, this restricted band shall be 0.490-0.510 MHz

² Above 38.6

(b) Except as provided in paragraphs (d) and (e), the field strength of emissions appearing within these frequency bands shall not exceed the limits shown in Section 15.209. At frequencies equal to or less than 1000 MHz, compliance with the limits in Section 15.209 shall be demonstrated using measurement instrumentation employing a CISPR quasi-peak detector. Above 1000 MHz, compliance with the emission limits in Section 15.209 shall be demonstrated based on the average value of the measured emissions. The provisions in Section 15.35 apply to these measurements.



1.13 Qualification of Test Facility

Name of Test Facility : HongAn Technology
Address of Test Facility : No. 15-1, Cweishuh Keng, Cweipin Village, Linkou, New Taipei City,
Taiwan, R.O.C
FCC Designation No. : TW1071, TW1163
TAF Accreditation No. : 1163

2 Power line Conducted Emission Measurement

2.1 Test Instruments

Refer to Sec. 1.2 Test Instruments.

2.2 Test Arrangement and Procedure

1. The EUT was placed on a table, which is 0.8m above ground plane.
2. Maximum procedure was performed on the six highest emissions to ensure EUT compliance.
3. Repeat above procedures until all frequency measured were complete.

2.3 Limit (§ 15.207)

For an intentional radiator which is designed to be connected to the public utility (AC) power line, the radio frequency voltage that is conducted back onto the AC power line on any frequency or frequencies within the band 150 kHz to 30 MHz shall not exceed 250 microvolts (The limit decreases linearly with the logarithm of the frequency in the range 0.15 MHz to 0.50 MHz). The limits at specific frequency range is listed as follows:

Frequency (MHz)	Limits (dBuV)	
	Q.P. (Quasi-Peak)	A.V. (Average)
0.15 to 0.50	66 to 56	56 to 46
0.50 to 5.0	56	46
5.0 to 30	60	50

Compliance with this provision shall be based on the measurement of the radio frequency voltage between each power line (LINE and NEUTRAL) and ground at the power terminals.

2.4 Test Result

N/A

The EUT applies a Radio intercom's Battery for its power supply.

3 Radiated Emission Test

3.1 Test Instruments

Refer to Sec. 1.2 Test Instruments.

3.2 Test Arrangement and Procedure

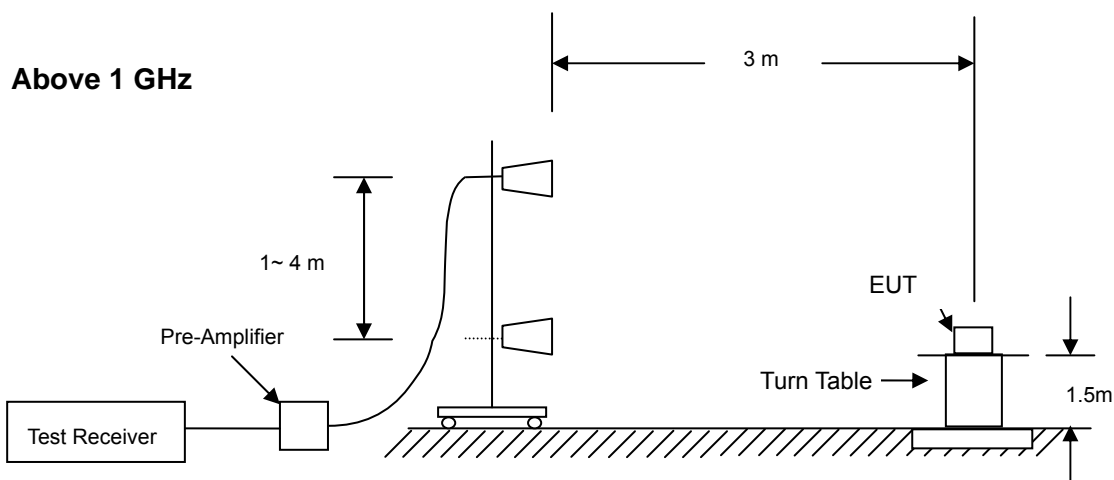
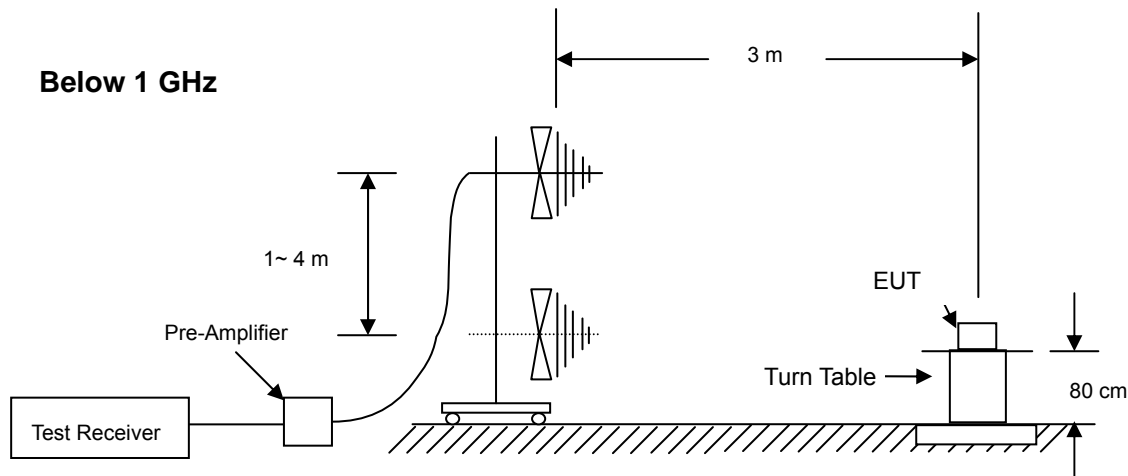

1. The EUT is placed on a turntable, which is 0.8 m (below 1GHz) and 1.5m (above 1GHz) above ground plane.
2. The turntable shall be rotated for 360 degrees to determine the position of maximum emission level.
3. EUT is set 3 m away from the receiving antenna, which is varied from 1 m to 4 m to find out the highest emissions.
4. Maxium procedure was performed on the six highest emissions to ensure EUT compliance.
5. And also, each emission was to be maximized by changing the polarization of receiving antenna both horizontal and vertical.
6. Set the spectrum analyzer. Refer to each test results for detail setting up.
7. Repeat above procedures until the meausreemnts for all frequencies are complete.

3.3 Limit of Field Strength of Fundamental (§ 15.249)

The field strength of emissions from intentional radiators operated within these frequency bands shall comply with the following:

Fundamental Frequency (MHz)	Field strength of fundamental (microvolts/ meter)	Field strength of harmonics (meters)
902-928	50	500
2400-2483.5	50	500
5725-5875	50	500
24000-24250	250	2500

Note:

1. Field strength limits are specified at a distance of 3 meters.
2. For frequencies above 1000 MHz, the field strength limits in above table are based on average limits. However, the peak field strength of any emission shall not exceed the maximum permitted average limits specified above by more than 20 dB under any condition of modulation.

3.4 Limit of Spurious Emission (§ 15.209)

Emissions radiated outside of the specified frequency bands, except for harmonics, shall be attenuated by at least 50 dB below the level of the fundamental or to the general radiated emission limits in § 15.209, whichever is lesser attenuation.

Frequency (MHz)	Field strength (microvolts/ meter)	Measurement distance (meters)
0.009-0.490	2400/F(kHz)	300
0.490-1.705	24000/F(kHz)	30
1.705-30.0	30	30
30-88	100**	3
88-216	150**	3
216-960	200**	3
Above 960	500	3

** Except as provided in paragraph (g), fundamental emissions from intentional radiators operating under this section shall not be located in the frequency bands 54-72 MHz, 76-88 MHz, 174-216 MHz or 470-806 MHz. However, operation within these frequency bands is permitted under other sections of this part, e.g.§§ 15.231 and 15.241.

3.5 Test Result

Compliance

The final test data are shown on the following page(s).

Radiated Emission Test Data (Field Strength of Fundamental)

Temperature	: 27.3°C	Humidity	: 52%
Test Date	: 2019-06-06	Tested by	: Andrew Lin
Polarization	: Vertical	Channel	: CH00, 20, 39 (1Mbps)
EUT Position	: X axis		

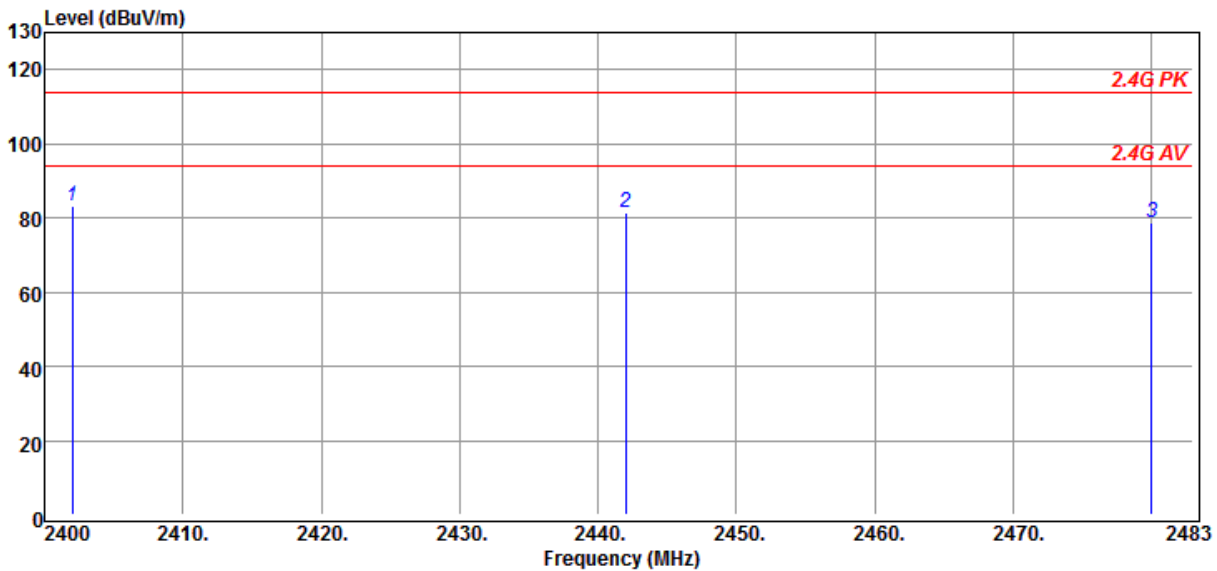

No.	Freq MHz	Reading dBμV	C.F dB	Result dBμV/m	Limit dBμV/m	Margin dB	Antenna Pol.	Remark
1	2402.00	89.86	-6.65	83.21	94.00	-10.79	VERTICAL	Peak
2	2442.00	88.09	-6.72	81.37	94.00	-12.63	VERTICAL	Peak
3	2480.00	85.29	-6.48	78.81	94.00	-15.19	VERTICAL	Peak

Note 1. C.F (Correction Factor) = Antenna factor + Cable loss - Preamp gain ◦

Note 2. Margin = Result - Limit ; Result = Reading + C.F ◦

Remark :

1. Measuring frequencies from 1 GHz to the 10th harmonic of highest fundamental frequency.
2. Measurements above show only up to 6 maximum emissions noted, or would be lesser if no specific emissions from the EUT are recorded (ie: margin > 20dB from the applicable limit) and considered that's already beyond the background noise floor.
3. Radiated emissions measured in frequency above 1000 MHz were made with an instrument using Peak detector mode and average detector mode of the emission shown in Actual FS column.
4. All readings are Peak values. None of the peak value reading exceeds the A.V. limit. Hence, A.V. reading was not measured.
5. Spectrum setting:
Peak Setting 1GHz to 10th harmonics of fundamental, RBW = 3MHz, VBW =10MHz, Sweep = AUTO.
Note: Because the 20 dB Bandwidth is over 1MHz, the RBW setting of measuring Field strength of Fundamental should be 3MHz, and VBW should be at 10 MHz.

Radiated Emission Test Data (Field Strength of Fundamental)

Temperature	: 27.3°C	Humidity	: 52%
Test Date	: 2019-06-06	Tested by	: Andrew Lin
Polarization	: Horizontal	Channel	: CH00, 20, 39 (1Mbps)
EUT Position	: X axis		

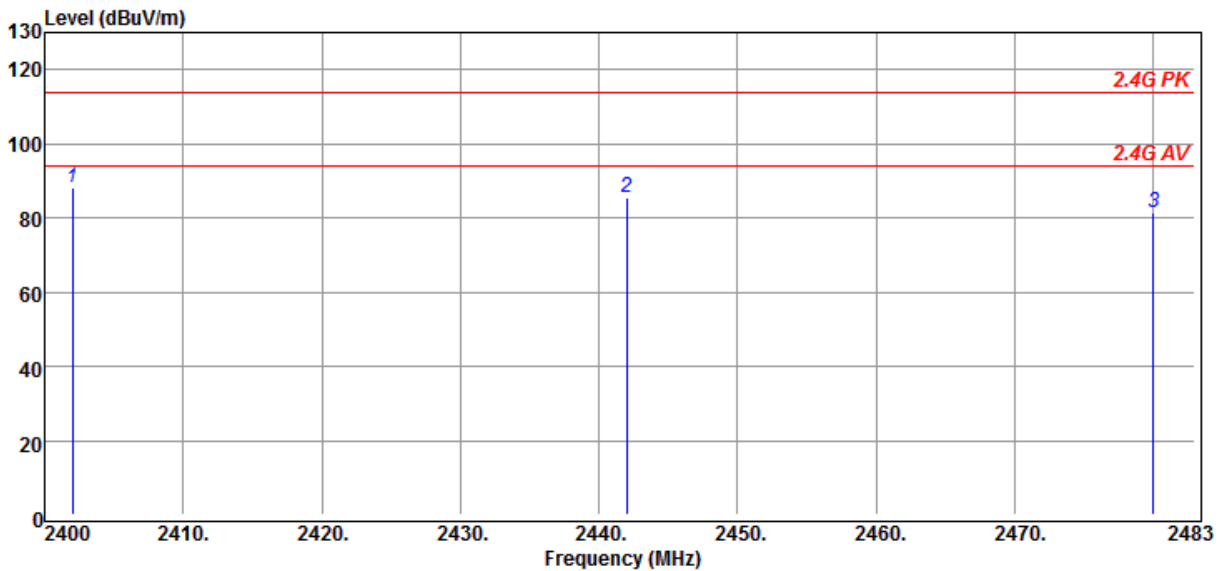

No.	Freq MHz	Reading dBμV	C.F dB	Result dBμV/m	Limit dBμV/m	Margin dB	Antenna Pol.	Remark
1	2402.00	95.03	-6.65	88.38	94.00	-5.62	HORIZONTAL	Peak
2	2442.00	92.03	-6.72	85.31	94.00	-8.69	HORIZONTAL	Peak
3	2480.00	87.78	-6.48	81.30	94.00	-12.70	HORIZONTAL	Peak

Note 1. C.F (Correction Factor) = Antenna factor + Cable loss - Preamp gain ◦

Note 2. Margin = Result - Limit ; Result = Reading + C.F ◦

Remark :

1. Measuring frequencies from 1 GHz to the 10th harmonic of highest fundamental frequency.
2. Measurements above show only up to 6 maximum emissions noted, or would be lesser if no specific emissions from the EUT are recorded (ie: margin > 20dB from the applicable limit) and considered that's already beyond the background noise floor.
3. Radiated emissions measured in frequency above 1000 MHz were made with an instrument using Peak detector mode and average detector mode of the emission shown in Actual FS column.
4. All readings are Peak values. None of the peak value reading exceeds the A.V. limit. Hence, A.V. reading was not measured.
5. Spectrum setting:
Peak Setting 1GHz to 10th harmonics of fundamental, RBW = 3MHz, VBW =10MHz, Sweep = AUTO.
Note: Because the 20 dB Bandwidth is over 1MHz, the RBW setting of measuring Field strength of Fundamental should be 3MHz, and VBW should be at 10 MHz.

Radiated Emission Test Data (Below 1 GHz)

Temperature	: 27.3°C	Humidity	: 52%
Test Date	: 2019-06-06	Tested by	: Andrew Lin
Polarization	: Vertical	Channel	: CH00
EUT Position	: X axis		

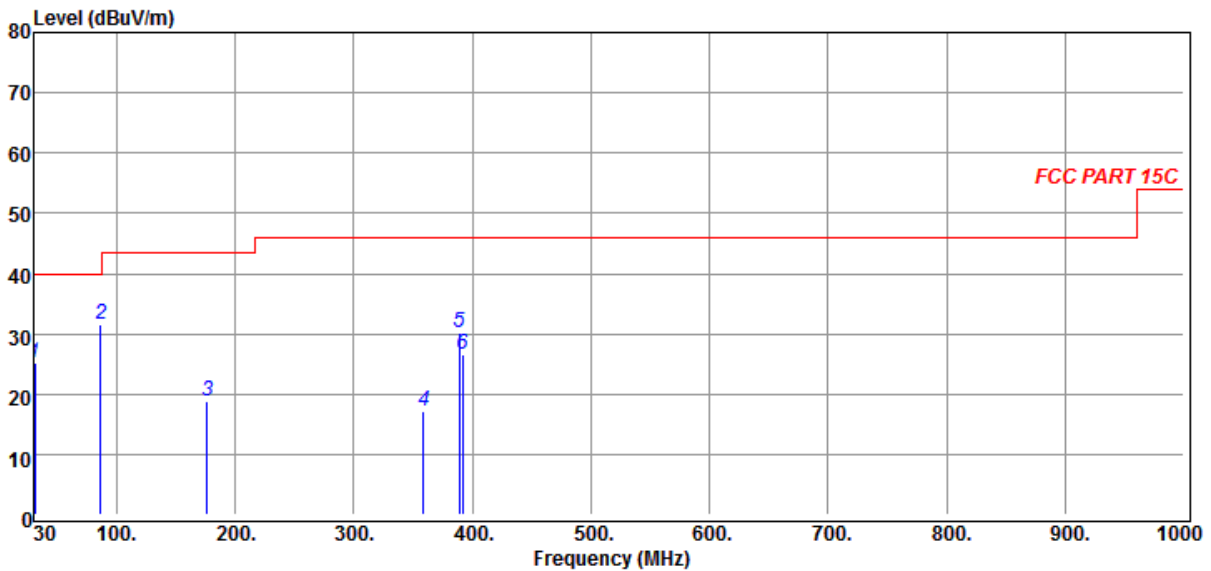

No.	Freq MHz	Reading dBμV	C.F dB	Result dBμV/m	Limit dBμV/m	Margin dB	Antenna Pol.	Remark
1	30.97	29.08	-3.83	25.25	40.00	-14.75	VERTICAL	Peak
2	86.26	46.18	-14.73	31.45	40.00	-8.55	VERTICAL	Peak
3	176.47	32.25	-13.42	18.83	43.50	-24.67	VERTICAL	Peak
4	358.83	24.30	-7.10	17.20	46.00	-28.80	VERTICAL	Peak
5	388.90	36.57	-6.47	30.10	46.00	-15.90	VERTICAL	Peak
6	391.81	32.87	-6.38	26.49	46.00	-19.51	VERTICAL	Peak

Note 1. C.F (Correction Factor) = Antenna factor + Cable loss - Preamp gain ◦

Note 2. Margin = Result - Limit ; Result = Reading + C.F ◦

Remark :

1. Measuring frequencies from 30 MHz to 1 GHz.
2. Radiated emissions measured in frequency range from 30 MHz to 1000 MHz were made with an instrument using Peak detector mode.
3. Data of measurement within this frequency range shown "----" in the table above means the reading of emissions are attenuated more than 20 dB below the permissible limits or the field strength is too small to be measured.
4. All readings are Peak values. None of the peak value reading exceeds the Q.P. limit. Hence, Q.P. reading was not measured.
5. The IF bandwidth of SPA between 30 MHz to 1 GHz was 100 kHz.

Radiated Emission Test Data (Below 1 GHz)

Temperature	: 27.3°C	Humidity	: 52%
Test Date	: 2019-06-06	Tested by	: Andrew Lin
Polarization	: Horizontal	Channel	: CH00
EUT Position	: X axis	Data rate	: 1Mbps

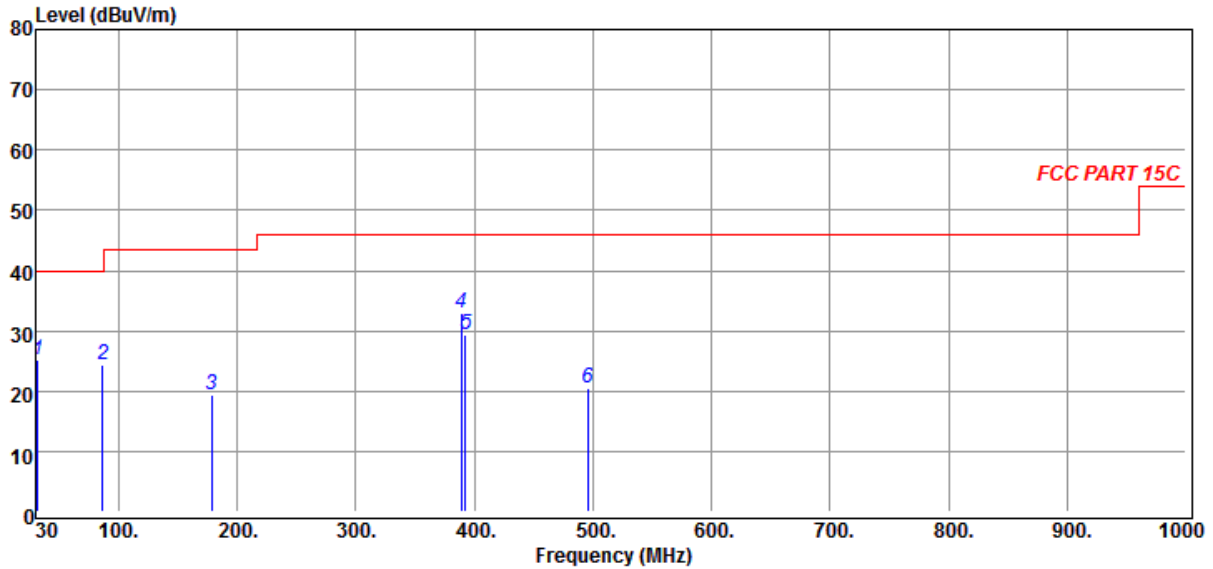

No.	Freq MHz	Reading dBµV	C.F dB	Result dBµV/m	Limit dBµV/m	Margin dB	Antenna Pol.	Remark
1	31.94	29.73	-4.41	25.32	40.00	-14.68	HORIZONTAL	Peak
2	86.26	39.16	-14.73	24.43	40.00	-15.57	HORIZONTAL	Peak
3	178.41	32.86	-13.52	19.34	43.50	-24.16	HORIZONTAL	Peak
4	388.90	39.30	-6.47	32.83	46.00	-13.17	HORIZONTAL	Peak
5	392.78	35.75	-6.36	29.39	46.00	-16.61	HORIZONTAL	Peak
6	495.60	24.49	-4.06	20.43	46.00	-25.57	HORIZONTAL	Peak

Note 1. C.F (Correction Factor) = Antenna factor + Cable loss - Preamp gain ◦

Note 2. Margin = Result - Limit ; Result = Reading + C.F ◦

Remark :

1. Measuring frequencies from 30 MHz to 1 GHz.
2. Radiated emissions measured in frequency range from 30 MHz to 1000 MHz were made with an instrument using Peak detector mode.
3. Data of measurement within this frequency range shown "----" in the table above means the reading of emissions are attenuated more than 20 dB below the permissible limits or the field strength is too small to be measured.
4. All readings are Peak values. None of the peak value reading exceeds the Q.P. limit. Hence, Q.P. reading was not measured.
5. The IF bandwidth of SPA between 30 MHz to 1 GHz was 100 kHz.

Radiated Emission Test Data (Above and Field Strength to 10th Harmonic)

Temperature	: 27.3°C	Humidity	: 52%
Test Date	: 2019-06-06	Tested by	: Andrew Lin
Polarization	: Vertical	Channel	: CH00
EUT Position	: X axis	Data rate	: 1Mbps

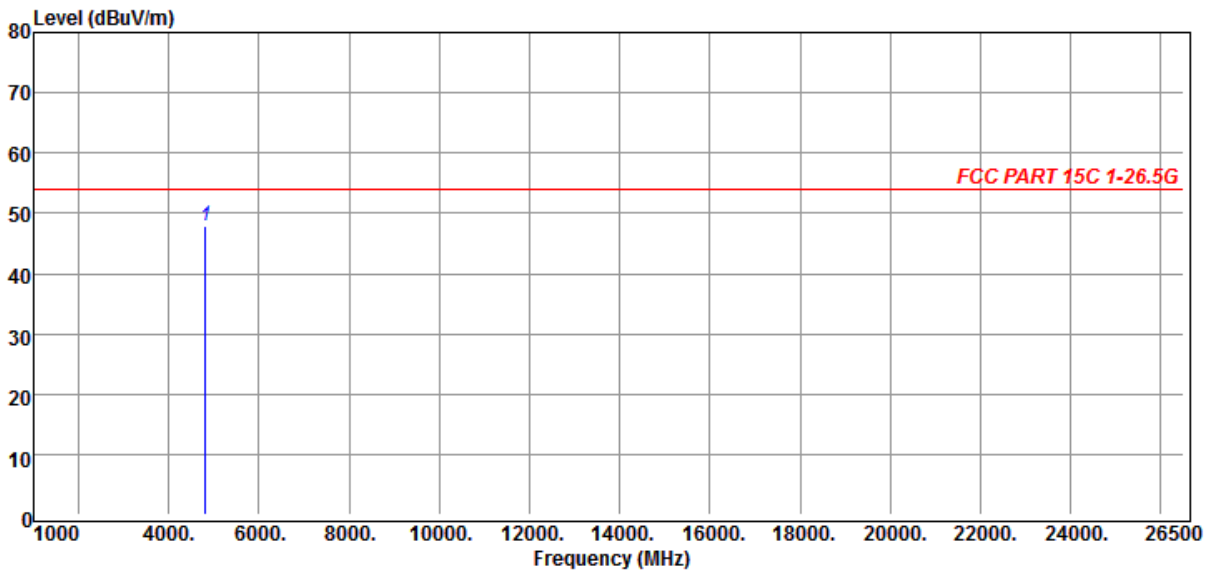

No.	Freq MHz	Reading dBµV	C.F dB	Result dBµV/m	Limit dBµV/m	Margin dB	Antenna Pol.	Remark
1	4804.00	47.27	0.74	48.01	54.00	-5.99	VERTICAL	Peak

Note 1. C.F (Correction Factor) = Antenna factor + Cable loss - Preamp gain ◦

Note 2. Margin = Result - Limit ; Result = Reading + C.F ◦

Remark :

1. Measuring frequencies from 1 GHz to the 10th harmonic of highest fundamental frequency.
2. Measurements above show only up to 6 maximum emissions noted, or would be lesser if no specific emissions from the EUT are recorded (ie: margin > 20dB from the applicable limit) and considered that's already beyond the background noise floor.
3. Radiated emissions measured in frequency above 1000 MHz were made with an instrument using Peak detector mode and average detector mode of the emission shown in Actual FS column.
4. All readings are Peak values. None of the peak value reading exceeds the A.V. limit. Hence, A.V. reading was not measured.
5. Spectrum setting:
 - (a) Peak Setting 1GHz to 10th harmonics of fundamental, RBW = VBW = 1MHz, Sweep = AUTO.

Radiated Emission Test Data (Above and Field Strength to 10th Harmonic)

Temperature	: 27.3°C	Humidity	: 52%
Test Date	: 2019-06-06	Tested by	: Andrew Lin
Polarization	: Horizontal	Channel	: CH00
EUT Position	: X axis	Data rate	: 1Mbps

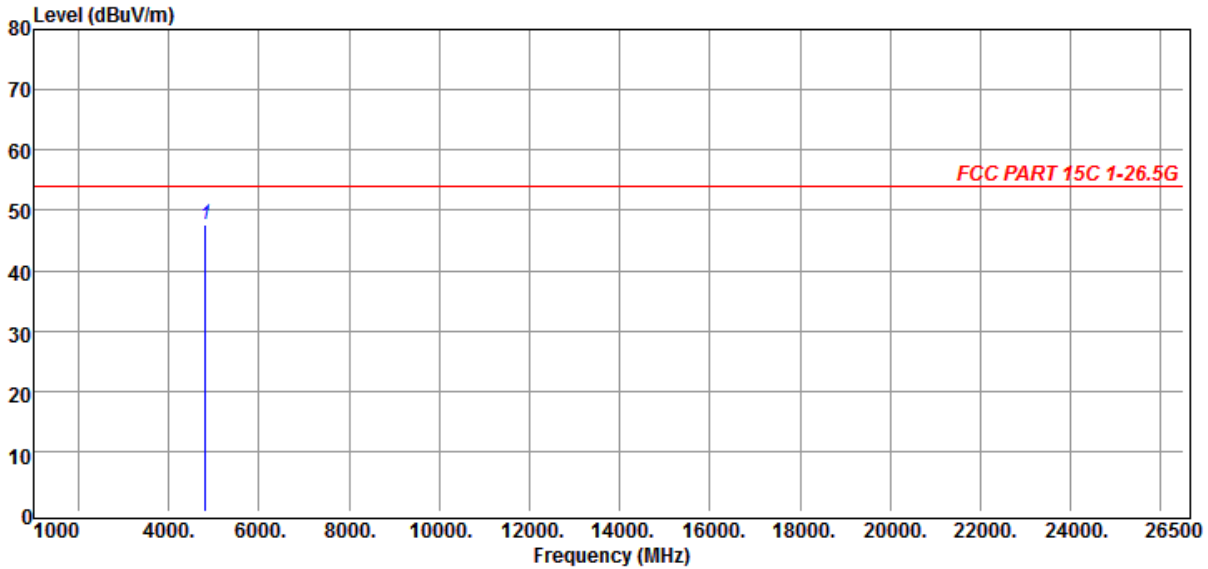

No.	Freq MHz	Reading dBµV	C.F dB	Result dBµV/m	Limit dBµV/m	Margin dB	Antenna Pol.	Remark
1	4804.00	46.84	0.74	47.58	54.00	-6.42	HORIZONTAL	Peak

Note 1. C.F (Correction Factor) = Antenna factor + Cable loss - Preamp gain ◦

Note 2. Margin = Result - Limit ; Result = Reading + C.F ◦

Remark :

1. Measuring frequencies from 1 GHz to the 10th harmonic of highest fundamental frequency.
2. Measurements above show only up to 6 maximum emissions noted, or would be lesser if no specific emissions from the EUT are recorded (ie: margin > 20dB from the applicable limit) and considered that's already beyond the background noise floor.
3. Radiated emissions measured in frequency above 1000 MHz were made with an instrument using Peak detector mode and average detector mode of the emission shown in Actual FS column.
4. All readings are Peak values. None of the peak value reading exceeds the A.V. limit. Hence, A.V. reading was not measured.
5. Spectrum setting:
 - (a) Peak Setting 1GHz to 10th harmonics of fundamental, RBW = VBW = 1MHz, Sweep = AUTO.

Radiated Emission Test Data (Above and Field Strength to 10th Harmonic)

Temperature	: 27.3°C	Humidity	: 52%
Test Date	: 2019-06-06	Tested by	: Andrew Lin
Polarization	: Vertical	Channel	: CH20
EUT Position	: X axis	Data rate	: 1Mbps

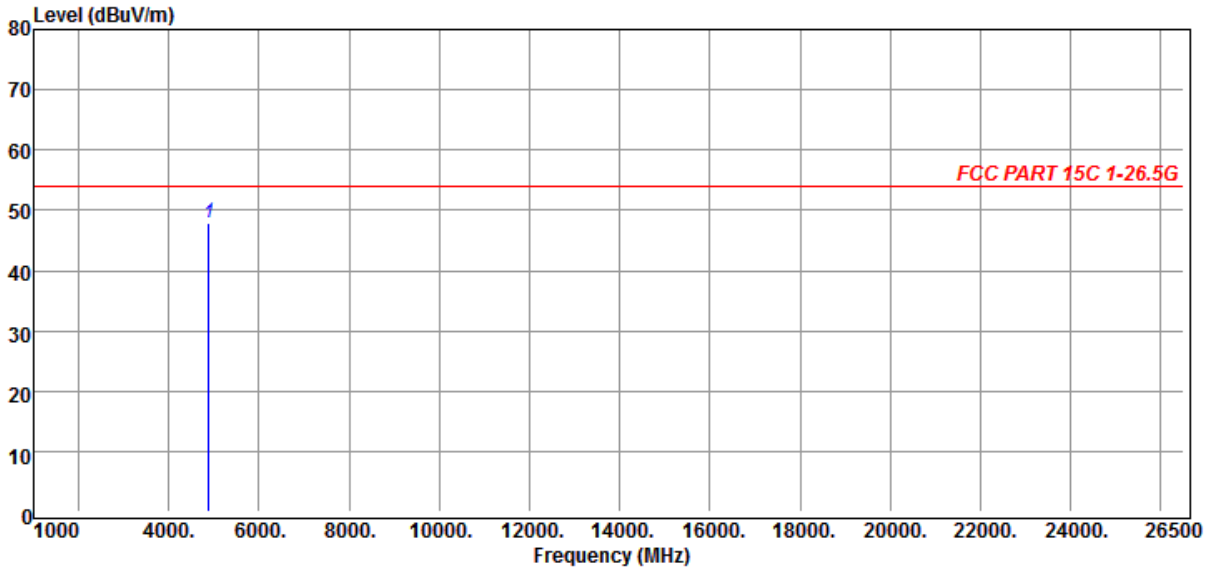

No.	Freq MHz	Reading dBµV	C.F dB	Result dBµV/m	Limit dBµV/m	Margin dB	Antenna Pol.	Remark
1	4884.00	46.88	1.02	47.90	54.00	-6.10	VERTICAL	Peak

Note 1. C.F (Correction Factor) = Antenna factor + Cable loss - Preamp gain ◦

Note 2. Margin = Result - Limit ; Result = Reading + C.F ◦

Remark :

1. Measuring frequencies from 1 GHz to the 10th harmonic of highest fundamental frequency.
2. Measurements above show only up to 6 maximum emissions noted, or would be lesser if no specific emissions from the EUT are recorded (ie: margin > 20dB from the applicable limit) and considered that's already beyond the background noise floor.
3. Radiated emissions measured in frequency above 1000 MHz were made with an instrument using Peak detector mode and average detector mode of the emission shown in Actual FS column.
4. All readings are Peak values. None of the peak value reading exceeds the A.V. limit. Hence, A.V. reading was not measured.
5. Spectrum setting:
 - (a) Peak Setting 1GHz to 10th harmonics of fundamental, RBW = VBW = 1MHz, Sweep = AUTO.

Radiated Emission Test Data (Above and Field Strength to 10th Harmonic)

Temperature	: 27.3°C	Humidity	: 52%
Test Date	: 2019-06-06	Tested by	: Andrew Lin
Polarization	: Horizontal	Channel	: CH20
EUT Position	: X axis	Data rate	: 1Mbps

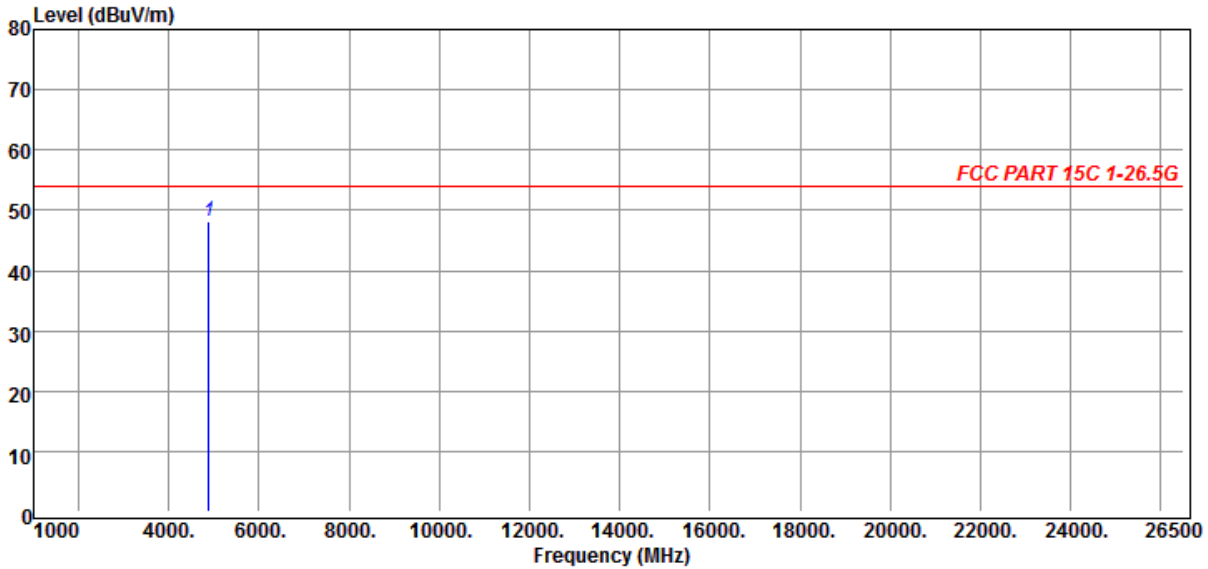

No.	Freq MHz	Reading dBµV	C.F dB	Result dBµV/m	Limit dBµV/m	Margin dB	Antenna Pol.	Remark
1	4884.00	47.16	1.02	48.18	54.00	-5.82	HORIZONTAL	Peak

Note 1. C.F (Correction Factor) = Antenna factor + Cable loss - Preamp gain ◦

Note 2. Margin = Result - Limit ; Result = Reading + C.F ◦

Remark :

1. Measuring frequencies from 1 GHz to the 10th harmonic of highest fundamental frequency.
2. Measurements above show only up to 6 maximum emissions noted, or would be lesser if no specific emissions from the EUT are recorded (ie: margin > 20dB from the applicable limit) and considered that's already beyond the background noise floor.
3. Radiated emissions measured in frequency above 1000 MHz were made with an instrument using Peak detector mode and average detector mode of the emission shown in Actual FS column.
4. All readings are Peak values. None of the peak value reading exceeds the A.V. limit. Hence, A.V. reading was not measured.
5. Spectrum setting:
 - (a) Peak Setting 1GHz to 10th harmonics of fundamental, RBW = VBW = 1MHz, Sweep = AUTO.

Radiated Emission Test Data (Above and Field Strength to 10th Harmonic)

Temperature	: 27.3°C	Humidity	: 52%
Test Date	: 2019-06-06	Tested by	: Andrew Lin
Polarization	: Vertical	Channel	: CH39
EUT Position	: X axis	Data rate	: 1Mbps

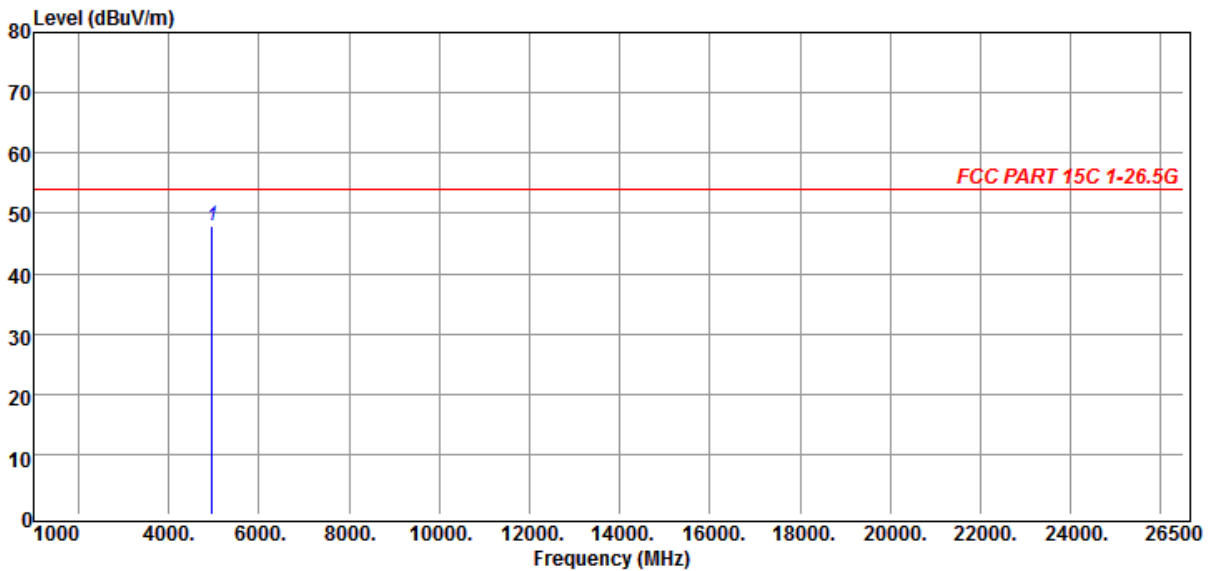

No.	Freq MHz	Reading dBµV	C.F dB	Result dBµV/m	Limit dBµV/m	Margin dB	Antenna Pol.	Remark
1	4960.00	46.42	1.41	47.83	54.00	-6.17	VERTICAL	Peak

Note 1. C.F (Correction Factor) = Antenna factor + Cable loss - Preamp gain ◦

Note 2. Margin = Result - Limit ; Result = Reading + C.F ◦

Remark :

1. Measuring frequencies from 1 GHz to the 10th harmonic of highest fundamental frequency.
2. Measurements above show only up to 6 maximum emissions noted, or would be lesser if no specific emissions from the EUT are recorded (ie: margin > 20dB from the applicable limit) and considered that's already beyond the background noise floor.
3. Radiated emissions measured in frequency above 1000 MHz were made with an instrument using Peak detector mode and average detector mode of the emission shown in Actual FS column.
4. All readings are Peak values. None of the peak value reading exceeds the A.V. limit. Hence, A.V. reading was not measured.
5. Spectrum setting:
 - (a) Peak Setting 1GHz to 10th harmonics of fundamental, RBW = VBW = 1MHz, Sweep = AUTO.

Radiated Emission Test Data (Above and Field Strength to 10th Harmonic)

Temperature	: 27.3°C	Humidity	: 52%
Test Date	: 2019-06-06	Tested by	: Andrew Lin
Polarization	: Horizontal	Channel	: CH39
EUT Position	: X axis	Data rate	: 1Mbps

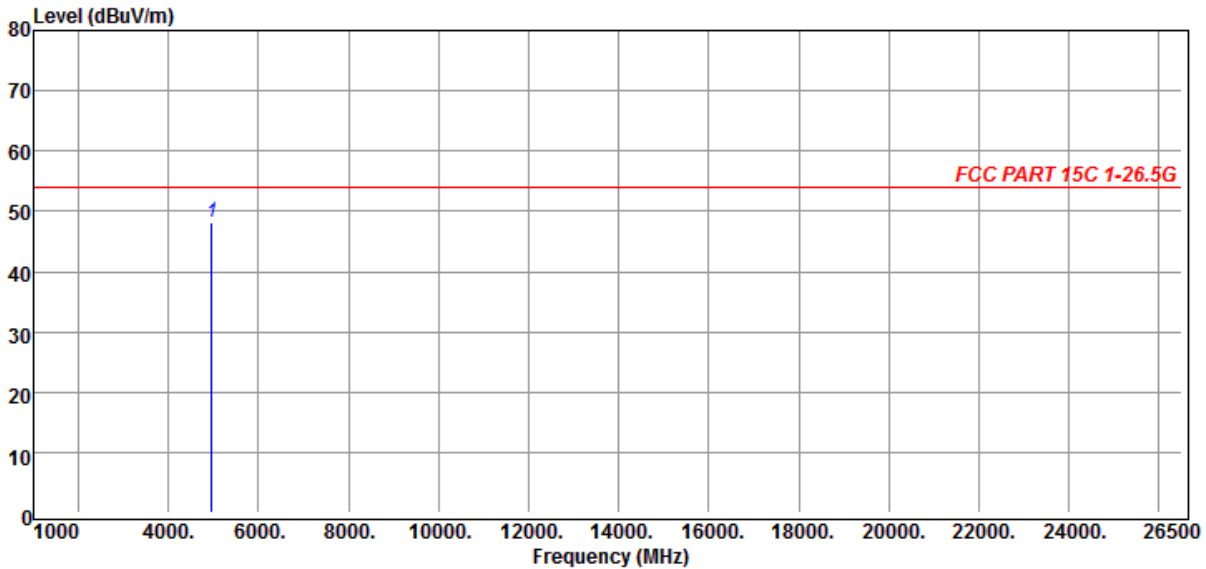

No.	Freq MHz	Reading dBμV	C.F dB	Result dBμV/m	Limit dBμV/m	Margin dB	Antenna Pol.	Remark
1	4960.00	46.78	1.41	48.19	54.00	-5.81	HORIZONTAL	Peak

Note 1. C.F (Correction Factor) = Antenna factor + Cable loss - Preamp gain ◦

Note 2. Margin = Result - Limit ; Result = Reading + C.F ◦

Remark :

1. Measuring frequencies from 1 GHz to the 10th harmonic of highest fundamental frequency.
2. Measurements above show only up to 6 maximum emissions noted, or would be lesser if no specific emissions from the EUT are recorded (ie: margin > 20dB from the applicable limit) and considered that's already beyond the background noise floor.
3. Radiated emissions measured in frequency above 1000 MHz were made with an instrument using Peak detector mode and average detector mode of the emission shown in Actual FS column.
4. All readings are Peak values. None of the peak value reading exceeds the A.V. limit. Hence, A.V. reading was not measured.
5. Spectrum setting:
 - (a) Peak Setting 1GHz to 10th harmonics of fundamental, RBW = VBW = 1MHz, Sweep = AUTO.

4 Out of Band Emission Test

4.1 Test Instruments

Refer to Sec. 1.2 Test Instruments.

4.2 Test Arrangement and Procedure

Refer to Sec. 3.2.

4.3 Limit of Field Strength of Fundamental (§ 15.249(d))

Emissions radiated outside of the specified frequency bands, except for harmonics, shall be attenuated by at least 50 dB below the level of the fundamental or to the general radiated emission limits in § 15.209, whichever is the lesser attenuation.

4.4 Test Result

Compliance

The final test data are shown on the following page(s).

Band-Edge Test Data (Lower Edge)

Temperature	: 27.3°C	Humidity	: 52%
Test Date	: 2019-06-06	Tested by	: Andrew Lin
Polarization	: Vertical	Channel	: CH00
EUT Position	: X axis	Data Rate	: 1Mbps

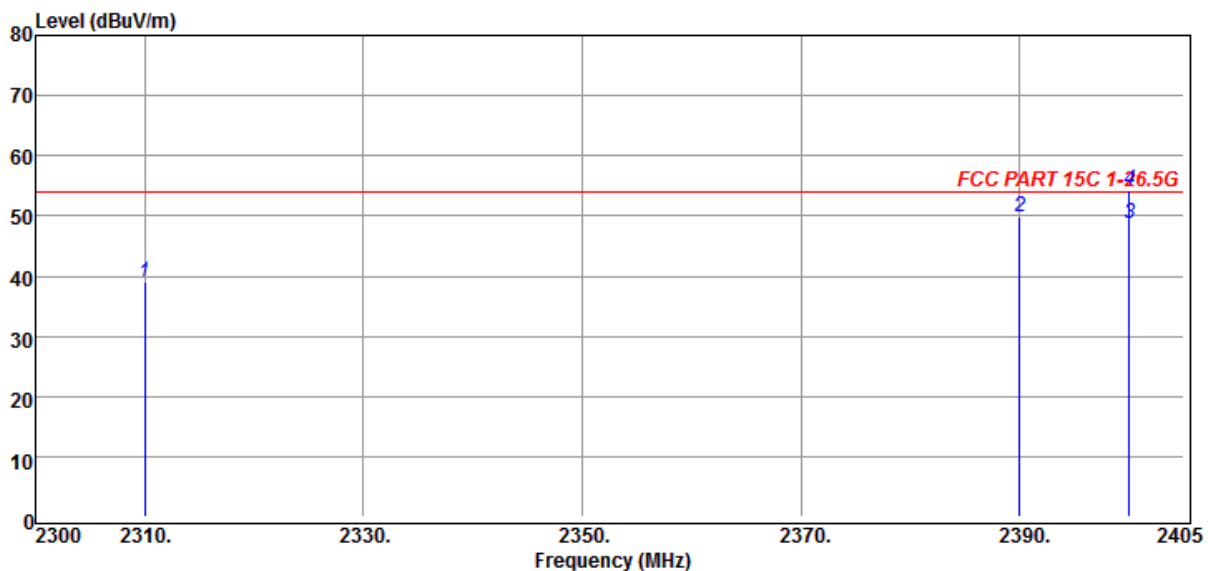

No.	Freq MHz	Reading dBμV	C.F dB	Result dBμV/m	Limit dBμV/m	Margin dB	Antenna Pol.	Remark
1	2310.00	45.86	-6.93	38.93	54.00	-15.07	VERTICAL	Peak
2	2390.00	56.54	-6.67	49.87	54.00	-4.13	VERTICAL	Peak
3	2400.00	55.48	-6.64	48.84	54.00	-5.16	VERTICAL	Average
4	2400.00	60.86	-6.64	54.22	54.00	0.22	VERTICAL	Peak

Note 1. C.F (Correction Factor) = Antenna factor + Cable loss - Preamp gain ◦

Note 2. Margin = Result - Limit ; Result = Reading + C.F ◦

Remark :

- Measuring frequencies from 1 GHz to the 10th harmonic of highest fundamental frequency.
- Measurements above show only up to 6 maximum emissions noted, or would be lesser if no specific emissions from the EUT are recorded (ie: margin > 20dB from the applicable limit) and considered that's already beyond the background noise floor.
- Radiated emissions measured in frequency above 1000 MHz were made with an instrument using Peak detector mode and average detector mode of the emission shown in Actual FS column.
- All readings are Peak values. None of the peak value reading exceeds the A.V. limit. Hence, A.V. reading was not measured.
- Spectrum setting:
 - Peak Setting 1GHz to 10th harmonics of fundamental, RBW = VBW = 1MHz, Sweep = AUTO.

Band-Edge Test Data (Lower Edge)

Temperature	: 27.3°C	Humidity	: 52%
Test Date	: 2019-06-06	Tested by	: Andrew Lin
Polarization	: Horizontal	Channel	: CH00
EUT Position	: X axis	Data Rate	: 1Mbps

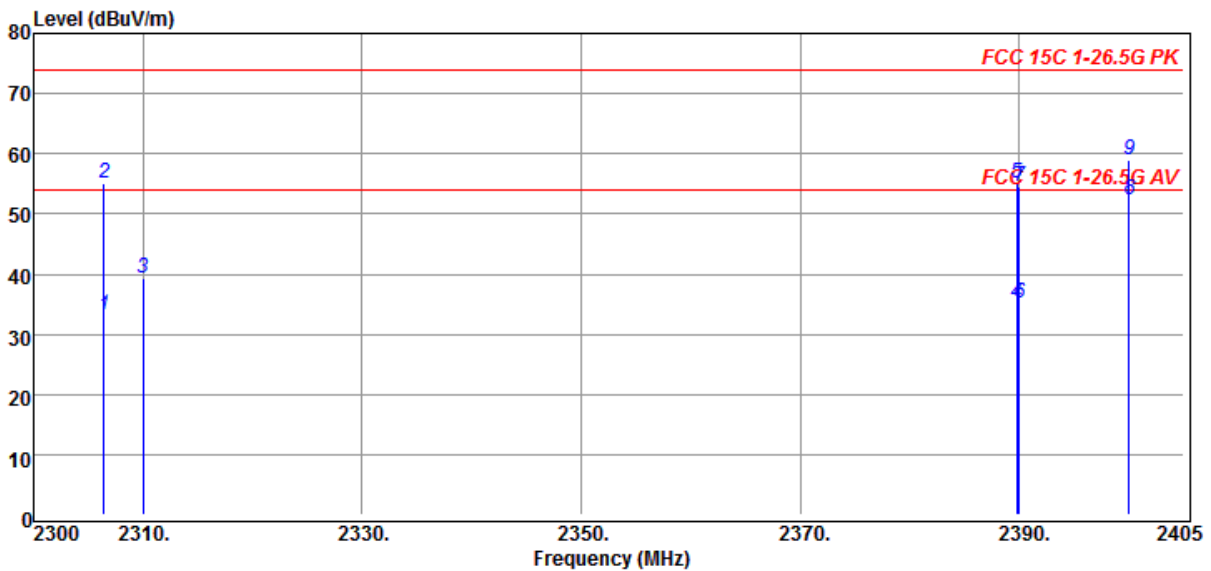

No.	Freq MHz	Reading dBμV	C.F dB	Result dBμV/m	Limit dBμV/m	Margin dB	Antenna Pol.	Remark
1	2306.41	40.20	-6.93	33.27	54.00	-20.73	HORIZONTAL	Average
2	2306.41	62.15	-6.93	55.22	74.00	-18.78	HORIZONTAL	peak
3	2310.00	46.15	-6.93	39.22	74.00	-34.78	HORIZONTAL	peak
4	2389.78	41.79	-6.67	35.12	54.00	-18.88	HORIZONTAL	Average
5	2389.78	61.66	-6.67	54.99	74.00	-19.01	HORIZONTAL	peak
6	2390.00	41.89	-6.67	35.22	54.00	-18.78	HORIZONTAL	Average
7	2390.00	61.07	-6.67	54.40	74.00	-19.60	HORIZONTAL	peak
8	2400.00	59.02	-6.64	52.38	54.00	-1.62	HORIZONTAL	Average
9	2400.00	65.50	-6.64	58.86	74.00	-15.14	HORIZONTAL	peak

Note 1. C.F (Correction Factor) = Antenna factor + Cable loss - Preamp gain ◦

Note 2. Margin = Result - Limit ; Result = Reading + C.F ◦

Remark :

1. Measuring frequencies from 1 GHz to the 10th harmonic of highest fundamental frequency.
2. Measurements above show only up to 6 maximum emissions noted, or would be lesser if no specific emissions from the EUT are recorded (ie: margin > 20dB from the applicable limit) and considered that's already beyond the background noise floor.
3. Radiated emissions measured in frequency above 1000 MHz were made with an instrument using Peak detector mode and average detector mode of the emission shown in Actual FS column.
4. All readings are Peak values. None of the peak value reading exceeds the A.V. limit. Hence, A.V. reading was not measured.
5. Spectrum setting:
 - (a) Peak Setting 1GHz to 10th harmonics of fundamental, RBW = VBW = 1MHz, Sweep = AUTO.

Band-Edge Test Data (Upper Edge)

Temperature	: 27.3°C	Humidity	: 52%
Test Date	: 2019-06-06	Tested by	: Andrew Lin
Polarization	: Vertical	Channel	: CH39
EUT Position	: X axis	Data Rate	: 1Mbps

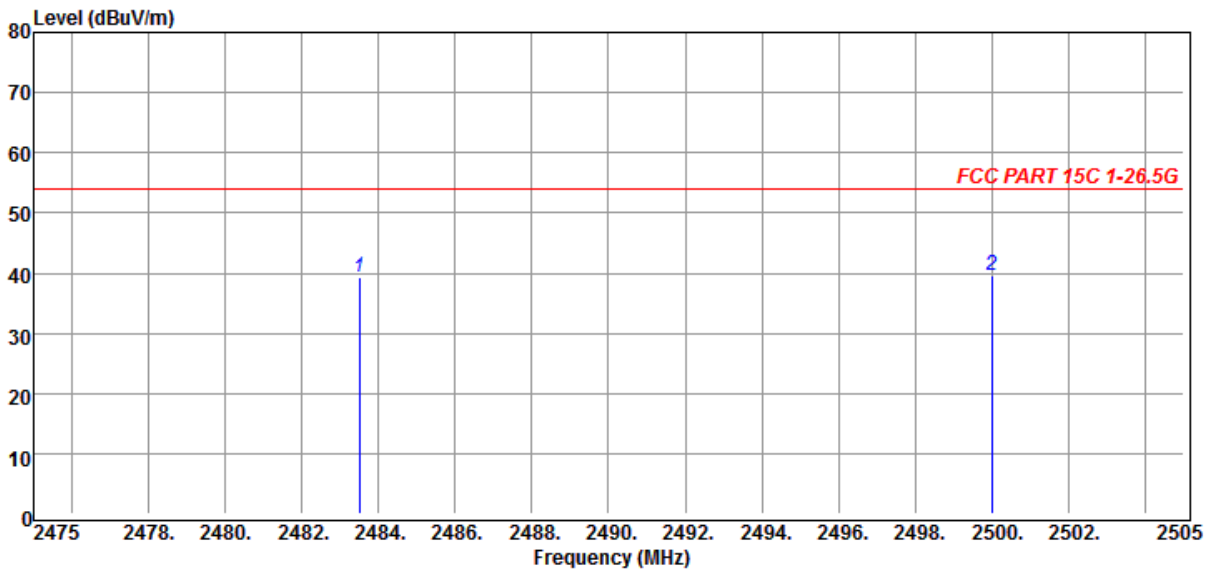

No.	Freq MHz	Reading dBμV	C.F dB	Result dBμV/m	Limit dBμV/m	Margin dB	Antenna Pol.	Remark
1	2483.50	45.71	-6.44	39.27	54.00	-14.73	VERTICAL	Peak
2	2500.00	46.03	-6.31	39.72	54.00	-14.28	VERTICAL	Peak

Note 1. C.F (Correction Factor) = Antenna factor + Cable loss - Preamp gain ◦

Note 2. Margin = Result - Limit ; Result = Reading + C.F ◦

Remark :

1. Measuring frequencies from 1 GHz to the 10th harmonic of highest fundamental frequency.
2. Measurements above show only up to 6 maximum emissions noted, or would be lesser if no specific emissions from the EUT are recorded (ie: margin > 20dB from the applicable limit) and considered that's already beyond the background noise floor.
3. Radiated emissions measured in frequency above 1000 MHz were made with an instrument using Peak detector mode and average detector mode of the emission shown in Actual FS column.
4. All readings are Peak values. None of the peak value reading exceeds the A.V. limit. Hence, A.V. reading was not measured.
5. Spectrum setting:
 - (a) Peak Setting 1GHz to 10th harmonics of fundamental, RBW = VBW = 1MHz, Sweep = AUTO.

Band-Edge Test Data (Upper Edge)

Temperature	: 27.3°C	Humidity	: 52%
Test Date	: 2019-06-06	Tested by	: Andrew Lin
Polarization	: Horizontal	Channel	: CH39
EUT Position	: X axis	Data Rate	: 1Mbps

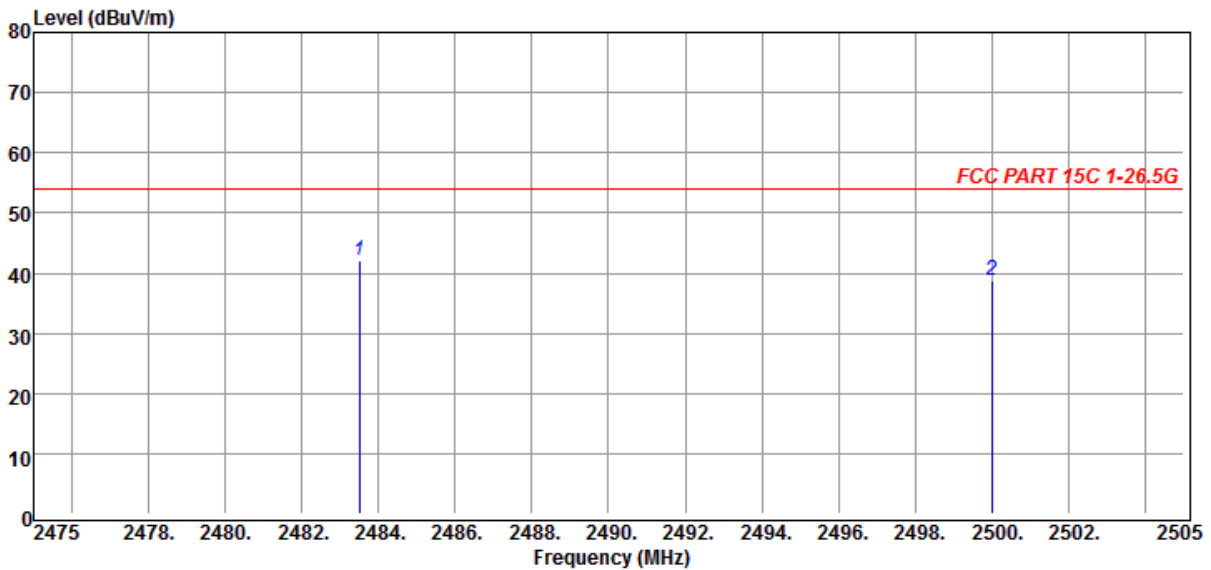

No.	Freq MHz	Reading dB μ V	C.F dB	Result dB μ V/m	Limit dB μ V/m	Margin dB	Antenna Pol.	Remark
1	2483.50	48.61	-6.44	42.17	54.00	-11.83	HORIZONTAL	Peak
2	2500.00	44.96	-6.31	38.65	54.00	-15.35	HORIZONTAL	Peak

Note 1. C.F (Correction Factor) = Antenna factor + Cable loss - Preamp gain ◦

Note 2. Margin = Result - Limit ; Result = Reading + C.F ◦

Remark :

- Measuring frequencies from 1 GHz to the 10th harmonic of highest fundamental frequency.
- Measurements above show only up to 6 maximum emissions noted, or would be lesser if no specific emissions from the EUT are recorded (ie: margin > 20dB from the applicable limit) and considered that's already beyond the background noise floor.
- Radiated emissions measured in frequency above 1000 MHz were made with an instrument using Peak detector mode and average detector mode of the emission shown in Actual FS column.
- All readings are Peak values. None of the peak value reading exceeds the A.V. limit. Hence, A.V. reading was not measured.
- Spectrum setting:
 - Peak Setting 1GHz to 10th harmonics of fundamental, RBW = VBW = 1MHz, Sweep = AUTO.

5 20 dB Bandwidth

5.1 Test Instruments

Refer to Sec. 1.2 Test Instruments.

5.2 Test Arrangement and Procedure

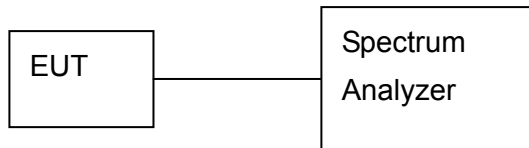

1. The transmitter output was connected to a spectrum analyzer (through an attenuator, if it's necessary).
2. The bandwidth of the fundamental frequency was measured by spectrum analyzer with 100kHz RBW and 300kHz VBW. Measured the -20 dB bandwidth and plotted the graph.

5.3 Limit

None; For report purpose only.

5.4 Test Result

No non-compliance noted.

The final test data are shown on the following page(s).

Temperature : 27.3°C Humidity : 52%
 Test Date : 2019-06-06 Tested by : Andrew Lin
 Data Rate : 1 Mbps Channel : 00

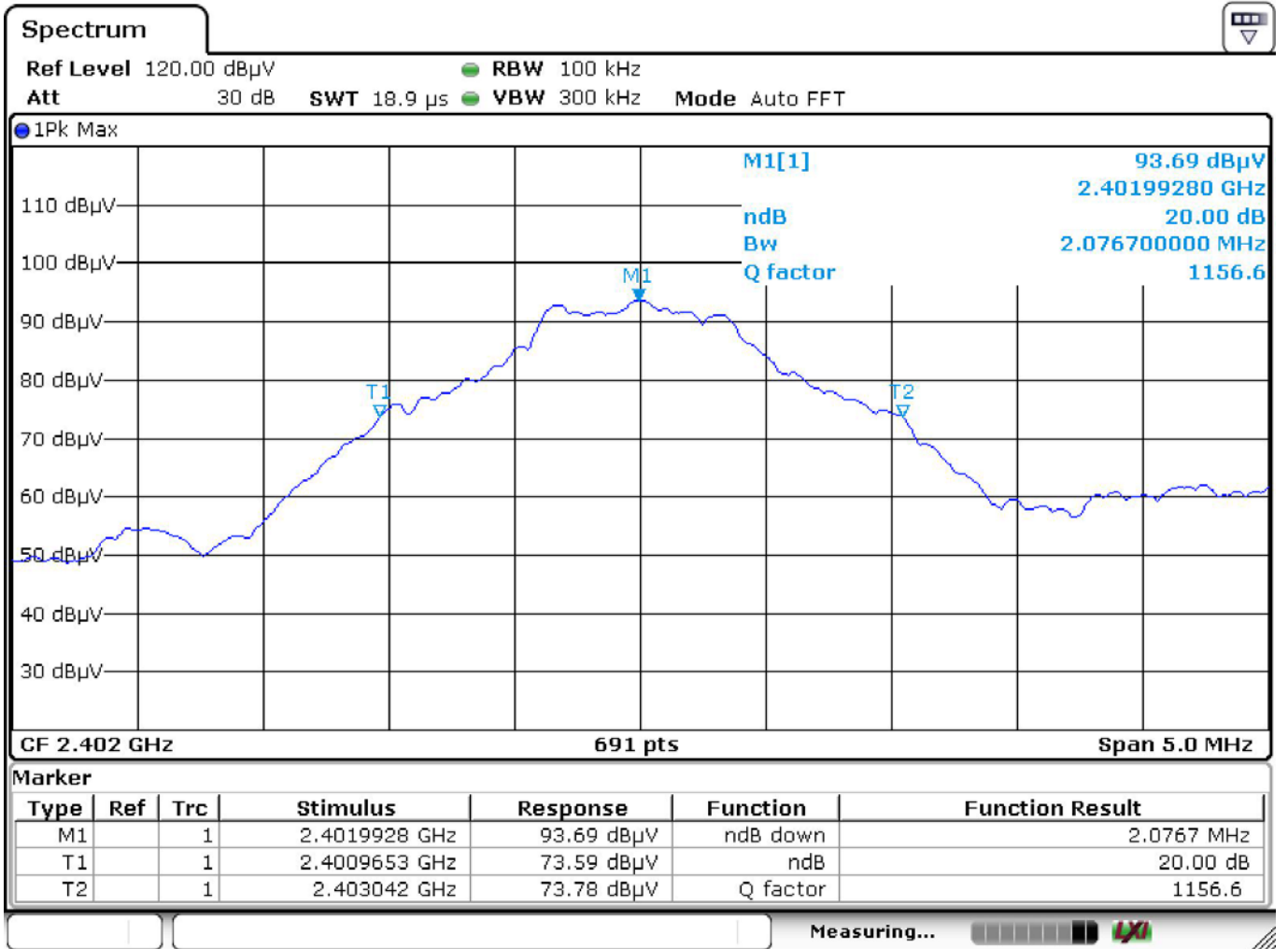

Data Rate : 1 Mbps Channel : 20

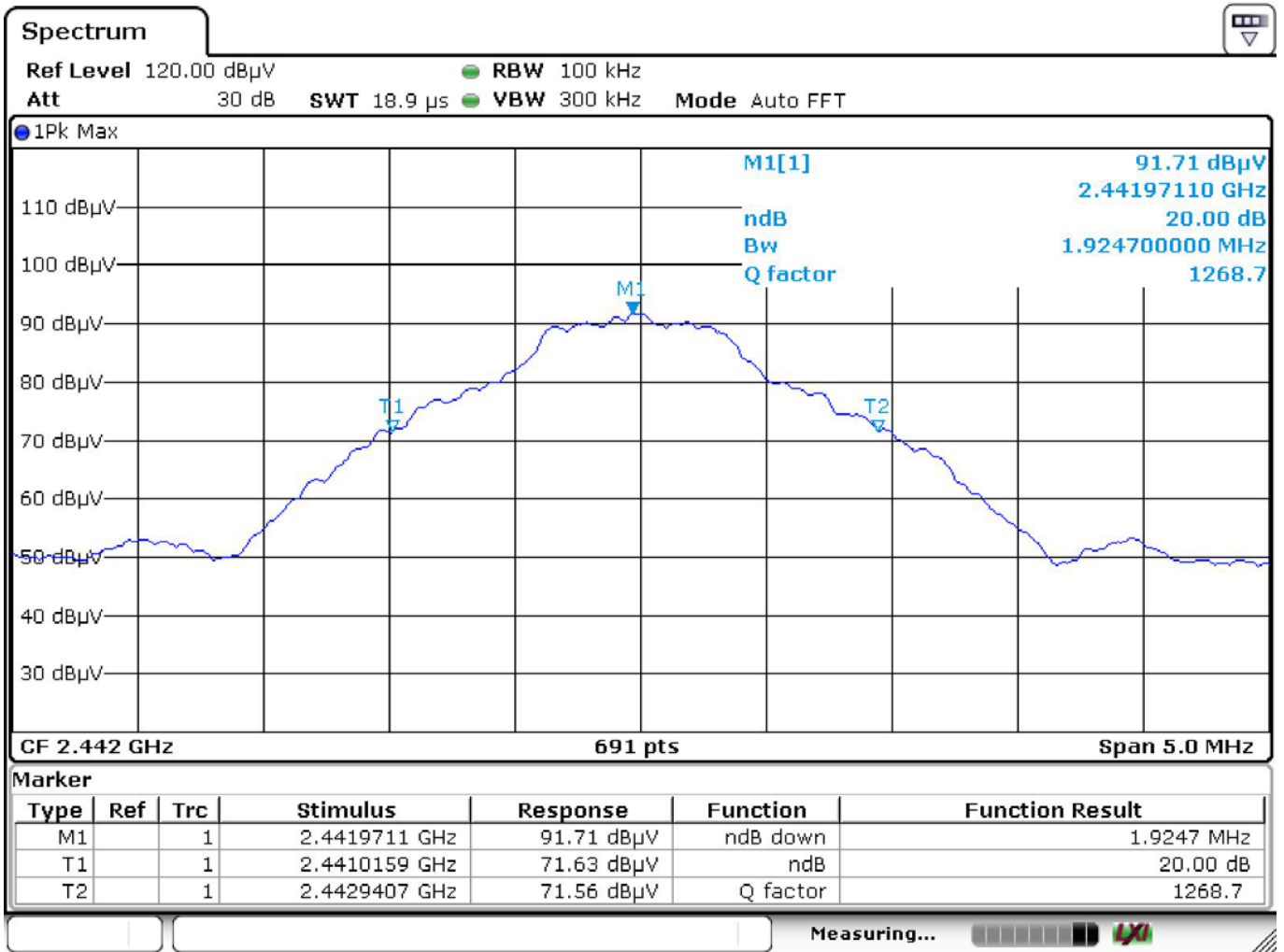

Data Rate : 1 Mbps Channel : 39

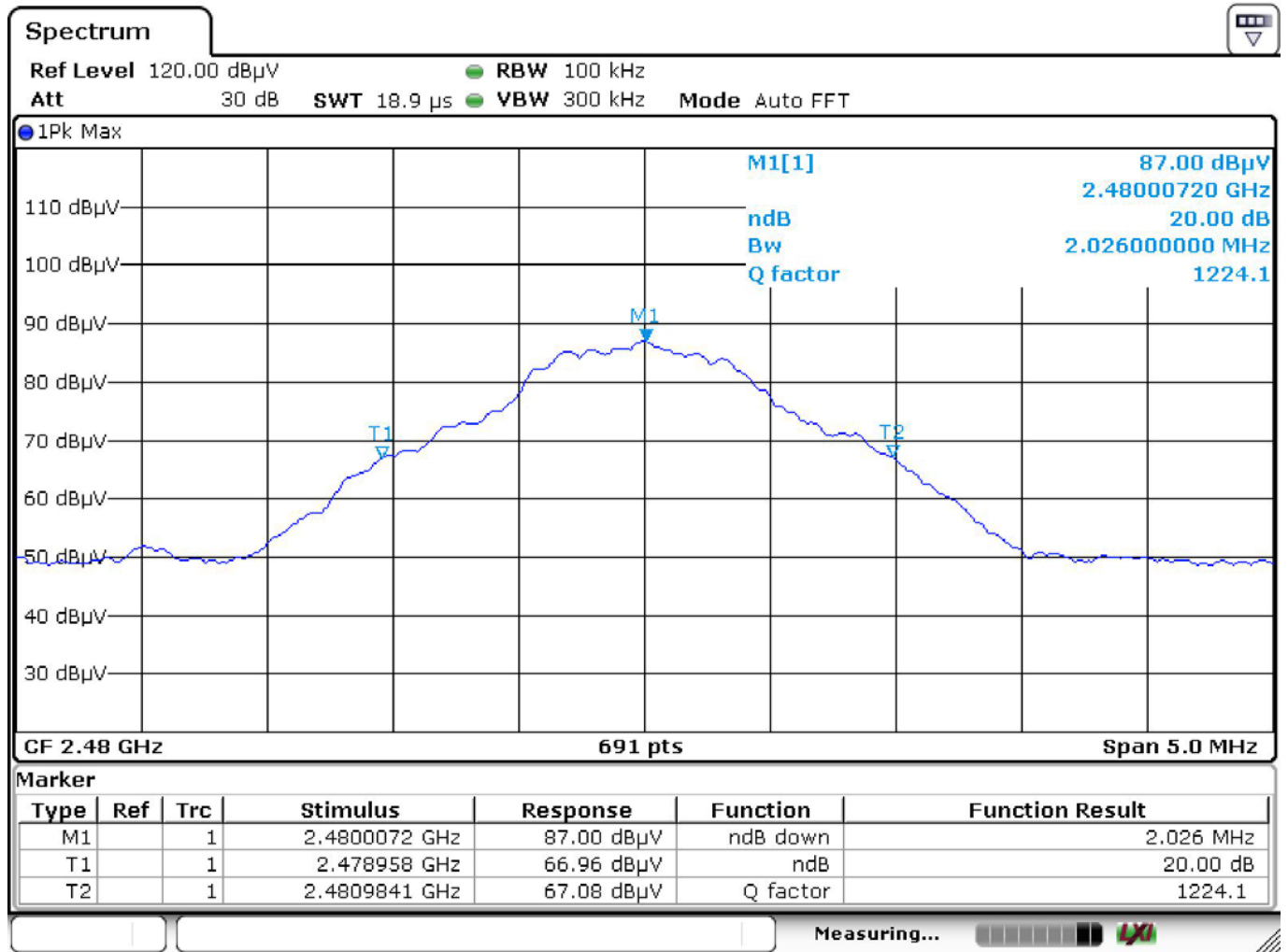

6 Antenna requirement

6.1 Limit (§ 15.203)

An intentional radiator shall be designed to ensure that no antenna other than that furnished by the responsible party shall be used with the device. The use of a permanently attached antenna or of an antenna that uses a uniue coupling to the intentional radiator shall be considered sufficient to comply with the provisions of this section. The manufacturer may design the unit so that a broken antenna can be replaced by the user, but the use of a standard antenna jack or electrical connector is prohibited. This requirement does not apply to carrier current devices or to devices operated under the provisions of § 15.211, § 15.213, § 15.217, § 15.219, or § 15.221. Further, this requirement does not apply to intentional radiators that must be professionally installed, such as perimeter protection systems and some field disturbance sensors, or to other intentional radiators which, in accordance with § 15.31(d), must be measured at the installation site. However, the installer shall be responsible for ensuring that the proper antenna is employed so that the limits in this part are not exceeded.

6.2 Test Result

Compliance.

The EUT applies a Chip Ceramic antenna.

-----End Of Test Report-----