

Annex acc. to FCC Title 47 CFR Part 15  
relating to  
Hirschmann Car Communication GmbH  
920287A

# Annex no. 5

## User Manual

### Functional Description

Title 47 - Telecommunication  
Part 15 - Radio Frequency Devices  
Subpart C – Intentional Radiators  
ANSI C63.4-2014  
ANSI C63.10-2013



Deutsche  
Akkreditierungsstelle  
D-PL-12053-01-00

**User Manual / Functional Description of the test equipment (EUT)**

	<p>User's manual / Operational Description 920287A</p>	<p>ODA Antenna Engineering  Date: 17.12.2018 Revision: V1.5</p>
---	--	---

# 920287A

## Transceiver Remote Entry

User's manual / Operational Description

	Name, Department	Date	Unterschrift
<b>Autor</b>	Jörg Maisenbacher		
<b>Freigabe</b>			
<b>Verteiler</b>	HCC Antennen		

	User's manual / Operational Description 920287A	ODA Antenna Engineering  Date: 17.12.2018 Revision: V1.5
---	--	--

## Table of Contents

<b>1</b>	<b>Change history .....</b>	<b>2</b>
<b>2</b>	<b>Overview .....</b>	<b>3</b>
2.1	Block diagram .....	3
2.2	Connections .....	3
2.3	Interaction .....	4
2.4	Installation .....	4
2.5	Operating temperature range .....	4
2.6	Interface .....	4
<b>3</b>	<b>Operational characteristics .....</b>	<b>4</b>
3.1	General Information .....	4
3.2	Receiver .....	5
3.3	Transmitter .....	5
3.4	Transmission .....	5
3.5	Frequency Generation and Stability .....	6
3.6	Further signal-sources (clock generators): .....	6
3.7	ON / OFF State of Oscillators in Dependency of Operatingmode .....	7
<b>4</b>	<b>Operational Procedures .....</b>	<b>7</b>

## 1 Change history

Datum	Chapter	Change	Author	Version
29.11.10	all	initial release	Maisenbacher	V0.1
01.09.15		Optically improved	Nebel	V1.1
12.12.18	all	mods	Nebel	V1.5

	User's manual / Operational Description 920287A	ODA Antenna Engineering
		Date: 17.12.2018 Revision: V1.5

## 2 Overview

### 2.1 Block diagram

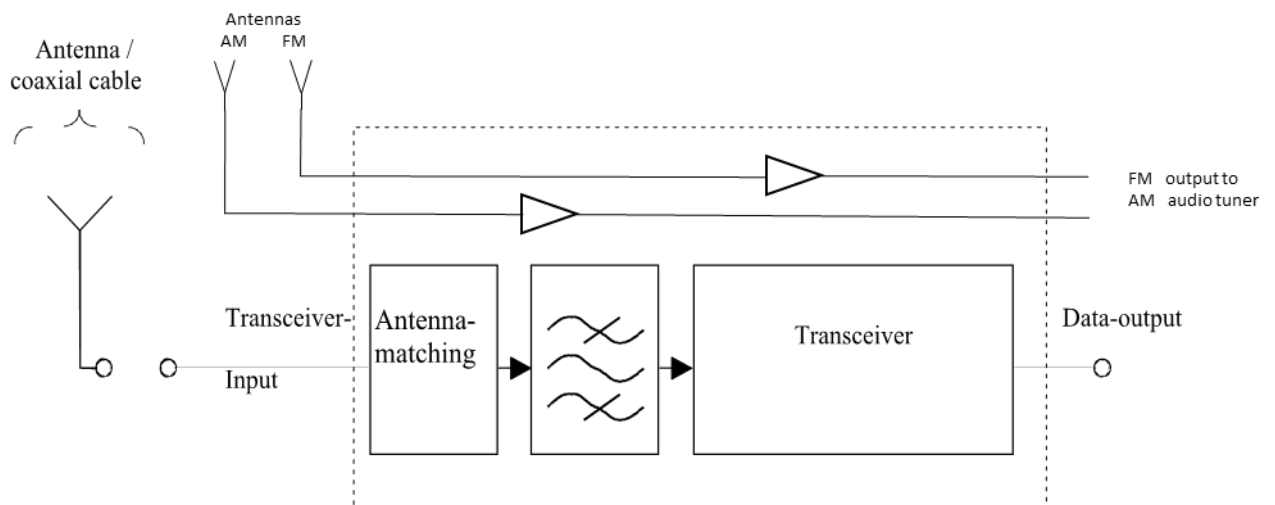

Figure 1: Blockdiagram of the remote-entry circuit

### 2.2 Broadcast reception amplifier

AM 530-1600kHz  
 FM 88-108MHz

### 2.3 Connections

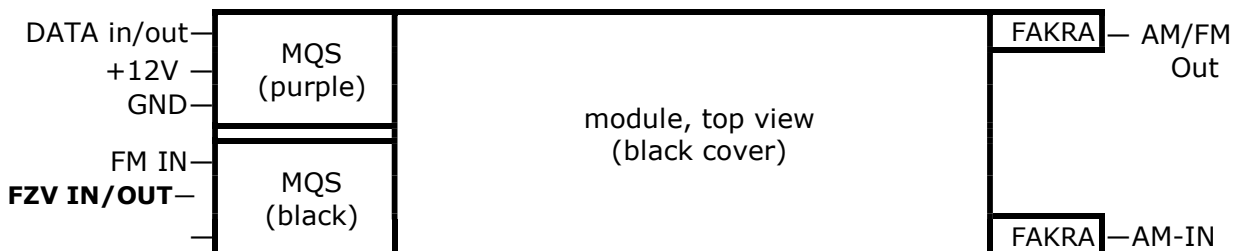
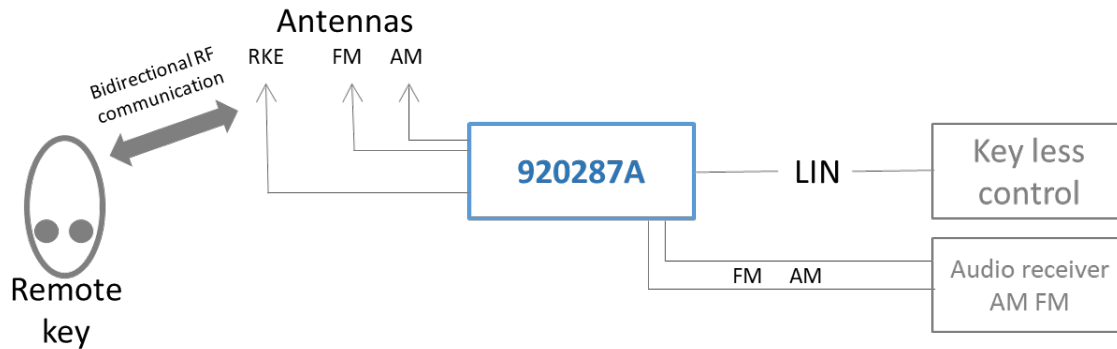

Figure 2: schematic view of module of the complete antenna amplifier (FZV IN/OUT is RF in/output for remote-entry System)

	User's manual / Operational Description 920287A	ODA Antenna Engineering
		Date: 17.12.2018 Revision: V1.5

## 2.4 Interaction



## 2.5 Installation

The remote control box is installed inside a vehicle and behind the cabin cover. Only service personnel is able to touch or handle it.

## 2.6 Operating temperature range

-40 ... +85°C

## 2.7 Interface

- Supply Voltage (+12V)
- RF-Interface; input / output
- Data-Interface 1-wire [bidirectional, digital, open-collector]

## 3 Operational characteristics

### 3.1 General Information

parameter		min	max	
Supply voltage		7,0	18,0	V
Current consumption	Cyclic for 55ms pre-signal, 3 channels ( $f_0-450\text{kHz}$ , $f_0$ , $f_0+450\text{kHz}$ )		700	$\mu\text{A}$

	User's manual / Operational Description 920287A	ODA Antenna Engineering  Date: 17.12.2018 Revision: V1.5
---	--	--

Current consumption when strong interfering signals	Cyclic for 55ms pre-signal, 3 channels ( $f_0-450\text{kHz}$ , $f_0$ , $f_0+450\text{kHz}$ ) interfering signals > -40dBm		900	$\mu\text{A}$
Current consumption (TX)	@+10dBm output power @ 50Ohm		40	mA
Frequency range	ECE	433,44	434,40	MHz
Max antenna gain			-2	dBi

### 3.2 Receiver

parameter		min	max	
Sensitivity	Matched to 50 Ohm Symbol rate: 10kBaud Manchester FSK-Modulation $\pm 10\text{kHz}$ deviation		-98	dBm
<b>Blocking</b> <b>(ratio of interfering signal to power of receiving signal)</b>	$\geq 150\text{ kHz}$		$\geq 30$	dB
	$\geq 225\text{ kHz}$		$\geq 40$	dB
	$\geq 450\text{ kHz}$		$\geq 45$	dB
	$\geq 800\text{ kHz}$		$\geq 50$	dB
	$\geq 1500\text{ kHz}$		$\geq 60$	dB
	$\geq 2500\text{ kHz}$		$\geq 70$	dB
	$\geq 5000\text{ kHz}$		$\geq 80$	dB

### 3.3 Transmitter

parameter		min	max	
Transmit power	ECE	+5	+10	dBm

The transmit power is referenced to the interface between module and car-antenna.

### 3.4 Transmission

#### 3.4.1 Data rates

for digital 1-wire and RF:

10 kBit / sec (ECE, USA)  $\leq \pm 1,0\%$

	User's manual / Operational Description 920287A	ODA Antenna Engineering Date: 17.12.2018 Revision: V1.5
---	--	--

### 3.4.2 Modulation

Frequency modulation FSK with 10kHz deviation.

### 3.4.3 Channel definition

The following table shows the center-frequencies for each channel.

The frequency-separation between two adjacent channels is 450 kHz.

Channel name		Center-frequency
name	Short name	
channel 1	CH1	ECE: 433,47 MHz
channel 2	CH2	ECE: 434,37 MHz
channel 3	CH3	ECE: 433,92 MHz

table 1: center frequencies of all channels

### 3.4.4 Carrier frequency

The carrier frequency has a tolerance (including influences because of temperature, aging, manufacturing tolerance) of:

ECE: 433,47 MHz  $\pm$  70ppm, 433,92 MHz  $\pm$  70ppm, 434,47 MHz  $\pm$  70ppm

## 3.5 Frequency Generation and Stability

The RF-frequencies are created with a fractional N PLL (phase locked loop). The frequency of the local oscillator is controlled by the fractional N Synthesizer. The discrete channel-frequencies are configured by digital settings

- The RX and TX- frequency deviation is  $\pm$ 10 kHz
- The RX intermediate frequency (IF) is 250kHz.
- RX receiver channel bandwidth is 165kHz.
- The PLL is referenced to a crystal oscillator
- The crystal oscillator (XTO) is operated at  $f_{XTO} = 24,2879$  MHz
- The tolerance of the crystal is  $\pm$ 70ppm.

## 3.6 Further signal-sources (clock generators):

- Slow RC Oscillator:  $f_{SRC} = 125\text{kHz} \pm 5\%$  Sleep Time reference in polling mode.
- Fast RC Oscillator:  $f_{FRC} = 6.36\text{MHz} \pm 10\%$  System clock reference CPU.



	User's manual / Operational Description 920287A	ODA Antenna Engineering Date: 17.12.2018 Revision: V1.5
---	--	--

### 3.7 ON / OFF State of Oscillators in Dependency of Operatingmode

- Polling cycle time : 50ms
- active (without signal):  $t_{AKTIV} = 3.05ms$  (typ.)
- Sleep-phase:  $t_{Sleep} = 46.95ms$  (typ.)

Operating mode =>	Init	Polling		TX-Mode	RX-Mode
		active	sleep		
XTO Oscillator ( $f_{XTO} = 24,2879MHz$ )	off	on	off	on	on
FRC Oscillator ( $f_{FRC} = 6.36MHz$ )	on	on	off	on	on
SRC Oscillator ( $f_{SRC} = 125kHz$ )	off	off	on	off	off

## 4 Operational Procedures

After connecting supply voltage, the module is **NOT** in normal operating mode.  
To get the module into normal operating mode (polling mode):

- Connect supply voltage (12V) and GND
- Pull the data line to GND for a short time (>5ms)

## 5 Certification

### USA

This device complies with Part 15 of the FCC Rules. Operation is subject to the following two conditions: (1) this device may not cause harmful interference, and (2) this device must accept any interference received, including interference that may cause undesired operation.