

Emissions Test Report

EUT Name: TransAir PTC-3006

Model No.: PTC-3006

CFR 47 Part 80, 90 and RSS-119:2011

Prepared for:

Lilee Systems, Ltd.
2905 Stender Way, Suite 78
Santa Clara, CA 95054 U.S.A.
Tel: (408) 988-8672

Prepared by:

TUV Rheinland of North America, Inc.
1279 Quarry Lane, Ste. A
Pleasanton, CA 94566
Tel: (925) 249-9123
Fax: (925) 249-9124
<http://www.tuv.com/>

Report/Issue Date: November 26, 2012
Report Number: 31260509.004

Statement of Compliance

Manufacturer: Lilee Systems, Ltd.
2905 Stender Way, Suite 78
Santa Clara, CA 95054 U.S.A.

Requester / Applicant: Lilee Systems, LTD

Name of Equipment: TransAir PTC-3006

Model No. PTC-3006

Type of Equipment: Intentional Radiator

Application of Regulations: CFR 47 Part 80, 90 and RSS-119:2011 Issue 11

Test Dates: February 28, 2012 to May 18, 2012 and August 1, 2012

Guidance Documents:

Emissions: ANSI/TIA-603-C:2004

Test Methods:

Emissions: ANSI/TIA-603-C:2004

The electromagnetic compatibility test and documented data described in this report has been performed and recorded by TUV Rheinland, in accordance with the standards and procedures listed herein. As the responsible authorized agent of the EMC laboratory, I hereby declare that the equipment described above has been shown to be compliant with the EMC requirements of the stated regulations and standards based on these results. If any special accessories and/or modifications were required for compliance, they are listed in the Executive Summary of this report.

This report must not be used to claim product endorsement by A2LA or any agency of the U.S. Government. This report contains data that are not covered by A2LA accreditation. This report shall not be reproduced except in full, without the written authorization of TUV Rheinland of North America.



Suresh Kondapalli November 25, 2012
Test Engineer Date

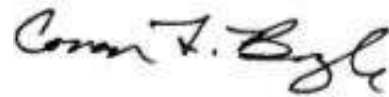

Conan Boyle November 26, 2012
A2LA Signatory Date



Testing Cert #3331.02



US5254



2932M-1

1	Executive Summary	6
1.1	Scope	6
1.2	Purpose	6
1.3	Summary of Test Results	6
1.4	Special Accessories	9
1.5	Equipment Modifications	9
2	Laboratory Information	10
2.1	Accreditations & Endorsements	10
2.1.1	US Federal Communications Commission	10
2.1.2	A2LA	10
2.1.3	Canada – Industry Canada	10
2.1.4	Japan – VCCI	10
2.1.5	Acceptance by Mutual Recognition Arrangement	11
2.2	Test Facilities	11
2.2.1	Emission Test Facility	11
2.2.2	Immunity Test Facility	11
2.3	Measurement Uncertainty	12
2.3.1	Sample Calculation – radiated & conducted emissions	12
2.3.2	Measurement Uncertainty	12
2.4	Calibration Traceability	13
3	Product Information	14
3.1	Product Description	14
3.2	Equipment Configuration	14
3.3	Operating Mode	14
3.4	Duty Cycle:	14
3.5	Unique Antenna Connector	15
3.5.1	Results	15
4	Emission Requirements – 216 to 222 MHz Band	16
4.1	Output Power Requirements	16
4.1.1	Test Method	16
4.1.2	Results	17
4.2	Occupied Bandwidth	49
4.2.1	Test Method	49
4.2.2	Results	50
4.3	Spectral Mask requirements	69
4.4	Conducted Spurious Emissions	89
4.4.1	Test Method	89
4.4.2	Results	90

Index of Tables

4.4.3	Out of band emissions receive mode	125
4.5	Transmitter Spurious Emissions	127
4.5.1	Test Methodology	127
4.5.2	Transmitter Spurious Emission Limit	128
4.5.3	Test Results	128
4.6	Receiver Spurious Emissions	150
4.6.1	Test Methodology	150
4.6.2	Receiver Spurious Emission Limit	151
4.6.3	Test Results	151
4.6.4	Sample Calculation	154
4.7	Normal operation/ Simulataneous opearion of Transmitters	155
4.8	Frequency Stability	157
4.8.1	Test Methodology	157
4.8.2	Test results	158
5	Test Equipment Use List	166
5.1	Equipment List	166
6	EMC Test Plan	167
6.1	EMC Test Plan	167
6.1.1	Introduction	167
6.1.2	Customer	167
6.1.3	Equipment Under Test (EUT)	168
6.1.4	Test Specifications	173

Index of Tables

Table 1: Summary of Test Results 6

Table 2: RF Output Power at the Antenna Port – Test Results 17

Table 3: Occupied Bandwidth – Test Results 50

Table 4: Spectral Mask Requirements – Test Results 70

Table 5: Out of band Conducted Emission – Test Results 90

Table 6: Frequency Stability – Test Results Fixed Mode 158

Table 7: Frequency Stability – Test Results Fixed Mode 159

Table 8: Frequency Stability – Test Results Mobile station mode 160

Table 9: Frequency Stability – Test Results mobile Station mode 161

Table 10: Customer Information 167

Table 11: Technical Contact Information 167

Table 12: EUT Specifications 168

Table 13: EUT Channel Power Specifications 169

Table 14: Interface Specifications: 172

Table 15: Supported Equipment : 172

Table 16: Description of Sample used for Testing 172

Table 17: Description of Test Configuration used for Radiated Measurement. 172

Table 18: Test Specifications 173

1 Executive Summary

1.1 Scope

This report is intended to document the status of conformance with the requirements of the CFR 47 Part 80, 90 and RSS-119:2011 based on the results of testing performed from February 28 to May 18 and Aug 01, 2012 on the TransAir PTC-3006 Model PTC-3006 manufactured by *Lilee Systems, LTD*. This report only applies to the specific samples tested under the stated test conditions. It is the responsibility of the manufacturer to assure that additional production units of this model are manufactured with identical or EMI equivalent electrical and mechanical components. This report is further intended to document changes and modifications to the EUT throughout its life cycle. All documentation will be included as a supplement.

1.2 Purpose

Testing was performed to evaluate the EMC performance of the EUT in accordance with the applicable requirements, procedures, and criteria defined in the application of regulations and application of standards listed in this report.

1.3 Summary of Test Results

Table 1: Summary of Test Results

Transmitter Modulation, output power and other parameters

Test	FCC Rule Part	RSS Rule Part	Measured value/ Comments	Limit/Requirement	Result
Frequency ranges (Listed for each channel spacing)	2.1033(C) (5) 80.45, 90.35	RSS-119	25 kHz, 216-222 MHz 12.5 kHz, 216-222 MHz 50 kHz, 216-222 MHz ¹	216-222 MHz ³	Complied
Power	2.1033(C) (6) 2.1033(C) (7) 2.1046 80.215 90.205	RSS-119 5.4.1 SRSP 512	28.2 Watts (44.51 dBm) for mobile application ² Fixed station: Maximum conducted power is 35.15 Watts (45.46 dBm) ² . Actual power will be determined at the time installation. Power at antenna port will always less than 35.15Watts Lowest power 0.5 Watts	30 Watts (mobile) ³ 216 to 220 MHz RSS-119 50Watts (mile) FCC Part 80.215 50 Watts 220 to 222 MHz SRSP 512 110 Watts (Fixed) 216 to 220 MHz RSS-119 5.4.1 125 Watts 220-222 MHz SRSP 512 Table 6.1 and 90.205	Complied
Emission Mask	2.1033(C) (4) 2.1047 80.211(f) 90.210	RSS-119 5.5 table 5	Device Complies with spectral masks – see test data	Masks C & F (FCC) Masks F & J(IC)	Complied
Occupied (99%) Bandwidth	2.1049	RSS-119 5.5 table 3	8.94 kHz 216- 220 MHz 10.13 kHz 216-220 MHz 23.29 kHz 216-220 MHz 9 kHz 220-222 MHz 10.08 kHz 220-222 MHz 16.76 kHz 220-222 MHz	50/25/12.5/6.25 kHz FCC Part 90 11.25 kHz and 4 kHz for RSS-119*	Complied

¹ Aggregate of 5 channels; * Authorized BW for single channel

² Power is variable actual power is chosen at the time installation depending on cable losses, ant height, gain and terrain as per FCC/ IC licensing procedures. Transmitter output power for fixed stations is factory set max limit at 45.5 dBm (35.15watts). The EIRP calculation is based on max gain antenna of 14.1dBi and cable loss of 9.2 dB. The equipment design prevents higher power by lockout/error message. Transmitter output power for mobile stations is factory set max limit at 44.5 dBm(28.2 Watts). The EIRP calculation is based on max gain antenna of 5.2 dBi and cable loss of 2.8 dB. The equipment design prevents higher power by lockout/error message. The minimum power of the device is 0.5 watts for both modes. ³ Lower of the FCC part 90 and RSS-199 limits was considered; RSS-119 limits operation to 217-218 and 219-222 MHz.

Transmitter spurious emissions

Test	FCC Rule Part	RSS Rule Part	Measured value/ Comments	Limit/Requirement	Result
Transmitter spurious					
At Antenna Terminal	2.1051	RSS-119 5.8	-26.77dBm	-25 dBm	Complied
Radiated (erp)	2.1057 80.211(f)				
Receiver spurious					
At Antenna terminal	15.111	RSS-GEN	-70.09 dBm	-57 dBm	Complied
Field Strength	15.109	RSS-GEN	36.64 dBuV/m at 65 MHz	Refer Section 4.6.3 of the report	Complied

§ Calculated from measured field strength using free space propagation equation.

€ EUT is Class A device, at 10 meters

Other parameters

Test	FCC Rule Part	RSS Rule Part	Measured value/ Comments	Limit/Requirement	Result
Frequency Stability	2.1055 90.213(a)	RSS-119 5.3 Table 1	0.7 ppm (Mobile configuration) 0.099 ppm (Base Station Configuration)	216-220 MHz 1.5 ppm 220-222 MHz 0.1 ppm	Complied
RF Exposure	1.1307 (b) 2.1093 80.227	RSS-102	RF Exposure is addressed at time of licensing. MPE calculation is provided here.		
DC voltage and current for final amplifier stage	15.107	RSS-GEN	12 Vdc, 6 Amps	Information only	--

1.4 Special Accessories

No special accessories were necessary in order to achieve compliance.

1.5 Equipment Modifications

None

2 Laboratory Information

2.1 Accreditations & Endorsements

2.1.1 US Federal Communications Commission



TUV Rheinland of North America at 1279 Quarry Ln, Pleasanton, CA 94566 is recognized by the commission for performing testing services for the general public on a fee basis. These laboratory test facilities have been fully described in reports submitted to and accepted by the FCC (US5254). The laboratory scope of accreditation includes: Title 47 CFR Parts 15, 18, and 90. The accreditation is updated every 3 years.

2.1.2 A2LA



TUV Rheinland of North America is accredited by the A2LA Laboratory Accreditation Program. The laboratory has been assessed and accredited in accordance with ISO Guide 17025:2005 and ISO 9002 (Testing Cert #3331.02). The scope of laboratory accreditation includes emission and immunity testing. The accreditation is updated annually.

2.1.3 Canada – Industry Canada



TUV Rheinland of North America at the 1279 Quarry Ln, Pleasanton, CA 94566 address is accredited by Industry Canada for performing testing services for the general public on a fee basis. This laboratory test facilities have been fully described in reports submitted to and accepted by Industry Canada (File Number 2932M-1). This reference number is the indication to the Industry Canada Certification Officers that the site meets the requirements of RSS 212, Issue 1 (Provisional). The accreditation is updated every 3 years.

2.1.4 Japan – VCCI



The Voluntary Control Council for Interference by Information Technology Equipment (VCCI) is a group that consists of Information Technology Equipment (ITE) manufacturers and EMC test laboratories. The purpose of the Council is to take voluntary control measures against electromagnetic interference from Information Technology Equipment, and thereby contribute to the development of a socially beneficial and responsible state of affairs in the realm of Information Technology Equipment in Japan. TUV Rheinland of North America at 1279 Quarry Ln, Pleasanton, CA 94566 has been assessed and approved in accordance with the Regulations for Voluntary Control Measures. (Registration Nos. A-0031& A-0032).

2.1.5 Acceptance by Mutual Recognition Arrangement



The United States has an established agreement with specific countries under the Asia Pacific Laboratory Accreditation Corporation (APLAC) Mutual Recognition Arrangement. Under this agreement, all TUV Rheinland at 1279 Quarry Ln, Pleasanton, CA 94566 test results and test reports within the scope of the laboratory NIST / A2LA accreditation will be accepted by each member country.

2.2 Test Facilities

All of the test facilities are located at 1279 Quarry Lane, Pleasanton, California 94566, USA. The 2305 Mission College, Santa Clara, 95054, USA location is considered a Pleasanton Annex.

2.2.1 Emission Test Facility

The Semi-Anechoic chamber and AC Line Conducted measurement facility used to collect the radiated and conducted data has been constructed in accordance with ANSI C63.7:1992. The site has been measured in accordance with and verified to comply with the theoretical normalized site attenuation requirements of ANSI C63.4-2009, at a test distance of 3 and 5 meters. The site is listed with the FCC and accredited by A2LA (Testing Cert #3331.02). The 3/5-meter semi-anechoic chamber used to collect the radiated data has been verified to comply with the theoretical normalized site attenuation requirements of ANSI C63.4-2009, at a test distance of 3 meter and 5 meters. A report detailing this site can be obtained from TUV Rheinland of North America.

2.2.2 Immunity Test Facility

ESD, EFT, Surge, PQF: These tests are performed in an environmentally controlled room with a 3.7 m x 4.8 m x 3.175 mm thick aluminum floor connected to PE ground.

For ESD testing, tabletop equipment is placed on an insulated mat with a surface resistivity of 10^9 Ohms/square on a 1.6 m x 0.8 m x 0.8 m high non-conductive table with a 3.175 mm aluminum top (Horizontal Coupling Plane). The HCP is connected to the main ground plane via a low impedance ground strap through two 470-k Ω resistors. The Vertical Coupling Plane consists of an aluminum plate 50 cm x 50 cm x 3.175 mm thick. The VCP is connected to the main ground plane via a low impedance ground strap through two 470-k Ω resistors.

For EFT, Surge, PQF, the HCP and VCP are removed.

RF Field Immunity testing is performed in a 7.3m x 4.3m x 4.1m anechoic chamber.

RF Conducted and Magnetic Field Immunity testing is performed on a 4.8m x 3.7m x 3.175mm thick aluminum ground plane.

All test areas allow a minimum distance of 1 meter from the EUT to walls or conducting objects.

2.3 Measurement Uncertainty

Two types of measurement uncertainty are expressed in this report, per *ISO Guide To The Expression Of Uncertainty In Measurement*, 1st Edition, 1995.

The Combined Standard Uncertainty is the standard uncertainty of the result of a measurement when that result is obtained from the values of a number of other quantities; it is equal to the positive square root of the sum of the variances or co-variances of these other quantities, weighted according to how the measurement result varies with changes in these quantities. The term *standard uncertainty* is the result of a measurement expressed as a standard deviation.

2.3.1 Sample Calculation – radiated & conducted emissions

The field strength is calculated by subtracting the Amplifier Gain and adding the Cable Loss and Antenna Correction Factor to the measured reading. The basic equation is as follows:

$$\text{Field Strength (dB}\mu\text{V/m)} = \text{RAW} - \text{AMP} + \text{CBL} + \text{ACF}$$

Where: RAW = Measured level before correction (dB μ V)

AMP = Amplifier Gain (dB)

CBL = Cable Loss (dB)

ACF = Antenna Correction Factor (dB/m)

$$\mu\text{V/m} = 10^{\frac{\text{dB}\mu\text{V/m}}{20}}$$

Sample radiated emissions calculation @ 30 MHz

Measurement +Antenna Factor–Amplifier Gain+Cable loss=Radiated Emissions (dBuV/m)

$$25 \text{ dBuV/m} + 17.5 \text{ dB} - 20 \text{ dB} + 1.0 \text{ dB} = 23.5 \text{ dBuV/m}$$

2.3.2 Measurement Uncertainty

	U_{lab}	U_{cispr}
Radiated Disturbance		
30 MHz – 40,000 MHz	3.2 dB	5.2 dB
Conducted Disturbance @ Mains Terminals		
150 kHz – 30 MHz	2.4 dB	3.6 dB
Disturbance Power		
30 MHz – 300 MHz	3.92 dB	4.5 dB

Measurement Uncertainty – Immunity Testing

The estimated combined standard uncertainty for ESD immunity measurements is $\pm 4.1\%$.
The estimated combined standard uncertainty for radiated immunity measurements is ± 2.7 dB.
The estimated combined standard uncertainty for conducted immunity measurements is ± 1.4 dB.
The estimated combined standard uncertainty for damped oscillatory wave immunity measurements is $\pm 8.8\%$.
The estimated combined standard uncertainty for harmonic current and flicker measurements is $\pm 0.45\%$.

Measurement Uncertainty – Radio Testing

The estimated combined standard uncertainty for frequency error measurements is ± 3.88 Hz
The estimated combined standard uncertainty for carrier power measurements is ± 1.59 dB.
The estimated combined standard uncertainty for adjacent channel power measurements is ± 1.47 dB.
The estimated combined standard uncertainty for modulation frequency response measurements is ± 0.46 dB.
The estimated combined standard uncertainty for transmitter conducted emission measurements is ± 4.01 dB

The expanded uncertainty at a level of 95% confidence is obtained by multiplying the combined standard uncertainty by a coverage factor of 2. Compliance criteria are not based on measurement uncertainty.

2.4 Calibration Traceability

All measurement instrumentation is traceable to the National Institute of Standards and Technology (NIST). Measurement method complies with ANSI/NCSL Z540-1-1994 and ISO Standard 17025:2005. Equipment calibration records are kept on file at the test facility.

3 Product Information

3.1 Product Description

PTC-3006 is Tranceiver unit of Lilee systems and part of TransAir PTC-3000 product family products. The Lilee Systems TransAir PTC-3000 product family includes three components: TransAir Wayside, TransAir Base Station and TransAir Locomotive radios. The TransAir PTC product family's design is based on both ACSES and an interoperable train control (ITC) architecture that in conjunction with the Lilee Mobility Controller (LMC-5x00 series) enables seamless roaming and constant communication between central traffic control, wayside signals, and onboard locomotive networks. This combined solution can help freight railroads and transit operators maintain compliance with the Federal Rail Safety Improvement Act of 2008.

3.2 Equipment Configuration

A description of the equipment configuration is given in the Test Plan Section. The EUT was tested as called for in the test standard and was configured and operated in a manner consistent with its intended use. The EUT was connected to rated power and allowed to reach intended operating conditions. The placement of the EUT system components was guided by the test standard and selected to represent typical installation conditions.

In the case of EUT that can operate in more than one configuration, preliminary testing was performed to determine the configuration that produced maximum radiation.

The final configuration was selected to produce the worst case radiation for emissions testing and to place the EUT in the most susceptible state for immunity testing.

3.3 Operating Mode

A description of the operation mode is given in the Test Plan Section. For EUT that can operate in more than one state, preliminary testing was performed to determine the operating mode that produced maximum radiation.

The final operating mode was selected to produce the worst case radiation for emissions testing and to place the EUT in the most susceptible state for immunity testing.

3.4 Duty Cycle:

EUT was operated at 100% duty cycle. No duty cycle correction was added to the results.

3.5 Unique Antenna Connector

An intentional radiator shall be designed to ensure that no antenna other than that furnished by the responsible party shall be used with the device. The use of a permanently attached antenna or of an antenna that uses a unique coupling to the intentional radiator shall be considered sufficient to comply with the provisions of this Section. The manufacturer may design the unit so that a broken antenna can be replaced by the user, but the use of a standard antenna jack or electrical connector is prohibited. This requirement does not apply to carrier current devices or to devices operated under the provisions of CFR47 Parts 15.211, 15.213, 15.217, 15.219, or 15.221.

3.5.1 Results

PTC-3006, radio unit is professionally installed. This requirement is not applicable.

4 Emission Requirements – 216 to 222 MHz Band

Testing was performed in accordance with CFR 47 Part 80, 90 and RSS 119, FCC part 15. These test methods are listed under the laboratory's A2LA Scope of Accreditation. This test measures the levels emanating from the EUT, thus evaluating the potential for the EUT to cause radio frequency interference to other electronic devices. Procedures described in section 8 of the standard were used.

4.1 Output Power Requirements

The maximum output power requirement is the maximum equivalent isotropic radiated power delivering at the transmitting antenna under specified conditions of measurements in the presence of modulation.

The maximum output power and harmonics shall not exceed CFR47 Part 80, 90 and RSS-119

4.1.1 Test Method

The conducted method was used to measure the power output according to ANSI/TIA-603-C: 2004. The measurement was performed with modulation per ANSI/TIA-603-C: 2004 was conducted on 3 channels in each operating range. The worst mode result indicated below.

Test Setup:

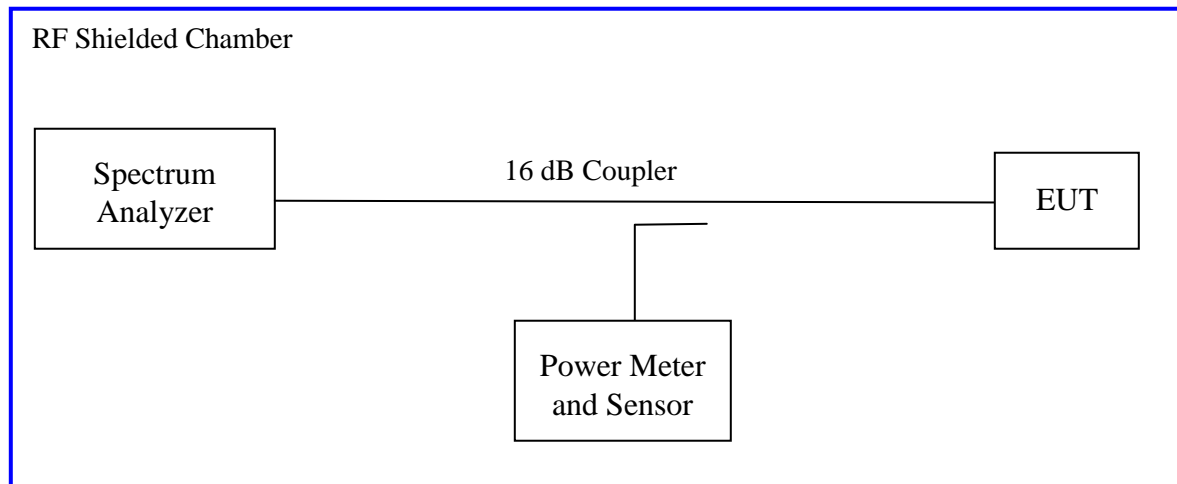

4.1.2 Results

As originally tested, the EUT was found to be compliant to the requirements of the test standard(s).

Table 2: RF Output Power at the Antenna Port – Test Results

Test Conditions: Conducted Measurement, Normal Temperature							
Antenna Type: Max Fixed Station gain 14.1 dBi Dual Yagi Antenna							
Signal State: Modulated see below							
Ambient Temp.: 21° C				Relative Humidity: 39%			
Freq.	Modulation	Power Setting	Measured power at Antenna Port		Limit Base Station Mode		Result
MHz			dBm	Watts	CFR Part 80/90	IC RSS-119	
216.00	GMSK 9600	ATT 0	44.88	30.76	50 W at antenna input terminal 80.215 (216 - 220 MHz)	110 W Para 5.4.1	Pass
	QPSK 16K	ATT 0	44.03	25.29			
	QPSK 32K	ATT 2	44.95	31.26			
217.500	GMSK 9600	ATT 0	45.45	35.05			
	QPSK 16K	ATT 0	45.44	34.99			
	QPSK 32K	ATT 2	45.46	35.15			
218.500	GMSK 9600	ATT 0	45.34	34.20			
	QPSK 16K	ATT 0	45.44	34.99			
	QPSK 32K	ATT 2	45.46	35.15			
219.500	GMSK 9600	ATT 0	45.04	31.91			
	QPSK 16K	ATT 0	43.84	24.21			
	QPSK 32K	ATT 5	45.27	33.65			
220.0125	GMSK 9600	ATT 0	44.51	28.24			
	QPSK 16K	ATT 2	44.41	28.24			
	QPSK 32K	ATT 15	39.93	9.84			
220.4875	GMSK 9600	ATT 0	44.58	28.70			
	QPSK 16K	ATT 2	44.46	27.92			

	QPSK 32K	ATT 15	40.08	10.18	110 W ERP 90.729 (220-222 MHz)	125 W ERP SRSP 512 (220-220 MHz)	Pass
220.9875	GMSK 9600	ATT 0	44.45	35.05			
	QPSK 16K	ATT 2	43.95	24.83			
	QPSK 32K	ATT 15	39.90	9.77			
222.00	GMSK 9600	ATT 0	45.11	32.43			
	QPSK 16K	ATT 2	44.47	27.99			
	QPSK 32K	ATT 15	40.50	11.22			

Note 1: The output power is adjusted at the time of installation, considering the cable losses and antenna gain

Note 2: Power measurements were performed as indicated in the above table. Only worst case/ limited number of plots are placed in the report.

Note 3: Frequency 220-221MHz is assigned to Fixed stations and 221 to 222 MHz is assigned to mobile stations

Note 4: RSS-119 limits operation to 217-218 and 219-222 MHz.

Note 5: Plots for 219.5 MHz are in Figures 24 to 28.

Mobile Mode

Test Conditions: Conducted Measurement, Normal Temperature							
Antenna Type: Highest gain for Mobile 5 dBi							
Signal State: Modulated							
Ambient Temp.: 21 °C				Relative Humidity: 39%			
Frequency	Modulation	Power setting	Measured Power at Antenna Port		ERP Limit		Result
			dBm	Watts	Mobile Mode		
MHz					CFR 47	RSS-119	
216.00	GMSK 9600	ATT 4	43.79	23.99	30W 216 to 220 MHz Part 80.215	30W Para 5.4.1	Pass
	QPSK 16K	ATT 0	44.03	25.29			
	QPSK 32K	ATT 7	44.45	27.86			
217.500	GMSK 9600	ATT 4	44.20	26.30			
	QPSK 16K	ATT 4	44.21	26.36			
	QPSK 32K	ATT 7	44.20	26.30			
218.500	GMSK 9600	ATT 4	44.20	26.30			
	QPSK 16K	ATT 4	44.40	27.54			
	QPSK 32K	ATT 7	44.40	27.54			
219.500	GMSK 9600	ATT1	44.26	26.66			
	QPSK 16K	ATT0	43.84	24.21			
	QPSK 32K	ATT5	44.27	26.73			
220.0125	GMSK 9600	ATT 0	44.51	28.24	50 W ERP Part 90.729 (220-222 MHz)	50W SRSP512 Para 6.3.1.4 (220-222 MHz)	
	QPSK 16K	ATT 2	44.41	27.60			
	QPSK 32K	ATT 15	39.93	9.84			
220.4875	GMSK 9600	ATT 0	44.51	28.24			
	QPSK 16K	ATT 2	43.46	22.18			
	QPSK 32K	ATT 15	40.18	10.42			

220.9875	GMSK 9600	ATT 0	44.45	35.05			Pass
	QPSK 16K	ATT 2	43.95	24.83			
	QPSK 32K	ATT 15	39.90	9.77			
222.00	GMSK 9600	ATT 4	44.40	27.54			
	QPSK 16K	ATT 2	44.47	27.99			
	QPSK 32K	ATT 15	40.50	11.22			

Note1: Maximum conducted power limited to 44.5 dBm (28.2 Watts) Output power is adjusted at the time installation based antenna gain and cable losses. The minimum power of the device is 0.5 Watts

Note2: Power measurements were performed as indicated in the above table. Only worst case/ limited number of plots are placed in the report.

Note3: Frequency 220-221MHz is assigned to fixed stations and 221 to 222 MHz is assigned to mobile stations

Note4: RSS-119 limits operation to 217-218 and 219-222 MHz.

Note5: Power levels for Base and mobile stations are the same for 219.5 MHz at 16 QPSK modulation

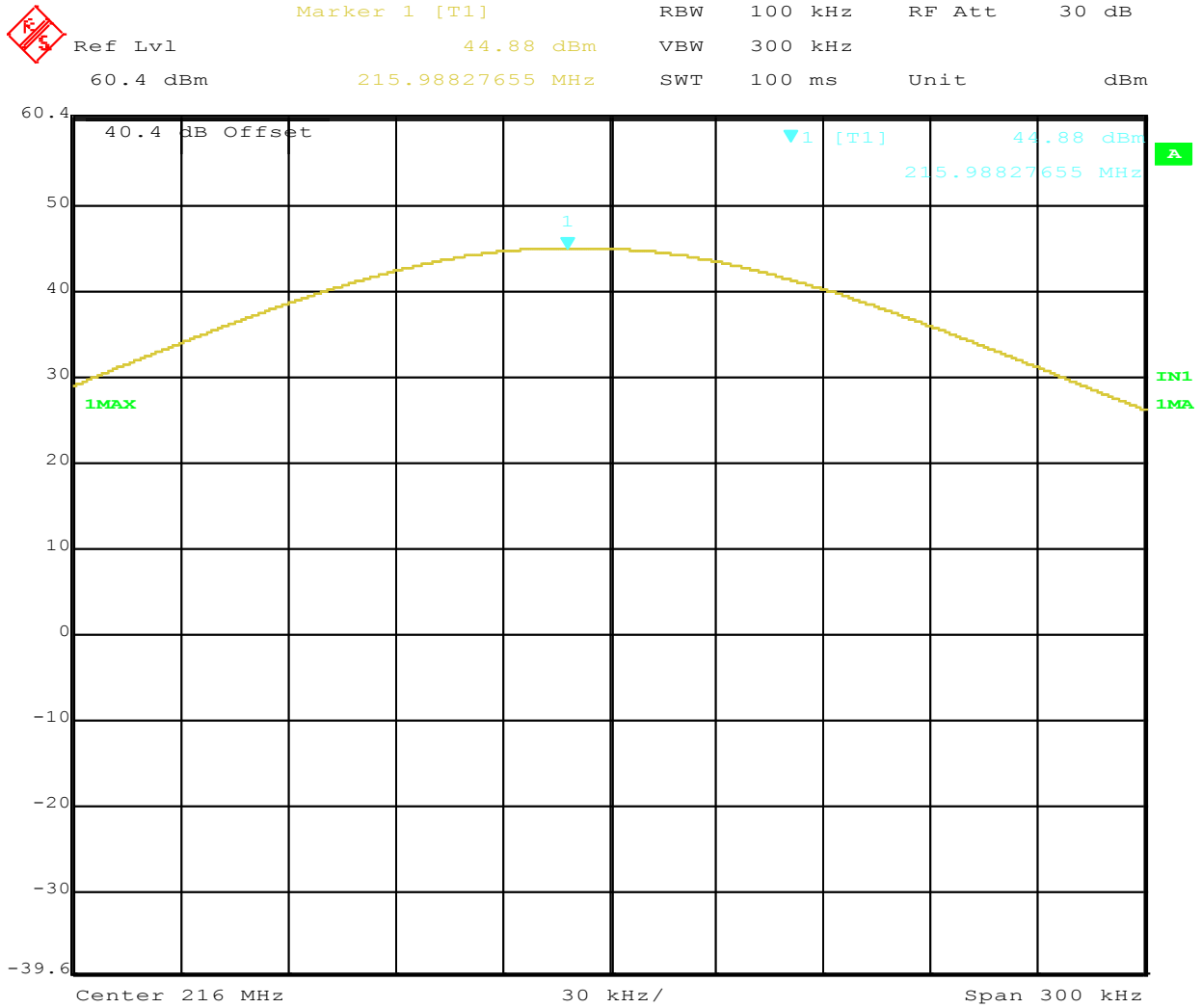

Date: 18.MAY.2012 16:28:12

Figure 1: Maximum Transmitted Power, 216.0 MHz at GMSK 9600

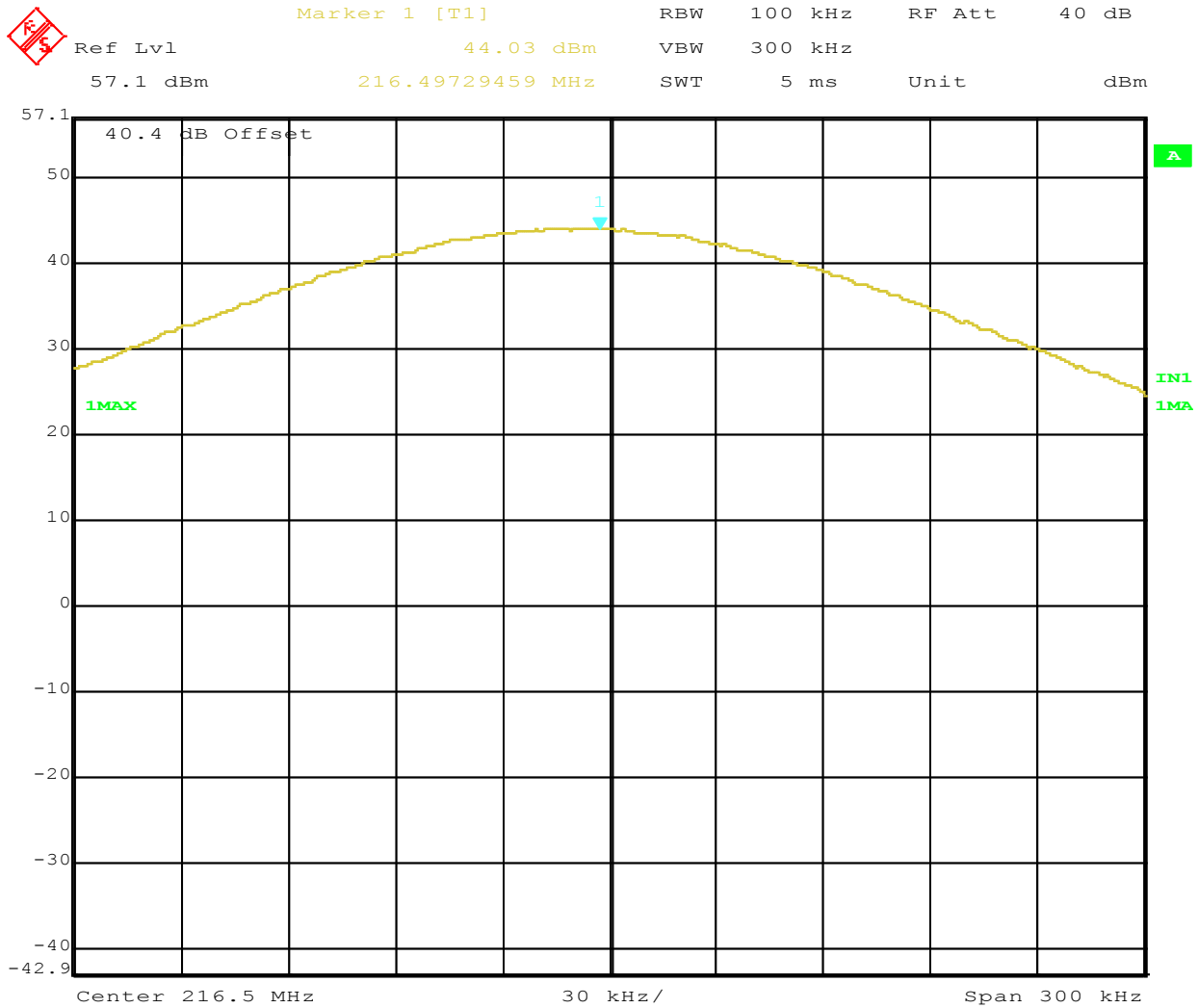

Date: 18.MAY.2012 15:35:25

Figure 2: Maximum Transmitted Power, 216 MHz at 16 QPSK

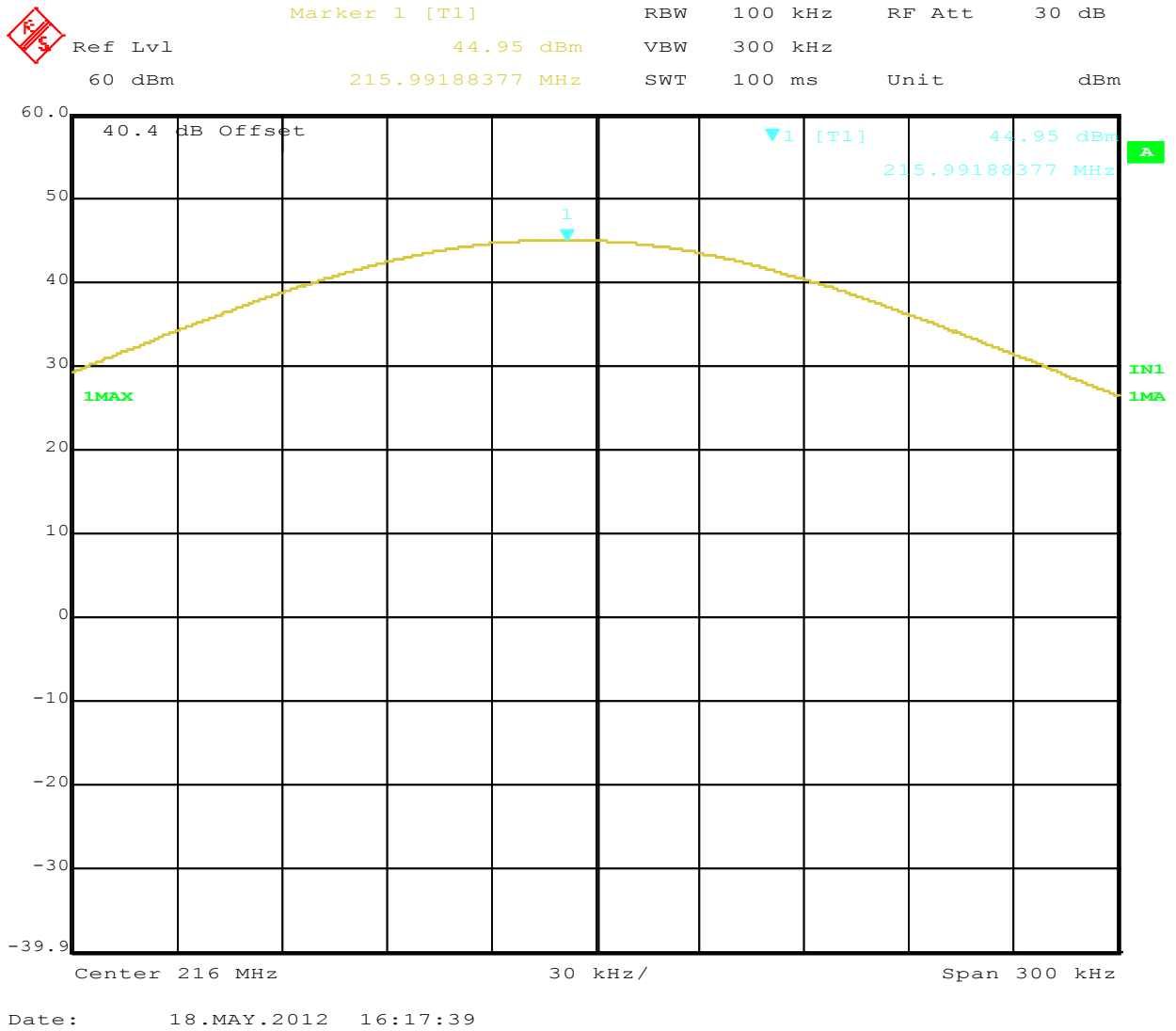
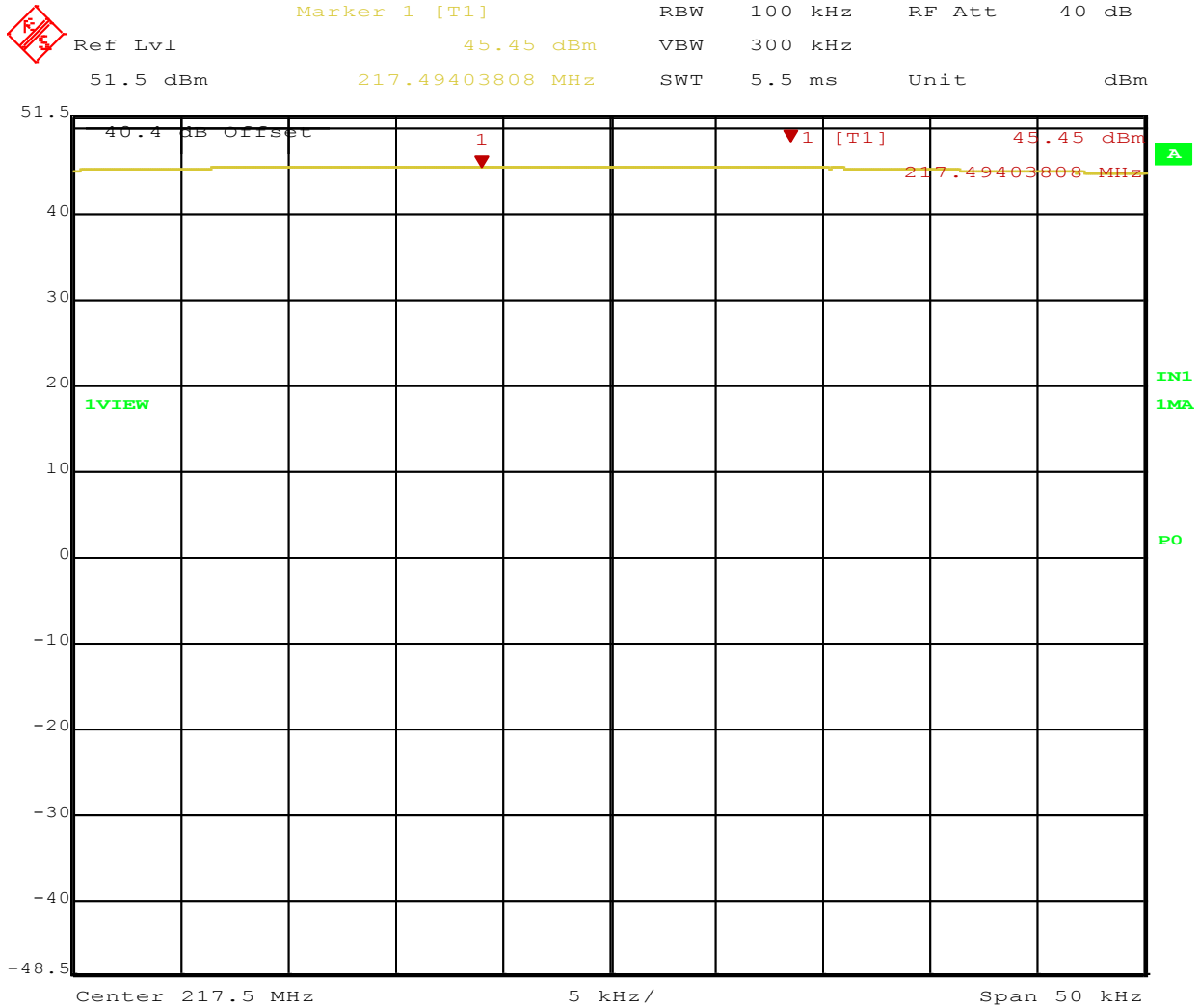
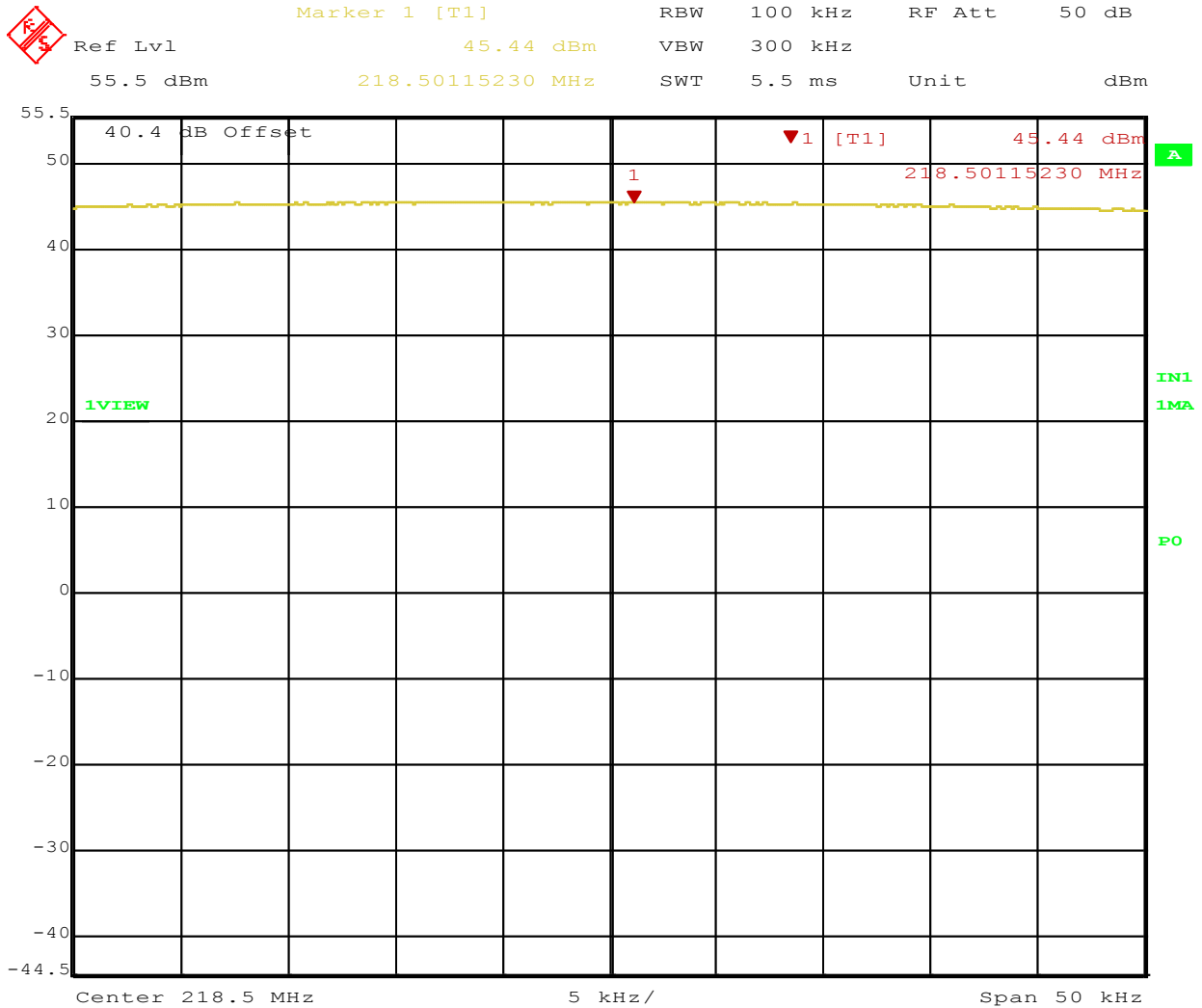

Figure 3: Maximum Transmitted Power, 216 MHz at 32 QPSK



Title: Power217.5 GMSK9600 Powersetting full power
 Date: 29.FEB.2012 13:50:59

Figure 4: Maximum Transmitted Power, 217.5 MHz at GMSK 9600



Title: Power 218.5 QPSK 16K Powersetting full power
 Date: 29.FEB.2012 16:22:42

Figure 5: Maximum Transmitted Power, 217.5 MHz at 16 QPSK

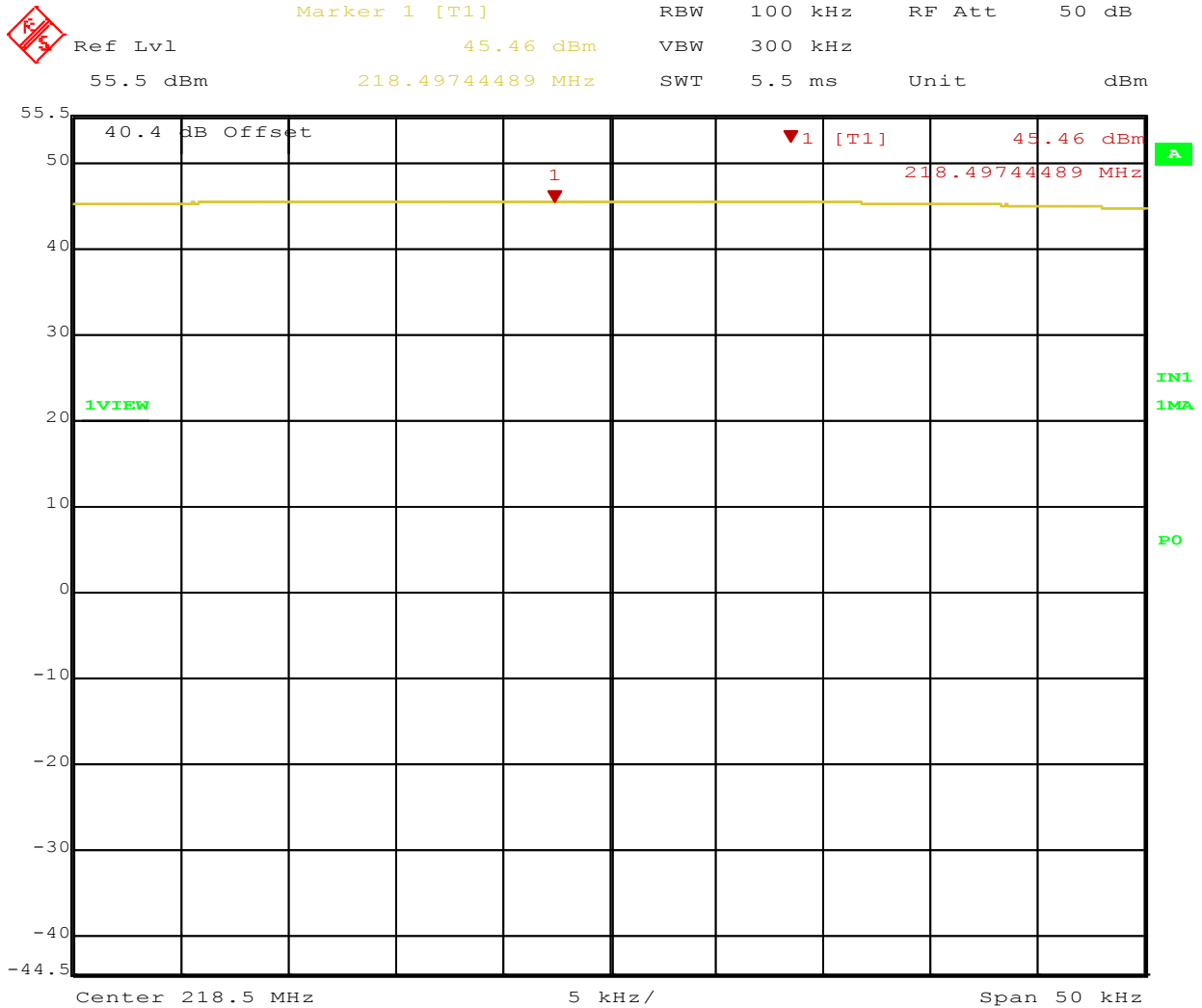

Title: Power FCC Mask 80.11 218.5 QPSK 32k Powersetting att 2
 Date: 29.FEB.2012 17:30:56

Figure 6: Maximum Transmitted Power, 217.5 MHz at 32 QPSK

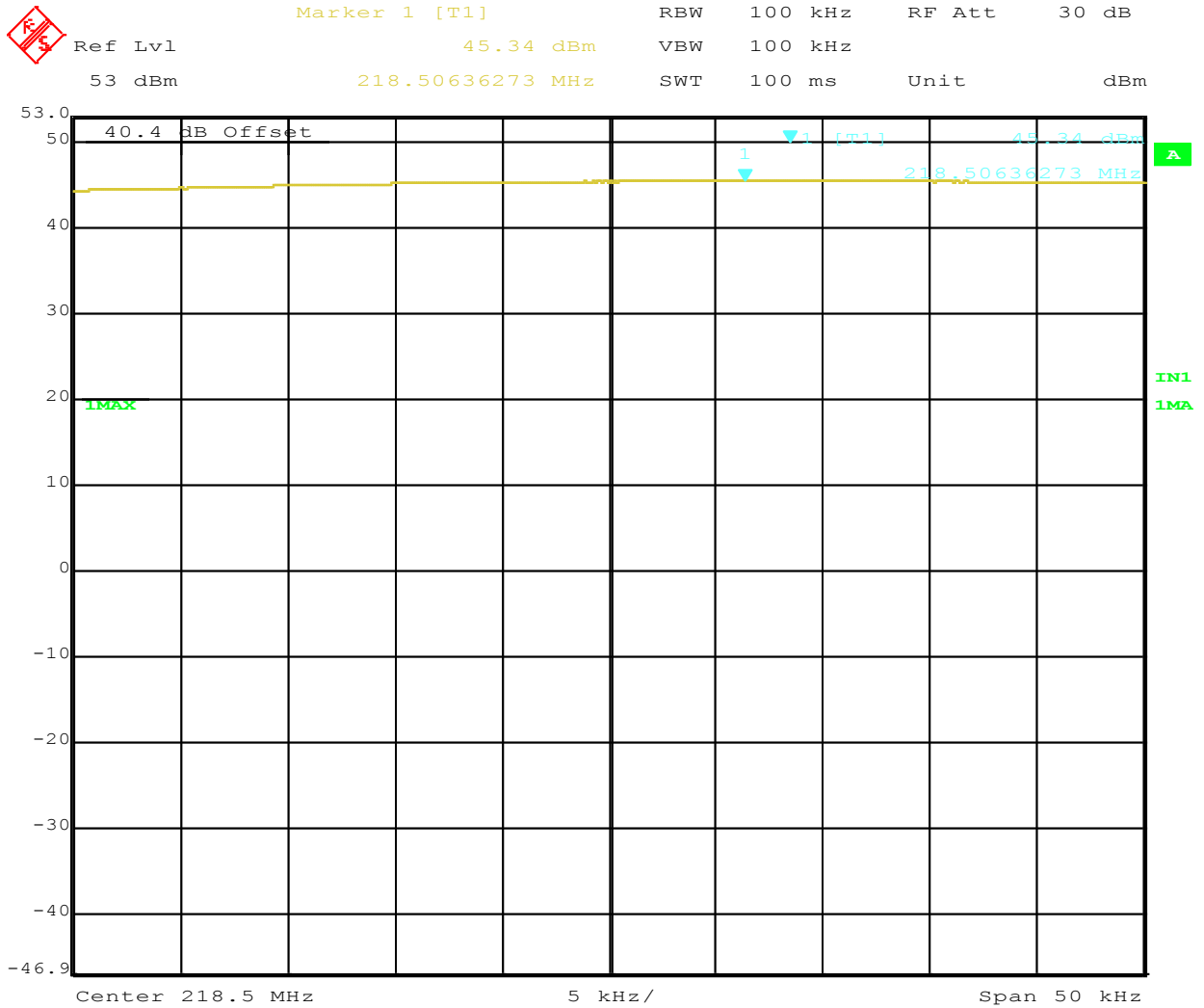
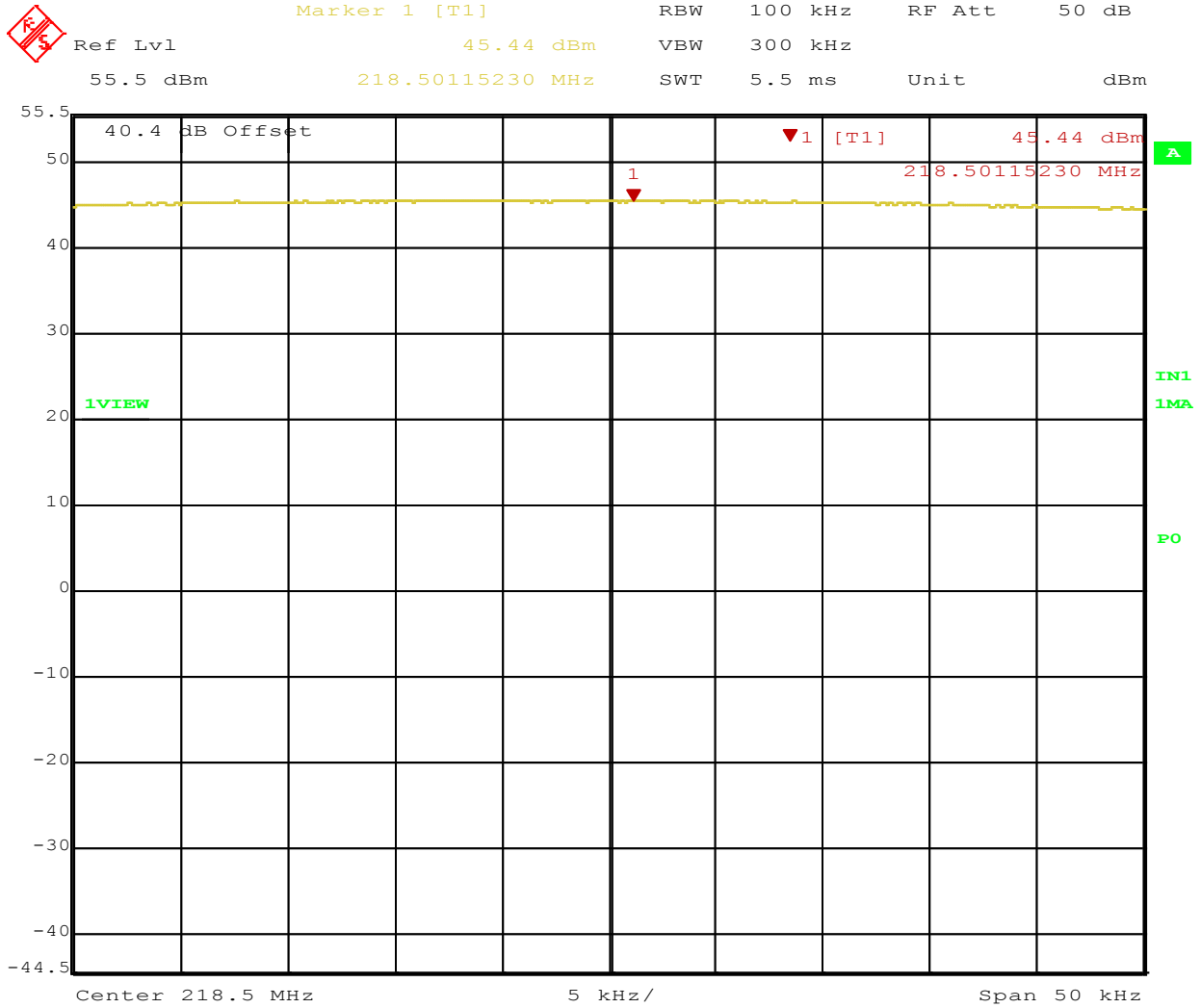
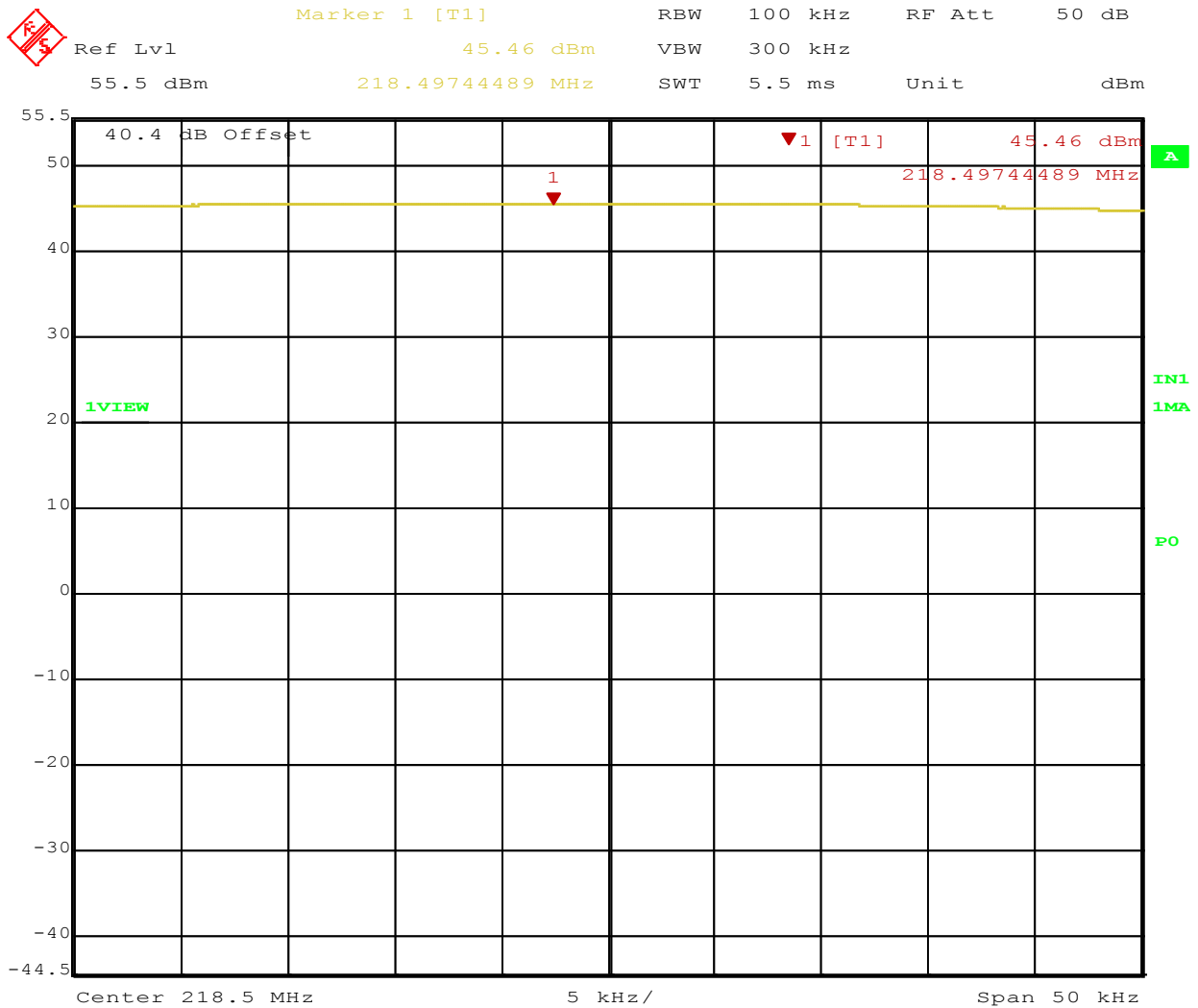

Figure 7: Maximum Transmitted Power, 218.5 MHz at GMSK



Title: Power 218.5 QPSK 16K Powersetting full power
 Date: 29.FEB.2012 16:22:42

Figure 8: Maximum Transmitted Power, 218.5 MHz at 16 QPSK



Title: Power FCC Mask 80.11 218.5 QPSK 32k Powersetting att 2
 Date: 29.FEB.2012 17:30:56

Figure 9: Maximum Transmitted Power, 218.5 MHz at 32 QPSK

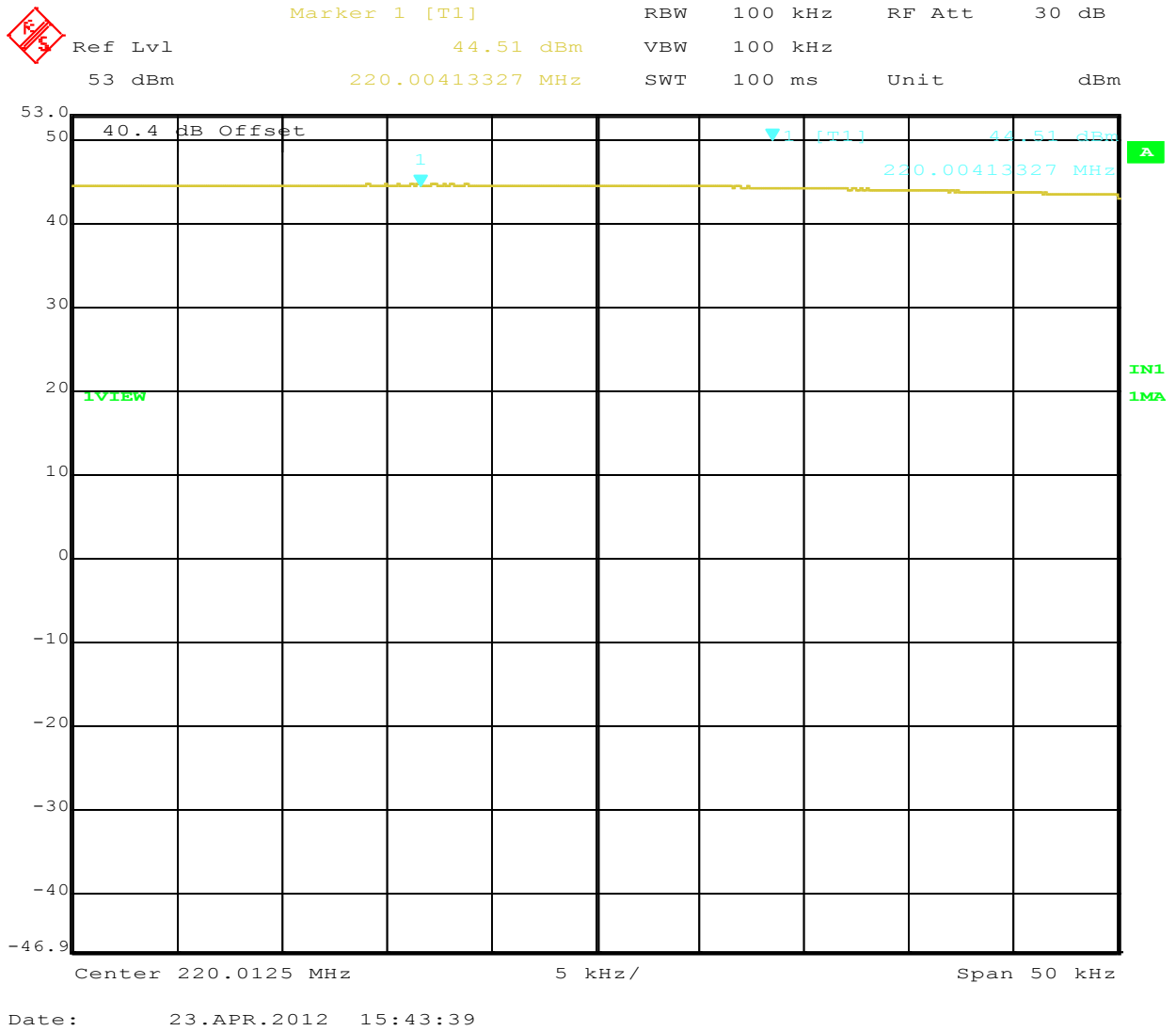

Figure 10: Maximum Transmitted Power, 220.0125 MHz at GMSK

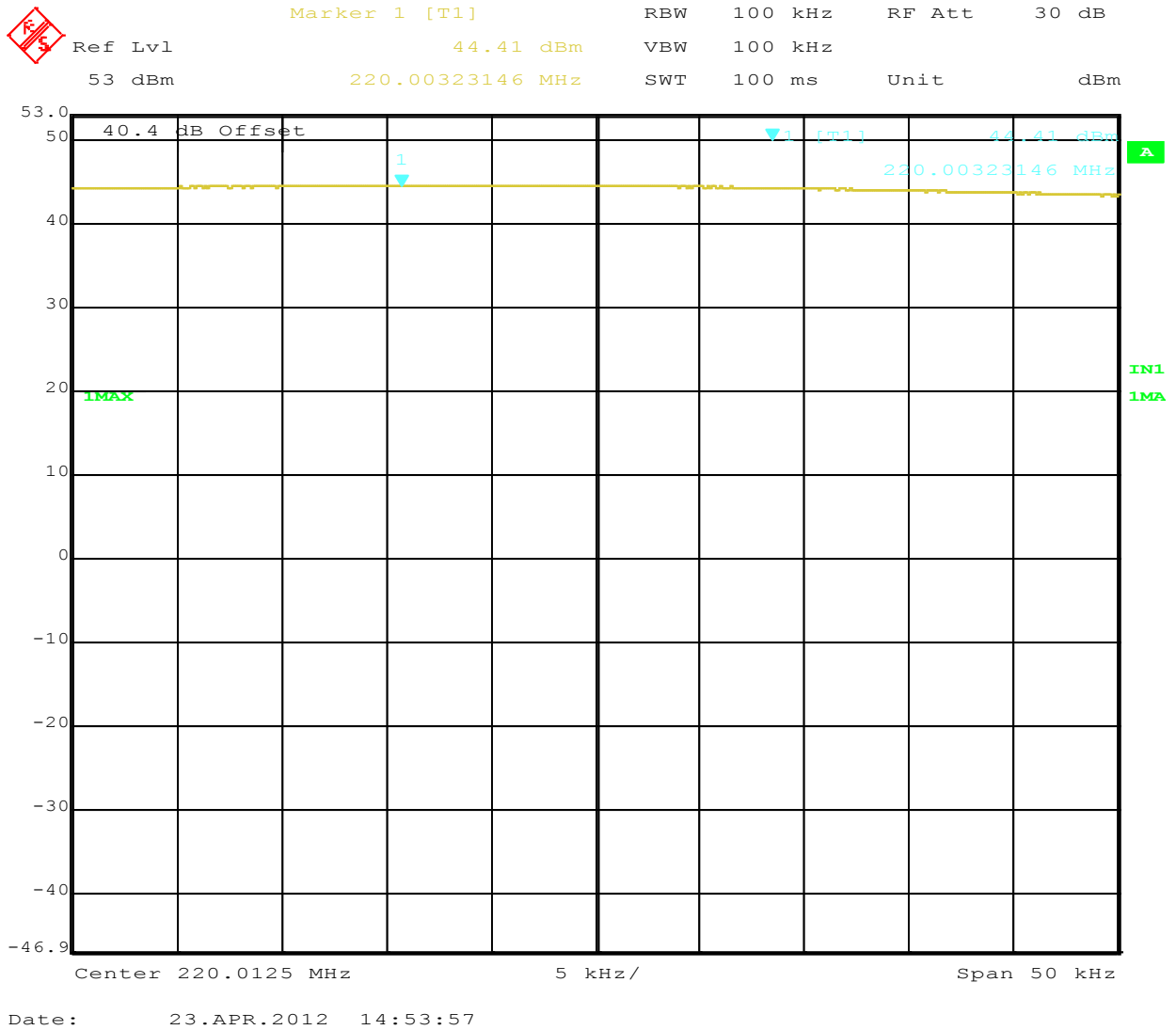

Figure 11: Maximum Transmitted Power, 220.0125 MHz at 16 QPSK

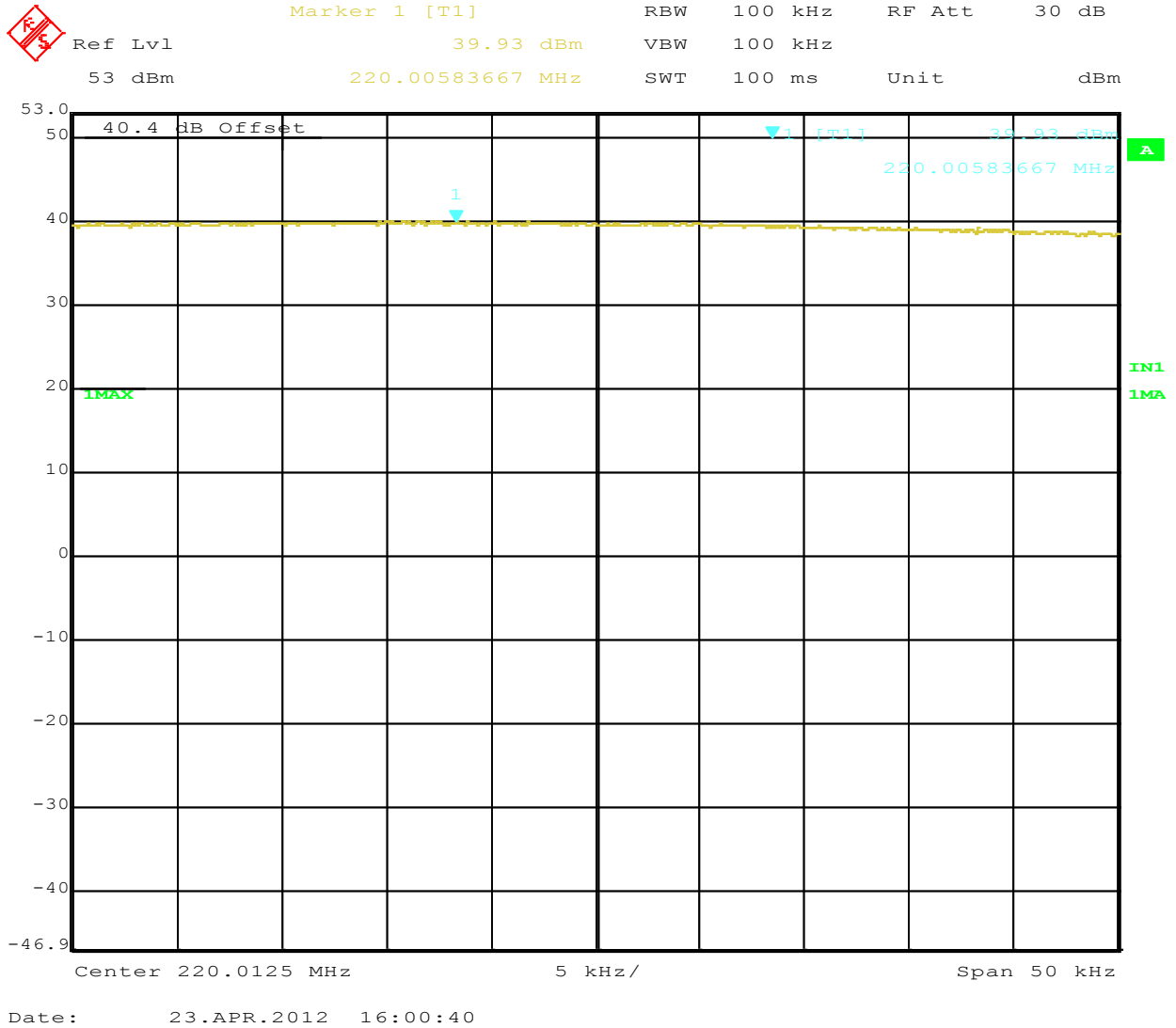

Figure 12: Maximum Transmitted Power, 220.0125 MHz at 32 QPSK

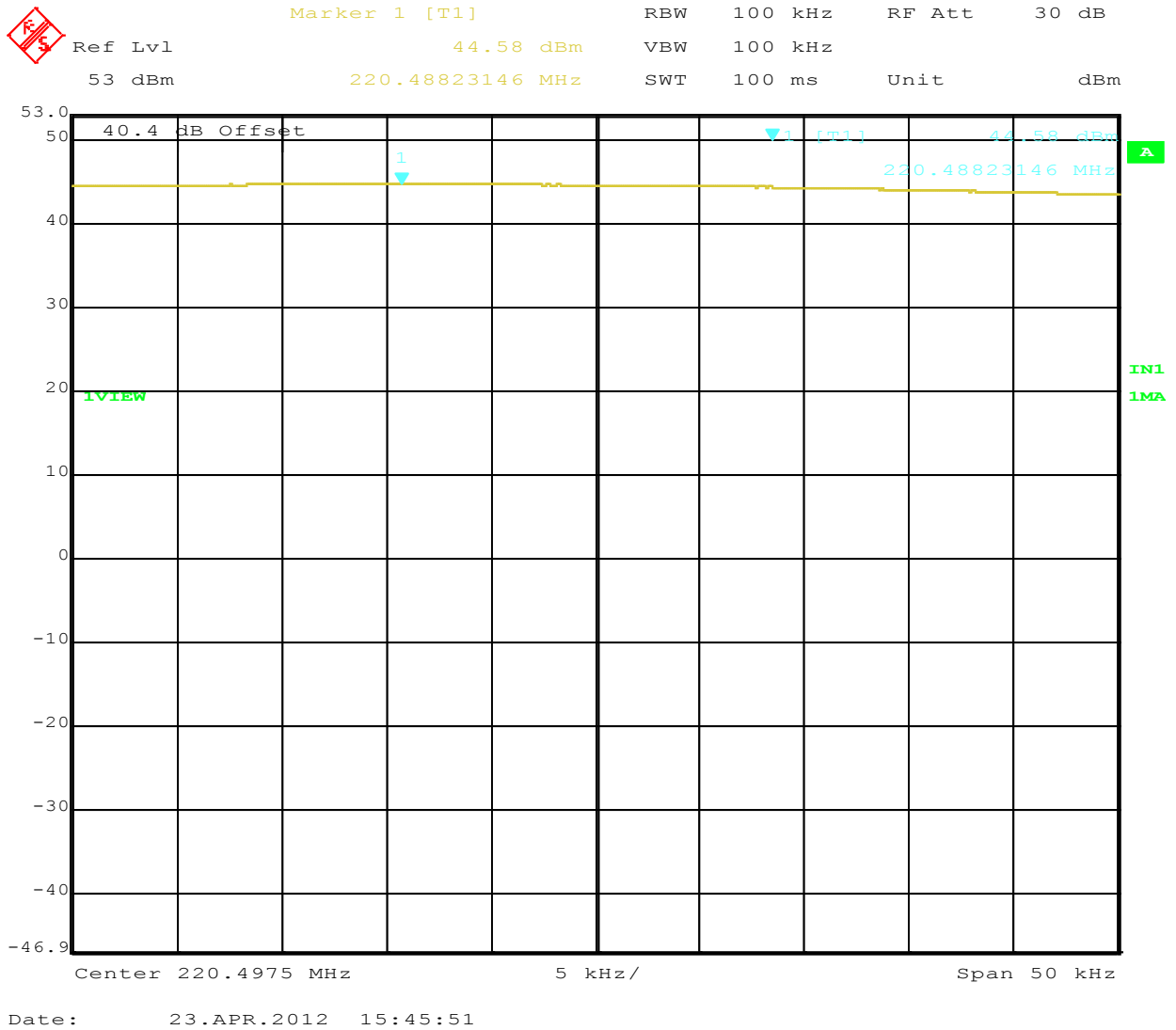

Figure 13: Maximum Transmitted Power, 220.4875 MHz at GMSK

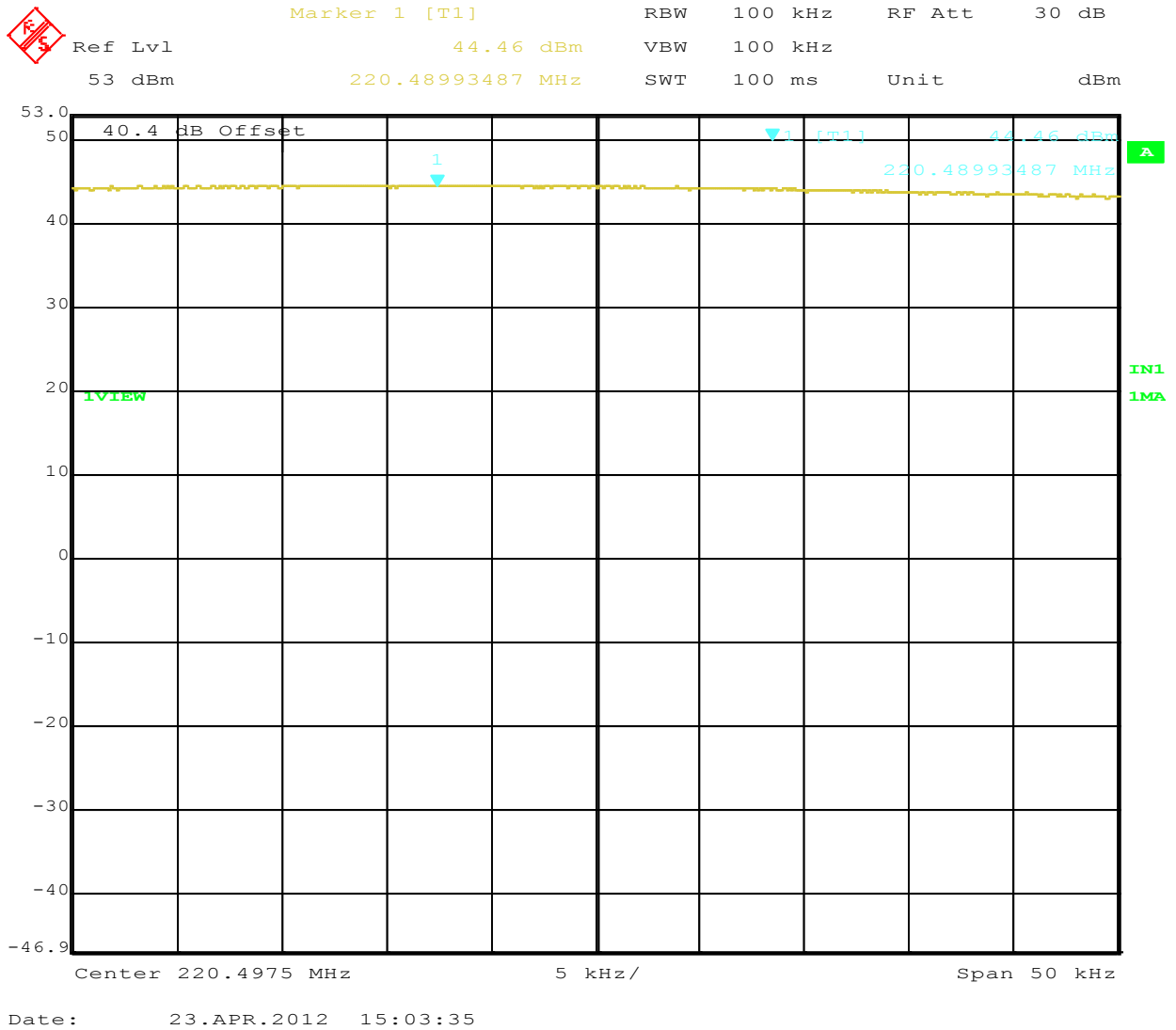

Figure 14: Maximum Transmitted Power, 220.4875 MHz at 16 QPSK

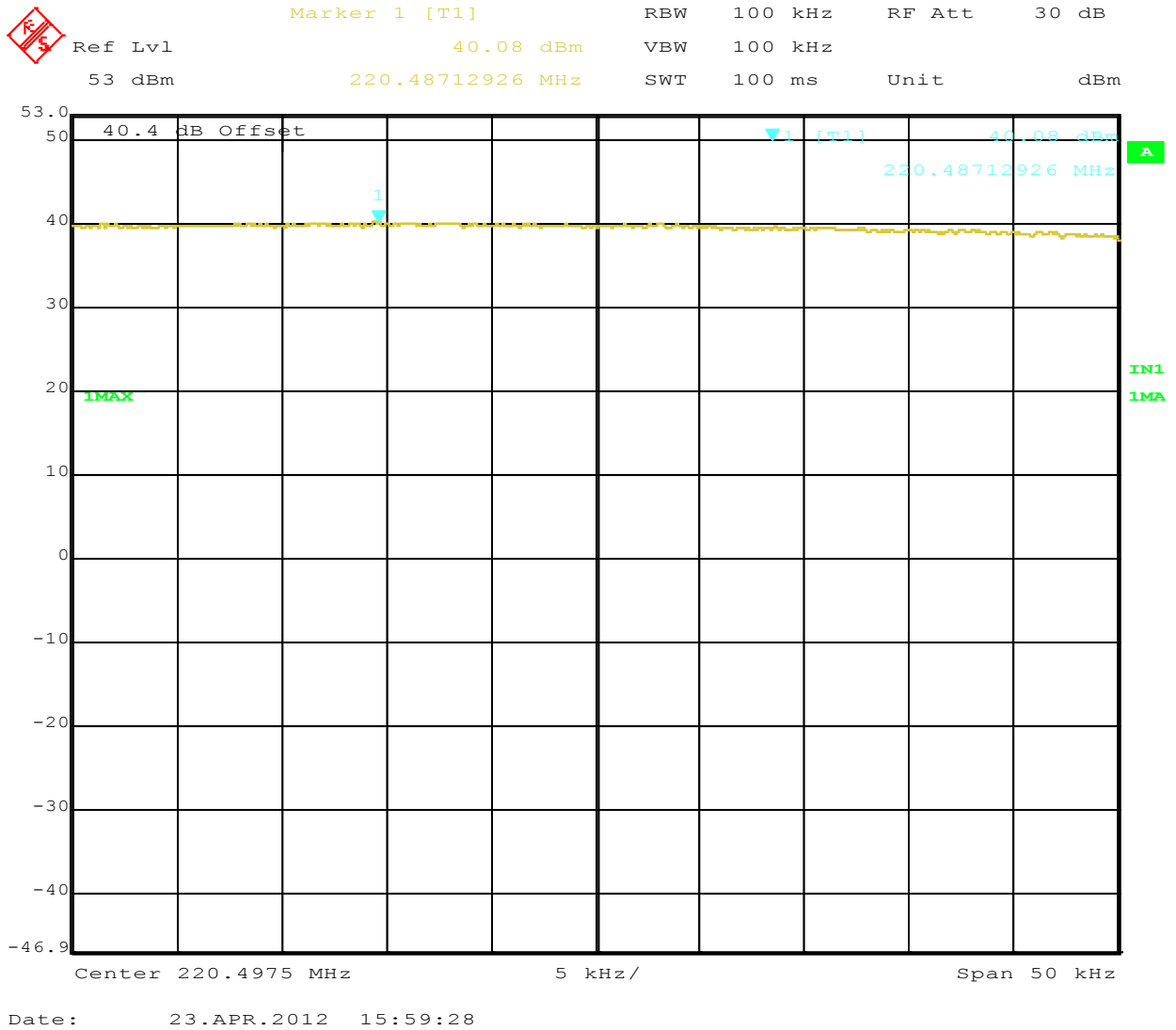

Figure 15: Maximum Transmitted Power, 220.4875 MHz at 32 QPSK

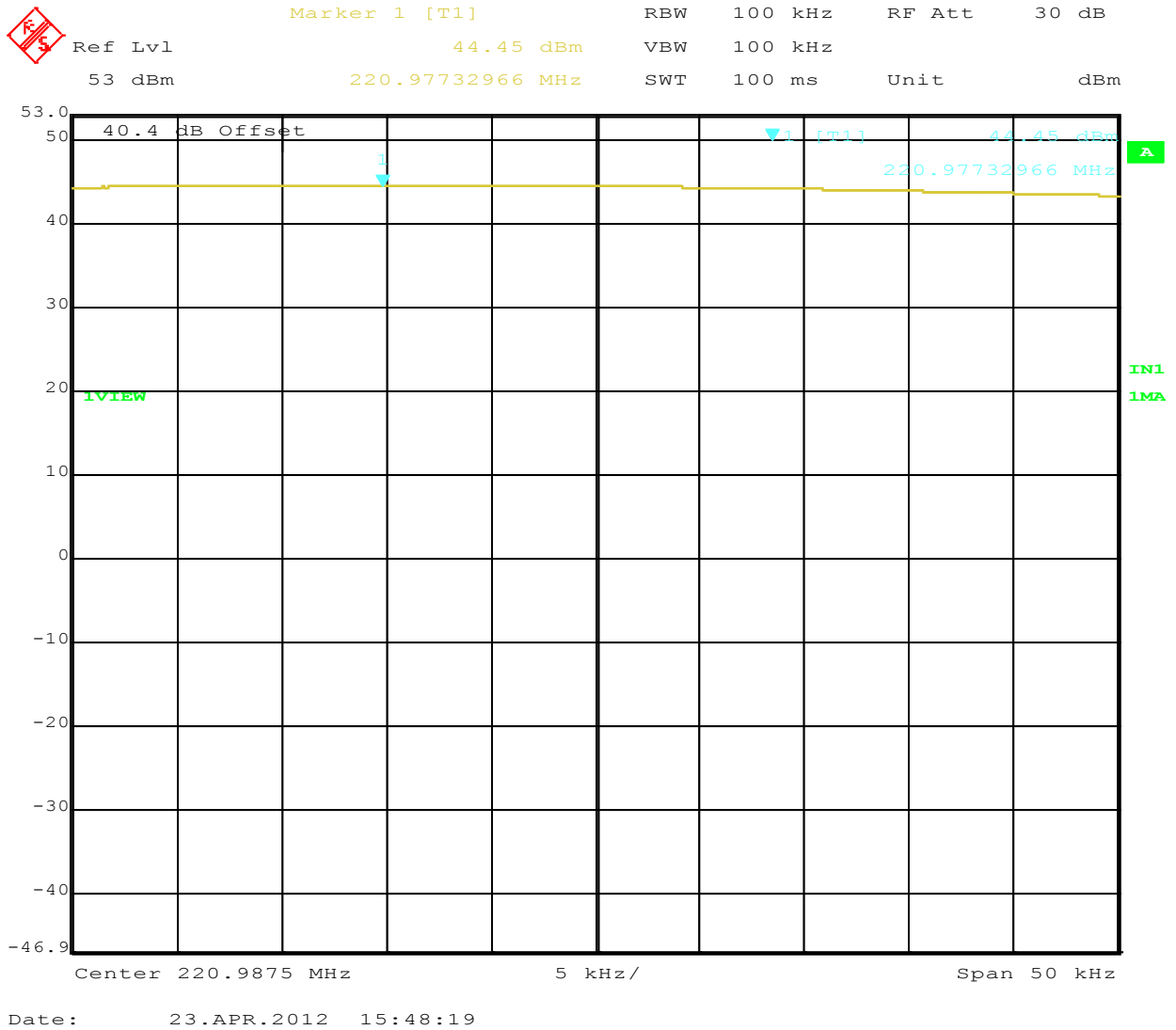

Figure 16: Maximum Transmitted Power, 220.9875 MHz at GMSK

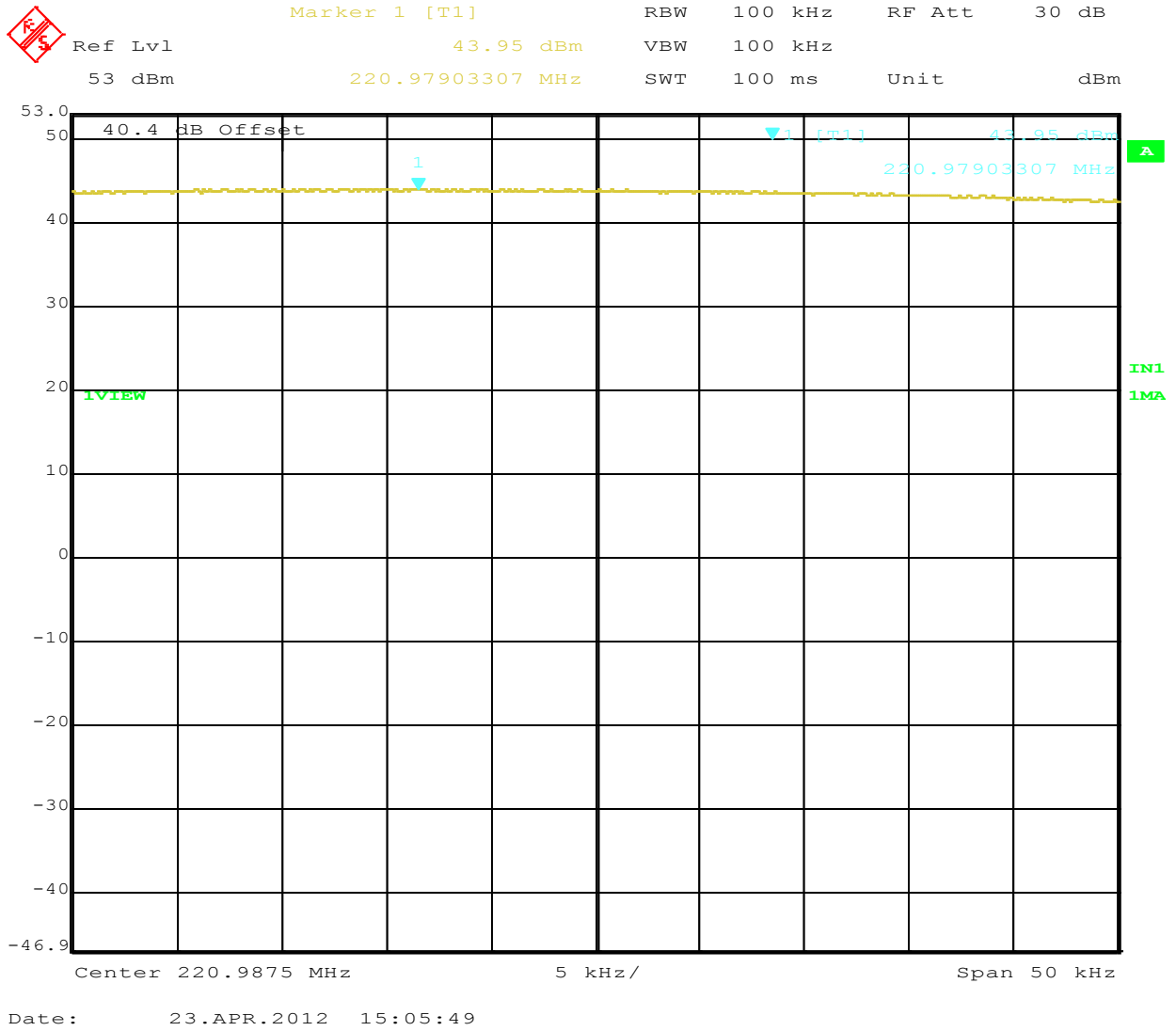

Figure 17: Maximum Transmitted Power, 220.9875 MHz at 16 QPSK

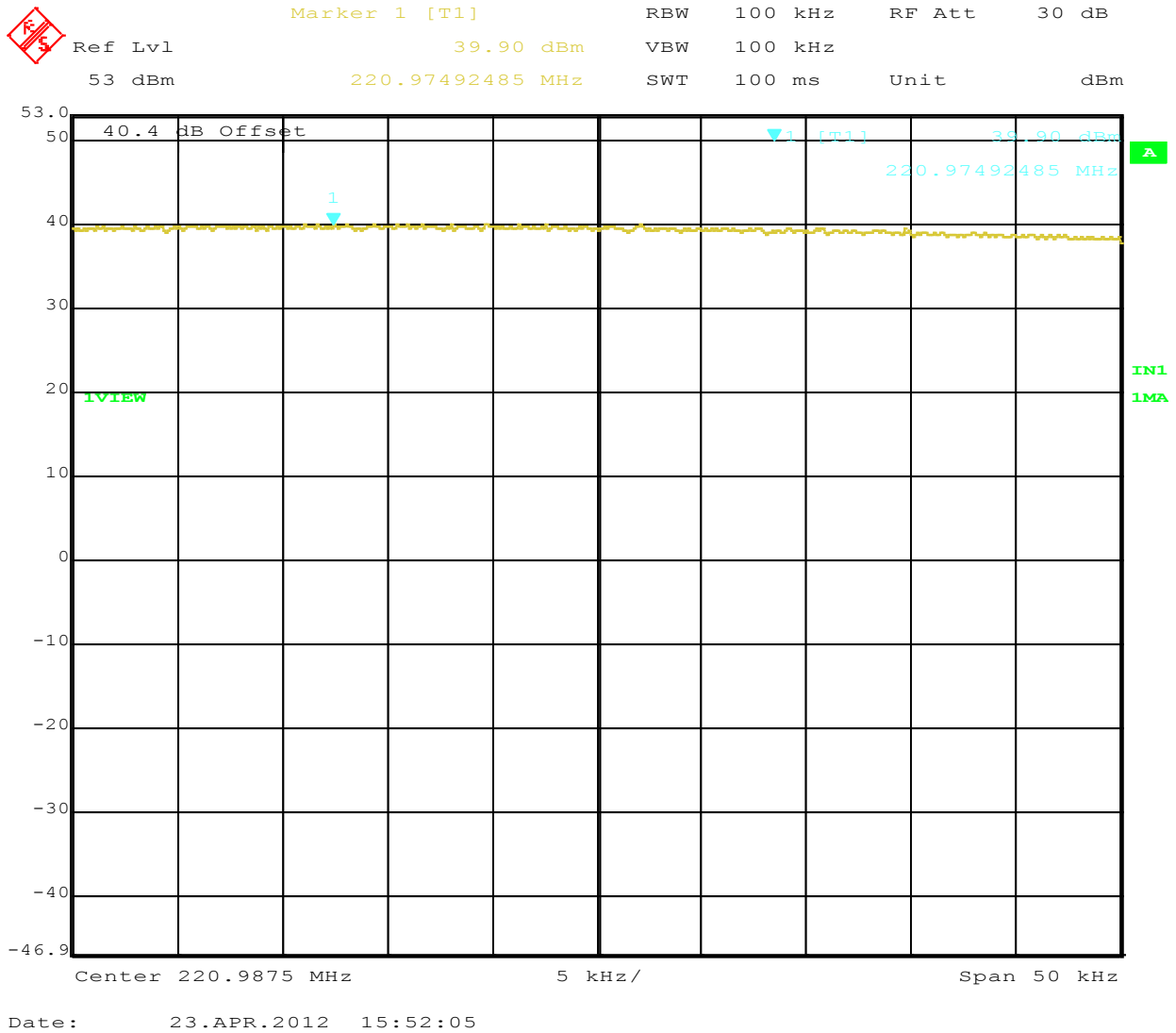

Figure 18: Maximum Transmitted Power, 220.9875 MHz at 32 QPSK

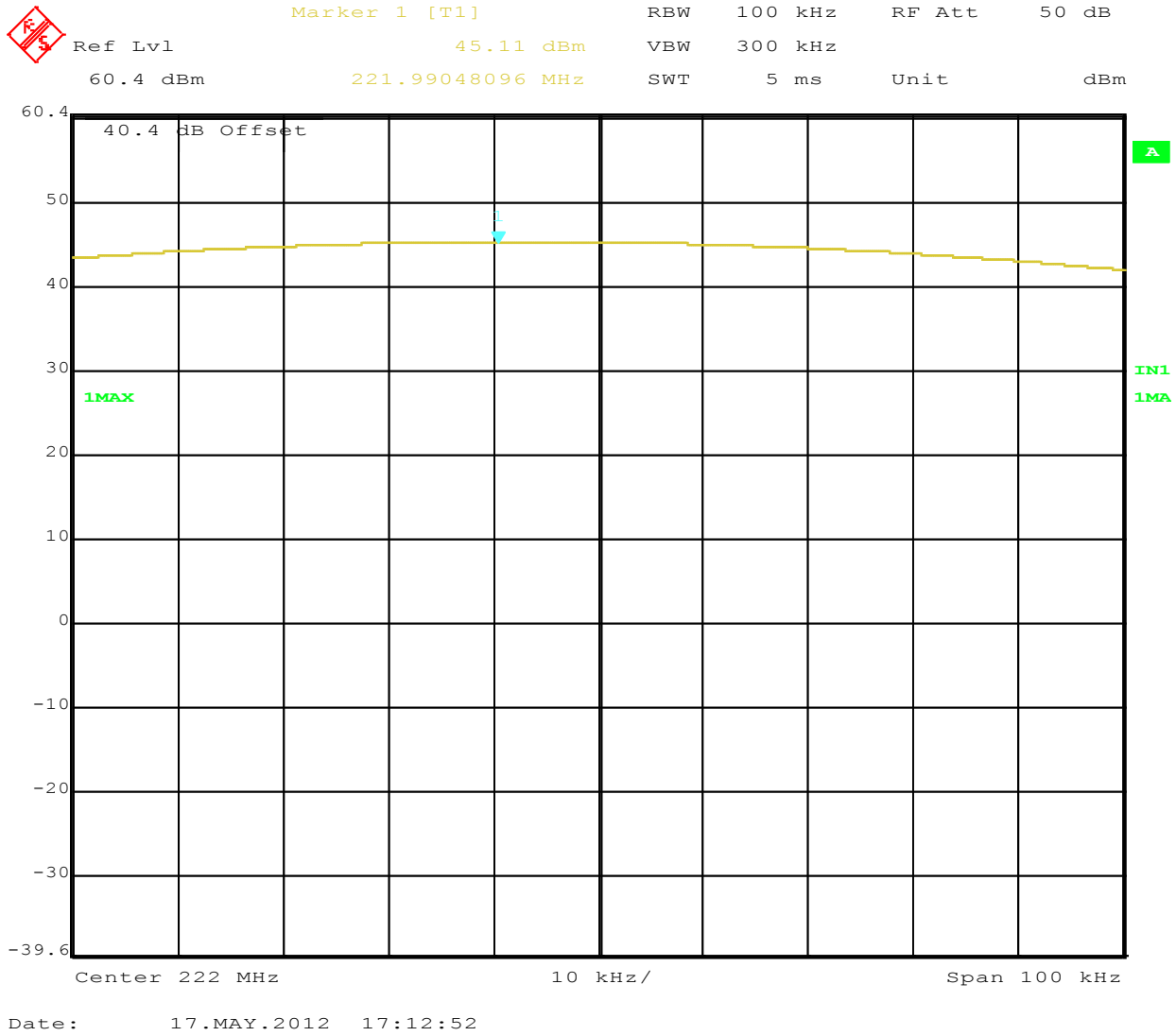

Figure 19: Maximum Transmitted Power, 222 MHz at GMSK

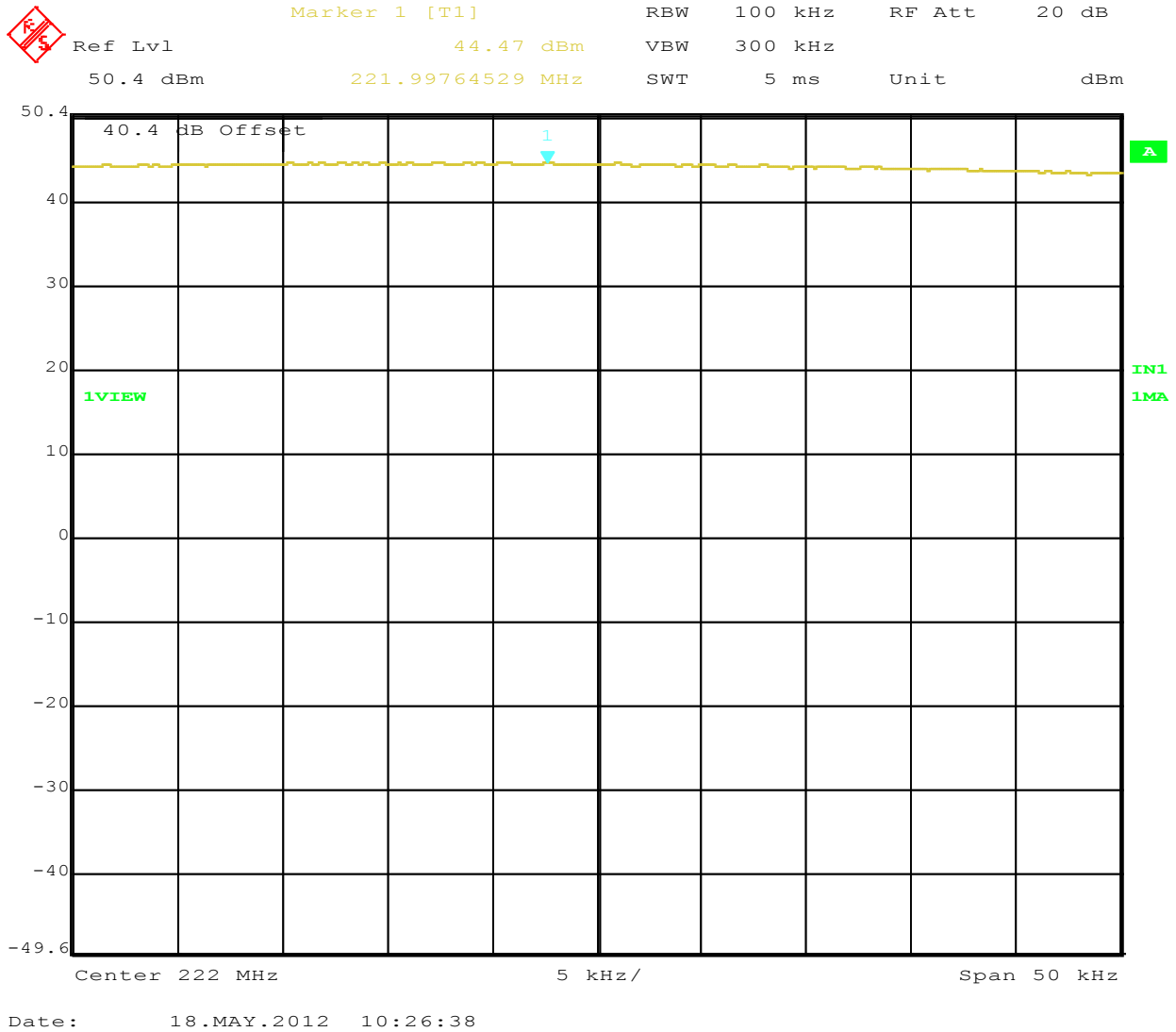

Figure 20: Maximum Transmitted Power, 222 MHz at 16 QPSK

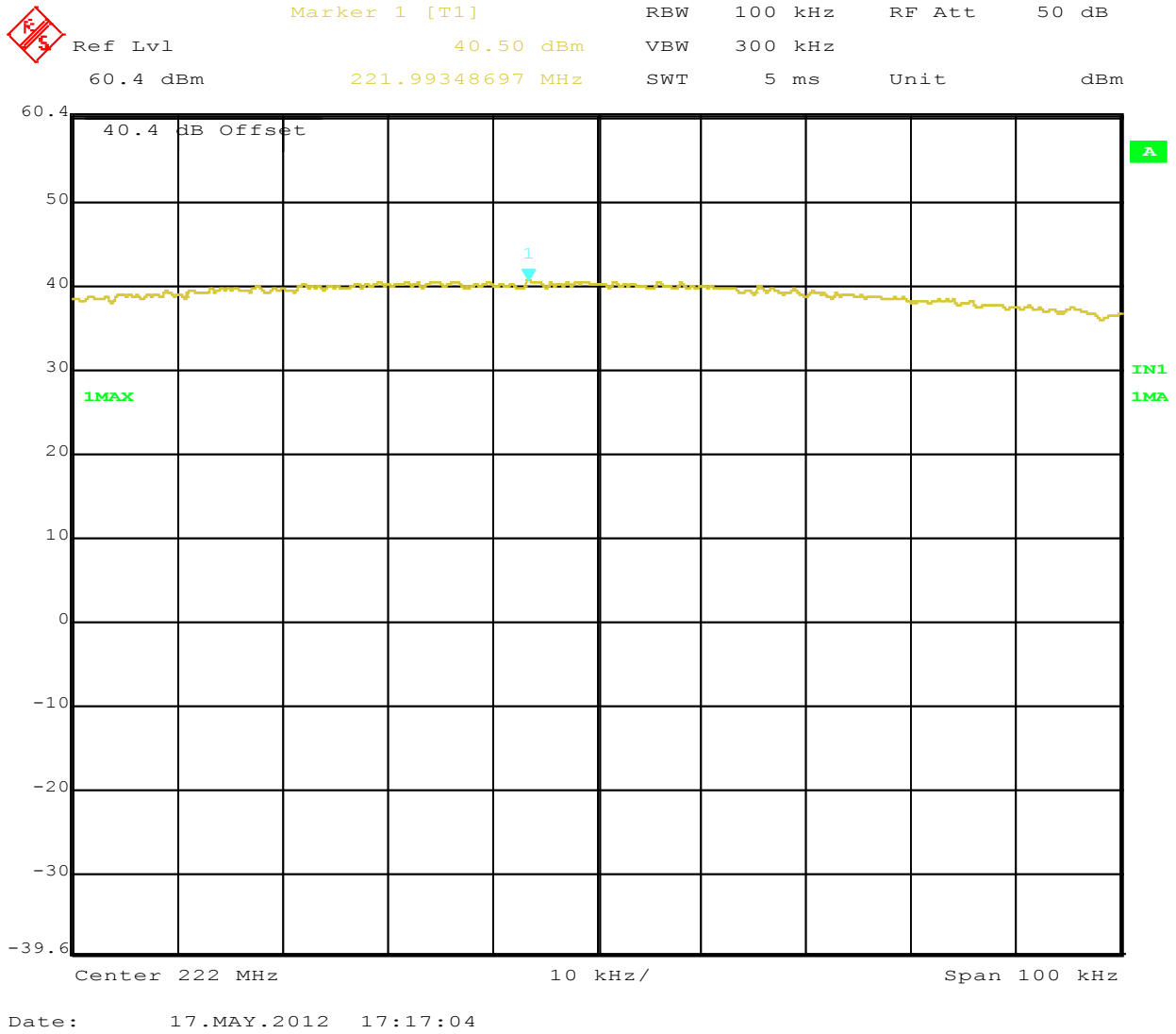

Figure 21: Maximum Transmitted Power, 222 MHz at 32 QPSK

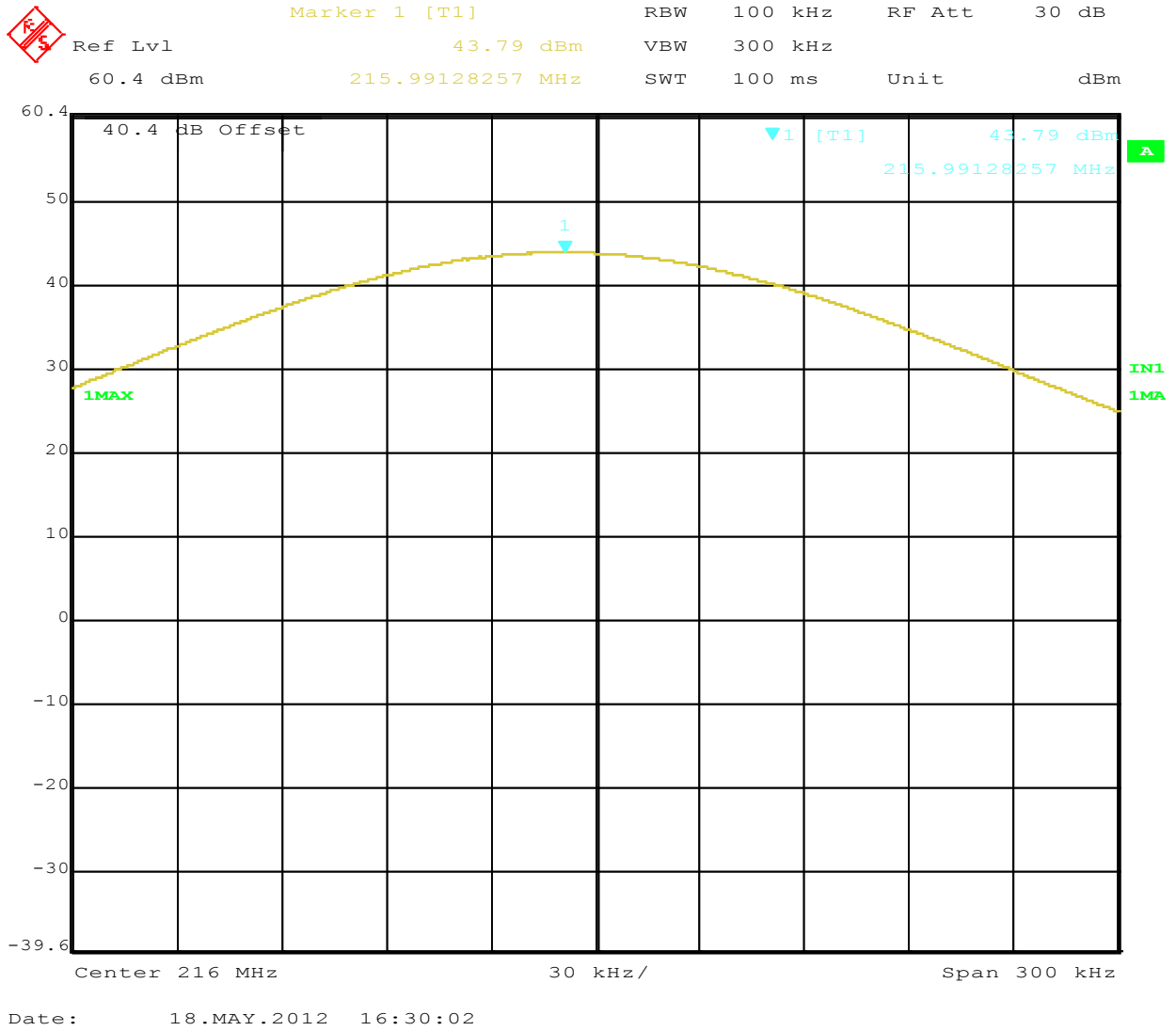

Figure 22: Maximum Transmitted Power, 216 MHz reduced power for Mobile application

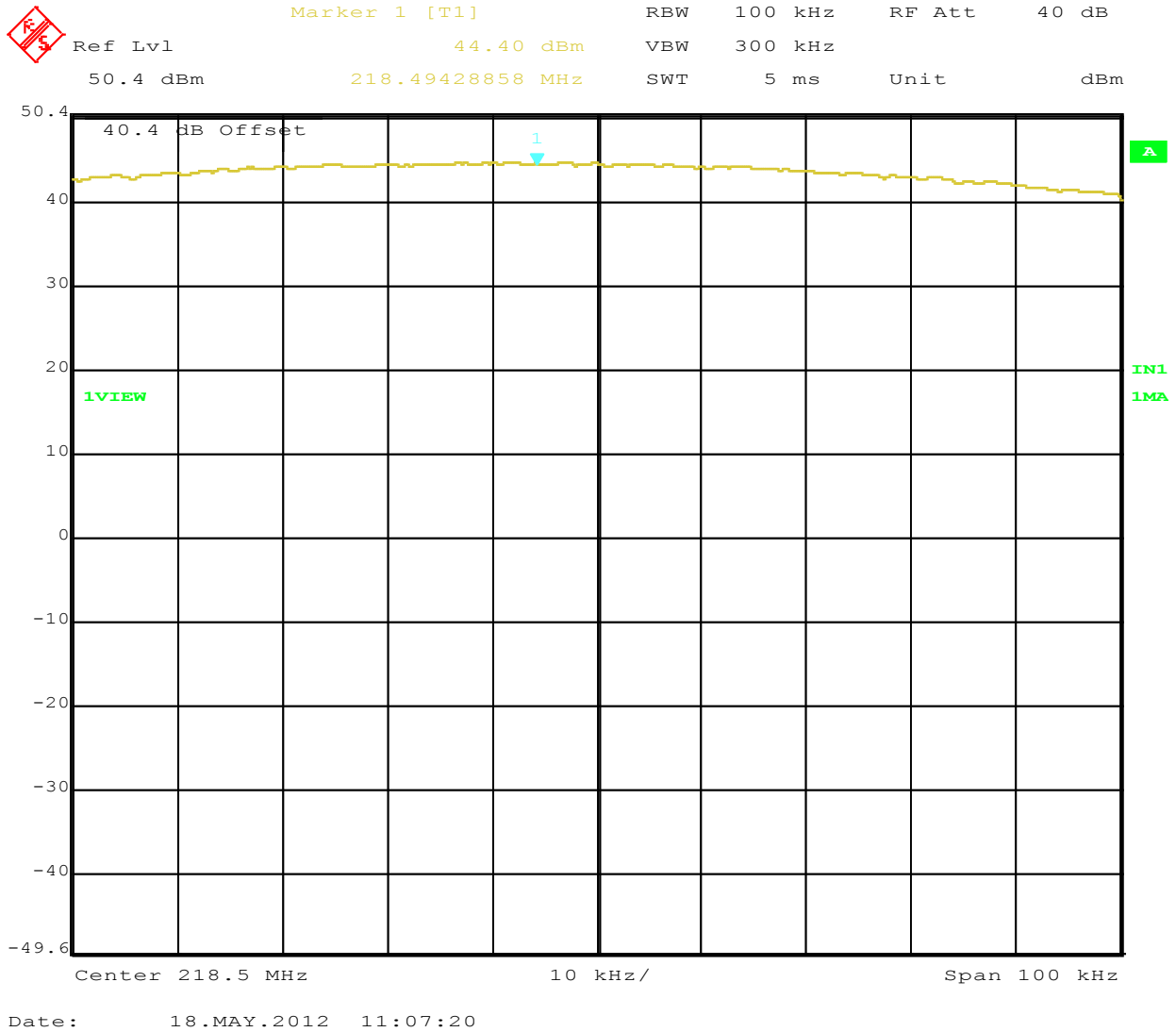

Figure 23: Maximum Transmitted Power, 218.5 MHz at 16 QPSK Mobile application

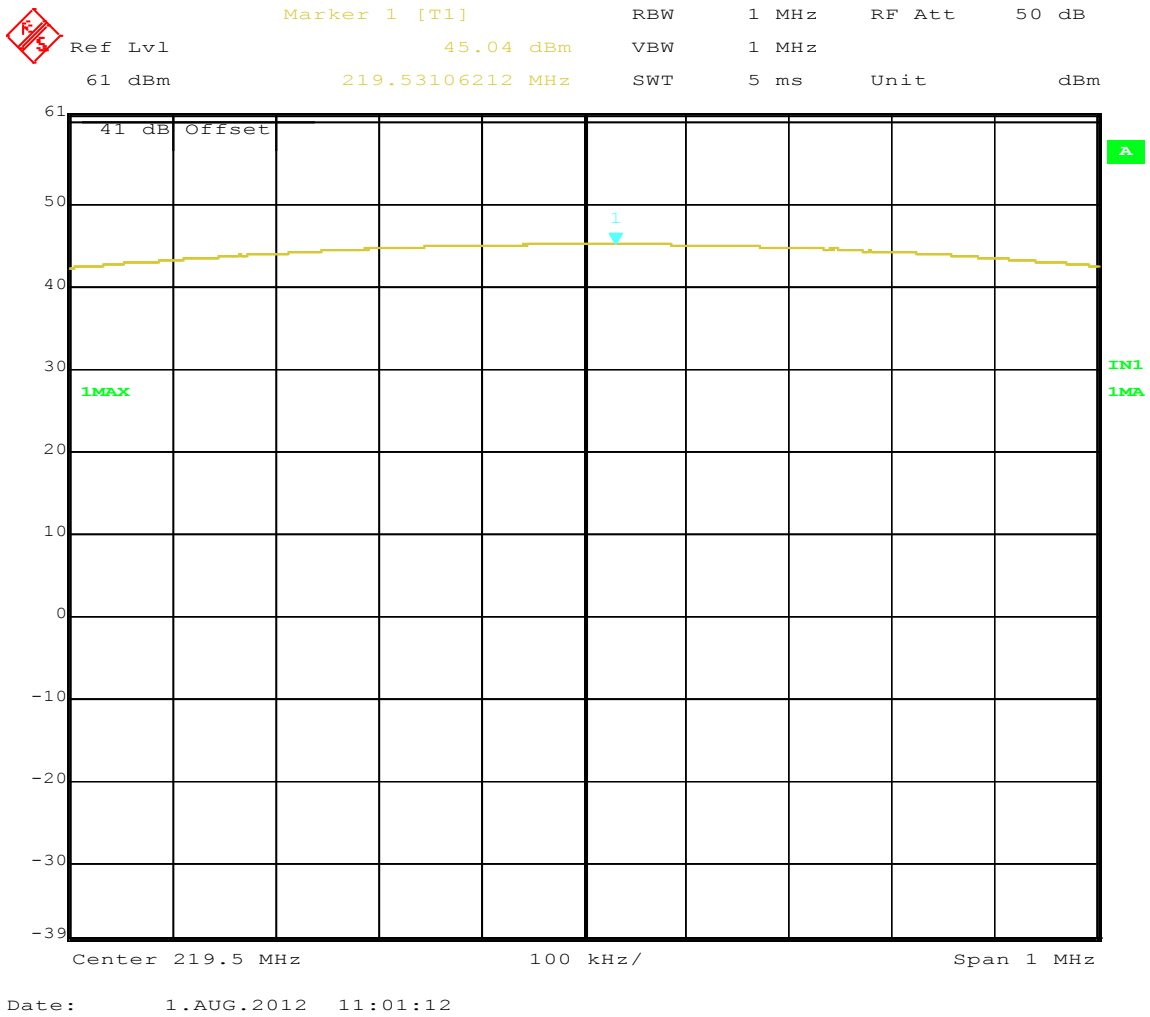
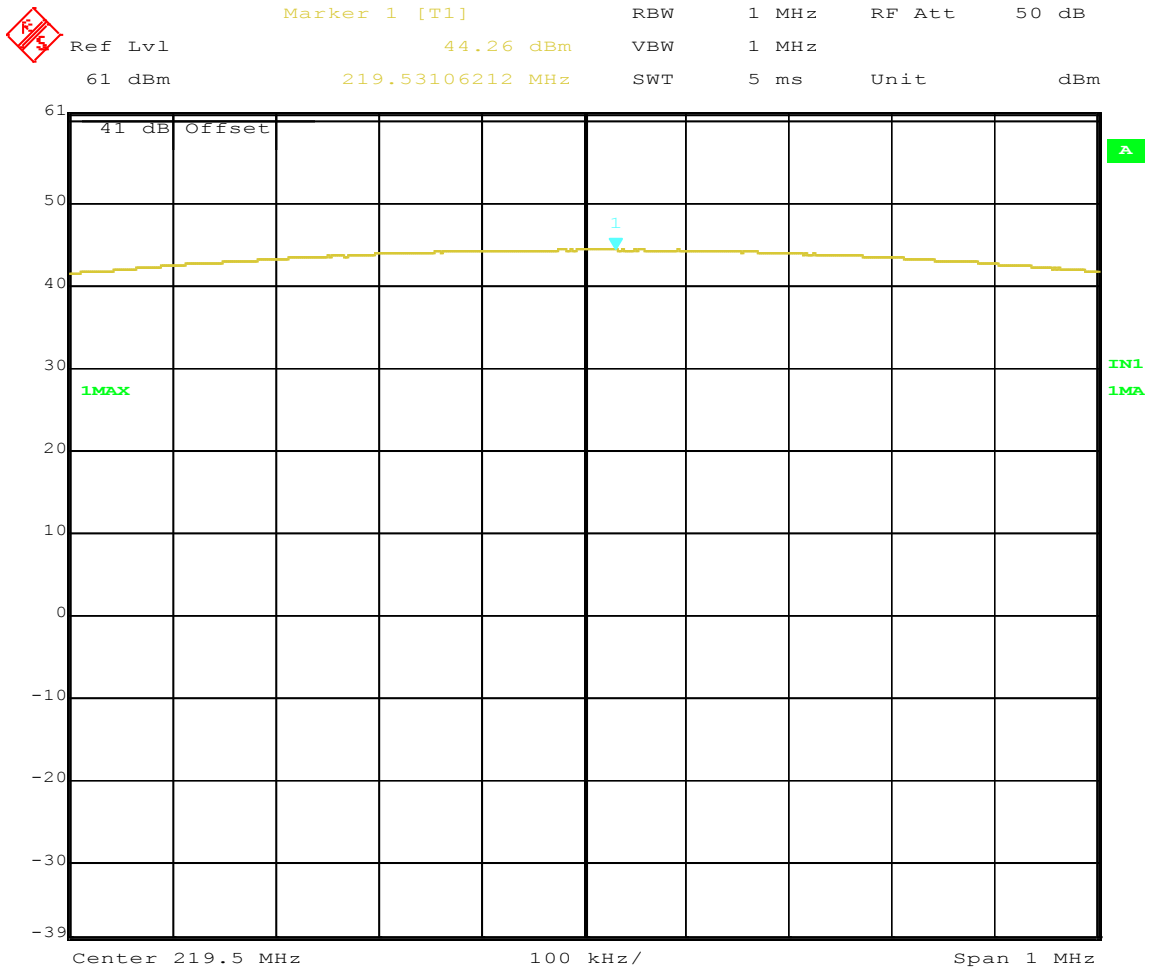

Figure 24: Maximum Transmitted Power, 219.5 MHz at GMSK Power for Fixed application



Date: 1.AUG.2012 11:02:58

Figure 25: Maximum Transmitted Power, 219.5 MHz at GMSK Power for mobile application

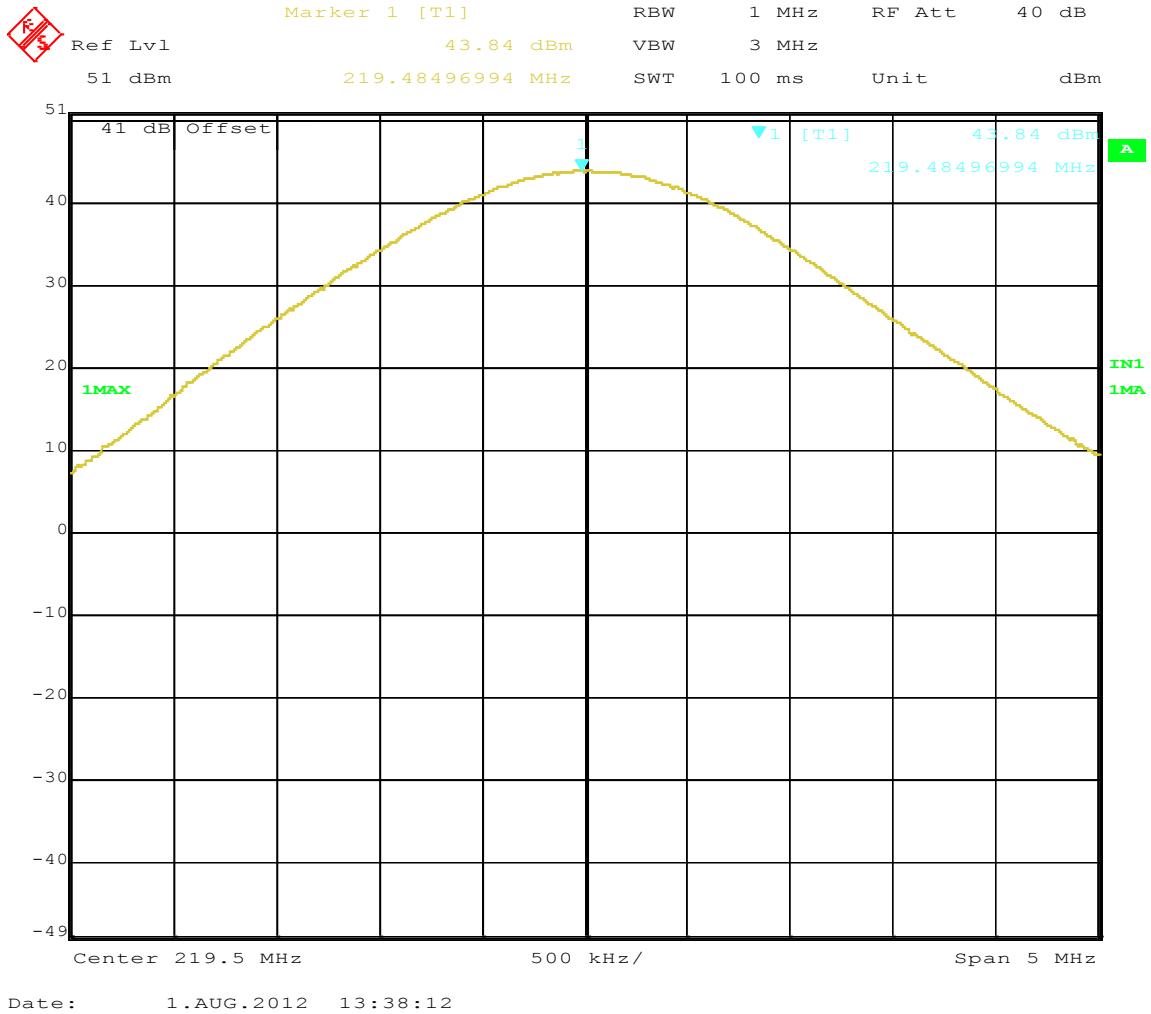

Figure 26: Maximum Transmitted Power, 219.5 MHz at 16 QPSK Power for Base station and mobile application

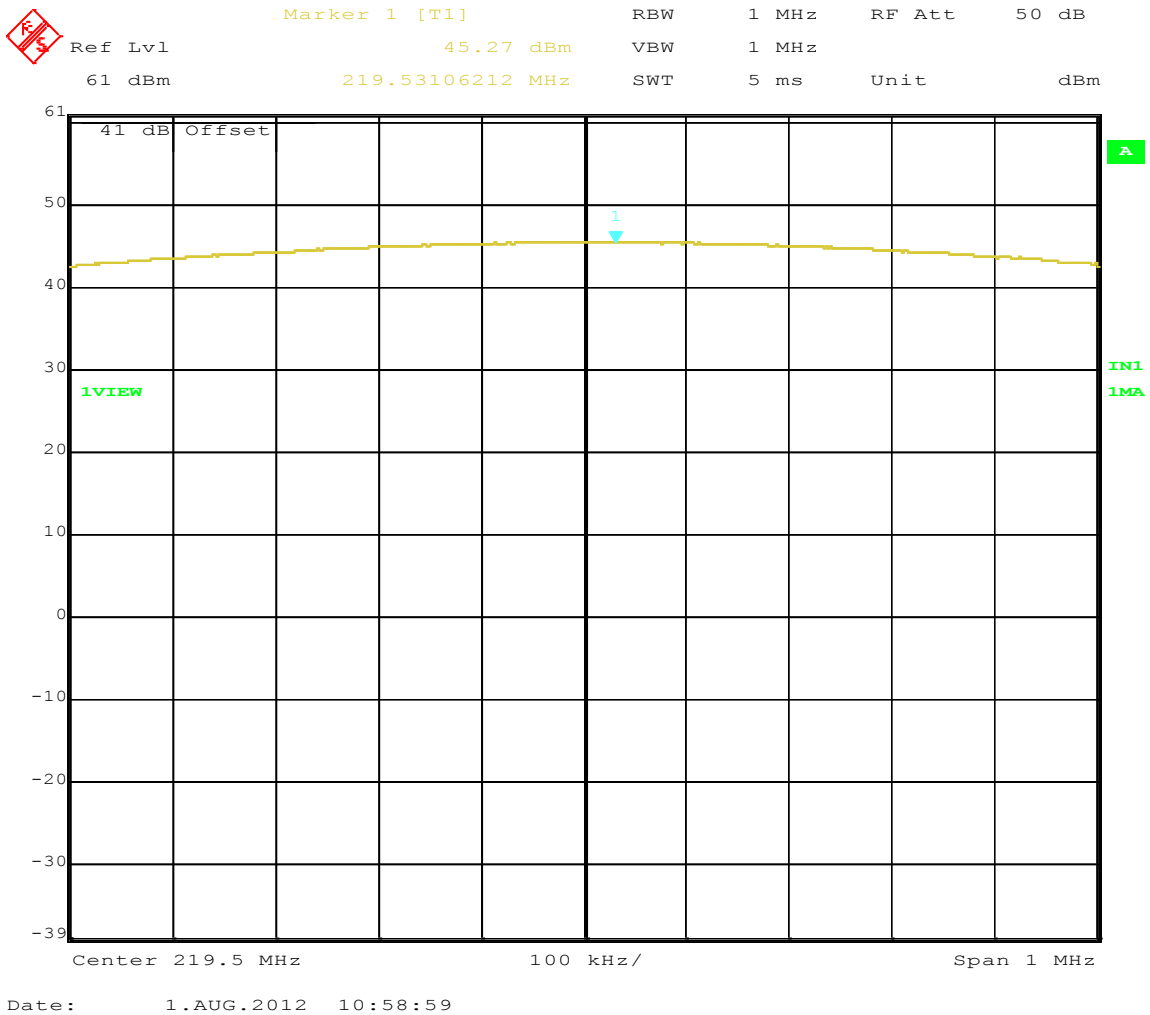

Figure 27: Maximum Transmitted Power, 219.5 MHz at 16 QPSK Power for Base station application

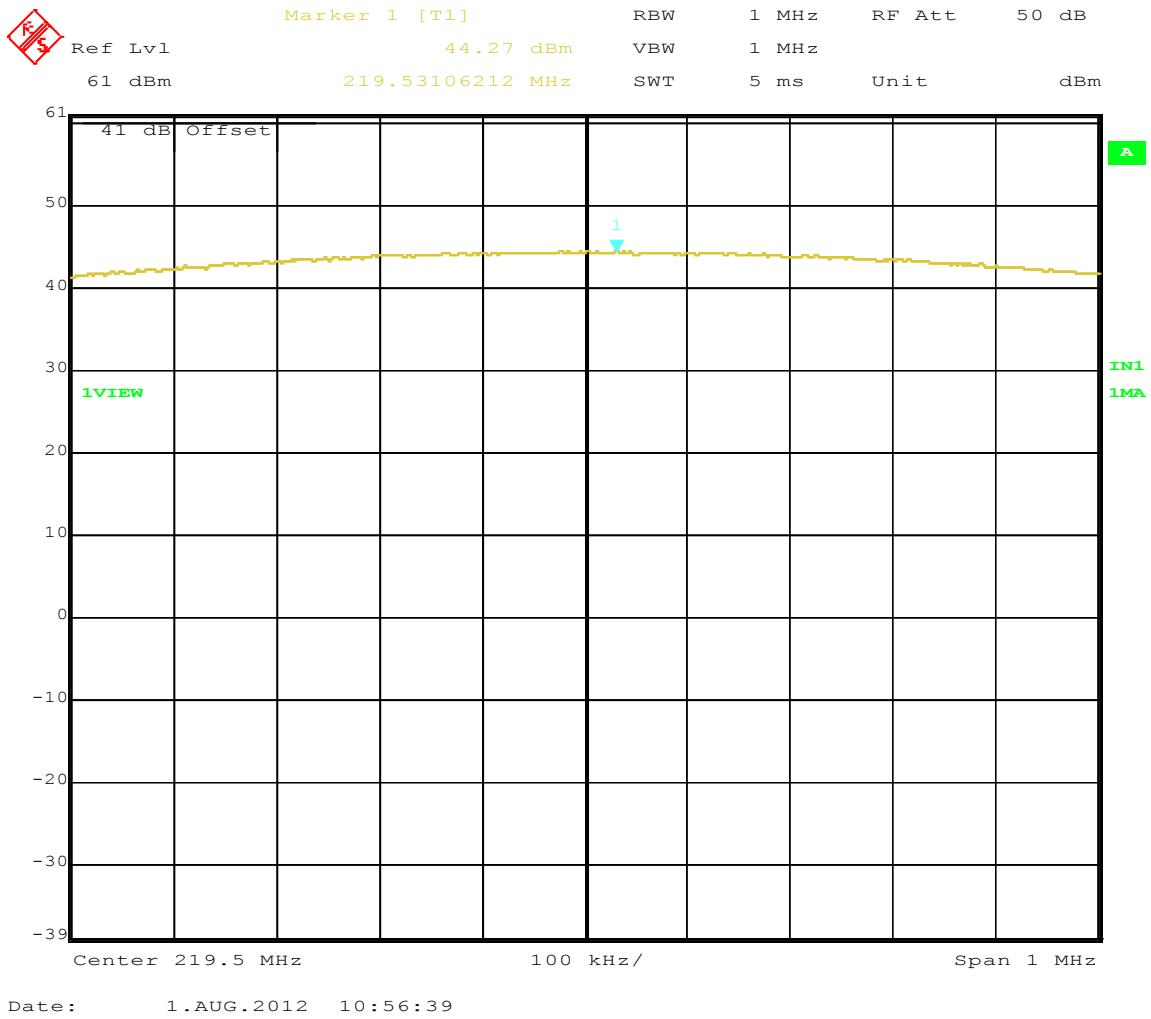

Figure 28: Maximum Transmitted Power, 219.5 MHz at 32 QPSK Power for mobile application

4.2 Occupied Bandwidth

The occupied bandwidth is measured at an amplitude level reduced from the reference level by a specified ratio. The reference level is the level of the highest amplitude signal observed from the transmitter at the fundamental frequency.

The 99% bandwidth is the bandwidth in which 99% of the transmitted power occupied.

The 26 dB bandwidth is defined the bandwidth of 26 dB from highest transmitted level of the fundamental frequency.

4.2.1 Test Method

The conducted method was used to measure the occupied bandwidth. The measurement was performed with modulation per CFR47 Part 90.209 & 90.259 and RSS-119. Initial investigation was performed at different data rates and TX chains. The narrowest bandwidths at each operational mode were measured on 3 operating channels. The worst sample result indicated below.

Test Setup:

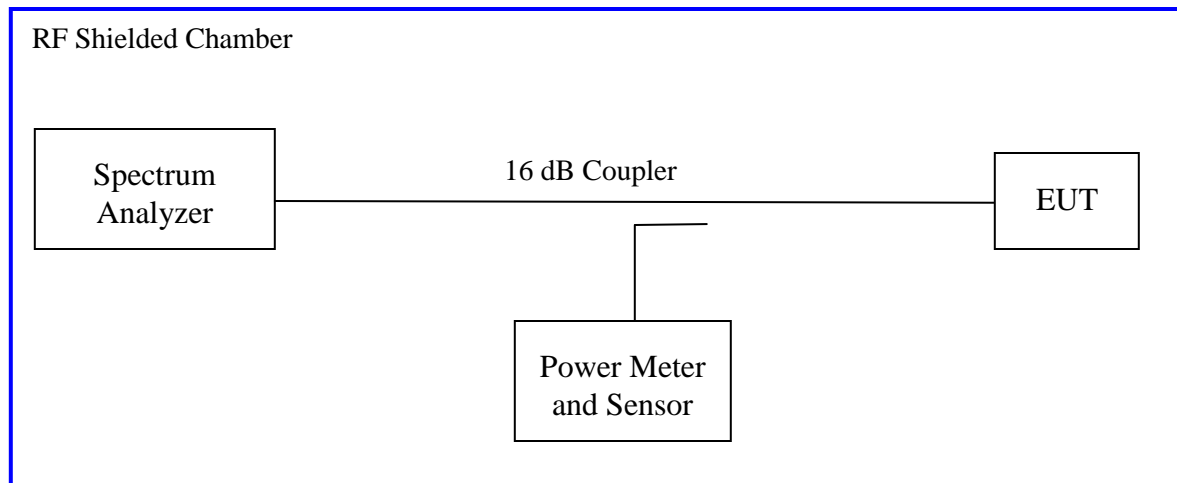

4.2.2 Results

As originally tested, the EUT was found to be compliant to the requirements of the test standard(s).

Table 3: Occupied Bandwidth – Test Results

Test Conditions: Conducted Measurement, Normal Temperature and Voltage only					
Antenna Type: External			Power Setting: See test plan		
Max. Antenna Gain: 3 dBi for Mobile and 14.1 dBi for Base Station			Signal State: Modulated		
Ambient Temp.: 21° C			Relative Humidity: 33%		
Bandwidth (KHz)					
Freq. (MHz)	Modulation/ Data rate	26 dB BW	99% Occupied BW	RSS-119 Limit (kHz)	Results
216.0	GMSK 9600	12.0	8.91	11.25	Pass
	16 QPSK	19.8	10.62	11.25	Pass
	32 QPSK	35.2	22.14	25.00	Pass
217.5	GMSK 9600	12.06	8.94	11.25	Pass
	16 QPSK	13.69	10.13	11.25	Pass
	32 QPSK	34.86	23.29	25.0	Pass
218.5	GMSK 9600	11.97	8.92	11.25	Pass
	16 QPSK	19.78	10.34	11.25	Pass
	32 QPSK	36.56	23.93	25.0	Pass
219.500	GMSK 9600	11.90	8.91	11.25	Pass
	16 QPSK	13.00	9.91	11.25	Pass
	32 QPSK	27.00	17.43	25.0	Pass
220.0125	GMSK 9600	12.05	9.00	11.25	Pass
	16 QPSK	13.6	8.91	11.25	Pass
	32 QPSK	20.39	16.76	25.0	Pass

220.9875	GMSK 9600	12.19	9.00	11.25	Pass
	16 QPSK	14.31	10.08	11.25	Pass
	32 QPSK	21.01	16.76	25.0	Pass
222.00	GMSK 9600	12.00	8.917	11.25	Pass
	16 QPSK	14.36	10.06	11.25	Pass
	32 QPSK	21.04	16.83	25.0	Pass

Note: Measurements plots for 219.5 MHz in Figures 43 - 45

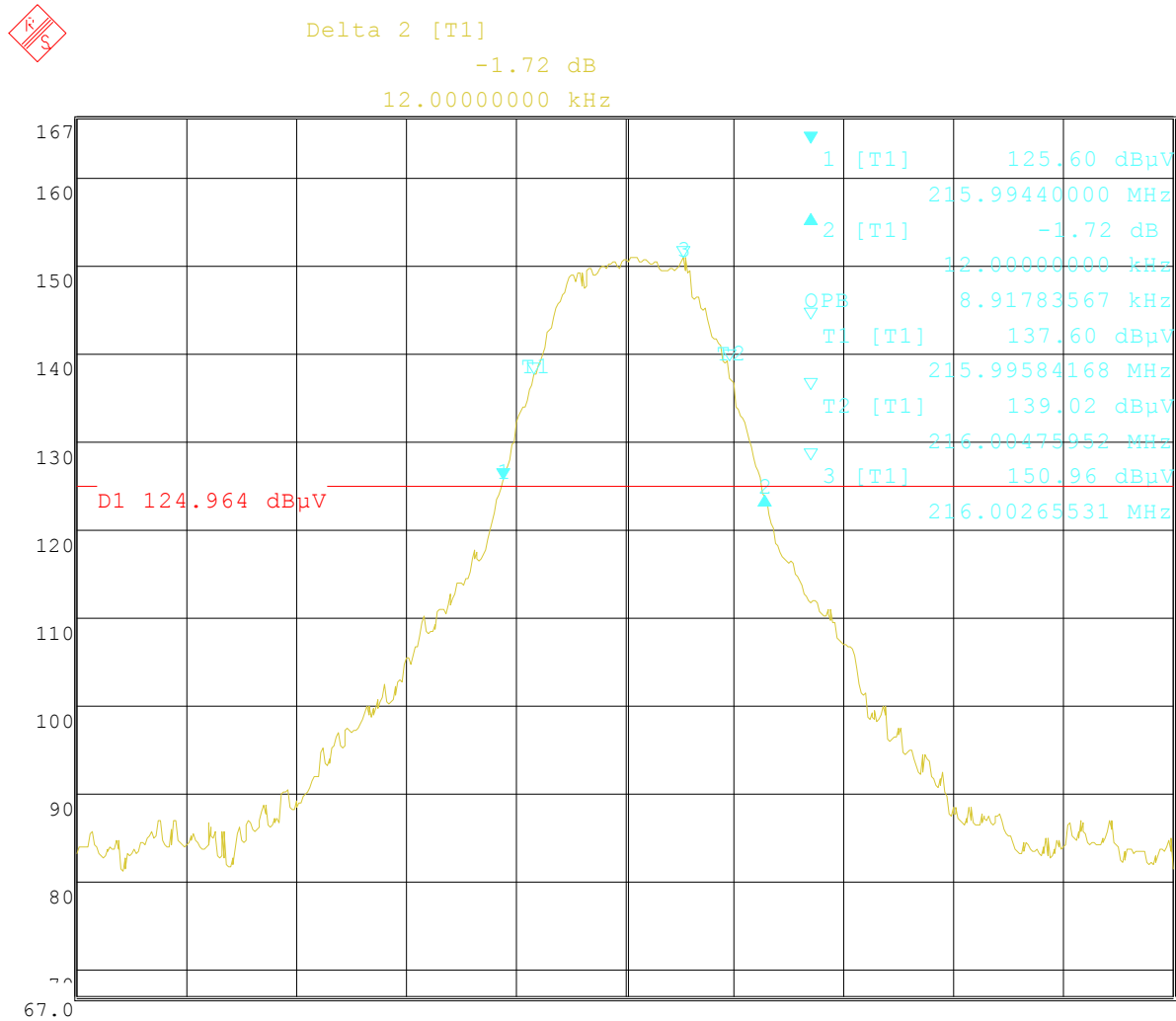

Date: 18.MAY.2012 16:25:40

Figure 29: Occupied Bandwidth at Operating Channel 216.0 MHz at GMSK

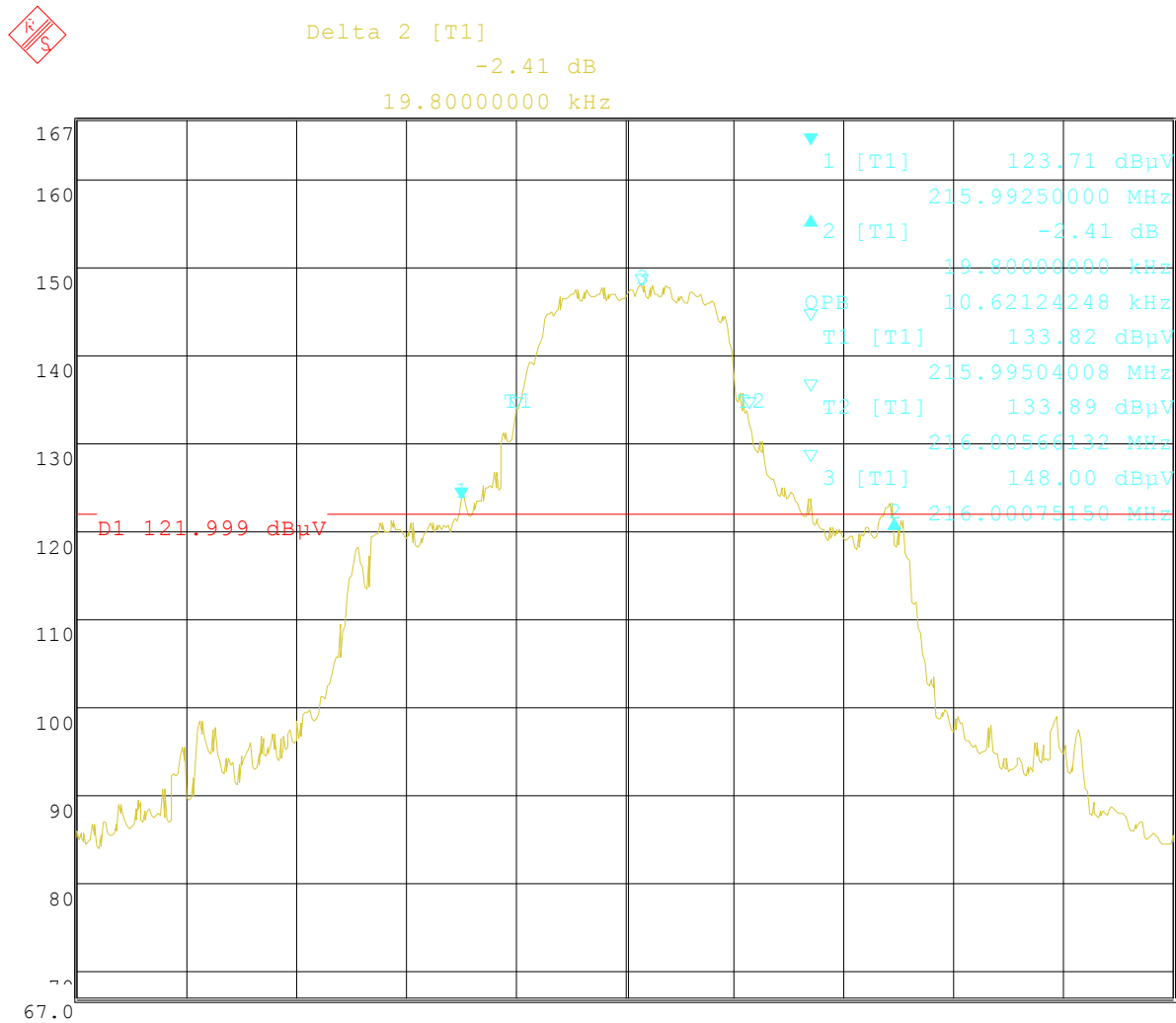

Date: 18.MAY.2012 16:02:12

Figure 30: Occupied Bandwidth at Operating Channel 216.0 MHz at 16 QPSK

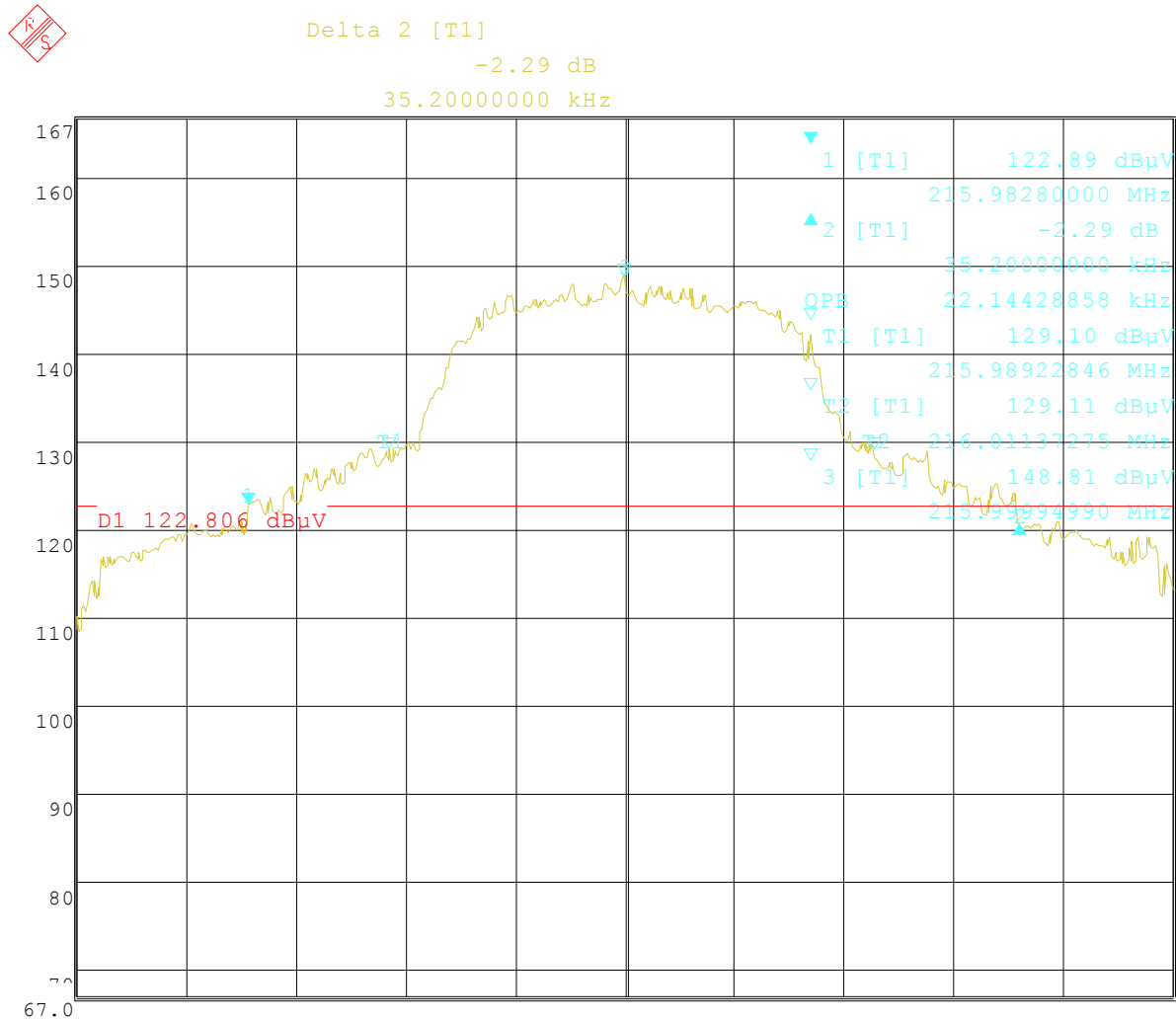

Date: 18.MAY.2012 16:23:28

Figure 31: Occupied Bandwidth at Operating Channel 216.0 MHz at 32 QPSK

Agilent 14:53:40 Apr 20, 2012

R T

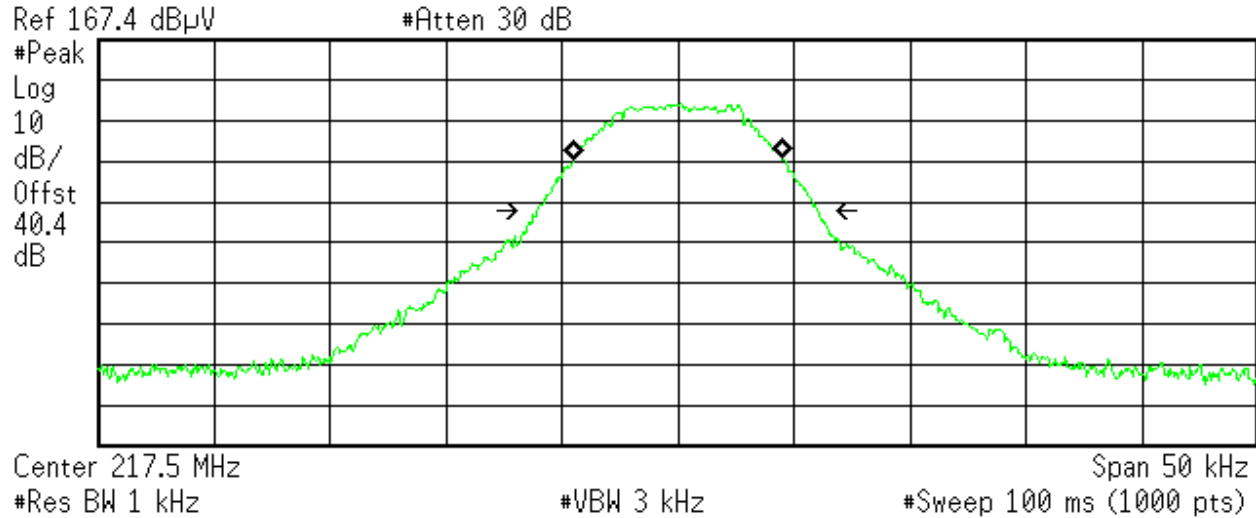

Occupied Bandwidth
8.9468 kHz

Occ BW % Pwr 99.00 %
x dB -26.00 dB

Transmit Freq Error 6.617 Hz
x dB Bandwidth 12.066 kHz

Figure 32: Occupied Bandwidth at Operating Channel 217.5 MHz at GMSK

Agilent 15:30:06 Apr 20, 2012

R T

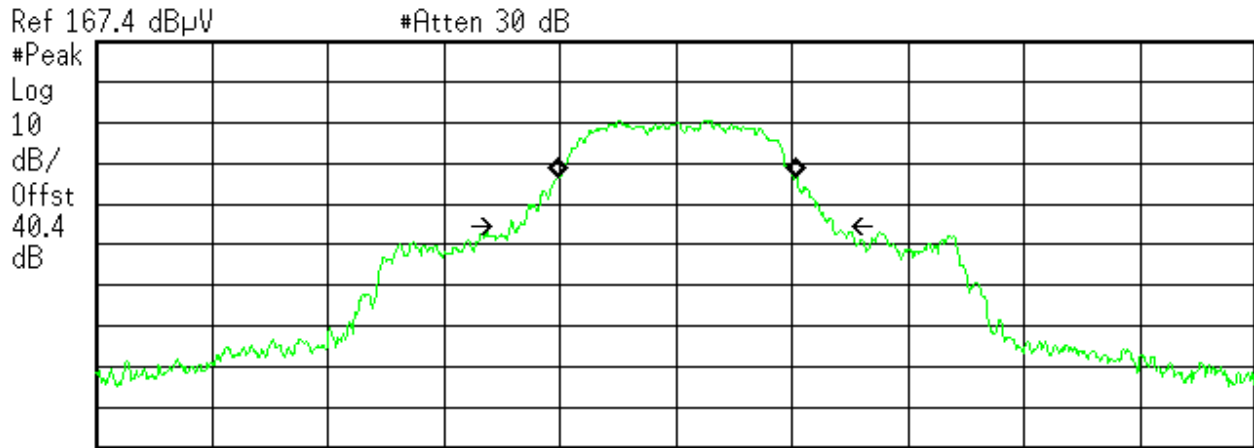

Occupied Bandwidth
 10.1320 kHz

Occ BW % Pwr 99.00 %
x dB -26.00 dB

Transmit Freq Error 9.031 Hz
x dB Bandwidth 13.699 kHz

Figure 33: Occupied Bandwidth at Operating Channel 217.5 MHz at 16 QPSK

Agilent 14:58:33 Apr 20, 2012

R T

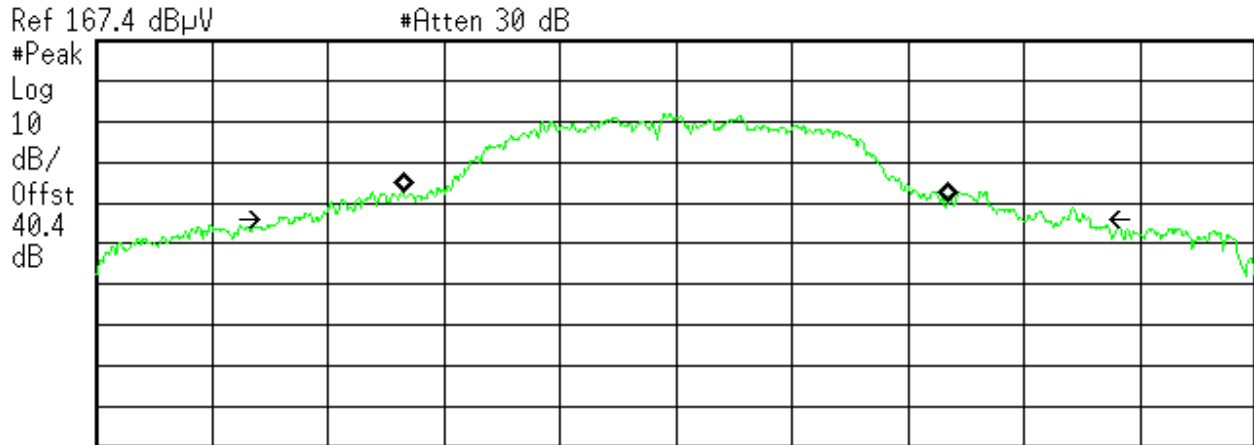

Center 217.5 MHz Span 50 kHz
 #Res BW 1 kHz #VBW 3 kHz #Sweep 100 ms (1000 pts)

Occupied Bandwidth
 23.2972 kHz

Occ BW % Pwr 99.00 %
x dB -26.00 dB

Transmit Freq Error -67.422 Hz
x dB Bandwidth 34.863 kHz

Figure 34: Occupied Bandwidth at Operating Channel 217.5 MHz at 32 QPSK

Agilent 14:45:56 Apr 20, 2012

R T

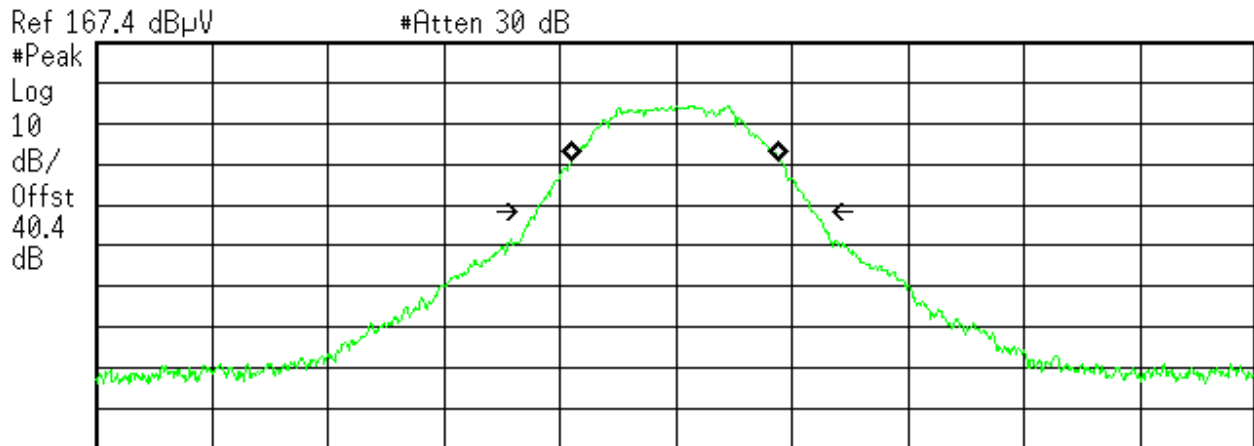

Center 218.5 MHz Span 50 kHz
 #Res BW 1 kHz #VBW 3 kHz #Sweep 100 ms (1000 pts)

Occupied Bandwidth
 8.9284 kHz

Occ BW % Pwr 99.00 %
Occupied Bandwidth -26.00 dB

Transmit Freq Error -31.695 Hz
x dB Bandwidth 11.970 kHz

Figure 35: Occupied Bandwidth at Operating Channel 218.5 MHz at GMSK

Agilent 15:17:55 Apr 20, 2012

R T

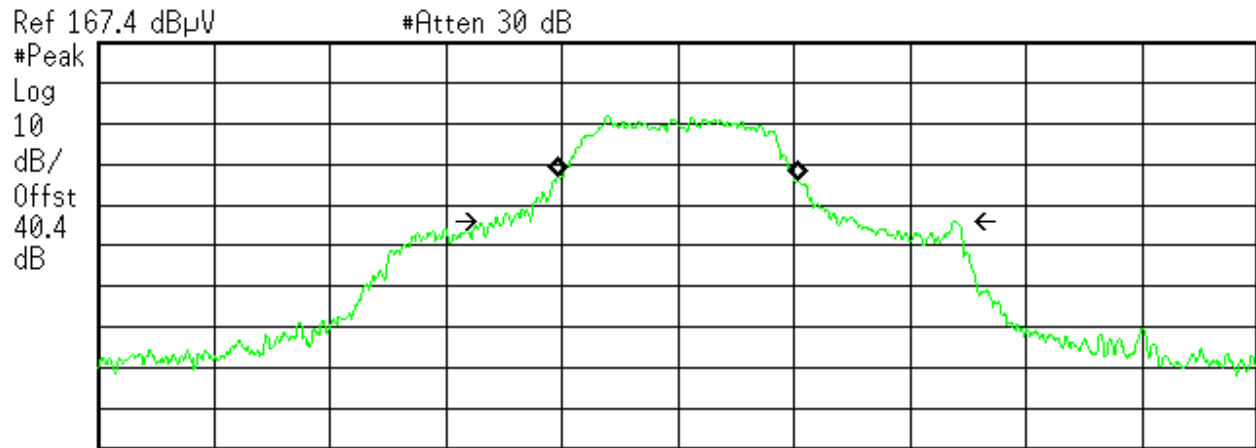

Center 218.5 MHz Span 50 kHz
#Res BW 1 kHz #VBW 3 kHz #Sweep 100 ms (1000 pts)

Occupied Bandwidth
10.3497 kHz

Occ BW % Pwr 99.00 %
x dB -26.00 dB

Transmit Freq Error -13.608 Hz
x dB Bandwidth 19.781 kHz

Figure 36: Occupied Bandwidth at Operating Channel 218.5 MHz at 16 QPSK

Agilent 14:50:17 Apr 20, 2012

R T

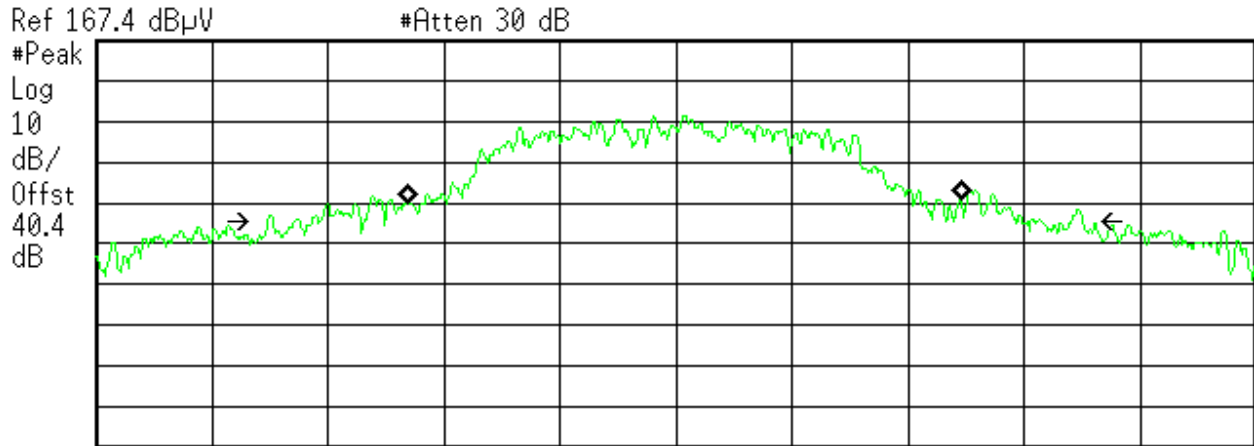

Center 218.5 MHz Span 50 kHz
 #Res BW 1 kHz #VBW 3 kHz #Sweep 100 ms (1000 pts)

Occupied Bandwidth
 23.9312 kHz

Occ BW % Pwr 99.00 %
x dB -26.00 dB

Transmit Freq Error 288.958 Hz
x dB Bandwidth 36.567 kHz

Figure 37: Occupied Bandwidth at Operating Channel 218.5 MHz at 32 QPSK

Agilent 14:23:27 Apr 20, 2012

R T

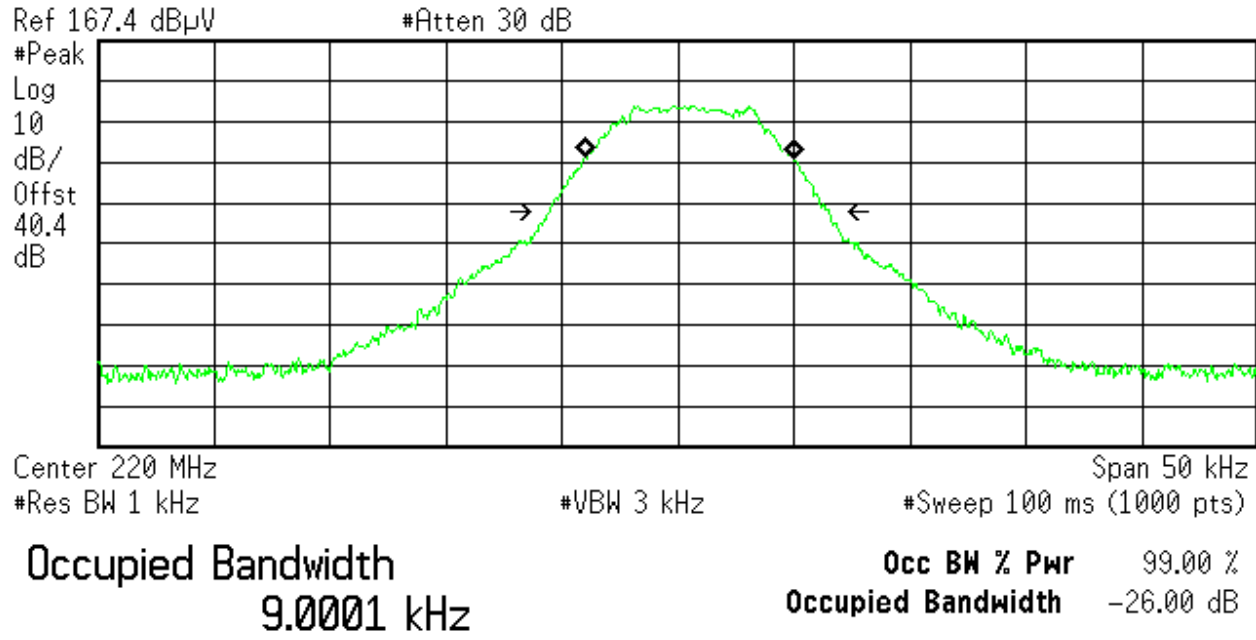

Transmit Freq Error 465.863 Hz
x dB Bandwidth 12.058 kHz

Figure 38: Occupied Bandwidth at Operating Channel 220.0125 MHz at GMSK

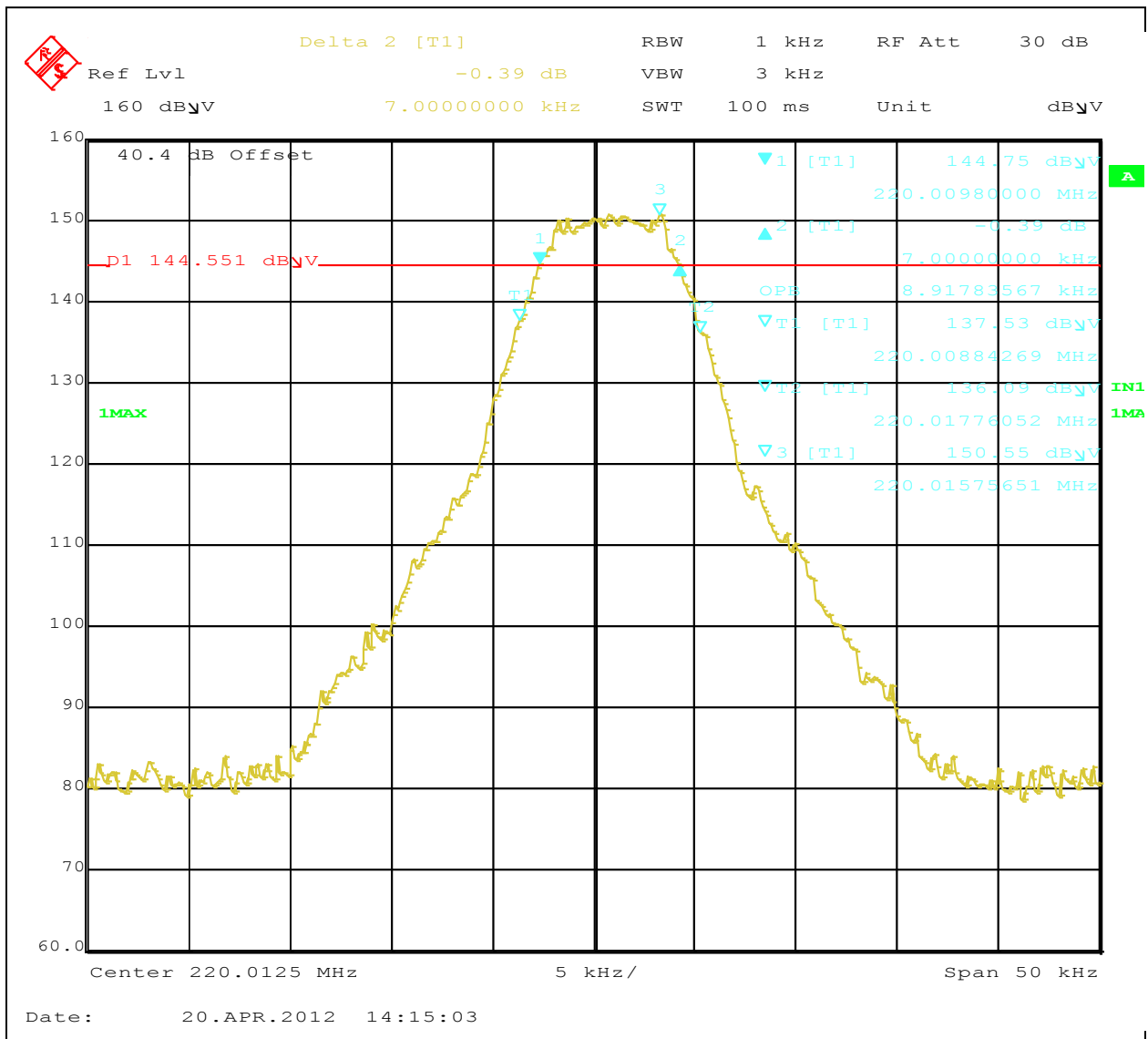
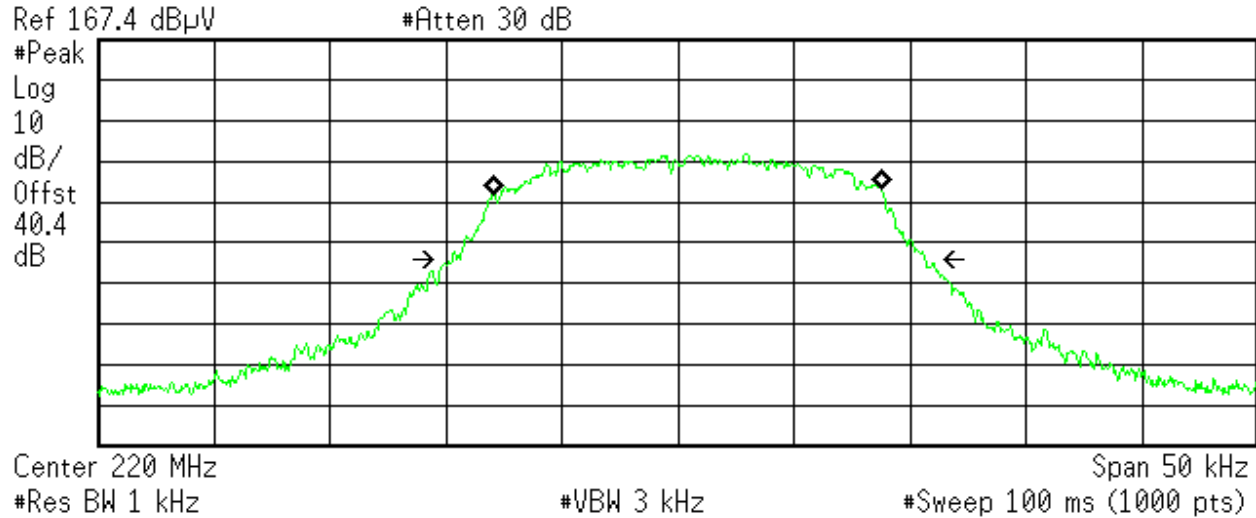

Figure 39: Occupied Bandwidth at Operating Channel 220.0125 MHz at 16 QPSK

Agilent 14:26:38 Apr 20, 2012

R T



Occupied Bandwidth
 16.7649 kHz

Occ BW % Pwr 99.00 %
x dB -26.00 dB

Transmit Freq Error 408.554 Hz
x dB Bandwidth 20.396 kHz

Figure 40: Occupied Bandwidth at Operating Channel 220.0125 MHz at 32 QPSK

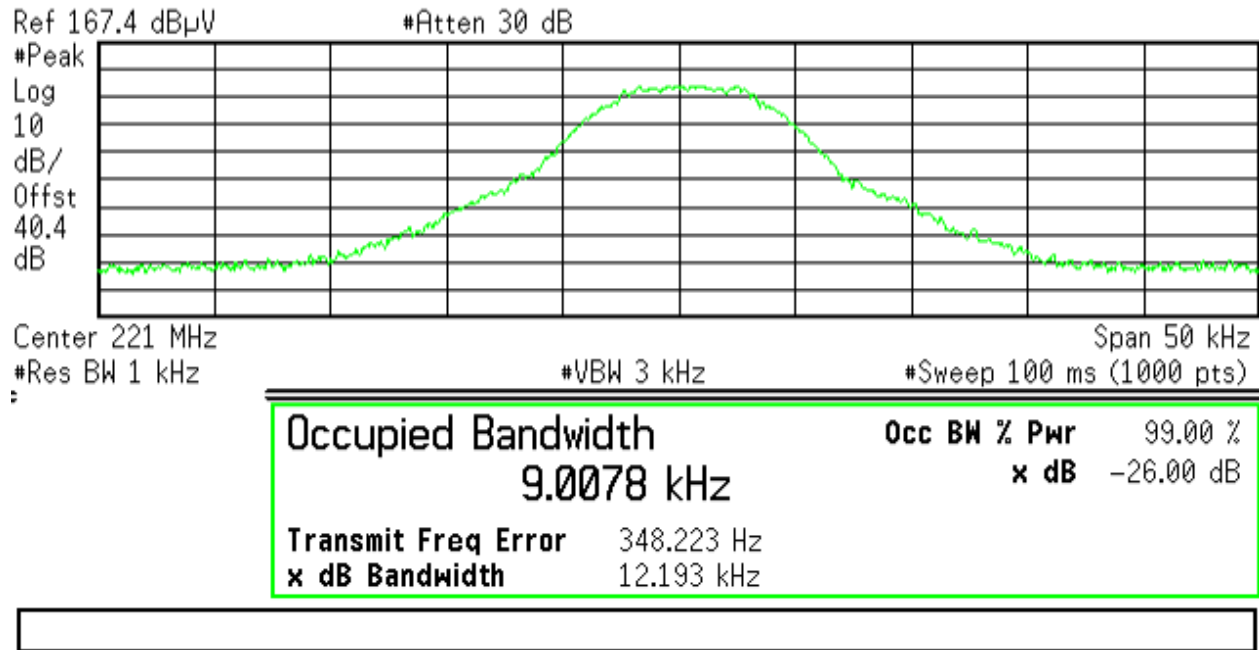
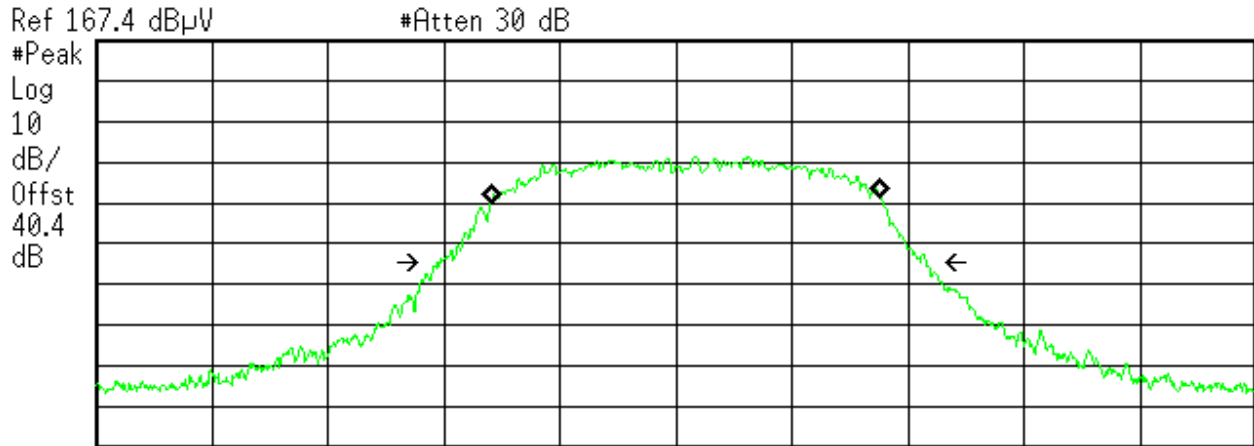

Figure 41: Occupied Bandwidth at Operating Channel 220.9875 MHz at GMSK

Agilent 14:31:41 Apr 20, 2012

R T



Center 221 MHz Span 50 kHz
 #Res BW 1 kHz #VBW 3 kHz #Sweep 100 ms (1000 pts)

Occupied Bandwidth
 16.7652 kHz

Occ BW % Pwr 99.00 %
x dB -26.00 dB

Transmit Freq Error 396.377 Hz
x dB Bandwidth 21.070 kHz

Figure 42: Occupied Bandwidth at Operating Channel 220.9875 MHz at 32 QPSK

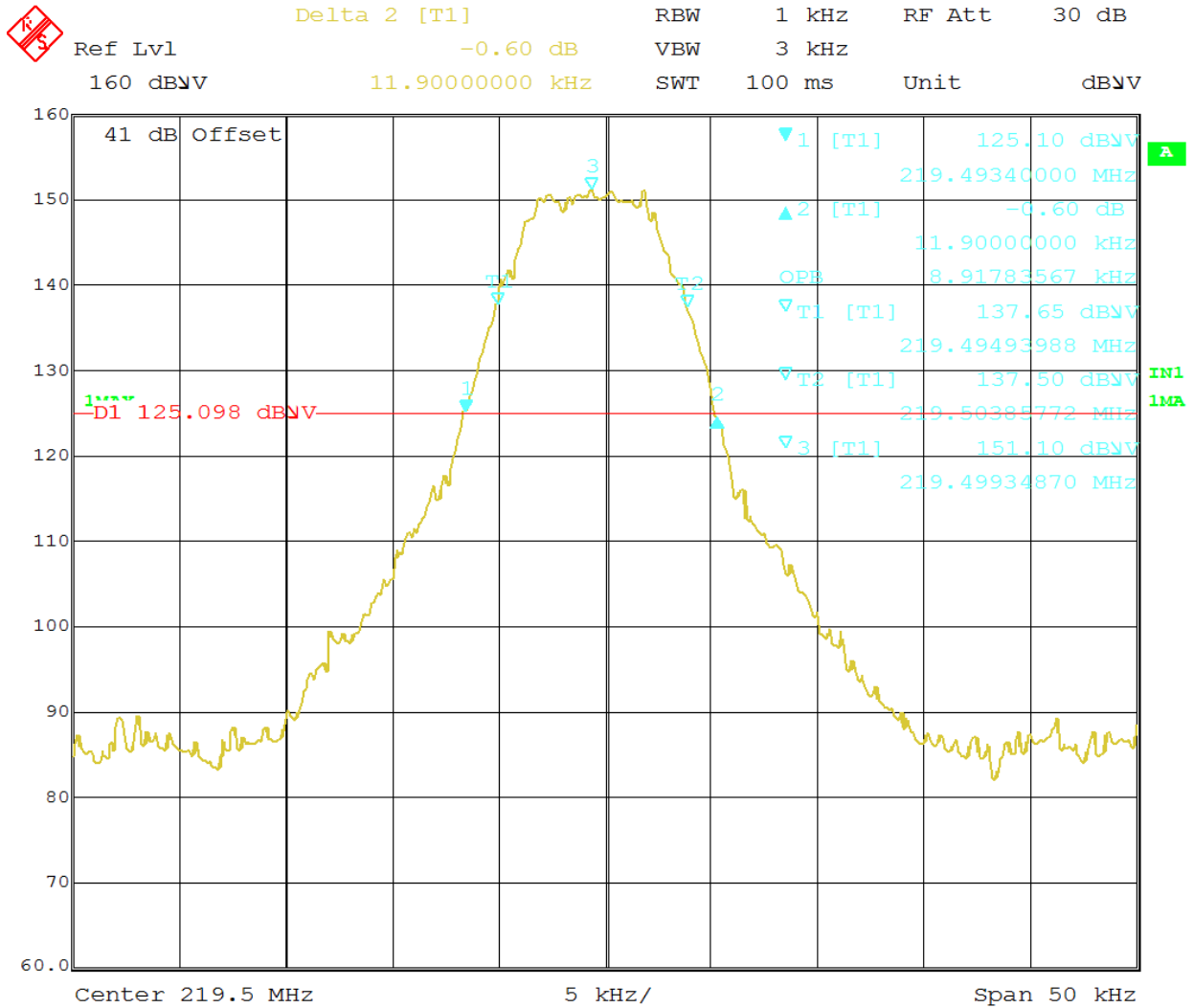

Date: 1.AUG.2012 11:25:41

Figure 43: Occupied Bandwidth at Operating Channel 219.5 MHz at GMSK

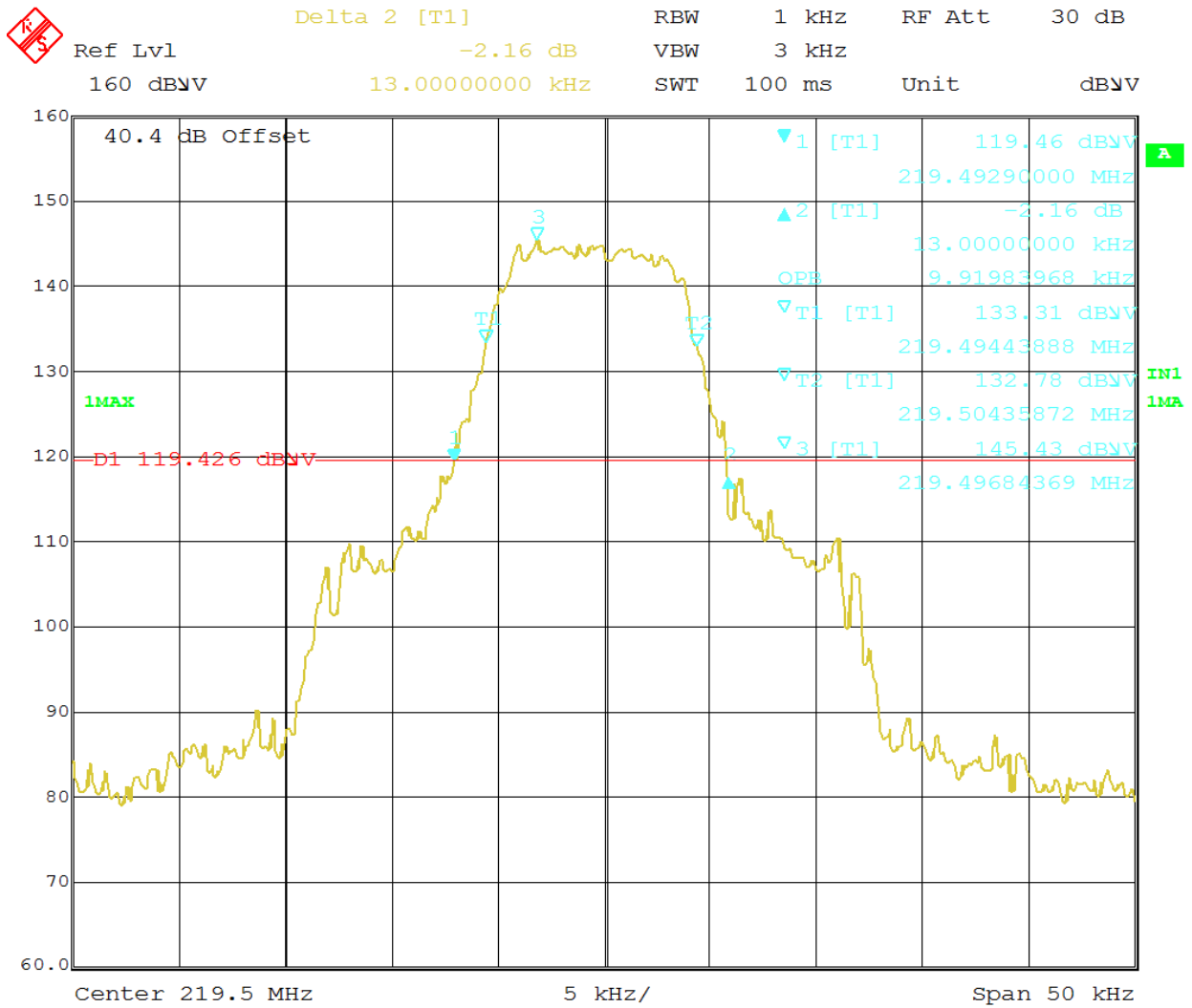

Date: 1.AUG.2012 13:46:01

Figure 44: Occupied Bandwidth at Operating Channel 219.5 MHz 16 QPSK

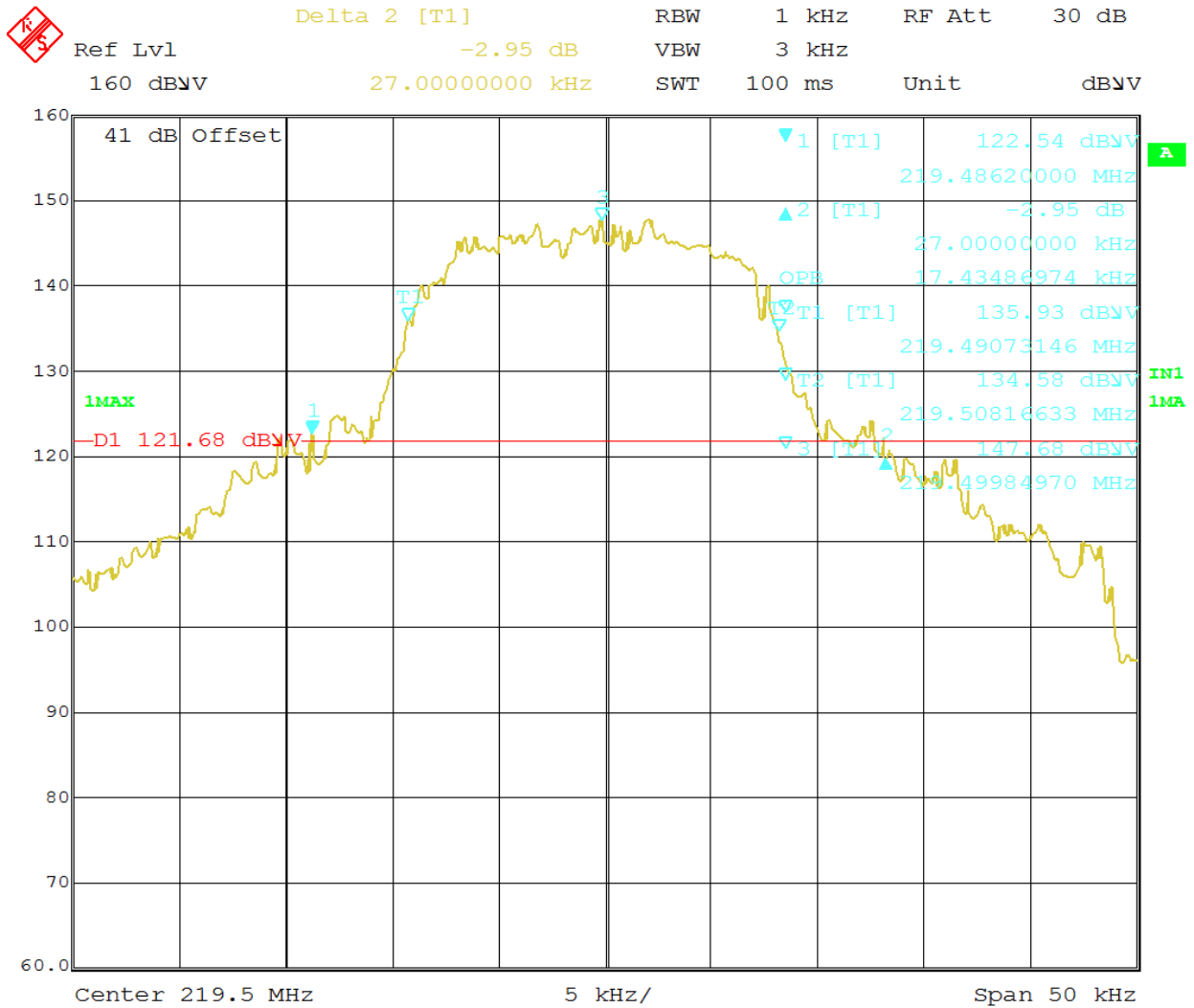

Date: 1.AUG.2012 11:26:56

Figure 45: Occupied Bandwidth at Operating Channel 219.5 MHz at 32 QPSK

4.3 Spectral Mask requirements

4.3.1.1.1 90.210 Emission masks.

The transmitters used in the radio service governed by this part of radio service must comply

Applicable mask 216-220 MHz Mask C Part 90.210, RSS-119 table 3 Mask J

Applicable mask for 220-222 MHz Mask F Part 90.210, RSS-119 table 3 Mask F

c) **Emission Mask C.** For transmitters that are not equipped with an audio low-pass filter, the power of any emission must be attenuated below the unmodulated carrier output power (P) as follows:

- (1) On any frequency removed from the center of the authorized bandwidth by a displacement frequency (f_d in kHz) of more than 5 kHz, but not more than 10 kHz: At least $83 \log(f_d/5)$ dB;
- (2) On any frequency removed from the center of the authorized bandwidth by a displacement frequency (f_d in kHz) of more than 10 kHz, but not more than 250 percent of the authorized bandwidth: At least $29 \log(f_d^2/11)$ dB or 50 dB, whichever is the lesser attenuation;
- (3) On any frequency removed from the center of the authorized bandwidth by more than 250 percent of the authorized bandwidth: At least $43 + 10 \log(P)$ dB.

(f) **Emission Mask F.** For transmitters operating in the 220–222 MHz frequency band, any emission must be attenuated below the power (P) of the highest emission contained within the authorized bandwidth as follows:

- (1) On any frequency from the center of the authorized bandwidth f_o to the edge of the authorized bandwidth f_e : Zero dB.
- (2) On any frequency removed from the center of the authorized bandwidth by a displacement frequency (f_d in kHz) of more than 2 kHz up to and including 3.75 kHz: $30 + 20(f_d-2)$ dB or $55 + 10 \log(P)$, or 65 dB, whichever is the lesser attenuation.
- (3) On any frequency beyond 3.75 kHz removed from the center of the authorized bandwidth f_d : At least $55 + 10 \log(P)$ dB.

Results

The Out of band emission was performed on the conducted test sample.

As originally tested, the EUT was found to be compliant to the requirements of the test standard(s).

Table 4: Spectral Mask Requirements – Test Results

Test Conditions: Conducted Measurement, Normal Temperature and Voltage only				
Antenna Type: External			Power Setting: See test plan	
Max. Antenna Gain: 5 dBi Mobile 14.1 dBi Base station			Signal State: Modulated	
Ambient Temp.: 21° C			Relative Humidity: 39%	
Emission Mask				
Operating Freq. MHz	Mode	Limit (dBm)	Measured Value (dBm)	Result
217.5	GMSK 9600	Mask C 90.210(b)/80.211(f) or 90.210(f) Mask J RSS-119	See plots	Pass
217.5	16 QPSK	Mask C 90.210(b)/80.211(f) or 90.210(f) Mask J RSS-119	See plots	Pass
217.5	32 QPSK	Mask C 90.210(b)/80.211(f) or 90.210(f) Mask J RSS-119	See plot	Pass
218.5	GMSK 9600	Mask C 90.210(b)/80.211(f) or 90.210(f)	See plots	Pass
218.5	16 QPSK	Mask C 90.210(b)/80.211(f) or 90.210(f)	See plots	Pass
218.5	32 QPSK	Mask C 90.210(b)/80.211(f) or 90.210(f)	See plots	Pass
219.5	GMSK 9600	Mask C 90.210(b)/80.211(f) or 90.210(f) Mask J RSS-119	See plots	Pass
219.5	16 QPSK	Mask C 90.210(b)/80.211(f) or 90.210(f) Mask J RSS-119	See plots	Pass

219.5	32 QPSK	Mask C 90.210(b)/80.211(f) or 90.210(f) Mask J RSS-119	See plots	Pass
220.0125	GMSK 9600	Mask F 90.210(f)/Mask F RSS- 119	See plot	Pass
220.0125	16 QPSK	Mask F 90.210(f)/Mask F RSS- 119	See plot	Pass
220.0125	32 QPSK	90.210(f)	See plot	Pass
220.9875	GMSK	MaskF 90.210(f)/Mask F RSS- 119	See plot	Pass
220.9875	GMSK 9600	MaskF 90.210(f)/Mask F RSS- 119	See plot	Pass
220.9875	32 QPSK	MaskF 90.210(f)/Mask F RSS- 119	See plot	Pass

Note 1: All mask measurements were performed as indicated in the above table. Only worst case/ limited number of plots are placed in the report.

Note 2: Emission mask CFR part 80.211(f) is applicable for 216 to 220 MHz, since the TransAir PTC-3000 does not use audio filter the closet mask Emission mask C was applied.

Note 3: For Mask J, two channel (2x12.5KHz) aggregation was used for 32 QPSK modulation. No channel aggregation was used for GMSK and 16 QPSK.

Note 4: For 220 -222 MHz, mask F requirements five (5x5KHz) channel aggregation was used.

Note 5: Emission masks for 219.5 MHz are in figures 60 - 62

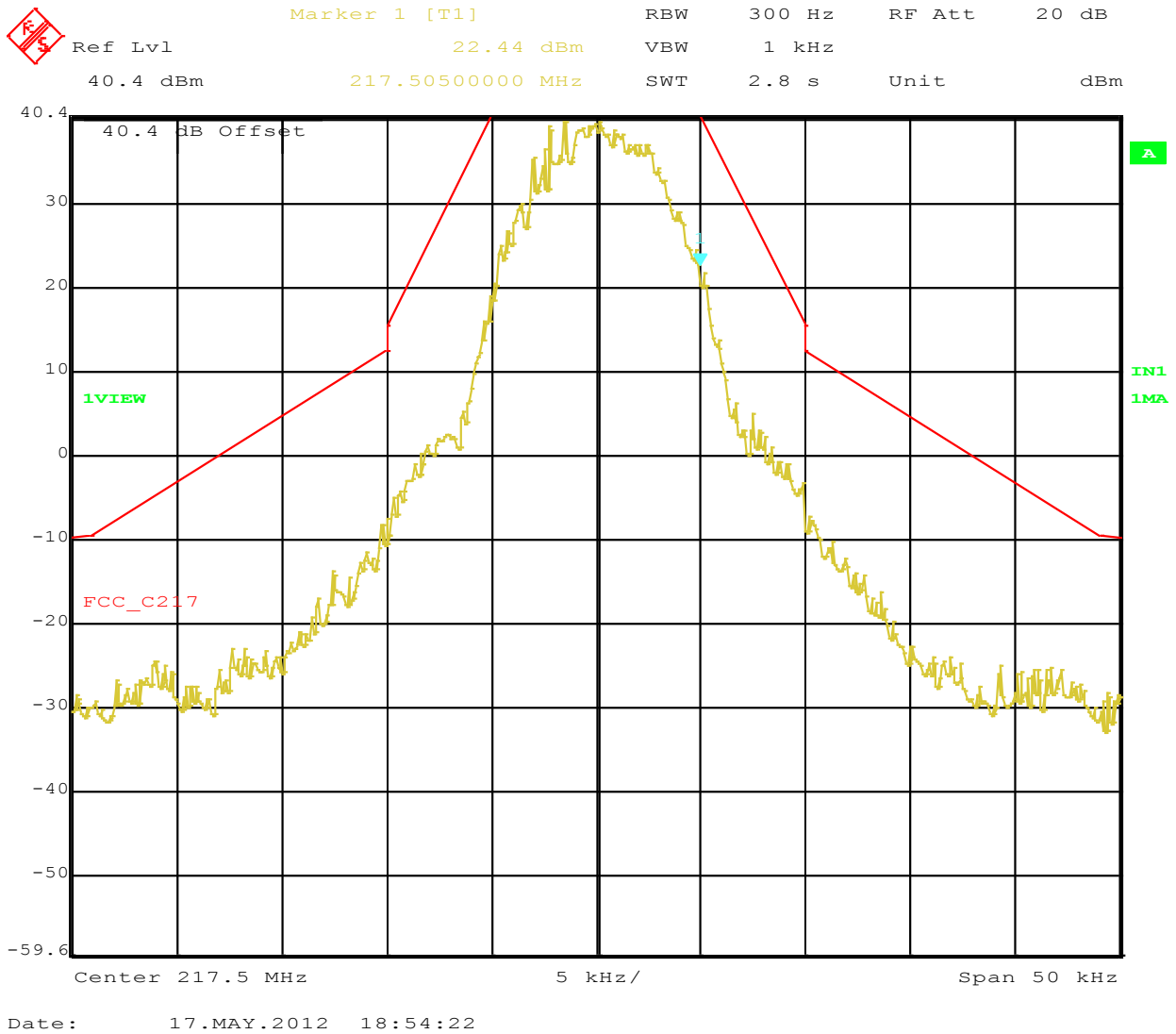
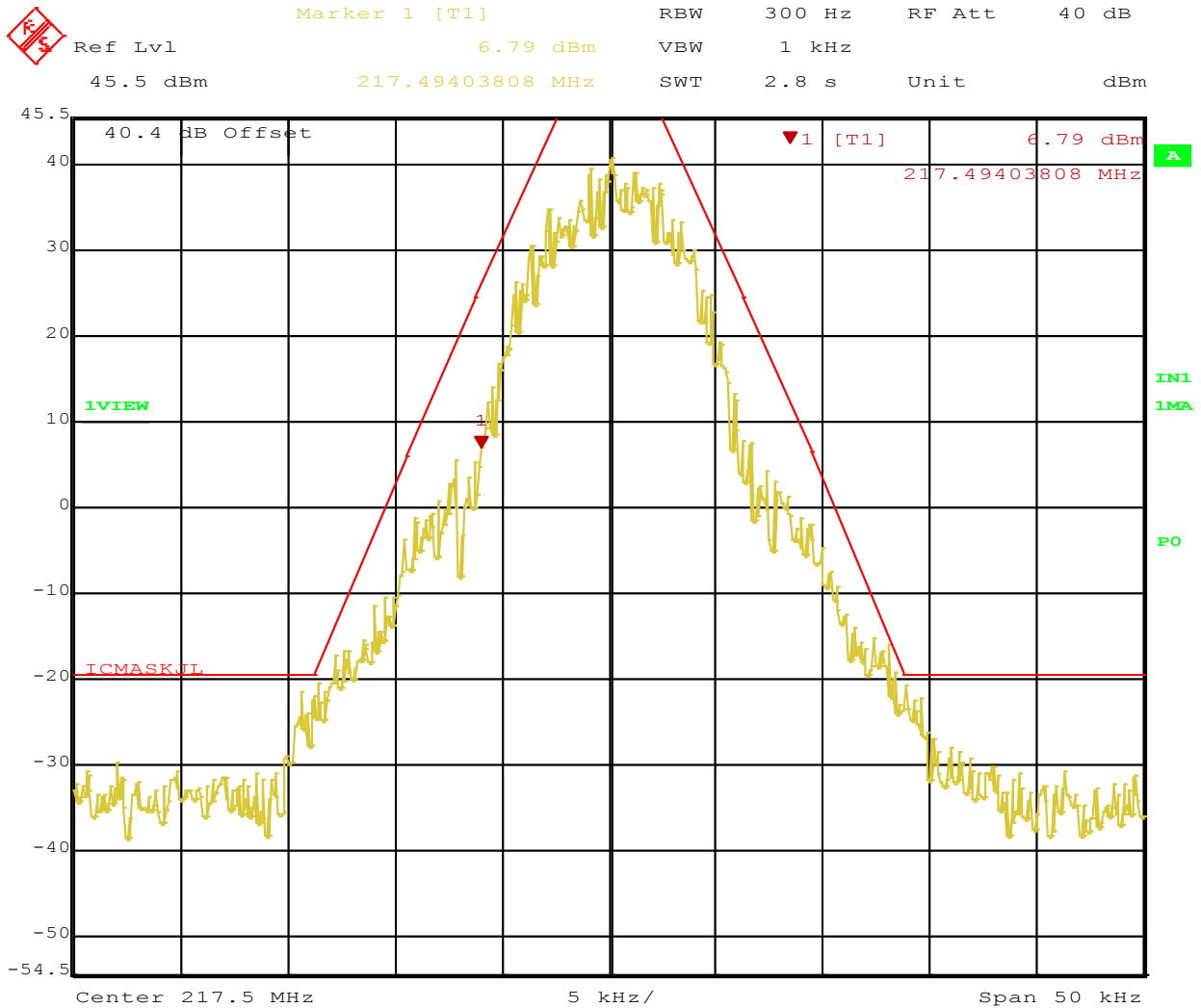

Figure 46: Emission mask C requirement at Operating Channel 217.5 MHz, GMSK

Note: Reference level of spectrum analyzer coincides with highest power level of the EUT. See the CW power and modulated signal captured in Figure #52



Title: Mask 217.5 GMSK9600 Powersetting full power
 Date: 29.FEB.2012 13:57:35

Note: Reference level adjusted to measured unmodulated power level

Figure 47: Emission mask J Requirement at Operating Channel 217.5 MHz, GMSK

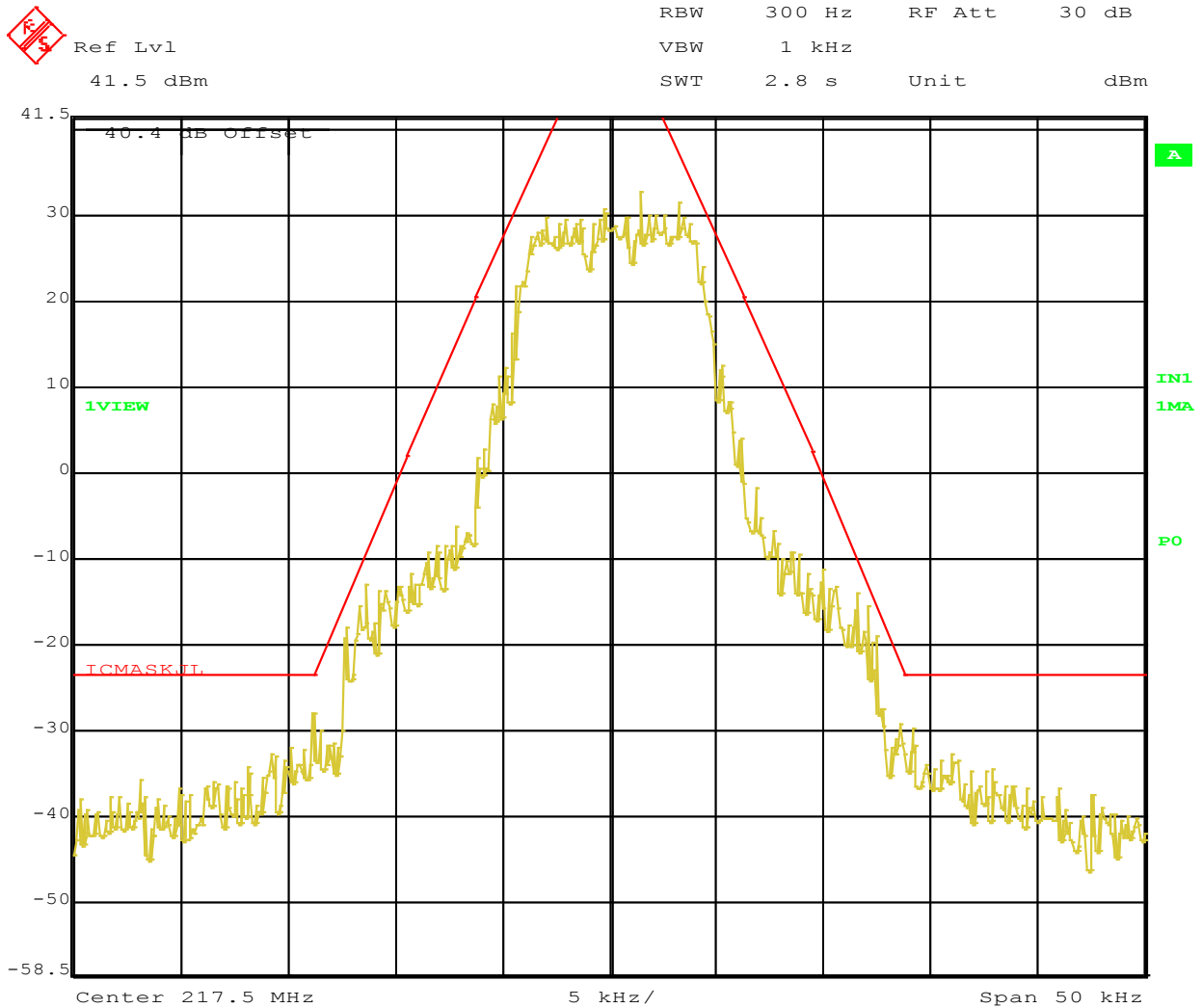

Title: QPSK 16K Power setting Att 7
 Date: 29.FEB.2012 13:36:24

Figure 48: Emission mask J Requirement at Operating Channel 217.5 MHz, 16 QPSK

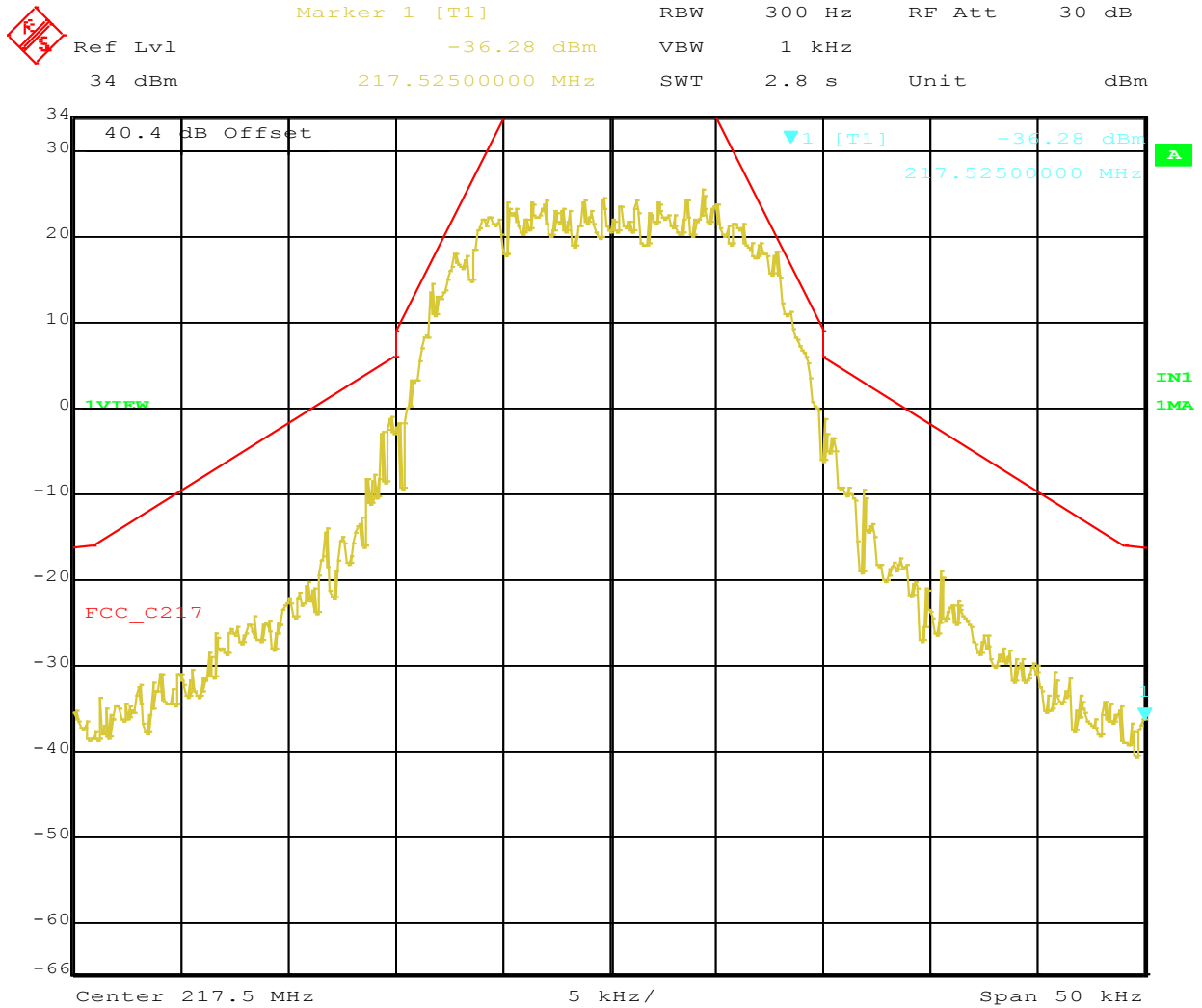

Date: 24.APR.2012 15:07:44

Figure 49: Emission mask C Requirement at Operating Channel 217.5 MHz, 32 QPSK (2 Channel Aggregation)

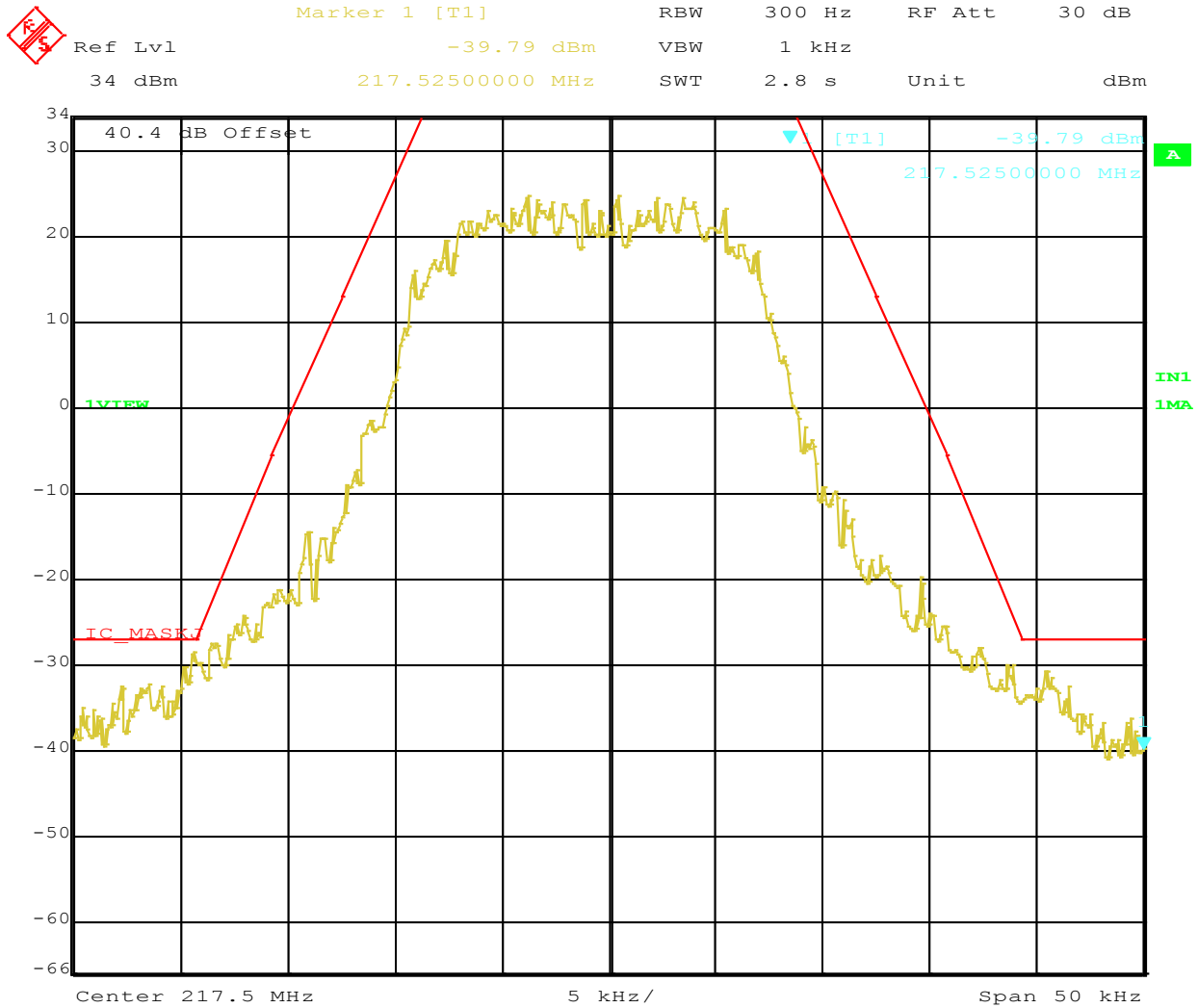

Date: 24.APR.2012 14:21:31

Figure 50: Emission mask J Requirement at Operating Channel 217.5 MHz, 32 QPSK (2 Channel Aggregation)

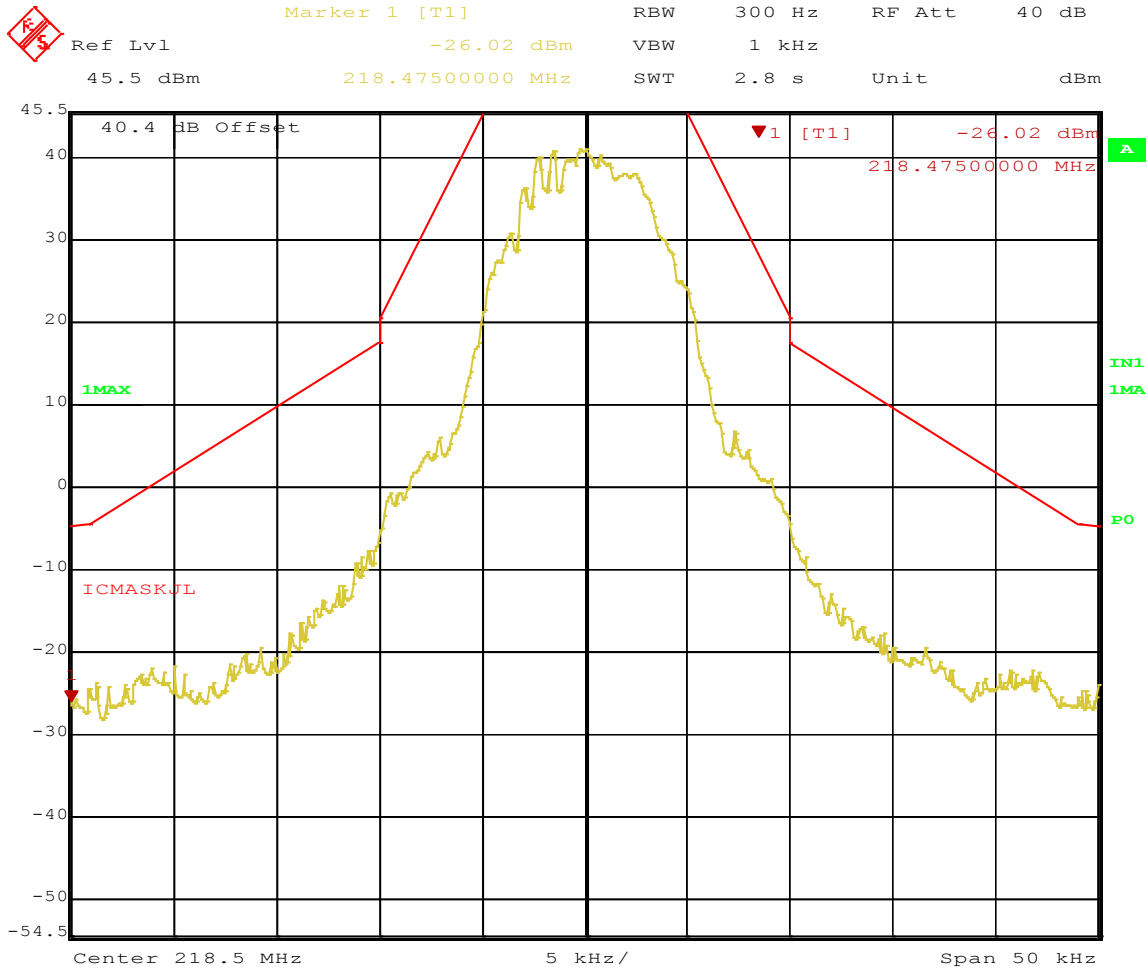

Title: Mask 218.5 GMSK9600 Powersetting full power
 Date: 29.FEB.2012 15:48:44

Figure 51: Emission mask C Requirement at Operating Channel 218.5 MHz, GMSK

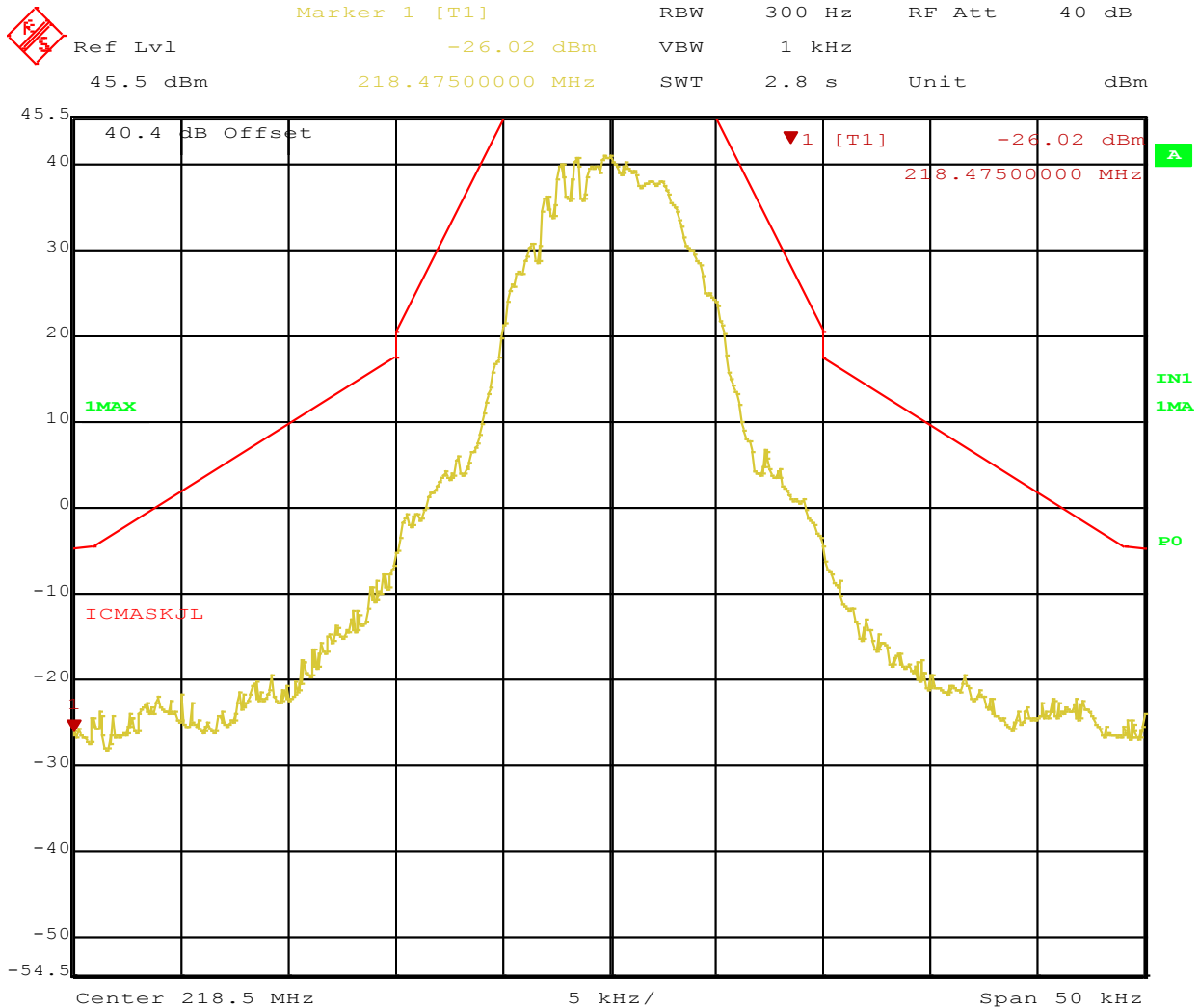

Title: Mask 218.5 GMSK9600 Powersetting full power
 Date: 29.FEB.2012 15:48:44

Figure 52: Emission mask C Requirement at Operating Channel 218.5 MHz, 16 QPSK

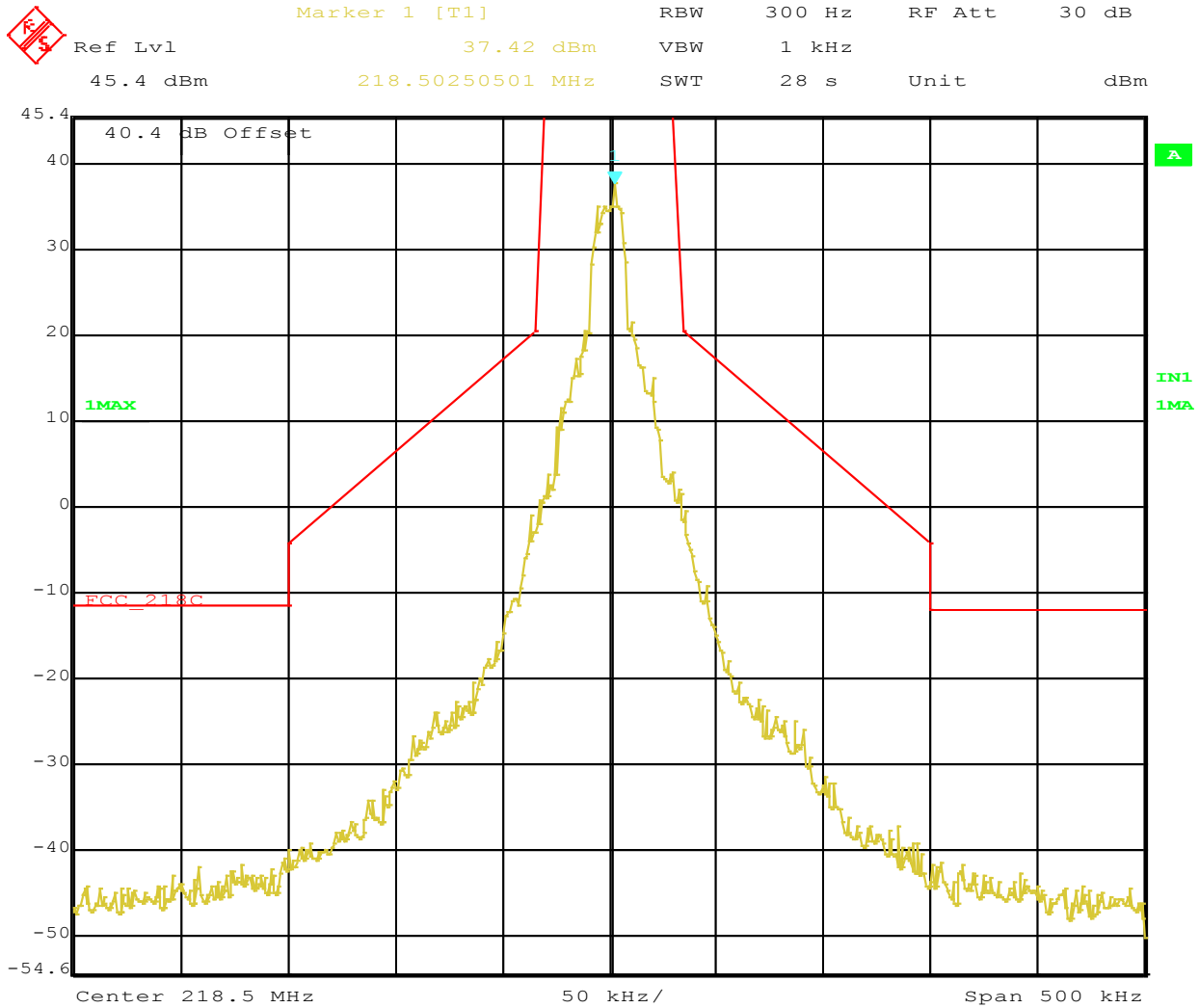

Date: 18.MAY.2012 14:06:08

Figure 53: Emission mask C Requirement at Operating Channel 218.5 MHz, 32 QPSK (2 Channel Aggregation)

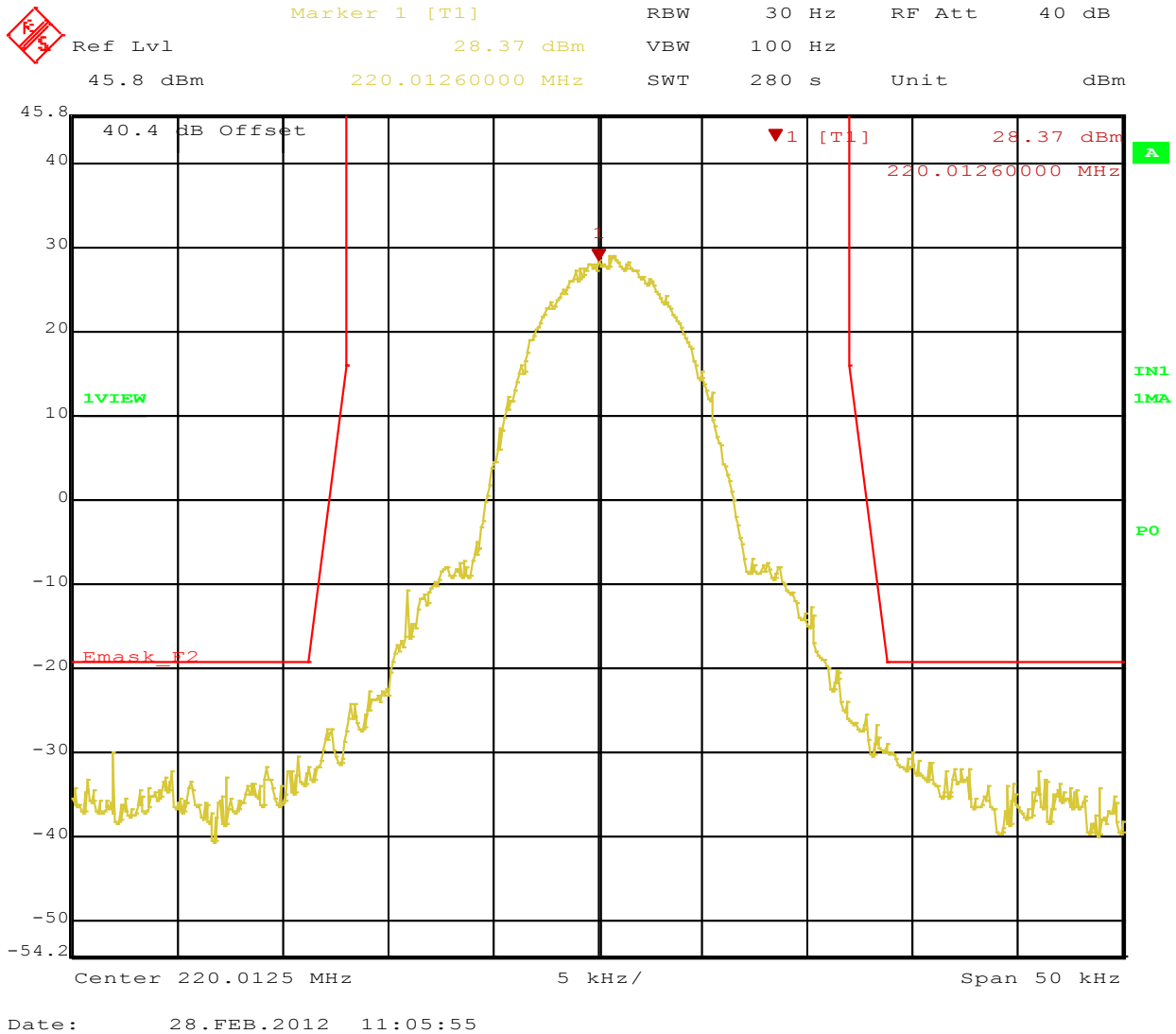

Figure 54: Emission mask F Requirement at Operating Channel 220.0125 MHz, GMSK

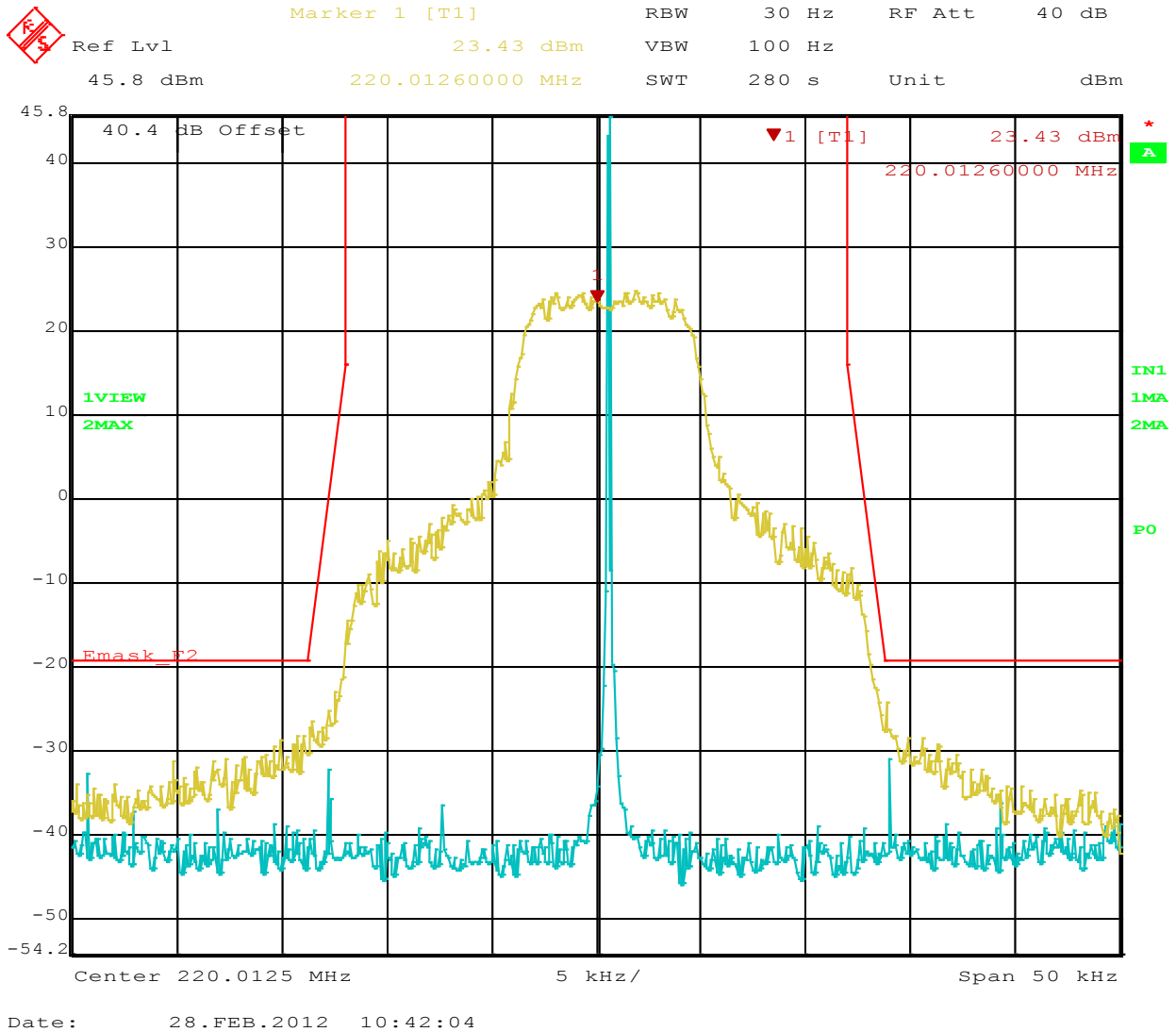
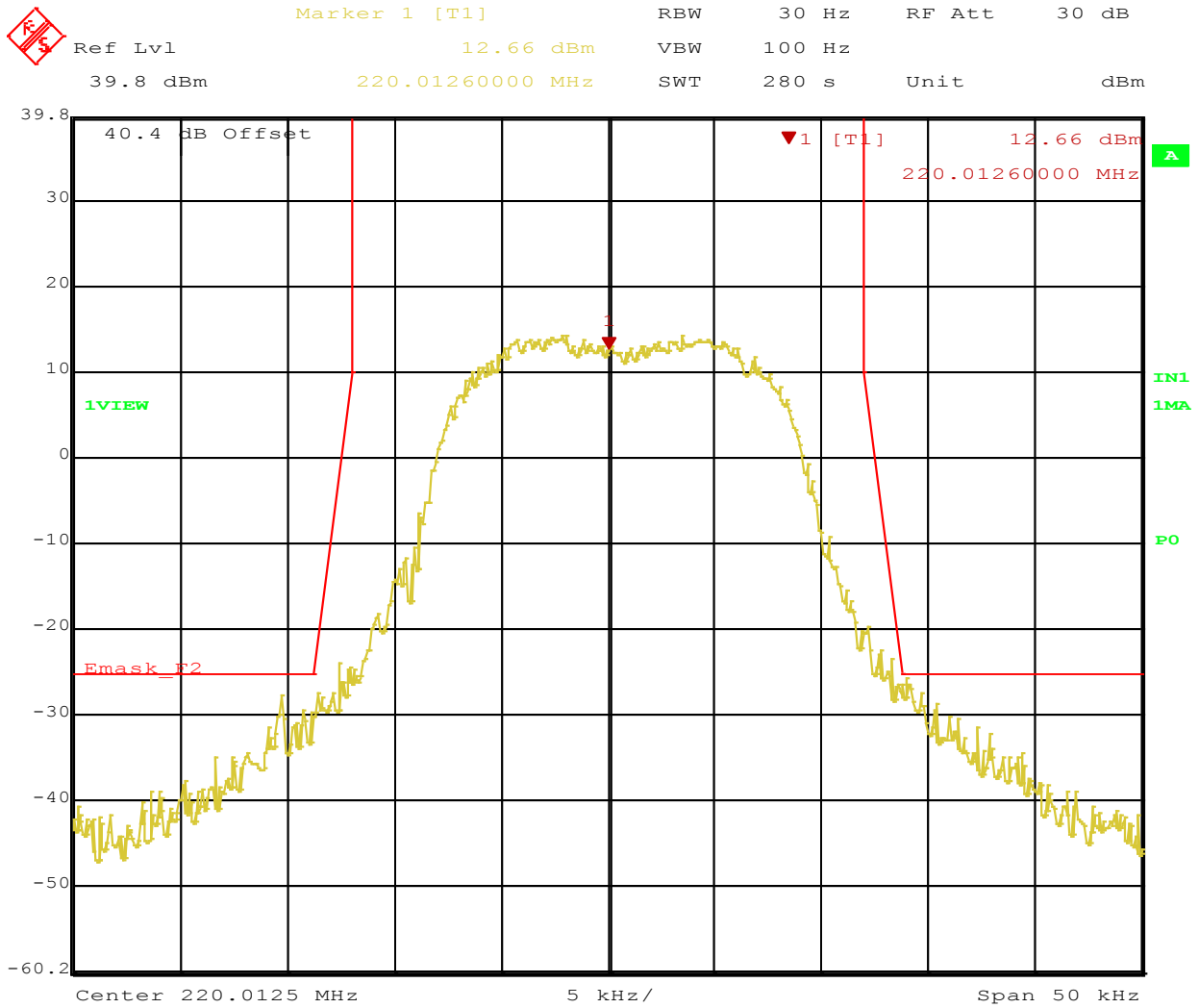
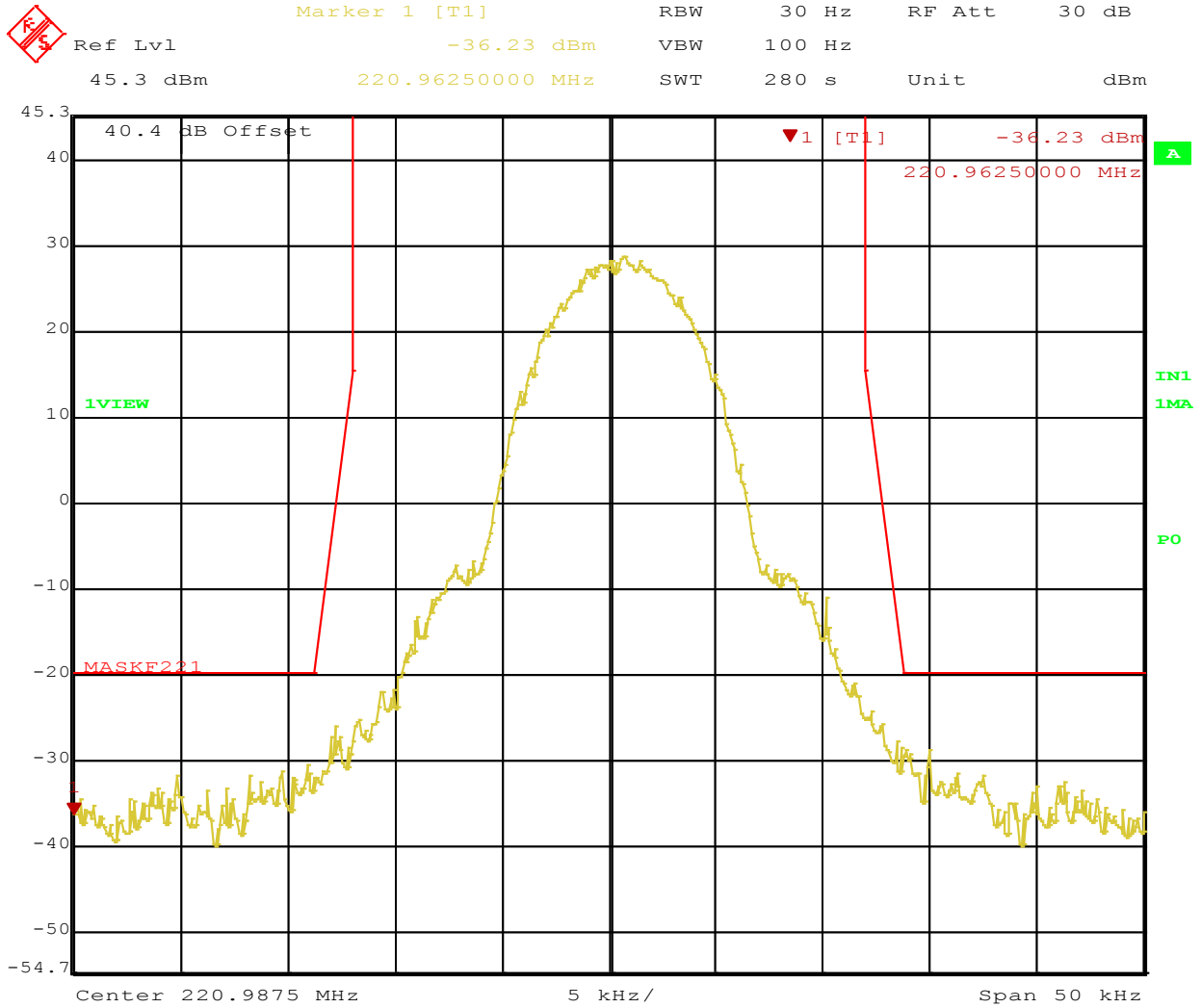

Figure 55: Emission mask F Requirement at Operating Channel 220.0125 MHz, 16 QPSK



Date: 28.FEB.2012 11:21:17

Figure 56: Emission mask F Requirement at Operating Channel 220.0125 MHz, 32 QPSK



Title: GMSK 9600bps High channel Full power
 Date: 28.FEB.2012 14:01:09

Figure 57: Emission mask F Requirement at Operating Channel 220.9875 MHz, GMSK

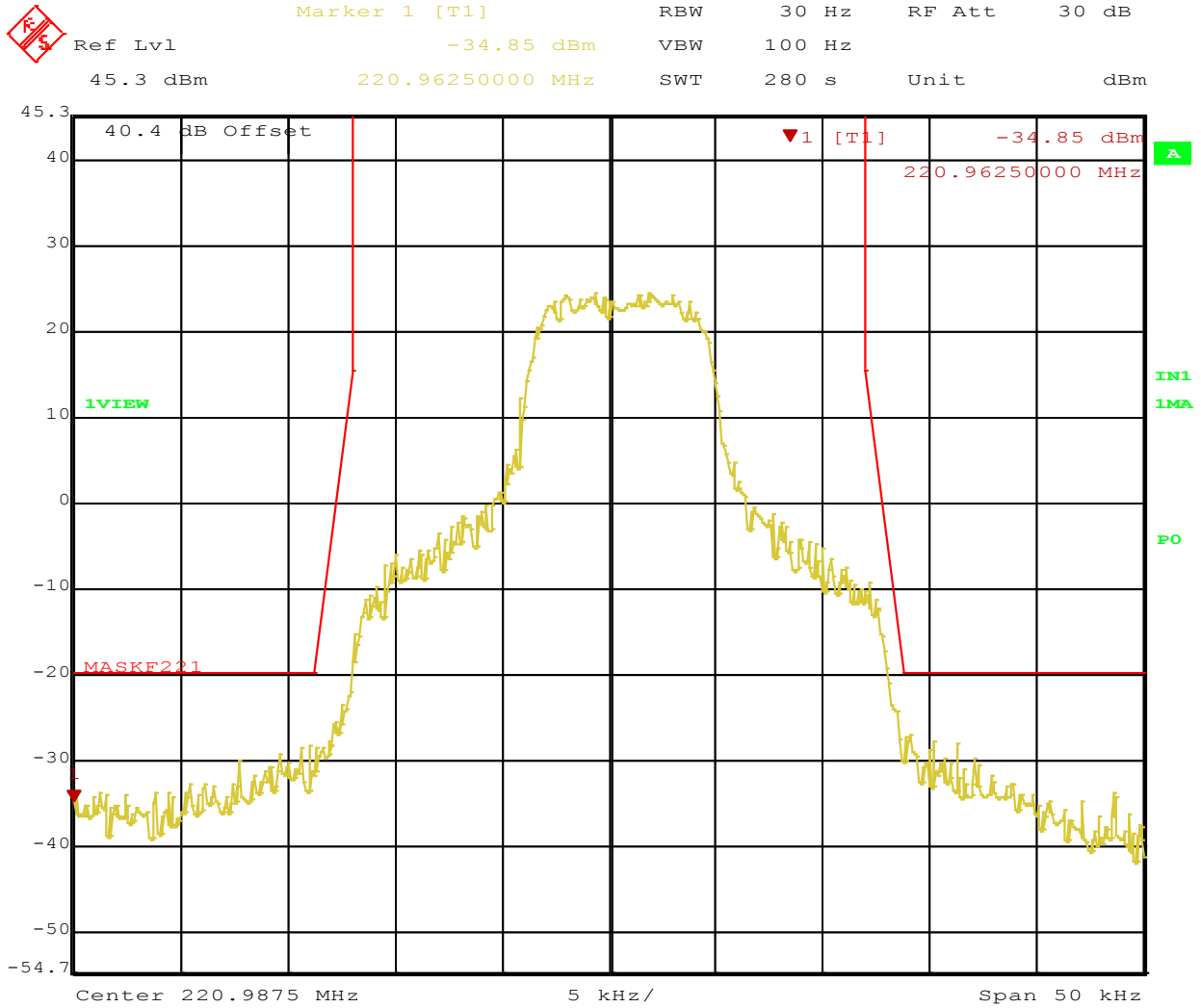

Title: QPSK mid Channel Pset -2
 Date: 28.FEB.2012 13:49:25

Figure 58: Emission mask F Requirement at Operating Channel 220.9875 MHz, 16 QPSK

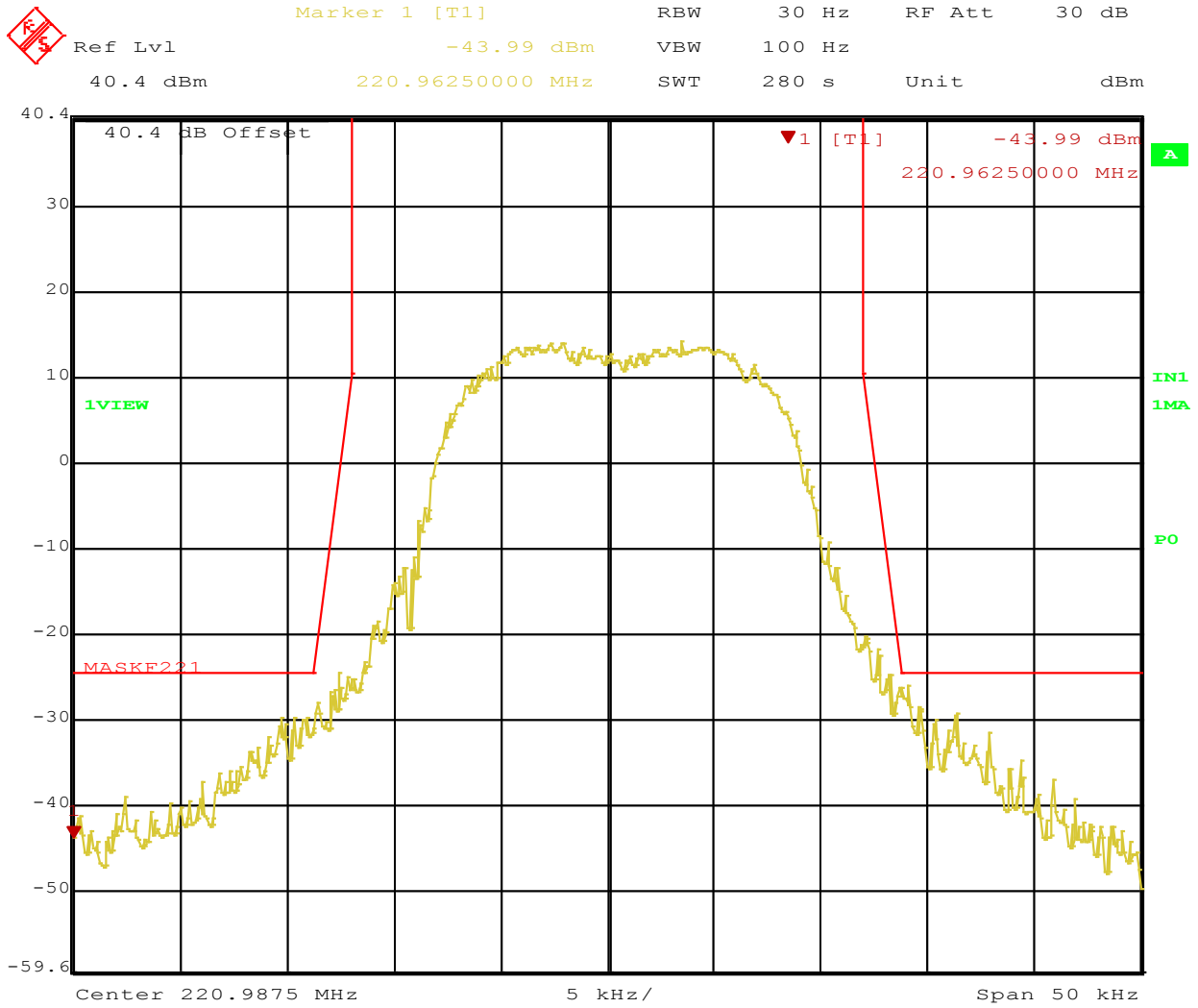

Figure 59: Emission mask F Requirement at Operating Channel 220.9875 MHz, 32 QPSK

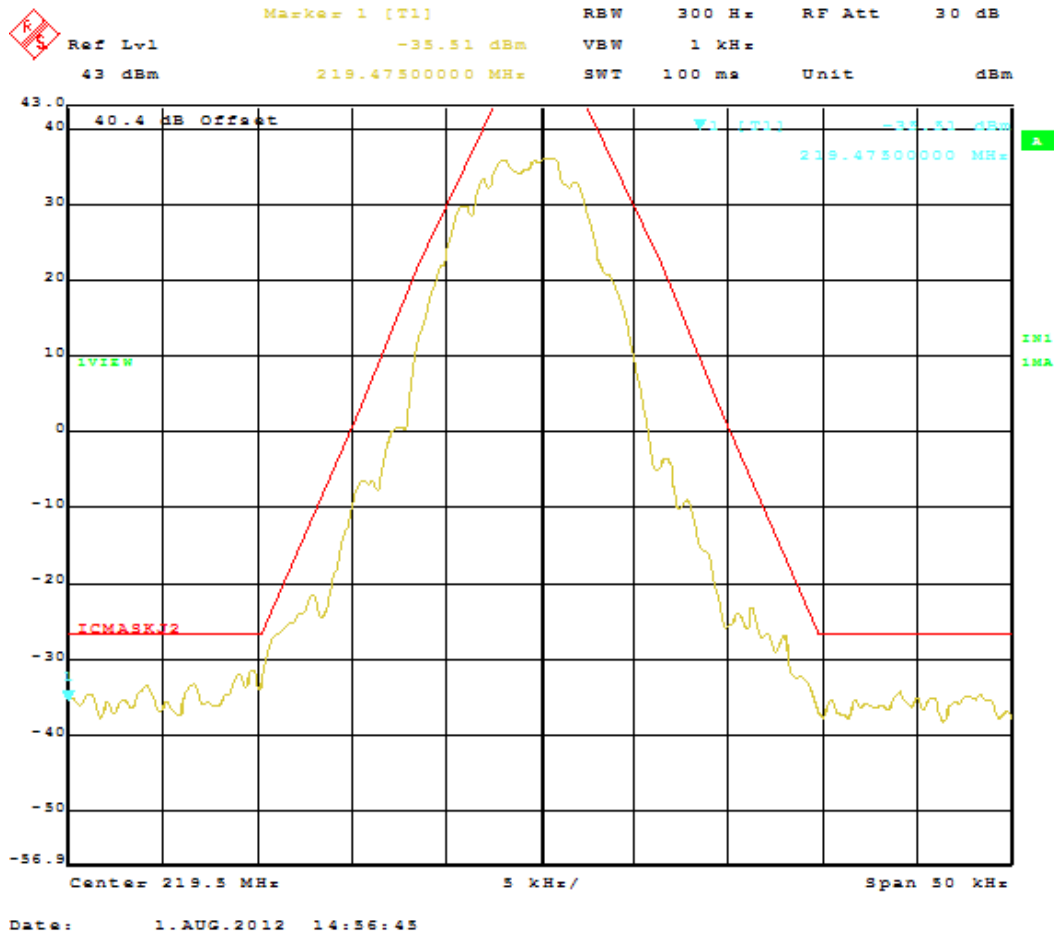

Figure 60: Emission mask J Requirement at Operating Channel 219.5 MHz, GMSK

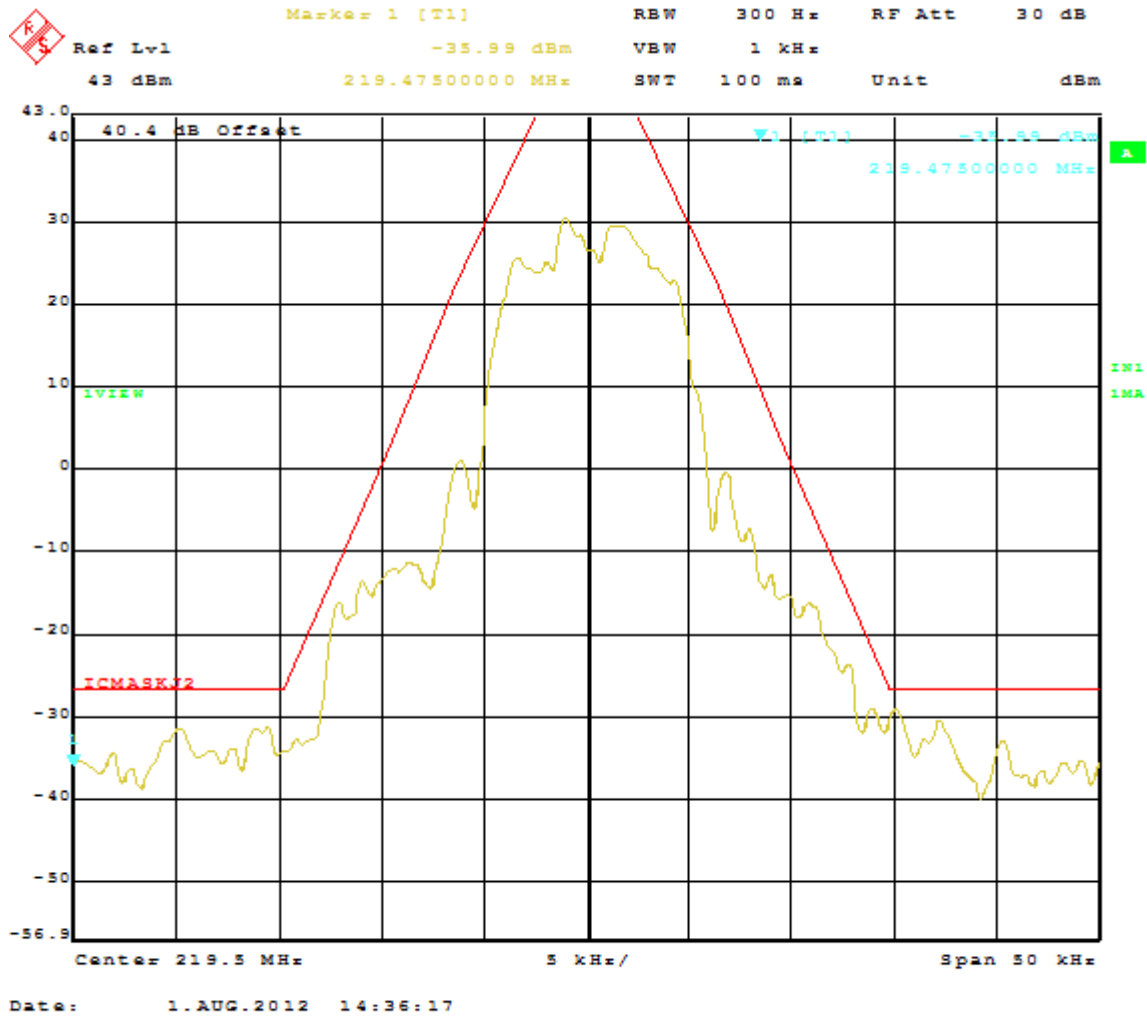

Figure 61: Emission mask J Requirement at Operating Channel 219.5 MHz, 16 QPSK

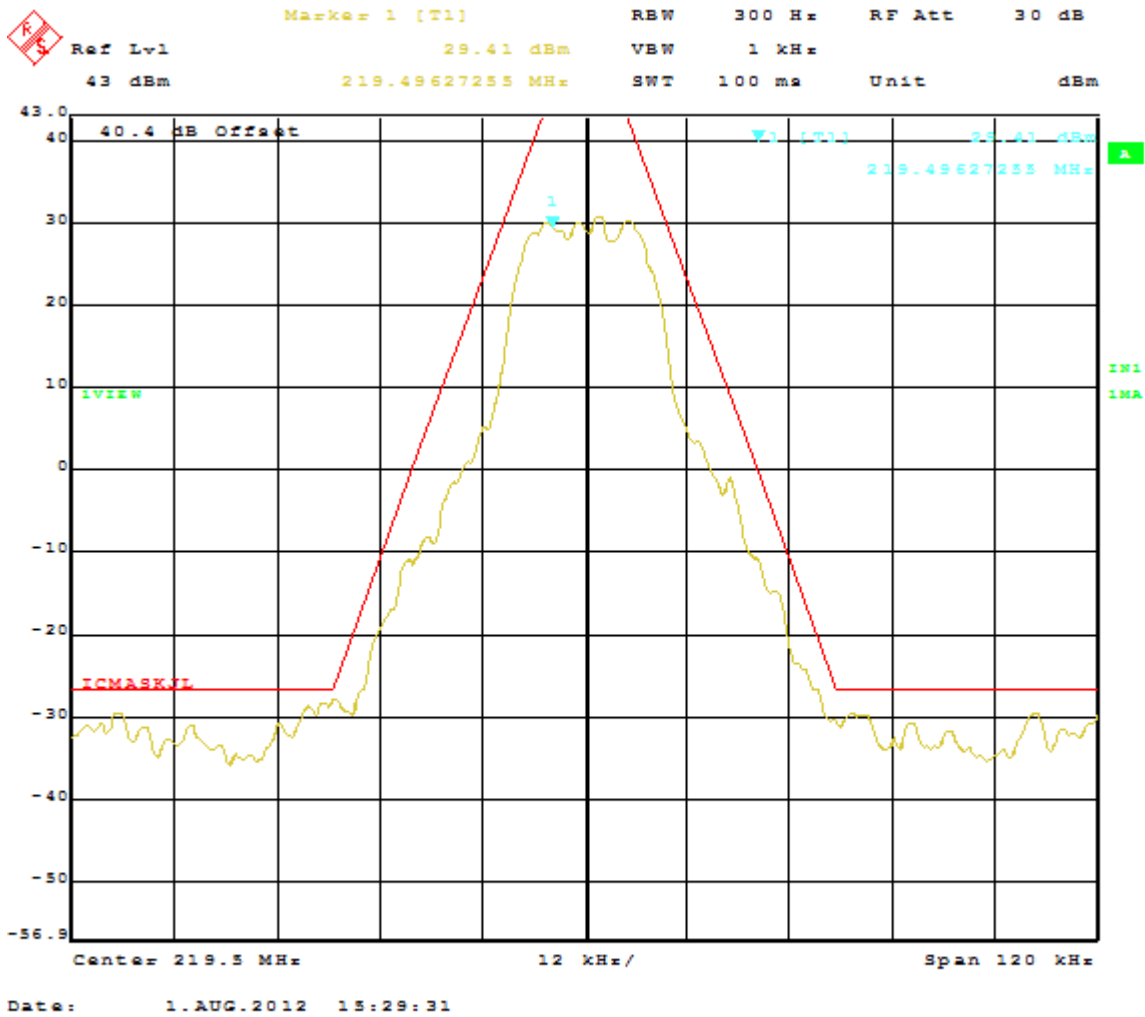

Figure 62: Emission mask J Requirement at Operating Channel 219.5 MHz, 32 QPSK

4.4 Conducted Spurious Emissions

Requirements is same as Emission Mask F as para 4.3 of this report. Any frequency outside the band of 216 MHz to 222 MHz, the power output level must be below -25 dBm

4.4.1 Test Method

The conducted method was used to measure the channel power output per ANSI/TIA-603-C:2004

The measurements were performed 30 MHz to 2.3GHz. Preliminary measurements indicated worst case emissions

The worst-case sample result is recorded below.

Test Setup:

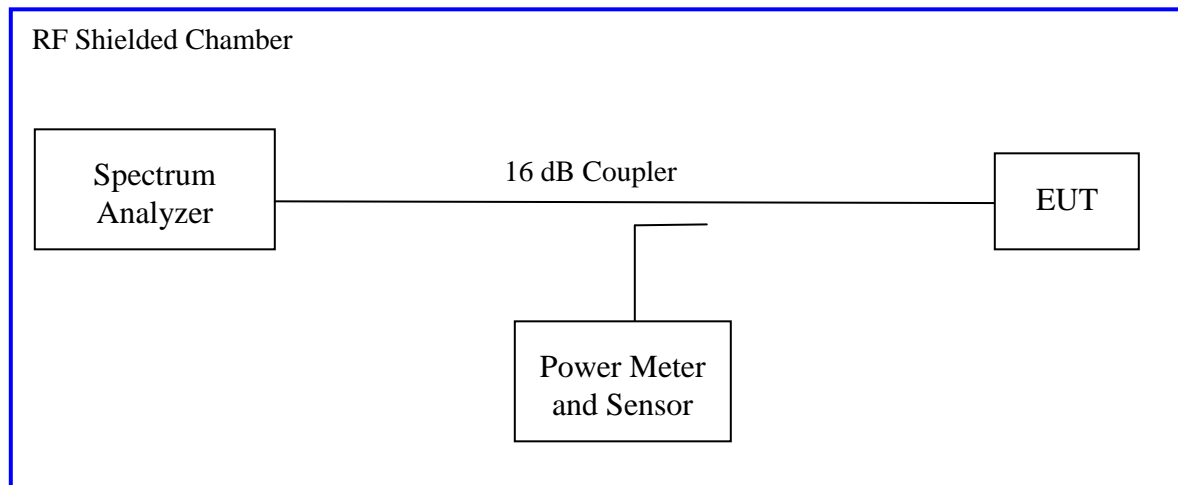

4.4.2 Results

Table 5: Out of band Conducted Emission – Test Results

Operating Freq.	Mode	Result
217.5	GMSK	Pass
	16 QPSK	Pass
	32 QPSK	Pass
218.5	GMSK	Pass
	16 QPSK	Pass
	32 QPSK	Pass
219.5	GMSK	Pass
	16 QPSK	Pass
	32 QPSK	Pass
220.0125	GMSK	Pass
	16 QPSK	Pass
	32 QPSK	Pass
220.9875	GMSK	Pass
	16 QPSK	Pass
	32 QPSK	Pass
222.00	GMSK	Pass
	16 QPSK	Pass
	32 QPSK	Pass
217.500	Receive	Pass
220.9875	Receive	Pass

Note 1: RSS-119 limits operation to 217-218 and 219-222 MHz.

Note 2: Emission mask C is applicable for frequency band 216 to 220 MHz which give -13dBm as limit for out of band emissions but the worst case limit of Mask F -25 dBm is applied for all plots.

Note 3: No emissions were observed in 1 to 2.3GHz band in preliminary scan, no final plots were taken with required RBW of 1MHz.

Note 4: Out of band emission plots for 219.5 MHz in figures 93 - 96

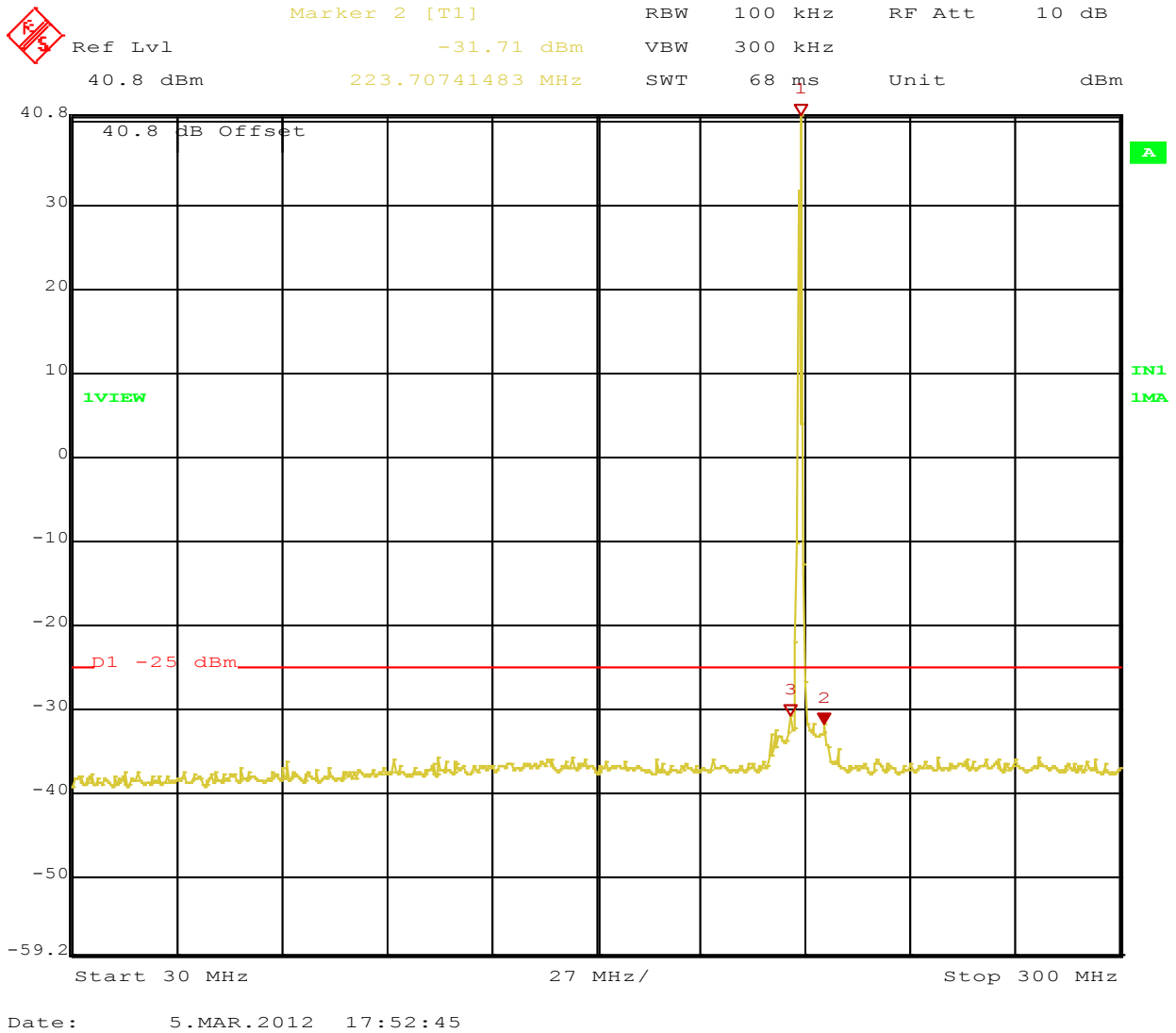
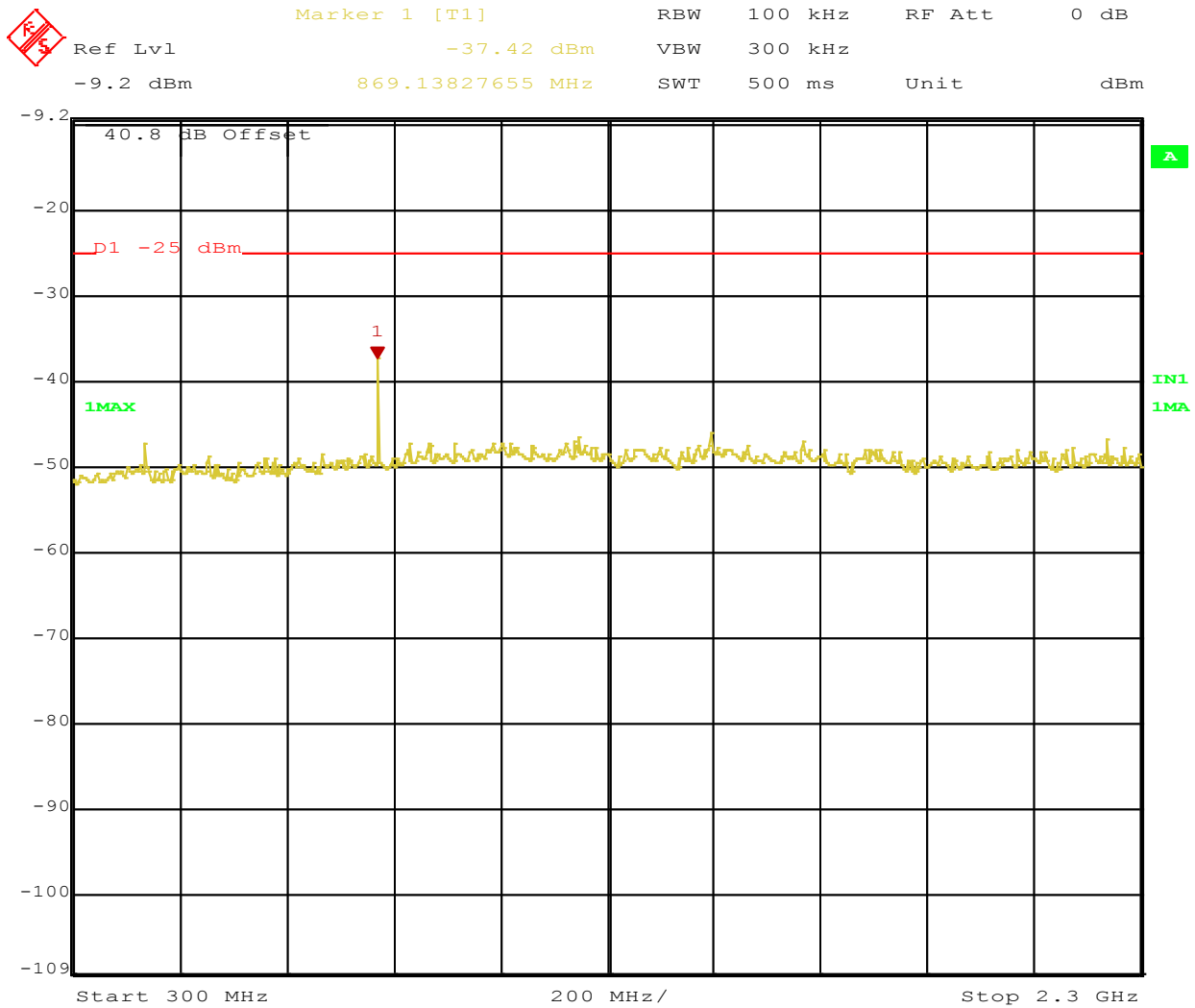

Figure 63: Out of Band Emissions Operating Channel 217.5 MHz, GMSK Plot1



Date: 5.MAR.2012 17:26:29

Figure 64: Out of Band Emissions Operating Channel 217.5 MHz, GMSK Plot 2

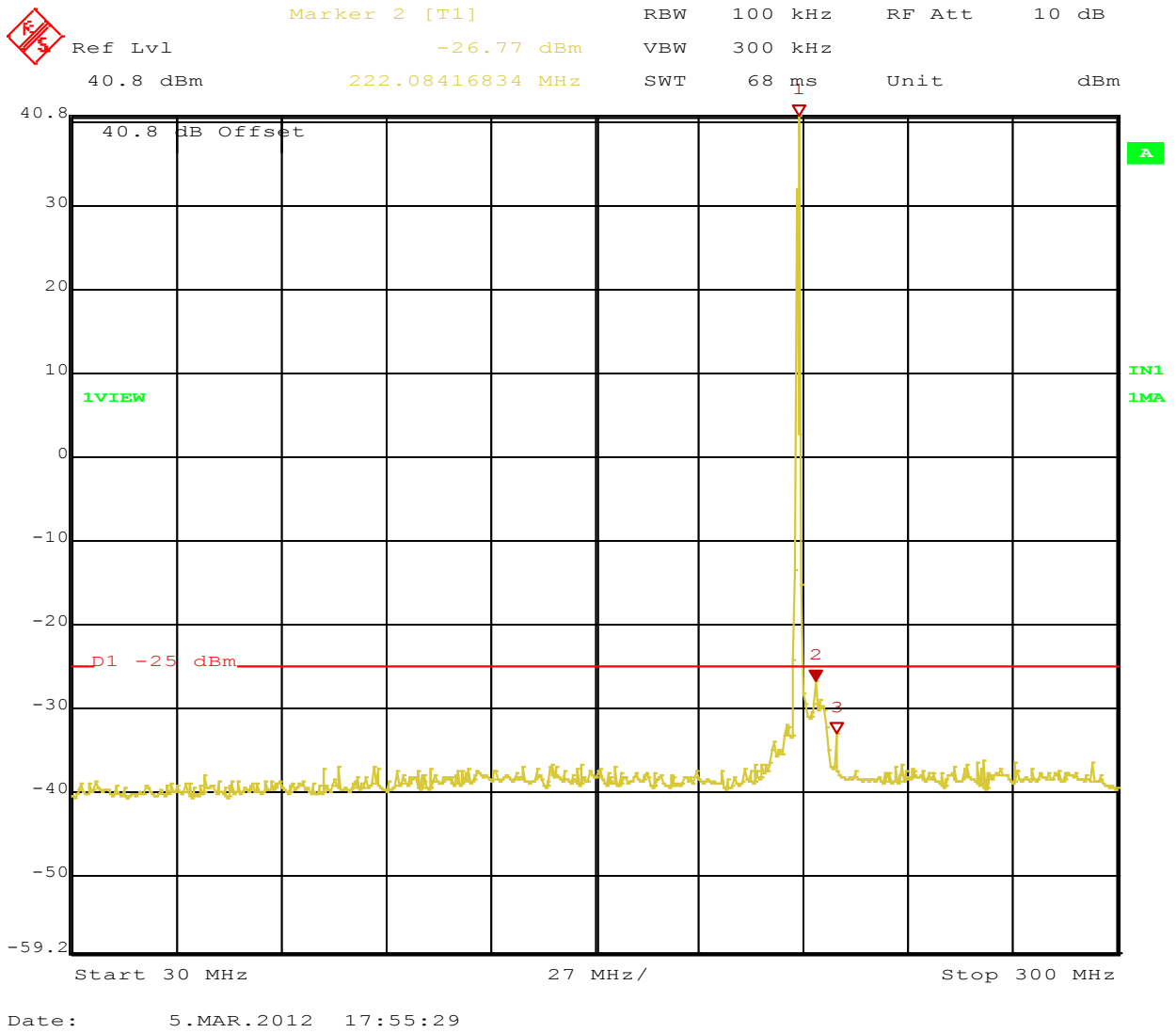
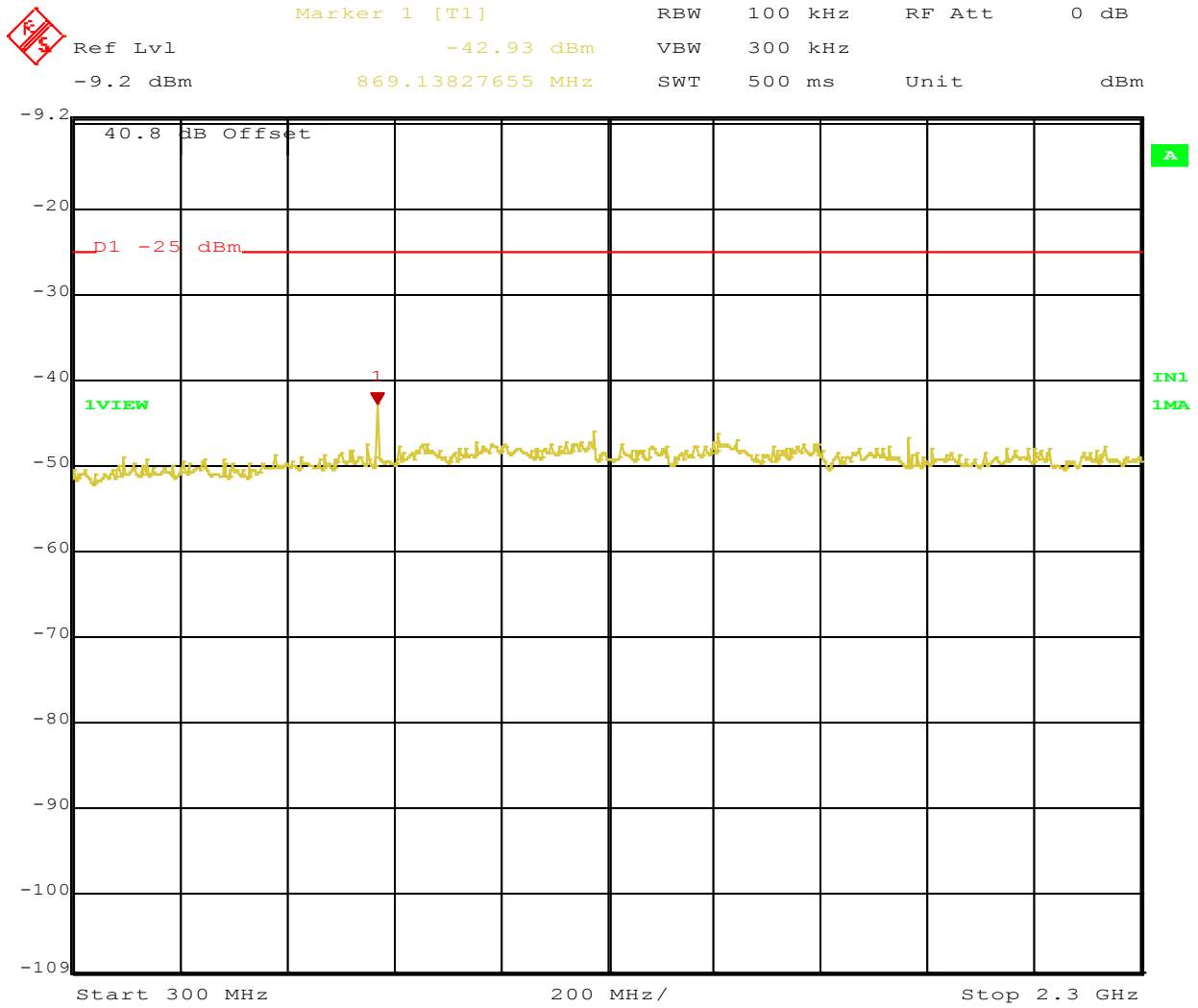

Figure 65: Out of Band Emissions Operating Channel 217.5 MHz, 16 QPSK Plot 1



Date: 5.MAR.2012 17:18:49

Figure 66: Out of Band Emissions Operating Channel 217.5 MHz, 16 QPSK Plot 2

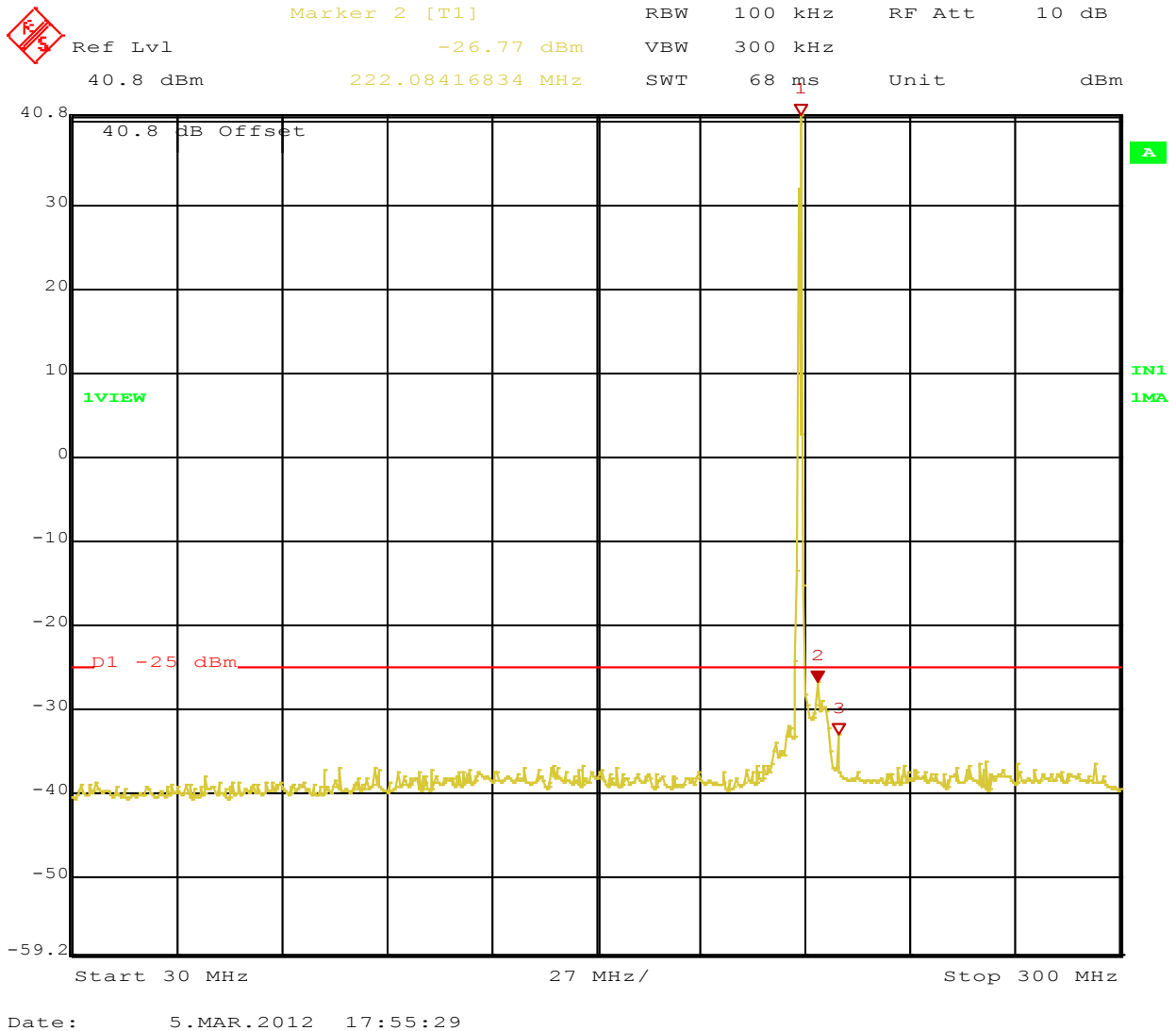
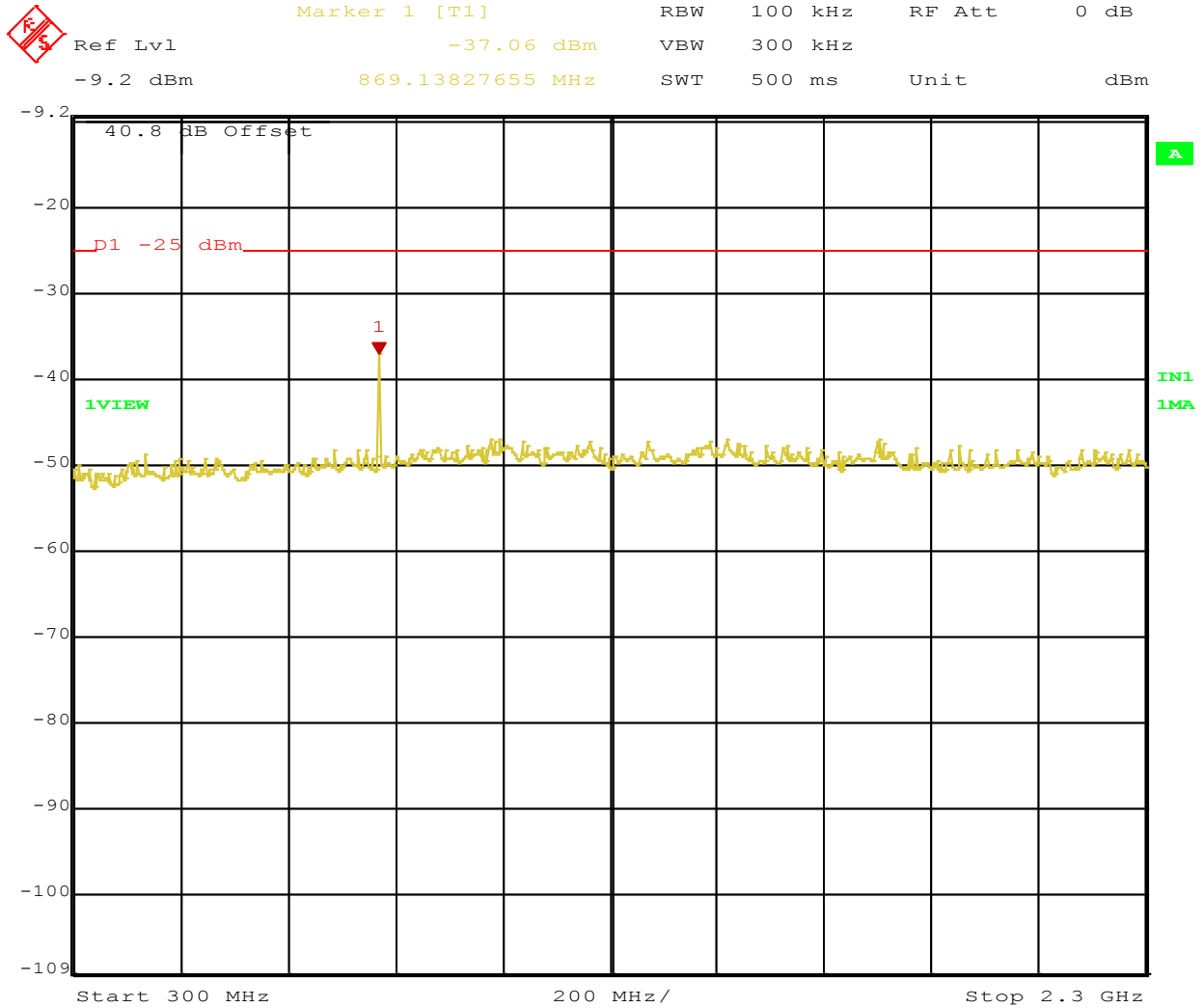

Figure 67: Out of Band Emissions Operating Channel 217.5 MHz, 32 QPSK Plot 1



Date: 5.MAR.2012 17:25:04

Figure 68: Out of Band Emissions Operating Channel 217.5 MHz, 32 QPSK Plot 2

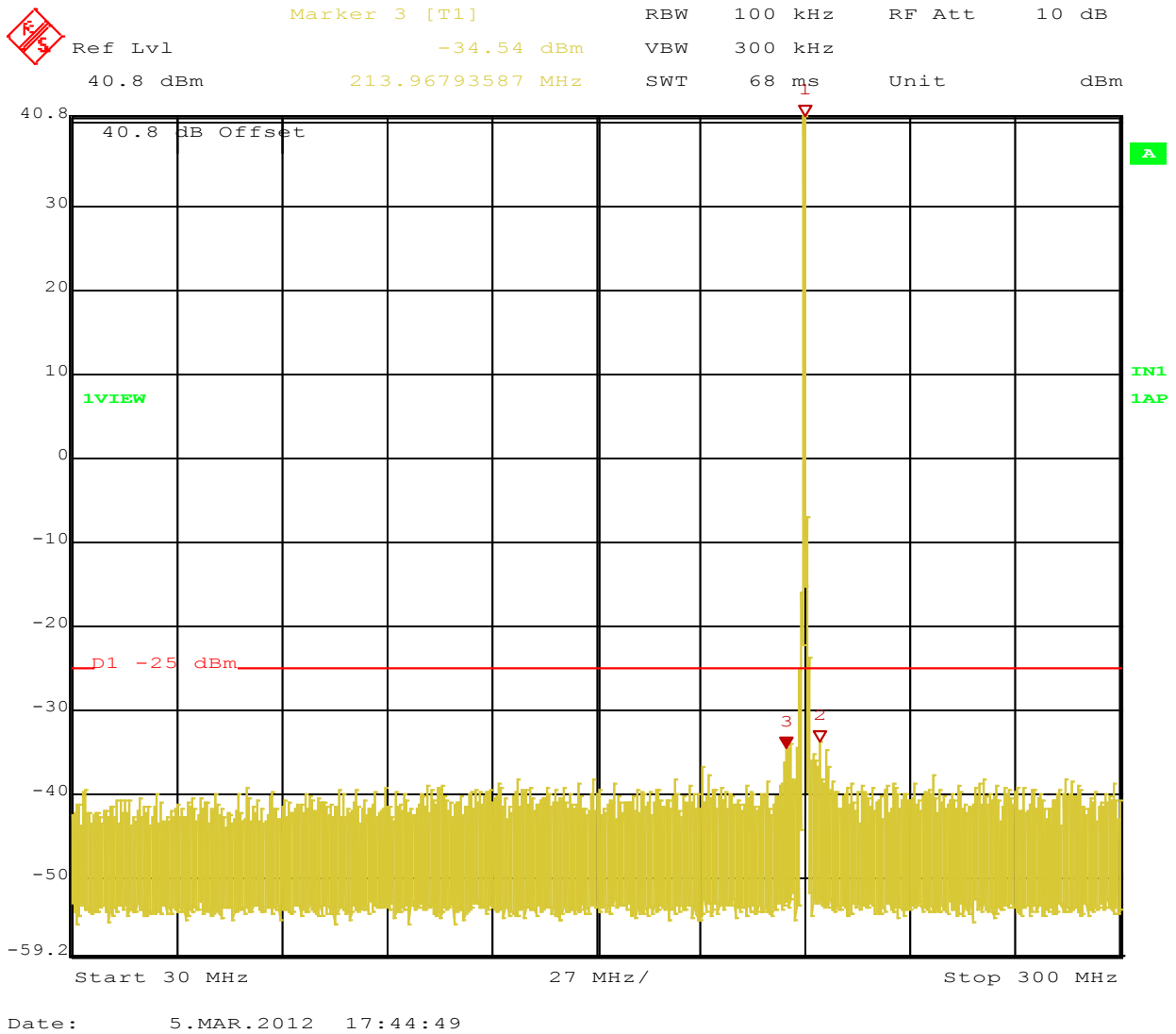

Figure 69: Out of Band Emissions Operating Channel 218.5 MHz, GMSK Plot 1

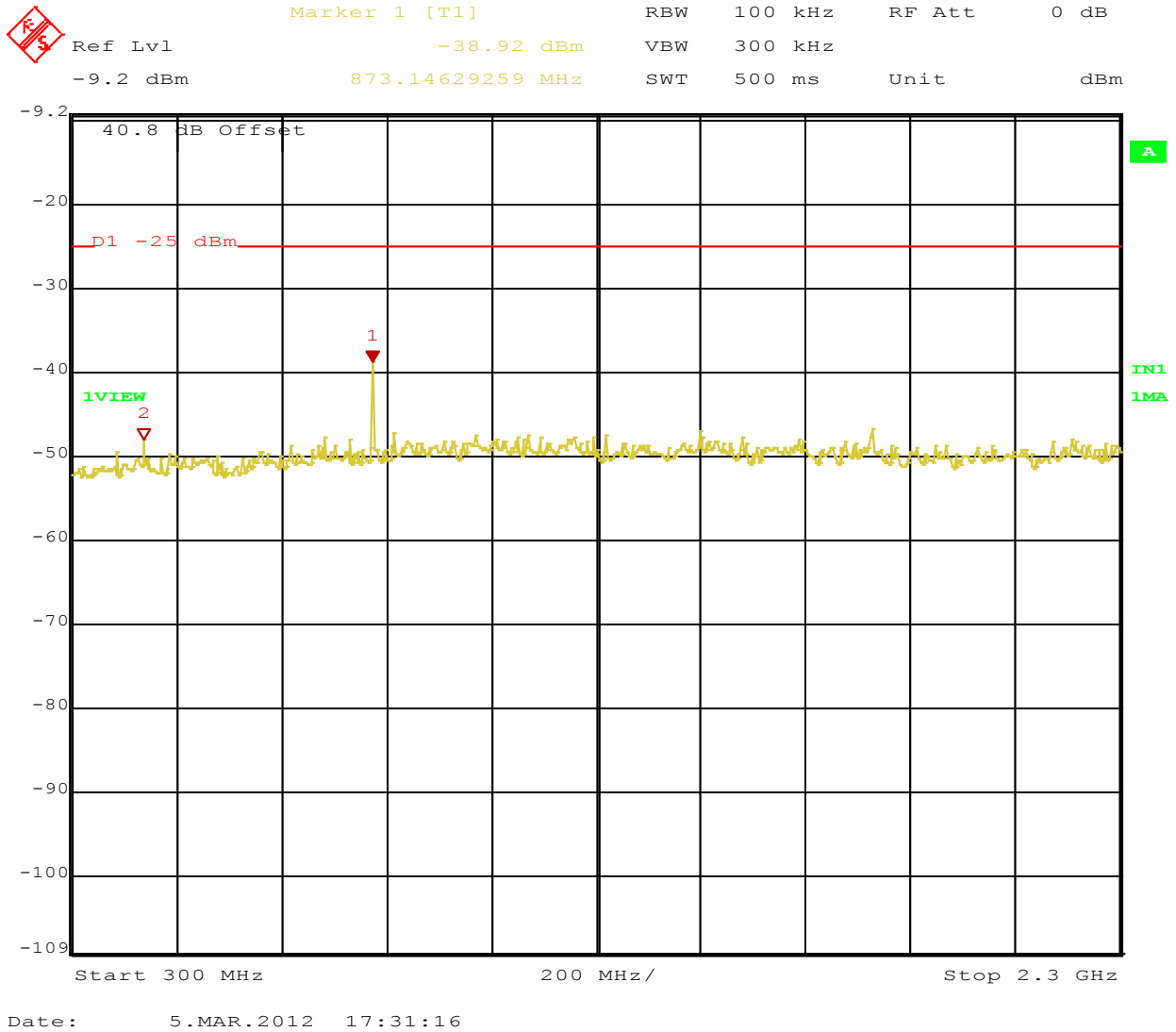

Figure 70: Out of Band Emissions Operating Channel 218.5 MHz, GMSK Plot 2

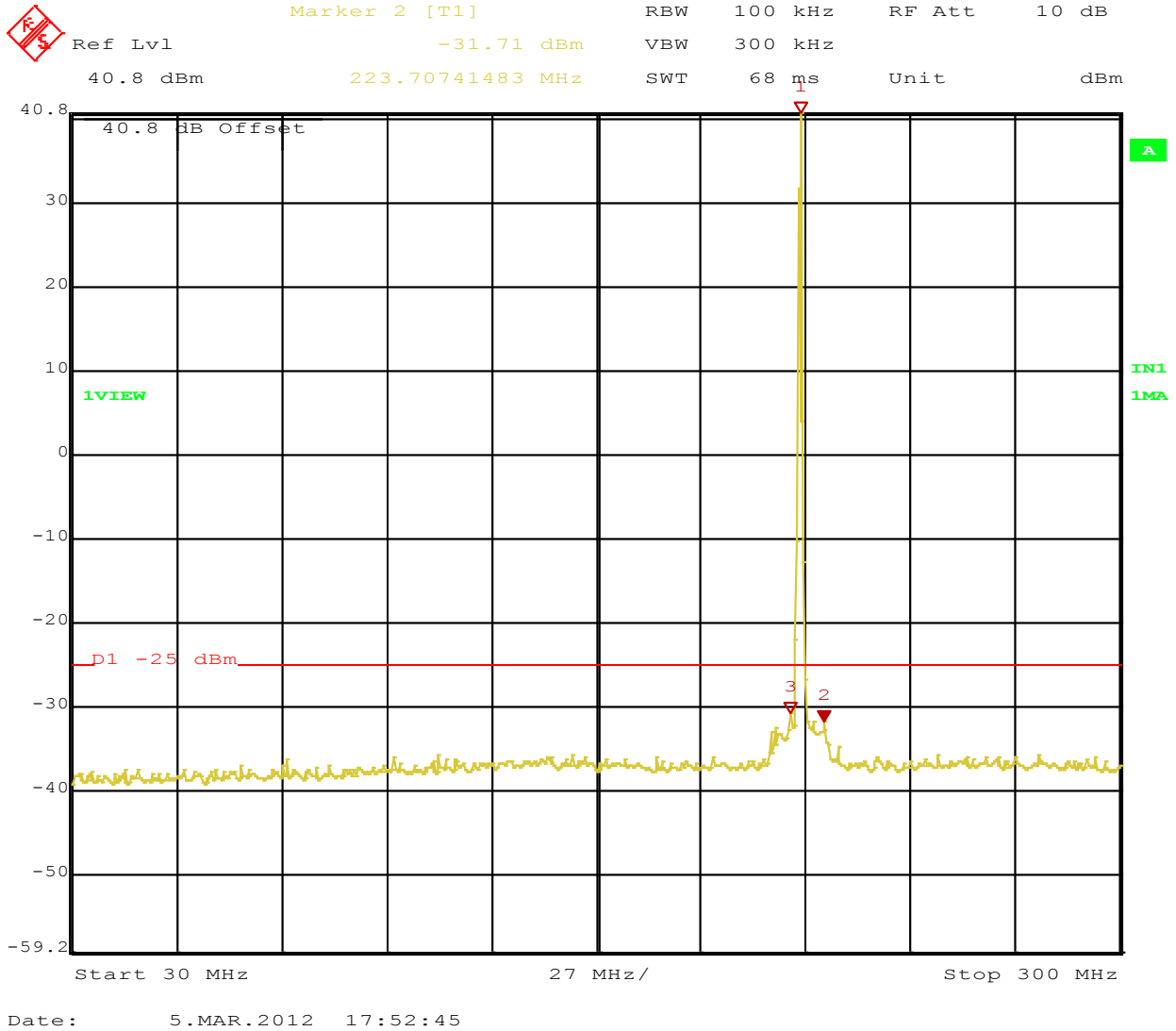
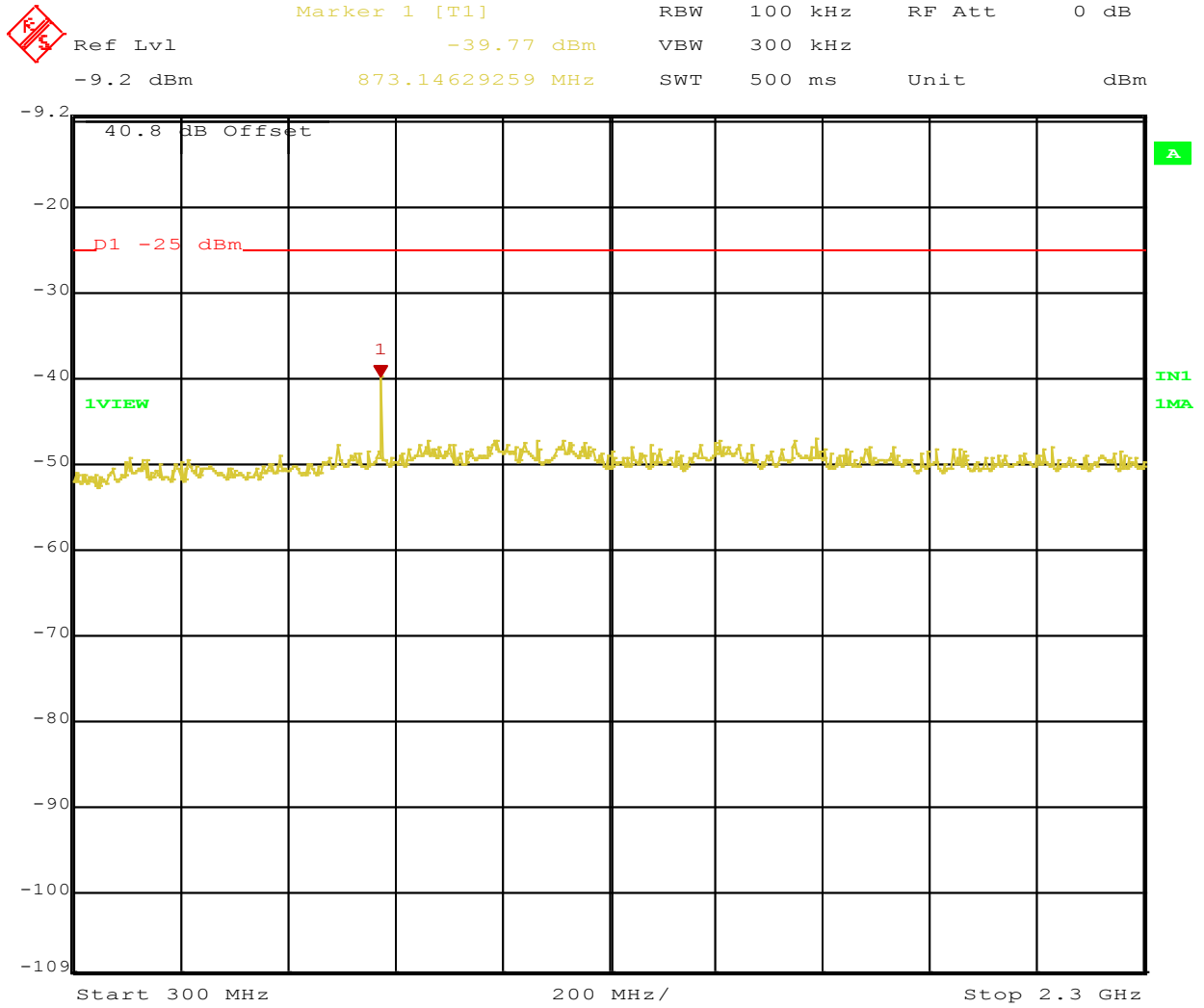

Figure 71: Out of Band Emissions Operating Channel 218.5 MHz, 16 QPSK Plot 1



Date: 5.MAR.2012 17:11:32

Figure 72: Out of Band Emissions Operating Channel 218.5 MHz, 16 QPSK Plot 2

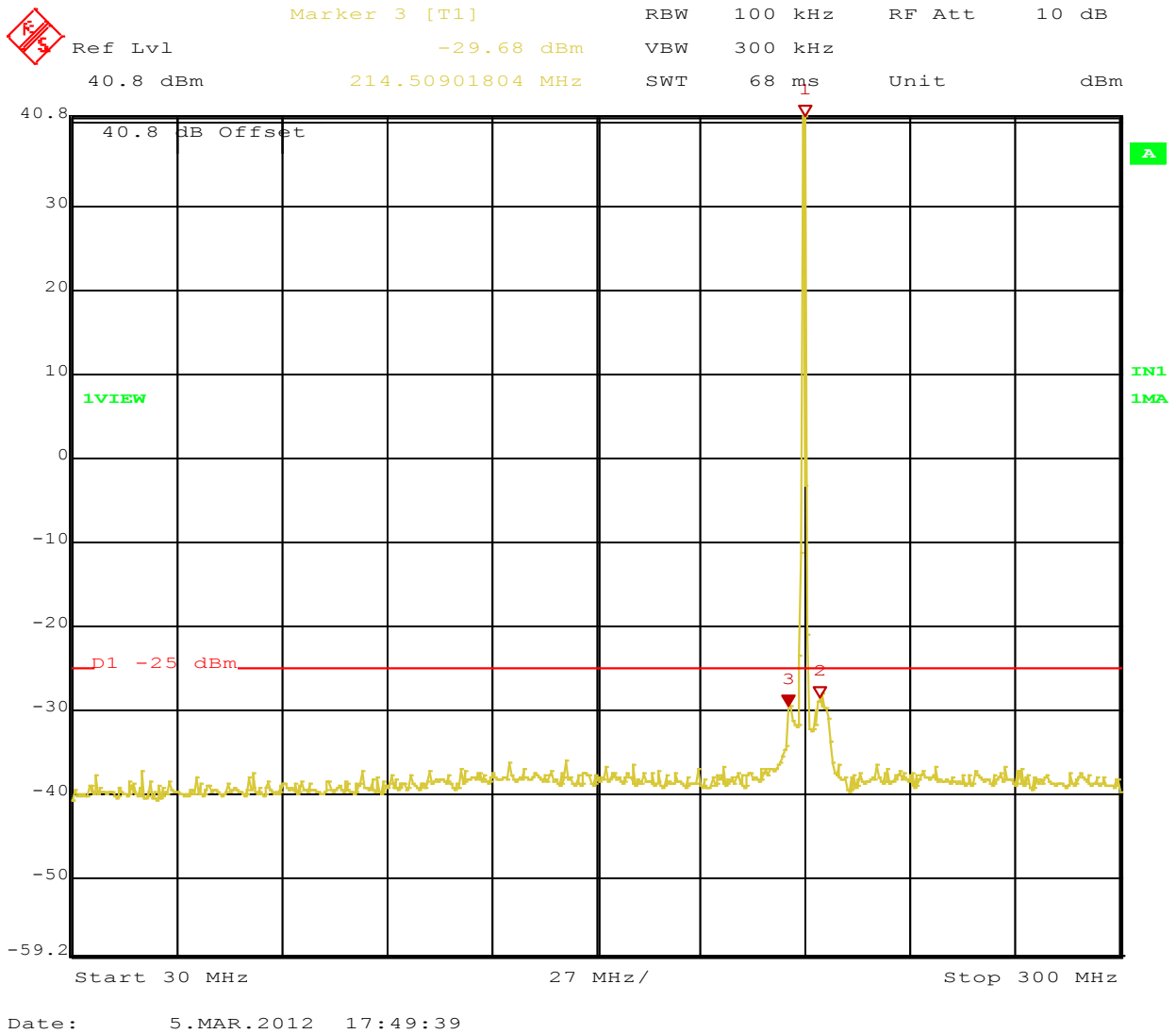

Figure 73: Out of Band Emissions Operating Channel 218.5 MHz, 32 QPSK Plot 1

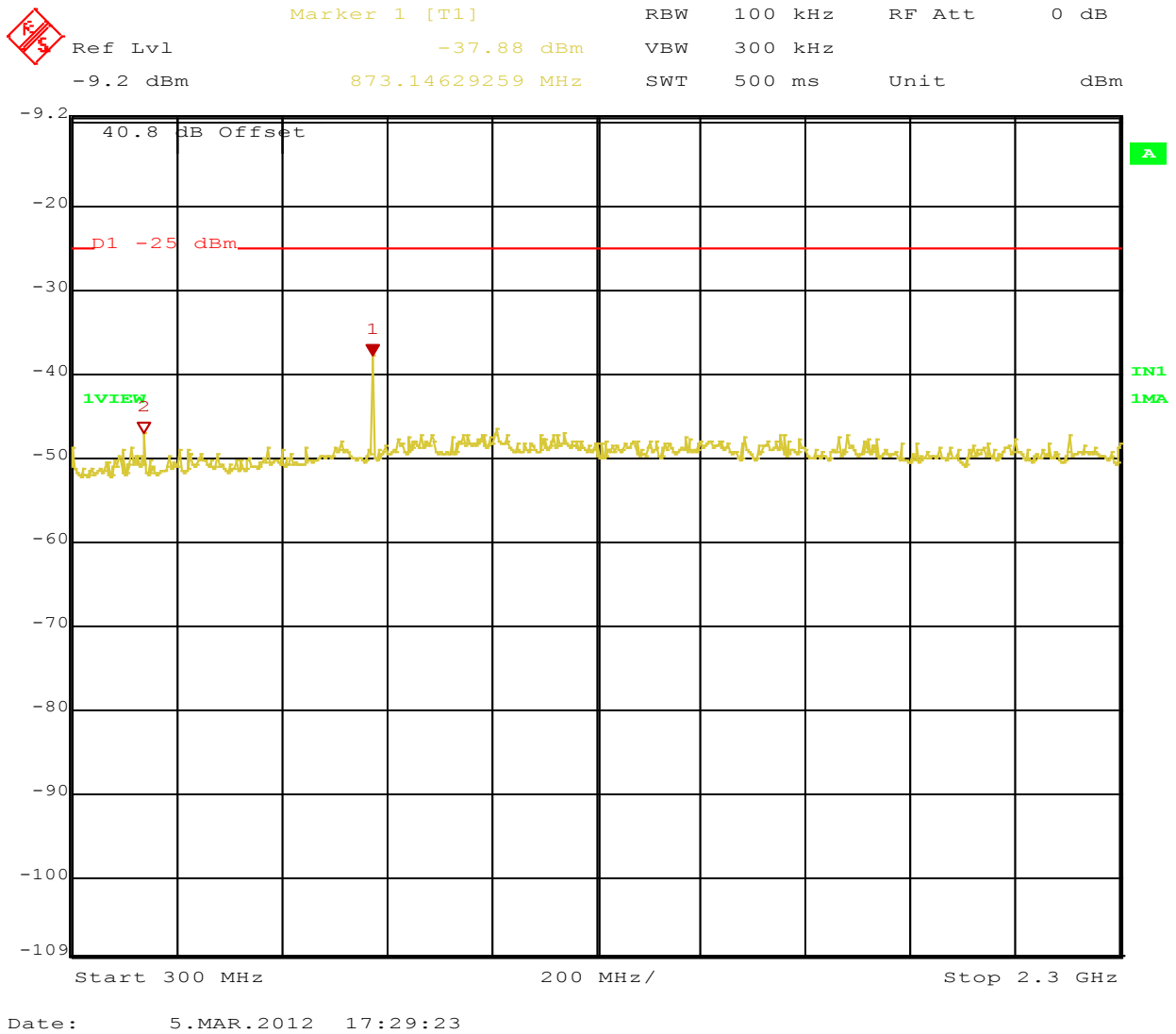

Figure 74: Out of Band Emissions Operating Channel 218.5 MHz, 32 QPSK Plot 2

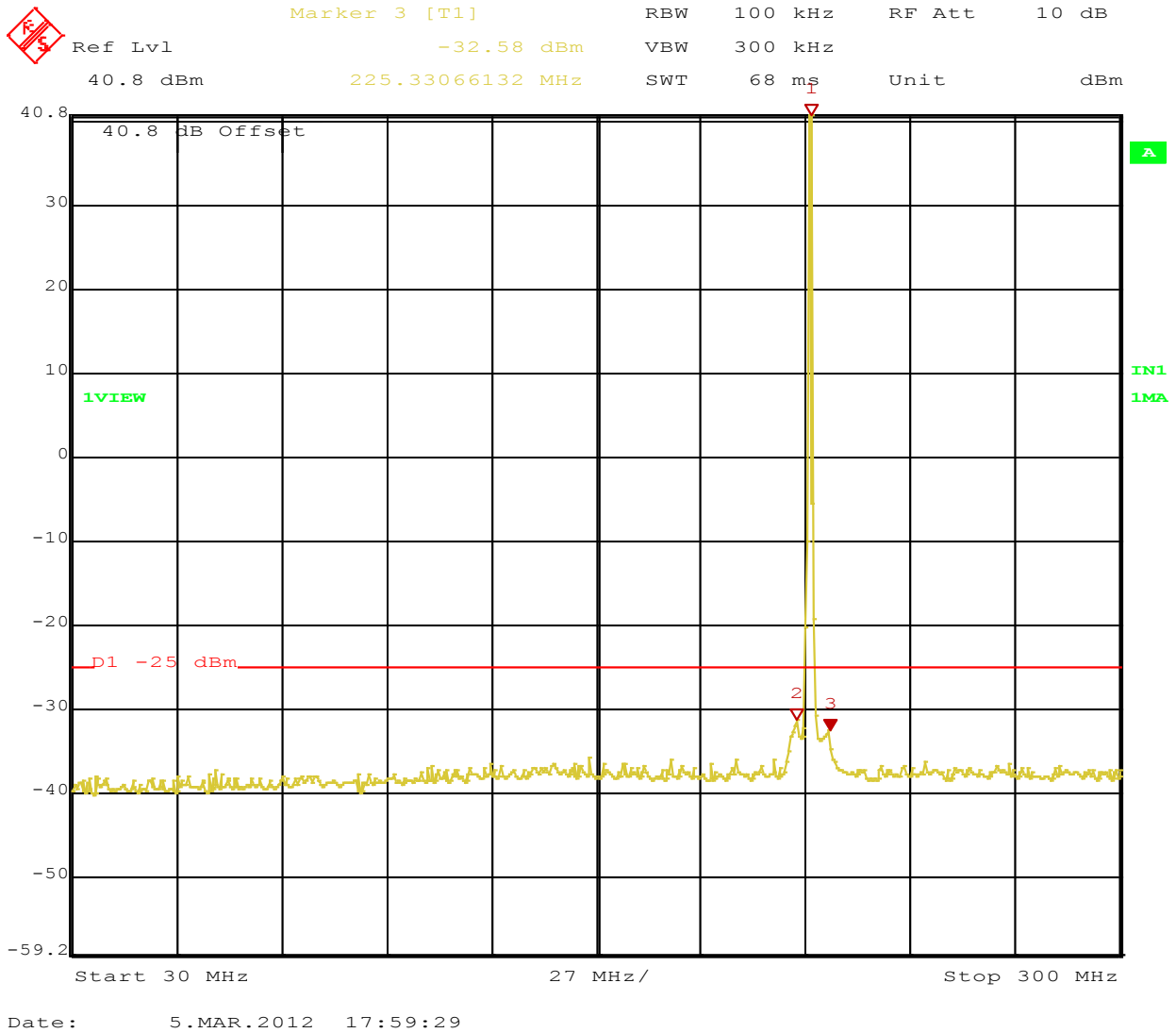

Figure 75: Out of Band Emissions Operating Channel 220.0125 MHz, GMSK Plot 1

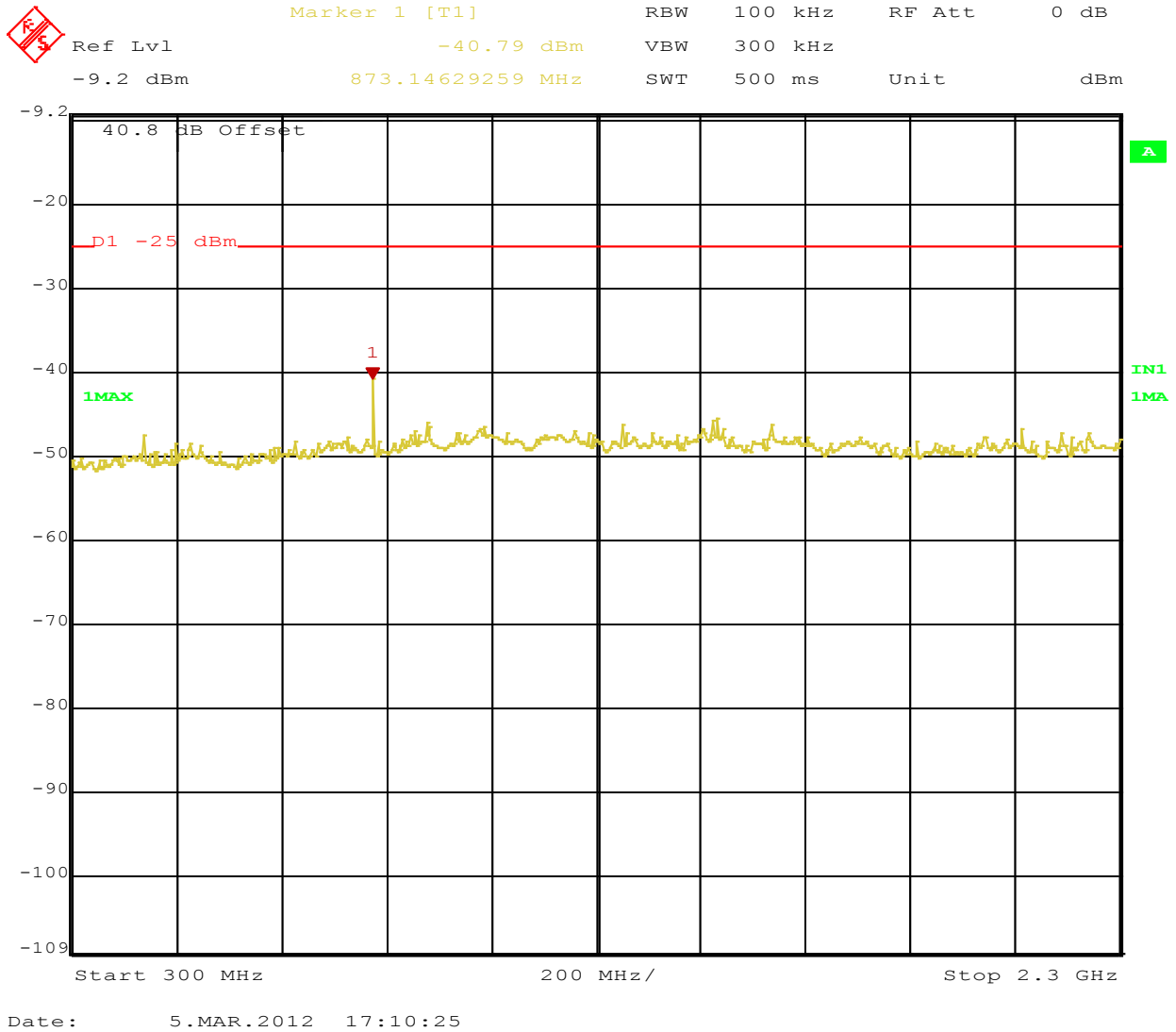

Figure 76: Out of Band Emissions Operating Channel 220.0125 MHz, GMSK Plot 2

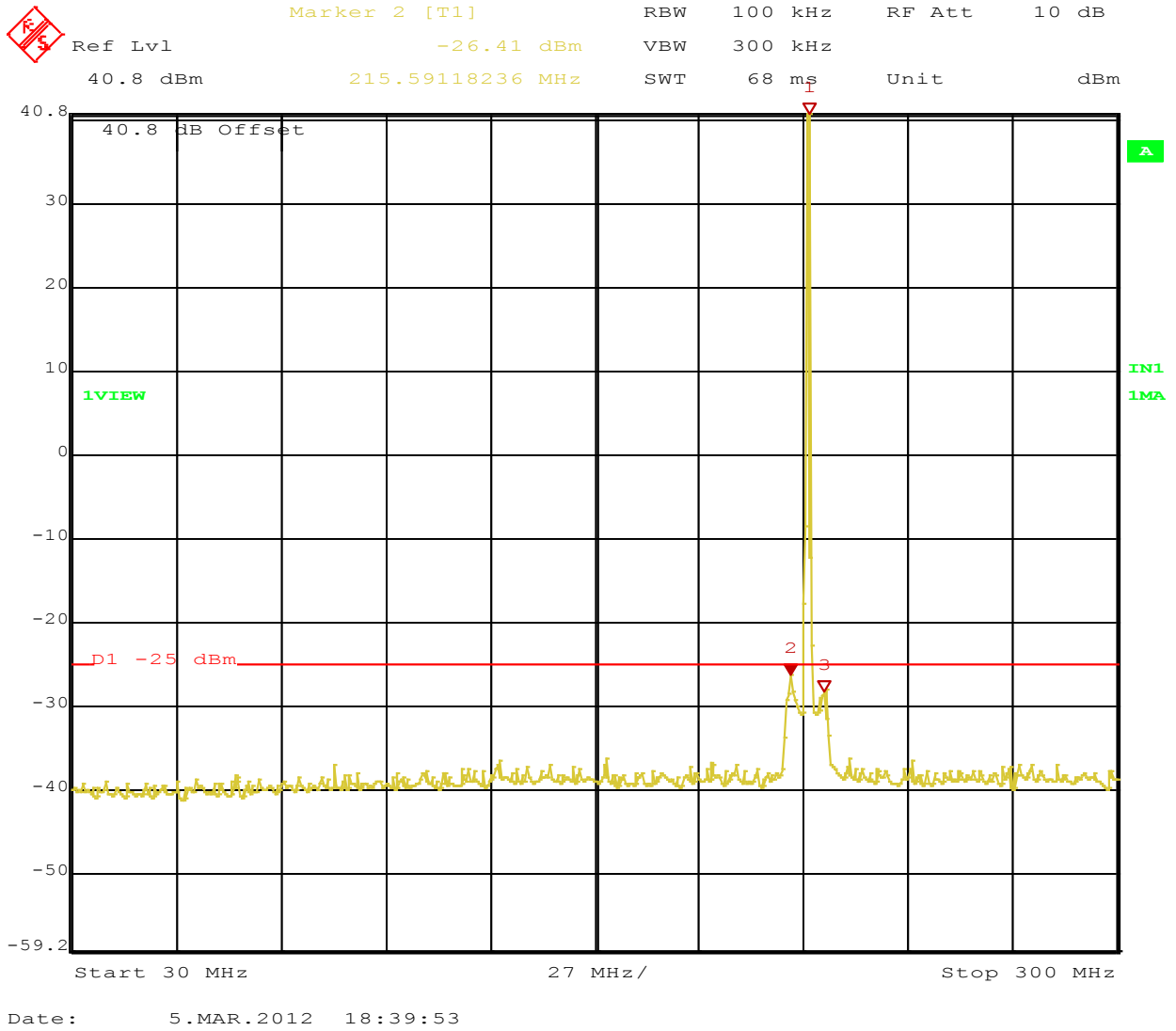

Figure 77: Out of Band Emissions Operating Channel 220.0125 MHz, 16 QPSK Plot 1

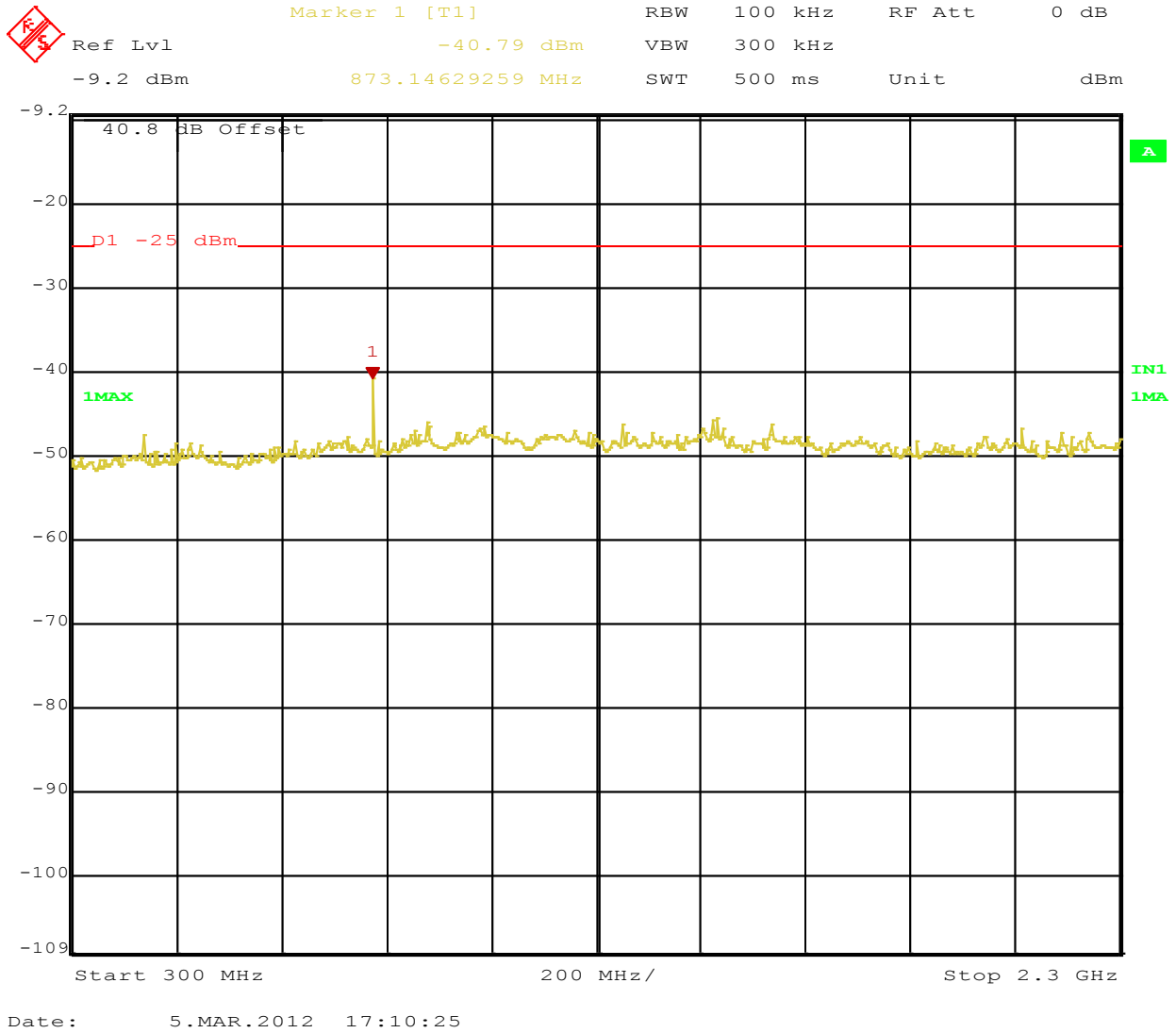

Figure 78: Out of Band Emissions Operating Channel 220.0125 MHz, 16 QPSK Plot 2

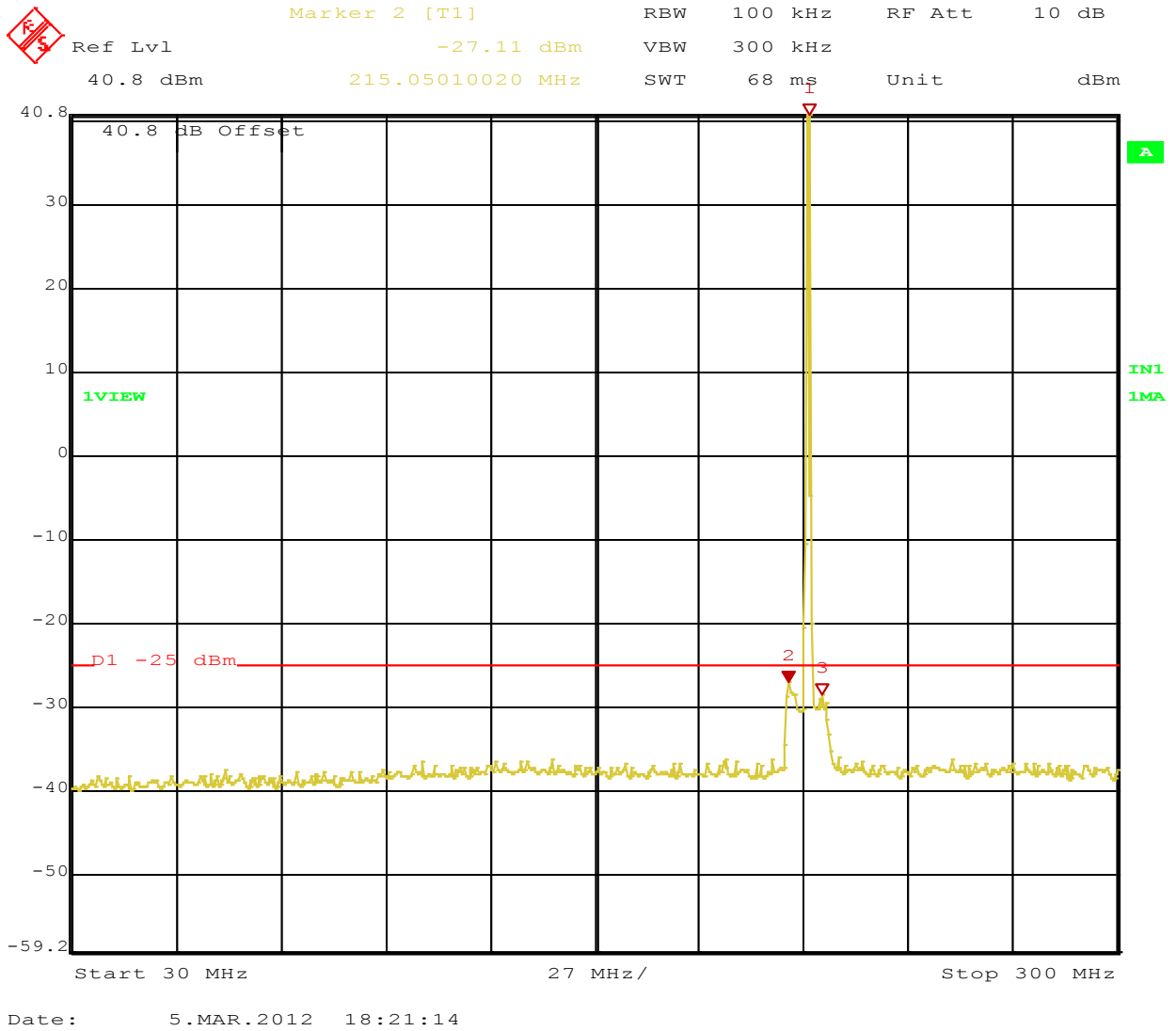
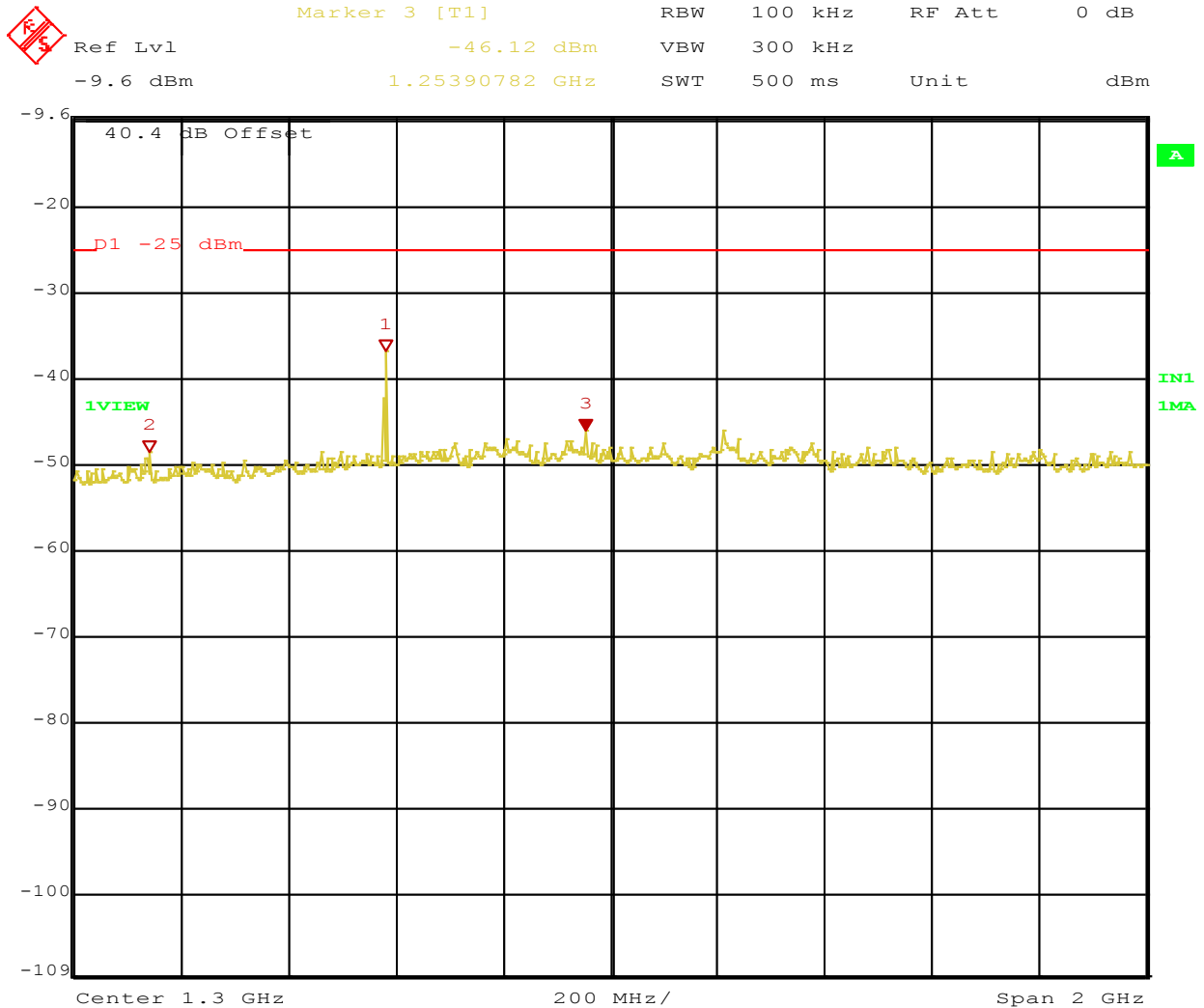

Figure 79: Out of Band Emissions Operating Channel 220.0125 MHz, 32 QPSK Plot 1



Date: 5.MAR.2012 16:05:23

Figure 80: Out of Band Emissions Operating Channel 220.0125 MHz, 32 QPSK Plot 2

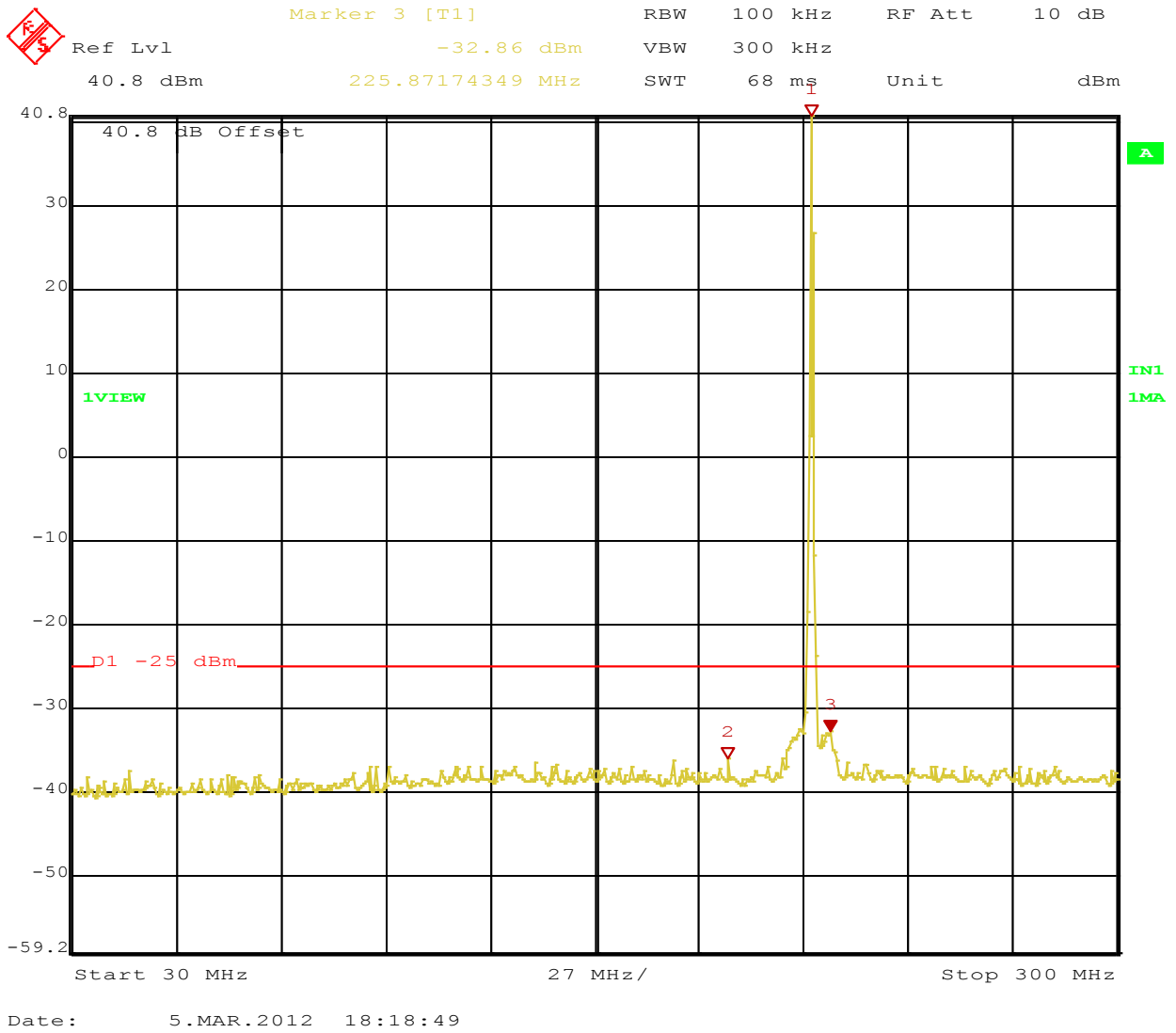

Figure 81: Out of Band Emissions Operating Channel 220.9875 MHz, GMSK Plot 1

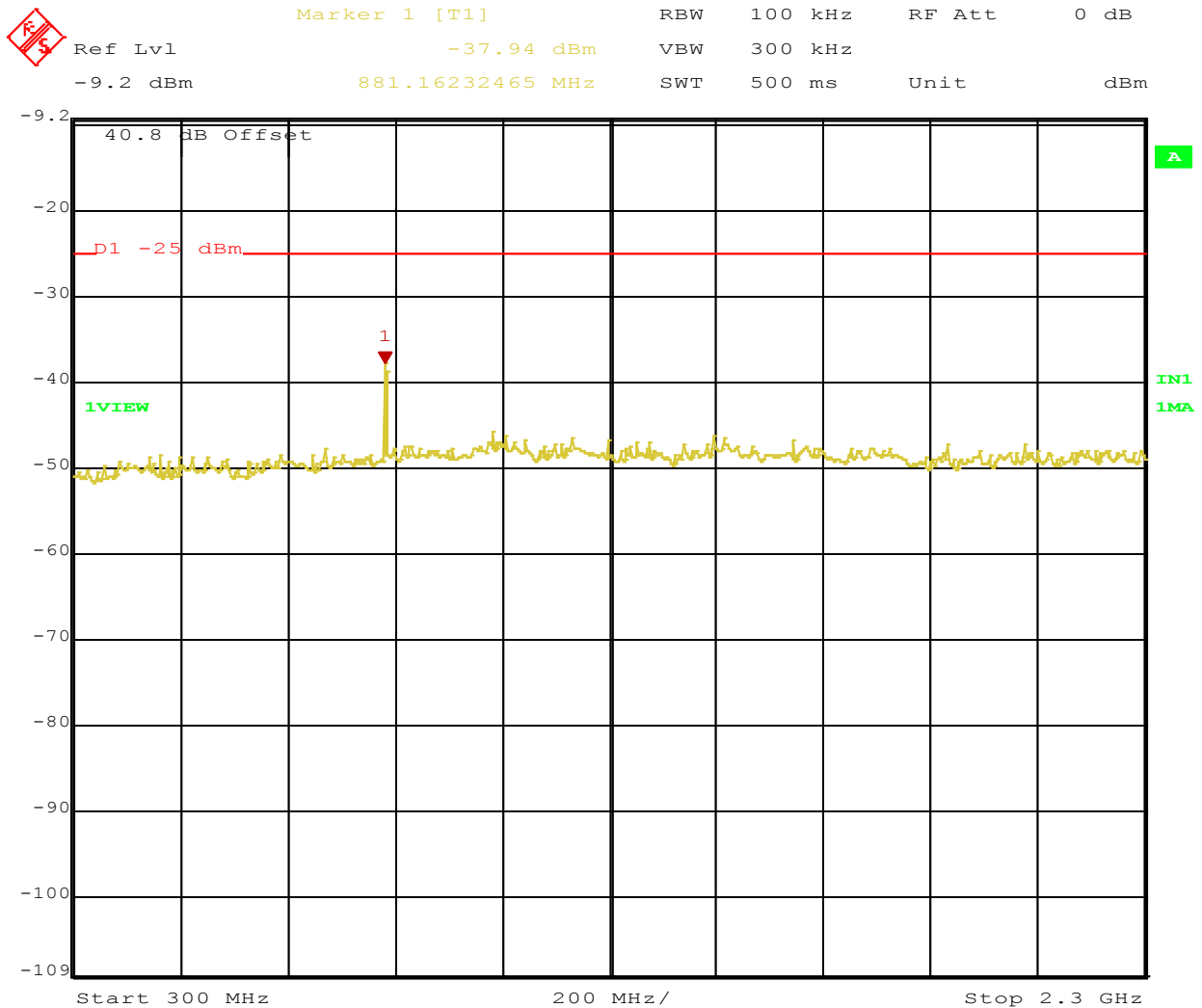

Figure 82: Out of Band Emissions Operating Channel 220.9875 MHz, GMSK Plot 2

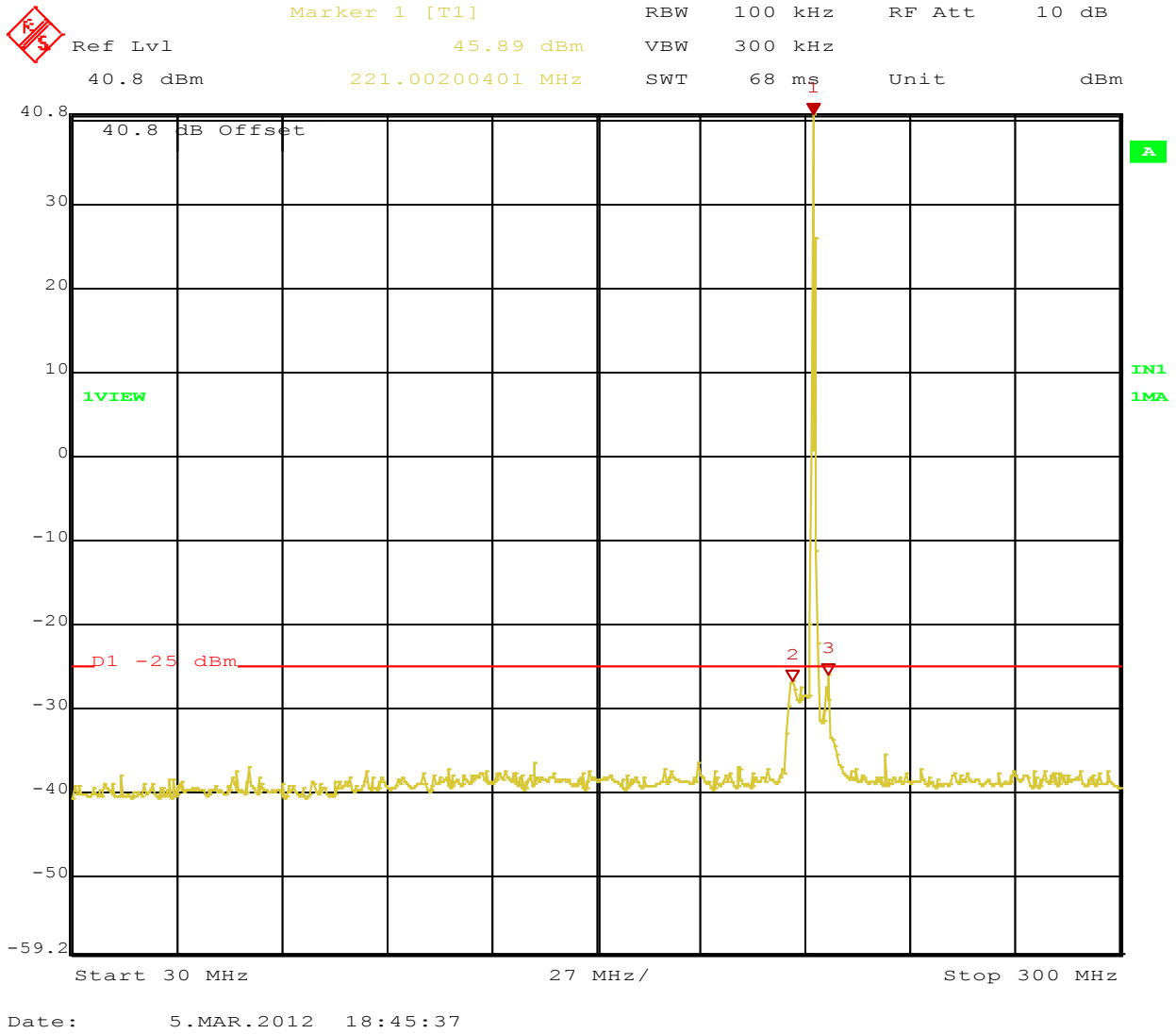
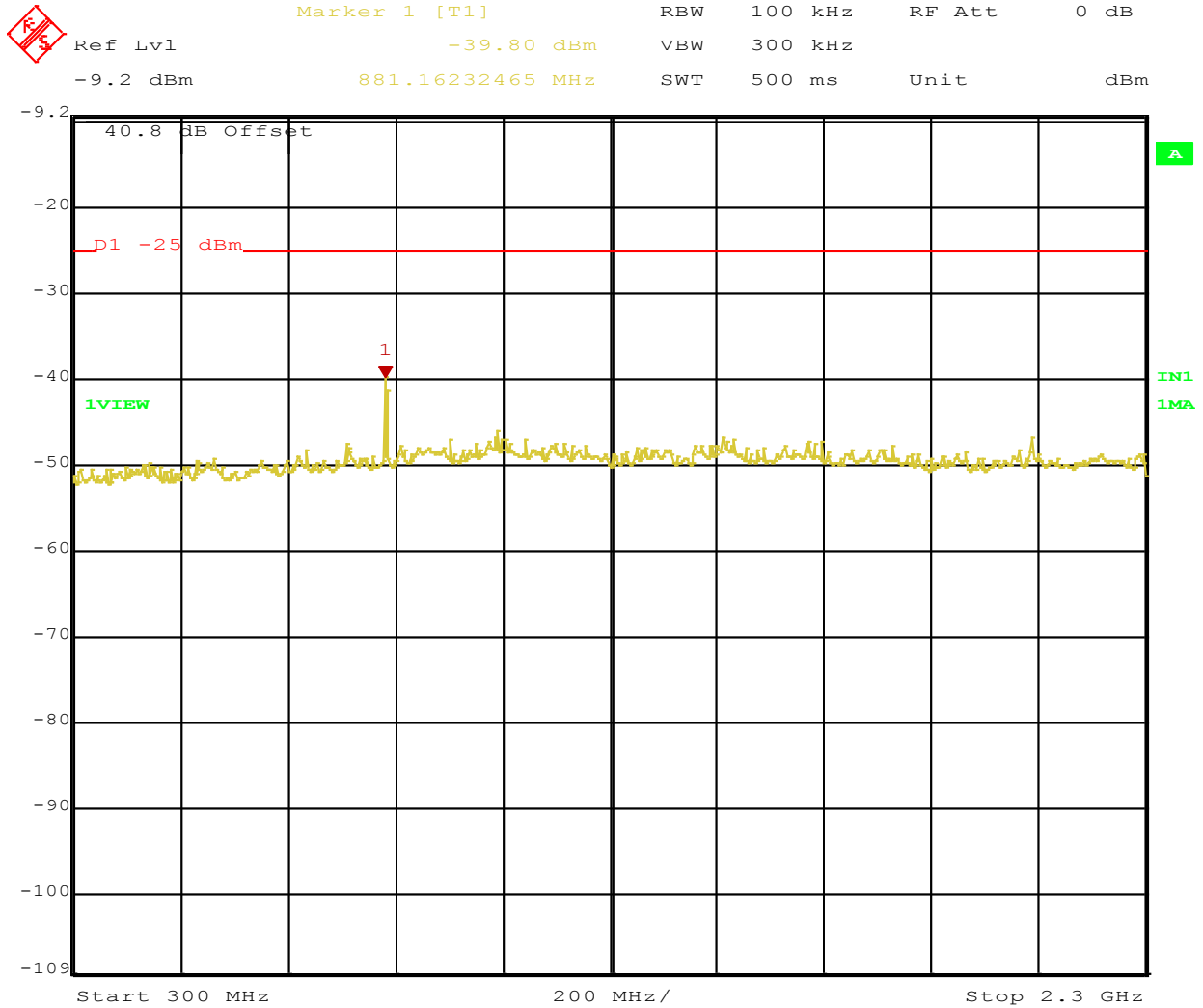

Figure 83: Out of Band Emissions Operating Channel 220.9875 MHz, 16 QPSK Plot 1



Date: 5.MAR.2012 16:56:33

Figure 84: Out of Band Emissions Operating Channel 220.9875 MHz, 16 QPSK Plot 2

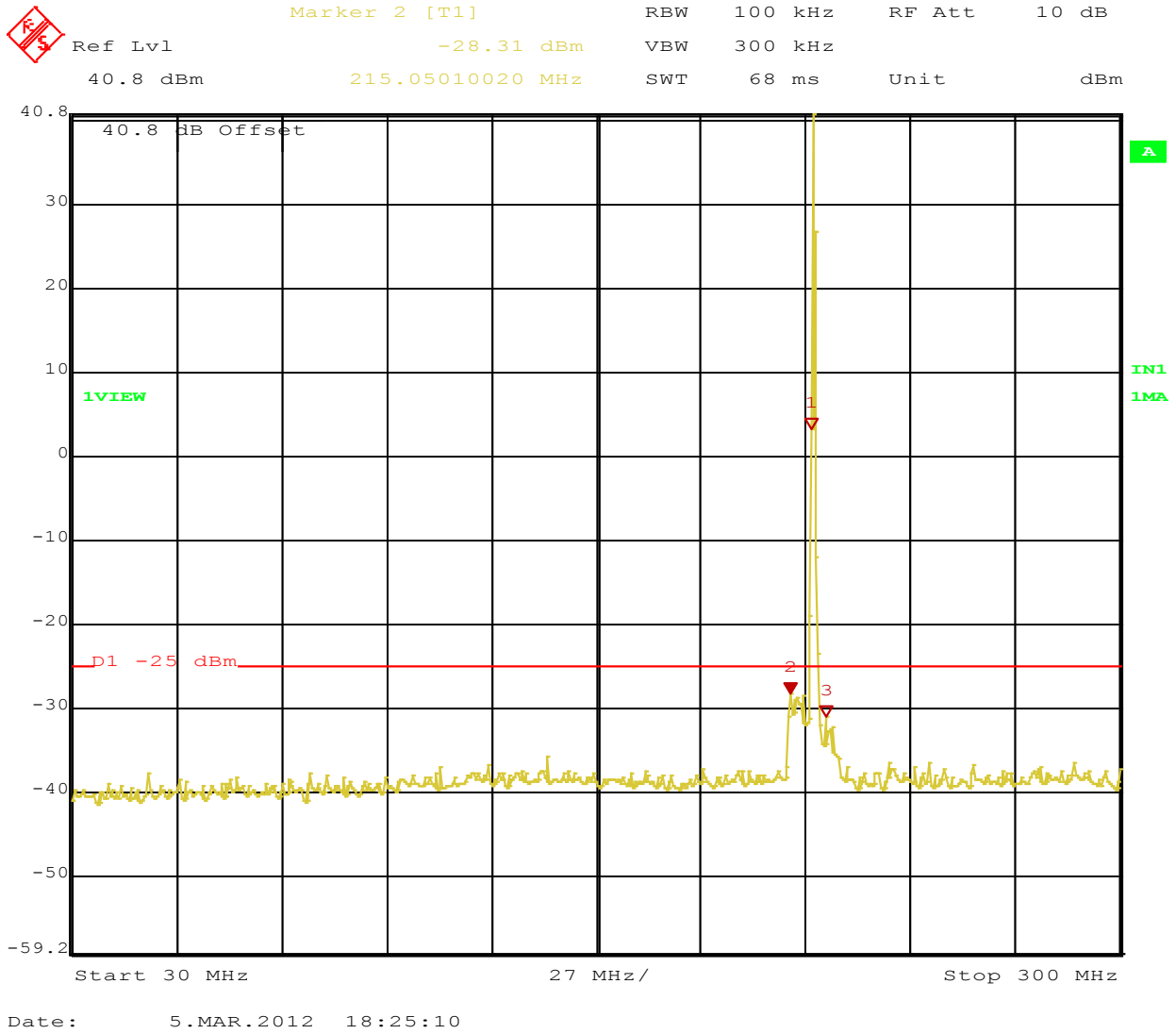

Figure 85: Out of Band Emissions Operating Channel 220.9875 MHz, 32 QPSK Plot 1

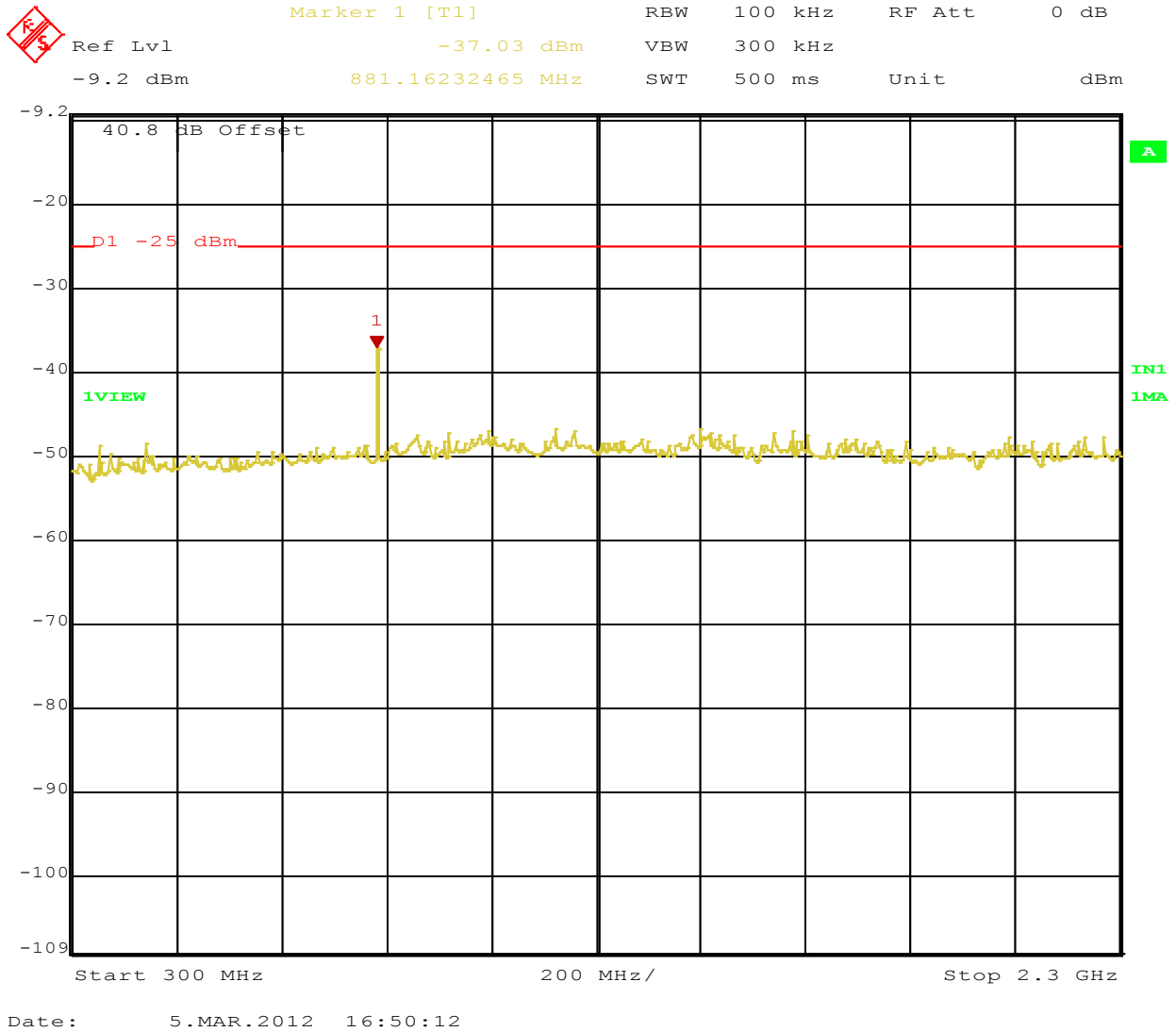

Figure 86: Out of Band Emissions Operating Channel 220.9875 MHz, 32 QPSK Plot 2

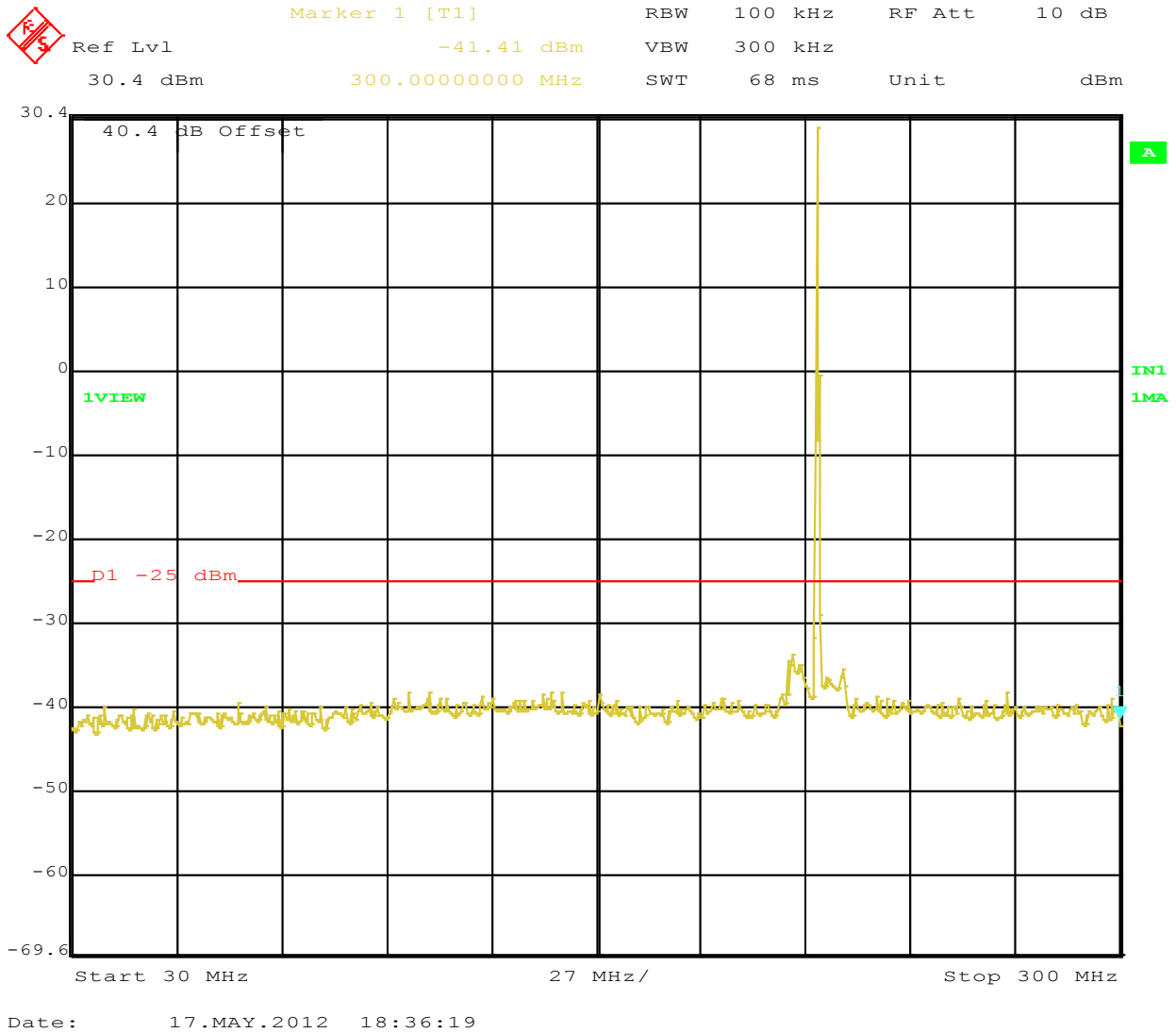
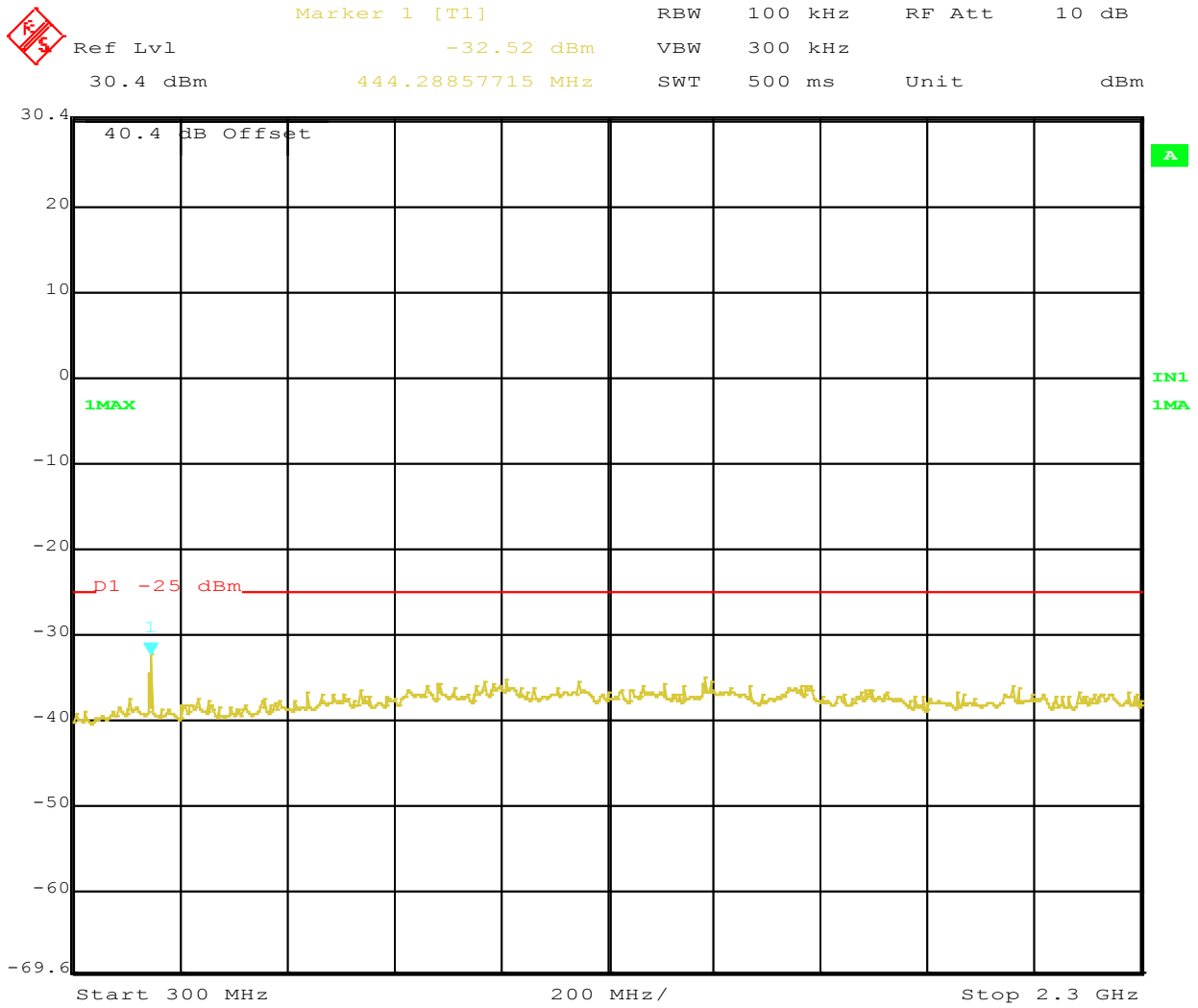

Figure 87: Out of Band Emissions Operating 222 MHz GSM Plot 1



Date: 17.MAY.2012 18:32:32

Figure 88: Out of Band Emissions Operating 222 MHz GMSK Plot 2

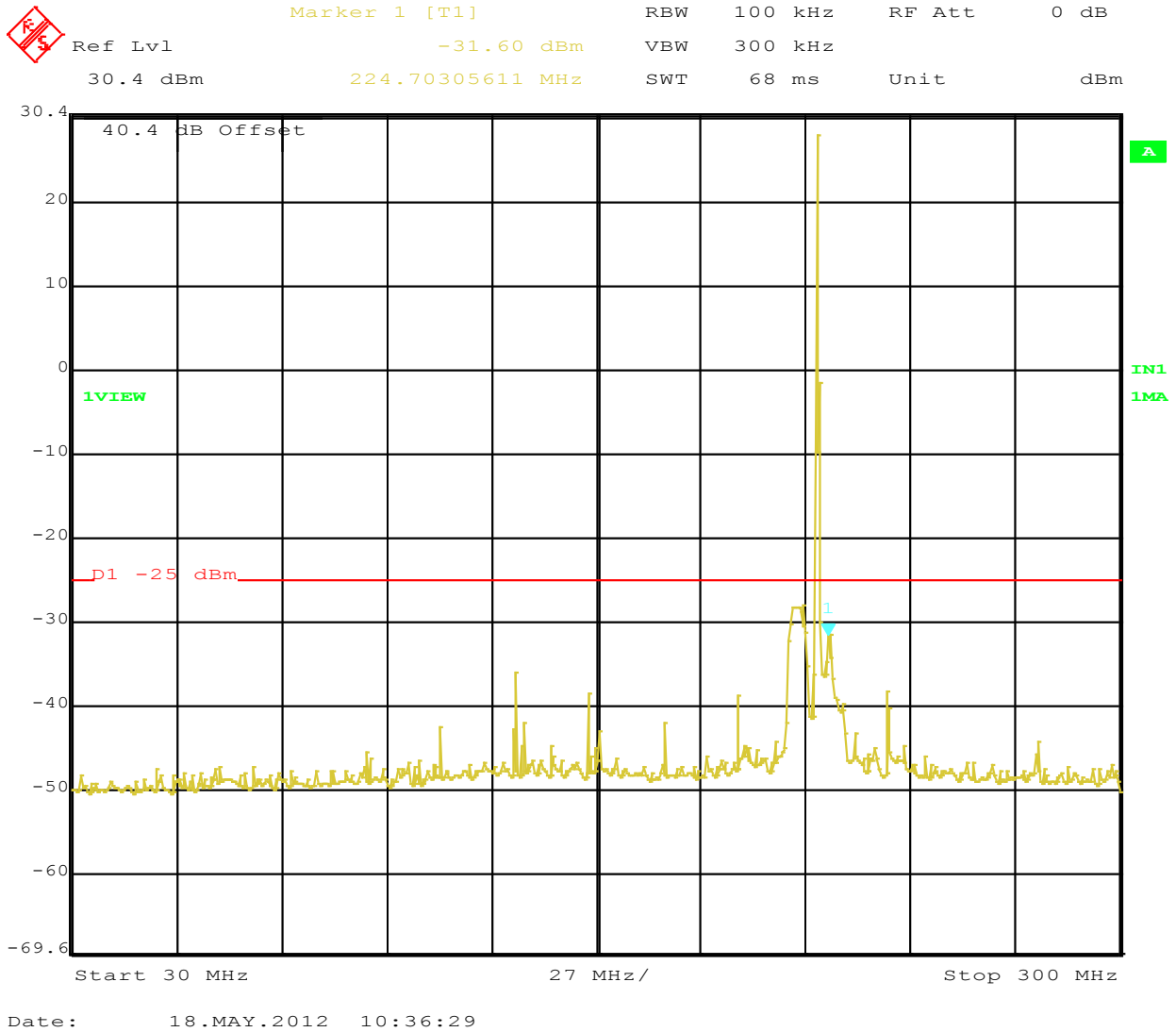

Figure 89: Out of Band Emissions Operating 222 MHz 16 QPSK Plot 1

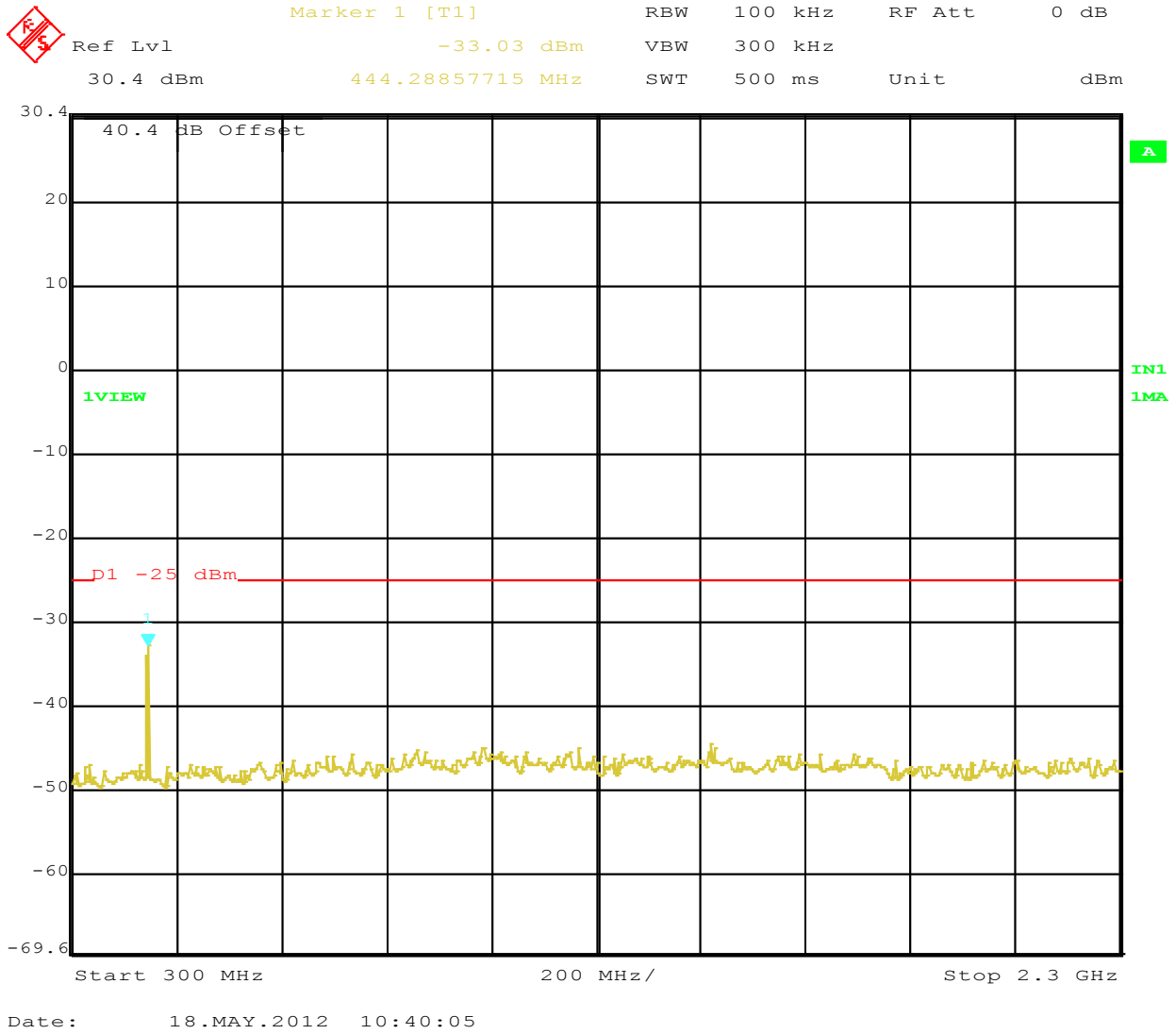

Figure 90: Out of Band Emissions Operating 222 MHz 16 QPSK Plot 2

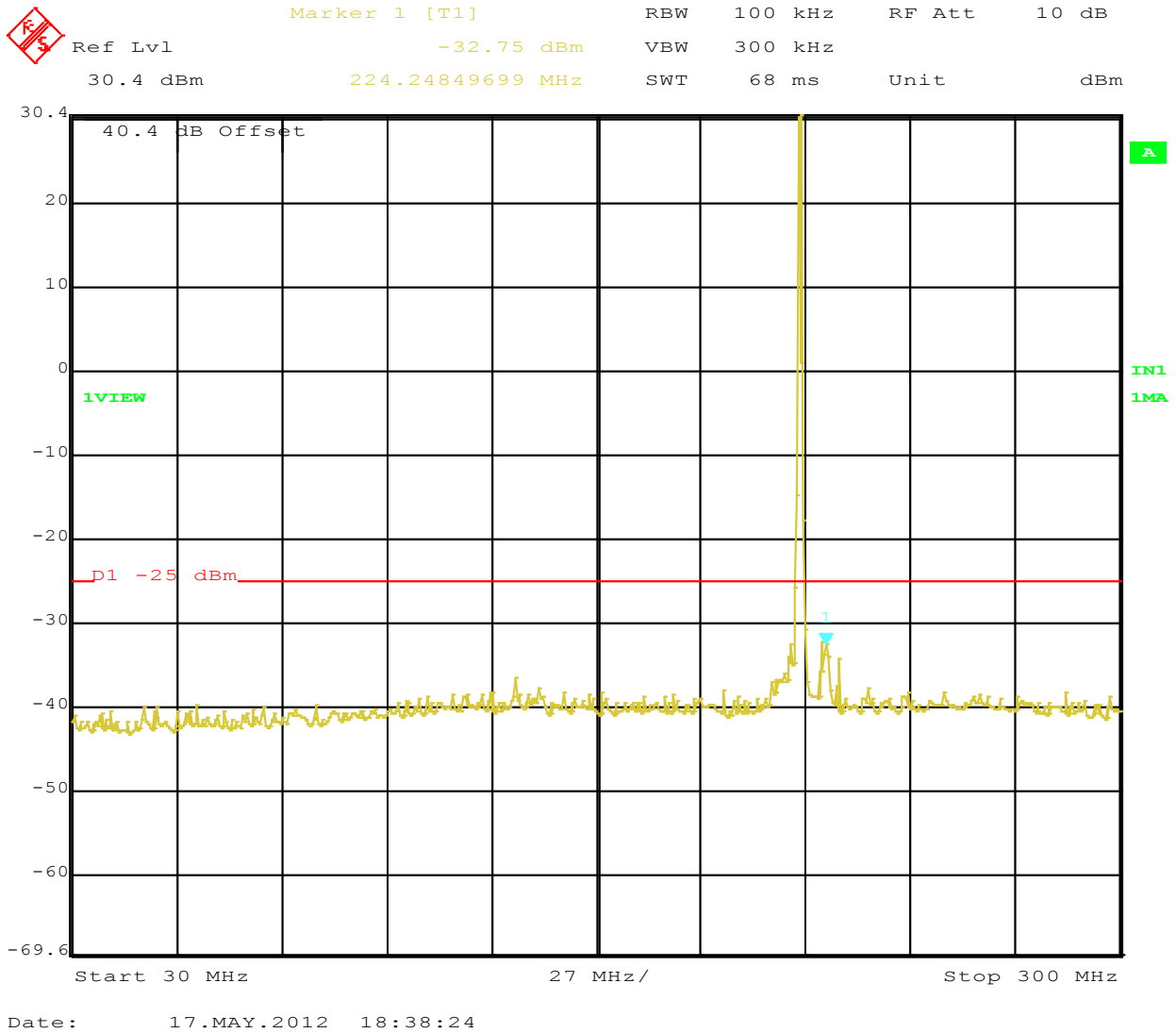
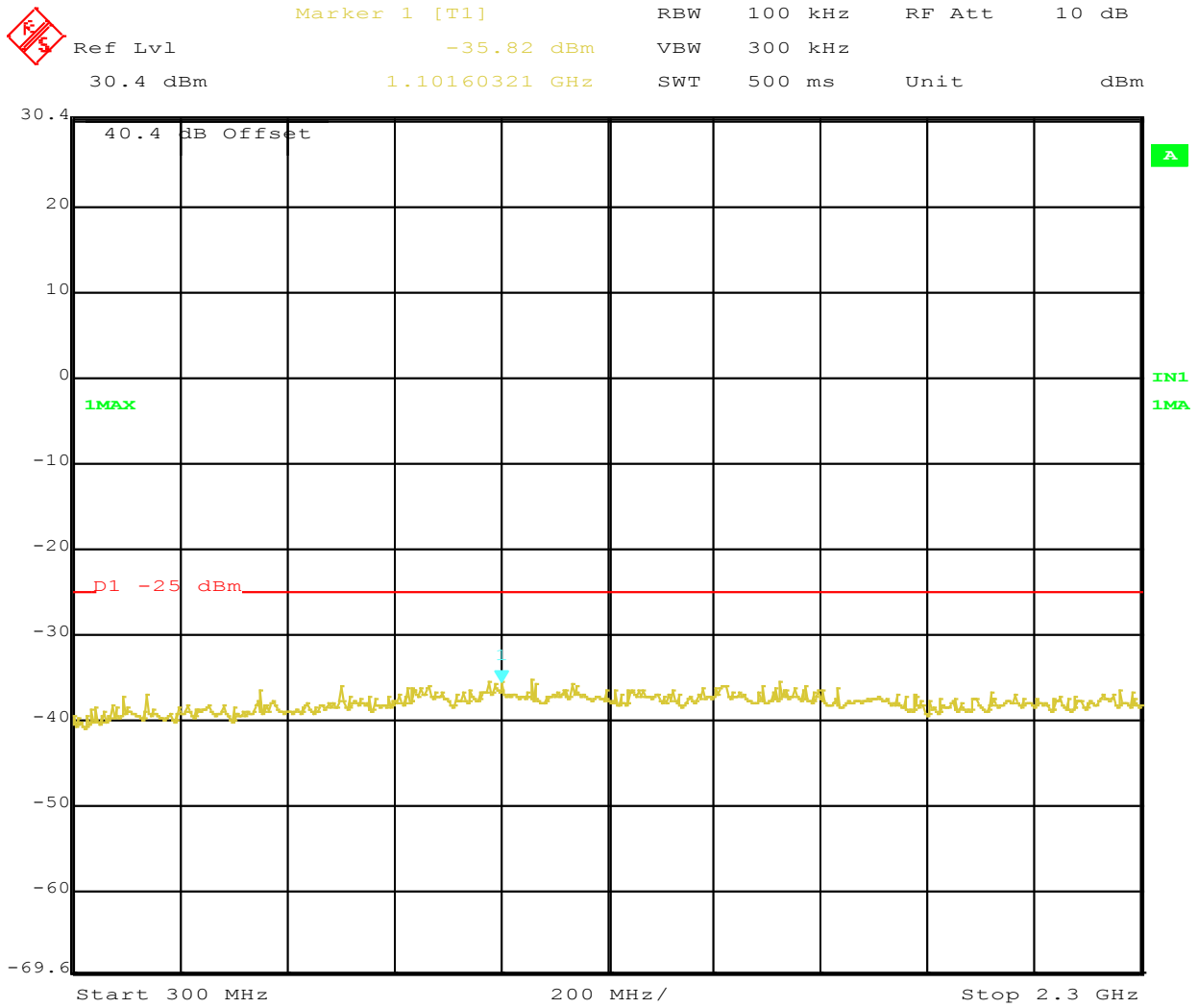

Figure 91: Out of Band Emissions Operating 222 MHz 32 QPSK Plot 1



Date: 17.MAY.2012 18:40:00

Figure 92: Out of Band Emissions Operating 222 MHz 32 QPSK Plot 2

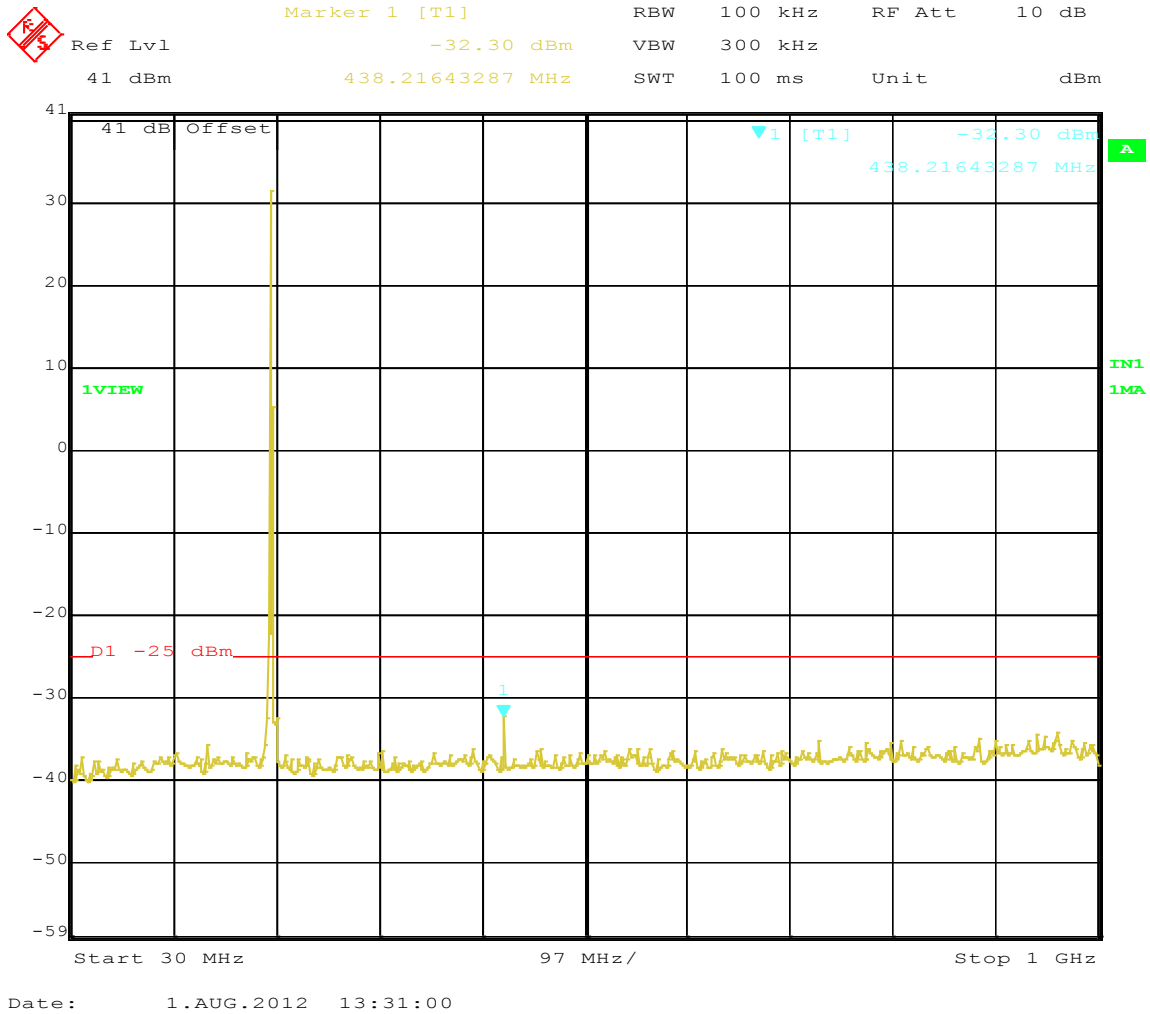

Figure 93: Out of Band Emissions Operating 219.5 MHz 16 QPSK Plot 1

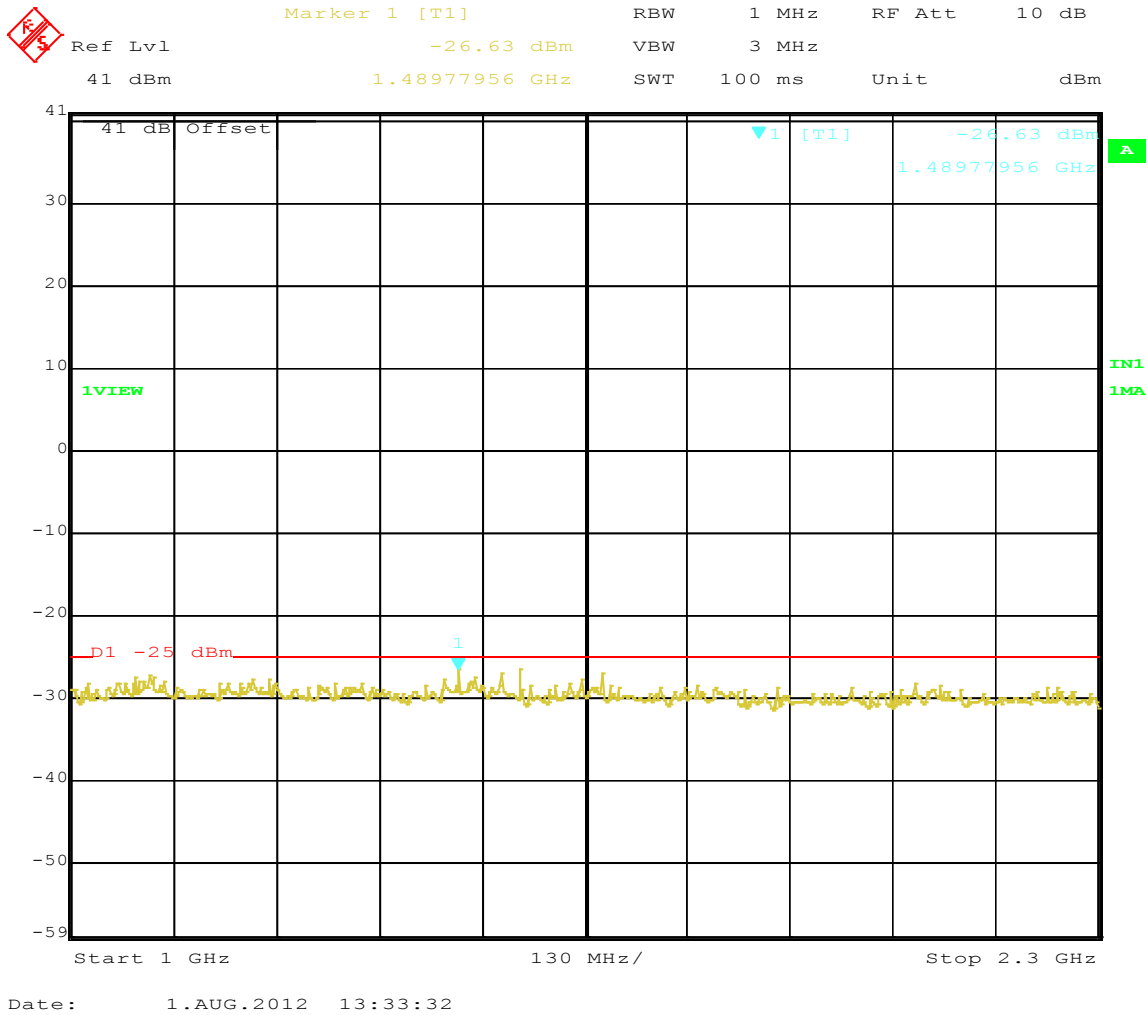

Figure 94: Out of Band Emissions Operating 219.5 MHz 16 QPSK Plot 2

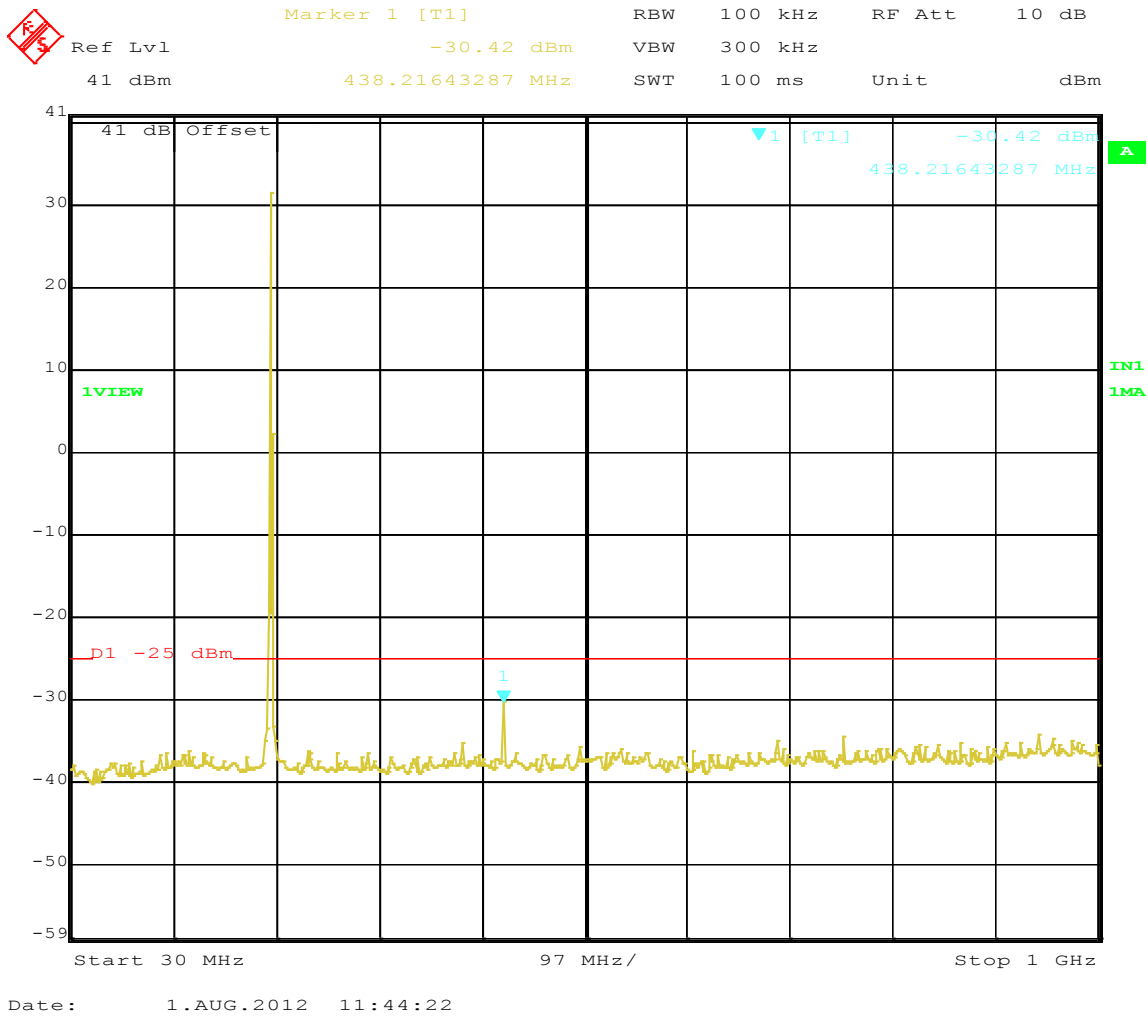

Figure 95: Out of Band Emissions Operating 219.5 MHz 32 QPSK Plot 1

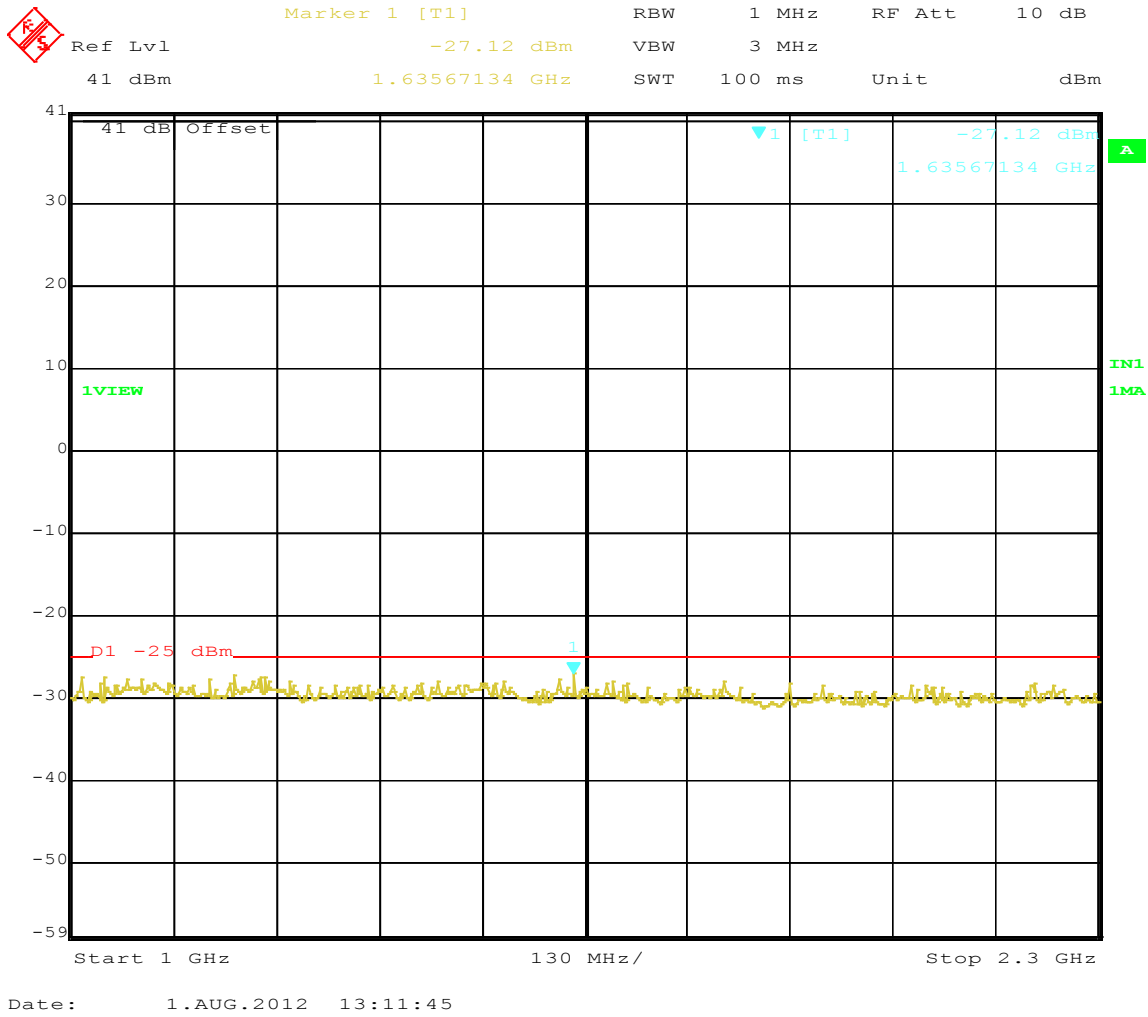
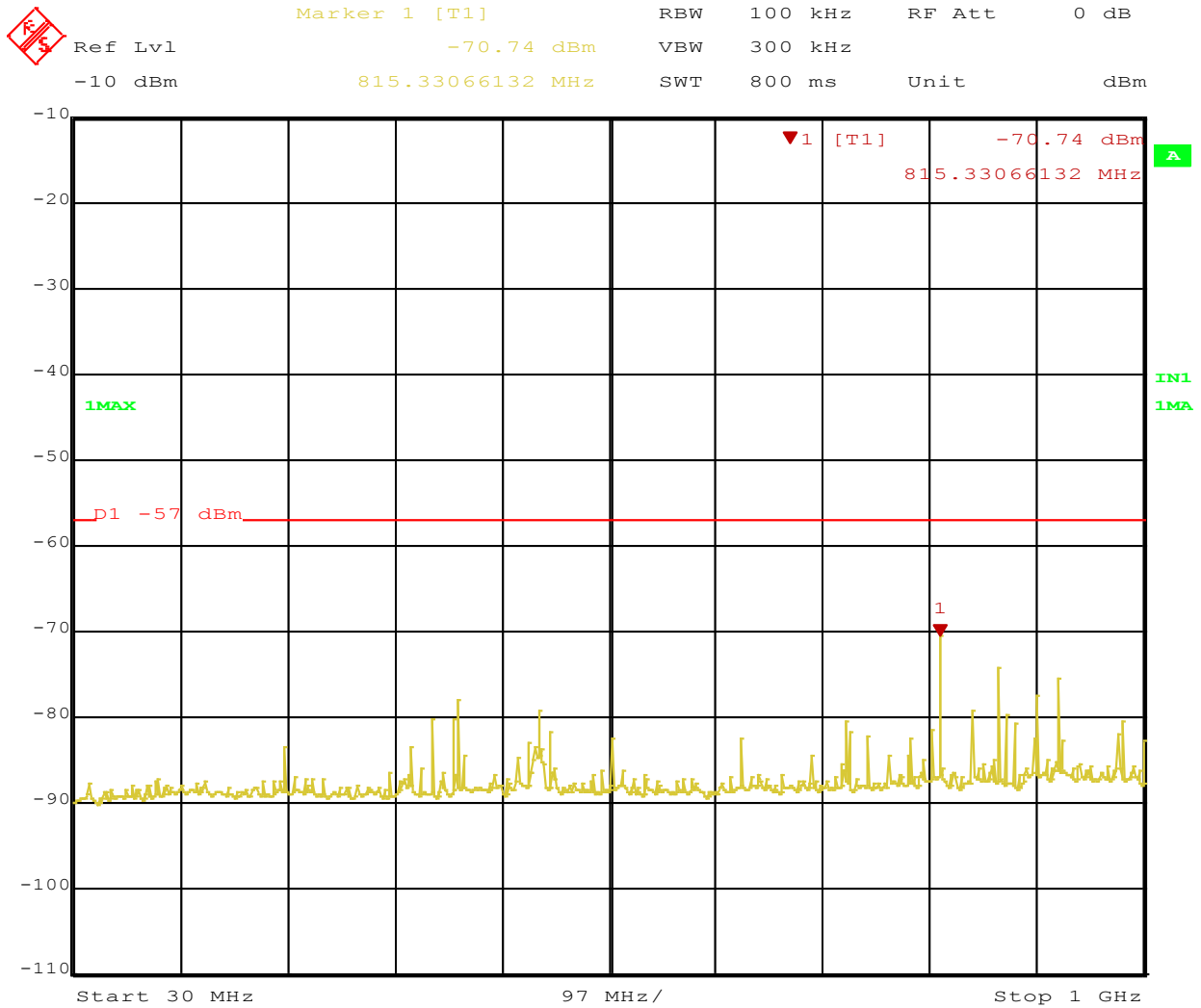

Figure 96: Out of Band Emissions Operating 219.5 MHz 32QPSK Plot 2

4.4.3 Out of band emissions receive mode



Date: 12.MAR.2012 08:40:26

Figure 97: Out of Band Emissions Operating 217.5 MHz Receive Mode

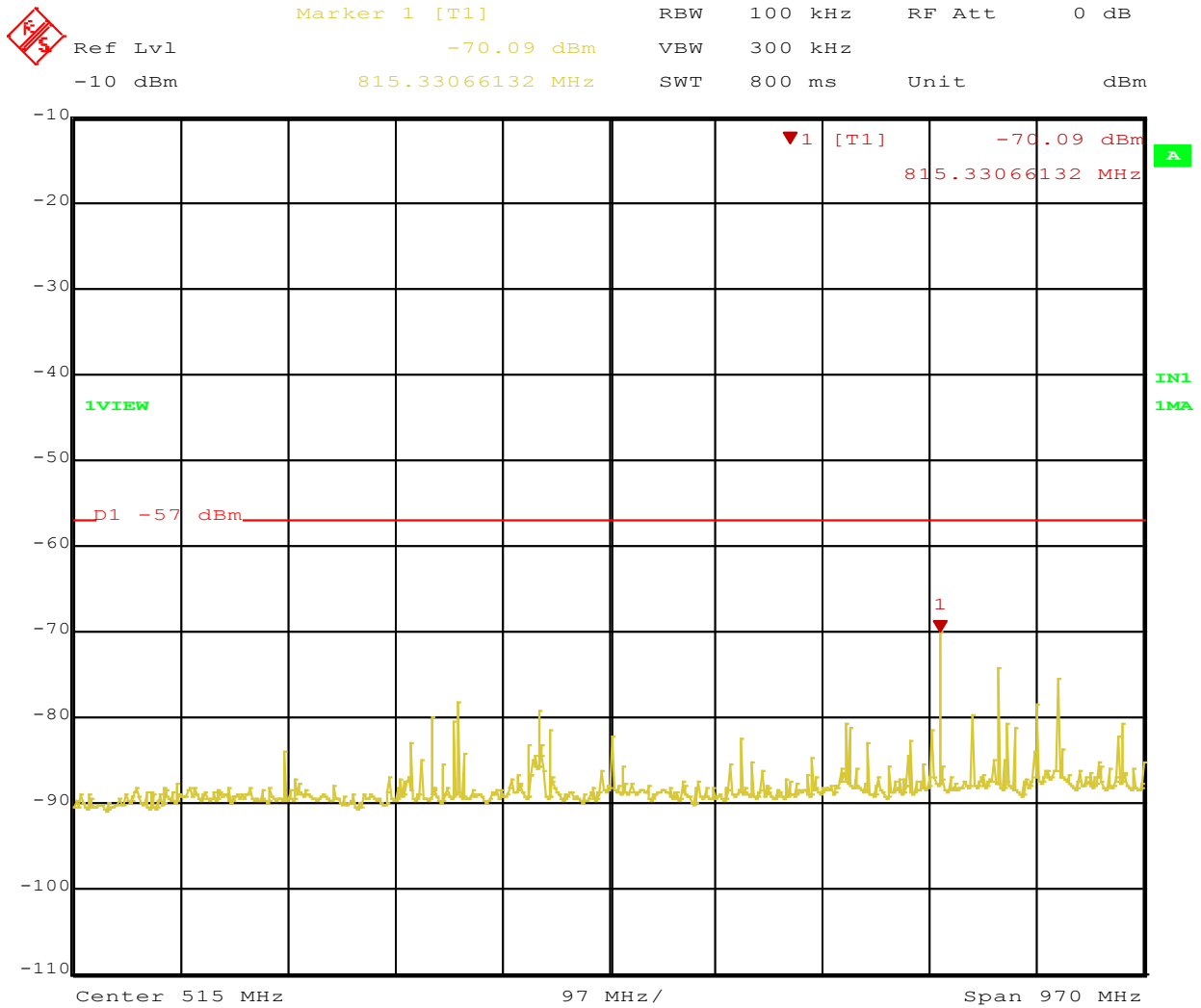

Date: 12.MAR.2012 08:15:09

Figure 98: Out of Band Emissions Operating 220.9875 MHz Receive Mode

4.5 Transmitter Spurious Emissions

Transmitter spurious emissions are emissions outside the frequency range of the equipment when the equipment is in transmit mode; per requirement of CFR47 part 90.210, RSS-119 para 4.2.3

4.5.1 Test Methodology

4.5.1.1 Preliminary Test

A test program that controls instrumentation and data logging was used to automate the preliminary RF emission test procedure. The frequency range of interest was divided into sub-ranges to yield a frequency resolution of approximately 120 kHz and provide a reading at each frequency for no more than 12° of turntable rotation. For each frequency sub-range the turntable was rotated 360° while peak emission data was recorded and plotted over the frequency range of interest in horizontal and vertical antenna polarization's.

Preliminary emission profile testing was performed inside the anechoic chamber. The EUT was placed on a 1.0m x 1.5m non-conductive table 80cm above the floor. The EUT was positioned as shown in the setup photographs. The receiving antenna was placed at a distance of 3m at a fixed height of 1m. Measurement equipment was located outside of the chamber. A video camera was placed inside the chamber to view the EUT.

4.5.1.2 Final Test

For each frequency measured, the peak emission was maximized by manipulating the receiving antenna from 1 to 4 meters above the ground plane and placing it at the position that produced the maximum signal strength reading. The turntable was then rotated through 360° while observing the peak signal and placing the EUT at the position that produced maximum radiation. The six highest emissions relative to the limit were measured unless such emissions were more than 20 dB below the limit. If less than six emissions are within 20 dB of the limit, than the noise level of the receiver is measured at frequencies where emissions are expected. Multiples of all oscillator and microprocessor frequencies were also checked.

Final testing was performed on an NSA compliant test site. The EUT was placed on a 1.0m x 1.5m non-conductive table 80cm above the ground plane. The placement of EUT and cables were the same as for preliminary testing and is shown in the setup photographs.

Final

The final scans were performed on the worst axis, for three operating channels. Substitution method was used to obtain final results. Final test were performed on the following channels based on pre-scans

217.5 MHz, 220.0125 MHz, 220.9875 MHz and 222 MHz

4.5.1.3 Deviations

None.

4.5.2 Transmitter Spurious Emission Limit

The spurious emissions of the transmitter shall not exceed the values in CFR47 Part 90 and RSS-119

Emission limits are taken from Emission mask F

4.5.3 Test Results

The final measurement data was taken under the worst case operating modes, configurations, and/or cable positions. It also reflects the results including any modifications and/or special accessories listed in Sections 1.4 and Test Plan.

As originally tested, the EUT was found to be compliant to the requirements of the test standard(s).

SOP 1 Radiated Emissions

Tracking # 31260509.004 Page 1 of 21

EUT Name	TransAir PTC-3006	Date	04/03/2012
EUT Model	PTC-3006	Temp / Hum in	23°C / 39%rh
EUT Serial	D1-10	Temp / Hum out	N/A
EUT Config.	TX ON	Line AC	12 Vdc
Standard	CFR47 Part 90	RBW / VBW	120 kHz/300 kHz
Dist/Ant Used	3m - EMCO3115 / 1m - RA42-K-F-4B-C	Performed by	Suresh Kondapalli

30 MHz to 1GHz Plot for Transmit Mode: GMSK 217.5 MHz

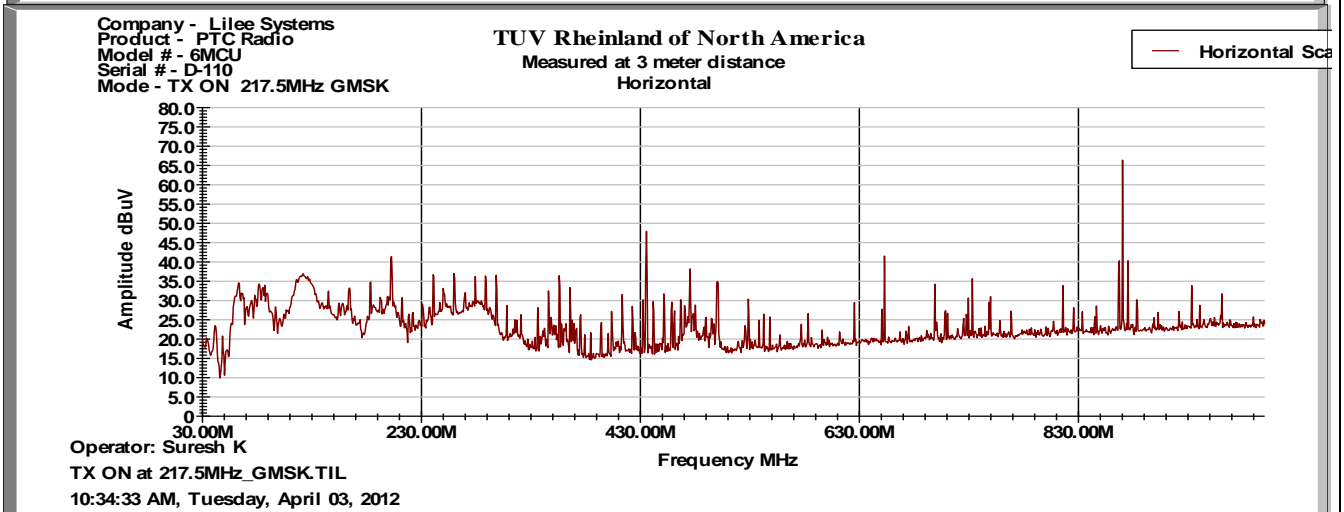
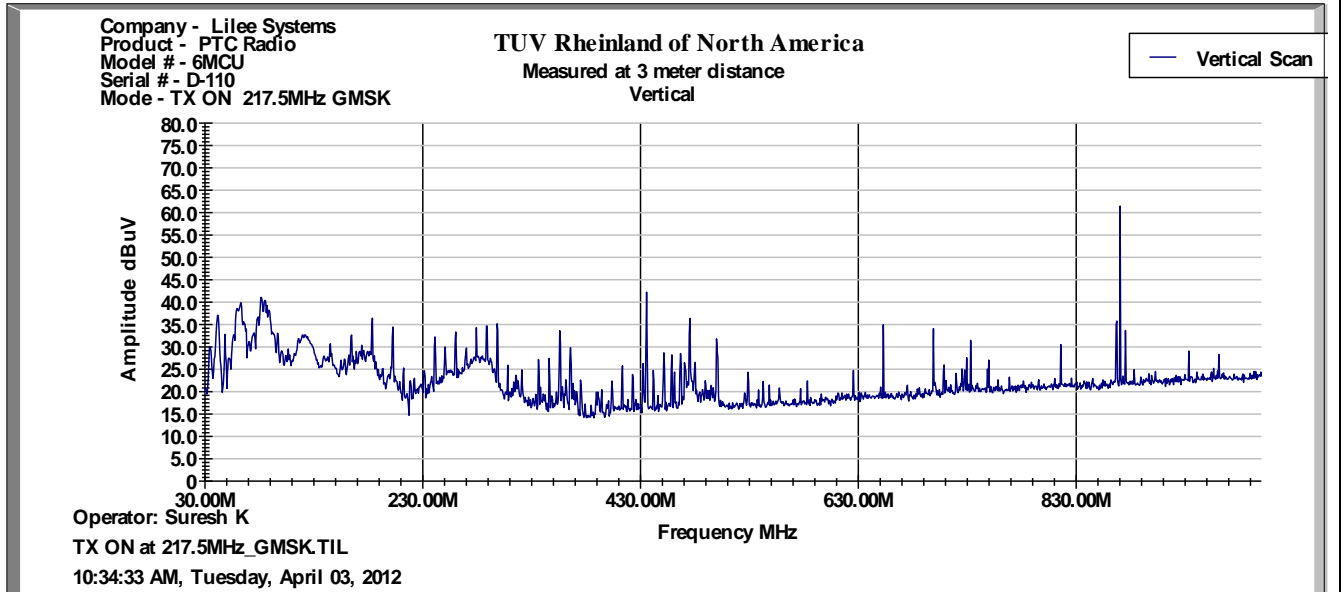

Notes: None

SOP 1 Radiated Emissions

Tracking # 31260509.004 Page 2 of 21

EUT Name	TransAir PTC-3006	Date	04/05/2012
EUT Model	PTC-3006	Temp / Hum in	23°C / 39%rh
EUT Serial	D1-10	Temp / Hum out	N/A
EUT Config.	TX ON	Line AC	12 Vdc
Standard	CFR47 Part 90	RBW / VBW	120 kHz/300 kHz
Dist/Ant Used	3m - EMCO3115 / 1m - RA42-K-F-4B-C	Performed by	Suresh Kondapalli

1GHz to 2.2GHz Plot for Transmit Mode: GMSK 217.5 MHzx

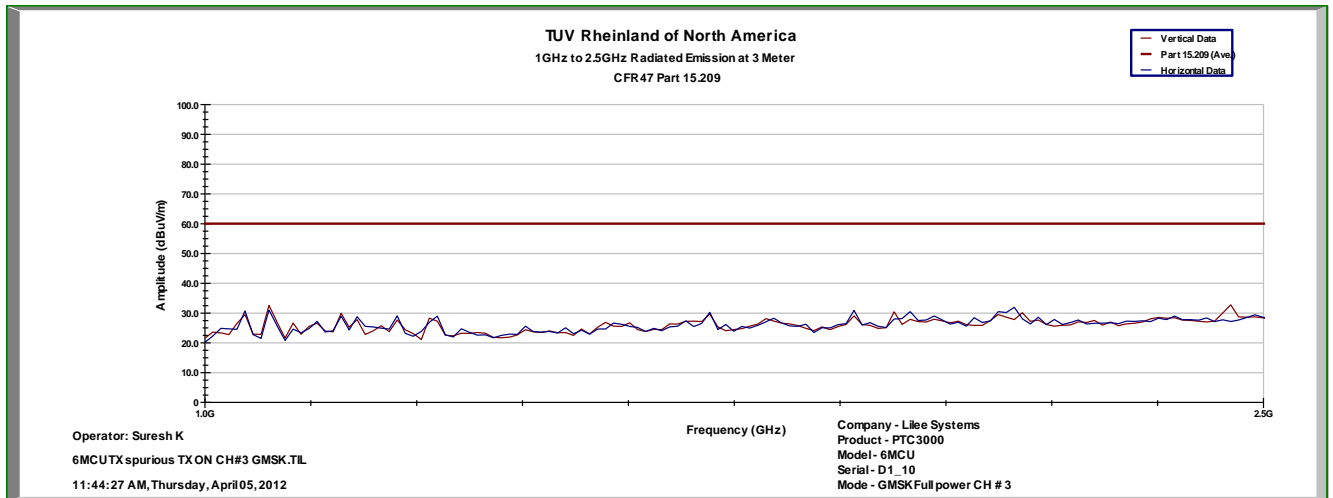

Notes: None

SOP 1 Radiated Emissions

Tracking # 31260509.004 Page 3 of 21

EUT Name	TransAir PTC-3006	Date	04/08/2012
EUT Model	PTC-3006	Temp / Hum in	23°C / 39%rh
EUT Serial	D1-10	Temp / Hum out	N/A
EUT Config.	TX ON	Line AC	12 Vdc
Standard	CFR47 Part 90	RBW / VBW	120 kHz/300 kHz
Dist/Ant Used	3m - EMCO3115 / 1m - RA42-K-F-4B-C	Performed by	Suresh Kondapalli

30 MHz to 1GHz Plot for Transmit Mode: 217.5 MHz at 16 QPSK

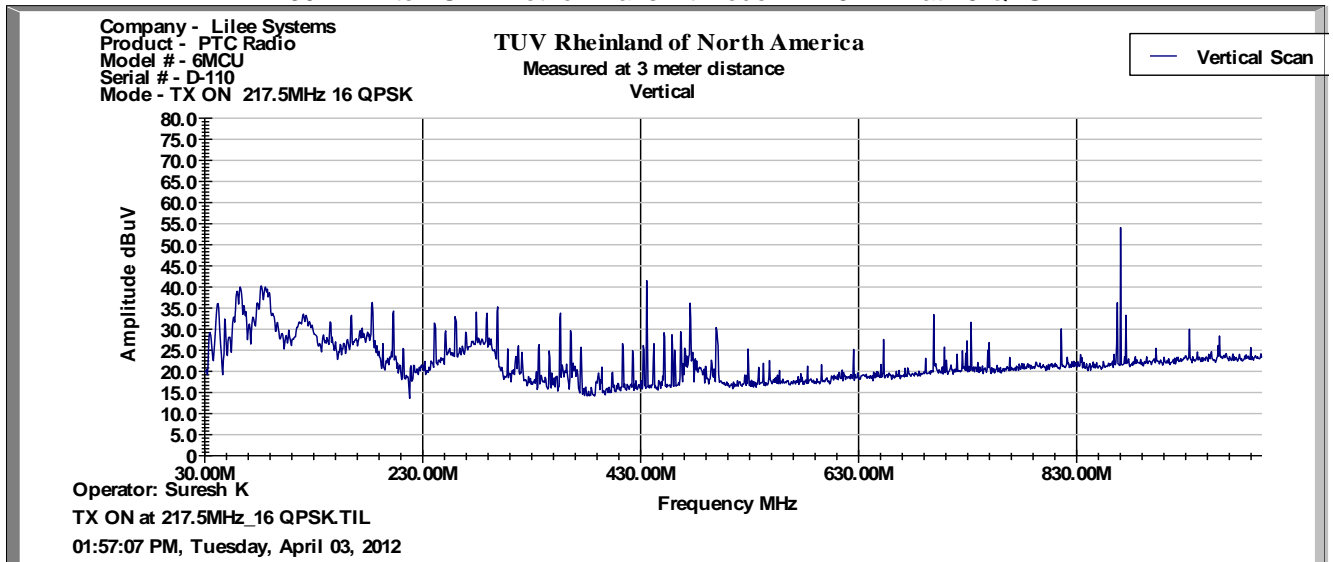

Note: Emission measurements in Horizontal polarization were made and highest measurements are placed in the table. Graph of Horizontal polarization measurements not placed here.

SOP 1 Radiated Emissions

Tracking # 31260509.004 Page 4 of 21

EUT Name	TransAir PTC-3006	Date	04/03/2012
EUT Model	PTC-3006	Temp / Hum in	23°C / 39%rh
EUT Serial	D1-10	Temp / Hum out	N/A
EUT Config.	TX ON	Line AC	12 Vdc
Standard	CFR47 Part 90	RBW / VBW	120 kHz/300 kHz
Dist/Ant Used	3m - EMCO3115 / 1m - RA42-K-F-4B-C	Performed by	Suresh Kondapalli

30 MHz to 1GHz Plot for Transmit Mode: 32 QPSK

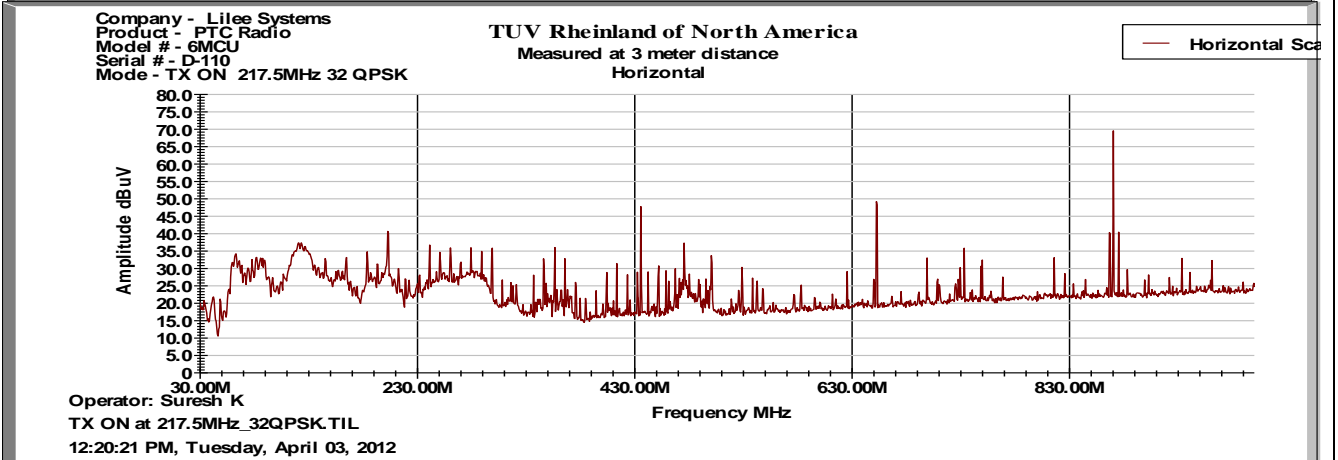
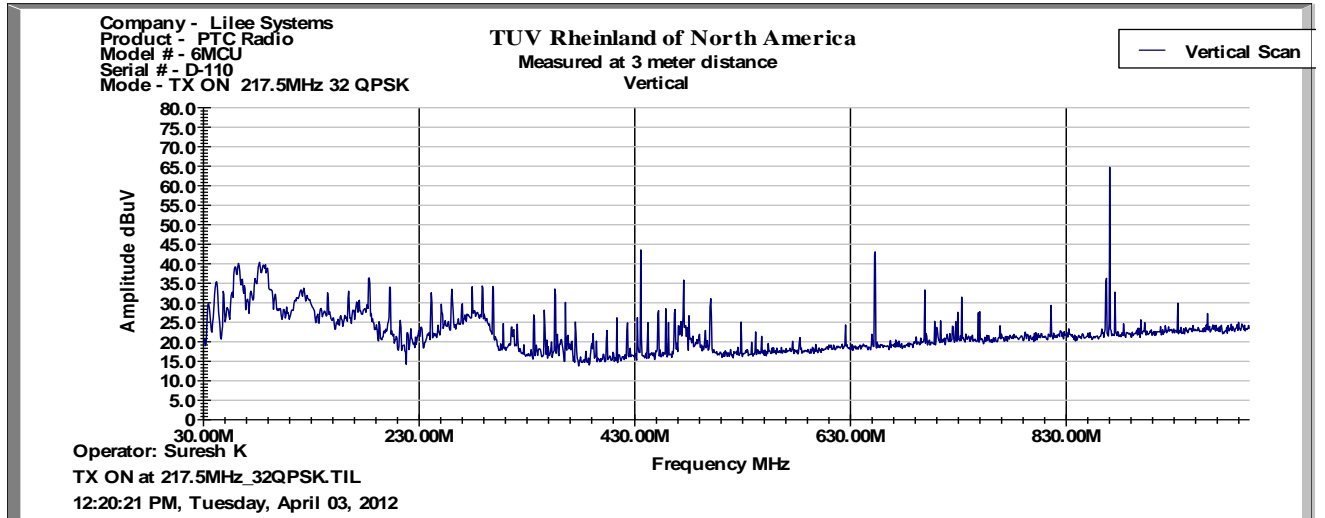

Notes: None

SOP 1 Radiated Emissions					Tracking # 31260509.004 Page 5 of 19					
EUT Name	TransAir PTC-3006				Date	04/17/2012				
EUT Model	PTC-3006				Temp / Hum in	23°C / 39%rh				
EUT Serial	D1-10				Temp / Hum out	N/A				
EUT Config.	TX ON				Line AC / Freq	DC 12Volts				
Standard	CFR47 Part 15 Subpart C				RBW / VBW	120 kHz/300 kHz				
Dist/Ant Used	3m / EMCO3115 / 1m - RA42-K-F-4B-C				Performed by	Suresh Kondapalli				
Frequency	Peak	Gen	Cable Loss	Antenna Gain	EIRP	Antenna POL	Table deg	Height cm	Limit dBm	Margin dB
MHz	dBuV/m	dBm	dB	dbi	dBm	POL	deg	cm	dBm	dB
Transmitted Data at 217 MHz GMSK/16 QPSK/32 QPSK										
81.31	58.46	-38.37	1.29	0.23	-39.43	V	110	281	-25.00	-14.43
201.598	54.89	-48.49	1.89	3.65	-46.74	H	277	178	-25.00	-21.74
434.982	55.28	-49.31	2.72	6.1	-45.93	H	103	285	-25.00	-20.93
475.002	45.49	-56.51	2.85	6.3	-53.06	V	116	167	-25.00	-28.06
652.496	48.92	-53.16	3.28	6.95	-49.50	V	124	128	-25.00	-24.50
652.505	56.25	-48.03	3.28	6.3	-45.01	H	109	321	-25.00	-20.01
869.985	71.91	-32.19	3.88	6.7	-29.37	H	106	315	-25.00	-4.37
870.01	68.61	-33.01	3.88	7.1	-29.79	V	110	181	-25.00	-4.79
Spec Margin = E-Field QP - Limit, E-Field QP = FIM QP+ Total CF ± Uncertainty										
Total CF= Amp Gain + Cable Loss + ANT Factor										
Combined Standard Uncertainty $u_c(y) = \pm 3.2$ dB Expanded Uncertainty $U = k u_c(y)$ $k = 2$ for 95% confidence										
Notes : Table combines all data rate/modulations										

SOP 1 Radiated Emissions						Tracking # 31260509.004 Page 6 of 21				
EUT Name		TransAir PTC-3006				Date		04/17/2012		
EUT Model		PTC-3006				Temp / Hum in		23°C / 39%rh		
EUT Serial		D1-10				Temp / Hum out		N/A		
EUT Config.		PTC-3006				Line AC / Freq		DC 12Volts		
Standard		CFR47 Part 15 Subpart C				RBW / VBW		120 kHz/300 kHz		
Dist/Ant Used		3m / EMCO3115 / 1m - RA42-K-F-4B-C				Performed by		Suresh Kondapalli		
Frequency Peak	Gen	Cable Loss	Antenna Gain	EIRP	Antenna	Table	Height	Limit	Margin	
MHz	dBuV/m	dBm	dB	dbi	dBm	POL	deg	cm	dBm	dB
Transmitted Data GMSK/16 QPSK/32 QPSK all Channels combined TX on 217.5 MHz										
1102.49	41.73	-72.0	1.24	6.76	-67.48	V	17	121	-25.0	-42.48
1466.78	35.21	-72.2	1.34	7.76	-65.78	V	40	111	-25.0	-40.78
1984.48	37.88	-79.3	1.5	8.81	-71.90	H	54	148	-25.0	-46.90
2125.76	35.99	-73.4	1.7	9.32	-65.78	H	35	143	-25.0	-40.78
2666.8	28.94	-53.5	1.7	9.41	-45.80	H	48	143	-25.0	-20.80
2866.52	45.92	-73.4	1.8	9.41	-65.79	H	38	137	-25.0	-40.79
Spec Margin = E-Field QP - Limit, E-Field QP = FIM QP+ Total CF ± Uncertainty Total CF= Amp Gain + Cable Loss + ANT Factor										
Combined Standard Uncertainty $u_c(y) = \pm 3.2$ dB Expanded Uncertainty $U = ku_c(y)$ $k = 2$ for 95% confidence										
Notes: EUT is Class A device; Table combines all data rates/modulations GMSK/16 QPSK/32 QPSK										

SOP 1 Radiated Emissions

Tracking # 31260509.004 Page 7 of 21

EUT Name	TransAir PTC-3006	Date	04/02/2012
EUT Model	PTC-3006	Temp / Hum in	23°C / 39%rh
EUT Serial	D1-10	Temp / Hum out	N/A
EUT Config.	TX ON	Line AC	12 Vdc
Standard	CFR47 Part 90	RBW / VBW	120 kHz/300 kHz
Dist/Ant Used	3m - EMCO3115 / 1m - RA42-K-F-4B-C	Performed by	Suresh Kondapalli

30 MHz to 1GHz Plot for Transmit Mode: 220.0125 MHz at GMSK

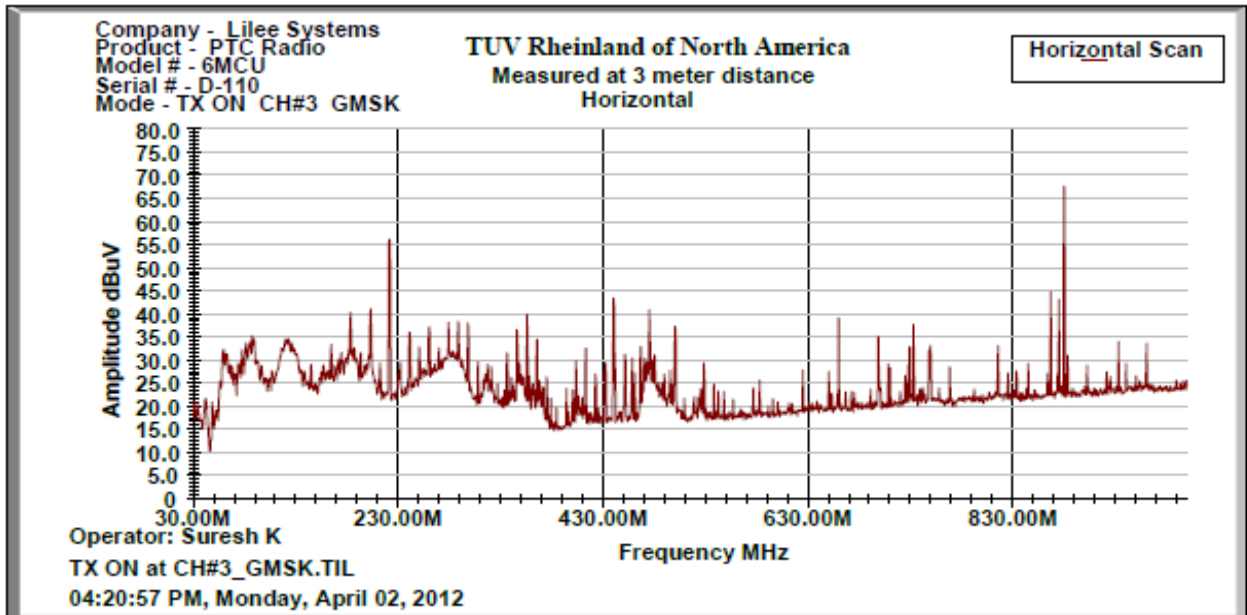
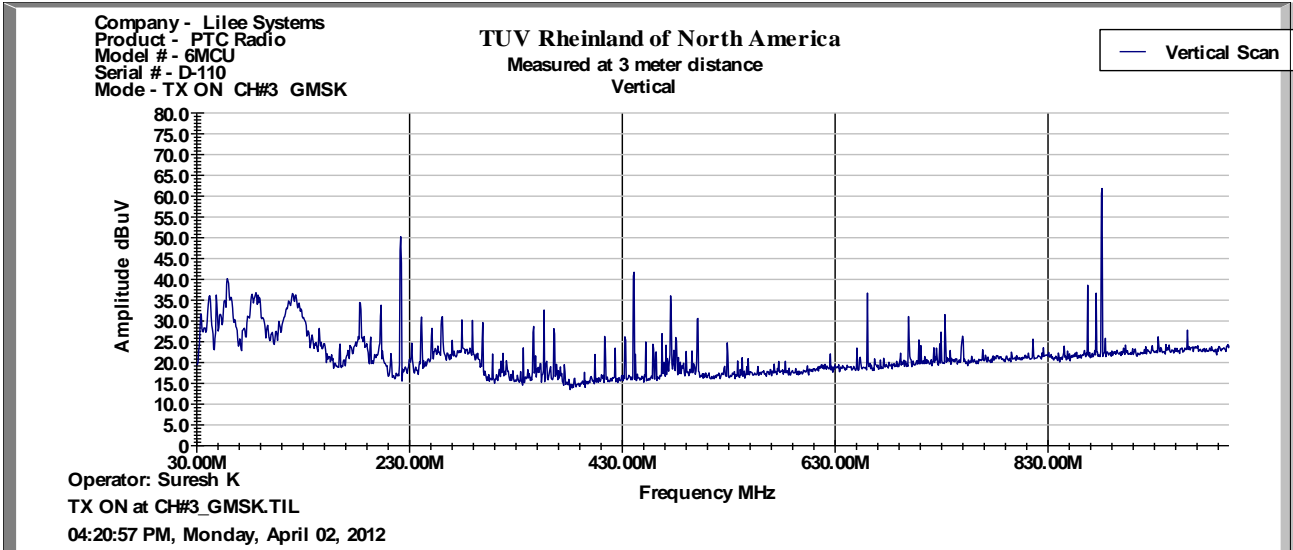

Notes: None

SOP 1 Radiated Emissions

Tracking # 31260509.004 Page 8 of 21

EUT Name	TransAir PTC-3006	Date	04/02/2012
EUT Model	PTC-3006	Temp / Hum in	23°C / 39%rh
EUT Serial	D1-10	Temp / Hum out	N/A
EUT Config.	TX ON	Line AC	12 Vdc
Standard	CFR47 Part 90	RBW / VBW	120 kHz/300 kHz
Dist/Ant Used	3m - EMCO3115 / 1m - RA42-K-F-4B-C	Performed by	Suresh Kondapalli

30 MHz to 1GHz Plot for Transmit Mode: TX On 220.0125MHz 16 QPSK

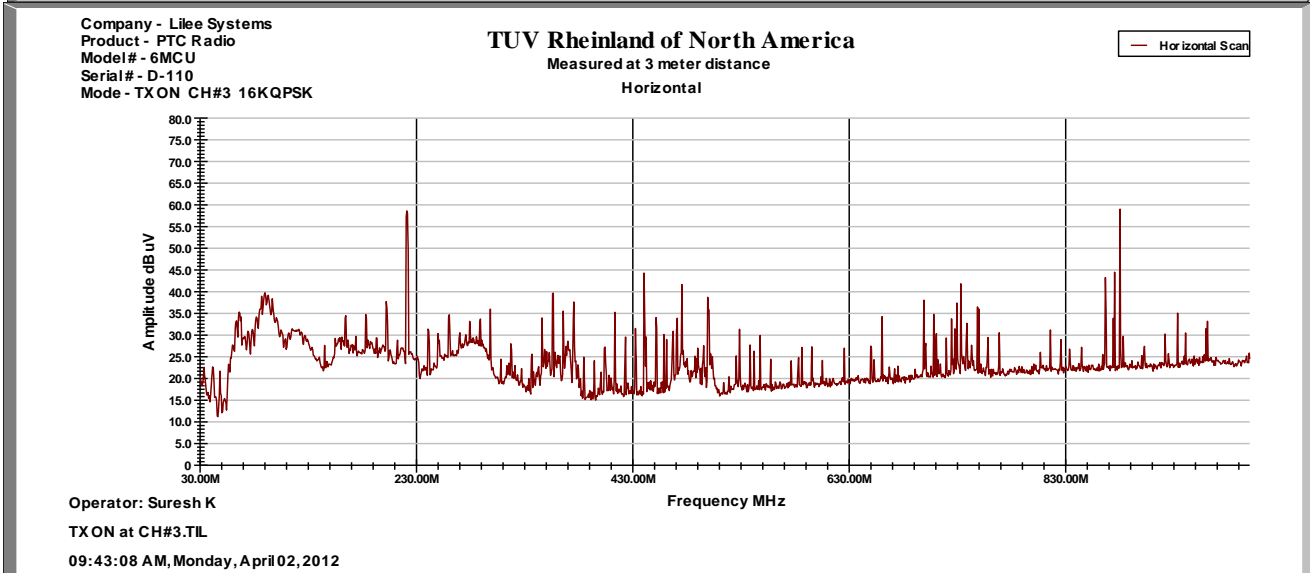
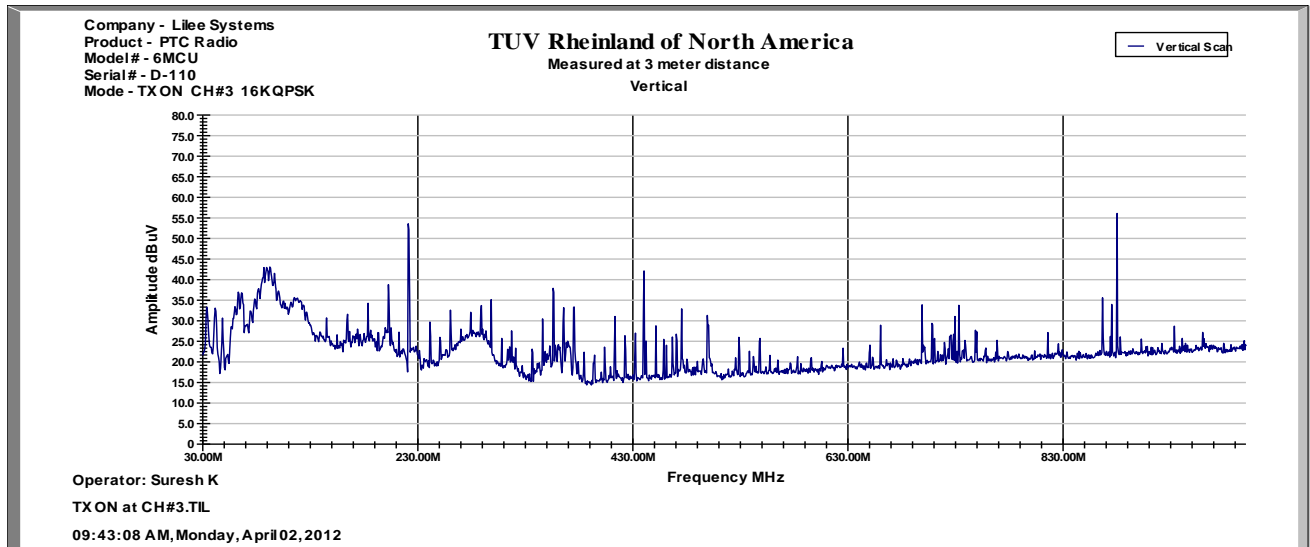

Notes: None

SOP 1 Radiated Emissions

Tracking # 31260509.004 Page 9 of 21

EUT Name	TransAir PTC-3006	Date	04/02/2012
EUT Model	PTC-3006	Temp / Hum in	23°C / 39%rh
EUT Serial	D1-10	Temp / Hum out	N/A
EUT Config.	TX ON	Line AC	12 Vdc
Standard	CFR47 Part 90	RBW / VBW	120 kHz/300 kHz
Dist/Ant Used	3m - EMCO3115 / 1m - RA42-K-F-4B-C	Performed by	Suresh Kondapalli

30 MHz to 1GHz Plot for Transmit Mode: 32 QPSK 220.0125 MHz

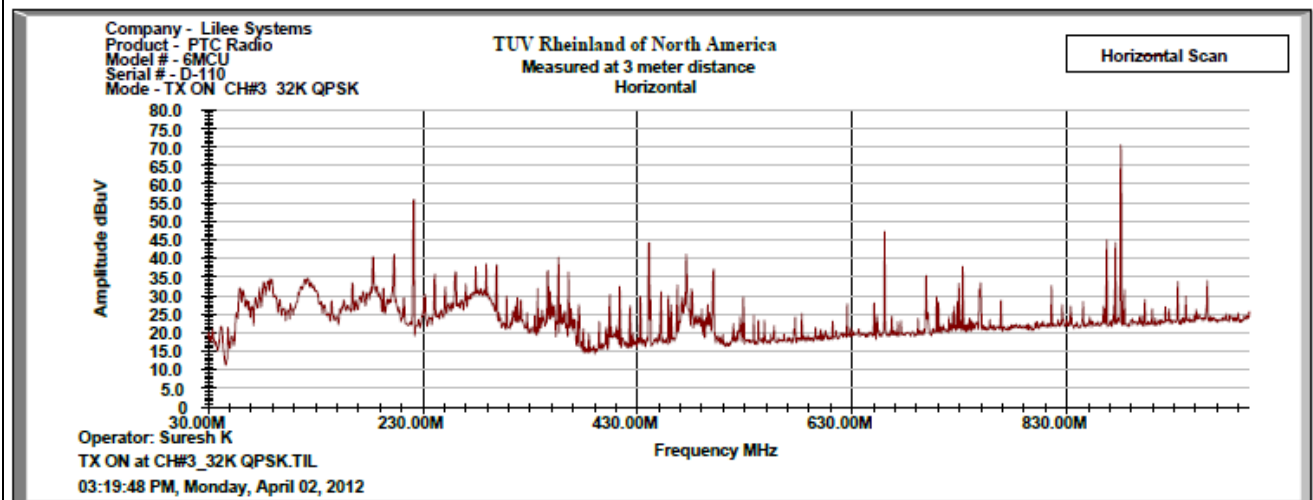
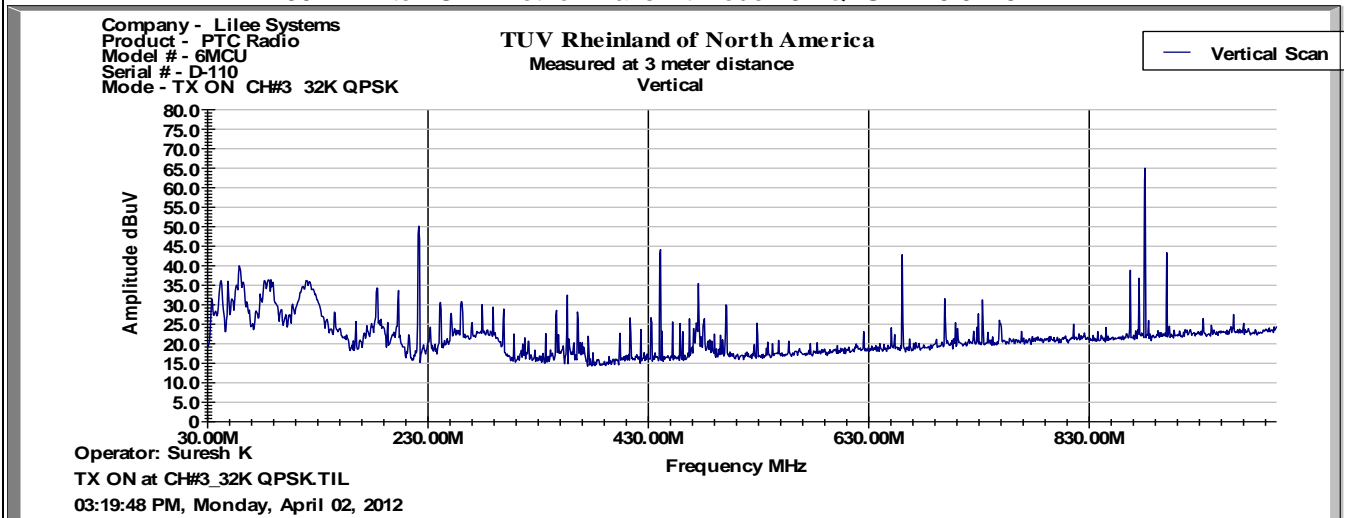

Notes: None

SOP 1 Radiated Emissions

Tracking # 31260509.004 Page 10 of 21

EUT Name	TransAir PTC-3006	Date	April 05, 2012
EUT Model	PTC-3006	Temp / Hum in	23°C / 40%rh
EUT Serial	D1-10	Temp / Hum out	N/A
EUT Config.	TX ON	Line AC	12 Vdc
Standard	CFR47 Part 15 Part90	RBW / VBW	120/300 kHz
Dist/Ant Used	3m - EMCO3115 / 1m - RA42-K-F-4B-C	Performed by	Suresh Kondapalli

Operating Freq 220.0125 MHz at GMSK

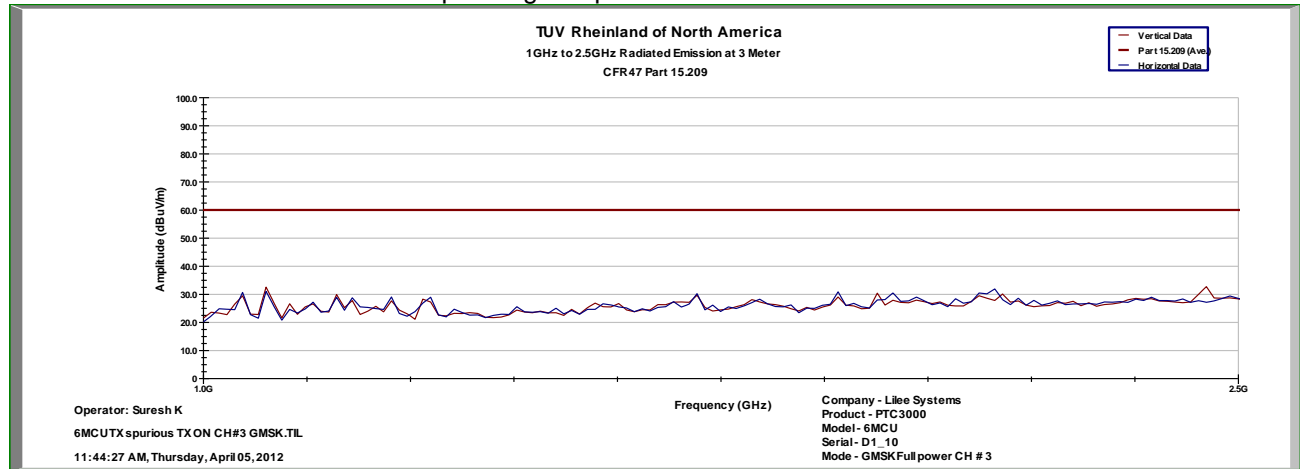

32 QPSK

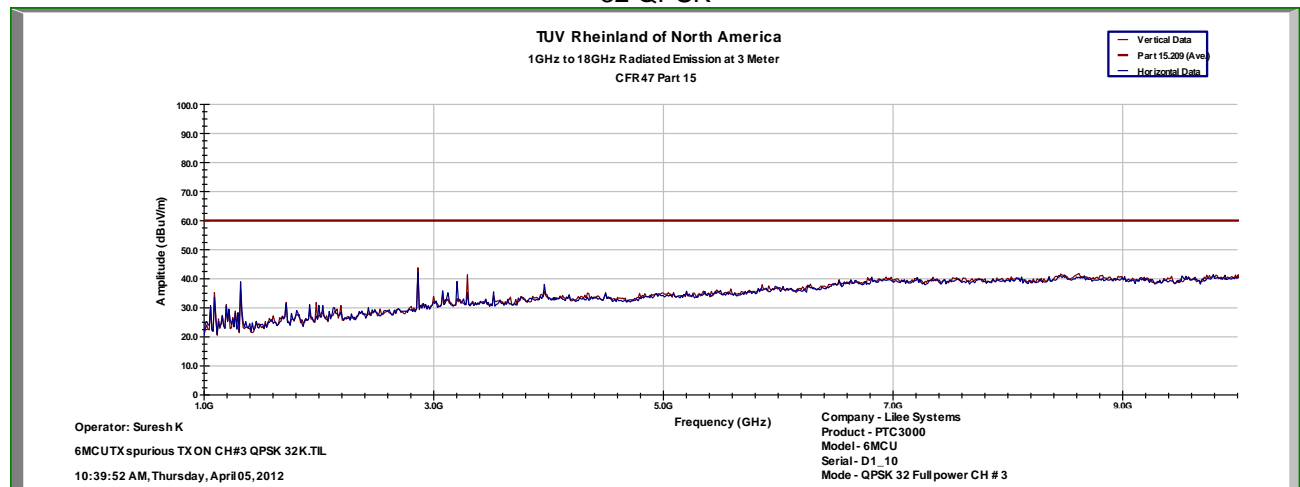

Notes:

SOP 1 Radiated Emissions					Tracking # 31260509.004 Page 11 of 21					
EUT Name	TransAir PTC-3200				Date	April 02 & 08, 2012				
EUT Model	PTC-3006				Temp / Hum in	23°C / 39%rh				
EUT Serial	D1-10				Temp / Hum out	N/A				
EUT Config.	TX ON				Line AC / Freq	12 Vdc				
Standard	CFR47 Part 15 part 90				RBW / VBW	120/300 kHz				
Dist/Ant Used	3m / EMCO3115 / 1m - RA42-K-F-4B-C				Performed by	Suresh Kondapalli				
Frequency	Peak	Gen	Cable	Antenna	EIRP	Antenna	Table	Height	Limit	Margin
MHz	dBuV/m	dBm	Loss	Gain	dBm	POL	deg	cm	dBm	dB
Transmitted Data 220.0125 MHz at GMSK/16 QPSK/32 QPSK										
107.84	38.10	-59.21	1.44	-1.45	-62.10	H	20	119	-25.00	-37.10
335.99	42.59	-60.38	2.41	6.42	-56.37	V	175	103	-25.00	-31.37
374.39	49.07	-55.97	2.52	6.09	-52.40	H	255	216	-25.00	-27.40
440.02	63.86	-37.91	2.73	6.50	-34.13	V	248	175	-25.00	-9.13
624.98	54.47	-49.54	3.24	6.30	-46.48	H	134	119	-25.00	-21.48
660.03	37.23	-67.07	3.35	6.60	-63.82	H	50	108	-25.00	-38.82
880.04	67.03	-34.33	3.90	7.00	-31.23	V	41	107	-25.00	-6.23
1100.07	47.11	-68.0	1.24	6.76	-62.48	H	128	106	-25.00	-37.48
1666.66	42.60	-69.2	1.56	7.6	-61.60	H	-26	106	-25.00	-36.6
1980.22	44.89	-75.43	1.8	8.81	-68.42	H	4	111	-25.00	-43.43
Spec Margin = E-Field QP - Limit, E-Field QP = FIM QP+ Total CF ± Uncertainty										
Total CF= Amp Gain + Cable Loss + ANT Factor										
Combined Standard Uncertainty $u_c(y) = \pm 3.2$ dB Expanded Uncertainty $U = k u_c(y)$ $k = 2$ for 95% confidence										
Notes EUT is Class A device										
Table combines all data rates/modulations										

SOP 1 Radiated Emissions

Tracking # 31260509.004 Page 12 of 2
 1

EUT Name	TransAir PTC-3006	Date	April 03, 2012
EUT Model	PTC-3006	Temp / Hum in	23°C / 40%rh
EUT Serial	D1-10	Temp / Hum out	N/A
EUT Config.	TX ON	Line AC	12 Vdc
Standard	CFR47 Part 90	RBW / VBW	120/300 kHz
Dist/Ant Used	3m - EMCO3115 / 1m - RA42-K-F-4B-C	Performed by	Suresh Kondapalli

30 MHz to 1GHz Plot for Transmit Mode: 220.9875MHz GMSK

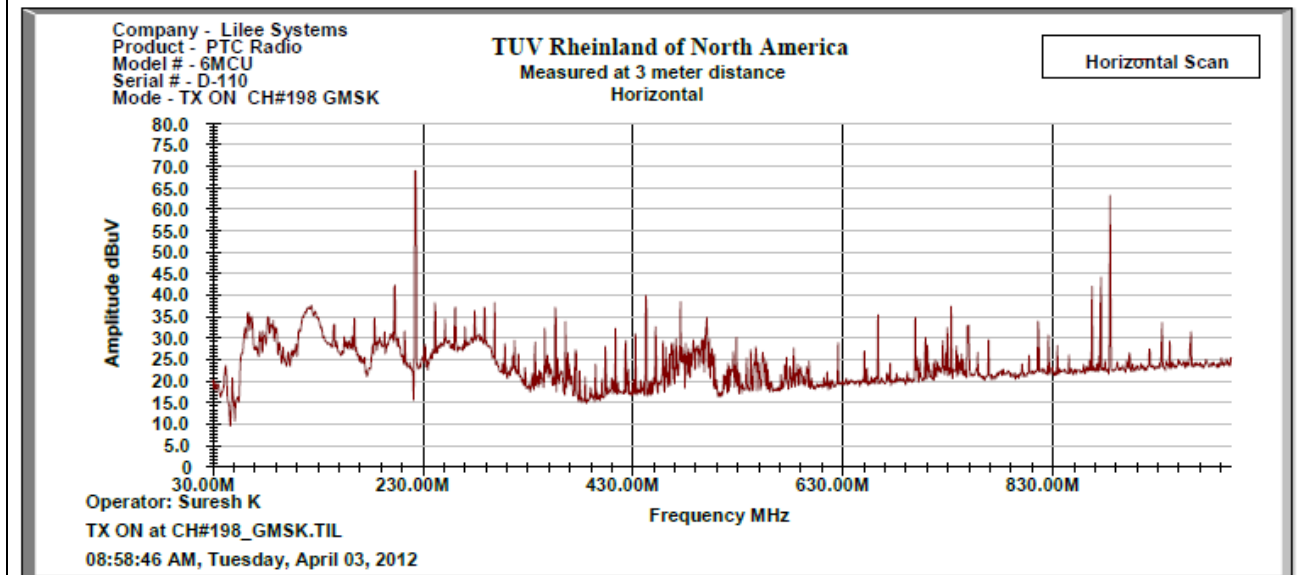
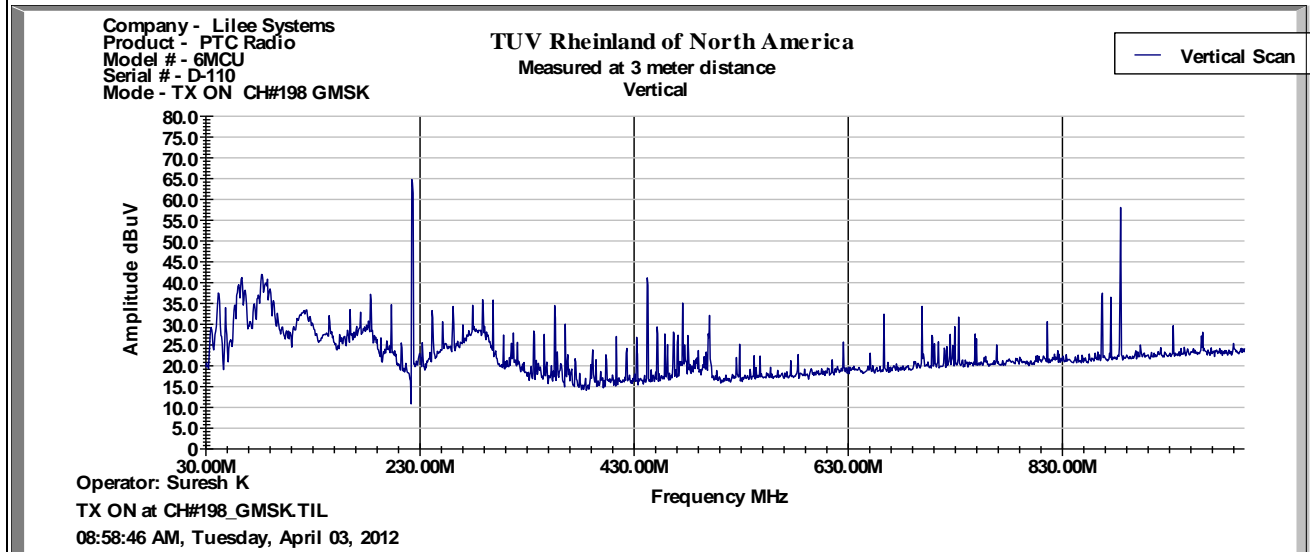

None

SOP 1 Radiated Emissions

Tracking # 31260509.004 Page 13 of 21

EUT Name	TransAir PTC-3006	Date	04/02/2012
EUT Model	PTC-3006	Temp / Hum in	23°C / 39%rh
EUT Serial	D110	Temp / Hum out	N/A
EUT Config.	TX ON	Line AC	12 Vdc
Standard	CFR47 Part 15 Part 90	RBW / VBW	120 kHz/300 kHz
Dist/Ant Used	3m - EMCO3115 / 1m - RA42-K-F-4B-C	Performed by	Suresh Kondapalli

30 to 1000 MHz Plot for Transmit Mode: Operating Freq 220.9875 MHz att0 max power

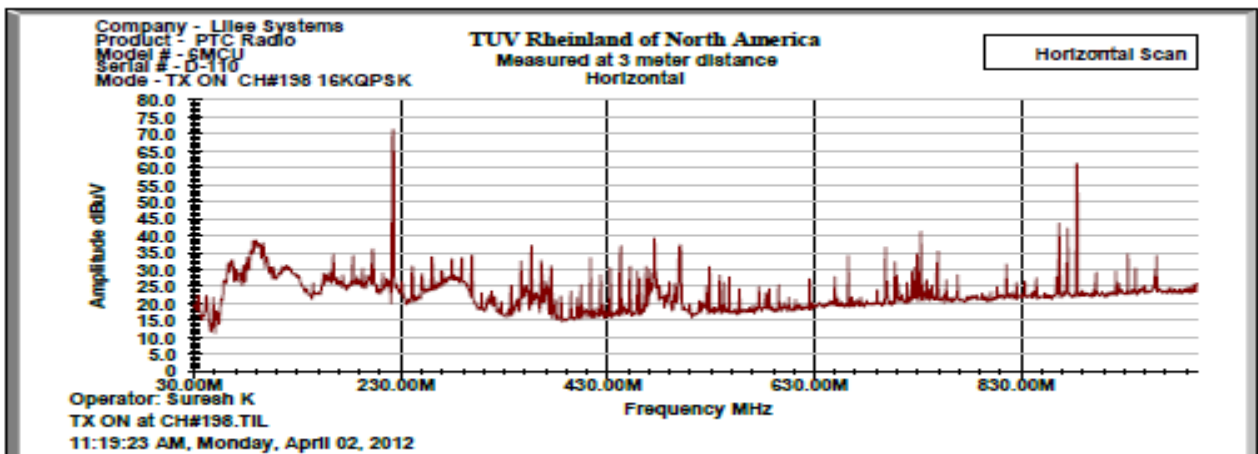
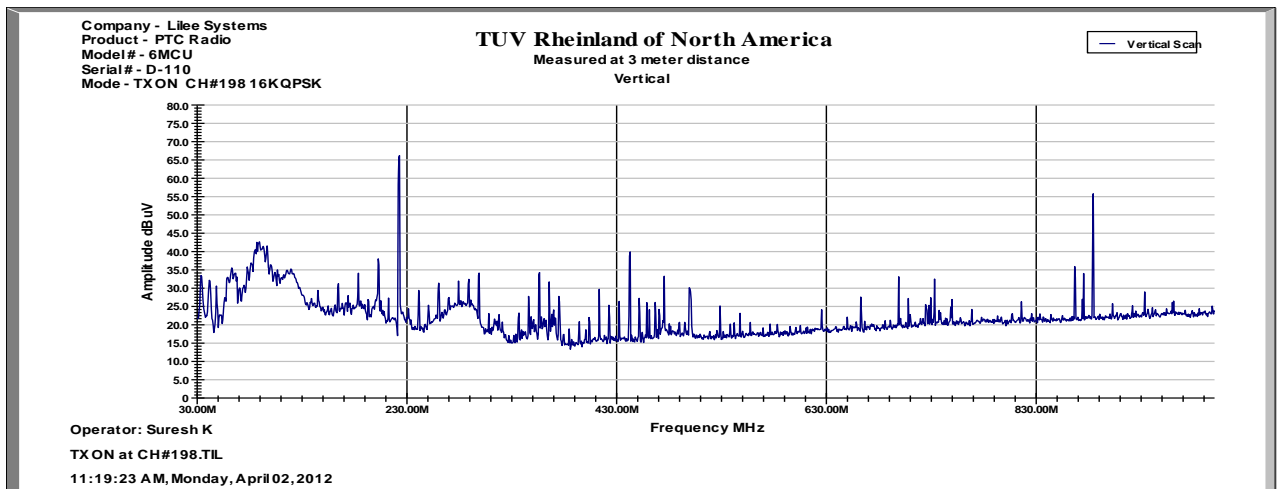

Notes: None

SOP 1 Radiated Emissions

Tracking # 31260509.004 Page 14 of 21

EUT Name	TransAir PTC-3006	Date	April 02, 2012
EUT Model	PTC-3006	Temp / Hum in	23°C / 40%rh
EUT Serial	D110	Temp / Hum out	N/A
EUT Config.	GMSK Max power	Line AC	12 Vdc
Standard	CFR47 Part 15 Part9	RBW / VBW	120 kHz/300 kHz
Dist/Ant Used	3m - EMCO3115 / 1m - RA42-K-F-4B-C	Performed by	Suresh Kondapalli

30 MHz to 1GHz Plot for Transmit Mode Operating Freq 220.9875 MHz att0 max power 32 QPSK

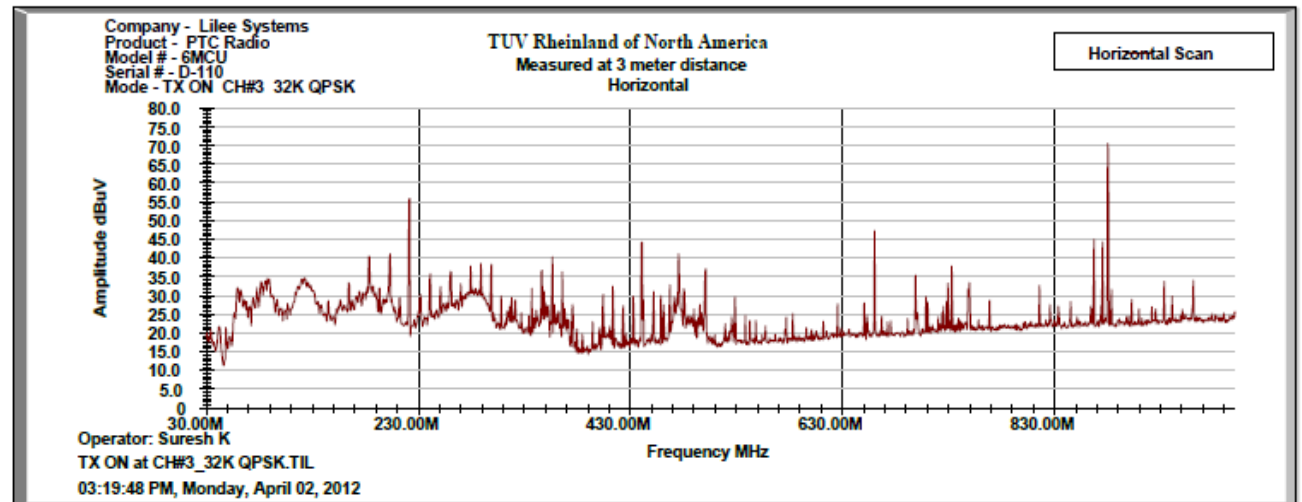
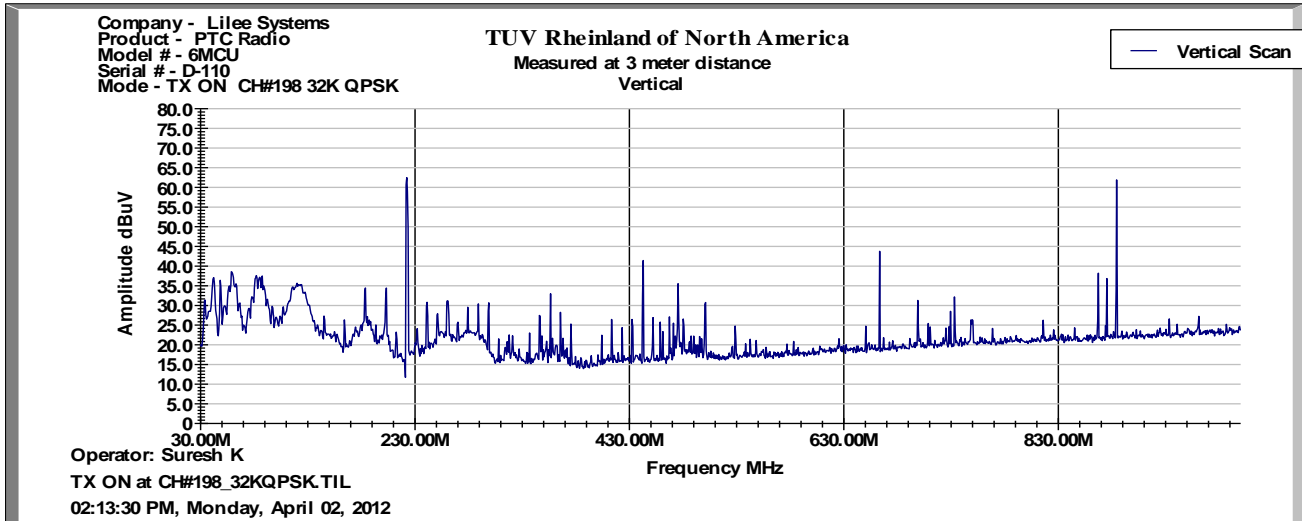

Notes:

SOP 1 Radiated Emissions

Tracking # 31260509.004 Page 15 of 21

EUT Name	TransAir PTC-3006	Date	04/05/2012
EUT Model	PTC-3006	Temp / Hum in	23°C / 39%rh
EUT Serial	D110	Temp / Hum out	N/A
EUT Config.	TX ON	Line AC	12 Vdc
Standard	CFR47 Part 15 Part 90	RBW / VBW	120 kHz/300 kHz
Dist/Ant Used	3m - EMCO3115 / 1m - RA42-K-F-4B-C	Performed by	Suresh Kondapalli

1 to 2.5GHz Plot for Transmit Mode: Operating Freq 220.9875 MHz att0 max power GMSK

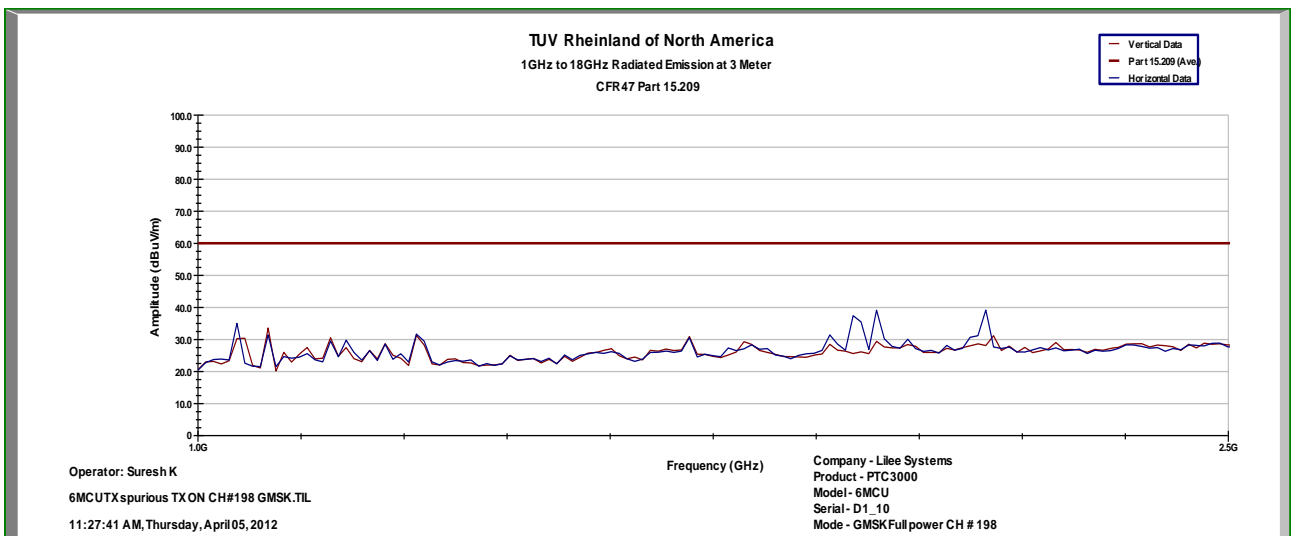

32 QPSK

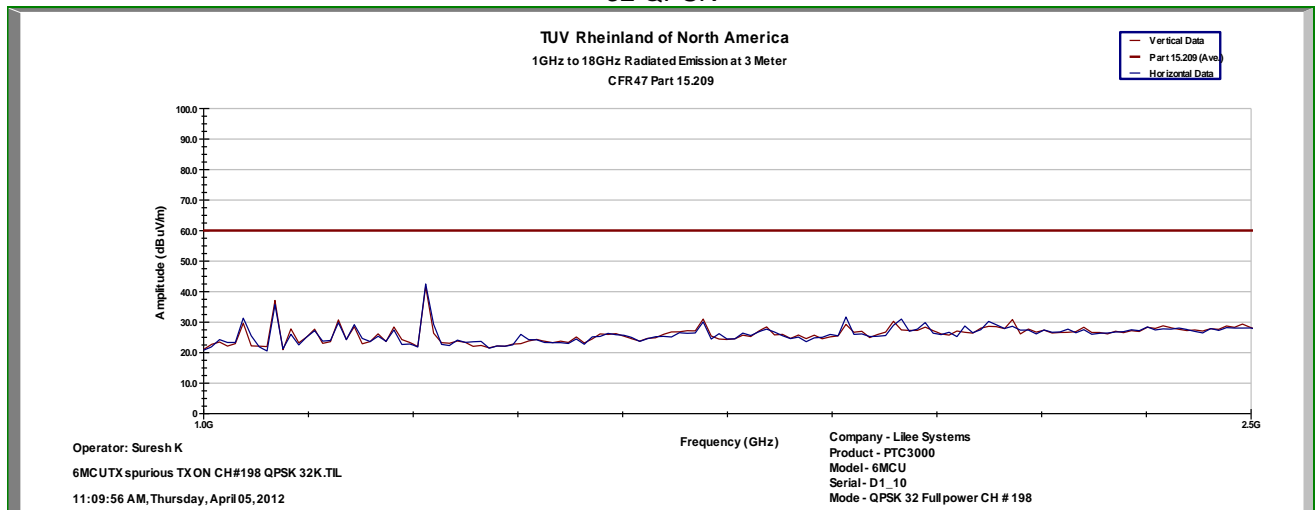

Notes: None

SOP 1 Radiated Emissions					Tracking # 31260509.004 Page 16 of 21					
EUT Name		TransAir PTC-3006			Date		April 18, 2012			
EUT Model		PTC-3006			Temp / Hum in		23°C / 39%rh			
EUT Serial		D110			Temp / Hum out		N/A			
EUT Config.		TX ON			Line AC / Freq		12 Vdc			
Standard		CFR47 Part 15 Subpart C			RBW / VBW		120/300 kHz			
Dist/Ant Used		3m / EMCO3115 / 1m - RA42-K-F-4B-C			Performed by		Suresh Kondapalli			
Frequency	Peak	Gen	Cable Loss	Antenna Gain	EIRP	Antenna POL	Table deg	Height cm	Limit dBm	Margin dB
MHz	dBuV/m	dBm	dB	dbi	dBm	POL	deg	cm	dBm	dB
Transmitted Data 220.9875 GMSK/16 QPSK/32 QPSK										
42.25	58.00	-31.91	0.98	-8.90	-41.79	V	0	100	-25	-16.79
66.75	62.10	-32.48	1.17	-1.02	-34.67	V	204	150	-25	-9.67
66.75	51.97	-44.15	1.17	-1.50	-46.82	H	262	200	-25	-21.82
122.00	49.24	-47.45	1.51	-2.06	-51.02	H	88	200	-25	-26.02
199.90	47.76	-54.83	1.89	3.21	-53.50	H	88	149	-25	-28.50
413.42	46.55	-55.25	2.65	6.23	-51.67	V	164	100	-25	-26.67
423.00	49.86	-54.62	2.68	5.90	-51.39	H	164	100	-25	-26.39
432.02	57.24	-47.28	2.71	6.04	-43.95	H	164	100	-25	-18.95
441.00	68.01	-36.53	2.73	6.20	-33.05	H	164	100	-25	-8.05
441.60	62.40	-39.42	2.73	6.50	-35.65	V	164	100	-25	-10.65
452.00	50.50	-53.89	2.77	6.26	-50.39	H	164	100	-25	-25.39
881.98	54.30	-47.02	3.90	7.00	-43.93	V	215	100	-25	-18.93
882.60	53.10	-51.10	3.91	6.65	-48.35	H	215	100	-25	-23.35
Spec Margin = E-Field QP - Limit, E-Field QP = FIM QP+ Total CF ± Uncertainty										
Total CF= Amp Gain + Cable Loss + ANT Factor										
Combined Standard Uncertainty $u_c(y) = \pm 3.2$ dB Expanded Uncertainty $U = ku_c(y)$ $k = 2$ for 95% confidence										
Notes EUT is Class A device										

SOP 1 Radiated Emissions

Tracking # 31260509.004 Page 17 of 21

EUT Name	TransAir PTC-3006	Date	May 16, 2012
EUT Model	PTC-3006	Temp / Hum in	23°C / 40%rh
EUT Serial	D110	Temp / Hum out	N/A
EUT Config.	16 QPSK max power	Line AC	12 Vdc
Standard	CFR47 Part 15 Subpart C	RBW / VBW	120/300 kHz
Dist/Ant Used	3m - EMCO3115 / 1m - RA42-K-F-4B-C	Performed by	Suresh Kondapalli

TX ON 222 MHz at GMSK

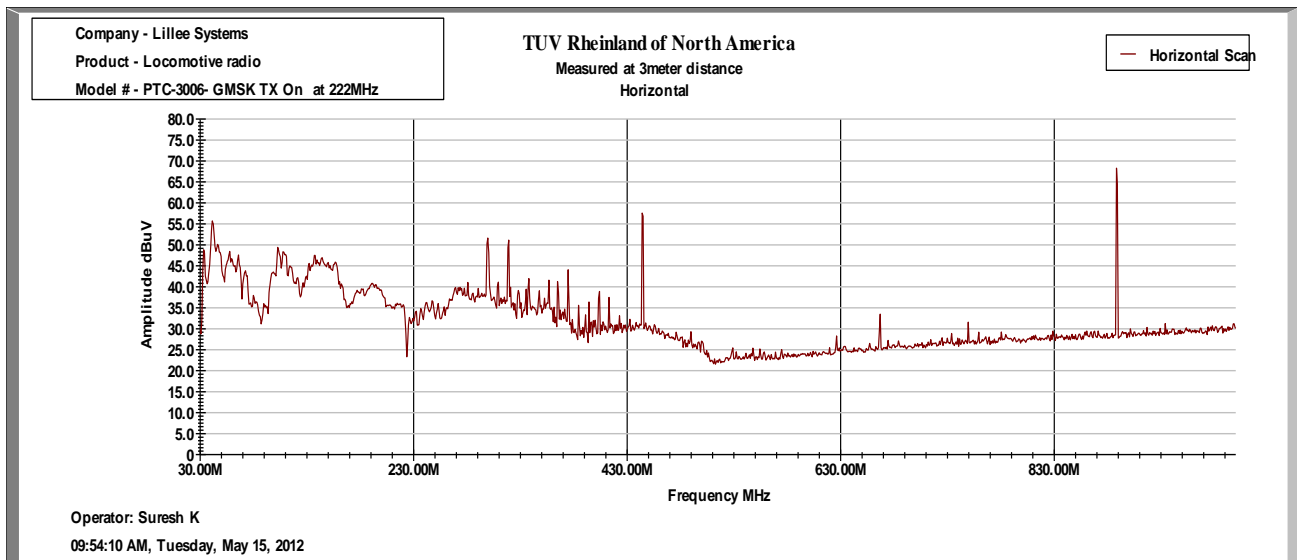
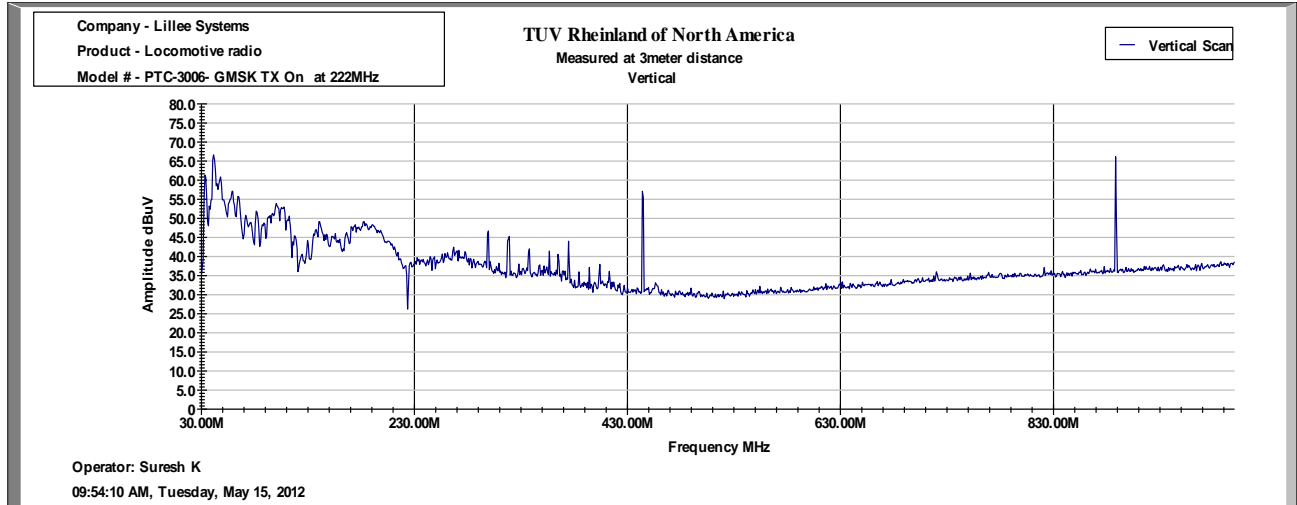

Note: None

SOP 1 Radiated Emissions

Tracking # 31260509.004 Page 18 of 21

EUT Name	TransAir PTC-3006	Date	May 16, 2012
EUT Model	PTC-3006	Temp / Hum in	23°C / 40%rh
EUT Serial	D110	Temp / Hum out	N/A
EUT Config.	16 QPSK max power	Line AC	12 Vdc
Standard	CFR47 Part 15 Subpart C	RBW / VBW	120/300 kHz
Dist/Ant Used	3m - EMCO3115 / 1m - RA42-K-F-4B-C	Performed by	Suresh Kondapalli

TX ON 222 MHz at 16 QPSK

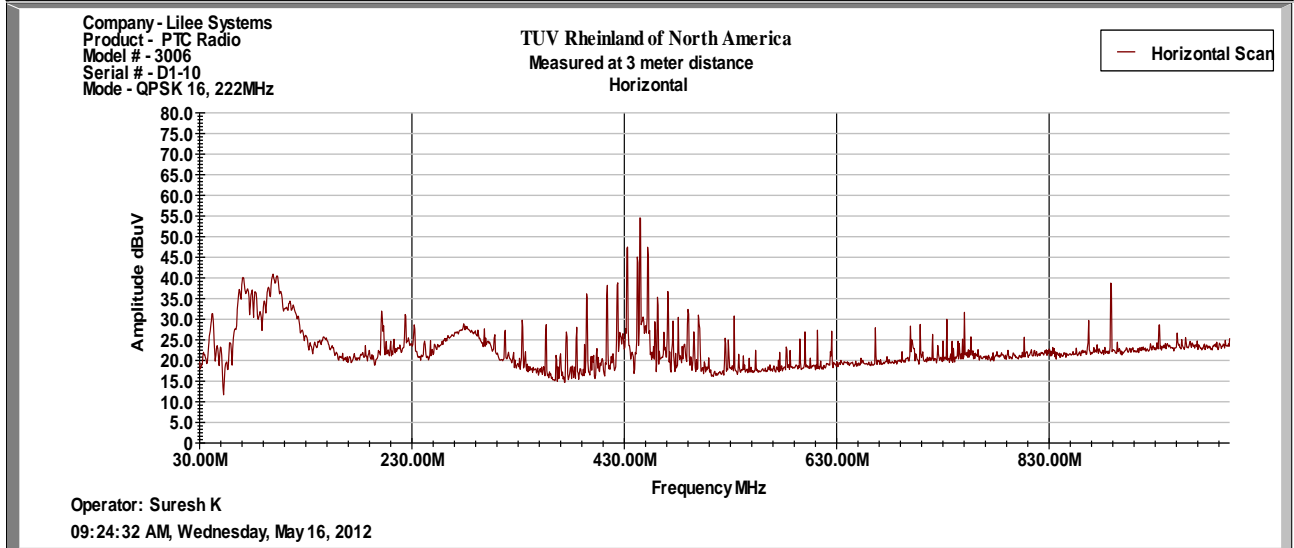
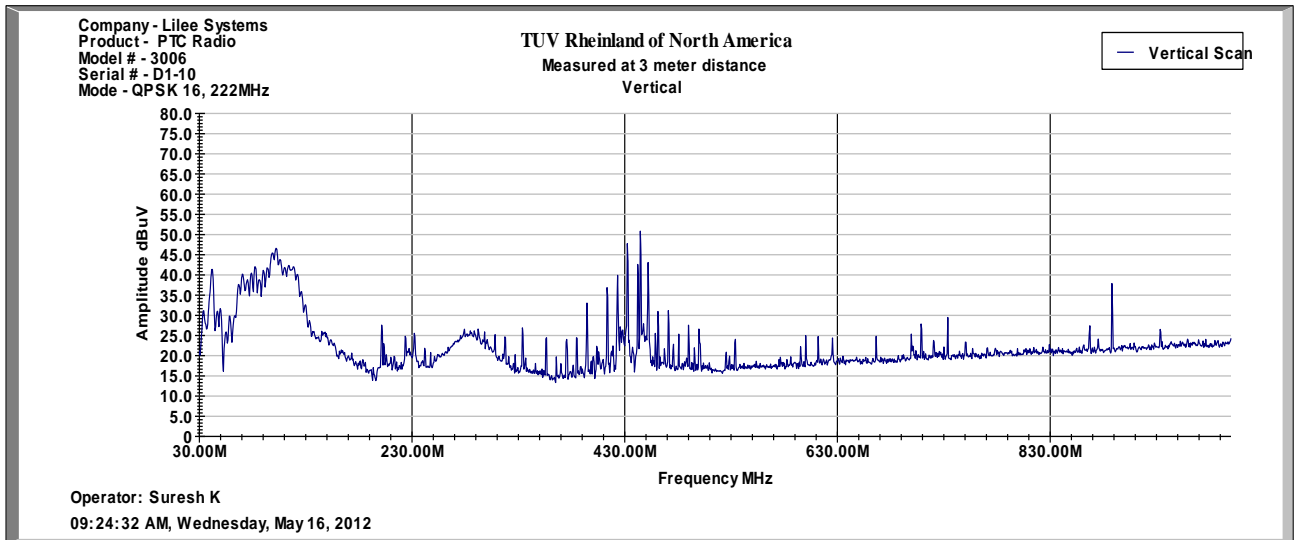

Notes: None

SOP 1 Radiated Emissions

Tracking # 31260509.004 Page 19 of 21

EUT Name	TransAir PTC-3006	Date	May 15, 2012
EUT Model	PTC-3006	Temp / Hum in	23°C / 40%rh
EUT Serial	D110	Temp / Hum out	N/A
EUT Config.	16 QPSK max power	Line AC	12 Vdc
Standard	CFR47 Part 15 Subpart C	RBW / VBW	120/300 kHz
Dist/Ant Used	3m - EMCO3115 / 1m - RA42-K-F-4B-C	Performed by	Suresh Kondapalli

TX ON 222 MHz at 32 QPSK

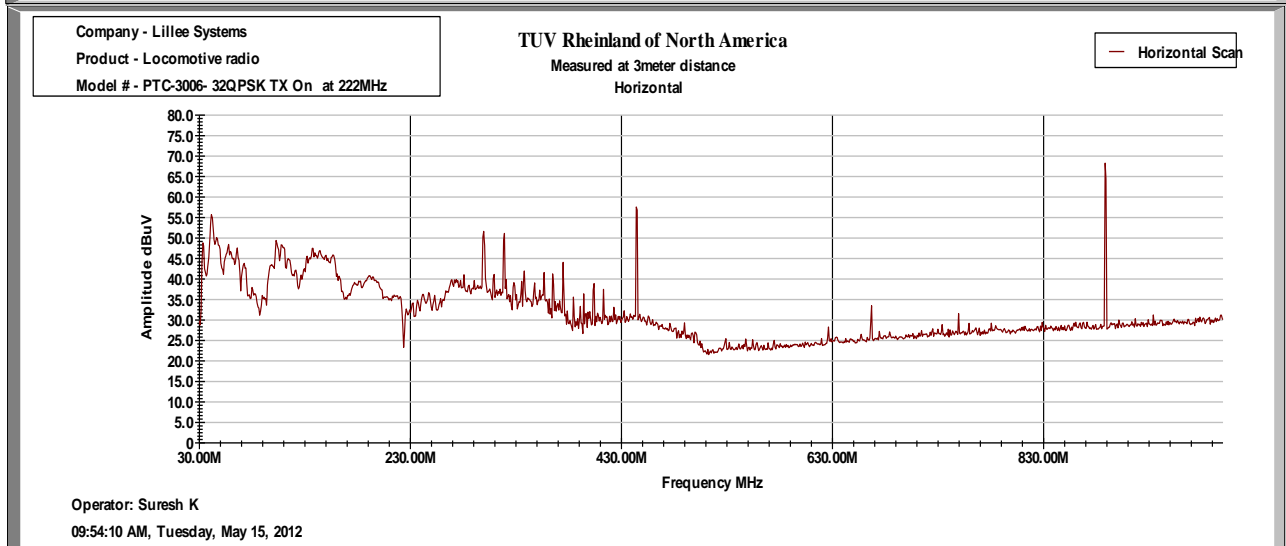
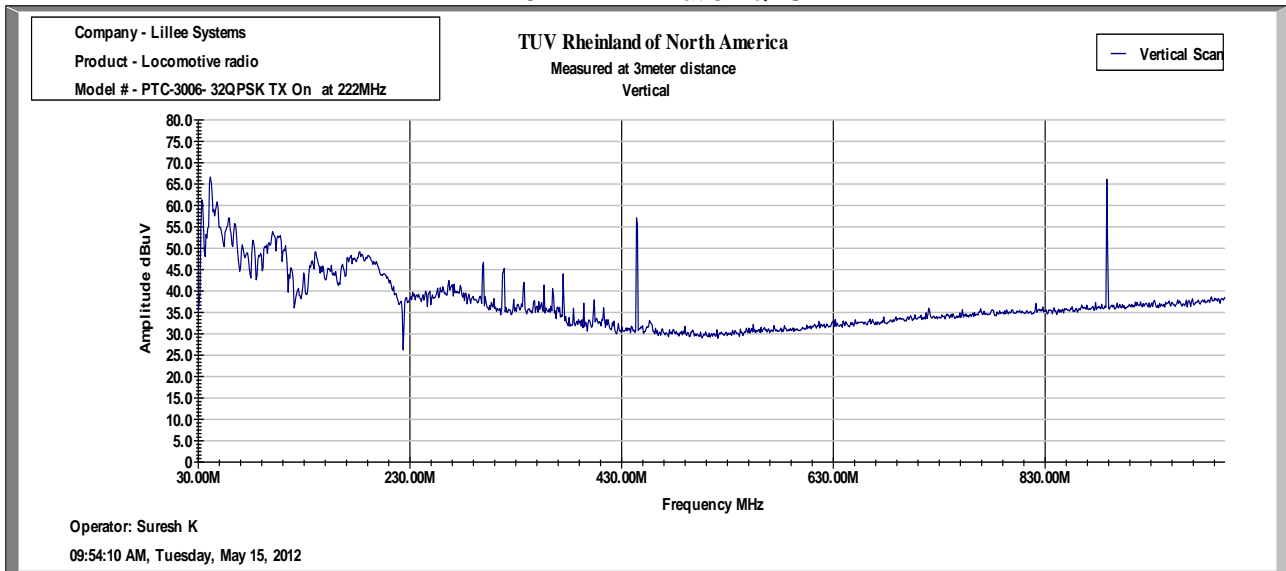

Notes: None

SOP 1 Radiated Emissions

Tracking # 31260509.004 Page 20 of 21

EUT Name	TransAir PTC-3006	Date	May 16, 2012
EUT Model	PTC-3006	Temp / Hum in	23°C / 40%rh
EUT Serial	D110	Temp / Hum out	N/A
EUT Config.	16 QPSK max power	Line AC	12 Vdc
Standard	CFR47 Part 15 Subpart C	RBW / VBW	120/300 kHz
Dist/Ant Used	3m - EMCO3115 / 1m - RA42-K-F-4B-C	Performed by	Suresh Kondapalli

TX ON 222 MHz at 16 QPSK

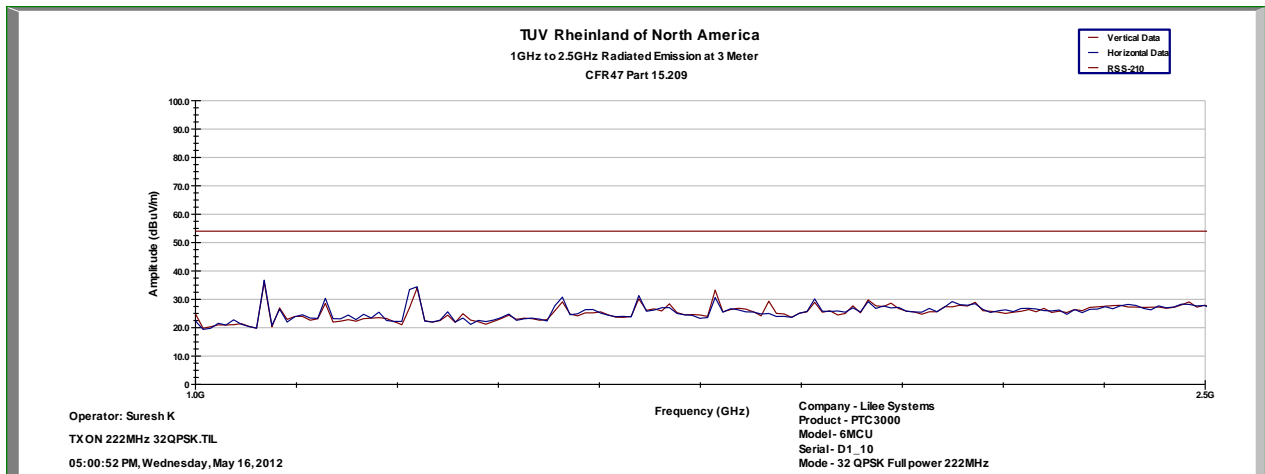

Notes: None

SOP 1 Radiated Emissions					Tracking # 31260509.004 Page 21 of 21					
EUT Name		TransAir-PTC3006			Date		May 16, 2012			
EUT Model		PTC-3006			Temp / Hum in		23°C / 39%rh			
EUT Serial		D1-10			Temp / Hum out		N/A			
EUT Config.		TX ON			Line AC / Freq		12 Vdc			
Standard		CFR47 Part 15 Subpart C			RBW / VBW		120/300 kHz			
Dist/Ant Used		3m / EMCO3115 / 1m - RA42-K-F-4B-C			Performed by		Suresh Kondapalli			
Frequency	Peak	Gen	Cable Loss	Antenna Gain	EIRP	Antenna POL	Table deg	Height cm	Limit dBm	Margin dB
MHz	dBuV/m	dBm	dB	dbi	dBm	POL	deg	cm	dBm	dB
Transmitted Data 222 MHz at GMSK/16 QPSK/32 QPSK										
69.43	58.04	-37.70	1.21	-1.36	-40.24	H	285	203	-25	-15.24
76.78	56.44	-41.17	1.25	-0.42	-42.84	H	260	240	-25	-17.84
100.80	59.41	-33.57	1.39	-0.64	-35.6	V	25	110	-25	-10.60
431.99	53.90	-47.70	2.71	6.5	-43.91	V	89	110	-25	-18.91
443.99	67.56	-34.38	2.73	6.5	-30.62	V	334	110	-25	-5.62
444.00	67.52	-36.94	2.73	6.2	-33.48	H	339	104	-25	-8.48
665.99	42.04	-60.09	3.36	7.02	-56.44	V	9	110	-25	-31.44
887.98	57.30	-44.07	3.91	7.0	-40.97	V	82	127	-25	-15.97
887.99	57	-47.3	3.91	6.76	-44.45	H	111	215	-25	-21.45
Spec Margin = E-Field QP - Limit, E-Field QP = FIM QP+ Total CF ± Uncertainty										
Total CF= Amp Gain + Cable Loss + ANT Factor										
Combined Standard Uncertainty $u_c(y) = \pm 3.2$ dB Expanded Uncertainty $U = ku_c(y)$ $k = 2$ for 95% confidence										
Notes EUT is Class A device Table combines all data rates/modulations GMSK/16 QPSK/32 QPSK										

Sample Calculation

The field strength is calculated by subtracting the Amplifier Gain and adding the Cable Loss and Antenna Correction Factor to the measured reading. The basic equation is as follows:

$$\text{Field Strength (dB}\mu\text{V/m)} = \text{FIM} - \text{AMP} + \text{CBL} + \text{ACF}$$

Where: FIM = Field Intensity Meter (dBμV)
 AMP = Amplifier Gain (dB)
 CBL = Cable Loss (dB)
 ACF = Antenna Correction Factor (dB/m)

$$\mu\text{V/m} = 10^{\frac{\text{dB}\mu\text{V} / \text{m}}{20}}$$

4.6 Receiver Spurious Emissions

Receiver spurious emissions are emissions at any frequency when the equipment is in receive mode.

The spurious emissions of the receiver shall not exceed the values in CFR47 Part 15.109 and RSS GEN Sect 6.1.

4.6.1 Test Methodology

4.6.1.1 Preliminary Test

A test program that controls instrumentation and data logging was used to automate the preliminary RF emission test procedure. The frequency range of interest was divided into sub-ranges to yield a frequency resolution of approximately 120 kHz and provide a reading at each frequency for no more than 12° of turntable rotation. For each frequency sub-range the turntable was rotated 360° while peak emission data was recorded and plotted over the frequency range of interest in horizontal and vertical antenna polarization's.

Preliminary emission profile testing was performed inside the anechoic chamber. The EUT was placed on a 1.0m x 1.5m non-conductive table 80cm above the floor. The EUT was positioned as shown in the setup photographs. The receiving antenna was placed at a distance of 3m at a fixed height of 1m. Measurement equipment was located outside of the chamber. A video camera was placed inside the chamber to view the EUT.

4.6.1.2 Final Test

For each frequency measured, the peak emission was maximized by manipulating the receiving antenna from 1 to 4 meters above the ground plane and placing it at the position that produced the maximum signal strength reading. The turntable was then rotated through 360° while observing the peak signal and placing the EUT at the position that produced maximum radiation. The six highest emissions relative to the limit were measured unless such emissions were more than 20 dB below the limit. If less than six emissions are within 20 dB of the limit, than the noise level of the receiver is measured at frequencies where emissions are expected. Multiples of all oscillator and microprocessor frequencies were also checked.

Final testing was performed on an NSA compliant test site. The EUT was placed on a 1.0m x 1.5m non-conductive table 80cm above the ground plane. The placement of EUT and cables were the same as for preliminary testing and is shown in the setup photographs.

4.6.1.3 Deviations

None.

4.6.2 Receiver Spurious Emission Limit

The spurious emissions of the receiver shall not exceed the values in CFR47 Part 80 & 90 and RSS-121.

Frequency (MHz)	Field strength (microvolts/meter)	Measurement distance (meters)
0.009-0.490.....	2400/F (kHz)	300
0.490-1.705.....	24000/F (kHz)	30
1.705-30.0.....	30	30
30-88.....	100 **	3
88-216.....	150 **	3
216-960.....	200 **	3
Above 960.....	500	3

4.6.3 Test Results

The final measurement data indicates the worst case operating modes, configurations, and/or cable positions. It also reflects the results including any modifications and/or special accessories listed in Sections 1.4 and 1.5.

As originally tested, the EUT was found to be compliant to the requirements of the test standard(s).

4.6.3.1 Final Data

The data recorded in this section contains the final results under the worst-case conditions and without any modifications or special accessories implemented as the manufacturer intends.

SOP 1 Radiated Emissions						Tracking # 31260509.004 Page 1 of 3				
EUT Name		TransAir PTC-3006				Date		April 18, 2012		
EUT Model		PTC-3006				Temp / Hum in		23°C / 39%rh		
EUT Serial		D1-10				Temp / Hum out		N/A		
EUT Config.		Receive Mode				Line AC / Freq		12 Vdc		
Standard		CFR 47 part 90				RBW / VBW		120/300 kHz		
Dist/Ant Used		3m / EMCO3115 / 1m - RA42-K-F-4B-C				Performed by		Suresh Kondapalli		
Emission Freq	FIM Pk	FIM QP	Total CF	E-Field QP	Spec Limit	Spec Margin	Table Pos	ANT Pos	ANT Pola	Type
120.40	50.41	48.67	-11.85	36.82	43.52	-6.70	267	181	H	Spurious
220.80	53.47	53.40	-13.73	39.67	46.02	-6.35	272	127	H	Spurious
230.40	52.34	51.03	-12.97	38.06	46.02	-7.96	269	125	H	Spurious
431.75	24.47	46.10	-8.08	38.02	46.02	-8.00	205	289	H	Spurious
441.60	49.08	49.12	-8.15	40.97	46.02	-5.05	183	102	H	Spurious
451.21	49.82	50.04	-8.06	41.98	46.02	-4.04	123	222	H	Spurious
65.41	58.01	55.21	-18.55	36.64	40.00	-3.36	143	120	V	Spurious
121.95	45.92	44.25	-11.93	32.32	43.52	-11.20	30	160	V	Spurious
431.75	23.00	43.06	-8.42	34.64	46.02	-11.38	238	132	V	Spurious
441.34	23.85	45.83	-8.45	37.38	46.02	-8.64	214	164	V	Spurious
Spec Margin = E-Field QP - Limit, E-Field QP = FIM QP+ Total CF ± Uncertainty										
Total CF= Amp Gain + Cable Loss + ANT Factor										
Combined Standard Uncertainty $u_c(y) = \pm 3.2$ dB Expanded Uncertainty $U = ku_c(y)$ $k = 2$ for 95% confidence										
Notes:										
Notes: 1Ghz: RBW=120 kHz,VBW=300 kHz 1GHz – 25 GHz: RBW=1MHz, VBW=3MHz										

SOP 1 Radiated Emissions

Tracking # 31260509.004 Page 2 of 3

EUT Name	TransAir PTC-3006	Date	April 05, 2012
EUT Model	PTC-3006	Temp / Hum in	22°C / 40%rh
EUT Serial	D1-10	Temp / Hum out	N/A
EUT Config.	EUT on with all antennas and I/O ports active	Line AC / Freq	12 Vdc
Standard	CFR47 Part 15.109, Class A	RBW / VBW	See Note
Dist/Ant Used	3m / JB3 & EMCO3115	Performed by	Suresh Kondapalli

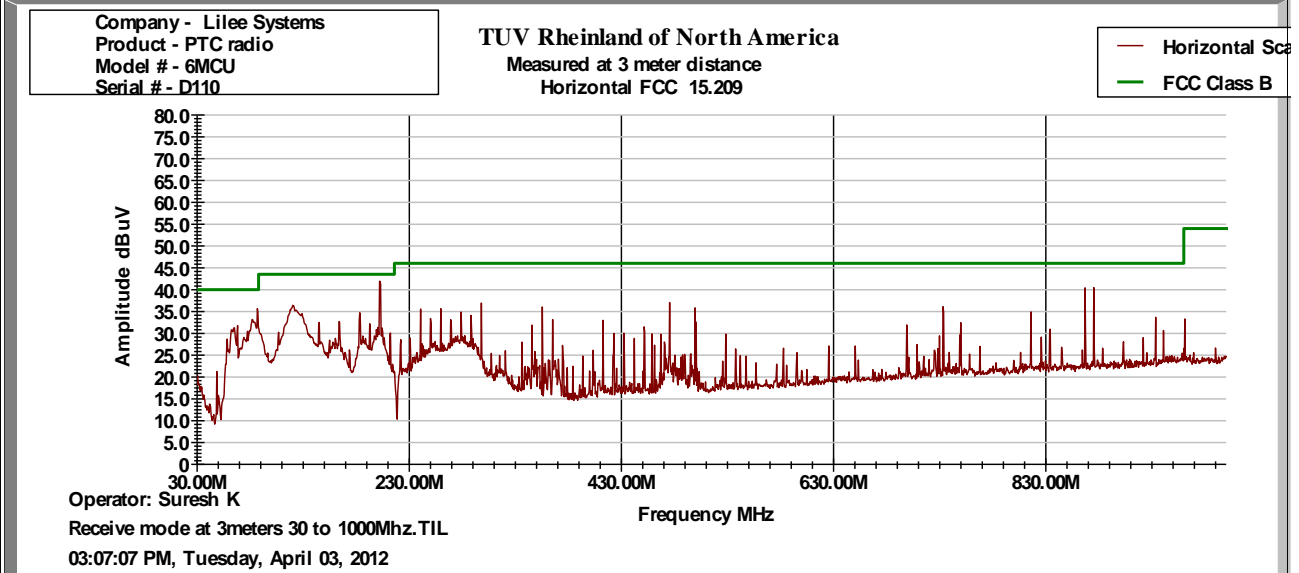
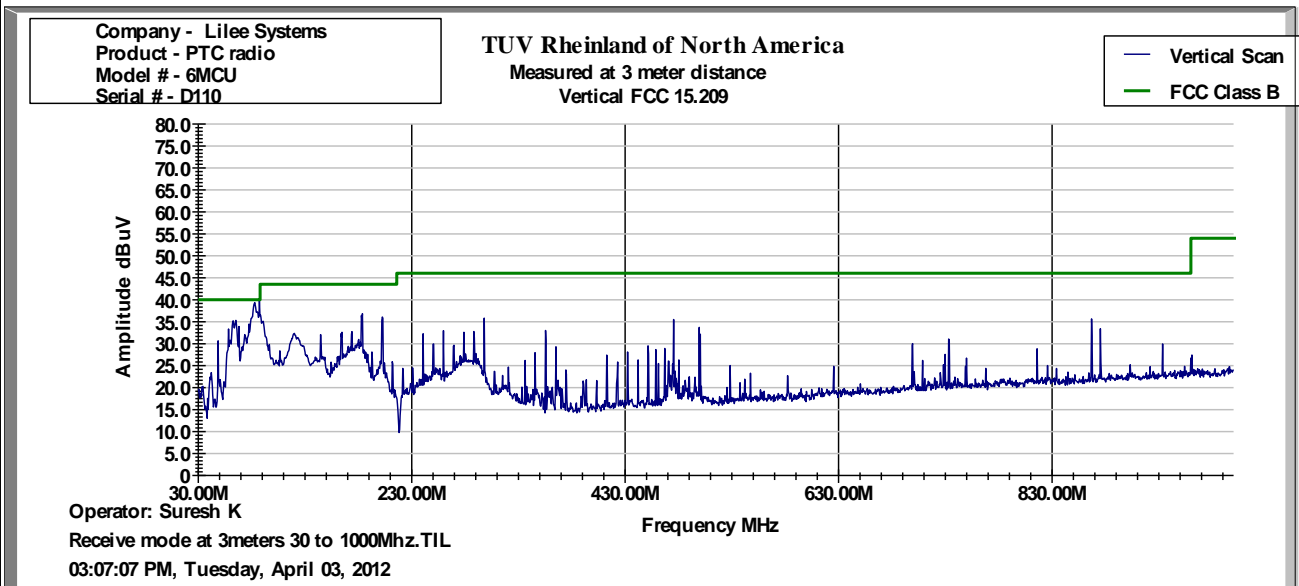

Notes : None

SOP 1 Radiated Emissions		Tracking # 31260509.00 Page 3 of 3 42	
EUT Name	TransAir PTC-3006	Date	04/05/2012
EUT Model	PTC-3006	Temp / Hum in	22°C / 40%rh
EUT Serial	D1-10	Temp / Hum out	N/A
EUT Config.	Receive Mode	Line AC	12 Vdc
Standard	CFR 47 part 90	RBW / VBW	1MHz/3MHz
Dist/Ant Used	3m / JB3	Performed by	Suresh Kondapali

Above 1GHz Plot for Receive Mode

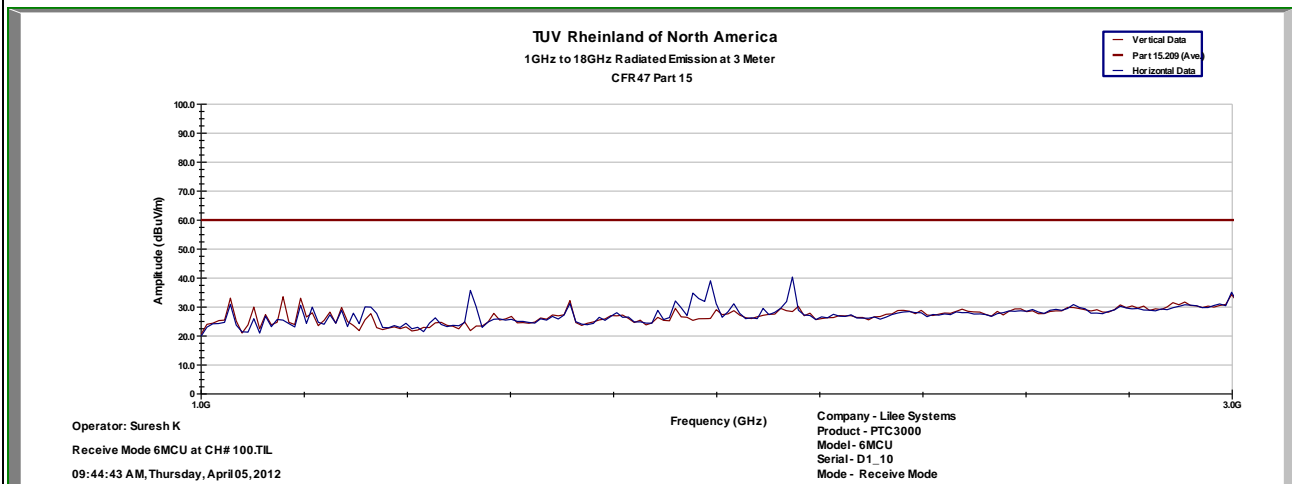

All Emissions above 1 GHz were at least 20dB below the limit

4.6.4 Sample Calculation

The field strength is calculated by subtracting the Amplifier Gain and adding the Cable Loss and Antenna Correction Factor to the measured reading. The basic equation is as follows:

$$\text{Field Strength (dB}\mu\text{V/m)} = \text{FIM} - \text{AMP} + \text{CBL} + \text{ACF}$$

Where: FIM = Field Intensity Meter (dB μ V)
 AMP = Amplifier Gain (dB)
 CBL = Cable Loss (dB)
 ACF = Antenna Correction Factor (dB/m)

$$\mu\text{V/m} = 10^{\frac{\text{dB}\mu\text{V/m}}{20}}$$

4.7 Normal operation/ Simultaneous operation of Transmitters

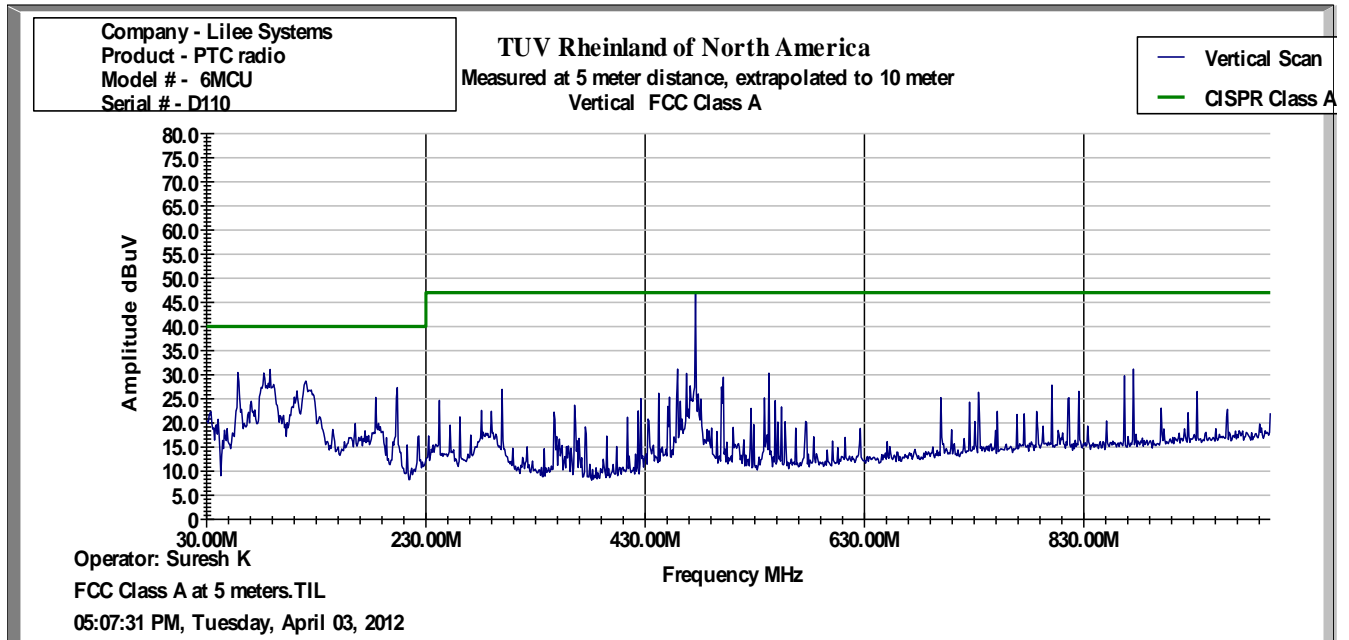
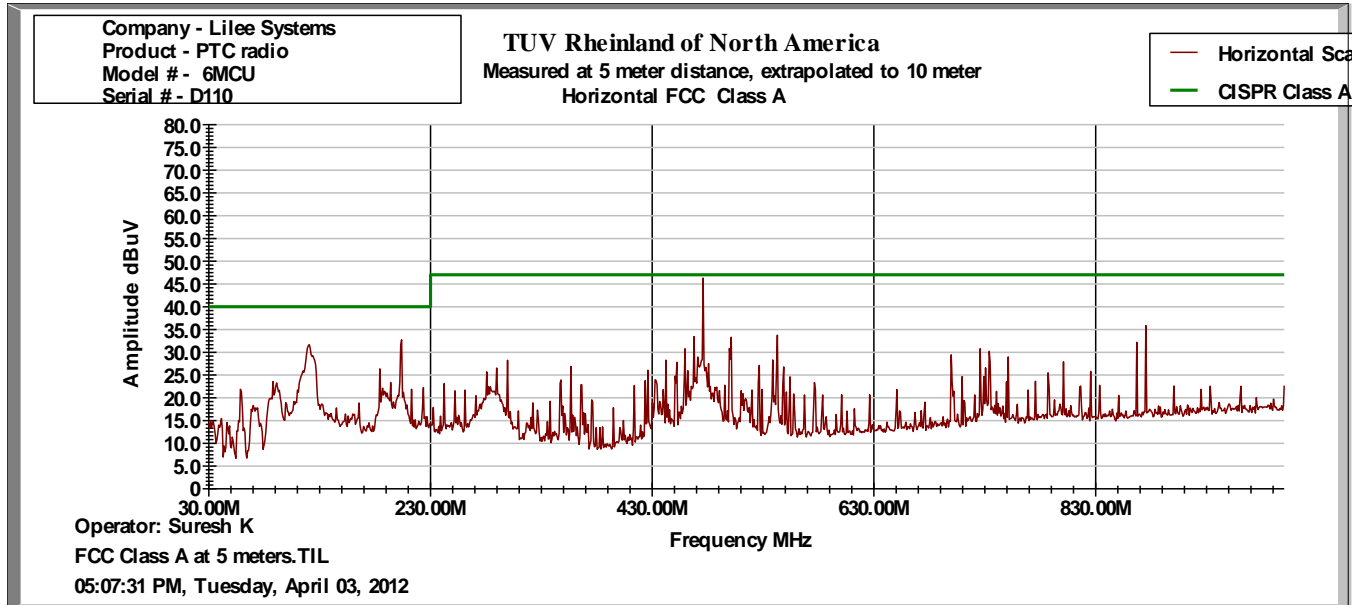

SOP 1 Radiated Emissions						Tracking # 31260509.004					
EUT Name	TransAir PTC-3006					Date	April 03, 2012				
EUT Model	PTC-3006					Temp / Hum in	23°C / 39%rh				
EUT Serial	D1-10					Temp / Hum out	N/A				
EUT Config.	Normal operation					Line AC / Freq	12 Vdc				
Standard	CFR 47 part 90					RBW / VBW	120/300 kHz				
Dist/Ant Used	3m / EMCO3115 / 1m - RA42-K-F-4B-C					Performed by	Suresh Kondapalli				
Emission Freq	FIM Pk	FIM QP	Total CF	E-Field QP	Spec Limit	Spec Margin	Table Pos	ANT Pos	ANT Pola	Comment	
57.6118	52.56	49.67	-24.53	25.14	40	-14.86	282	114	V		
81.3413	54.55	52.25	-24.6	27.65	40	-12.35	60	141	V		
121.905	48.1	46.32	-17.74	28.58	40	-11.42	299	325	H		
201.597	55.01	53.85	-18.76	35.09	40	-4.91	241	240	H		
474.999	60.32	59.77	-13.74	46.03	47	-0.97	7	163	V		
541.663	48.04	47.26	-12.53	34.73	47	-12.27	50	107	H		
875.004	45.92	44.99	-7.44	37.55	47	-9.45	306	172	H		
Spec Margin = E-Field QP - Limit, E-Field QP = FIM QP+ Total CF ± Uncertainty											
Total CF= Amp Gain + Cable Loss + ANT Factor											
Combined Standard Uncertainty $u_c(y) = \pm 3.2$ dB Expanded Uncertainty $U = k u_c(y)$ $k = 2$ for 95% confidence											
Notes: 1Ghz: RBW=120 kHz,VBW=300 kHz 1GHz – 25 GHz: RBW=1MHz, VBW=3MHz											
All Emissions abobe 1 GHz were at least 20dB below the limit											

4.8 Frequency Stability

In accordance with 47 CFR Part 90.213(a) the transmitters used in the services governed by this part must have a minimum frequency stability specified below

Frequency range (MHz)	Fixed and base stations	Mobile stations	
		Over 2 watts output power	2 watts or less output power
216–220	1.0		1.0
220–222 ¹²	0.1	1.5	1.5

¹²Mobile units may utilize synchronizing signals from associated base stations to achieve the specified carrier stability.

4.8.1 Test Methodology

FCC 2.1055

EUT was placed inside temperature chamber and its power supply was connected to variable DC power supply. Antenna port was connected to spectrum Analyzer placed outside the chamber. The frequency stability was measured at the antenna port with a spectrum analyzer using a peak detector with a resolution bandwidth of 3Hz and a video bandwidth of 1 kHz.

Measurements were performed at nominal power supply voltage (DC 17 Vdc) with variation of ambient temperature from -30 to +50° C with 10° C steps and at nominal temperature (20° C) with variation of power supply voltage from 85% to 115% of the nominal value. For each test condition, after stable temperature was reached, the EUT was turned on and the operating frequency was measured at startup and at 2, 5 and 10 minutes after the EUT was energized. The EUT was transmitting an unmodulated carrier for this test.

Frequency stability test were performed at 220.0125 MHz and 220.9875 MHz. The test is applicable for entire range of 216 to 222 MHz as equipment has same firmware for entire range.

4.8.2 Test results

As originally tested, the EUT was found to be compliant to the requirements of the test standard(s).

Table 6: Frequency Stability – Test Results Fixed Mode

Test Conditions		Freq. Assigned MHz	Measured MHz	Dev. Hz	Deviation %	Deviation PPM	Deviation Limit PPM
Temp. [°C]	DC Input [V]						
0	17.0	220.012500	220.012508	8	3.63616E-06	0.03636157	0.1
-10	17.0	220.012500	220.012518	18	8.18135E-06	0.081813533	0.1
-20	17.0	220.012500	220.012522	22	9.99943E-06	0.099994321	0.1
-30	17.0	220.012500	220.012522	22	9.99943E-06	0.099994321	0.1
10	17.0	220.012500	220.012507	7	3.18164E-06	0.031816374	0.1
20	17.0	220.012500	220.012507	7	3.18164E-06	0.031816374	0.1
30	17.0	220.012500	220.012498	-2	-9.09039E-07	-0.009090393	0.1
40	17.0	220.012500	220.012490	-10	-4.5452E-06	-0.045452163	0.1
50	17.0	220.012500	220.012494	-6	-2.72712E-06	-0.027271178	0.1
22	14.4 (85%)	220.012501	220.012501	1	4.5452E-07	0.004545216	0.1
22	21.4 (115%)	220.012501	220.012501	1	4.5452E-07	0.004545216	0.1
22	10 Lowest Operational	220.012501	220.012501	1	4.5452E-07	0.004545216	0.1
22	24 Highest Operational	220.012501	220.012501	1	4.5452E-07	0.004545216	0.1

Frequency evaluation was made at the start time, 2 min, 5 min and 10 min from start time with worst-case values reported here.

Table 7: Frequency Stability – Test Results Fixed Mode

Test Conditions		Freq Assigned MHz	Measured MHz	Dev. Hz	Deviation %	Deviation PPM	Deviation Limit PPM
Temp. [°C]	DC Input [V]						
0	17.0	220.987500	220.987510	10	4.52514E-06	0.045251428	0.1
-10	17.0	220.987500	220.987517	17	7.69274E-06	0.076927428	0.1
-20	17.0	220.987500	220.987521	21	9.5028E-06	0.095027999	0.1
-30	17.0	220.987500	220.987522	22	9.95531E-06	0.099553142	0.1
10	17.0	220.987500	220.987508	8	3.62011E-06	0.036201143	0.1
20	17.0	220.987500	220.987505	5	2.26257E-06	0.022625714	0.1
30	17.0	220.987500	220.987499	-1	-4.52514E-07	-0.004525143	0.1
40	17.0	220.987500	220.987489	-11	-4.97766E-06	-0.049776571	0.1
50	17.0	220.987500	220.987493	-7	-3.1676E-06	-0.031676000	0.1
22	14.4 (85%)	220.987500	220.987503	3	1.35754E-06	0.013575428	0.1
22	21.4 (115%)	220.987500	220.987502	2	9.05029E-07	0.009050286	0.1
22	10 Lowest Operational	220.987500	220.987502	2	9.05029E-07	0.009050286	0.1
22	24 Highest Operational	220.987500	220.987498	-2	-9.05029E-07	-0.009050286	0.1

Frequency evaluation was made at the start time, 2 min, 5 min and 10 min from start time with worst-case values reported here.

Table 8: Frequency Stability – Test Results Mobile station mode

Test Conditions		Freq. Assigned MHz	Measured MHz	Dev. Hz	Deviation %	Deviation PPM	Deviation Limit PPM
Temp. [°C]	DC Input [V]						
0	17	220.012500	220.012551	51	2.31805E-05	0.231805	+/-1.5
-10	17	220.012500	220.012570	70	3.18164E-05	0.3181637	+/-1.5
-20	17	220.012500	220.012555	55	2.49986E-05	0.2499858	+/-1.5
-30	17	220.012500	220.012550	50	2.2726E-05	0.2272598	+/-1.5
10	17	220.012500	220.012607	107	4.86336E-05	0.486336	+/-1.5
20	17	220.012500	220.012621	121	5.40878E-05	0.5408784	+/-1.5
30	17	220.012500	220.012630	130	5.90876E-05	0.5908755	+/-1.5
40	17	220.012500	220.012637	137	6.22692E-05	0.6226921	+/-1.5
50	17	220.012500	220.012644	144	6.54508E-05	0.6545083	+/-1.5
22	14.4 (85%)	220.012500	220.012626	126	5.72695E-05	0.5726947	+/-1.5
22	21.4 (115%)	220.012500	220.012626	126	5.72695E-05	0.5726947	+/-1.5
22	10 Lowest Operational	220.012500	220.012627	127	5.7724E-05	0.5772399	+/-1.5
22	24 Highest Operational	220.012500	220.012624	124	5.63604E-05	0.5636043	+/-1.5

Frequency evaluation was made at the start time, 2 min, 5 min and 10 min from start time with worst-case values reported here.

Table 9: Frequency Stability – Test Results mobile Station mode

Test Conditions		Freq. Assigned MHz	Measured MHz	Dev. Hz	Deviation %	Deviation PPM	Deviation Limit PPM
Temp. [°C]	DC Input [V]						
0	17	220.987500	220.987600	100	4.52514E-05	0.452514282	+/-1.5
-10	17	220.987500	220.987578	78	3.52961E-05	0.35296114	+/-1.5
-20	17	220.987500	220.987578	78	3.52961E-05	0.35296114	+/-1.5
-30	17	220.987500	220.987559	59	2.66983E-05	0.266983427	+/-1.5
10	17	220.987500	220.987610	110	4.97766E-05	0.497765711	+/-1.5
20	17	220.987500	220.987650	150	6.78771E-05	0.678771424	+/-1.5
30	17	220.987500	220.987652	152	6.87822E-05	0.687821709	+/-1.5
40	17	220.987500	220.987653	153	6.92347E-05	0.692346852	+/-1.5
50	17	220.987500	220.987654	154	6.96872E-05	0.696872195	+/-1.5
22	14.4 (85%)	220.987500	220.987651	151	6.83297E-05	0.683296567	+/-1.5
22	21.4 (115%)	220.987500	220.987651	151	6.83297E-05	0.683296567	+/-1.5
22	10 Lowest Operational	220.987500	220.987651	151	6.83297E-05	0.683296567	+/-1.5
22	24 Highest Operational	220.987500	220.987651	151	6.83297E-05	0.683296567	+/-1.5

Frequency evaluation was made at the start time, 2 min, 5 min and 10 min from start time with worst-case values reported here.

Test Setup Photos

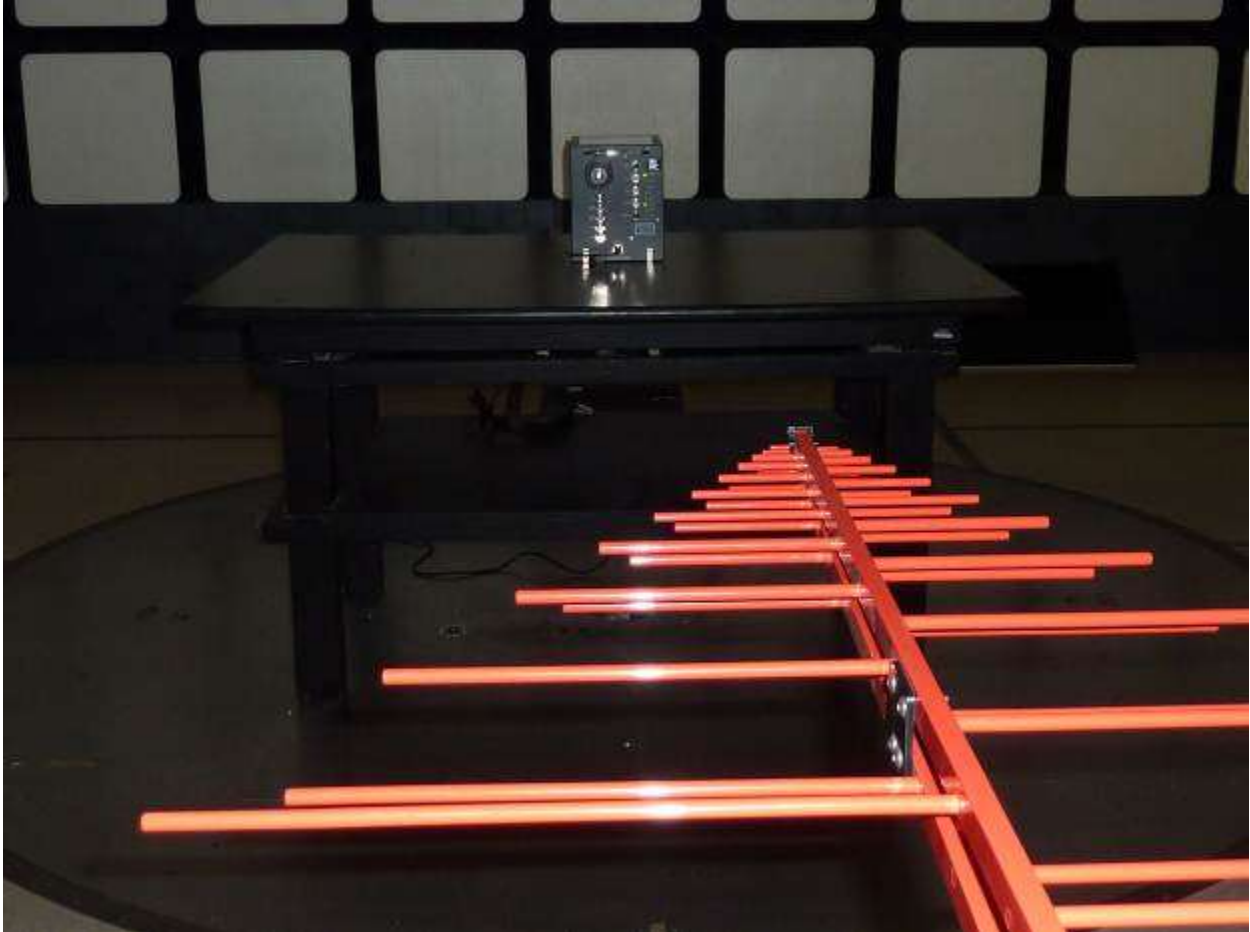





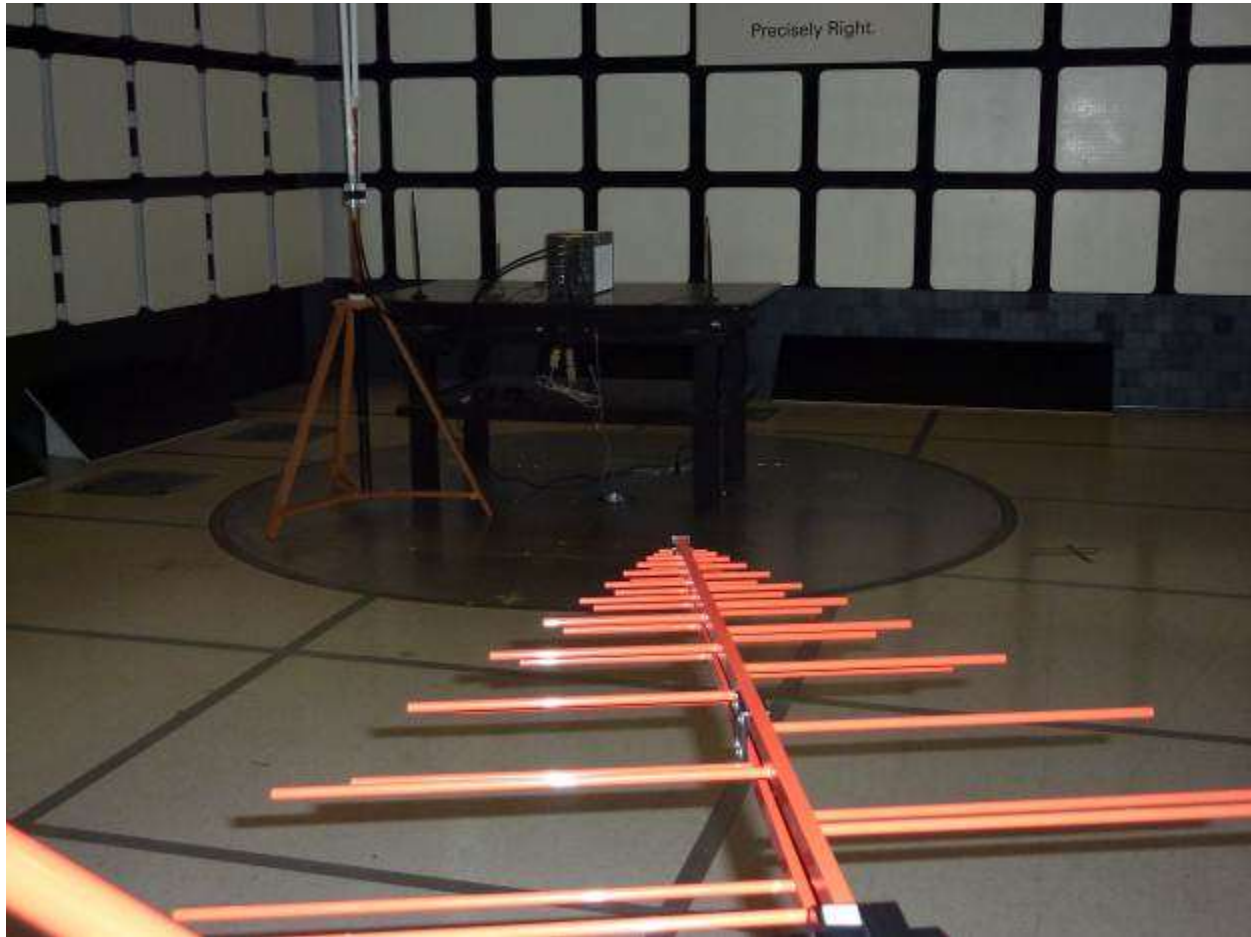

5 Test Equipment Use List

5.1 Equipment List

Equipment	Manufacturer	Model #	Serial/Inst #	Last Cal mm/dd/yy	Next Cal mm/dd/yy
Bilog Antenna	Sunol Sciences	JB3	A102606	5/21/2012	5/21/2013
Horn Antenna	Sunol Sciences	DRH-118	A040806	9/29/2010	9/29/2012
Antenna (18-26GHz)	CMT	RA42-K-F-4B-C	020131-004	1/17/2012	1/17/2013
Antenna (26-40GHz)	CMT	RA28-K-F-4B-C	011469R-003	1/17/2012	1/17/2013
EMI Receiver	Hewlett Packard	8546A	3807A00445	1/17/2012	1/17/2013
Preselector	Hewlett Packard	85460A	3704A00407	1/17/2012	1/17/2013
Amplifier	Hewlett Packard	8447D	2944A07996	1/16/2012	1/16/2013
Spectrum Analyzer	Rohde & Schwarz	ESIB	832427/002	1/17/2012	1/17/2013
Amplifier	Rohde & Schwarz	TS-PR18	3545.7008.03	9/29/2010	9/29/2012
Amplifier	Rohde & Schwarz	TS-PR26	100011	1/16/2012	1/16/2013
Amplifier	Rohde & Schwarz	TS-PR40	100012	1/16/2012	1/16/2013
Signal Generator	Anritsu	MG3694A	42803	1/17/2012	1/17/2013
Notch Filter	Micro-Tronics	BRM50702	37	1/17/2012	1/17/2013
Notch Filter	Micro-Tronics	BRC50705	9	1/17/2012	1/17/2013
High Pass Filter (3.5 GHz)	Hewlett Packard	84300-80038	820004	1/17/2012	1/17/2013
High Pass Filter (8.5 GHz)	Micro-Tronics	HPM50107	4	1/17/2012	1/17/2013
Notch Filter	Telonic Berkely, Inc	TTR210-3EE	50033-2	VB	VB
Power Supplier	Kikosui	PCR8000W	CM000912	1/21/2012	1/21/2013
Digital Multimeter	Fluke	177	92780314	1/18/2012	1/18/2013
Power Meter	Agilent	E4418B	MY45103902	1/21/2012	1/21/2013
Power Sensor	Hewlett Packard	8482A	55-5131	1/21/2012	1/21/2013
Spectrum Analyzer	Agilent	E4407B	SG43330468	10/05/2011	10/05/2012

VB: Verify before use

6 EMC Test Plan

6.1 EMC Test Plan

6.1.1 Introduction

This section provides a description of the Equipment Under Test (EUT), configurations, operating conditions, and performance acceptance criteria. It is an overview of information provided by the manufacturer so that the test laboratory may perform the requested testing.

6.1.2 Customer

Table 10: Customer Information

Company Name	Lilee Systems, Ltd
Address	2905 Stender Way, Suite 78
City, State, Zip	Santa Clara, CA 95054
Country	U.S.A.
Phone	(408) 988-8672
Fax	(408) 988-8813

Table 11: Technical Contact Information

Name	Hamid Movahedi
E-mail	hmovahedi@lileesystems.com
Phone	(408) 898-8672
Fax	(408) 988-8813

6.1.3 Equipment Under Test (EUT)

Table 12: EUT Specifications

EUT Specification	
Dimensions	Length: 29cm, Width: 16cm, Height: 30cm
AC Adapter (For charging only)	Input Voltage: 10 to 24 Vdc Input Current: 12 A
Environment	Mobile/Fixed
Operating Temperature Range:	-40 to +70 degrees C
Multiple Feeds	<input type="checkbox"/> Yes and how many <input checked="" type="checkbox"/> No
Hardware Version	D
Part Number	None
RF Software Version	None
Radio Module	
Operating Mode	Base station, Waystation and mobile
Transmitter Frequency Band	216 to 222 MHz
Max. Rated Power Output	See Channel Planning Table.
Power Setting @ Operating Channel	Power setting is from Att 31 = 20 dBm to ATT 0= 45.8 dBm See Channel Planning Table.
Antenna Type	TransAir 3 dBi PIFA Antenna for Locomotive /Mobile (actual gain5.2 dBi) TransAir 13 dBi sector Antenna for Base station and wayside YA-200230M13-NF 13 dBi Yagi antenna for Base Station SY2062-SF11SNM(U) Dual Yagi, 12 dBd for Base station (14.1 dBi)
Modulation Type	<input type="checkbox"/> AM <input type="checkbox"/> FM <input type="checkbox"/> DSSS <input type="checkbox"/> OFDM <input checked="" type="checkbox"/> Other describe: GMSK, $\Pi/4$ QPSK, QPSK, OQPSK, BPSK, SOQPSK, & DQPSK,
Data Rate	9600BPS, 16KBPS, 32KBPS
TX/RX Chain (s)	2 (Primary and Standby only one active at a time)
Directional Gain Type	<input checked="" type="checkbox"/> Uncorrelated <input checked="" type="checkbox"/> No Beam-Forming <input type="checkbox"/> Other describe:
Type of Equipment	<input type="checkbox"/> Table Top <input type="checkbox"/> Wall-mount <input type="checkbox"/> Floor standing cabinet <input checked="" type="checkbox"/> Other Fixed and mobile modes, used in Locomotive, Wayside Station, Fixed mounted/ Base station

Table 13: EUT Channel Power Specifications

Frequency (MHz)	Power Set Value
	See Table 2

EUT channels available;

PTC-3006 216-222 MHz band as follows

See para RSS-121 para 5.5.3 for

The 217-218 MHz and 221-220 MHz bands are each segmented into 80 channels, with carrier frequencies evenly spaced at 12.5 kHz, the first and last carrier frequencies being 6.25 kHz from the band edges.

Note: Equipment may be certified to operate in the entire band 217-220 MHz, but the sub-band 218-221 MHz may not be available for licensing.

and

Ch#3 to CH# 218 (220 MHz band)

Table B1 - Channel Designations in the Band 220-222 MHz

Note: Only base station frequencies are listed in MHz. Paired mobile station frequencies are 1 MHz higher

Channel Number	Center Frequency	Channel Number	Center Frequency	Channel Number	Center Frequency	Channel Number	Center Frequency
1	220.0025	51	220.2525	101	220.5025	151	220.7525
2	220.0075	52	220.2575	102	220.5075	152	220.7575
3	220.0125	53	220.2625	103	220.5125	153	220.7625
4	220.0175	54	220.2675	104	220.5175	154	220.7675
5	220.0225	55	220.2725	105	220.5225	155	220.7725
6	220.0275	56	220.2775	106	220.5275	156	220.7775
7	220.0325	57	220.2825	107	220.5325	157	220.7825
8	220.0375	58	220.2875	108	220.5375	158	220.7875
9	220.0425	59	220.2925	109	220.5425	159	220.7925
10	220.0475	60	220.2975	110	220.5475	160	220.7975
11	220.0525	61	220.3025	111 ²	220.5525	161 ³	220.8025
12	220.0575	62	220.3075	112	220.5575	162 ³	220.8075
13	220.0625	63	220.3125	113 ²	220.5625	163 ³	220.8125
14	220.0675	64	220.3175	114	220.5675	164 ³	220.8175
15	220.0725	65	220.3225	115 ²	220.5725	165 ³	220.8225
16	220.0775	66	220.3275	116	220.5775	166 ³	220.8275
17	220.0825	67	220.3325	117 ²	220.5825	167 ³	220.8325
18	220.0875	68	220.3375	118	220.5875	168 ³	220.8375
21	220.0925	69	220.3425	121 ²	220.5925	169 ³	220.8425
20	220.0975	70	220.3475	120	220.5975	170 ³	220.8475
21 ¹	220.1025	71	220.3525	121	220.6025	171	220.8525
22 ¹	220.1075	72	220.3575	122	220.6075	172	220.8575
23 ¹	220.1125	73	220.3625	123	220.6125	173	220.8625
24 ¹	220.1175	74	220.3675	124	220.6175	174	220.8675
25 ¹	220.1225	75	220.3725	125	220.6225	175	220.8725
26	220.1275	76	220.3775	126	220.6275	176	220.8775
27	220.1325	77	220.3825	127	220.6325	177	220.8825
28	220.1375	78	220.3875	128	220.6375	178	220.8875
29	220.1425	79	220.3925	129	220.6425	179	220.8925
30	220.1475	80	220.3975	130	220.6475	180	220.8975
31	220.1525	81	220.4025	131	220.6525	181 ³	220.9025
32	220.1575	82	220.4075	132	220.6575	182 ³	220.9075
33	220.1625	83	220.4125	133	220.6625	183 ³	220.9125
34	220.1675	84	220.4175	134	220.6675	184 ³	220.9175
35	220.1725	85	220.4225	135	220.6725	185 ³	220.9225
36	220.1775	86	220.4275	136	220.6775	186	220.9275

Channel Number	Center Frequency	Channel Number	Center Frequency	Channel Number	Center Frequency	Channel Number	Center Frequency
37	220.1825	87	220.4325	137	220.6825	187	220.9325
38	220.1875	88	220.4375	138	220.6875	188	220.9375
39	220.2125	89	220.4425	139	220.6925	189	220.9425
40	220.2175	90	220.4475	140	220.6975	210	220.9475
41	220.2025	91	220.4525	141	220.7025	211	220.9525
42	220.2075	92	220.4575	142	220.7075	212	220.9575
43	220.2125	93	220.4625	143	220.7125	213	220.9625
44	220.2175	94	220.4675	144	220.7175	214	220.9675
45	220.2225	95	220.4725	145	220.7225	215	220.9725
46	220.2275	96	220.4775	146	220.7275	216 ⁴	220.9775
47	220.2325	97	220.4825	147	220.7325	217 ⁴	220.9825
48	220.2375	98	220.4875	148	220.7375	218 ⁴	220.9875
49	220.2425	99	220.4925	149	220.7425	219 ⁴	220.9925
50	220.2475	100	220.4975	150	220.7475	200 ⁴	220.9975

¹ Available to the Railway Association of Canada (refer to Section 5.5)

² Available to Canada for ITS/IVHS operations on a shared basis within the coordination zone (refer to Section 5.3)

³ Available for public safety and mutual aid operations (refer to Section 5.2.1)

⁴ Available for low-power operations in both countries (refer to Section 5.4)

Table 14: Interface Specifications:

Power Output through custom connector, SPI and control signals

Table 15: Supported Equipment :

None

Table 16: Description of Sample used for Testing

Device	Serial	RF Connection	CFR47 Part 90
PTC-3006 Transmitter	PTC transmitter card #556D904D04G2100 0005M0LB Host Device #D1-10	N- Female terminated with Load	TX Emission, RX Emission
		N-Female Connected directly to Spectrum analyzer through short coax cable and Calibrated 30 dB pad	RF Power Output, Out of Band Emission, Emission mask, Occupied Bandwidth Frequency Stability

Table 17: Description of Test Configuration used for Radiated Measurement.

Device	Antenna	Mode	
PTC-3006 Transmitter	Dummy Load	* Transmit * Receive	EUT is normally rack mounted/used on table top. EUT was evaluated as table top equipment
Host Chassis Serial #: D1-10			

6.1.4 Test Specifications

Testing requirements

Table 18: Test Specifications

Emissions and Immunity	
Standard	Requirement
CFR 47 Part 80 & 90	All
RSS-121 Issue 11, 2011	All

END OF REPORT