

Emissions Test Report

EUT Name: TransAir PTC-3001

Model No.: PTC-3001

CFR 47 Part 95

Prepared for:

Lilee Systems, Ltd.
2905 Stender Way, Suite 78
Santa Clara, CA 95054 U.S.A.
Tel: (408) 988-8672

Prepared by:

TUV Rheinland of North America, Inc.
1279 Quarry Lane, Ste. A
Pleasanton, CA 94566
Tel: (925) 249-9123
Fax: (925) 249-9124
<http://www.tuv.com/>

Report/Issue Date: November 26, 2012
Report Number: 31260509.003B

Statement of Compliance

Manufacturer: Lilee Systems, Ltd.
2905 Stender Way, Suite 78
Santa Clara, CA 95054 U.S.A.
Requester / Applicant: Lilee Systems, LTD
Name of Equipment: TransAir PTC-3001
Model No. PTC-3001
Type of Equipment: Intentional Radiator
Application of Regulations: CFR 47 Part 95
Test Dates: February 28, 2012 to May 18, 2012 and July 10, 2012

Guidance Documents:

Emissions: ANSI/TIA-603-C:2004

Test Methods:

Emissions: ANSI/TIA-603-C:2004

The electromagnetic compatibility test and documented data described in this report has been performed and recorded by TUV Rheinland, in accordance with the standards and procedures listed herein. As the responsible authorized agent of the EMC laboratory, I hereby declare that the equipment described above has been shown to be compliant with the EMC requirements of the stated regulations and standards based on these results. If any special accessories and/or modifications were required for compliance, they are listed in the Executive Summary of this report.

This report must not be used to claim product endorsement by A2LA or any agency of the U.S. Government. This report contains data that are not covered by A2LA accreditation. This report shall not be reproduced except in full, without the written authorization of TUV Rheinland of North America.



Suresh Kondapalli November 25, 2012
Test Engineer Date

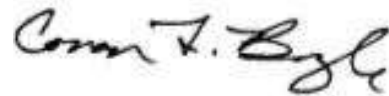

Conan Boyle November 26, 2012
A2LA Signatory Date



INDUSTRY
CANADA



US5254

Testing Cert #3331.02

2932M-1

1097 (A-0031)

1	Executive Summary	6
1.1	Scope	6
1.2	Purpose	6
1.3	Summary of Test Results	6
1.4	Special Accessories	8
1.5	Equipment Modifications	8
2	Laboratory Information	9
2.1	Accreditations & Endorsements	9
2.1.1	US Federal Communications Commission	9
2.1.2	A2LA	9
2.1.3	Canada – Industry Canada	9
2.1.4	Japan – VCCI	9
2.1.5	Acceptance by Mutual Recognition Arrangement	9
2.2	Test Facilities	10
2.2.1	Emission Test Facility	10
2.2.2	Immunity Test Facility	10
2.3	Measurement Uncertainty	10
2.3.1	Sample Calculation – radiated & conducted emissions	11
2.3.2	Measurement Uncertainty	11
2.4	Calibration Traceability	12
3	Product Information	13
3.1	Product Description	13
3.2	Equipment Configuration	13
3.3	Operating Mode	13
3.4	Duty Cycle:	13
3.5	Unique Antenna Connector	14
3.5.1	Results	14
4	Emission Requirements – 218 to 219 MHz Band	15
4.1	Output Power Requirements	15
4.1.1	Test Method	15
4.1.2	Results	16
4.2	Occupied Bandwidth	30
4.2.1	Test Method	30
4.2.2	Results	31
4.3	Spectral Mask requirements	35
4.4	Conducted Spurious Emissions	43

Index of Tables

4.4.1	Test Method	43
4.4.2	Results	44
4.5	Transmitter Spurious Emissions	48
4.5.1	Test Methodology	48
4.5.2	Transmitter Spurious Emission Limit	49
4.5.3	Test Results	49
4.5.4	Sample Calculation	53
4.6	Receiver Spurious Emissions	54
4.6.1	Test Methodology	54
4.6.2	Receiver Spurious Emission Limit	55
4.6.3	Test Results	55
4.6.4	Conducted spurious emissions in Receive mode	56
4.6.5	Sample Calculation	59
4.7	Test Setup Photos	60
5	Test Equipment Use List	62
5.1	Equipment List	62
6	EMC Test Plan	63
6.1	EMC Test Plan	63
6.1.1	Introduction	63
6.1.2	Customer	63
6.1.3	Equipment Under Test (EUT)	64
6.1.4	Test Specifications	66

Index of Tables

Table 1: Summary of Test Results 6
Table 2: RF Output Power at the Antenna Port – Test Results 16
Table 3: Occupied Bandwidth – Test Results 31
Table 4: Spectral Mask Requirements – Test Results 36
Table 5: Out of band Conducted Emission – Test Results 44
Table 6: Customer Information 63
Table 7: Technical Contact Information 63
Table 8: EUT Specifications 64
Table 9: EUT Channel Power Specifications 65
Table 10: Interface Specifications: 65
Table 11: Supported Equipment : 65
Table 12: Description of Sample used for Testing 65
Table 13: Description of Test Configuration used for Radiated Measurement. 66
Table 14: Test Specifications 66

1 Executive Summary

1.1 Scope

This report is intended to document the status of conformance with the requirements of the CFR 47 Part 95 based on the results of testing performed from February 28 to May 18, 2012 and July 10, 2012, on the TransAir PTC-3001 Model PTC-3001 manufactured by *Lilee Systems, LTD*. This report only applies to the specific samples tested under the stated test conditions. It is the responsibility of the manufacturer to assure that additional production units of this model are manufactured with identical or EMI equivalent electrical and mechanical components. This report is further intended to document changes and modifications to the EUT throughout its life cycle. All documentation will be included as a supplement.

1.2 Purpose

Testing was performed to evaluate the EMC performance of the EUT in accordance with the applicable requirements, procedures, and criteria defined in the application of regulations and application of standards listed in this report.

1.3 Summary of Test Results

Table 1: Summary of Test Results

Transmitter Modulation, output power and other parameters

Test	FCC Rule Part	Measured value/ Comments	Limit/Requirement	Result
Frequency Ranges	2.1033(C) (5) 95.853	218-219 MHz	218-219 MHz	Complied
Power	2.1033(C) (6) 2.1033(C) (7) 2.1046 95.855	Conducted at ant port 1.0 Watt (Mobile) Conducted at ant port 4.56 Watts (Fixed station)	ERP 4 Watts Mobile ¹ ERP 20 Watts Fixed	Complied
Emission Mask	2.1033(C) (4) 2.1047 95.857	Device Complies with spectral mask – see test data	Mask 95.857	Complied
Occupied (99%) Bandwidth	2.1049	8.94 kHz 10.13 kHz 23.93 kHz	For information oly	--

¹ Transmitter output power for fixed stations is factory set max limit at 36.59 dBm (4.56 watts). The EIRP calculation is based on max gain antenna of 3dBi. The equipment design prevents higher power by lockout/error message. Transmitter output power for mobile stations is factory set max limit at 30.0dBm (1Watt). Licencee ensures Fixed and mobile units are limited to 20Watts and 4watts ERP respectively.

Transmitter spurious emissions

Test	FCC Rule Part	Measured value/ Comments	Limit/Requirement	Result
Transmitter spurious				
At Antenna Terminal	2.1051 2.1057	-26.96 dBm	-13 dBm	Complied
Radiated (erp)	80.211(f), 95.857			
Receiver spurious				
At Antenna terminal	15.111	-70.74 dBm	-57 dBm	Complied
Field Strength	15.109	36.64 dBuV/m at 65 MHz	Refer Section CFR 15.109	Complied

§ Calculated from measured field strength using free space propagation equation.

€ EUT is Class A device, at 10 meters

Other parameters

Test	FCC Rule Part	RSS Rule Part	Measured value/ Comments	Limit/Requirement	Result
RF Exposure	1.1307 (b) 2.1093 80.227	RSS-102	RF Exposure is addressed at time of licensing. MPE calculation is provided here.		
DC voltage and current for final amplifier stage	15.107	RSS-GEN	12 Vdc, 6 Amps	Information only	--

1.4 Special Accessories

No special accessories were necessary in order to achieve compliance.

1.5 Equipment Modifications

None.

2 Laboratory Information

2.1 Accreditations & Endorsements

2.1.1 US Federal Communications Commission



TUV Rheinland of North America at 1279 Quarry Ln, Pleasanton, CA 94566 is recognized by the commission for performing testing services for the general public on a fee basis. These laboratory test facilities have been fully described in reports submitted to and accepted by the FCC (US5254). The laboratory scope of accreditation includes: Title 47 CFR Parts 15, 18, and 90. The accreditation is updated every 3 years.

2.1.2 A2LA



TUV Rheinland of North America is accredited by the A2LA. The laboratory has been assessed and accredited in accordance with ISO Guide 17025:2005 and ISO 9002 (Testing Cert #3331.02). The scope of laboratory accreditation includes emission and immunity testing. The accreditation is updated annually.

2.1.3 Canada – Industry Canada



TUV Rheinland of North America at the 1279 Quarry Ln, Pleasanton, CA 94566 address is accredited by Industry Canada for performing testing services for the general public on a fee basis. This laboratory test facilities have been fully described in reports submitted to and accepted by Industry Canada (File Number 2932M-1). This reference number is the indication to the Industry Canada Certification Officers that the site meets the requirements of RSS 212, Issue 1 (Provisional). The accreditation is updated every 3 years.

2.1.4 Japan – VCCI



The Voluntary Control Council for Interference by Information Technology Equipment (VCCI) is a group that consists of Information Technology Equipment (ITE) manufacturers and EMC test laboratories. The purpose of the Council is to take voluntary control measures against electromagnetic interference from Information Technology Equipment, and thereby contribute to the development of a socially beneficial and responsible state of affairs in the realm of Information Technology Equipment in Japan. TUV Rheinland of North America at 1279 Quarry Ln, Pleasanton, CA 94566 has been assessed and approved in accordance with the Regulations for Voluntary Control Measures. (Registration Nos. A-0031& A-0032).

2.1.5 Acceptance by Mutual Recognition Arrangement



The United States has an established agreement with specific countries under the Asia Pacific Laboratory Accreditation Corporation (APLAC) Mutual Recognition Arrangement. Under this agreement, all TUV Rheinland at 1279 Quarry Ln, Pleasanton, CA 94566 test results and test reports within the scope of the laboratory NIST / A2LA accreditation will be accepted by each member country.

2.2 Test Facilities

All of the test facilities are located at 1279 Quarry Lane, Pleasanton, California 94566, USA. The 2305 Mission College, Santa Clara, 95054, USA location is considered a Pleasanton Annex.

2.2.1 Emission Test Facility

The Semi-Anechoic chamber and AC Line Conducted measurement facility used to collect the radiated and conducted data has been constructed in accordance with ANSI C63.7:1992. The site has been measured in accordance with and verified to comply with the theoretical normalized site attenuation requirements of ANSI C63.4-2009, at a test distance of 3 and 5 meters. The site is listed with the FCC and accredited by A2LA (Testing Cert #3331.02). The 3/5-meter semi-anechoic chamber used to collect the radiated data has been verified to comply with the theoretical normalized site attenuation requirements of ANSI C63.4-2009, at a test distance of 3 meter and 5 meters. A report detailing this site can be obtained from TUV Rheinland of North America.

2.2.2 Immunity Test Facility

ESD, EFT, Surge, PQF: These tests are performed in an environmentally controlled room with a 3.7 m x 4.8 m x 3.175 mm thick aluminum floor connected to PE ground.

For ESD testing, tabletop equipment is placed on an insulated mat with a surface resistivity of 10^9 Ohms/square on a 1.6 m x 0.8 m x 0.8 m high non-conductive table with a 3.175 mm aluminum top (Horizontal Coupling Plane). The HCP is connected to the main ground plane via a low impedance ground strap through two 470-k Ω resistors. The Vertical Coupling Plane consists of an aluminum plate 50 cm x 50 cm x 3.175 mm thick. The VCP is connected to the main ground plane via a low impedance ground strap through two 470-k Ω resistors.

For EFT, Surge, PQF, the HCP and VCP are removed.

RF Field Immunity testing is performed in a 7.3m x 4.3m x 4.1m anechoic chamber.

RF Conducted and Magnetic Field Immunity testing is performed on a 4.8m x 3.7m x 3.175mm thick aluminum ground plane.

All test areas allow a minimum distance of 1 meter from the EUT to walls or conducting objects.

2.3 Measurement Uncertainty

Two types of measurement uncertainty are expressed in this report, per *ISO Guide To The Expression Of Uncertainty In Measurement*, 1st Edition, 1995.

The Combined Standard Uncertainty is the standard uncertainty of the result of a measurement when that result is obtained from the values of a number of other quantities; it is equal to the positive square root of the sum of the variances or co-variances of these other quantities, weighted according to how the measurement result varies with changes in these quantities. The term *standard uncertainty* is the result of a measurement expressed as a standard deviation.

2.3.1 Sample Calculation – radiated & conducted emissions

The field strength is calculated by subtracting the Amplifier Gain and adding the Cable Loss and Antenna Correction Factor to the measured reading. The basic equation is as follows:

$$\text{Field Strength (dB}\mu\text{V/m)} = \text{RAW} - \text{AMP} + \text{CBL} + \text{ACF}$$

Where: RAW = Measured level before correction (dBμV)

AMP = Amplifier Gain (dB)

CBL = Cable Loss (dB)

ACF = Antenna Correction Factor (dB/m)

$$\mu\text{V/m} = 10^{\frac{\text{dB}\mu\text{V/m}}{20}}$$

Sample radiated emissions calculation @ 30 MHz

Measurement +Antenna Factor–Amplifier Gain+Cable loss=Radiated Emissions (dBuV/m)

$$25 \text{ dBuV/m} + 17.5 \text{ dB} - 20 \text{ dB} + 1.0 \text{ dB} = 23.5 \text{ dBuV/m}$$

2.3.2 Measurement Uncertainty

	U_{lab}	U_{cispr}
Radiated Disturbance		
30 MHz – 40,000 MHz	3.2 dB	5.2 dB
Conducted Disturbance @ Mains Terminals		
150 kHz – 30 MHz	2.4 dB	3.6 dB
Disturbance Power		
30 MHz – 300 MHz	3.92 dB	4.5 dB

Measurement Uncertainty – Immunity Testing

The estimated combined standard uncertainty for ESD immunity measurements is $\pm 4.1\%$.
The estimated combined standard uncertainty for radiated immunity measurements is ± 2.7 dB.
The estimated combined standard uncertainty for conducted immunity measurements is ± 1.4 dB.
The estimated combined standard uncertainty for damped oscillatory wave immunity measurements is $\pm 8.8\%$.
The estimated combined standard uncertainty for harmonic current and flicker measurements is $\pm 0.45\%$.

Measurement Uncertainty – Radio Testing

The estimated combined standard uncertainty for frequency error measurements is ± 3.88 Hz
The estimated combined standard uncertainty for carrier power measurements is ± 1.59 dB.
The estimated combined standard uncertainty for adjacent channel power measurements is ± 1.47 dB.
The estimated combined standard uncertainty for modulation frequency response measurements is ± 0.46 dB.
The estimated combined standard uncertainty for transmitter conducted emission measurements is ± 4.01 dB

The expanded uncertainty at a level of 95% confidence is obtained by multiplying the combined standard uncertainty by a coverage factor of 2. Compliance criteria are not based on measurement uncertainty.

2.4 Calibration Traceability

All measurement instrumentation is traceable to the National Institute of Standards and Technology (NIST). Measurement method complies with ANSI/NCSL Z540-1-1994 and ISO Standard 17025:2005. Equipment calibration records are kept on file at the test facility.

3 Product Information

3.1 Product Description

PTC-3001 radio is Transceiver intended for locomotive communications and is part of Lilee systems TransAir PTC-3000 product family products.

The Lilee Systems TransAir PTC-3001 product family includes three components: TransAir Wayside, TransAir Base Station and TransAir Locomotive radios. The TransAir PTC product family's design is based on both ACSES and an interoperable train control (ITC) architecture that in conjunction with the Lilee Mobility Controller (LMC-5x00 series) enables seamless roaming and constant communication between central traffic control, wayside signals, and onboard locomotive networks. This combined solution can help freight railroads and transit operators maintain compliance with the Federal Rail Safety Improvement Act of 2008.

3.2 Equipment Configuration

A description of the equipment configuration is given in the Test Plan Section. The EUT was tested as called for in the test standard and was configured and operated in a manner consistent with its intended use. The EUT was connected to rated power and allowed to reach intended operating conditions. The placement of the EUT system components was guided by the test standard and selected to represent typical installation conditions.

In the case of EUT that can operate in more than one configuration, preliminary testing was performed to determine the configuration that produced maximum radiation.

The final configuration was selected to produce the worst case radiation for emissions testing and to place the EUT in the most susceptible state for immunity testing.

3.3 Operating Mode

A description of the operation mode is given in the Test Plan Section. For EUT that can operate in more than one state, preliminary testing was performed to determine the operating mode that produced maximum radiation.

The final operating mode was selected to produce the worst case radiation for emissions testing and to place the EUT in the most susceptible state for immunity testing.

3.4 Duty Cycle:

EUT was operated at 100% duty cycle. No duty cycle correction was added to the results.

3.5 Unique Antenna Connector

An intentional radiator shall be designed to ensure that no antenna other than that furnished by the responsible party shall be used with the device. The use of a permanently attached antenna or of an antenna that uses a unique coupling to the intentional radiator shall be considered sufficient to comply with the provisions of this Section. The manufacturer may design the unit so that a broken antenna can be replaced by the user, but the use of a standard antenna jack or electrical connector is prohibited. This requirement does not apply to carrier current devices or to devices operated under the provisions of CFR47 Parts 15.211, 15.213, 15.217, 15.219, or 15.221.

3.5.1 Results

EUT is professionally installed. This requirement is not applicable.

4 Emission Requirements – 218 to 219 MHz Band

Testing was performed in accordance with CFR 47 Part 95. These test methods are listed under the laboratory's A2LA Scope of Accreditation. This test measures the levels emanating from the EUT, thus evaluating the potential for the EUT to cause radio frequency interference to other electronic devices. Procedures described in section 8 of the standard were used.

4.1 Output Power Requirements

The maximum output power requirement is the maximum equivalent isotropic radiated power delivering at the transmitting antenna under specified conditions of measurements in the presence of modulation.

The maximum output power and harmonics shall not exceed CFR47 Part 95F

4.1.1 Test Method

The conducted method was used to measure the power output according to ANSI/TIA-603-C: 2004. The measurement was performed with modulation per ANSI/TIA-603-C: 2004 was conducted on 1 channel in each operating range. The worst mode result indicated below.

Test Setup:

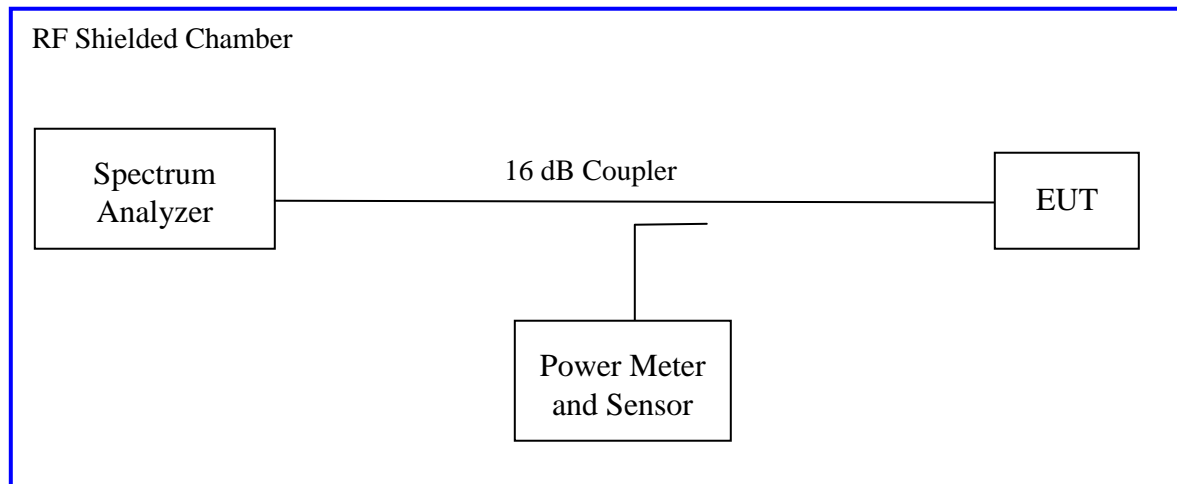

4.1.2 Results

As originally tested, the EUT was found to be compliant to the requirements of the test standard(s).

Table 2: RF Output Power at the Antenna Port – Test Results

Test Conditions: Conducted Measurement, Normal Temperature						
Antenna Type: Max Fixed station gain 3.0 dBi Yagi Antenna						
Signal State: Modulated see below						
Ambient Temp.: 21 °C			Relative Humidity: 39%			
Freq.	Modulation	Power Setting	Measured power at Antenna Port		ERP Limit Base Station Mode	Result
MHz			dBm	Watts	CFR Part 95F	
218.250	GMSK 9600	ATT 11	36.52	4.48	20 Watts	Complied
	QPSK 16K	ATT 11	36.02	3.99		
	QPSK 32K	ATT 16	36.59	4.56		
218.750	GMSK 9600	ATT 11	36.55	4.51		
	QPSK 16K	ATT 11	35.69	3.70		
	QPSK 32K	ATT 16	36.32	4.28		

Note1: ¹ Transmitter output power for fixed stations is factory set max limit at 36.59dBm (4.56 watts). The EIRP calculation is based on max gain antenna of 3dBi. The equipment design prevents higher power by lockout/error message. Licencee ensures Fixed units are limited to 20Watts ERP.

Mobile Mode

Test Conditions: Conducted Measurement, Normal Temperature						
Antenna Type: Highest gain 3 dBi Yagi Antenna						
Signal State: Modulated						
Ambient Temp.: 21 °C			Relative Humidity: 39%			
Frequency	Modulation	Power setting	Measured Power at Antenna Port		ERP Limit	Result
			dBm	Watts	Mobile Mode	
MHz					Part 95F	
218.250	GMSK 9600	ATT 19	28.65	0.73	4Watts	Complied
	QPSK 16K	ATT 17	29.47	0.88		
	QPSK 32K	ATT 22	29.13	0.82		
218.750	GMSK 9600	ATT 17	29.21	0.83		
	QPSK 16K	ATT 18	30.00	1.00		
	QPSK 32K	ATT 22	29.60	0.91		

Note1: Transmitter output power for mobile stations is factory set max limit at 30.0 dBm(1Watt). Licencee ensures mobile units are limited to 4watts ERP. Power measurements were performed as indicated in the above table. Only worst case/ limited number of plots are placed in the report.

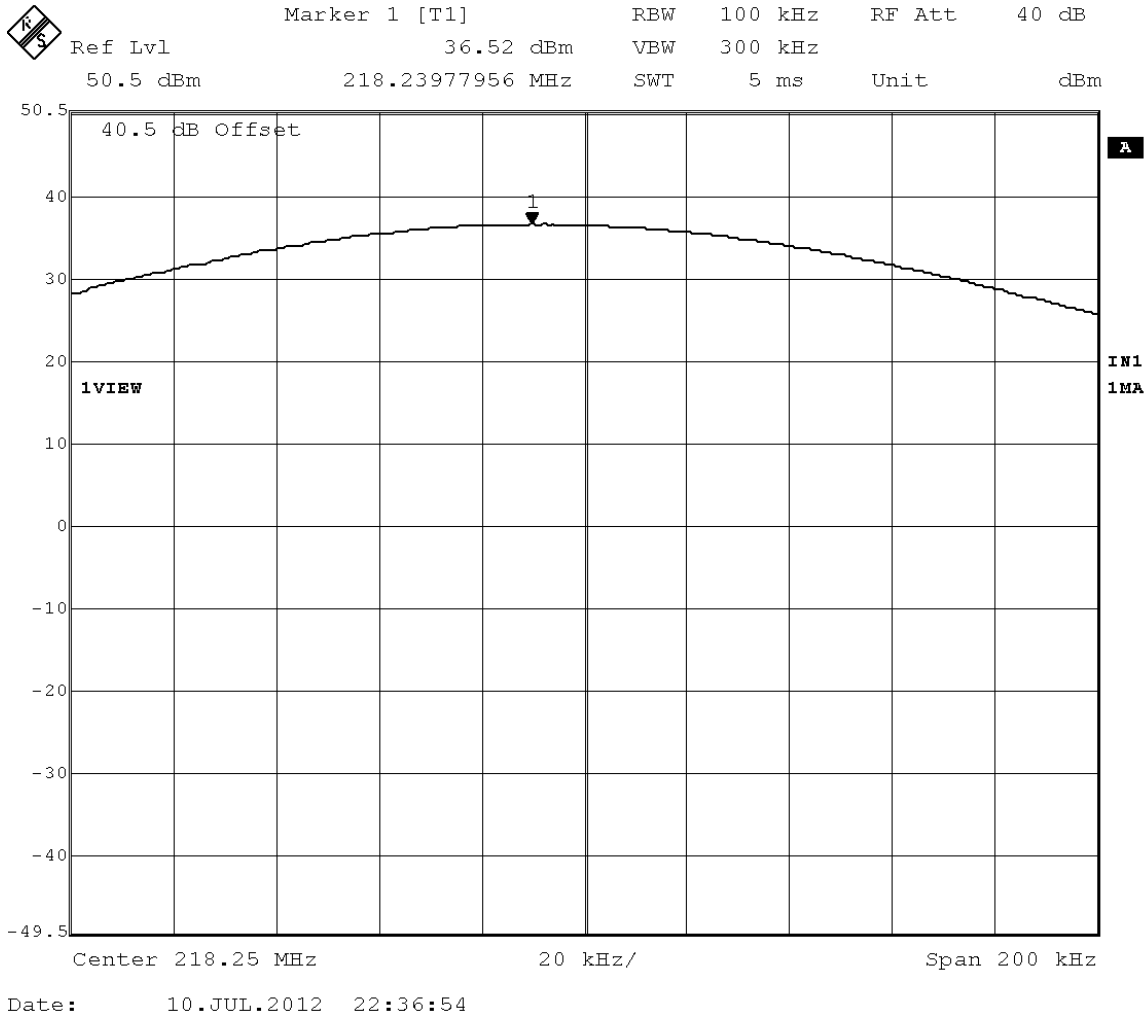

Figure 1: Maximum Transmitted Power, 218.250 MHz at GMSK 9600

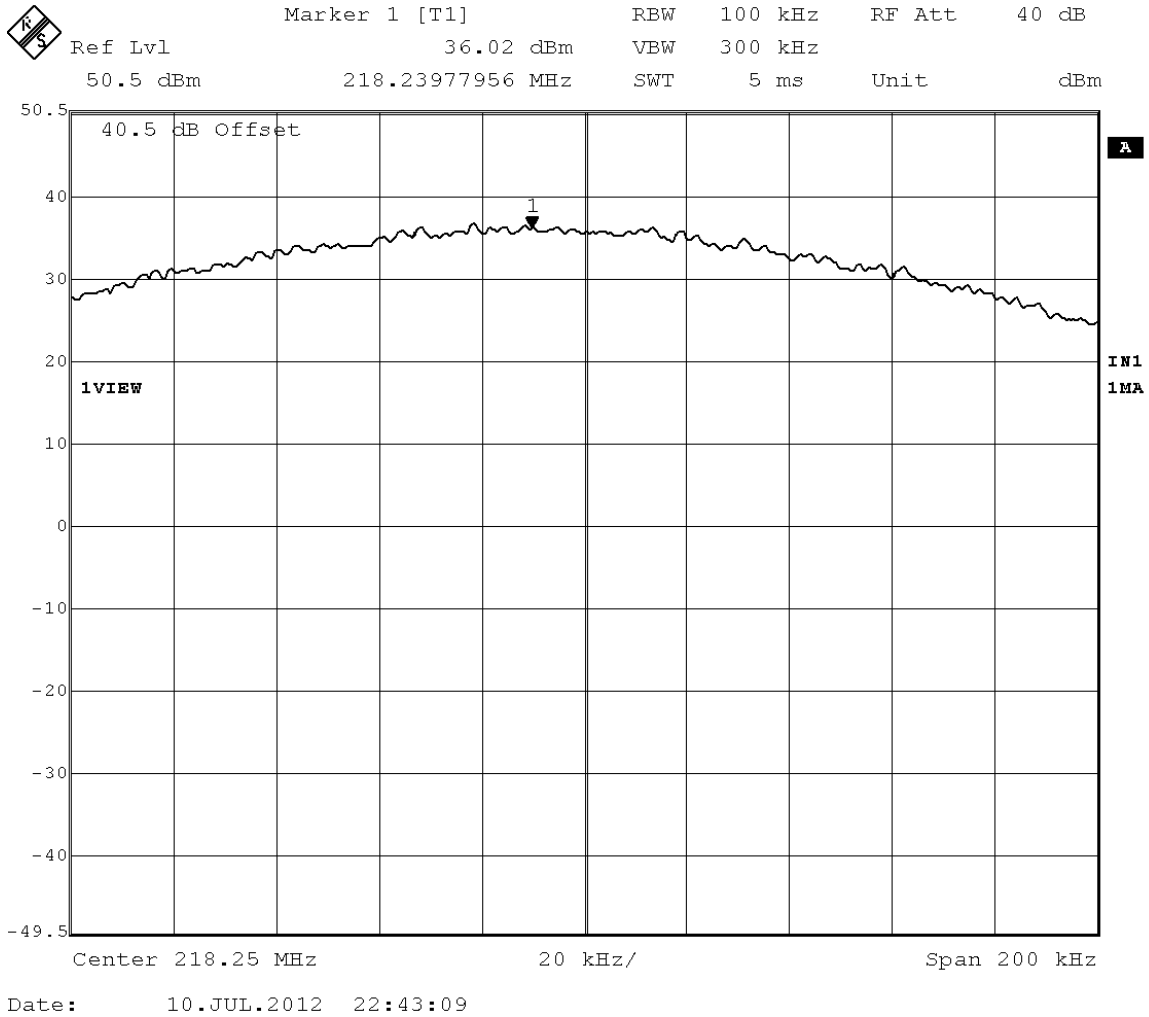

Figure 2: Maximum Transmitted Power, 218.250 MHz at 16 QPSK

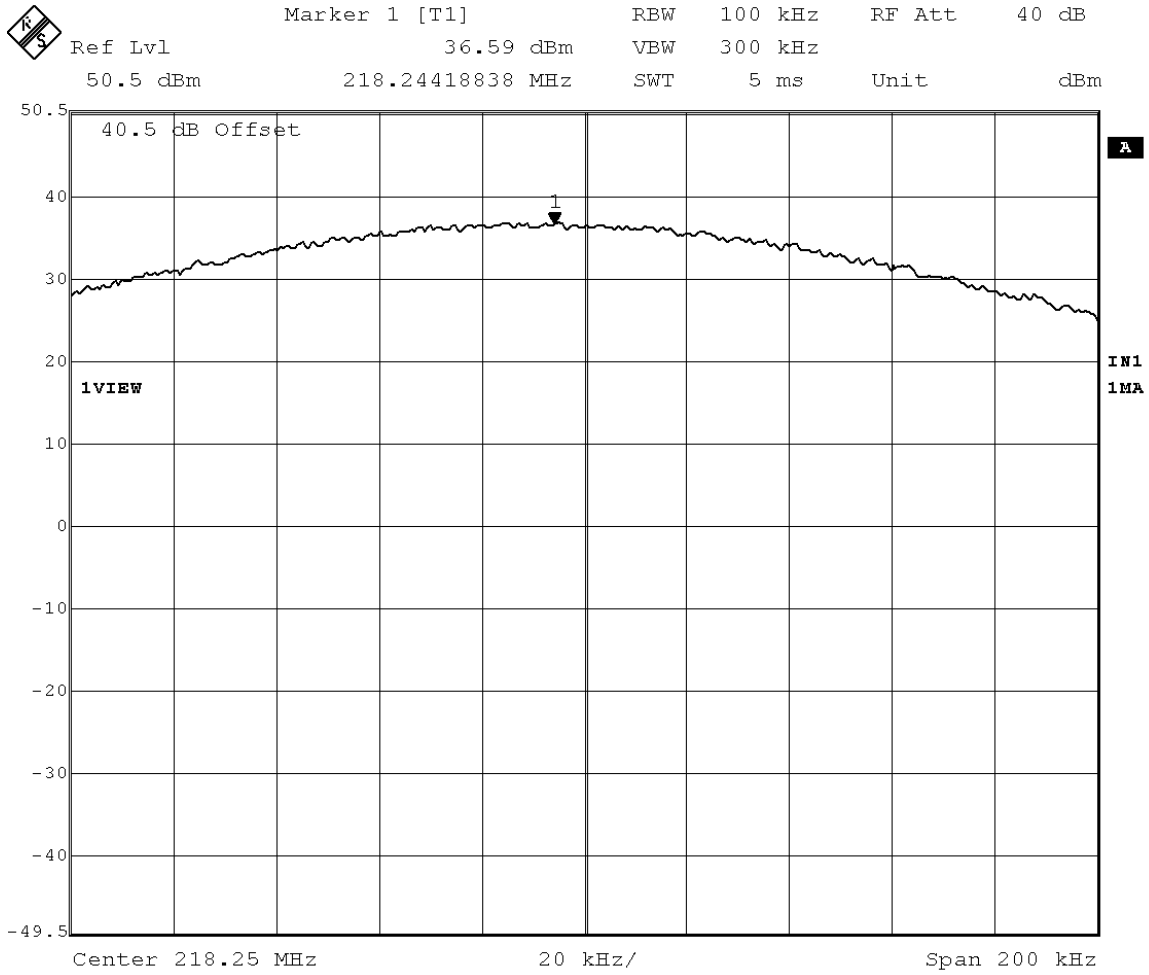
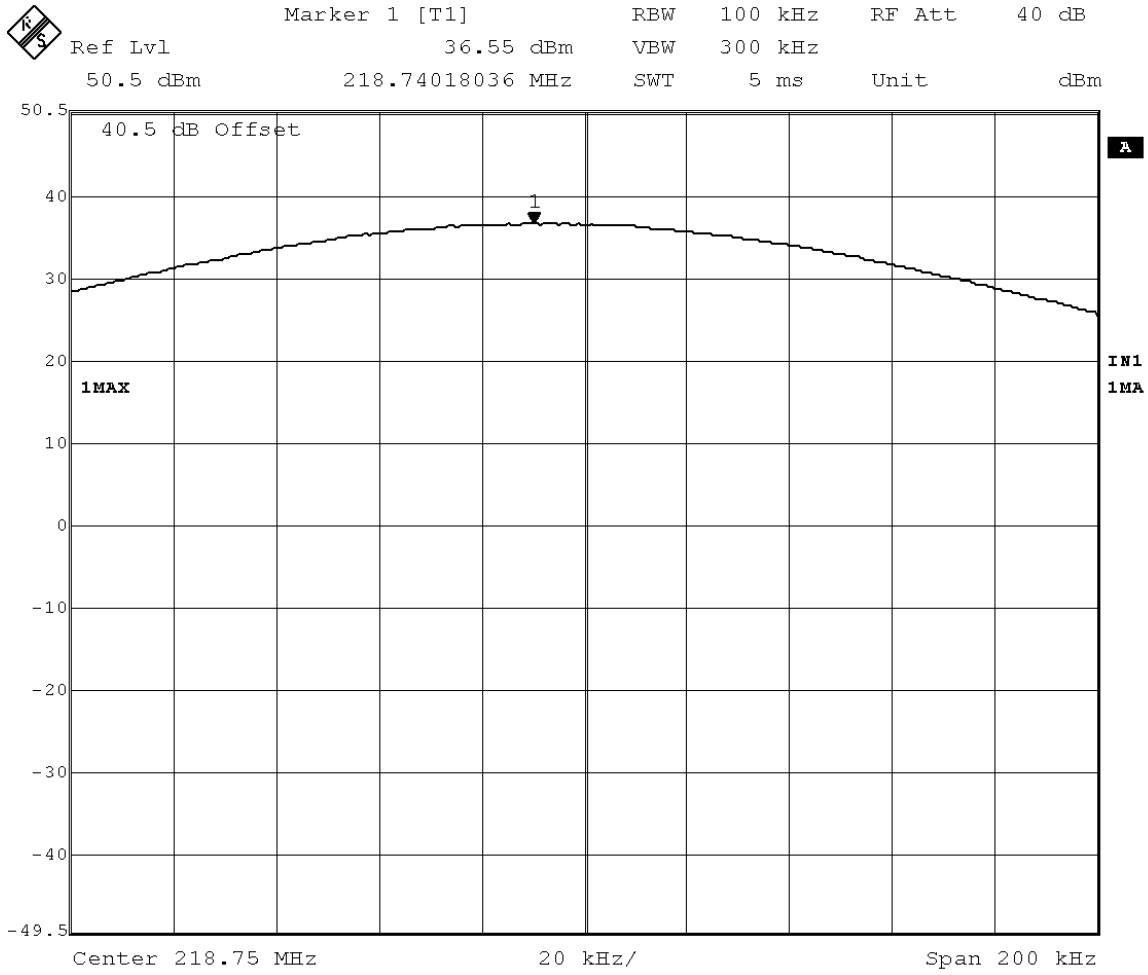
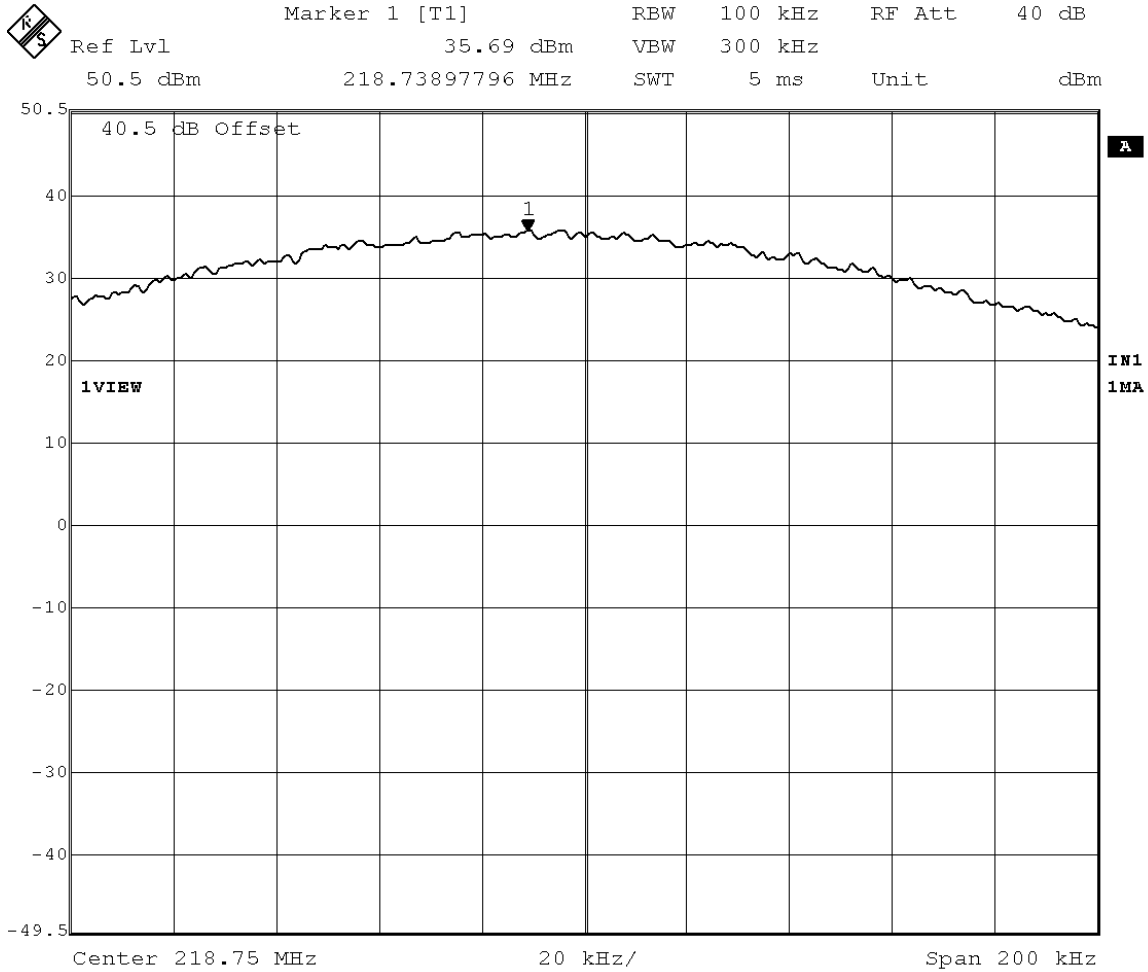

Figure 3: Maximum Transmitted Power, 218.250 MHz at 32 QPSK



Date: 10.JUL.2012 22:35:31

Figure 4: Maximum Transmitted Power, 218.750 MHz at GMSK 9600



Date: 10.JUL.2012 22:44:45

Figure 5: Maximum Transmitted Power, 218.5 MHz at 16 QPSK

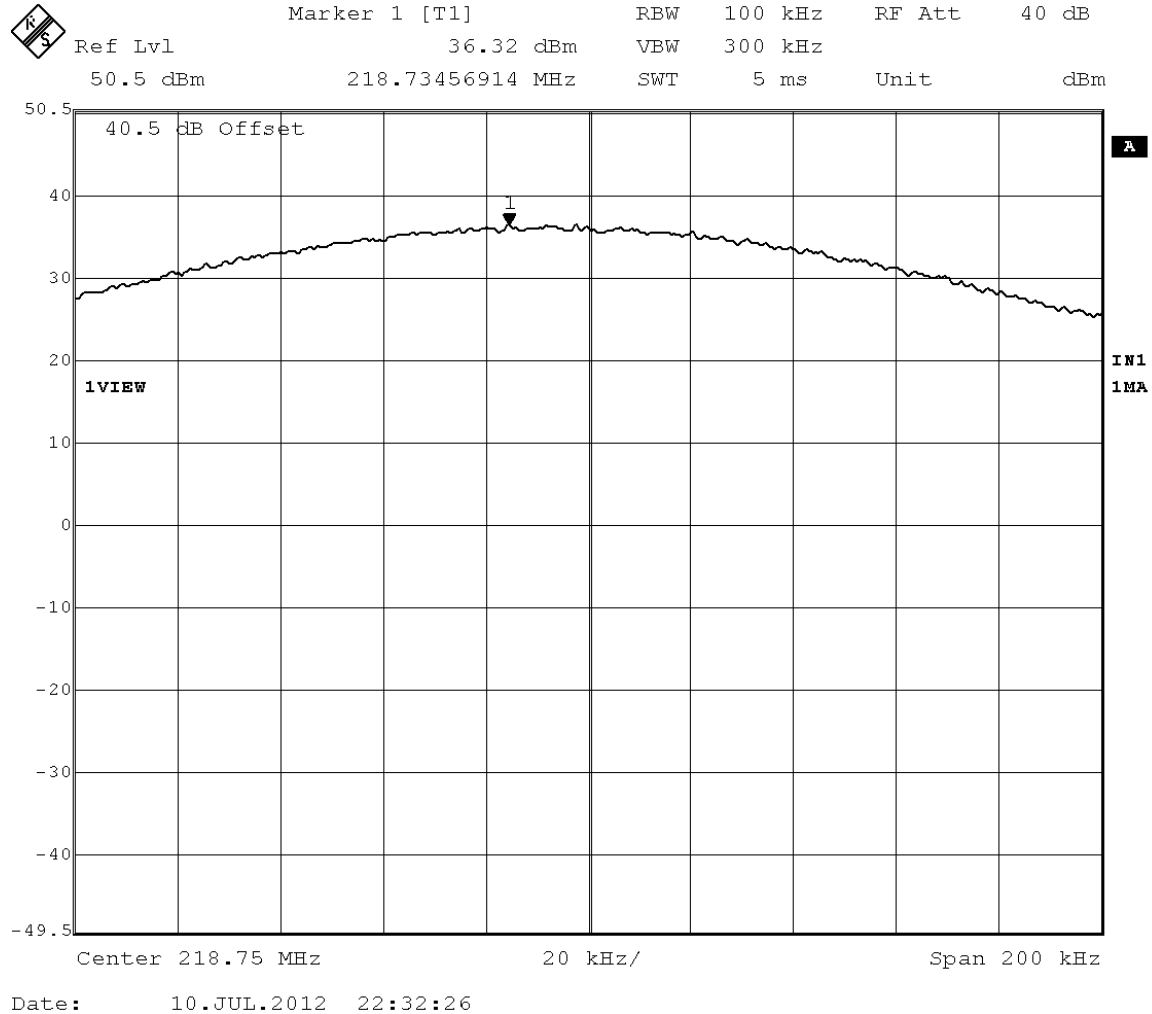
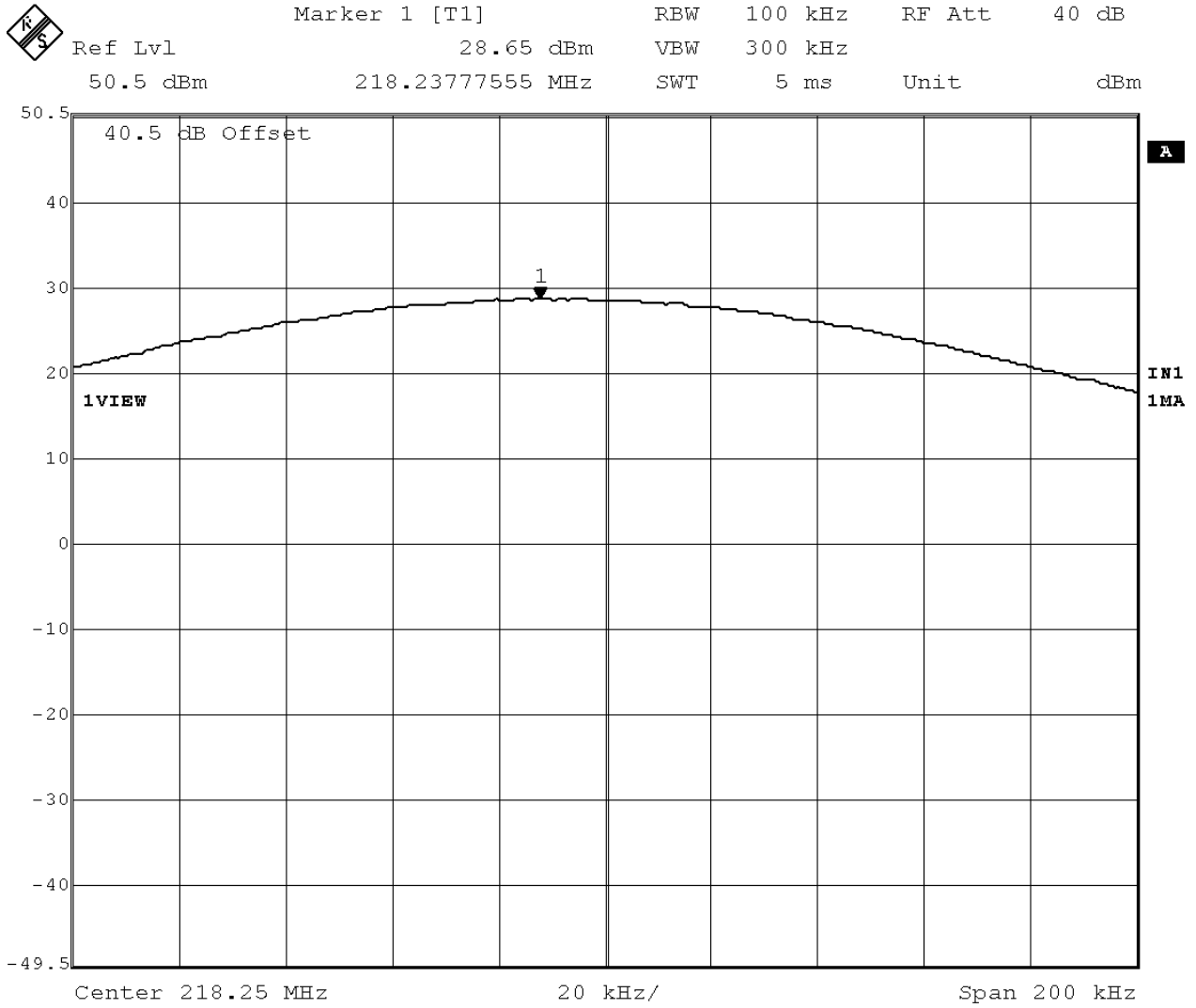

Figure 6: Maximum Transmitted Power, 218.75 MHz at 32 QPSK



Date: 10.JUL.2012 22:58:04

Figure 7: Maximum Transmitted Power, 218.25 MHz at GMSK

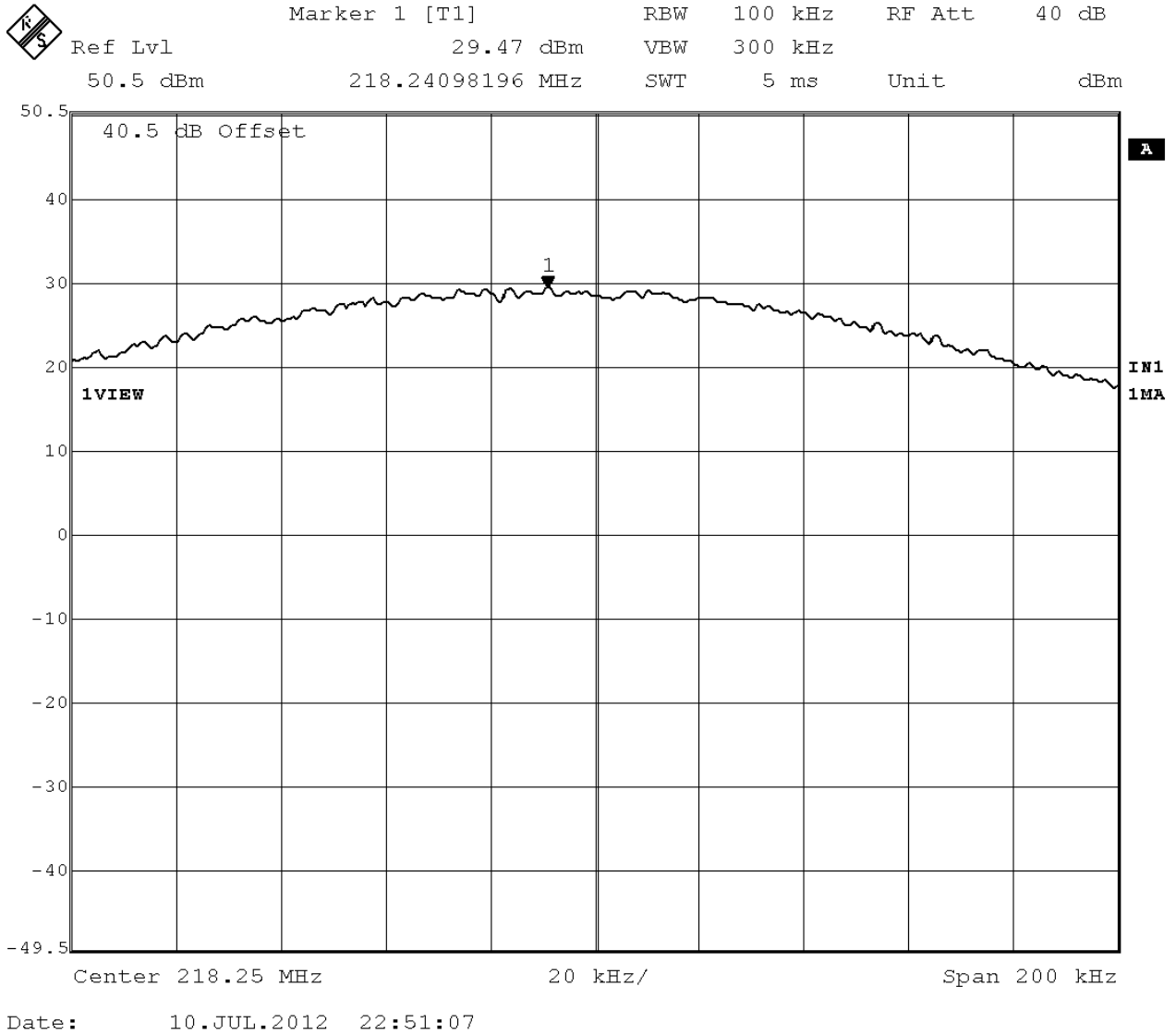

Figure 8: Maximum Transmitted Power, 218.25 MHz at 16 QPSK

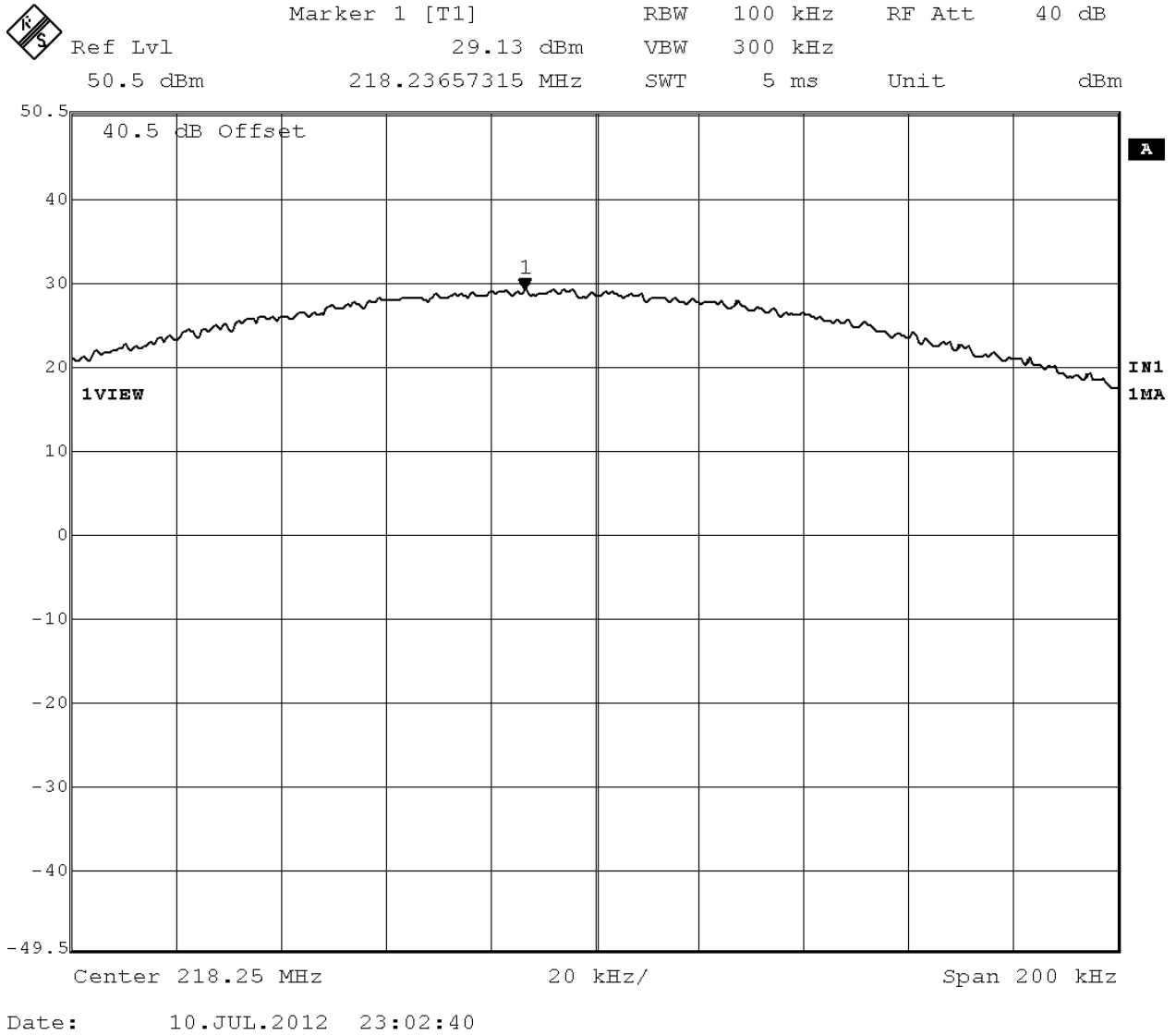
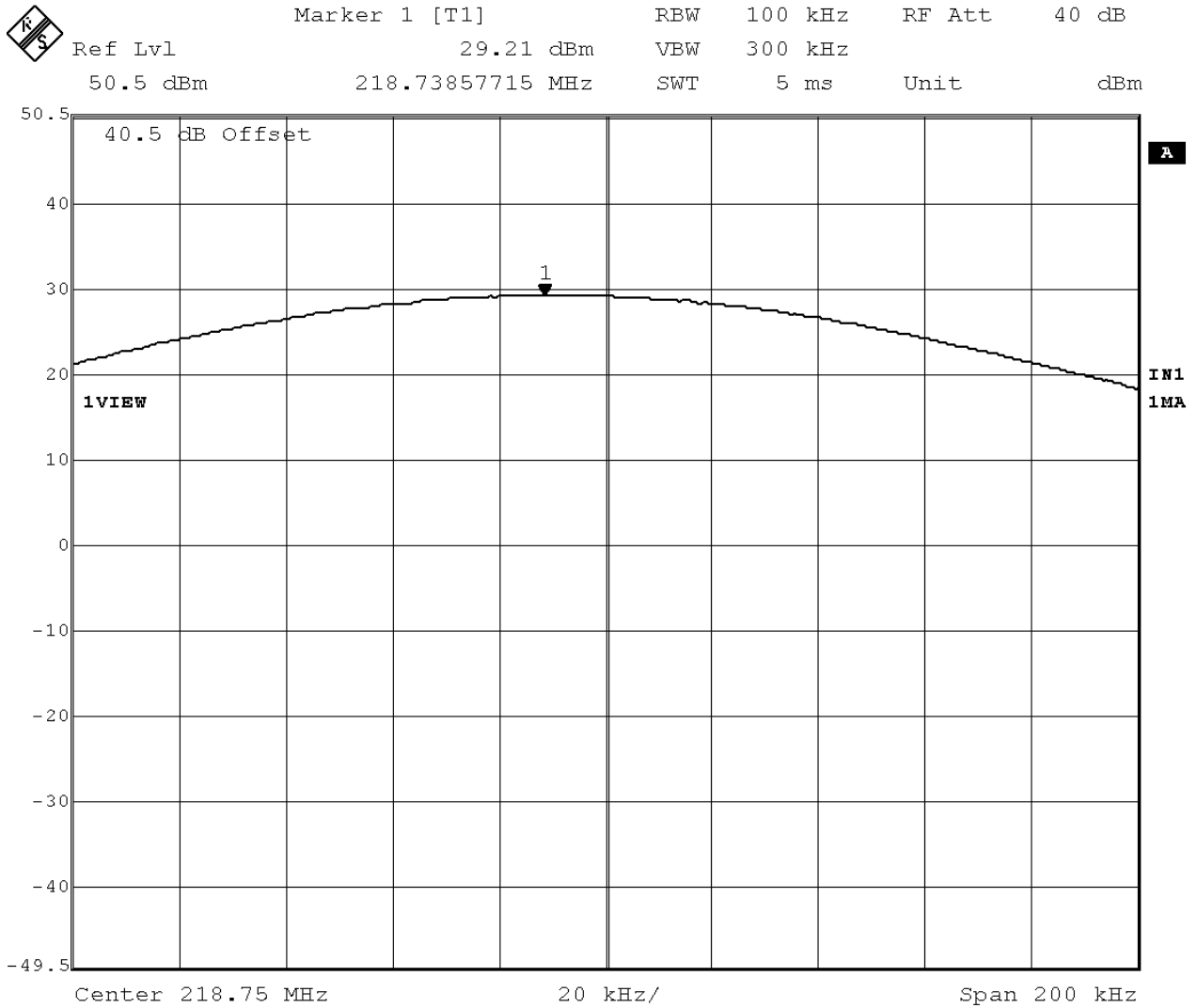
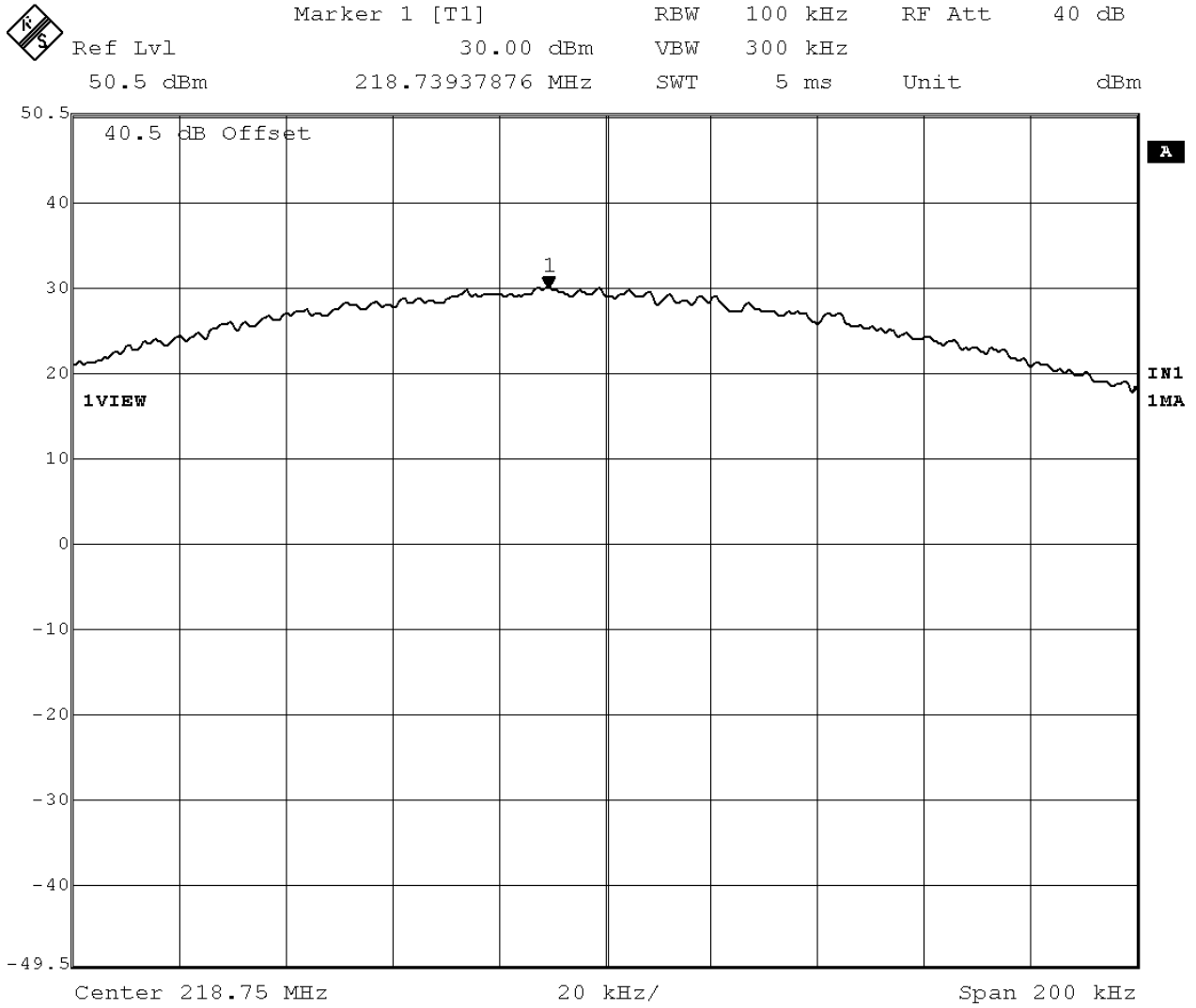

Figure 9: Maximum Transmitted Power, 218.250 MHz at 32 QPSK



Date: 10.JUL.2012 22:59:46

Figure 10: Maximum Transmitted Power, 218.75 MHz GMSK



Date: 10.JUL.2012 22:49:31

Figure 11: Maximum Transmitted Power, 218.750MHz at 16 QPSK

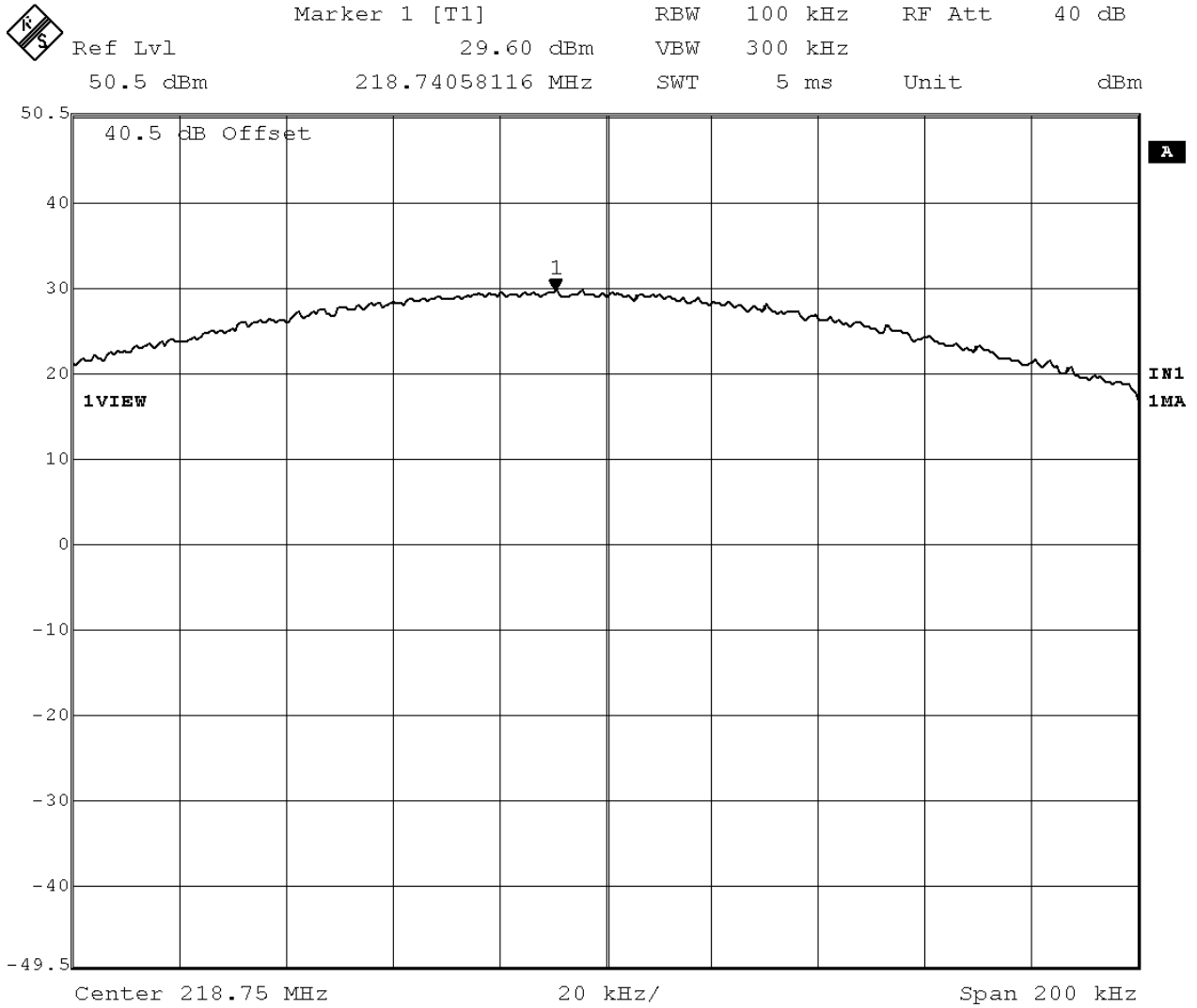

Date: 10.JUL.2012 23:01:36

Figure 12: Maximum Transmitted Power, 218.75 MHz at 32 QPSK

4.2 Occupied Bandwidth

The occupied bandwidth is measured at an amplitude level reduced from the reference level by a specified ratio. The reference level is the level of the highest amplitude signal observed from the transmitter at the fundamental frequency.

The 99% bandwidth is the bandwidth in which 99% of the transmitted power occupied.

The 26 dB bandwidth is defined the bandwidth of 26 dB from highest transmitted level of the fundamental frequency.

4.2.1 Test Method

The conducted method was used to measure the occupied bandwidth. The measurement was performed with modulation per CFR47 Part 95. Initial investigation was performed at different data rates and TX chains. The narrowest bandwidths at each operational mode were measured on 3 operating channels. The worst sample result indicated below.

Test Setup:

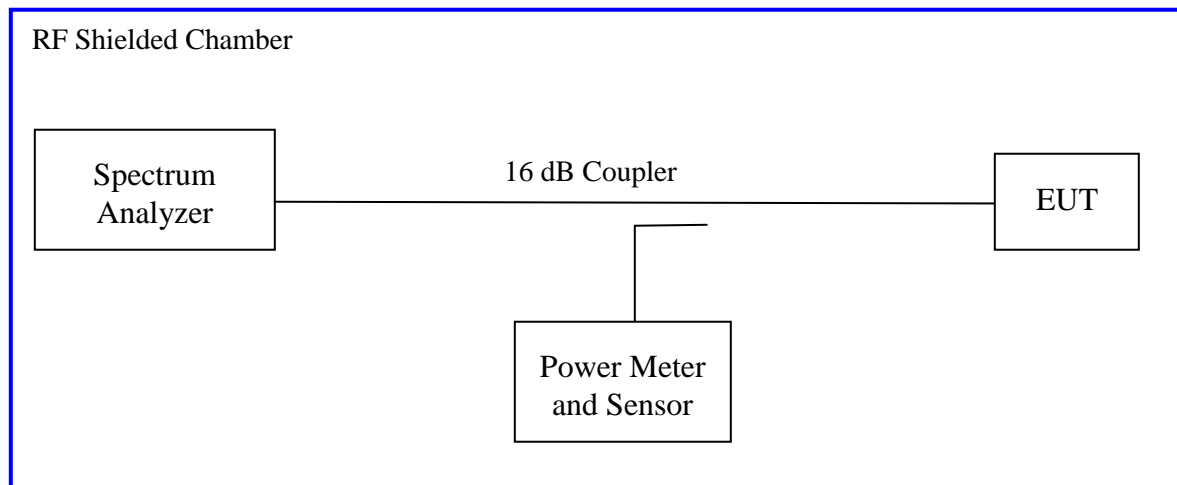

4.2.2 Results

As originally tested, the EUT was found to be compliant to the requirements of the test standard(s).

Table 3: Occupied Bandwidth – Test Results

Test Conditions: Conducted Measurement, Normal Temperature and Voltage only				
Antenna Type: External			Power Setting: See test plan	
Max. Antenna Gain: 3 dBi			Signal State: Modulated	
Ambient Temp.: 21 °C			Relative Humidity: 33%	
Bandwidth (KHz)				
Freq. (MHz)	Modulation/ Data rate	26 dB BW	99% Occupied BW	Results
218.5	GMSK 9600	11.97	8.92	Pass
	16 QPSK	19.78	10.34	Pass
	32QPSK	36.56	23.93	Pass

Note: These measurements were also performed at higher power for part 80 /90 see test report 31260509.003

Agilent 14:45:56 Apr 20, 2012

R T

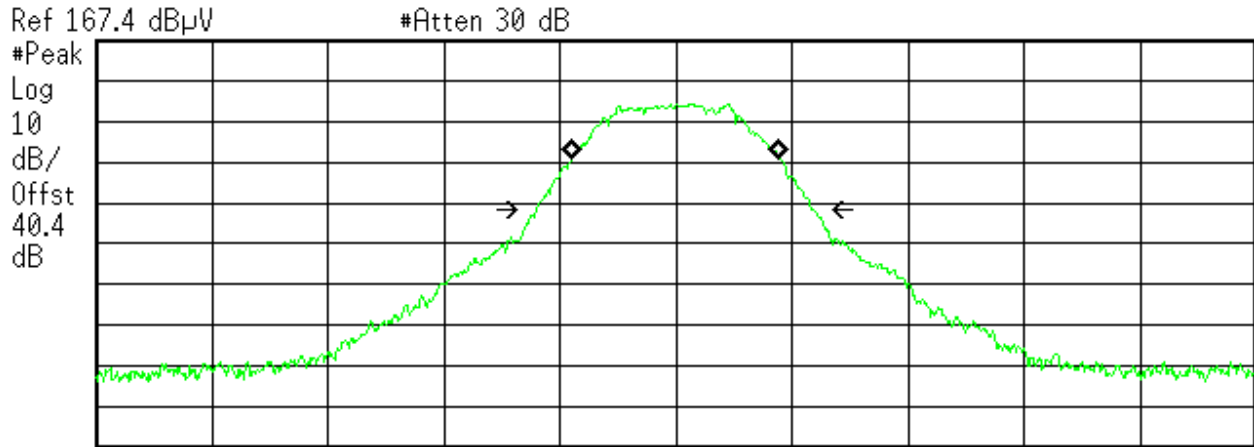

Center 218.5 MHz Span 50 kHz
 #Res BW 1 kHz #VBW 3 kHz #Sweep 100 ms (1000 pts)

Occupied Bandwidth
 8.9284 kHz

Occ BW % Pwr 99.00 %
Occupied Bandwidth -26.00 dB

Transmit Freq Error -31.695 Hz
x dB Bandwidth 11.970 kHz

Figure 13: Occupied Bandwidth at– Operating Channel 218.5 MHz at GMSK

Agilent 15:17:55 Apr 20, 2012

R T

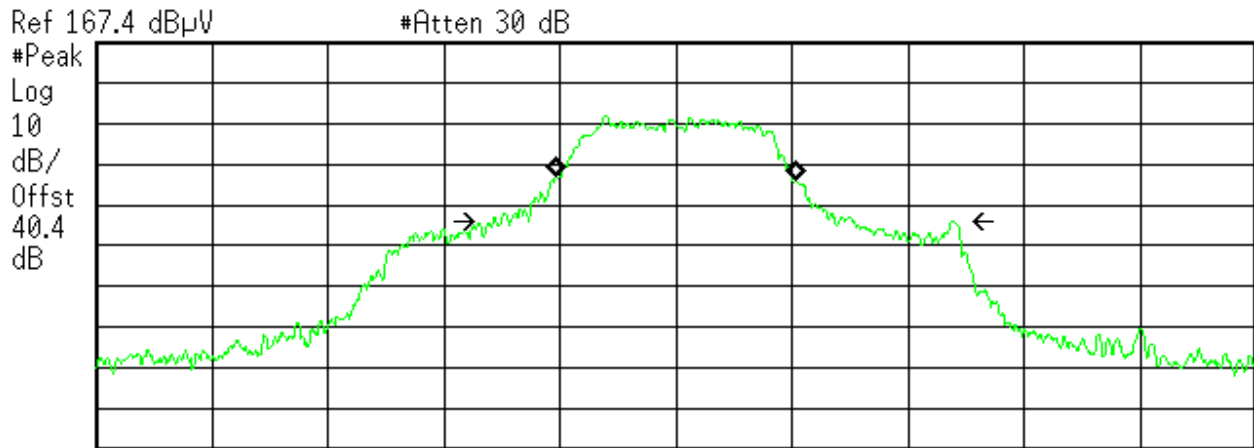

Center 218.5 MHz Span 50 kHz
 #Res BW 1 kHz #VBW 3 kHz #Sweep 100 ms (1000 pts)

Occupied Bandwidth
 10.3497 kHz

Occ BW % Pwr 99.00 %
x dB -26.00 dB

Transmit Freq Error -13.608 Hz
x dB Bandwidth 19.781 kHz

Figure 14: Occupied Bandwidth at– Operating Channel 218.5 MHz at 16 QPSK

Agilent 14:50:17 Apr 20, 2012

R T

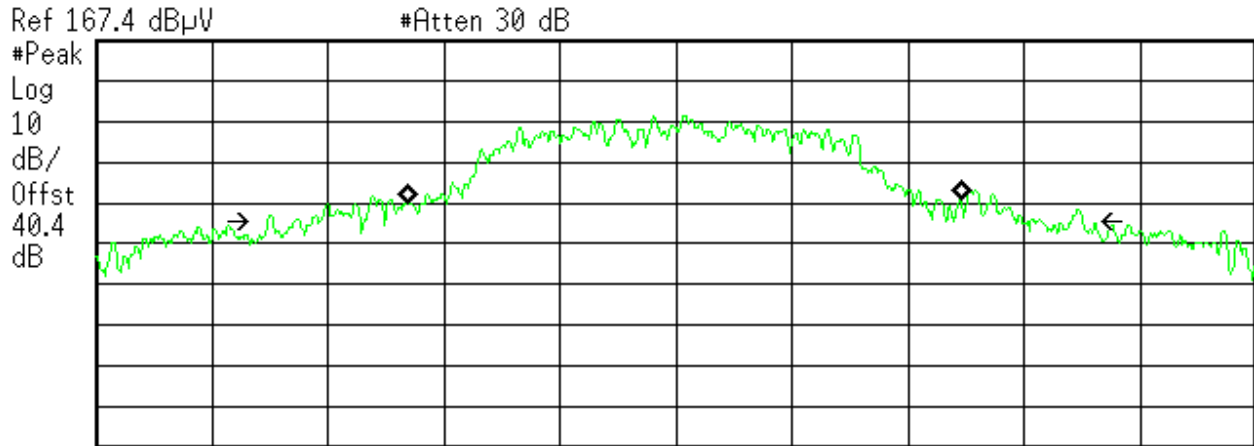

Center 218.5 MHz Span 50 kHz
 #Res BW 1 kHz #VBW 3 kHz #Sweep 100 ms (1000 pts)

Occupied Bandwidth
 23.9312 kHz

Occ BW % Pwr 99.00 %
x dB -26.00 dB

Transmit Freq Error 288.958 Hz
x dB Bandwidth 36.567 kHz

Figure 15: Occupied Bandwidth at– Operating Channel 218.5 MHz at 32 QPSK

Note: These measurements were also performed at higher power for Part 80/90 see report number 31260509.003

4.3 Spectral Mask requirements

4.3.1.1.1 95.857 Emission masks.

*The transmitters used in the radio service governed by this part of radio service must comply
Applicable mask Emission requirements of 95.857*

- (1) Zero dB on any frequency within the authorized frequency segment.
 - (2) At least 28 dB on any frequency removed from the midpoint of the assigned frequency segment by more than 250 kHz up to and including 750 kHz;
 - (3) At least 35 dB on any frequency removed from the midpoint of the assigned frequency segment by more than 750 kHz up to and including 1250 kHz;
 - (4) At least 43 plus $10 \log$ (base 10) (mean power in watts) dB on any frequency removed from the midpoint of the assigned frequency segment by more than 1250 kHz.
- (c) When testing for certification, all measurements of unnecessary radiation are performed using a carrier frequency as close to the edge of the authorized frequency segment as the transmitter is designed to be capable of operating.

Results

The Out of band emission was performed on the conducted test sample.

As originally tested, the EUT was found to be compliant to the requirements of the test standard(s).

Table 4: Spectral Mask Requirements – Test Results

Test Conditions: Conducted Measurement, Normal Temperature and Voltage only				
Antenna Type: External			Power Setting: See test plan	
Max. Antenna Gain: 3dBi			Signal State: Modulated	
Ambient Temp.: 21 °C			Relative Humidity: 39%	
Emission Mask				
Operating Freq. MHz	Mode	Limit (dBm)	Measured Value (dBm)	Result
218.250	GMSK 9600	Mask 95.858	See plots #16	Pass
218.250	16 QPSK	Mask 95.858	See plots #17,18, 19 & 20	Pass
218.250	32 QPSK	Mask 95.858	See plots #21	Pass

Note1: All mask measurements were performed as indicated in the above table. Only worst case/ limited number of plots are placed in the report. The mask is applicable for entire range of 218 to 219 MHz

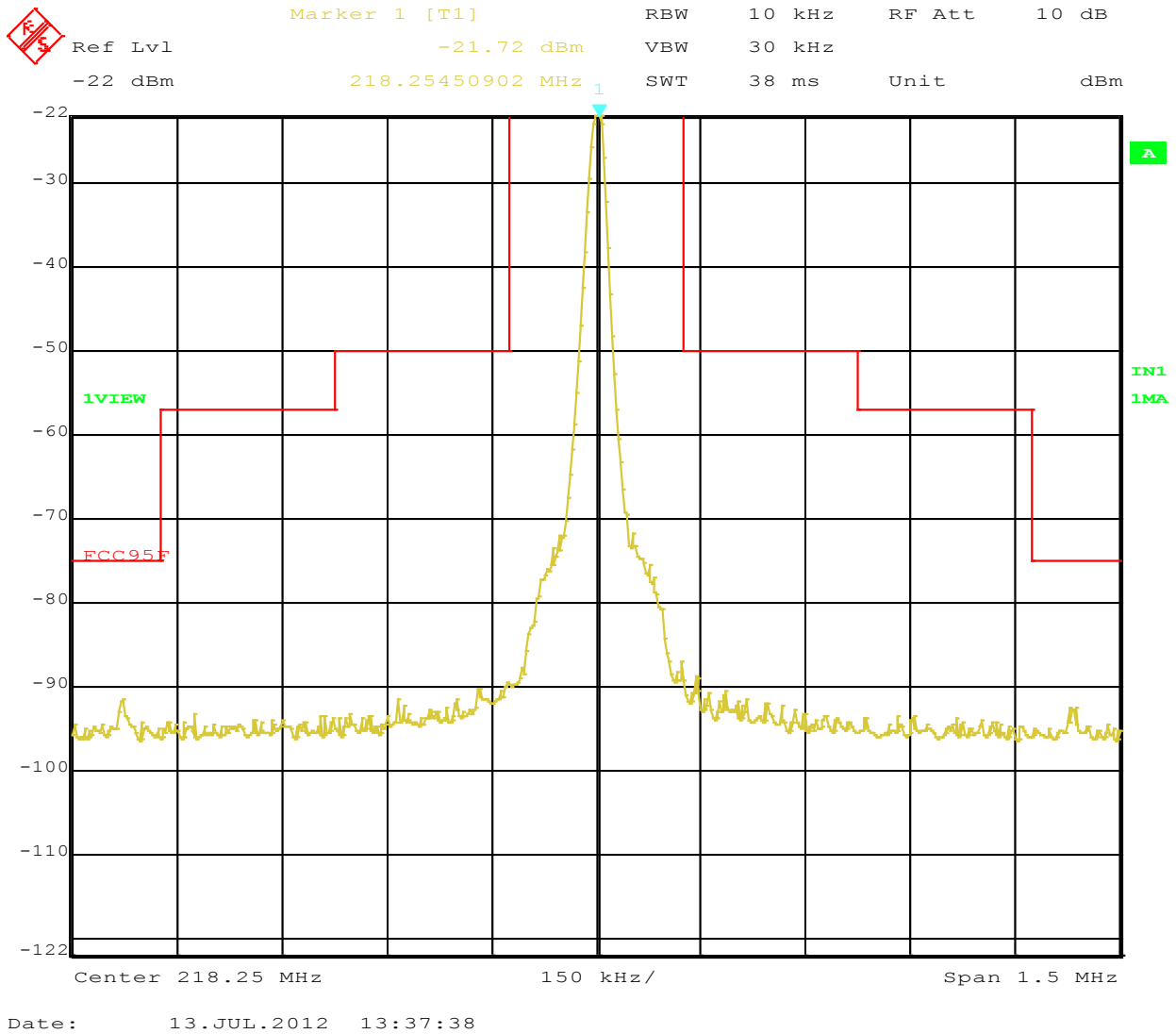
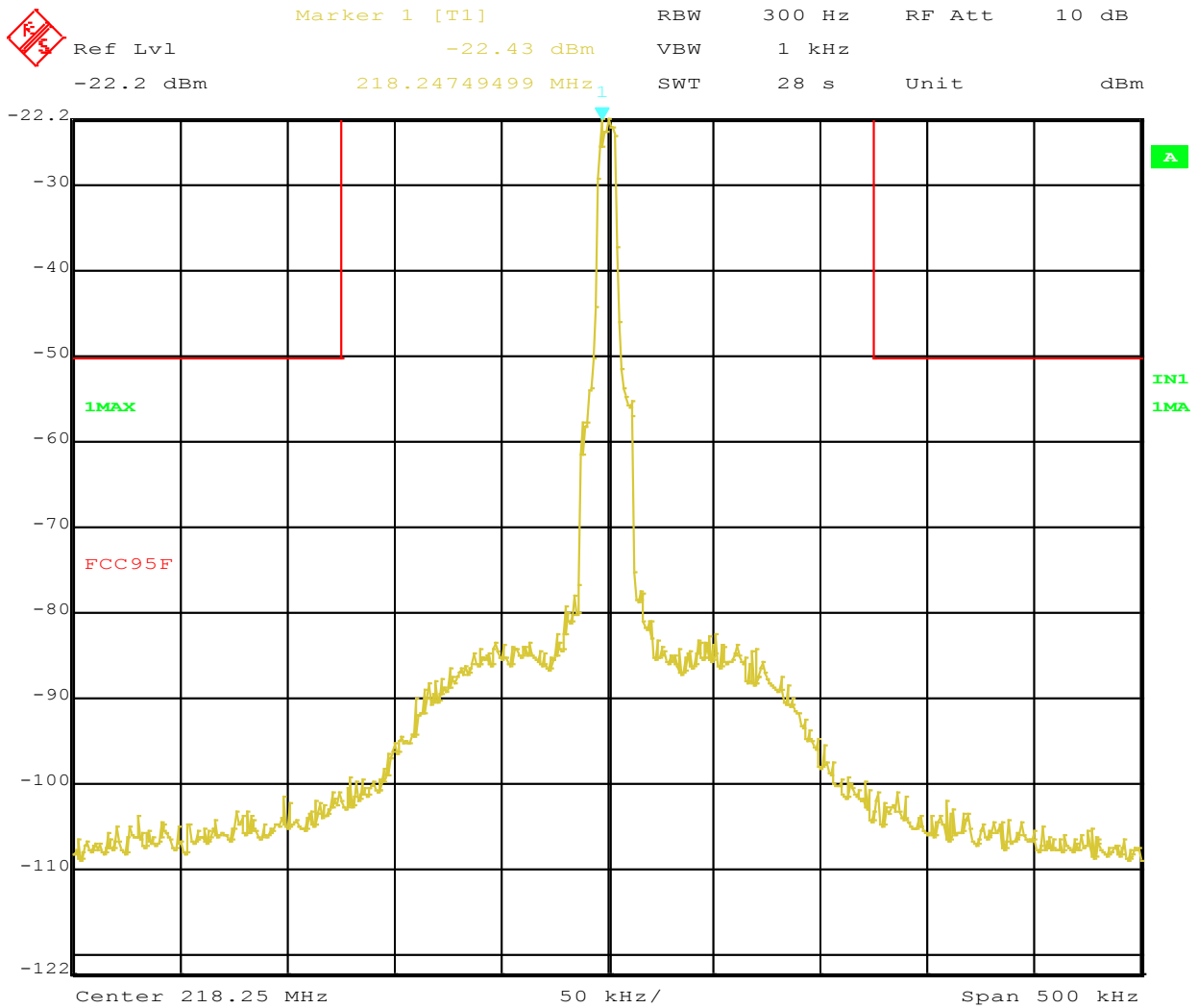

Figure 16: Emission mask requirement at Operating Channel 218.25 MHz at GMSK

Note: Reference level of spectrum analyzer coincides with highest power level of the EUT.



Date: 13.JUL.2012 13:17:54

Figure 17: Emission mask Requirement at Operating Channel 218.250 MHz at 16 QPSK

Note: Reference level adjusted measured power level

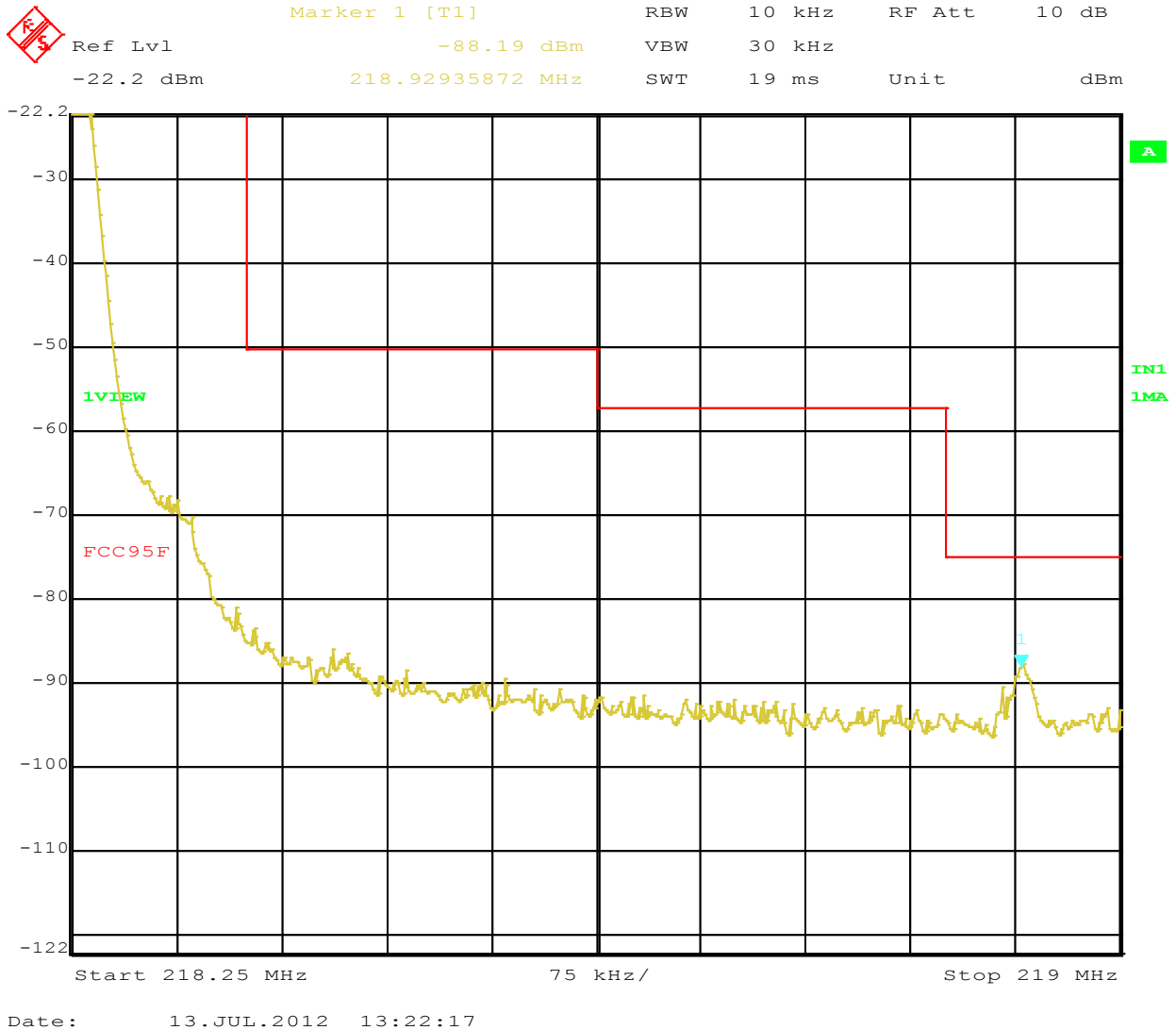

Figure 18: Emission mask Requirement at Operating Channel 218.25 MHz at 16 QPSK

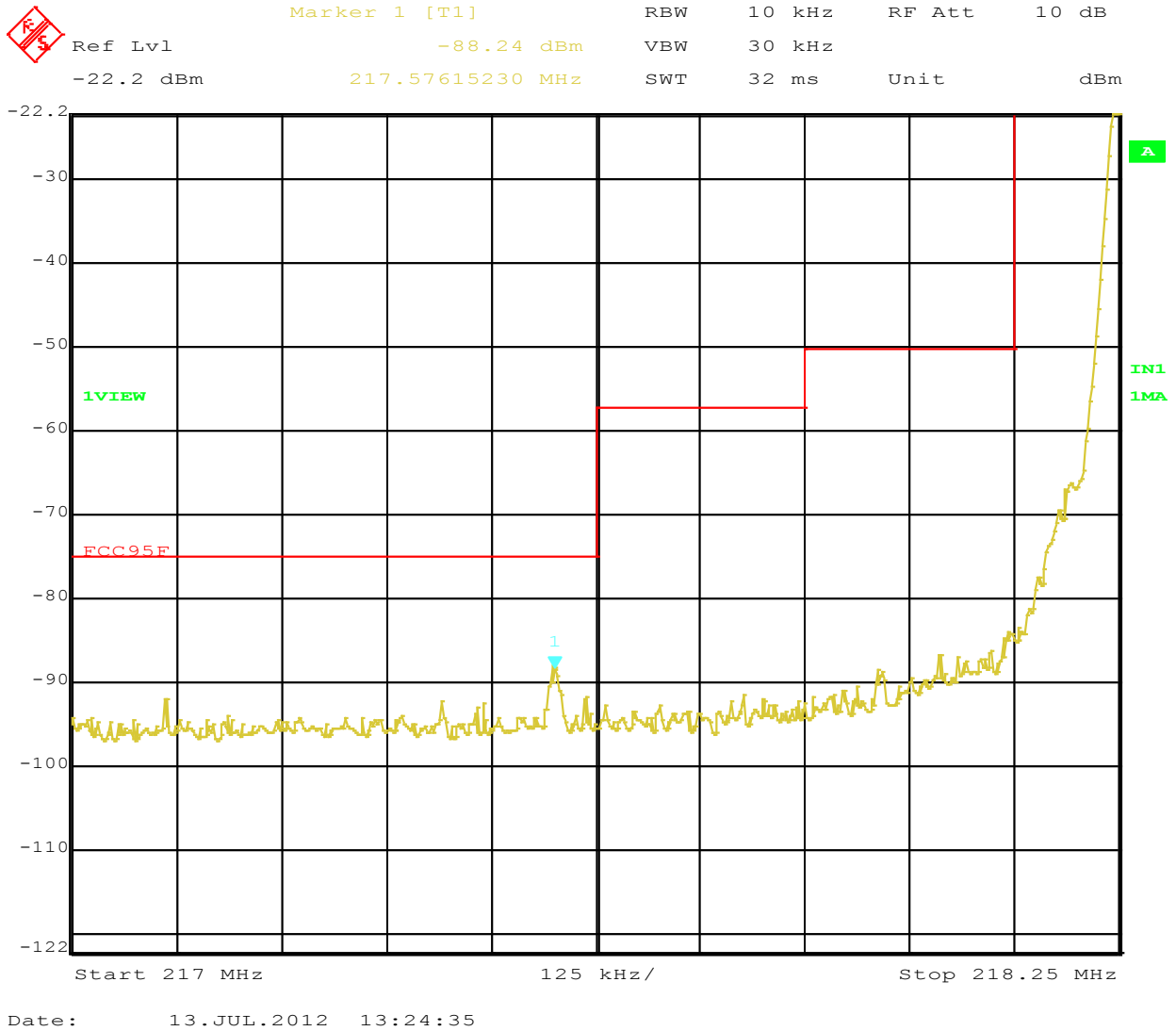
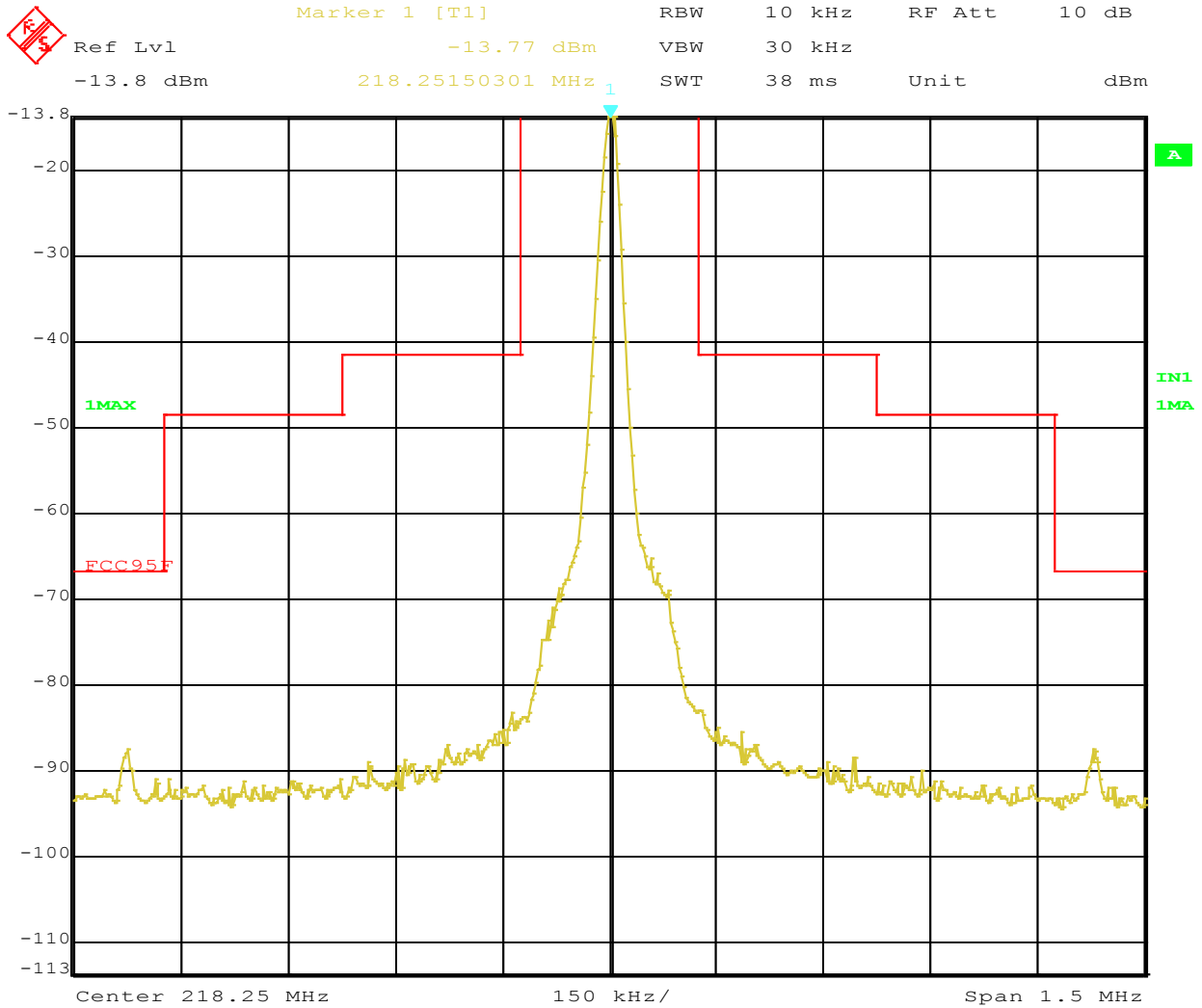

Figure 19: Emission mask Requirement at Operating Channel 218.25 MHz at 16 QPSK



Date: 13.JUL.2012 13:27:21

Figure 20: Emission mask Requirement at Operating Channel 218.25 MHz at 16 QPSK

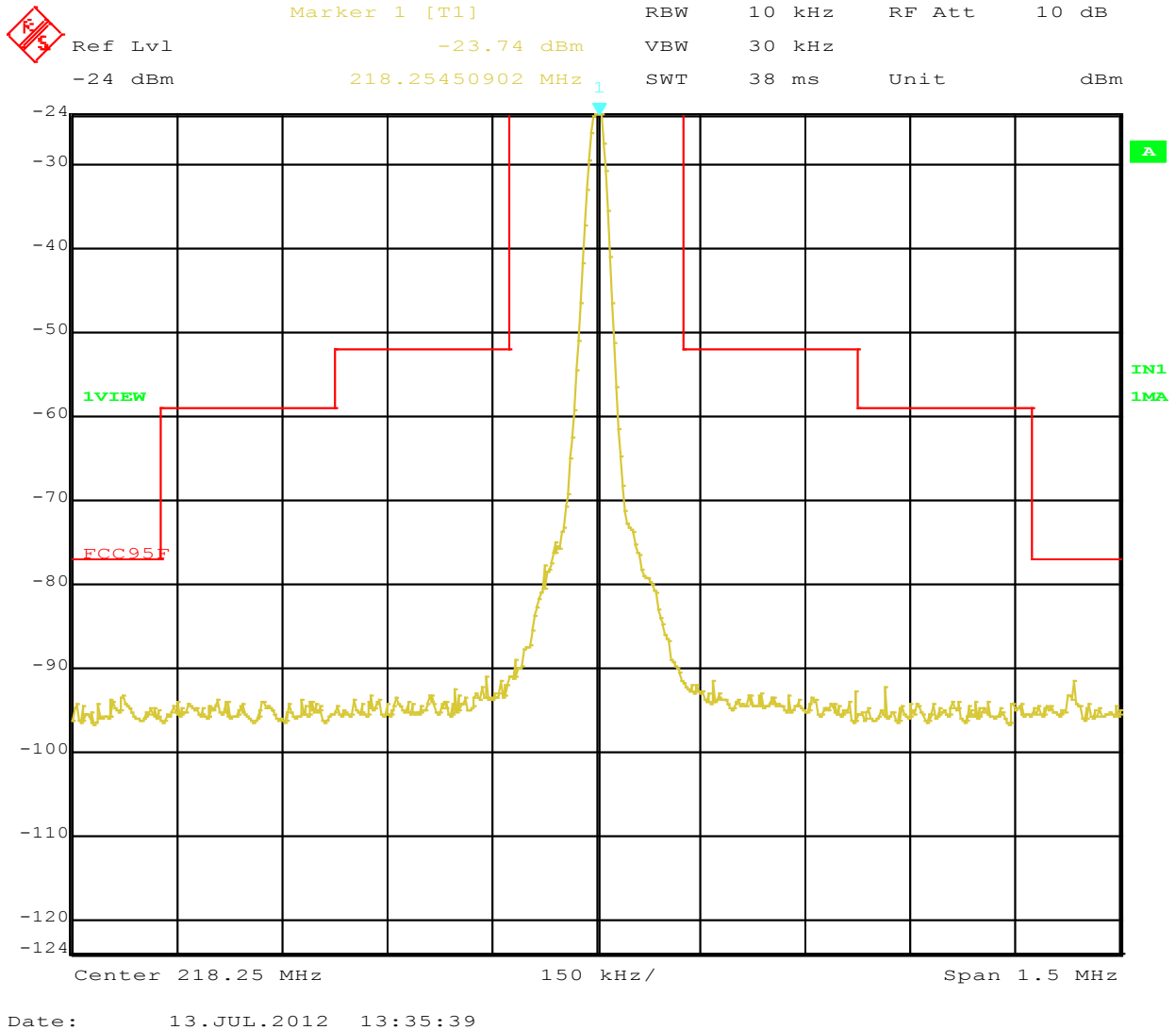

Figure 21: Emission mask Requirement at Operating Channel 218.25 MHz at 32 QPSK

Note: Emask was performed at 218.25 MHz. As same circuitry is employed Emask at 218.75 MHz is identical to the mask at 218.25 MHz

4.4 Conducted Spurious Emissions

Requirements is same as Emission Mask 95.857. Any frequency outside the band of 218 MHz to 219 MHz, the power output level must be below -13 dBm

4.4.1 Test Method

The conducted method was used to measure the channel power output per ANSI/TIA-603-C:2004

The measurements were performed 30 MHz to 2.3 GHz. Preliminary measurements indicated worst case emissions

The worst-case sample result is recorded below.

Test Setup:

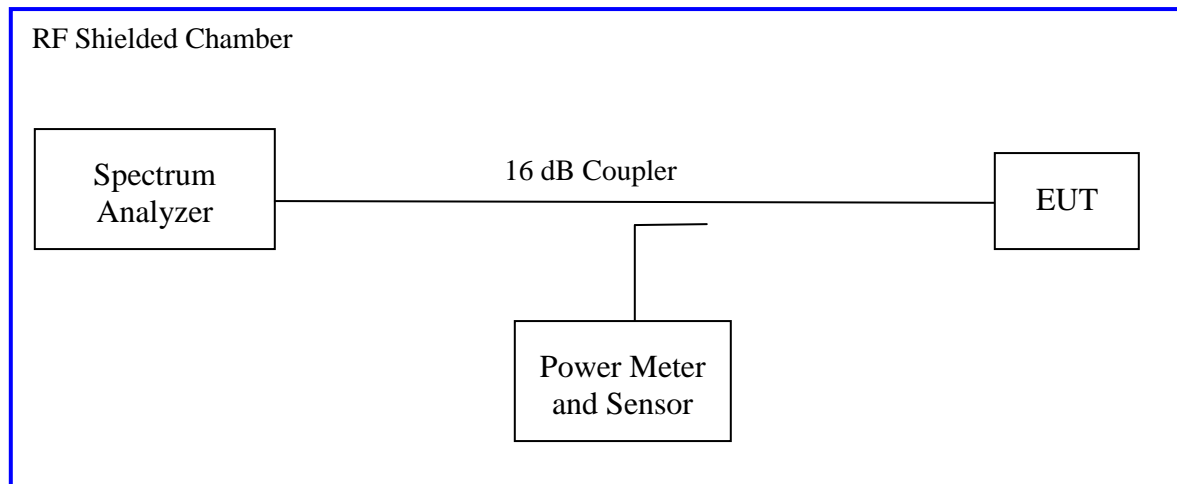

4.4.2 Results

Table 5: Out of band Conducted Emission – Test Results

Operating Freq.	Mode	Result
218.5	GMSK	Pass
	16 QPSK	Pass
	32 QPSK	Pass

Note2: Emission mask 95.857 a (4) is applicable for frequency band 218 to 2219 MHz which gives -13 dBm as limit for out of band emissions but the worst case limit of Mask -13 dBm is applied for all plots.

Note3: No emissions were observed in 1 to 2.3 GHz band in preliminary scan, no final plots were taken with required RBW of 1 MHz.

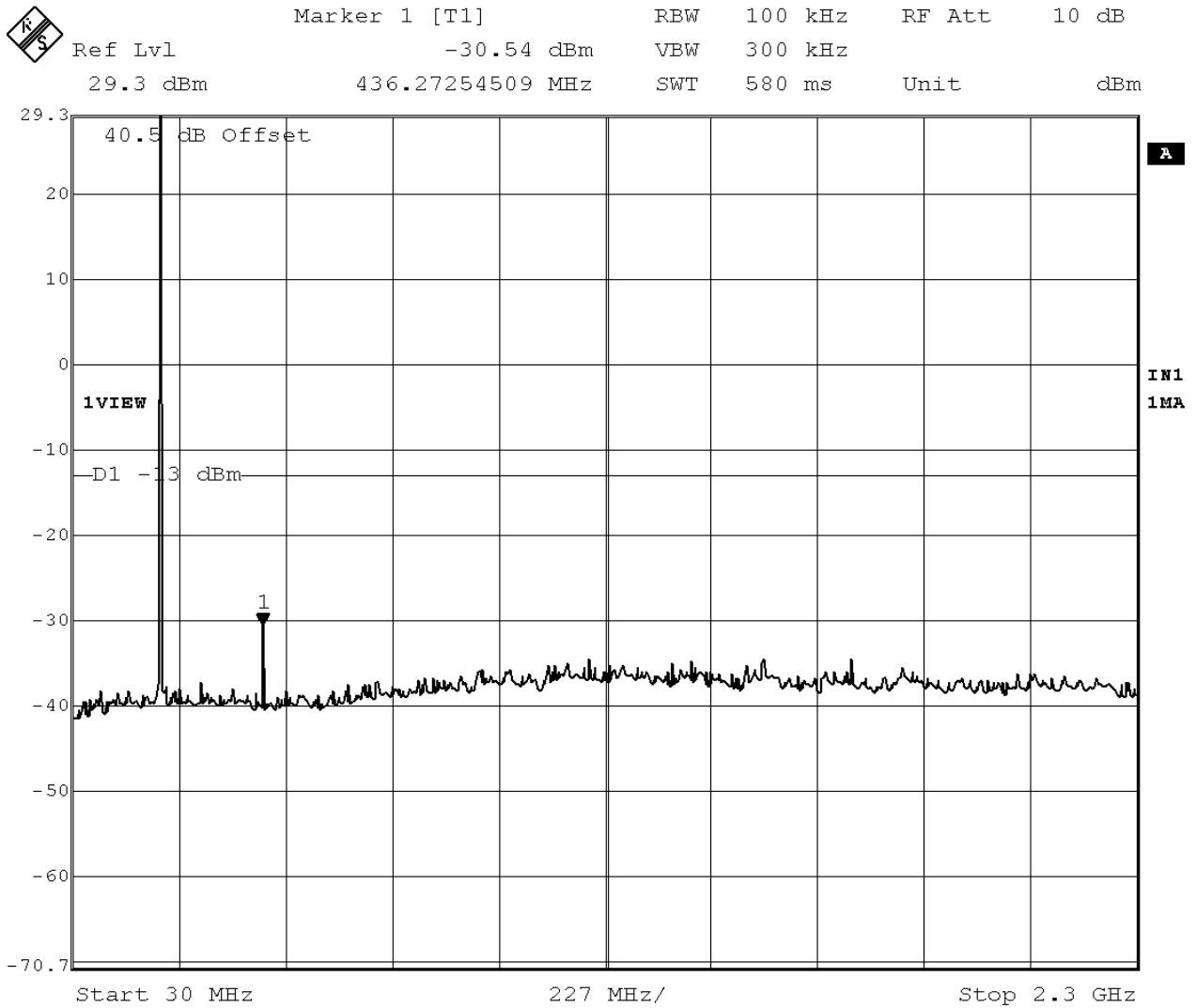

Date: 10.JUL.2012 23:54:19

Figure 22: Out of Band Emissions Operating Channel 218.5 MHz at GMSK

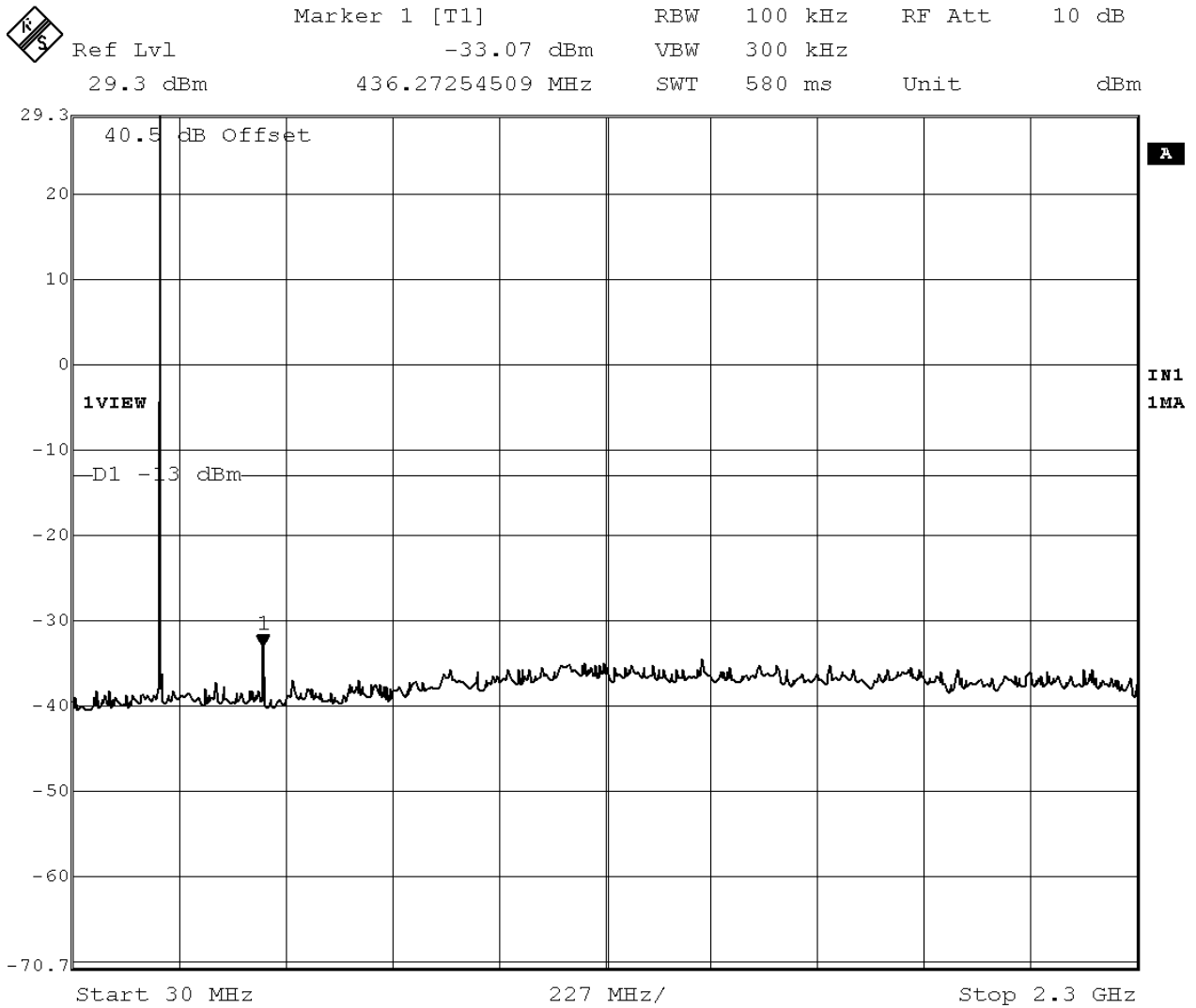

Date: 11.JUL.2012 00:01:13

Figure 23: Out of Band Emissions Operating Channel 218.5 MHz at 16 QPSK

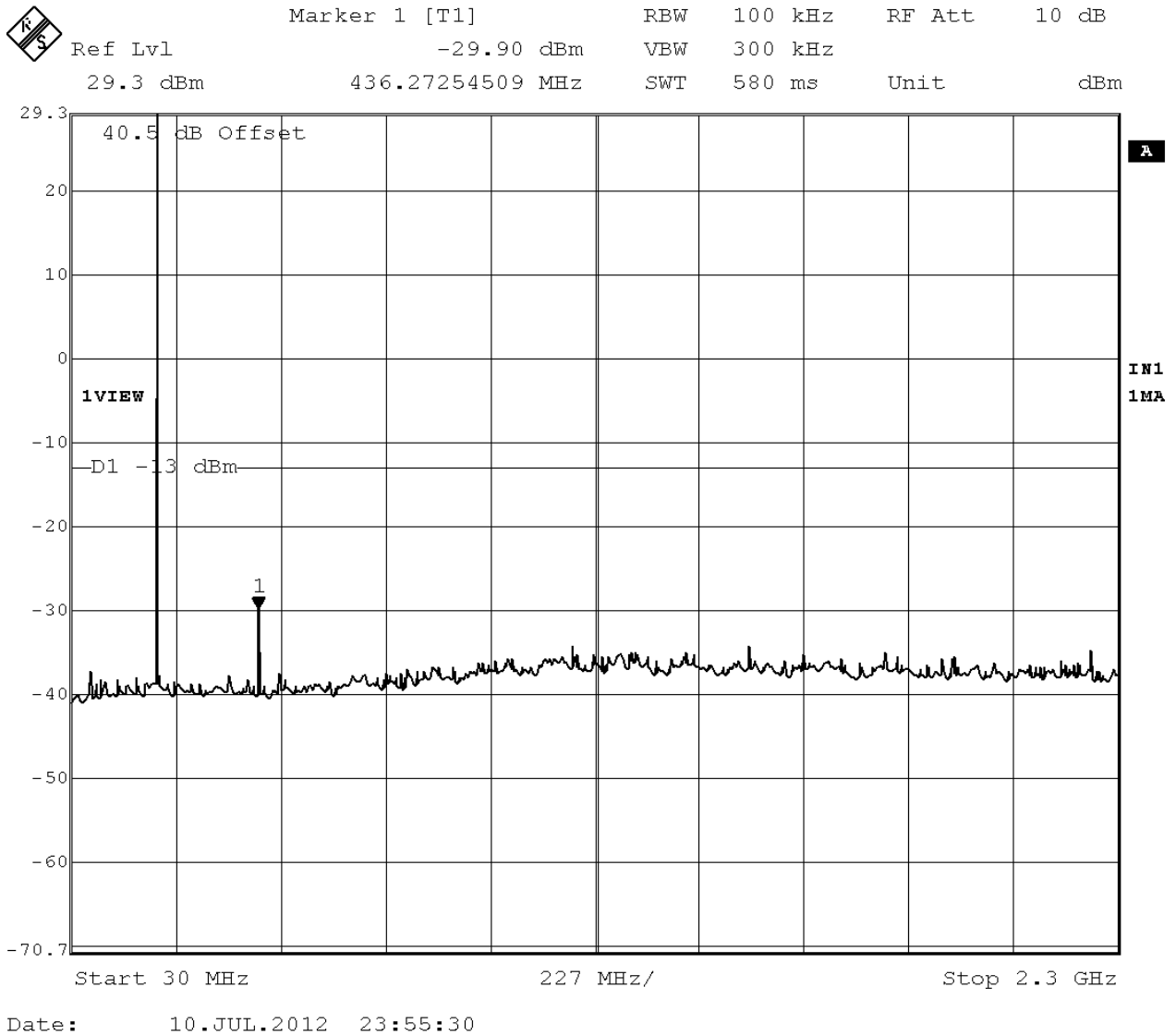

Figure 24: Out of Band Emissions Operating Channel 218.5 MHz at 32 QPSK

4.5 Transmitter Spurious Emissions

Transmitter spurious emissions are emissions outside the frequency range of the equipment when the equipment is in transmit mode; per requirement of CFR47 part 95

4.5.1 Test Methodology

4.5.1.1 Preliminary Test

A test program that controls instrumentation and data logging was used to automate the preliminary RF emission test procedure. The frequency range of interest was divided into sub-ranges to yield a frequency resolution of approximately 120 kHz and provide a reading at each frequency for no more than 12° of turntable rotation. For each frequency sub-range the turntable was rotated 360° while peak emission data was recorded and plotted over the frequency range of interest in horizontal and vertical antenna polarization's.

Preliminary emission profile testing was performed inside the anechoic chamber. The EUT was placed on a 1.0m x 1.5m non-conductive table 80cm above the floor. The EUT was positioned as shown in the setup photographs. The receiving antenna was placed at a distance of 3m at a fixed height of 1m. Measurement equipment was located outside of the chamber. A video camera was placed inside the chamber to view the EUT.

4.5.1.2 Final Test

For each frequency measured, the peak emission was maximized by manipulating the receiving antenna from 1 to 4 meters above the ground plane and placing it at the position that produced the maximum signal strength reading. The turntable was then rotated through 360° while observing the peak signal and placing the EUT at the position that produced maximum radiation. The six highest emissions relative to the limit were measured unless such emissions were more than 20 dB below the limit. If less than six emissions are within 20 dB of the limit, than the noise level of the receiver is measured at frequencies where emissions are expected. Multiples of all oscillator and microprocessor frequencies were also checked.

Final testing was performed on an NSA compliant test site. The EUT was placed on a 1.0m x 1.5m non-conductive table 80cm above the ground plane. The placement of EUT and cables were the same as for preliminary testing and is shown in the setup photographs.

Final

The final scans were performed on the worst axis, for three operating channels. Substitution method was used to obtain final results. Final test were performed on the following channels based on pre-scans

218.5 MHz

4.5.1.3 Deviations

None.

4.5.2 Transmitter Spurious Emission Limit

The spurious emissions of the transmitter shall not exceed the values in CFR47 Part 95

Emission limits are taken from Emission mask 95.857

4.5.3 Test Results

The final measurement data was taken under the worst case operating modes, configurations, and/or cable positions. It also reflects the results including any modifications and/or special accessories listed in Sections 1.4 and Test Plan.

As originally tested, the EUT was found to be compliant to the requirements of the test standard(s).

SOP 1 Radiated Emissions					Tracking # 31260509.003 Page 1 of 4 B					
EUT Name	TransAir PTC-3200				Date	March 7, 2012				
EUT Model	PTC-3001				Temp / Hum in	23°C / 39%rh				
EUT Serial	D1-6				Temp / Hum out	N/A				
EUT Config.	TX ON				Line AC / Freq	12 Vdc				
Standard	CFR47 Part 15 part 95				RBW / VBW	120/300 kHz				
Dist/Ant Used	3m / EMCO3115 / 1m - RA42-K-F-4B-C				Performed by	Suresh Kondapalli				
Frequency Peak	Gen	Cable Loss	Antenna Gain	EIRP	Antenna POL	Table deg	Height cm	Limit dBm	Margin dB	
MHz	dBuV/m	dBm	dB	dbi	dBm	POL	deg	cm	dBm	dB
Transmitted Data 218.5 MHz at GMSK/16 QPSK/32 QPSK										
42.25	57.17	-32.74	0.98	-8.90	-42.62	V	329	100	-13	-29.62
66.75	63.30	-31.28	1.17	-1.02	-33.47	V	213	150	-13	-20.47
121.88	54.50	-42.21	1.51	-2.06	-45.78	H	97	185	-13	-32.78
413.42	47.14	-57.43	2.65	5.90	-54.18	H	324	102	-13	-41.18
423.20	52.36	-52.11	2.68	5.90	-48.88	H	150	102	-13	-35.88
432.00	56.61	-47.91	2.71	6.04	-44.58	H	150	102	-13	-31.58
436.99	74.15	-30.38	2.72	6.14	-26.96	H	139	102	-13	-13.96
441.60	54.85	-49.64	2.73	6.20	-46.17	H	136	102	-13	-33.17
451.40	49.98	-54.37	2.76	6.27	-50.86	H	154	102	-13	-37.86
655.90	50.80	-53.54	3.31	6.35	-50.49	H	224	150	-13	-37.49
874.00	65.20	-38.96	3.88	6.70	-36.15	H	194	102	-13	-23.15
Spec Margin = E-Field QP - Limit, E-Field QP = FIM QP+ Total CF ± Uncertainty										
Total CF= Amp Gain + Cable Loss + ANT Factor										
Combined Standard Uncertainty $u_c(y) = \pm 3.2$ dB Expanded Uncertainty $U = ku_c(y)$ $k = 2$ for 95% confidence										
Notes: EUT is Class A device. Table combines all data rates/modulations. Worst case results are presented here.										

SOP 1 Radiated Emissions

Tracking # 31260509.003 Page 2 of 4
 B

EUT Name	TransAir PTC-3001	Date	March 07, 2012
EUT Model	PTC-3001	Temp / Hum in	23°C / 40%rh
EUT Serial	D1-10	Temp / Hum out	N/A
EUT Config.	TX ON	Line AC	12 Vdc
Standard	CFR47 Part 95	RBW / VBW	120/300 kHz
Dist/Ant Used	3m - EMCO3115 / 1m - RA42-K-F-4B-C	Performed by	Suresh Kondapalli

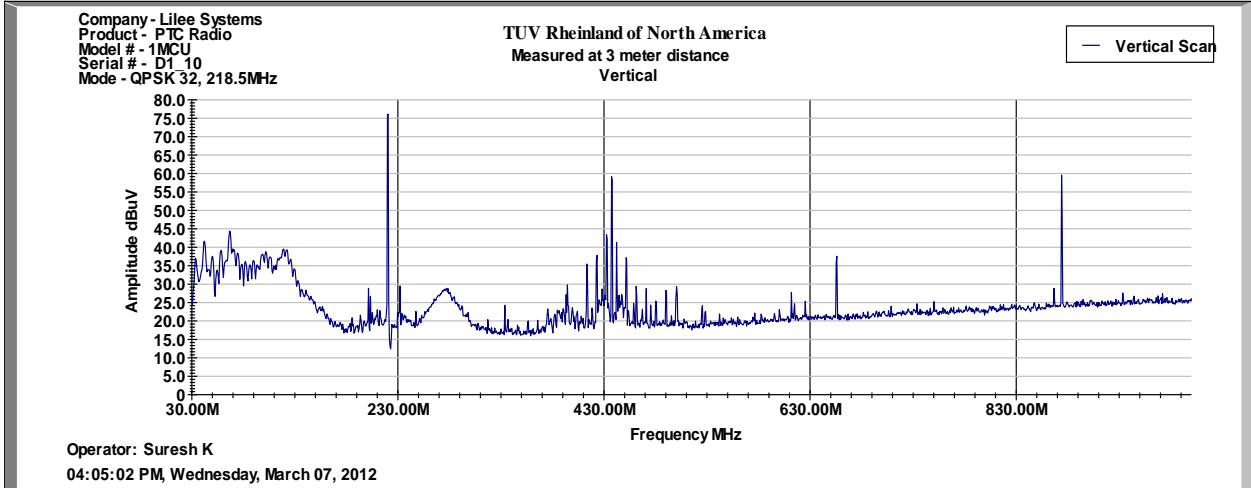
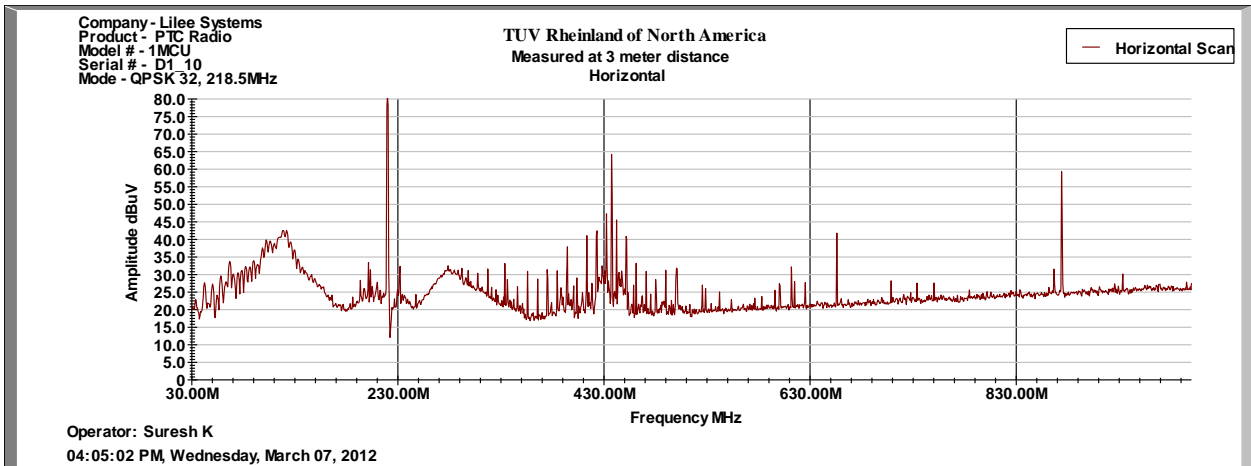

Notes:

SOP 1 Radiated Emissions

Tracking # 31260509.003 Page 3 of 4
 B

EUT Name	TransAir PTC-3001	Date	04/06/2012
EUT Model	PTC-3001	Temp / Hum in	23°C / 39%rh
EUT Serial	D1-6	Temp / Hum out	N/A
EUT Config.	TX ON	Line AC	12 Vdc
Standard	CFR47 Part 15 Part 95	RBW / VBW	120 kHz/300 kHz
Dist/Ant Used	3m - EMCO3115 / 1m - RA42-K-F-4B-C	Performed by	Suresh Kondapalli

1 to 2.5GHz Plot for Transmit Mode: 218.50MHz

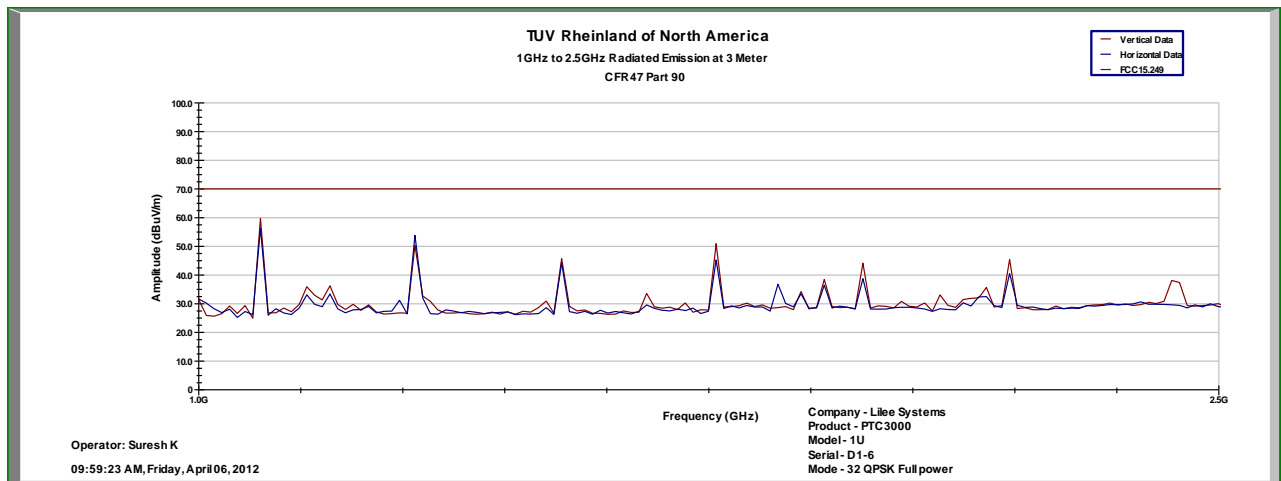

Note: These measurements performed at higher power for part 80 /90 are still applicable

SOP 1 Radiated Emissions					Tracking # 31260509.003 Page 4 of 4 B					
EUT Name	TransAir PTC-3001				Date	04/06/2012				
EUT Model	PTC-3001				Temp / Hum in	23°C / 39%rh				
EUT Serial	D1-6				Temp / Hum out	N/A				
EUT Config.	TX ON				Line AC / Freq	DC 12Volts				
Standard	CFR47 Part 15 Subpart C				RBW / VBW	120 kHz/300 kHz				
Dist/Ant Used	3m / EMCO3115 / 1m - RA42-K-F-4B-C				Performed by	Suresh Kondapalli				
Frequency Peak	Gen	Cable Loss	Antenna Gain	EIRP	Antenna POL	Table deg	Height cm	Limit dBm	Margin dB	
MHz	dBuV/m	dBm	dB	dbi	dBm	POL	deg	cm	dBm	dB
Transmitted Data GMSK/16 QPSK/32 QPSK all Channels combined										
1102.49	41.73	-24.48	1.24	6.76	-54.75	V	17	121	-13.0	-41.75
1466.78	35.21	-23.58	1.34	7.76	-60.57	V	40	111	-13.0	-47.57
1984.48	37.88	-22.69	1.5	8.81	-64.11	H	54	148	-13.0	-51.11
2125.76	35.99	-22.38	1.7	9.32	-59.79	H	35	143	-13.0	-46.79
2666.8	28.94	-22.29	1.7	9.41	-46.85	H	48	143	-13.0	-33.85
2866.52	45.92	-22.39	1.8	9.41	-49.87	H	38	137	-13.0	-36.87

4.5.4 Sample Calculation

The field strength is calculated by subtracting the Amplifier Gain and adding the Cable Loss and Antenna Correction Factor to the measured reading. The basic equation is as follows:

$$\text{Field Strength (dB}\mu\text{V/m)} = \text{FIM} - \text{AMP} + \text{CBL} + \text{ACF}$$

Where: FIM = Field Intensity Meter (dBμV)
 AMP = Amplifier Gain (dB)
 CBL = Cable Loss (dB)
 ACF = Antenna Correction Factor (dB/m)

$$\mu\text{V/m} = 10^{\frac{\text{dB}\mu\text{V} / \text{m}}{20}}$$

4.6 Receiver Spurious Emissions

Receiver spurious emissions are emissions at any frequency when the equipment is in receive mode.

The spurious emissions of the receiver shall not exceed the values in CFR47 Part 15.109 and RSS GEN Sect 6.1.

4.6.1 Test Methodology

4.6.1.1 Preliminary Test

A test program that controls instrumentation and data logging was used to automate the preliminary RF emission test procedure. The frequency range of interest was divided into sub-ranges to yield a frequency resolution of approximately 120 kHz and provide a reading at each frequency for no more than 12° of turntable rotation. For each frequency sub-range the turntable was rotated 360° while peak emission data was recorded and plotted over the frequency range of interest in horizontal and vertical antenna polarization's.

Preliminary emission profile testing was performed inside the anechoic chamber. The EUT was placed on a 1.0m x 1.5m non-conductive table 80cm above the floor. The EUT was positioned as shown in the setup photographs. The receiving antenna was placed at a distance of 3m at a fixed height of 1m. Measurement equipment was located outside of the chamber. A video camera was placed inside the chamber to view the EUT.

4.6.1.2 Final Test

For each frequency measured, the peak emission was maximized by manipulating the receiving antenna from 1 to 4 meters above the ground plane and placing it at the position that produced the maximum signal strength reading. The turntable was then rotated through 360° while observing the peak signal and placing the EUT at the position that produced maximum radiation. The six highest emissions relative to the limit were measured unless such emissions were more than 20 dB below the limit. If less than six emissions are within 20 dB of the limit, than the noise level of the receiver is measured at frequencies where emissions are expected. Multiples of all oscillator and microprocessor frequencies were also checked.

Final testing was performed on an NSA compliant test site. The EUT was placed on a 1.0m x 1.5m non-conductive table 80cm above the ground plane. The placement of EUT and cables were the same as for preliminary testing and is shown in the setup photographs.

4.6.1.3 Deviations

None.

4.6.2 Receiver Spurious Emission Limit

The spurious emissions of the receiver shall not exceed the values in CFR47 Part 80 & 90 and RSS 119.

Frequency (MHz)	Field strength (microvolts/meter)	Measurement distance (meters)
0.009-0.490.....	2400/F (kHz)	300
0.490-1.705.....	24000/F (kHz)	30
1.705-30.0.....	30	30
30-88.....	100 **	3
88-216.....	150 **	3
216-960.....	200 **	3
Above 960.....	500	3

4.6.3 Test Results

The final measurement data indicates the worst case operating modes, configurations, and/or cable positions. It also reflects the results including any modifications and/or special accessories listed in Sections 1.4 and 1.5.

As originally tested, the EUT was found to be compliant to the requirements of the test standard(s).

4.6.3.1 Final Data

The data recorded in this section contains the final results under the worst-case conditions and without any modifications or special accessories implemented as the manufacturer intends.

4.6.4 Conducted spurious emissions in Receive mode

Limits : CFR 47 15.111 -57dBm

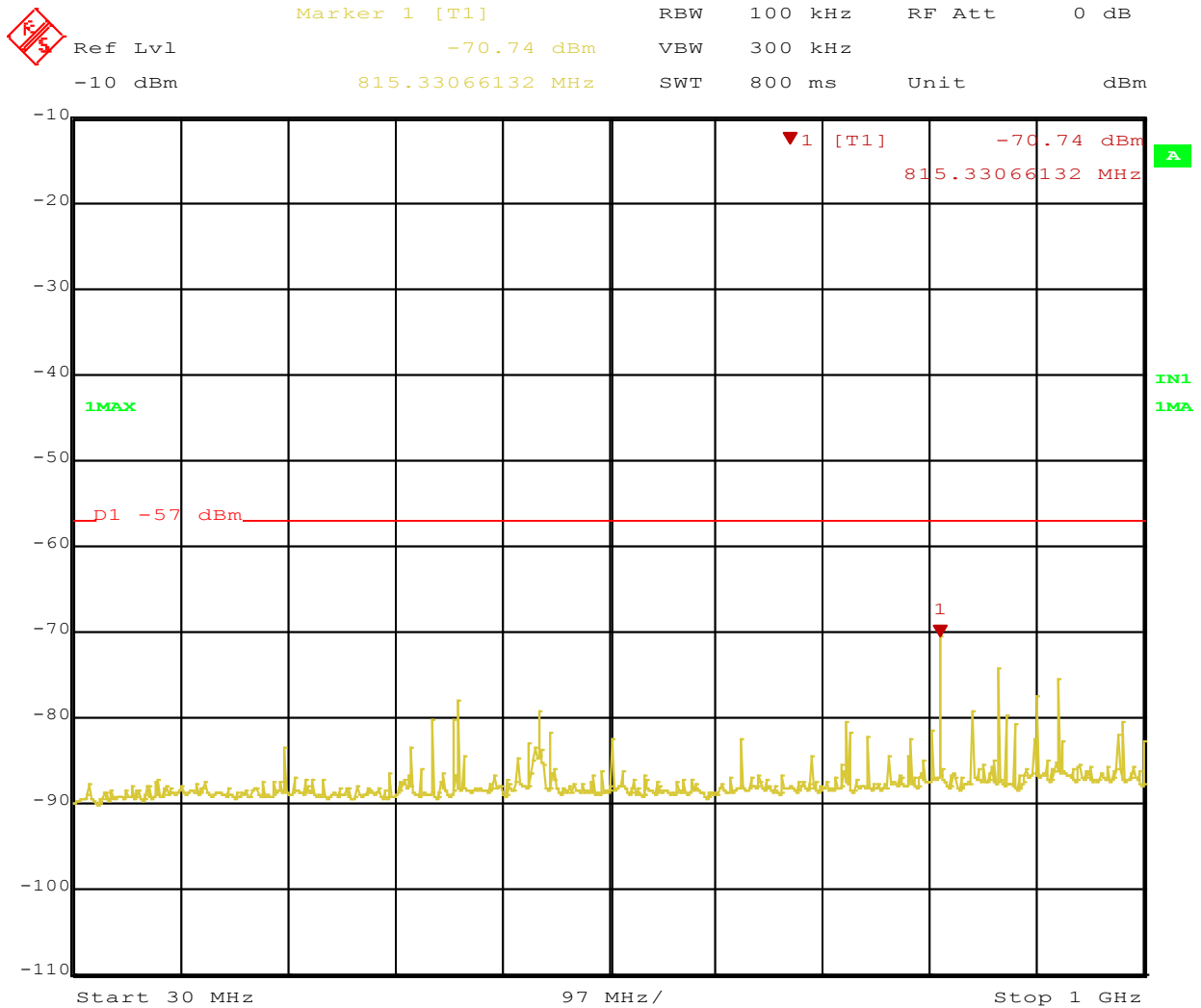

Date: 12.MAR.2012 08:40:26

SOP 1 Radiated Emissions						Tracking # 31260509.003 Page 1 of 3 B					
EUT Name	TransAir PTC-3001					Date	March 07, 2012				
EUT Model	PTC-3001					Temp / Hum in	23°C / 39%rh				
EUT Serial	D1-10					Temp / Hum out	N/A				
EUT Config.	Receive Mode					Line AC / Freq	12 Vdc				
Standard	CFR 47 part 95					RBW / VBW	120/300 kHz				
Dist/Ant Used	3m / EMCO3115 / 1m - RA42-K-F-4B-C					Performed by	Suresh Kondapalli				
Emission Freq	FIM Pk	FIM QP/Avg	Total CF	E-Field QP	Spec Limit	Spec Margin	Table Pos	ANT Pos	ANT Pola	Type	
120.40	50.41	48.67	-11.85	36.82	43.52	-6.70	267	181	H	Spurious	
220.80	53.47	53.40	-13.73	39.67	46.02	-6.35	272	127	H	Spurious	
230.40	52.34	51.03	-12.97	38.06	46.02	-7.96	269	125	H	Spurious	
431.75	24.47	46.10	-8.08	38.02	46.02	-8.00	205	289	H	Spurious	
441.60	49.08	49.12	-8.15	40.97	46.02	-5.05	183	102	H	Spurious	
451.19	49.82	50.04	-8.06	41.98	46.02	-4.04	123	222	H	Spurious	
65.41	58.01	55.19	-18.55	36.64	40.00	-3.36	143	120	V	Spurious	
121.95	45.92	44.25	-11.93	32.32	43.52	-11.20	30	160	V	Spurious	
431.75	23.00	43.06	-8.42	34.64	46.02	-11.38	238	132	V	Spurious	
441.34	23.85	45.83	-8.45	37.38	46.02	-8.64	194	164	V	Spurious	
1000.00	42.36	34.03	-9.25	24.78	54.00	-29.22	224	100	H	Spurious	
1666.71	41.07	40.97	-6.29	34.68	54.00	-19.32	170	114	H	Spurious	
1805.44	41.92	37.33	-4.91	32.42	54.00	-21.58	81	105	H	Spurious	
2125.77	42.05	36.28	-4.38	31.90	54.00	-22.10	12	129	H	Spurious	
Spec Margin = E-Field QP - Limit, E-Field QP = FIM QP+ Total CF ± Uncertainty											
Total CF= Amp Gain + Cable Loss + ANT Factor											
Combined Standard Uncertainty $u_c(y) = \pm 3.2$ dB Expanded Uncertainty $U = ku_c(y)$ $k = 2$ for 95% confidence											
Notes: Note: These measurements were performed at higher power for part 80 /90 are still applicable											
Notes: 1Ghz: RBW=120 kHz,VBW=300 kHz 1GHz – 25 GHz: RBW=1 MHz, VBW=3MHz											

SOP 1 Radiated Emissions

Tracking # 31260509.003 Page 2 of 3
 B

EUT Name	TransAir PTC-3001	Date	March 09, 2012
EUT Model	PTC-3001	Temp / Hum in	22°C / 40%rh
EUT Serial	D1-10	Temp / Hum out	N/A
EUT Config.	EUT on with all antennas and I/O ports active	Line AC / Freq	12 Vdc
Standard	CFR47 Part 15.109, Class A	RBW / VBW	See Note
Dist/Ant Used	3m / JB3 & EMCO3115	Performed by	Suresh Kondapalli

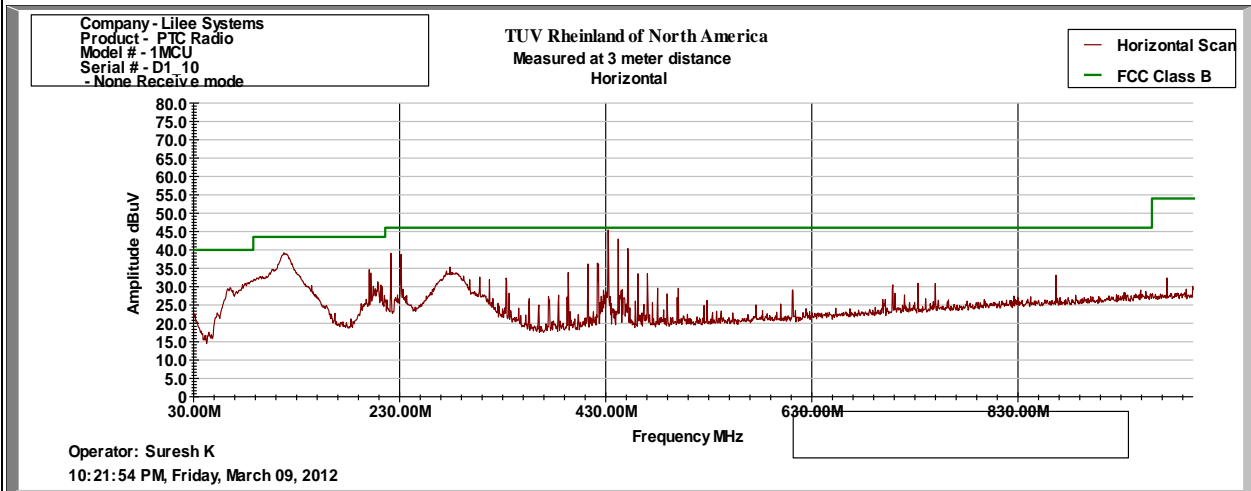
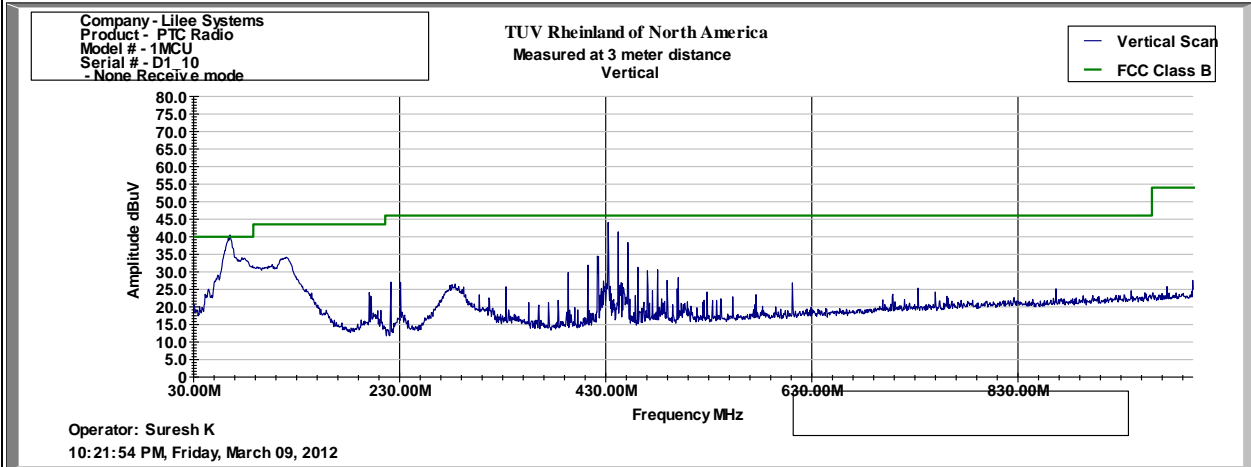

Notes : None

SOP 1 Radiated Emissions

Tracking # 31260509.00 Page 3 of 3
 3B

EUT Name	TransAir PTC-3001	Date	04/06/2012
EUT Model	PTC-3001	Temp / Hum in	22°C / 40%rh
EUT Serial	1	Temp / Hum out	N/A
EUT Config.	Receive Mode	Line AC	12 Vdc
Standard	CFR 47 part 90	RBW / VBW	1 MHz/3MHz
Dist/Ant Used	3m / JB3	Performed by	Suresh Kondapali

Above 1GHz Plot for Receive Mode

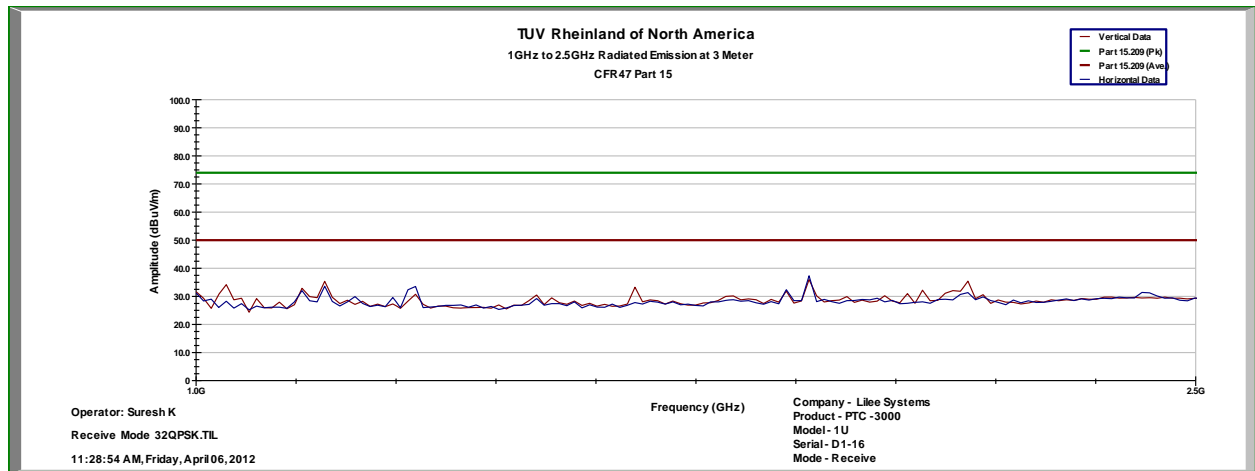

4.6.5 Sample Calculation

The field strength is calculated by subtracting the Amplifier Gain and adding the Cable Loss and Antenna Correction Factor to the measured reading. The basic equation is as follows:

$$\text{Field Strength (dB}\mu\text{V/m)} = \text{FIM} - \text{AMP} + \text{CBL} + \text{ACF}$$

- Where:
- FIM = Field Intensity Meter (dB μ V)
 - AMP = Amplifier Gain (dB)
 - CBL = Cable Loss (dB)
 - ACF = Antenna Correction Factor (dB/m)

$$\mu\text{V/m} = 10^{\frac{\text{dB}\mu\text{V} / \text{m}}{20}}$$

4.7 Test Setup Photos





5 Test Equipment Use List

5.1 Equipment List

Equipment	Manufacturer	Model #	Serial/Inst #	Last Cal mm/dd/yy	Next Cal mm/dd/yy
Bilog Antenna	Sunol Sciences	JB3	A102606	5/19/2012	5/19/2013
Horn Antenna	Sunol Sciences	DRH-118	A040806	9/29/2010	9/29/2012
Antenna (18-26GHz)	CMT	RA42-K-F-4B-C	020131-004	1/17/2012	1/17/2013
Antenna (26-40GHz)	CMT	RA28-K-F-4B-C	011469R-003	1/17/2012	1/17/2013
EMI Receiver	Hewlett Packard	8546A	3807A00445	1/17/2012	1/17/2013
Preselector	Hewlett Packard	85460A	3704A00407	1/17/2012	1/17/2013
Amplifier	Hewlett Packard	8447D	2944A07996	1/16/2012	1/16/2013
Spectrum Analyzer	Rohde & Schwarz	ESIB	832427/002	1/17/2012	1/17/2013
Amplifier	Rohde & Schwarz	TS-PR18	3545.7008.03	9/29/2010	9/29/2012
Amplifier	Rohde & Schwarz	TS-PR26	100011	1/16/2012	1/16/2013
Amplifier	Rohde & Schwarz	TS-PR40	100012	1/16/2012	1/16/2013
Signal Generator	Anritsu	MG3694A	42803	1/17/2012	1/17/2013
Notch Filter	Micro-Tronics	BRM50702	37	1/17/2012	1/17/2013
Notch Filter	Micro-Tronics	BRC50705	9	1/17/2012	1/17/2013
High Pass Filter (3.5 GHz)	Hewlett Packard	84300-80038	820004	1/17/2012	1/17/2013
High Pass Filter (8.5 GHz)	Micro-Tronics	HPM50107	4	1/17/2012	1/17/2013
Notch Filter	Telonic Berkely, Inc	TTR190-3EE	50033-2	VB	VB
Power Supplier	Kikosui	PCR8000W	CM000912	1/19/2012	1/19/2013
Digital Multimeter	Fluke	177	92780314	1/18/2012	1/18/2013
Power Meter	Agilent	E4418B	MY45103902	1/19/2012	1/19/2013
Power Sensor	Hewlett Packard	8482A	55-5131	1/19/2012	1/19/2013
Spectrum Analyzer	Agilent	E4407B	SG43330468	10/05/2011	10/05/2012

VB: Verify before use

6 EMC Test Plan

6.1 EMC Test Plan

6.1.1 Introduction

This section provides a description of the Equipment Under Test (EUT), configurations, operating conditions, and performance acceptance criteria. It is an overview of information provided by the manufacturer so that the test laboratory may perform the requested testing.

6.1.2 Customer

Table 6: Customer Information

Company Name	Lilee Systems, Ltd
Address	2905 Stender Way, Suite 78
City, State, Zip	Santa Clara, CA 95054
Country	U.S.A.
Phone	(408) 988-8672
Fax	(408) 988-8813

Table 7: Technical Contact Information

Name	Hamid Movahedi
E-mail	hmovahedi@lileesystems.com
Phone	(408) 898-8672
Fax	(408) 988-8813

6.1.3 Equipment Under Test (EUT)

Table 8: EUT Specifications

EUT Specification	
Dimensions	Lenth: 42cm Width: 29cm (w). Height: 6cm
Power	Input Voltage: 10 to 24 Vdc Input Current: 12 A
Environment	Mobile/Fixed
Operating Temperature Range:	-40 to +70 degrees C
Multiple Feeds	<input type="checkbox"/> Yes and how many <input checked="" type="checkbox"/> No
Hardware Version	D
Part Number	None
RF Software Version	None
Radio	
Operating Mode	Base station, Waystation and mobile
Transmitter Frequency Band	216 to 222 MHz This report covers FCC CFR 47 part 95F, 218 to 219 MHz band only
Max. Rated Power Output	See Channel Planning Table.
Power Setting @ Operating Channel	Power setting is from Att 31 = 20 dBm to ATT 0= 45.8 dBm See Channel Planning Table. Transmission at 218.5 MHz shall be limited to 1watt for mobile and 4 watts for Base Station.
Antenna Type	Lilee systems TransAir 220MHz 3dBi Max gain 2.97dBi for part 95F Operation
Modulation Type	<input type="checkbox"/> AM <input type="checkbox"/> FM <input type="checkbox"/> DSSS <input type="checkbox"/> OFDM <input checked="" type="checkbox"/> Other describe: GMSK, $\Pi/4$ QPSK, QPSK, OQPSK, BPSK, SOQPSK, & DQPSK,
Data Rate	9600BPS, 16KBPS, 32KBPS
TX/RX Chain (s)	2 (Primary and standby only one active at a time)
Directional Gain Type	<input checked="" type="checkbox"/> Uncorrelated <input checked="" type="checkbox"/> No Beam-Forming <input type="checkbox"/> Other describe:
Type of Equipment	<input type="checkbox"/> Table Top <input type="checkbox"/> Wall-mount <input type="checkbox"/> Floor standing cabinet <input checked="" type="checkbox"/> Other Fixed and mobile modes, used in Locomotive, Wayside Station, Fixed mounted/ Base station

Table 9: EUT Channel Power Specifications

Frequency (MHz)	Power Set Value
	See Table 2

EUT channels available;

PTC-3001 uses 216 to 222MHz band as follows

This report covers only CFR 47 part 95F, 218 to 219 MHz band. No specific channels are assigned for CFR 47 part 95F.

PTC-3000 operates in both segments of the the band Segment A: 218.0- 218.5 MHz and Segment B: 218.5 to 219 MHz. The test was performed on first and last channels.

Table 10: Interface Specifications:

Description of various models:

Power Output through custom connector, SPI and control signals

Table 11: Supported Equipment :

None

Table 12: Description of Sample used for Testing

Device	Serial	RF Connection	CFR47 Part 95
PTC-3001 Transmitter	PTC transmitter card 556D904D04G21000 005M0LB S/n #D1-6 & 1	N- Female terminated with Load	TX Emission, RX Emission,
		N-Female Connected directly to Spectrum analyzer through short coax cable and Calibrated 30 dB pad	RF Power Output, Out of Band Emission, Emission mask, Occupied Bandwidth Frequency Stability

Table 13: Description of Test Configuration used for Radiated Measurement.

Device	Antenna	Mode	
PTC-3001 Transmitter	Dummy Load	* Transmit * Receive	EUT is normally rack mounted/used on table top. EUT was evaluated as table top equipment
EUT #: S/N D1-6, D1-7			

6.1.4 Test Specifications

Testing requirements

Table 14: Test Specifications

Emissions and Immunity	
Standard	Requirement
CFR 47 Part 95F	All

END OF REPORT