



**BUREAU
VERITAS**

FCC Registration Number: DE0023

ECL-EMC Test Report No.: 20-146

Equipment under test: WSC-2

Type of test: FCC 47 CFR Part 15 Subpart B

Measurement Procedures: ANSI C63.4 (2014)

Test result: Passed

Date of issue:	17.12.2020		Signature:
Issue-No.:	01	Author:	
Date of delivery:	15.12.2020		
Test dates:	16.12. - 17.12.2020	reviewed:	



BNetzA-CAB-19/21-20



Deutsche
Akkreditierungsstelle
D-PL-12024-06-04



Client: ANDREW Wireless Systems GmbH

Industriering 10
D-86675 Buchdorf
Germany

Test house: Bureau Veritas Consumer Products Services
Germany GmbH
Thurn-und-Taxis-Straße 18
D-90411 Nürnberg
Tel.: +49 40 74041 0
Fax: +49 40 74041-2755

Versions management

V 01.00 ---

General:

The purpose of the performed inspections and tests was to demonstrate that equipment under defined environmental conditions can survive without irreversible failures and perform according to requirements. This report informs about the results of the EMC tests, it only refers to the equipment under test. No part of this report may be reproduced in any form, without written permission.



Table of contents

1	INTRODUCTION.....	4
1.1	PURPOSE.....	4
1.2	SUMMARY	4
2	EQUIPMENT UNDER TEST	5
2.1	EUT DESIGNATION	5
2.2	DESCRIPTION	5
2.3	CONFIGURATION.....	6
2.4	CONNECTIONS.....	7
2.5	FREQUENCIES	7
2.6	GROUNDING.....	7
2.7	OPERATION STATE.....	8
2.8	USED SOFTWARE.....	8
3	DESCRIPTION OF EMC TEST CENTER.....	9
3.1	MEASUREMENT UNCERTAINTY	9
3.2	CLIMATIC TEST CONDITIONS DURING MEASUREMENTS.....	9
3.3	DECISION OF CONFORMITY	9
4	MEASUREMENT OF EMISSION.....	10
4.1	CONDUCTED EMISSION FROM THE POWER PORT	10
4.2	ELECTRIC FIELD RADIATED EMISSION IN THE FREQUENCY RANGE 30 MHz - 1 GHz.....	14
4.3	RADIATED EMISSION FROM THE ENCLOSURE IN THE FREQUENCY RANGE ABOVE 1 GHz.....	20
	ANNEX A: ACCREDITATION CERTIFICATE (FOR INFORMATION)	25



1 Introduction

1.1 Purpose

This report documents the qualification testing for the WSC-2 system to FCC 47CFR Part 15 Subpart B Class B. The system is referred to as the EUT from here on for the purpose of this report. All emission testing was performed per ANSI C63.4 (methods of measurement of radio-noise emissions from low-voltage electrical and electronic equipment in the range of 9 kHz to 40 GHz).

1.2 Summary

The EUT met the emission requirement per FCC 47CFR part 15 Subpart B for class B.

Emission	Regulation	Test result	Compliance	
			Yes	No
Conducted emission; power supply lines (150 kHz - 30 MHz)	15.107	The radiated emissions were met with a minimum 3.3 dB margin below the specified limits.	X	
Radiated emission (30 MHz - 1 GHz)	15.109	The radiated emissions were met with a minimum 12.7 dB margin below the specified limits.	X	
Radiated emission (1 GHz – 3.223 GHz)	15.109	The radiated 10.1 dB margin below the specified limits.	X	

2 Equipment under test

2.1 EUT designation

EUT: WCS2 PN 7844067-00 Rev 00
 S/N US233720-02

2.2 Description

The WCS is the head-end hardware platform for ERA/ION-E. It is available in height unit variants of 2U and 4U. The original WCS design required two DC power inputs from an external PSU. One 12Vdc input for powering the WCS chassis and plug-in cards and a second 57Vdc input for powering isolated PoE remotes connected to the system.

The purpose of this project is to provide a new chassis power configuration that will support a -48Vdc direct power input in place of the original 12Vdc input. This will be accomplished by adding a new DC-DC power conversion stage inside the WCS chassis that utilizes the existing internal WCS chassis airflow to cool it. The WCS chassis will also need to incorporate a new rear panel and duct plate to accommodate this power converter board. The -48Vdc input will be the new source of power for the original 12Vdc circuits residing inside the WCS and on the plug-in cards. No 57Vdc input is planned for supporting the isolated PoE remotes of the ION-E system. As a result of not having the 57Vdc isolated input, this chassis will not provide full CAT card support.

Mechanically, this project includes a new rear panel, airflow duct, and interior connector shields in the WCS chassis. Electrically, the project will include two new DC-DC power conversion PCBA's and two new BOM revisions of the existing DSP board assembly to support these changes. One each for the 4U and the 2U WCS chassis respectively. PMBus/I2C communications will be supported internally using a cable between the existing DSP board interface and the power conversion PCBA. This bus will provide PSU alarming and power metrics to the ERA/ION-E system software.

The WCS chassis regulatory compliance levels will be maintained from the original design except for safety compliance which will now also include IEC/EN/UL 62368-1 requirements. This design will not support N+1 redundancy. No design provisioning is being planned to support an AC input variant of the power conversion PCBA at this time. The WCS4 and WCS2 will have different power conversion PCBA's with a higher power solution provided in the WCS4 chassis. The existing WCS DSP board will be reused in two different BOM variants to support the WCS4 and WCS2 respectively.

2.3 Configuration



Front View of WCS-2



Back View of WCS-2

2.4 Connections

1. WCS2. PN 7844067-00 Rev 00. SN US233720-02
2. 2 RFD. PN 7633229-02.
3. 2 OPT. PN 7642123-00.
4. 1 SUI. PN 76421250-00.

2.5 Frequencies

Maximum internal frequency:

Gb Transceiver Clock: 644.53125 MHz

2.6 Grounding



The DUT was connected to ground during the test (via earth strap).

EMC Test Report No.: 20-146

FCC Registration Number: DE0023



BUREAU
VERITAS

2.7 Operation state

Idle Mode: EUT powered up, no signal input

2.8 Used software

Version: 2.8.2.46



3 Description of EMC test center

3.1 Measurement Uncertainty

The table below shows the measurement uncertainties for each measurement method. The expanded uncertainty was calculated with worst case values over the complete frequency area.

Measurement method	Frequency area impulse duration time	Description	expanded Uncertainty (95% or k=2)	U _{CISPR}
Radiated emission (EN 55022; ANSI C63.4 etc.)	30 MHz - 1 GHz	Semi anechoic chamber	± 4,7 dB	± 6,3 dB
	1 GHz – 6/18 GHz	Fully/Semi anechoic chamber	± 4,4 dB/ ± 4,4 dB	± 5,2 dB/ ± 5,5 dB
Conducted emission (EN 55022; ANSI C63.4 etc.)	9 kHz - 150 kHz	Semi anechoic chamber	± 3,5 dB	± 3,8 dB
	150 kHz - 30 MHz		± 3,1 dB	± 3,4 dB

3.2 Climatic test conditions during measurements

ambient temperature: 15 - 35 °C
 relative humidity: 30 - 60 %
 air pressure: 860 - 1060 hPa

3.3 Decision of conformity

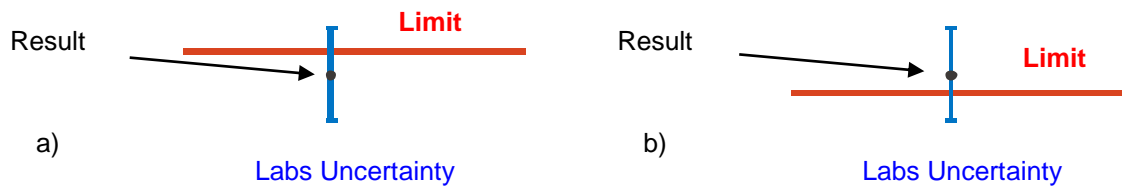

Pass	Fail
-------------	-------------

The Uncertainty of the test lab is:

$$U_{Labor} < U_{CISPR}$$

Therefore the limits can be taken as they are defined in the standards. No additional margin to the limit is necessary.

Taking into account the measurement uncertainty of the laboratory it is possible, that foreign lab results can differ.

- a) The probability for a “Pass” is higher.
- b) The probability for a “Fail” is higher.



4 Measurement of emission

4.1 Conducted emission from the power port

Set-up and test method:

Frequency range	power-line voltages and frequencies	Line	Limit	Test method
150 kHz - 30 MHz	120 V / 60 Hz	AC power supply line	15.107 Class B	ANSI C63.4:2014

Test equipment used:

Designation	Type	Manufacturer	Frequency range	Cal. date	Next Cal.	Inventory no.	used
EMI test receiver	ESU40	R & S	10 Hz - 40 GHz	15.10.19	31.12.20	E2025	X
Transient Limiter	ESH3-Z2	R & S	9 kHz - 30 MHz	19.12.19	19.12.21	K877	X
LISN (2x10 A)	ESH3-Z5	R & S	9 kHz - 30 MHz	09.10.18	31.12.20	K 679	X
software	BAT-EMC	Nexio	V3.20.0.10	-	-	-	X

Note: No AC/DC-power supply is provided by customer. Therefore a standard common laboratory power supply provided by BV was used.

Test location: SAC
 Test engineer: Reusch
 Date: 17.12.2020

Test results:

Frequency range	Operation Mode	Mains	Line	Detector	Measurement report
150 kHz - 30 MHz	Idle Mode	120 V / 60 Hz	N	PK / AV	1
			L	PK / AV	2

The EUT fulfilled the required limits.



- FCC/FCC 15.107 B - Avg/
- FCC/FCC 15.107 B - Q-Peak/
- Peak (Neutral)
- Avg (Neutral)
- ◇ Peak (Peak/Lim.Q-Peak) (Neutral)
- ◇ Avg (Avg/Lim.Avg) (Neutral)
- ◇ QP (Neutral) (Neutral)
- ◇ AVG (Neutral) (Neutral)

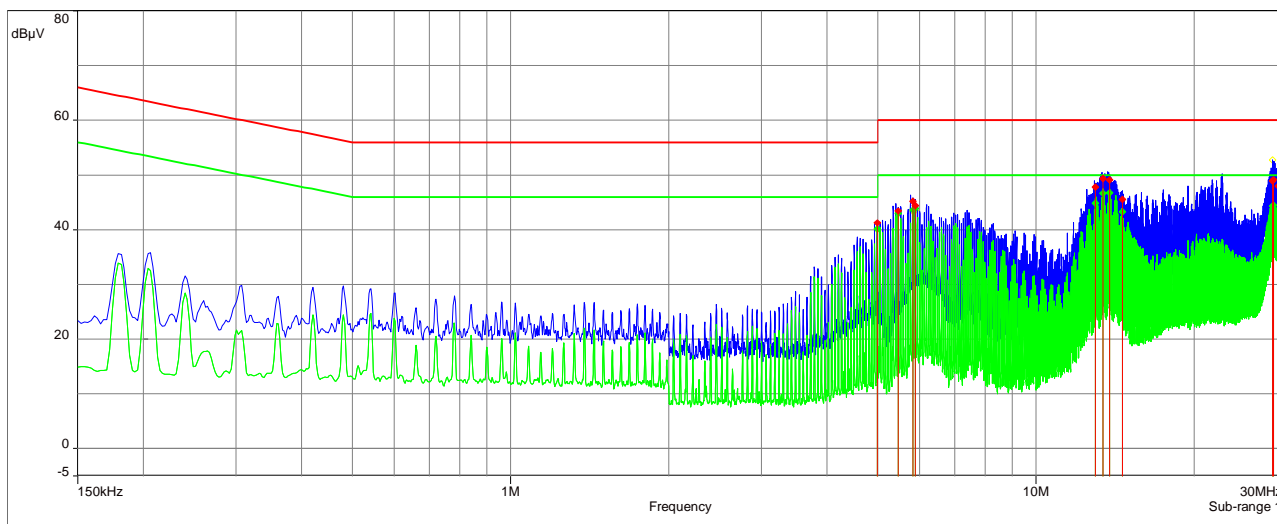

Frequency (MHz)	QP (dBµV)	Limit QP (dBµV)	Margin QP(dB)	AVG (dBµV)	Limit AVG (dBµV)	Margin AVG (dB)
4.98525	41.31	56.00	14.69	40.18	46.00	5.82
5.4645	43.45	60.00	16.55	43.00	50.00	7.00
5.82675	45.17	60.00	14.83	43.64	50.00	6.36
5.88525	44.44	60.00	15.56	43.85	50.00	6.15
12.97275	47.81	60.00	12.19	44.88	50.00	5.12
13.3935	49.32	60.00	10.68	46.67	50.00	3.33
13.81425	49.11	60.00	10.89	46.74	50.00	3.26
14.595	45.55	60.00	14.45	43.29	50.00	6.71
28.16925	48.96	60.00	11.04	44.34	50.00	5.66
28.2885	49.20	60.00	10.80	44.54	50.00	5.46
28.88925	48.00	60.00	12.00	43.37	50.00	6.63

Measurement report 1.



- FCC/FCC 15.107 B - Avg/
- FCC/FCC 15.107 B - Q-Peak/
- Peak (Phase 1)
- Avg (Phase 1)
- Peak (Peak/Lim.Q-Peak) (Phase 1)
- Avg (Avg/Lim.Avg) (Phase 1)
- ↓ QP (Phase1) (Phase 1)
- ↓ AVG (Phase1) (Phase 1)

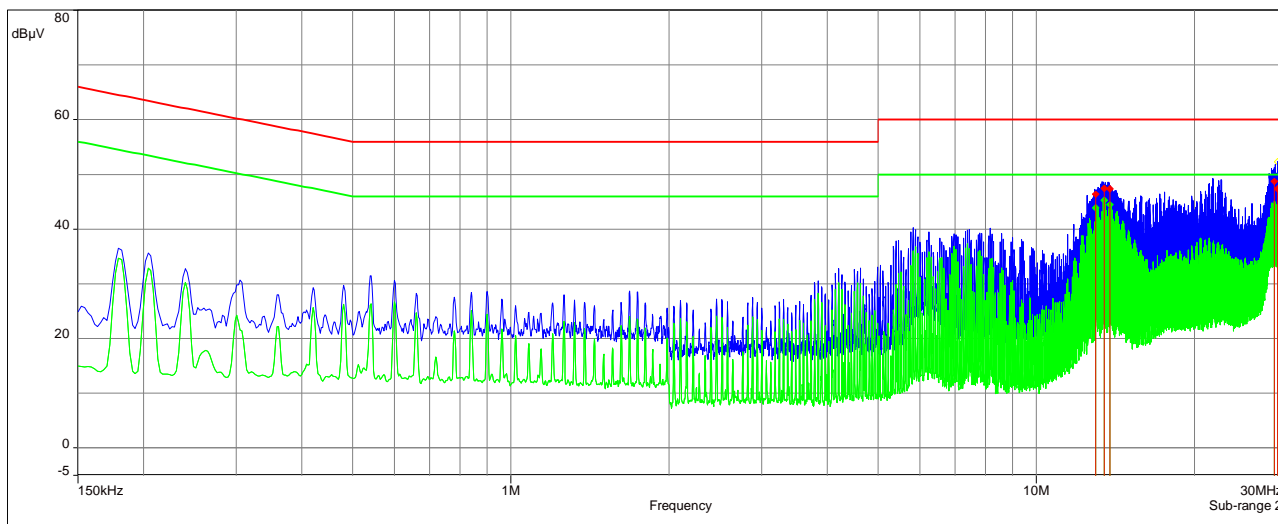

Frequency (MHz)	QP (dBµV)	Limit QP (dBµV)	Margin QP(dB)	AVG (dBµV)	Limit AVG (dBµV)	Margin AVG (dB)
12.97275	46.42	60.00	13.58	43.87	50.00	6.13
13.45425	47.47	60.00	12.53	45.31	50.00	4.69
13.81425	47.32	60.00	12.68	44.53	50.00	5.47
28.34925	48.71	60.00	11.29	44.23	50.00	5.77
28.77225	47.36	60.00	12.64	41.99	50.00	8.01
29.78925	46.85	60.00	13.15	41.58	50.00	8.42

Measurement report 2.



Basic set-up

The measurements were made in the operating mode, with the EUT producing the maximum emission, consistent with normal applications. The EUT load was adjusted within the range specified by manufacturer in order to maximize the emission.

The DC power supplied EUT was connected to a standard laboratory power supply, which was connected to the LISN.

For this test, the EUT was placed at a distance of 80 cm from the LISN.

The 50 Ω measuring port is terminated into a 50 Ω EMI receiver and all other ports are terminated into 50 Ω loads.

Details are as indicated below:

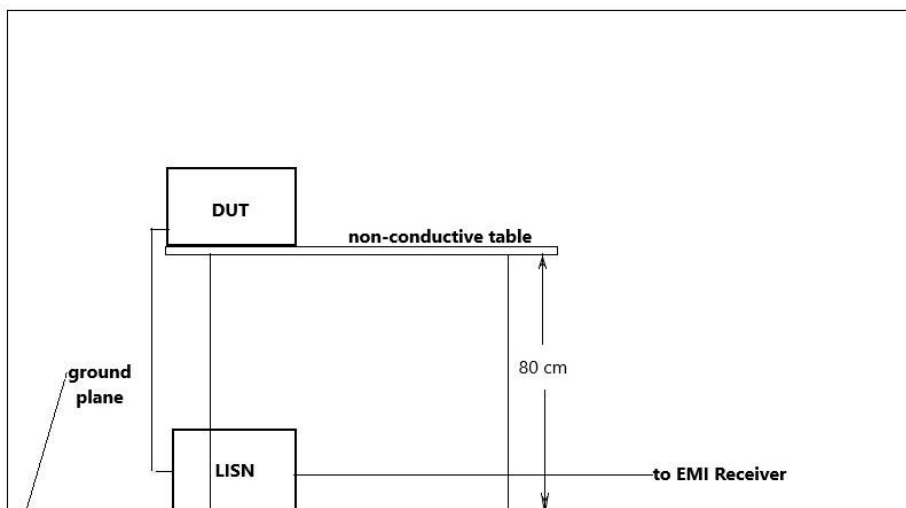



4.2 Electric field radiated emission in the frequency range 30 MHz - 1 GHz

Set-up and test method:

Frequency range	Measurement distance	Limit	Test method
30 MHz - 1 GHz	10 m	15.109 Class B	ANSI C63.4:2014

Test equipment used:

Designation	Type	Manufacturer	Frequency range	Cal.-date	next Cal.-date	Inventor y no.	used
EMI test receiver	ESU40	R & S	10 Hz - 40 GHz	15.10.19	31.12.20	E2025	X
Antenna	CBL 6111	Chase	30 MHz – 1 GHz	05.12.19	05.12.21	K1026	X
Pre amplifier	AM1431	Miteq	10kHz - 1GHz	31.10.19	31.10.20	K1721	X
software	BAT-EMC	Nexio	V3.20.0.10	-	-	-	X

Test location: SAC
 Test engineer: Reusch
 Date: 16.12.2020

Test results:

Frequency range	Operation Mode	Antenna polarity	Detector	Measurement report
30 MHz - 1 GHz	Idle Mode	vertical	PK / QP	3
		horizontal	PK / QP	4

The EUT fulfilled the required limits.



- FCC/FCC 15.109 B - Q-Peak/10.0m/
- Peak (Manual suspects) (Vertical)
- Avg (Manual suspects) (Vertical)
- Peak (Vertical)
- Avg (Vertical)
- Peak (Peak/Lim.Q-Peak) (Vertical)
- ↓ QuasiPeak (dBuV/m) (Vertikal) (Vertical)

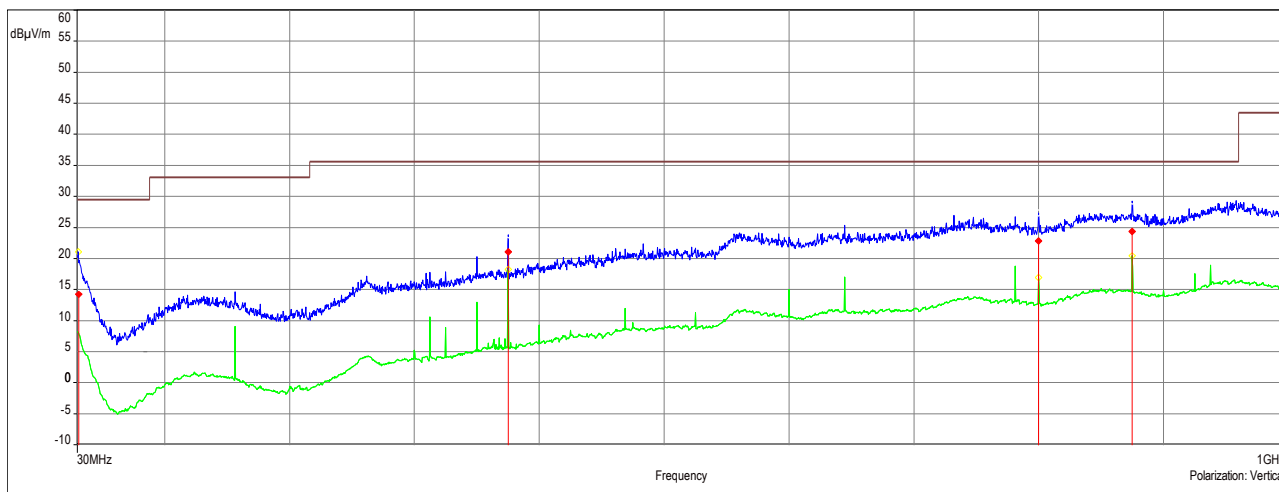

Frequency (MHz)	QuasiPeak (dBuV/m)	Margin (dB)	Average (dBuV/m)	Angle (°)	Height (m)	Polarisation
31	14.28	15.22	7.53	32.40	2.88	Vertical
374.99	21.03	14.57	17.34	-170.10	1.00	Vertical
799.99	22.84	12.76	17.99	-98.50	2.05	Vertical

Measurement report 3.



- FCC/FCC 15.109 B - Q-Peak/10.0m/
- Peak (Horizontal)
- Avg (Horizontal)
- Peak (Peak/Lim. Q-Peak) (Horizontal)
- ↓ QuasiPeak (dBμV/m) (Vertikal) (Horizontal)

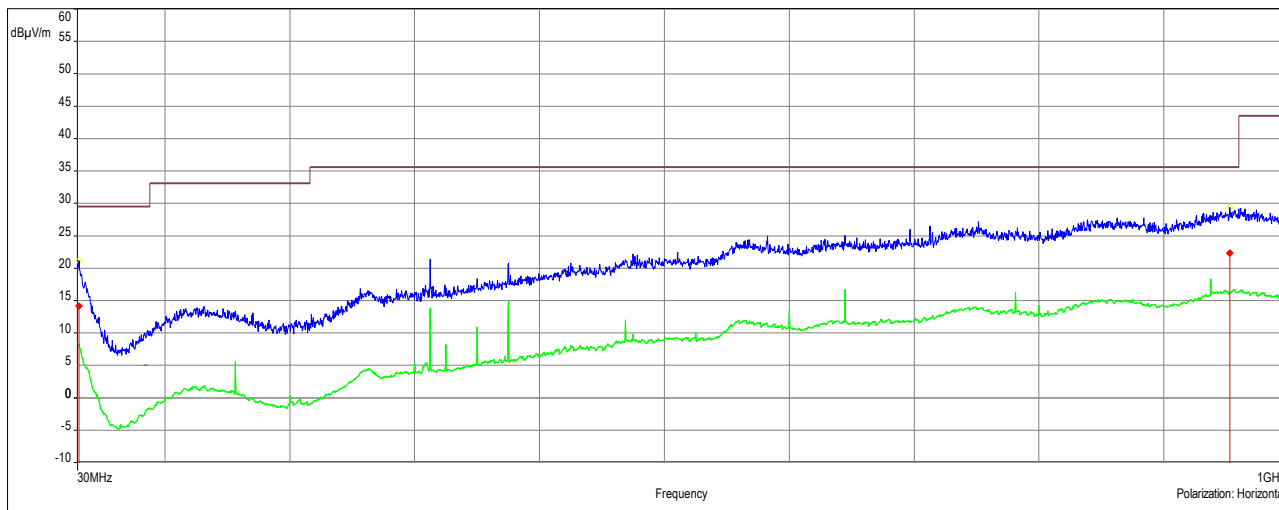

Frequency (MHz)	QuasiPeak (dBμV/m)	Margin (dB)	Average (dBμV/m)	Angle (°)	Height (m)	Polarization
31.3	14.21	15.29	7.50	-149.70	3.25	Horizontal
952.9	22.34	13.26	15.64	-125.30	3.85	Horizontal

Measurement report 4.

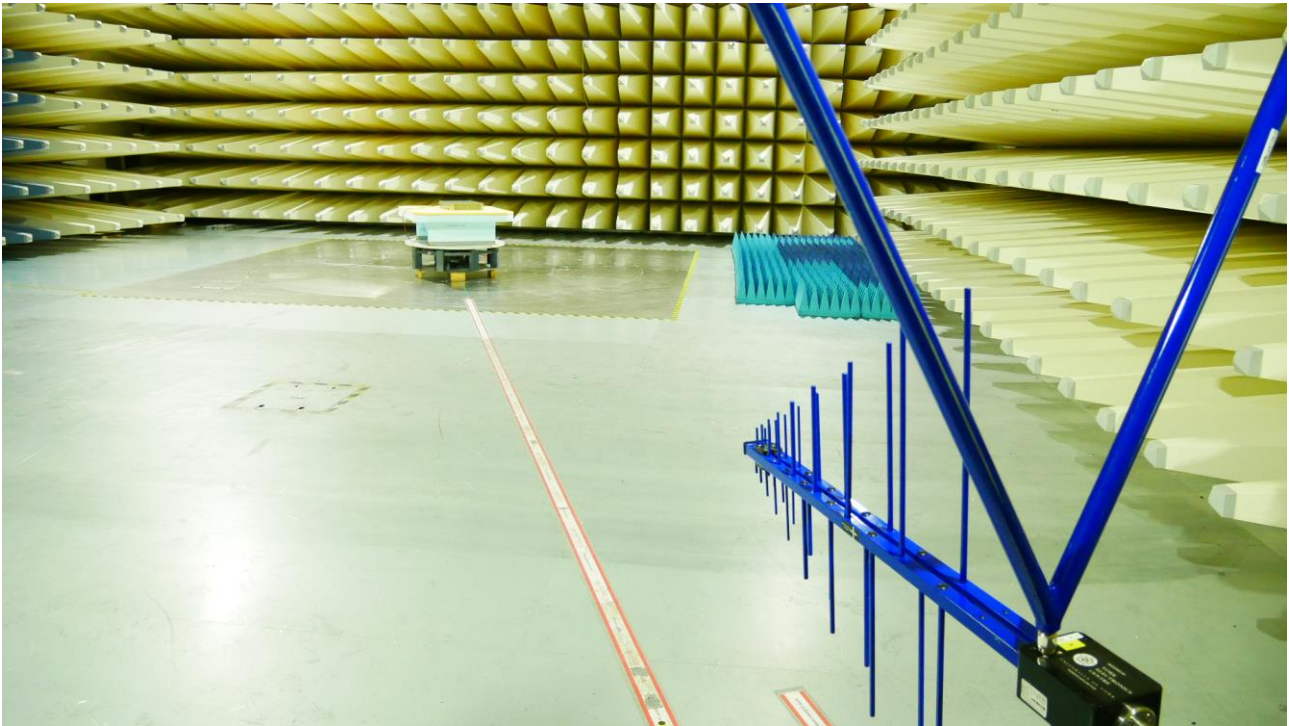

Basic set-up

The measurements were made in the operating mode, with the EUT producing the maximum emission, consistent with normal applications. The EUT load was adjusted within the range specified by manufacturer in order to maximize the emission.

For this test, the EUT was placed on the turntable at a distance of 10 m from the receive antenna. The EUT was positioned on a 10 cm high wooden pallet or on a nonconductive table. The connecting lines to the EUT were fed in from above (as in the installation). The system ground was connected to the ground plane. The turntable was connected directly to the ground system of the test chamber.

While EUT power is on, an operator manually scans the selected frequency range using an EMI test receiver to identify signals being generated by the EUT. At this time the operator determines which signals generated by EUT are significant enough to assign to the final data list in the computer. The signals on the final list are automatically characterized while the antenna is in both horizontal and vertical polarity. The tower and turntable are controlled by the operator. The maximized signal indication on the receiver is then combined with the calibration factors, cable insertion loss and the proper antenna factors to provide the emission level in dB $\mu\text{V}/\text{m}$ which is compared directly with the requirement stored in the program libraries. The maximum RFI field strength was determined during the measurement by rotating the turntable (± 180 degrees) and varying the height of the receive antenna ($h = 1 \dots 4$ m).

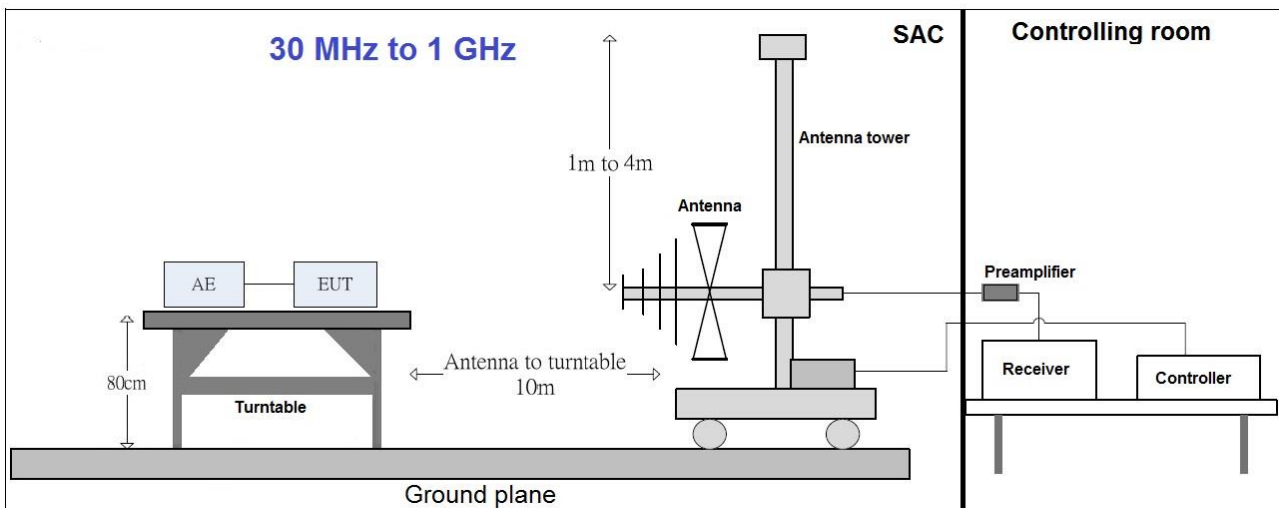

Step 1: Preliminary scan

This is a preliminary test to identify the highest amplitudes relative to the limit.

Settings for step 1:

- Antenna distance: 10 m
- Detector: Peak-Maxhold / Quasipeak (FFT-based)
- Frequency range: 30 – 1000 MHz
- Frequency steps: 30 kHz
- IF-Bandwidth: 120 kHz
- Measuring time / Frequency step: 100 ms
- Turntable angle range: -180° to 180°
- Turntable step size: 15°
- Height variation range: 1 – 4 m
- Height variation step size: 2 m
- Polarisation: Horizontal + Vertical

Intention of this step is, to determine the radiated EMI-profile of the EUT. Afterwards the relevant emissions for the final measurement are identified.



Step 2: Adjustment measurement

In this step the accuracy of the turntable azimuth and antenna height will be improved. This is necessary to find out the maximum value of every frequency.

For each frequency, which was determined the turntable azimuth and antenna height will be adjusted. The turntable azimuth will slowly vary by $\pm 45^\circ$ around this value. During this action, the value of emission is continuously measured. The turntable azimuth at the highest emission will be recorded and adjusted. In this position, the antenna height will also slowly vary by ± 100 cm around the antenna height determined. During this action, the value of emission is also continuously measured. The antenna height of the highest emission will also be recorded and adjusted.

- Detector: Peak – Maxhold
- Measured frequencies: in step 1 determined frequencies
- IF – Bandwidth: 120 kHz
- Measuring time: 100 ms
- Turntable angle range: $\pm 30^\circ$ around the determined value
- Antenna polarization: max. value determined in step 1

Step 3: Final measurement with QP detector

With the settings determined in step 3, the final measurement will be performed:

EMI receiver settings for step 4:

- Detector: Quasi-Peak (< 1 GHz)
- Measured frequencies: in step 1 determined frequencies
- IF – Bandwidth: 120 kHz
- Measuring time: 1 s

After the measurement a plot will be generated which contains a diagram with the results of the preliminary scan and a chart with the frequencies and values of the results of the final measurement.

Field Strength Calculations

$$FS = SA + AF + CL$$

Where as;

- FS** = Total Field Strength
- SA** = EMC test receiver Reading
- AF** = Antenna Factor
- CL** = Cable Loss



4.3 Radiated emission from the enclosure in the frequency range above 1 GHz

Set-up and test method:

Frequency range	Measurement distance	Limit	Test method
1 GHz – 3.223 GHz *	3 m	15.109 Class B	ANSI C63.4:2014

* 5 times highest internal frequency : $5 * 644.53125 \text{ MHz} = 3.223 \text{ MHz}$

Test equipment used:

Designation	Type	Manufacturer	Frequency range	Cal.-date	next Cal.-date	Inventory no.	used
EMI test receiver	ESU40	R & S	10 Hz - 40 GHz	15.10.19	31.12.20	E2025	X
Antenna	HL025	R & S	1 GHz - 18 GHz	21.06.19	21.06.21	K1114	X
Preamplifier	AFS4-00102000	Miteq	100 MHz - 20 GHz	20.08.19	31.12.20	K817	X
Software / software	BAT-EMC	Nexio	V3.18.0.32	-	-	-	X

Test location: SAC
 Test engineer: Reusch
 Date: 16.12.2020

Test results:

Frequency range	Operational Mode	Antenna		EUT azimuth	Detector	Measurement report
		Polarity	Height			
1 GHz – 18 GHz	Idle Mode	vertical	1 – 4m	-180° at +180°	AV	5
		horizontal	1 – 4m	-180° at +180°	AV	6

The EUT fulfilled the required limits.



- FCC/FCC 15.109 B - Avg/3.0m/
- FCC/FCC 15.109 B - Q-Peak/3.0m/
- FCC/FCC 15.109 B - Peak/3.0m/
- ◇ Peak (Manual suspects) (Vertical)
- ◇ Avg (Manual suspects) (Vertical)
- Peak (Vertical)
- Avg (Vertical)
- ◇ Avg (Avg/Lim.Avg) (Vertical)
- × Peak (dBμV/m) (Vertical) (Vertical)
- × Average (dBμV/m) (Vertical) (Vertical)
- × Margin AV (dB) (Vertical) (Vertical)

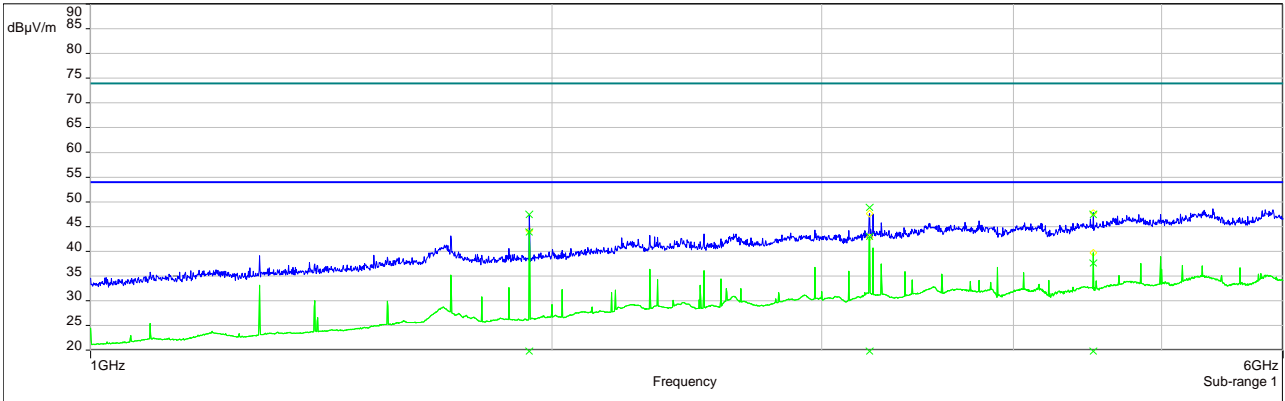

Frequency (MHz)	Peak (dBμV/m)	Average (dBμV/m)	Margin (dB)	Height (m)	Angle (°)	Polarization
1933.5	47.40	43.90	10.10	1.58	148.30	Vertical
3222.75	48.84	43.04	10.96	1.88	146.80	Vertical
4512	47.41	37.67	16.33	1.89	92.70	Vertical

Measurement report 5.



- FCC/FCC 15.109 B - Avg/3.0m/
- FCC/FCC 15.109 B - Q-Peak/3.0m/
- FCC/FCC 15.109 B - Peak/3.0m/
- ◇ Peak (Manual suspects) (Horizontal)
- ◇ Avg (Manual suspects) (Horizontal)
- Peak (Horizontal)
- Avg (Horizontal)
- ◇ Avg (Avg/Lim.Avg) (Horizontal)
- × Peak (dBμV/m) (Vertikal) (Horizontal)
- × Average (dBμV/m) (Vertikal) (Horizontal)
- × Margin AV (dB) (Vertikal) (Horizontal)

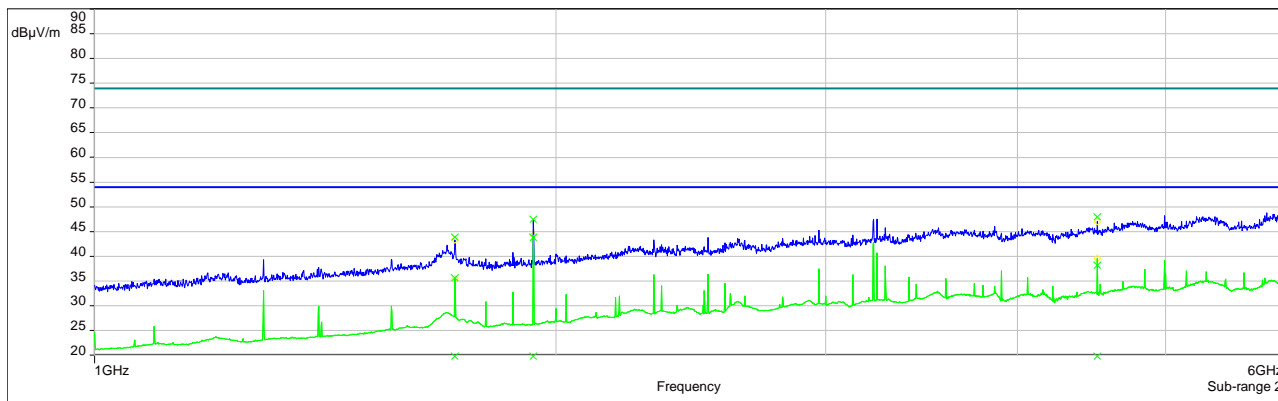

Frequency (MHz)	Peak (dBμV/m)	Average (dBμV/m)	Margin (dB)	Height (m)	Angle (°)	Polarization
1718.75	43.87	35.64	18.36	1.95	-47.70	Horizontal
1933.5	47.50	43.75	10.25	1.29	116.10	Horizontal
4511.75	48.02	38.26	15.74	1.77	87.00	Horizontal

Measurement report 6.

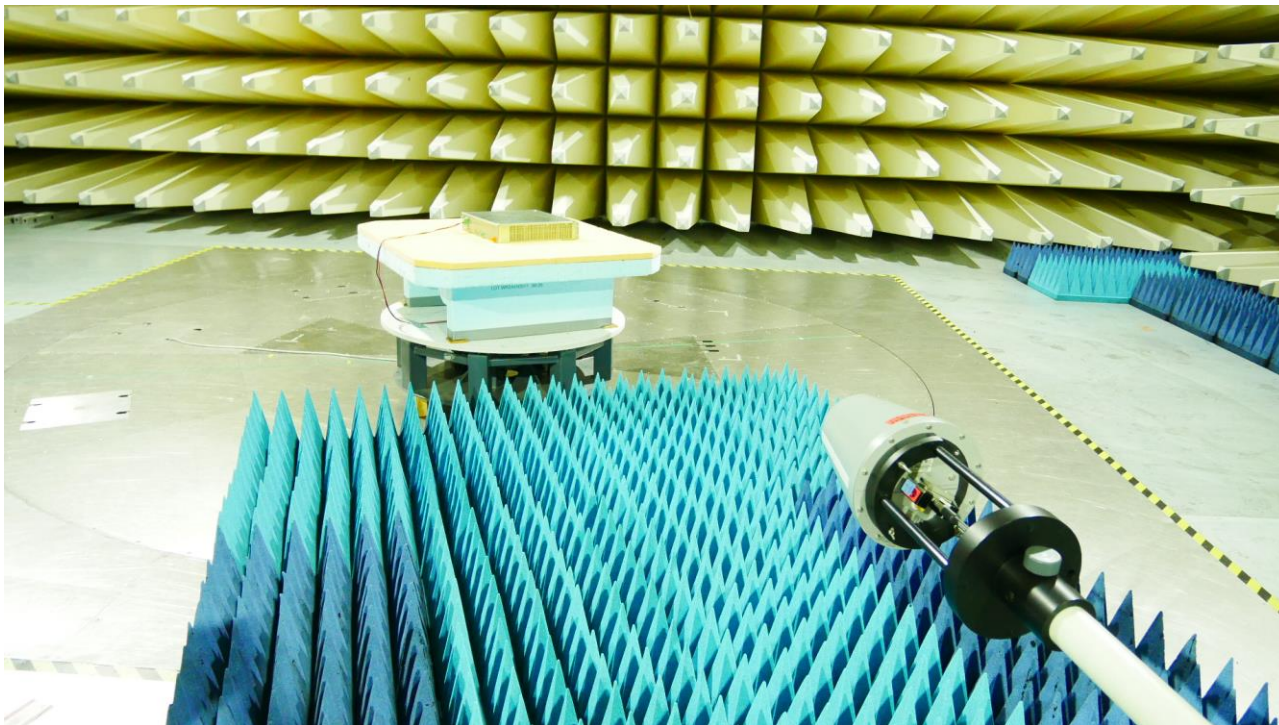

Basic set-up

The measurements were made in the operating mode, with the EUT producing the maximum emission, consistent with normal applications. The EUT load was adjusted within the range specified by manufacturer in order to maximize the emission.

For this test, the EUT was placed on the turntable at a distance of 3 m from the receive antenna. The EUT was positioned on a 10 cm high wooden pallet or on a non-conductive table. The connecting lines to the EUT were fed in from above (as in the installation). The system ground was connected to the ground plane. The turntable was connected directly to the ground system of the test chamber.

While EUT power is on, an operator manually scans the selected frequency range using an EMI test receiver to identify signals being generated by the EUT. At this time the operator determines which signals generated by EUT are significant enough to assign to the final data list in the computer. The signals on the final list are automatically characterized while the antenna is in both horizontal and vertical polarity. The tower and turntable are controlled by the operator. The maximized signal indication on the receiver is then combined with the calibration factors, cable insertion loss and the proper antenna factors to provide the emission level in dB μ V/m which is compared directly with the requirement stored in the program libraries. The maximum RFI field strength was determined during the measurement by rotating the turntable (± 180 degrees) and varying the height of the receive antenna ($h = 1 \dots 4$ m).

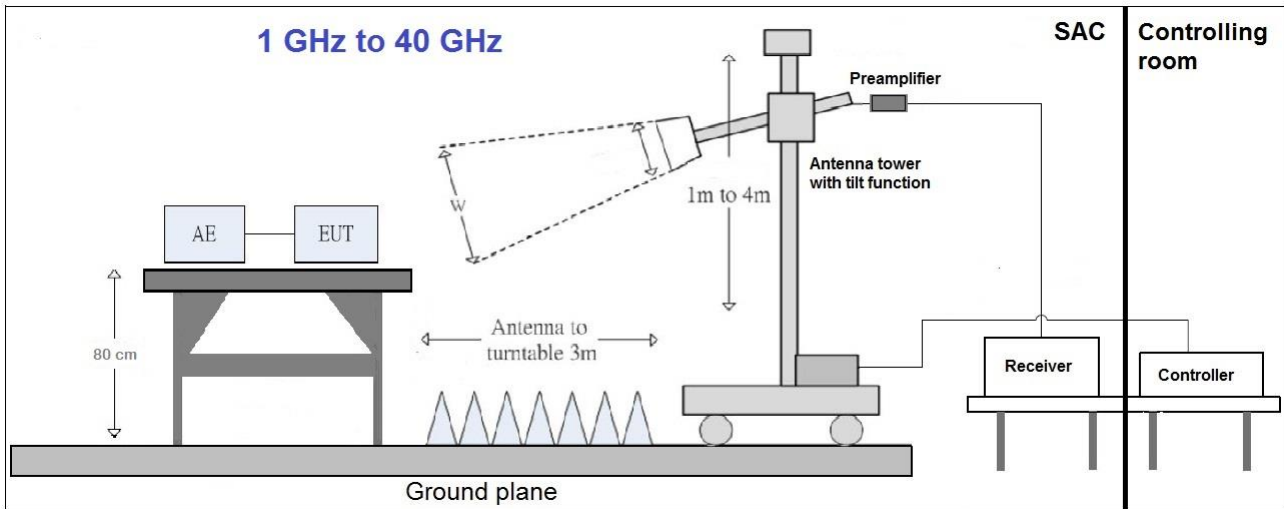

The following modifications apply to the measurement procedure for the frequency range above 1 GHz:

Step 1:

The Equipment Under Test (EUT) was set up on a non-conductive support at 0.8 m height in the semi-anechoic chamber. Absorbers are placed around and between the turn table and the antenna tower. The turn table step size (azimuth angle) for the preliminary measurement is 15 °.

Step 2:

The maximum RFI field strength was determined during the measurement by rotating the turntable (± 180 degrees) and varying the height of the receive antenna ($h = 1 \dots 4$ m) with an additional tilt function of the antenna. The turn table azimuth will slowly vary by $\pm 15^\circ$.

EMI receiver settings (for all steps):

- Detector: Peak, Average
- IF Bandwidth = 1 MHz

Step 3:

Spectrum analyzer settings for step 3:

- Detector: Peak / Average
- Measured frequencies: in step 1 determined frequencies
- IF – Bandwidth: 1 MHz
- Measuring time: 1 s

Field Strength Calculations

$$FS = SA + AF + CL$$

Where as;

- FS** = Total Field Strength
- SA** = EMC test receiver Reading
- AF** = Antenna Factor
- CL** = Cable Loss

EMC Test Report No.: 20-146

FCC Registration Number: DE0023



BUREAU
VERITAS

Annex A: Accreditation certificate (for information)

The accreditation relates to competences stated on the accreditation certificate. The current certificate is available on the homepage of the DAkkS and can be downloaded under accredited bodies with the processing number:

see <https://www.dakks.de/en>

******* End of test report *******