

Test Site
FCC Test Site No.: 96997



BUREAU
VERITAS

ECL-EMC Test Report No.: 15-020

Equipment under test: **ION-U H 7P/80-85P/17P/19P**
800MHz Path
FCC ID: **XS5-UH781719P**

Type of test: **FCC 47 CFR Part 90 Subpart S:2015**
Private Land Mobile Repeater

Measurement Procedures: 47 CFR Parts 2:2015 (*Frequency Allocations and Radio Treaty Matters; General Rules and Regulations*), Part 90:2015 (Private Land Mobile), ANSI/TIA-603-C (2004), *Land Mobile FM or PM Communications Equipment Measurement and Performance Standards*
IC-RSS-GEN:2007 General Requirements and Information for the Certification of Radiocommunication Equipment

Test result: **Passed**

Date of issue:	29.06.15	Signature:	
Issue-No.:	01	Author:	
Date of delivery:	27.01.15	Checked:	
Test dates:	15.12.14 – 27.01.15		
Pages:	67		

Test Report No.: 15-020

FCC ID: XS5-UH781719P



BUREAU
VERITAS

Manufacturer: ANDREW Wireless Systems GmbH
Industriering 10

D-86675 Buchdorf

Tel.: +49 (0)9099 69 0

Fax: +49 (0)9099 69 140

Test Location: Bureau Veritas Consumer Products Services
Germany GmbH
European Compliance Laboratory (ECL)
Thurn-und-Taxis-Straße 18

D-90411 Nürnberg

Tel.: +49 40 74041 0

Fax: +49 40 74041-2755

General:

The purpose of this report is to show compliance to the FCC regulations for licensed devices operating under section 90 of the Code of Federal Regulations title 47.

This report informs about the results of the RF tests, it only refers to the equipment under test. No part of this report may be reproduced in any form, without written permission.



Table of contents

1	TEST RESULTS SUMMARY	6
2	EQUIPMENT UNDER TEST (E.U.T.)	7
2.1	DESCRIPTION	7
2.1.1	DOWNLINK	7
2.1.2	UPLINK	7
2.1.3	DESCRIPTION OF EUT	8
2.1.4	BLOCK DIAGRAM OF MEASUREMENT REFERENCE POINTS	9
2.1.5	DOWNLINK SYSTEM GAIN AND OUTPUT POWER.....	9
3	TEST SITE (ANDREW BUCHDORF)	10
3.1	TEST ENVIRONMENT	10
3.2	TEST EQUIPMENT	10
3.3	INPUT AND OUTPUT LOSSES	11
3.4	MEASUREMENT UNCERTAINTY	11
4	TEST SITE (BUREAU VERITAS CONSUMER PRODUCTS SERVICES)	11
5	RF POWER OUT: §90.635, §2.1046	12
5.1	LIMIT.....	12
5.2	TEST METHOD	12
5.3	TEST RESULTS.....	13
5.3.1	DOWNLINK.....	14
5.3.1.1	GSM.....	16
5.3.1.2	EDGE.....	16
5.3.1.3	CDMA	17
5.3.1.4	WCDMA.....	17
5.3.1.5	LTE	18
5.3.2	UPLINK	18
5.4	SUMMARY TEST RESULT.....	18
6	OCCUPIED BANDWIDTH: §90.210, §2.1049	19
6.1	LIMIT.....	19
6.2	TEST METHOD	19
6.3	TEST RESULTS	20
6.3.1	DOWNLINK.....	20
6.3.1.1	GSM.....	21
6.3.1.2	EDGE.....	22
6.3.1.3	CDMA	23
6.3.1.4	WCDMA.....	24
6.3.1.5	LTE	25
6.3.2	26DB BANDWIDTH.....	26
6.3.2.1	GSM.....	26
6.3.2.2	EDGE.....	27
6.3.2.3	CDMA	28
6.3.2.4	WCDMA.....	29



6.3.2.5	LTE	30
6.3.3	UPLINK	31
6.4	SUMMARY TEST RESULT	31
7	SPURIOUS EMISSIONS AT ANTENNA TERMINALS: §90.210, §2.1051	32
7.1	LIMIT	32
7.2	TEST METHOD	32
7.3	TEST RESULTS	33
7.3.1	DOWNLINK	33
7.3.1.1	GSM	34
7.3.1.2	EDGE	34
7.3.1.3	CDMA	35
7.3.1.4	WCDMA	35
7.3.1.5	LTE	36
7.3.2	UPLINK	36
7.4	SUMMARY TEST RESULT	36
8	INTERMODULATION: §90.691, §2.1051	37
8.1	LIMIT	37
8.2	TEST METHOD	37
8.3	TEST RESULTS	38
8.3.1	DOWNLINK	38
8.3.1.1	GSM	39
8.3.1.2	EDGE	40
8.3.1.3	CDMA	41
8.3.1.4	WCDMA	42
8.3.1.5	LTE	43
8.3.2	UPLINK	44
8.4	SUMMARY TEST RESULT	44
9	EMISSION MASK: §90.691, §2.1051	45
9.1	LIMIT	45
9.2	TEST METHOD	46
9.3	TEST RESULTS	46
9.3.1	DOWNLINK	46
9.3.1.1	GSM < 1MHz to band edge	47
9.3.1.2	EDGE < 1MHz to band edge	48
9.3.1.3	CDMA < 1MHz to band edge	49
9.3.1.4	WCDMA < 1MHz to band edge	50
9.3.1.5	LTE < 1MHz to band edge	51
9.3.2	UPLINK	52
9.4	SUMMARY TEST RESULT	52
10	OUT OF BAND REJECTION	53
10.1	LIMIT	53
10.2	TEST METHOD	53
10.3	TEST RESULTS	53
10.3.1	DOWNLINK	54



10.3.2	UPLINK	54
10.4	SUMMARY TEST RESULT	54
11	NOISE.....	55
11.1	LIMIT.....	55
11.2	TEST METHOD	55
11.3	TEST RESULTS.....	56
11.3.1	DOWNLINK.....	56
11.3.2	UPLINK	56
11.4	SUMMARY TEST RESULT	56
12	FIELD STRENGTH OF SPURIOUS EMISSIONS: §90.210, §2.1053	57
12.1	LIMIT §22.917	61
12.2	TEST METHOD ANSI/TIA/EA-603-C.....	62
12.3	CLIMATIC VALUES IN THE LAB.....	62
12.4	TEST RESULTS.....	63
12.4.1	30 MHZ TO 1 GHZ DOWNLINK (BOTTOM – MIDDLE – TOP) SUBPART H.....	63
12.4.2	30 MHZ TO 1 GHZ DOWNLINK (MIDDLE OF ALL PATHS)	64
12.4.3	1 GHZ TO 20 GHZ DOWNLINK (BOTTOM – MIDDLE – TOP) SUBPART H.....	65
12.4.4	1 GHZ TO 20 GHZ DOWNLINK (MIDDLE OF ALL PATHS)	66
13	HISTORY.....	67



1 Test Results Summary

Name of Test	FCC Para. No.	FCC Method	FCC Spec.	Result
RF Power Output	90.635	2.1046	1000 Watts	Complies
Occupied Bandwidth	90.210	2.1049	Input/Output	Complies
Spurious Emissions at Antenna Terminals	90.210	2.1051	-13dBm	Complies
Intermodulation testing	90.219	KDB 935210 D02 v02 Annex D.3	-13dBm	Complies
Emission Mask	90.691	2.1051	-13dBm	Complies
Frequency Stability	90.213	2.1055	1 ppm	NA
Out of Band Rejection	KDB 935210 D02 v02	KDB 935210 D03 v02	KDB 935210 D03 v02	Complies
Noise	90.219			Complies
Radiated Spurious emission	90.210	2.1053	-13dBm	Complies

Frequency stability is given by: The system gets an electrical analog signal from the BSS which is converted into an analog optical signal, transmitted by the optical links and then reconverted in the Remote Unit into an analog electrical signal. During this process happens no frequency change/modification, so input and output have same frequency what can be seen under clause "Occupied Bandwidth".



2 Equipment under test (E.U.T.)

2.1 Description

Kind of equipment	ION-U H 7P/80-85P/17P/19P-Vac-M2
Andrew Ident. Number	7698400-0001
Serial no.(SN)	11
Revision	00
Software version and ID	1.69.0
Type of modulation and Designator	GSM (GXW) <input checked="" type="checkbox"/> GSM EDGE (G7W) <input checked="" type="checkbox"/> CDMA (F9W) <input checked="" type="checkbox"/> W-CDMA (F9W) <input checked="" type="checkbox"/> LTE (G7D) <input checked="" type="checkbox"/>
Frequency Translation	F1-F1 <input checked="" type="checkbox"/> F1-F2 <input type="checkbox"/> N/A <input type="checkbox"/>
Band Selection	Software <input type="checkbox"/> Duplexer <input checked="" type="checkbox"/> Full band <input type="checkbox"/>

2.1.1 Downlink

Pass band	Path 862 MHz – 894 MHz
Pass band under test	Path 862 MHz – 869 MHz
Max. composite output power based on one carrier per path (rated)	43.0 dBm = 20 W
MIMO max. composite output power based on one carrier per path (rated)	46.0 dBm = 40 W
System Gain*	10 dB @ Pout BTS of 33 dBm

*see 2.1.5

2.1.2 Uplink

Pass band	Path 817 MHz – 849 MHz
Maximum rated output power	n. a.
System Gain*	n.a.

*see 2.1.5

Note: The EUT does not transmit over the air in the uplink direction.



2.1.3 Description of EUT

CommScope's ION-U H 7P/80-85P/17P/19P-Vac-M2 is a multi-band, multi-operator Remote Unit. It is used in conjunction with a Master Unit in the ION optical distribution system. This system transports up to four frequency bands simultaneously, providing a cost-effective solution for distributing capacity from one or more base stations. In single use the ION-U H 7P/80-85P/17P/19P-Vac-M2 is a SISO system. In combination with a ION-U EU H 7P/80-85P/17P/19P-Vac-M2 and or ION-U EU H 23/23-Vac-M2 the ION-U system can use for MIMO application in all RF paths.

This Test Report describes only the approval of the 800 MHz Path.

The ION-U H 7P/80-85P/17P/19P-Vac-M2 Repeater system consists of one 700 MHz path, one 800-850 MHz path, one 1700/2100 MHz path and one 1900 MHz path with the intended use of simultaneous transmission.

The antenna(s) used with device must be fixed-mounted on permanent structures.



2.1.4 Block diagram of measurement reference points

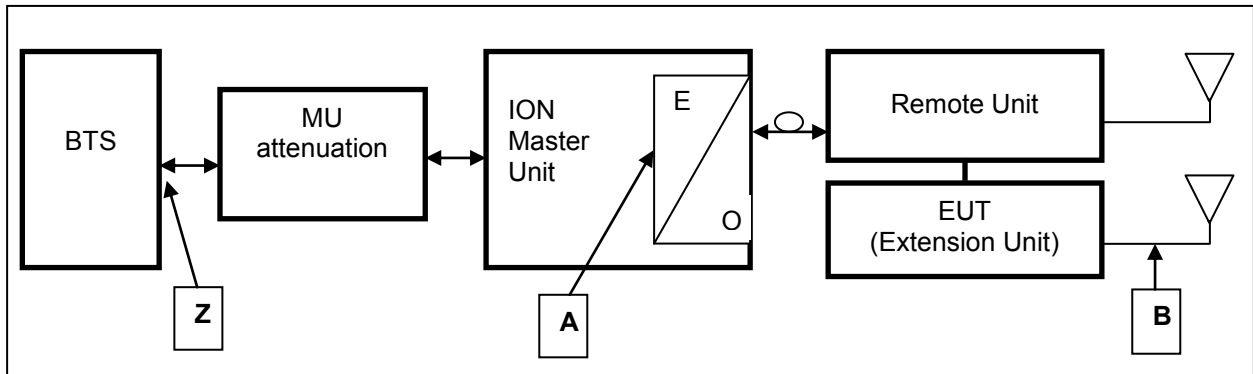

figure 2.1.4-#1 Block diagram of measurement reference points

Remote Unit (RU) is the EUT

O/E Optical/Electrical converter
 MU Master Unit

Reference point A	MU	UL output,	DL input
Reference point B	Remote Unit	DL output,	UL input
Reference point Z	BTS	DL output,	UL input

Since a signal generator does not supply a good output signal with +33 or +43dBm, for the downlink measurement the MU Attenuation is not used.

That means for downlink measurements the signal generator is connected to measurement point A at the master optical / electrical converter and the analyzer to the measurement point B at the RU.

2.1.5 Downlink System Gain and Output Power

System optimized for BTS power (fixed value) Z	MU Attenuation (manual leveling)	Maximum rated input power at the MU OTRX (fixed value) A	RU Gain (fixed value) A to B	Maximum rated output power at RU Antenna port (fixed value) B
+33 dBm	55 dB	-22 dBm	+65 dB	+43.0 dBm @ 1 carrier
System Gain Z to B	+10 dB			
+43 dBm	65 dB	-22 dBm	+65 dB	+43.0 dBm @ 1 carrier
System Gain Z to B	+0 dB			

table 2.1.5-#1 Equipment under test (E.U.T.) Description Downlink System Gain and Output Power



3 Test site (Andrew Buchdorf)

3.1 Test environment

All tests were performed under the following environmental conditions:

Condition	Minimum value	Maximum value
Barometric pressure	86 kPa	106 kPa
Temperature	15°C	30°C
Relative Humidity	20 %	75 %
Power supply range	±5% of rated voltages	

3.2 Test equipment

ANDREW Inv. No.	Test equipment	Type	Manufacturer	Serial No.	Calibration
9266	Network Analyzer	ZNB 20	R&S	101490	12/2015
9236	Spectrum Analyzer	FSV 30	R&S	101345	9/2015
9069	Generator	SMBV100A	R&S	256275	08/2015
9046	Generator	SMBV100A	R&S	255090	06/2016
8542	Power Meter	E4418A	Agilent	GB38273230	02/2016
8544	Power Sensor	E8481H	Agilent	3318A19208	07/2015
7157	RF-Cable	Succoflex	Suhner	36180/4P	CIU
7158	RF-Cable	Succoflex	Suhner	36182/4P	CIU
7289	RF-Cable	Succoflex	Suhner	28443/4PE	CIU
7290	RF-Cable	Succoflex	Suhner	28444/4PE	CIU
7385	RF-Cable	Succoflex	Suhner	36267/4P	CIU
7387	RF-Cable	Succoflex	Suhner	36267/4P	CIU
7390	RF-Cable	Succoflex	Suhner	40193/4P	CIU
7381	RF-Cable	Succoflex	Suhner	40200/4P	CIU
7460	Notch filter	WRCTF869/894- 867/896- 60/12+9EE	Wainwright Instruments	1	CIU
7406	Switch-Matrix		Andrew		CIU

CIU = Calibrate in use



3.3 Input and output losses

All recorded power levels should be referenced to the input and output connectors of the repeater, unless explicitly stated otherwise.

The test equipment used in this test has to be calibrated, so that the functionality is also checked.

All cables, attenuators, splitter, isolator, circulator and combiner etc. must be measured before testing and used for compensation during testing.

3.4 Measurement uncertainty

The extended measurement uncertainty corresponds to the measurement results from the standard measurement uncertainty multiplied by the coverage factor $k=2$. The true value is located in the corresponding interval with a probability of 95 %.

4 Test site (Bureau Veritas Consumer Products Services)

FCC Test site: 96997

See relevant dates under section 8.



5 RF Power Out: §90.635, §2.1046

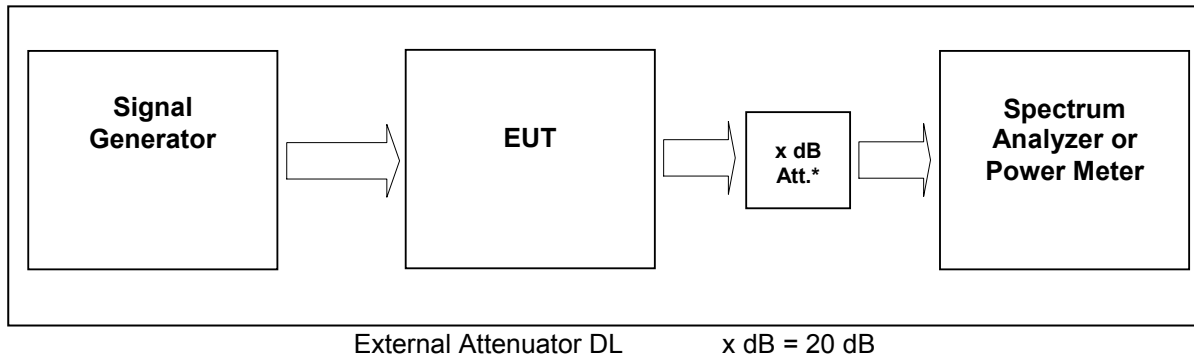

figure 5-#1 Test setup: RF Power Out: §90.635, §2.1046

Measurement uncertainty	± 0,38 dB
Test equipment used	9069, 9046, 9236, 7406, 7157, 7158, 7289, 7290, 7385

5.1 Limit

Minimum standard:

§ 90.635 Limitations on power and antenna height.

(a) The effective radiated power and antenna height for base stations may not exceed 1 kilowatt (30 dBW) and 304 m. (1,000 ft.) above average terrain (AAT), respectively, or the equivalent thereof as determined from the Table. These are maximum values, and applicants will be required to justify power levels and antenna heights requested.

5.2 Test method

§ 2.1046 Measurements required: RF power output.

(a) For transmitters other than single sideband, independent sideband and controlled carrier radiotelephone, power output shall be measured at the RF output terminals when the transmitter is adjusted in accordance with the tune-up procedure to give the values of current and voltage on the circuit elements specified in § 2.1033(c)(8). The electrical characteristics of the radio frequency load attached to the output terminals when this test is made shall be stated.

(c) For measurements conducted pursuant to paragraphs (a) and (b) of this section, all calculations and methods used by the applicant for determining carrier power or peak envelope power, as appropriate, on the basis of measured power in the radio frequency load attached to the transmitter output terminals shall be shown. Under the test conditions specified, no components of the emission spectrum shall exceed the limits specified in the applicable rule parts as necessary for meeting occupied bandwidth or emission limitations



5.3 Test Results

Detector RMS.

Test signal GSM:

Signal waveform with GMSK modulation in all time slots according to 3GPP TS45.004

Test signal GSM EDGE:

Signal waveform with 8-PSK modulation in all time slots according to 3GPP TS45.004

Test signal CDMA:

Signal waveform according to table 6.2-1 of standard specification 3GPP2 C.p0051-0 v1.0 16.February 2006 pilot, sync, paging, 37 traffics, which is equal to the table 6.5.2.1 of 3GPP2 C.S0010-C v2.0 24.February 2006.

Test signal WCDMA:

Signal waveform according to Test Model 1 of standard specification 3GPP TS25.141. Signal modulated with a combination of PCCPCH, SCCPCH and Dedicated Physical Channels specified as test model 1 64 DPCH.

Test signal LTE:

Signal waveform according to Test Model 1.1, E-TM1.1, clause 6.1.1.1-1, table 6.1.1.1-1 of standard specification 3GPP TS 36.141 V9.3.0 (2010-03).



5.3.1 Downlink

Modulation	Measured at	Carrier /MHz	RBW VBW Span	RF Power (dBm)	RF Power (W)	MIMO* RF Power (W)	Plot -
GSM	Middle	865.5 MHz	1MHz 3MHz 10MHz	43.0	20	40	5.3.1.1 #1
EDGE	Middle	865.5 MHz	1MHz 3MHz 10MHz	43.0	20	40	5.3.1.2 #1
CDMA	Middle	865.5 MHz	3MHz 10MHz 15MHz	43.0	20	40	5.3.1.3 #1
WCDMA	Middle	865.5 MHz	10MHz 10MHz 50MHz	43.0	20	40	5.3.1.4 #1
LTE	Middle	865.5 MHz	3MHz 10MHz 15MHz	43.0	20	40	5.3.1.5 #1
Maximum output power = 43.0 dBm = 20 W							
Limit Maximum output power (erp) = 1000 W							

table 5.3.1-#1 RF Power Out: §90.635, §2.1046 Test Results Downlink

SISO:

The max RF Power out is 43 dBm, so the maximum antenna gain (x) can be calculated as follow:

Limit = 1000W (erp) = 60 dBm

Info: 1000W (erp) = 1640W (eirp)

$60 \text{ dBm} > 43 \text{ dBm} + x \rightarrow x = 60 \text{ dBm} - 43 \text{ dBm} = 17 \text{ dBd}$

$x \text{ dBi} = 17 \text{ dBd} + 2.15 = 19.15 \text{ dBi}$

=> The antenna that will be used for the complete system have to have a gain lower than 19.15 dBi, relative to a dipol.

***MIMO:**

MIMO path test results see RF Test Report FCC ID XS5-UEUH781719P.

If the DUT used in MIMO configuration according to KDB 662911, the MIMO Max RF Power is the sum of the RF power from the SISO path and MIMO path.

MIMO Max RF Power = SISO path RF Power + MIMO path RF Power

MIMO Max RF Power = 20 W + 20 W = 40 W = 46 dBm



The MIMO max RF Power out is 46 dBm, so the maximum antenna gain (x) can be calculated as follow:

Limit = 1000W (erp) = **60 dBm**

Info: 1000W (erp) = 1640W (eirp)

$$60 \text{ dBm} > 46 \text{ dBm} + x \text{ -----} \rightarrow x = 60 \text{ dBm} - 46 \text{ dBm} = \underline{14 \text{ dBd}}$$
$$x \text{ dBi} = 14 \text{ dBd} + 2.15 = \underline{16.15 \text{ dBi}}$$

=> The antenna that will be used for the complete system have to have a gain lower than 16.15 dBi, relative to a dipol.

Modulation	Pin / dBm (Ref. point B)
GSM	-21.9
EDGE	-21.9
CDMA	-22.2
WCDMA	-22.1
LTE	-21.8

table 5.3.1-#2 RF Power Out: §90.635, §2.1046 Test Results Downlink Input power



5.3.1.1 GSM

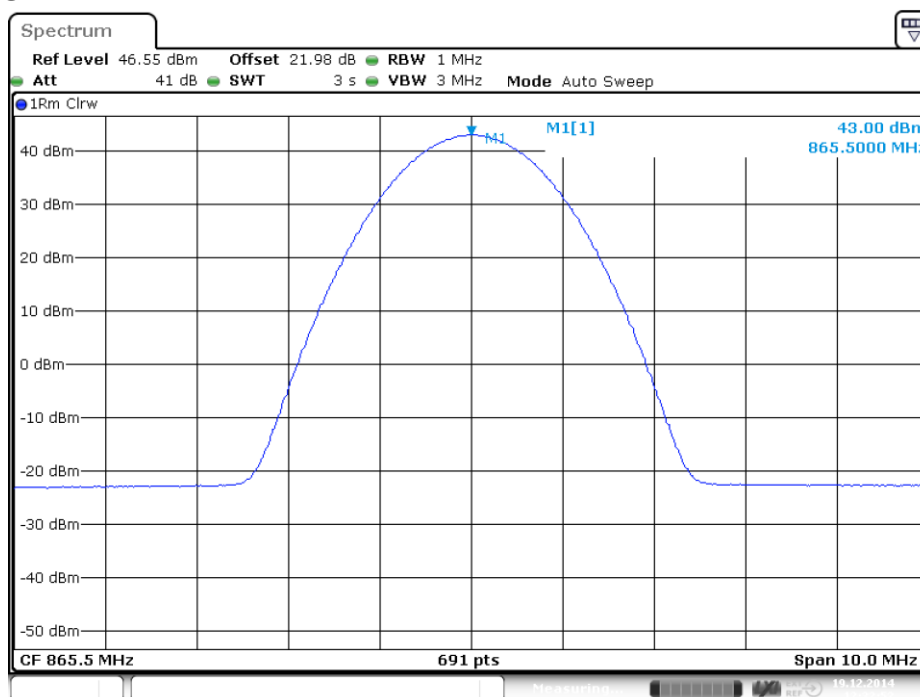

Date: 19.DEC.2014 12:32:52

plot 5.3.1.1-#1 RF Power Out: §90.635, §2.1046; Test Results; Downlink; GSM Middle

5.3.1.2 EDGE

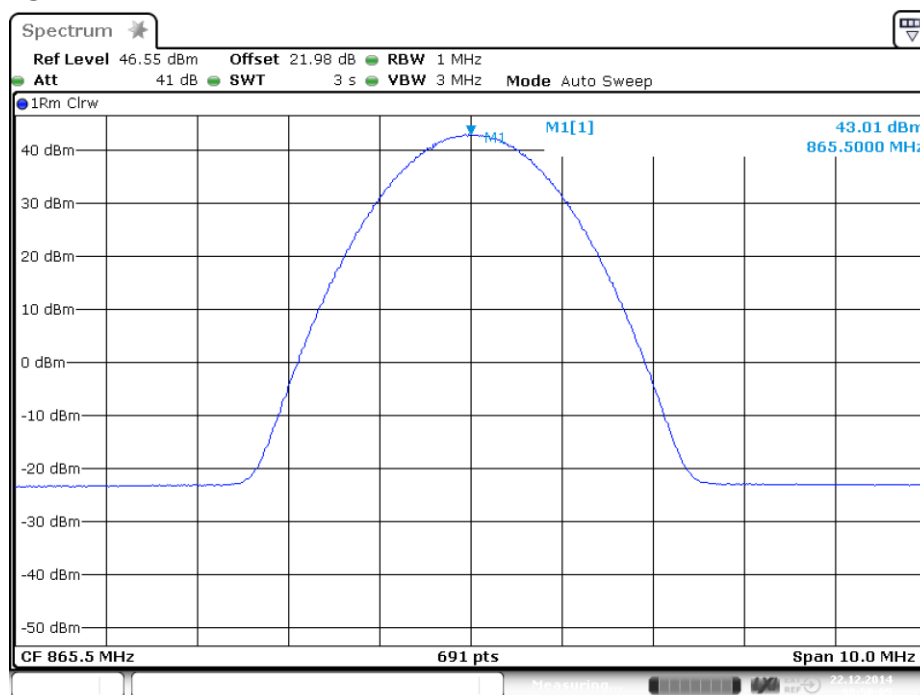

Date: 22.DEC.2014 08:50:05

plot 5.3.1.2-#1 RF Power Out: §90.635, §2.1046; Test Results; Downlink; EDGE Middle



5.3.1.3 CDMA

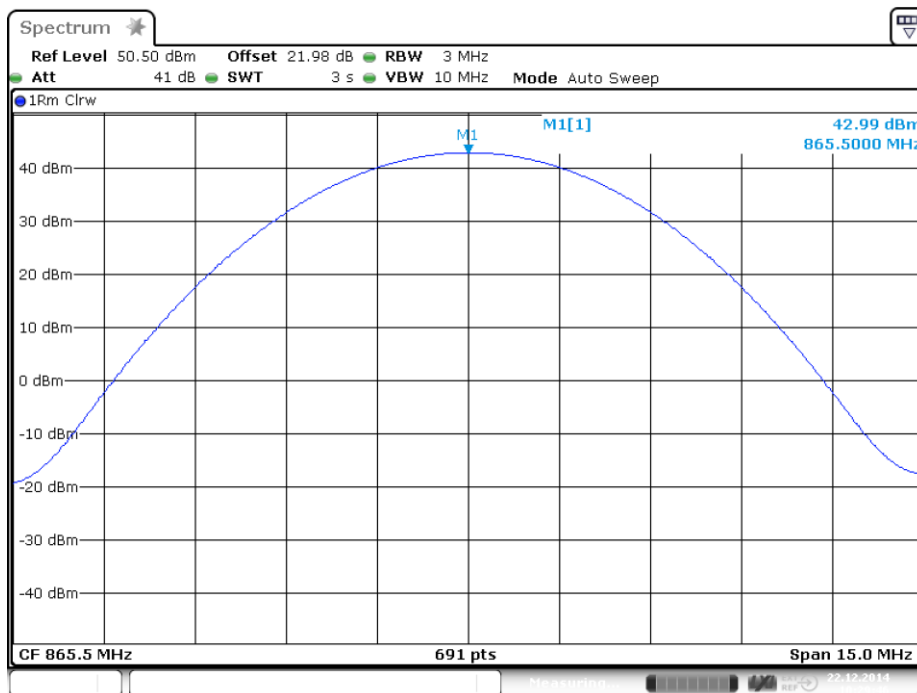

Date: 22.DEC.2014 10:29:46

plot 5.3.1.3-#1 RF Power Out: §90.635, §2.1046; Test Results; Downlink; CDMA Middle

5.3.1.4 WCDMA

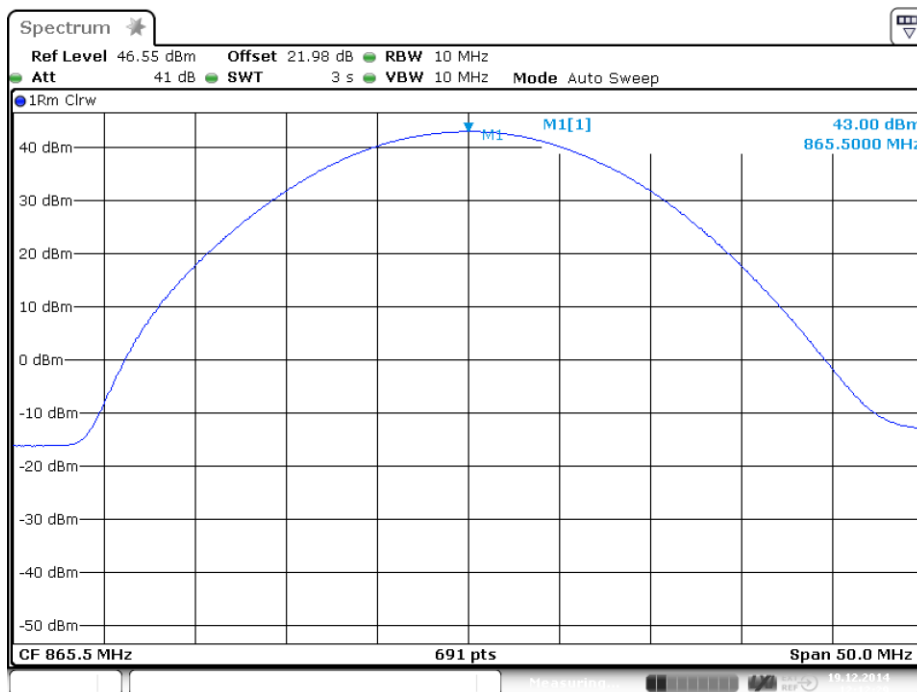

Date: 19.DEC.2014 12:12:30

plot 5.3.1.4-#1 RF Power Out: §90.635, §2.1046; Test Results; Downlink; WCDMA Middle



5.3.1.5 LTE

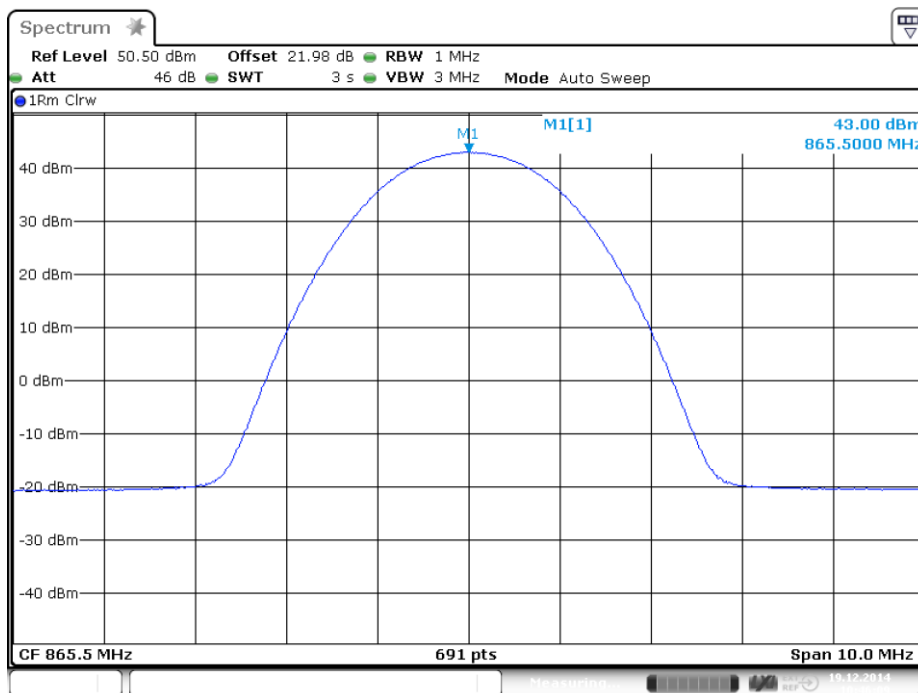

Date: 19.DEC.2014 10:46:09

plot 5.3.1.5-#1 RF Power Out: §90.635, §2.1046; Test Results; Downlink; LTE Middle

5.3.2 Uplink

n.a.

Note: The EUT does not transmit over the air in the uplink direction.

5.4 Summary test result

Test result	complies, according the plots above
Tested by:	F. Bengesser
Date:	22.12.2014

6 Occupied Bandwidth: §90.210, §2.1049

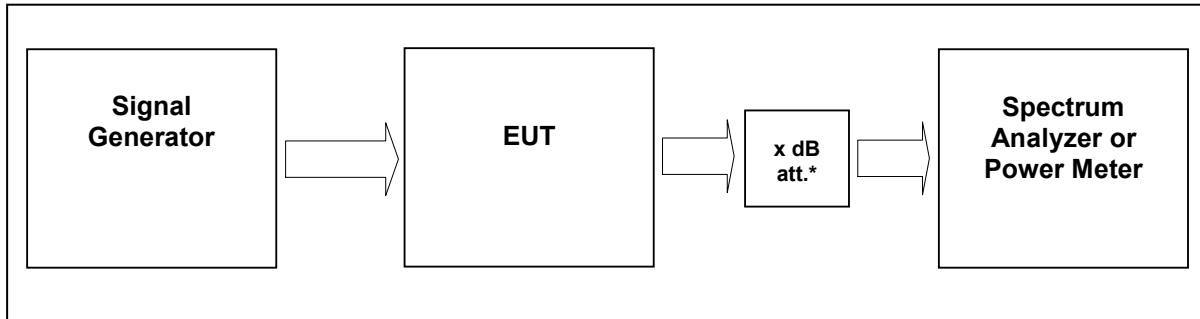

External Attenuator DL x dB = 20 dB
figure 6-#1 Test setup: Occupied Bandwidth: §90.210, §2.1049

Measurement uncertainty	± 0,38 dB
Test equipment used	9069, 9046, 9236, 7406, 7157, 7158, 7289, 7290, 7385

6.1 Limit

The spectral shape of the output should look similar to input for all modulations.

6.2 Test method

Para. No.2.1049

The occupied bandwidth, that is the frequency bandwidth such that, below its lower and above its upper frequency limits, the mean powers radiated are each equal to 0.5 percent of the total mean power radiated by a given emission shall be measured under the following conditions as applicable:



6.3 Test results

6.3.1 Downlink

Detector PK.

Modulation	Measured at	Carrier /MHz	RBW VBW Span	Occupied Bandwidth	Plot #
GSM	Middle	865.5 MHz	3 kHz 30 kHz 1 MHz	246.9 kHz	6.3.1.1 #1, #2
EDGE	Middle	865.5 MHz	3 kHz 30 kHz 1 MHz	243.9 kHz	6.3.1.2 #1, #2
CDMA	Middle	865.5 MHz	30 kHz 300 kHz 5 MHz	1.2 MHz	6.3.1.3 #1, #2
WCDMA	Middle	865.5 MHz	100 kHz 1 MHz 10 MHz	4.2 MHz	6.3.1.4 #1, #2
LTE	Middle	865.5 MHz	30 kHz 300 kHz 5 MHz	1.1 MHz	6.3.1.5 #1, #2

Modulation	Measured at	Carrier /MHz	RBW VBW Span	26dB Bandwidth	Plot #
GSM	Middle	865.5 MHz	3 kHz 30 kHz 1 MHz	322.3 kHz	6.3.2.1 #1, #2
EDGE	Middle	865.5 MHz	3 kHz 30 kHz 1 MHz	312.8 kHz	6.3.2.2 #1, #2
CDMA	Middle	865.5 MHz	30 kHz 300 kHz 5 MHz	1.4 MHz	6.3.2.3 #1, #2
WCDMA	Middle	865.5 MHz	100 kHz 1 MHz 10 MHz	4.7 MHz	6.3.2.4 #1, #2
LTE	Middle	865.5 MHz	30 kHz 300 kHz 5 MHz	1.3 MHz	6.3.2.5 #1, #2

table 6.3-#1 Occupied Bandwidth: §90.210, §2.1049 Test results



6.3.1.1 GSM

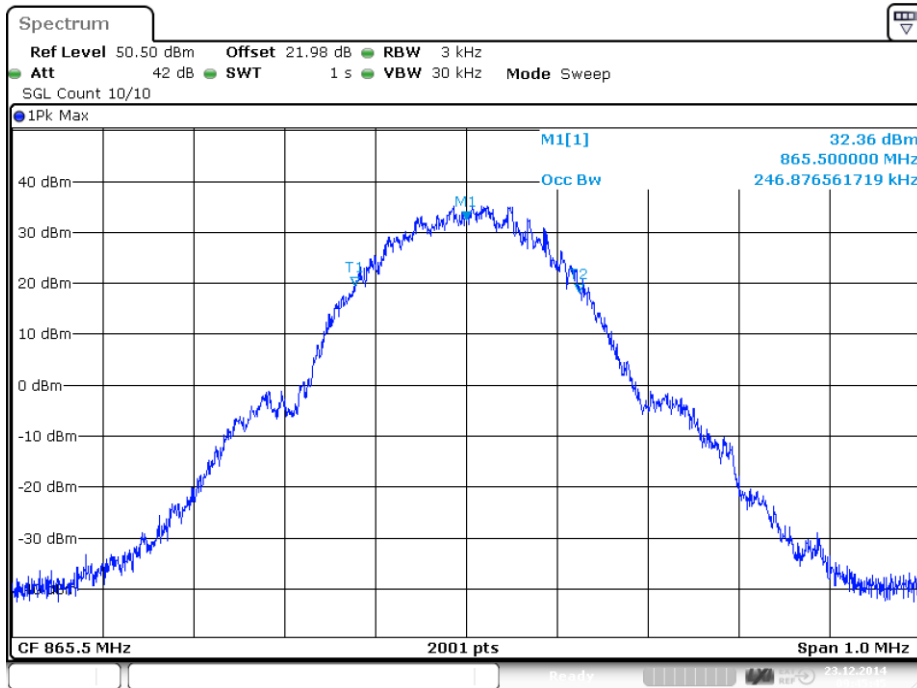

Date: 23.DEC.2014 09:45:45

plot 6.3.1.1-#1 Occupied Bandwidth: §90.210, §2.1049; Test results; Downlink; GSM Output

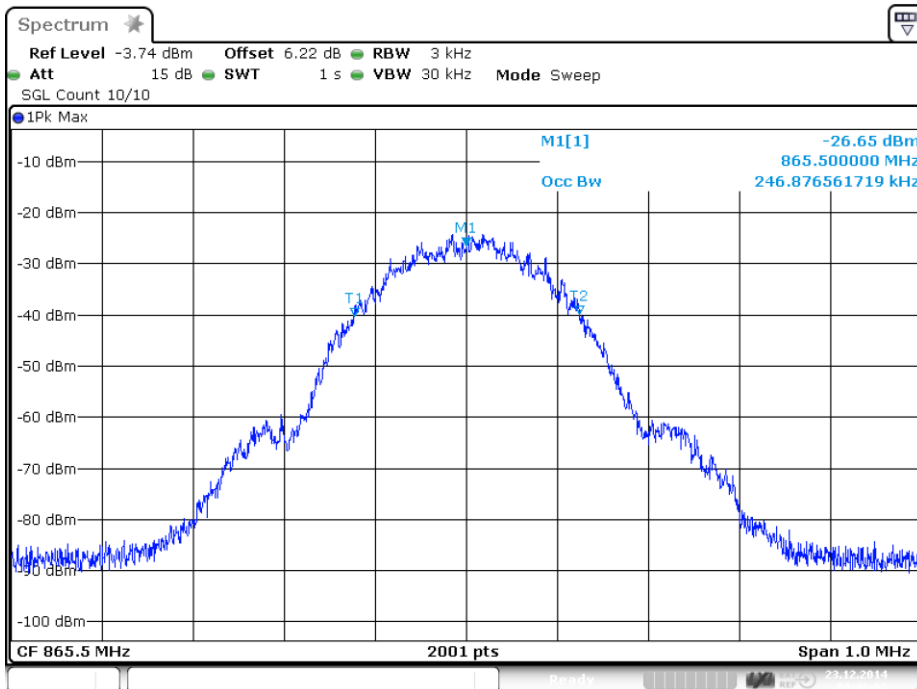

Date: 23.DEC.2014 09:48:02

plot 6.3.1.1-#2 Occupied Bandwidth: §90.210, §2.1049; Test results; Downlink; GSM Input



6.3.1.2 EDGE

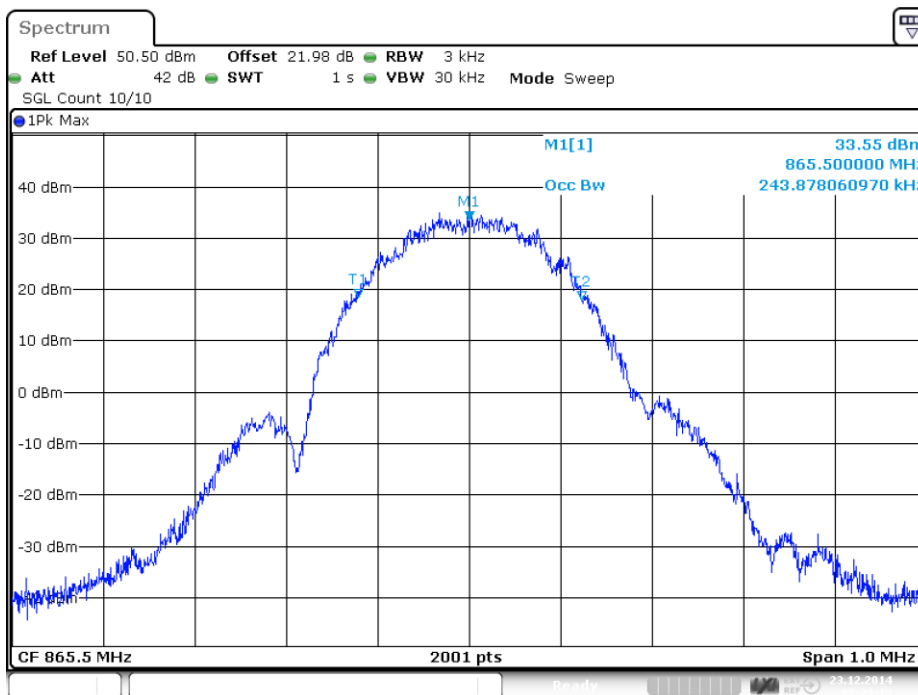

Date: 23.DEC.2014 08:23:12

plot 6.3.1.2-#1 Occupied Bandwidth: §90.210, §2.1049; Test results; Downlink; EDGE Output

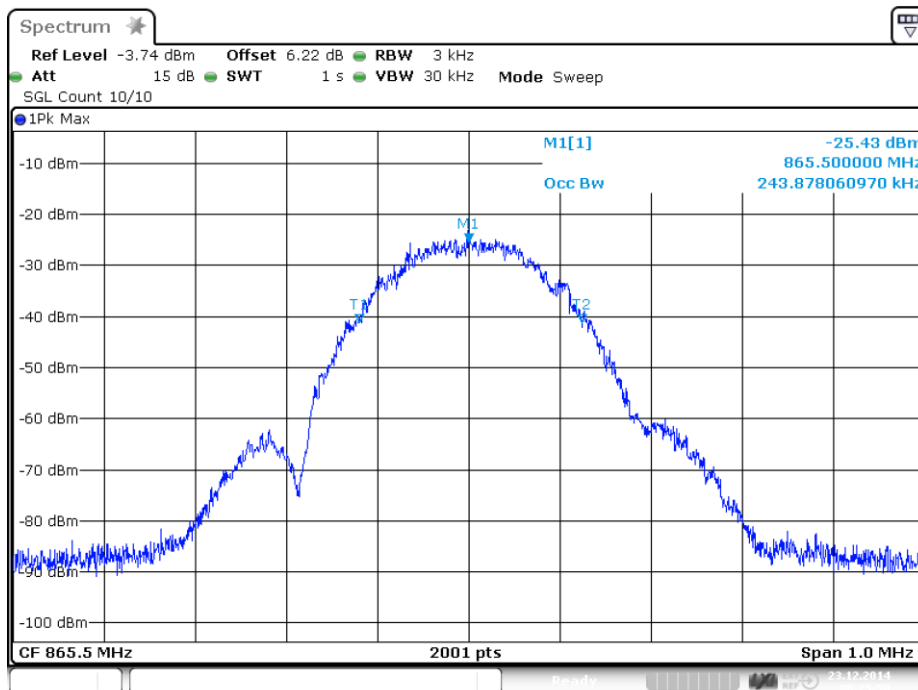

Date: 23.DEC.2014 08:25:50

plot 6.3.1.2-#2 Occupied Bandwidth: §90.210, §2.1049; Test results; Downlink; EDGE Input



6.3.1.3 CDMA

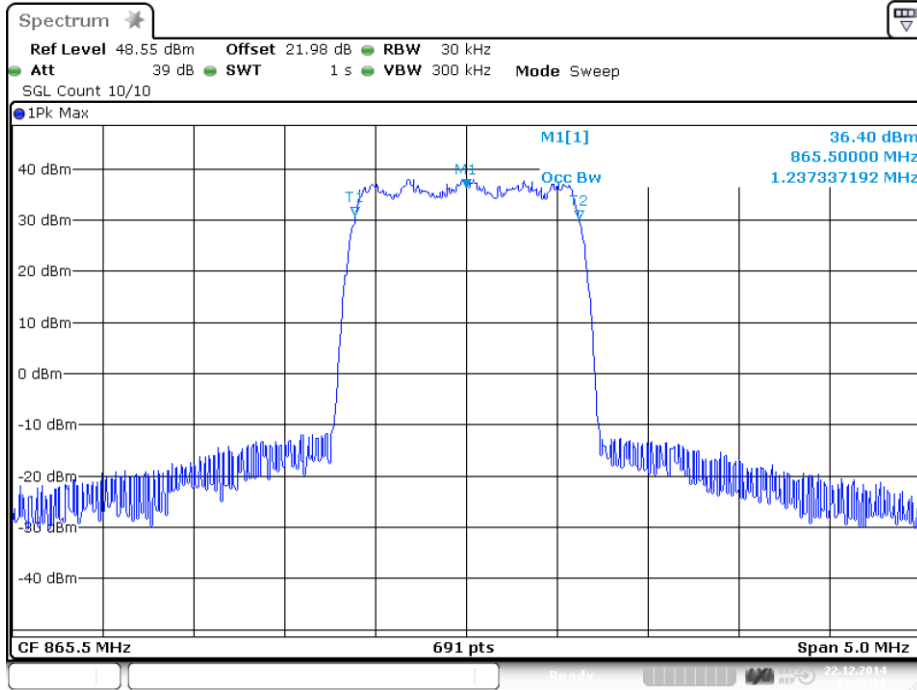

Date: 22.DEC.2014 13:28:39

plot 6.3.1.3-#1 Occupied Bandwidth: §90.210, §2.1049; Test results; Downlink; CDMA Output

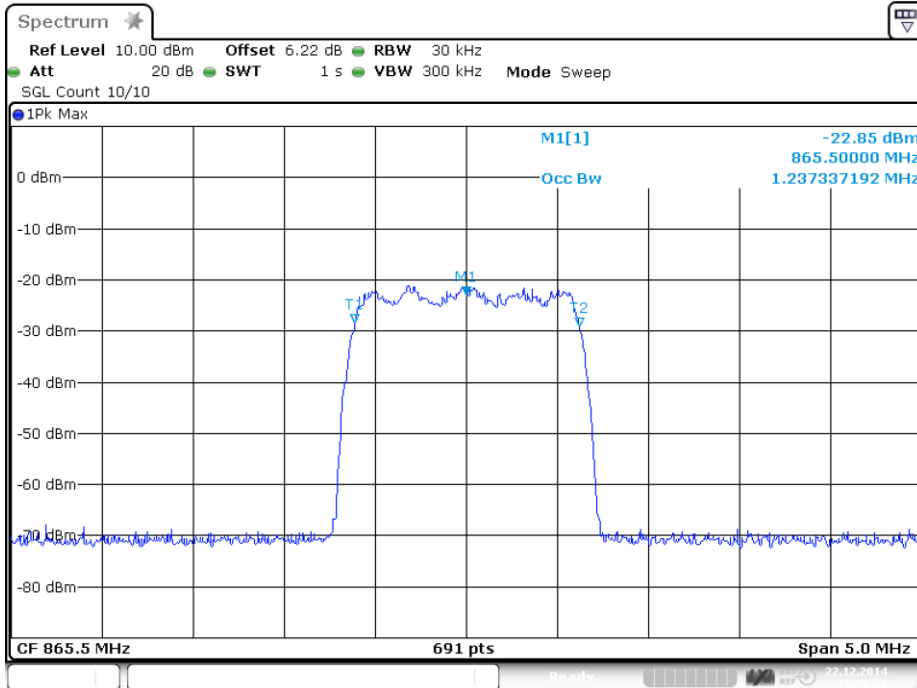

Date: 22.DEC.2014 13:39:26

plot 6.3.1.3-#2 Occupied Bandwidth: §90.210, §2.1049; Test results; Downlink; CDMA Input



6.3.1.4 WCDMA

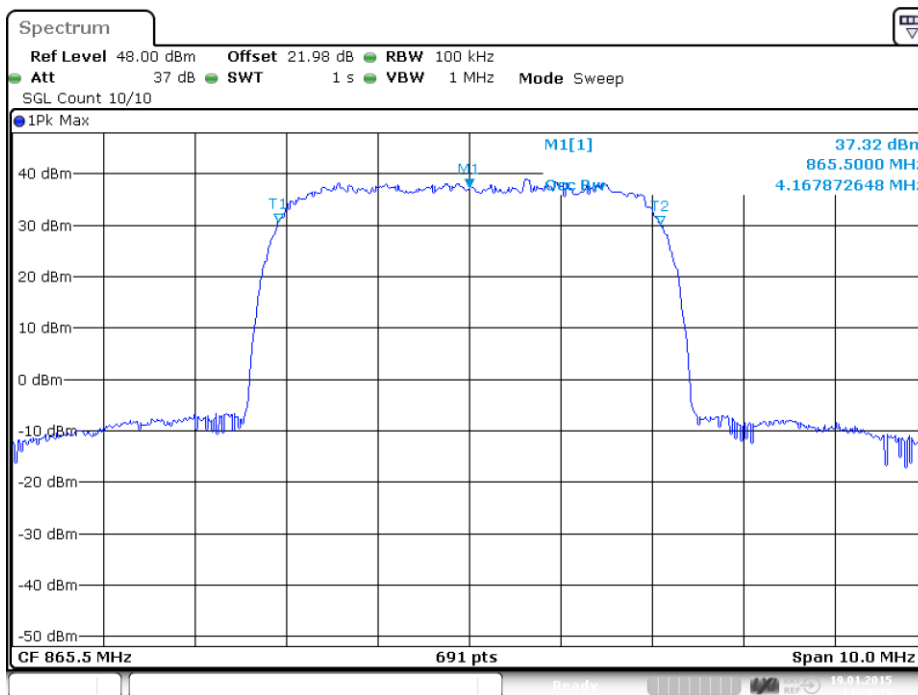

Date: 19.JAN.2015 14:29:35

plot 6.3.1.4-#1 Occupied Bandwidth: §90.210, §2.1049; Test results; Downlink; WCDMA Output

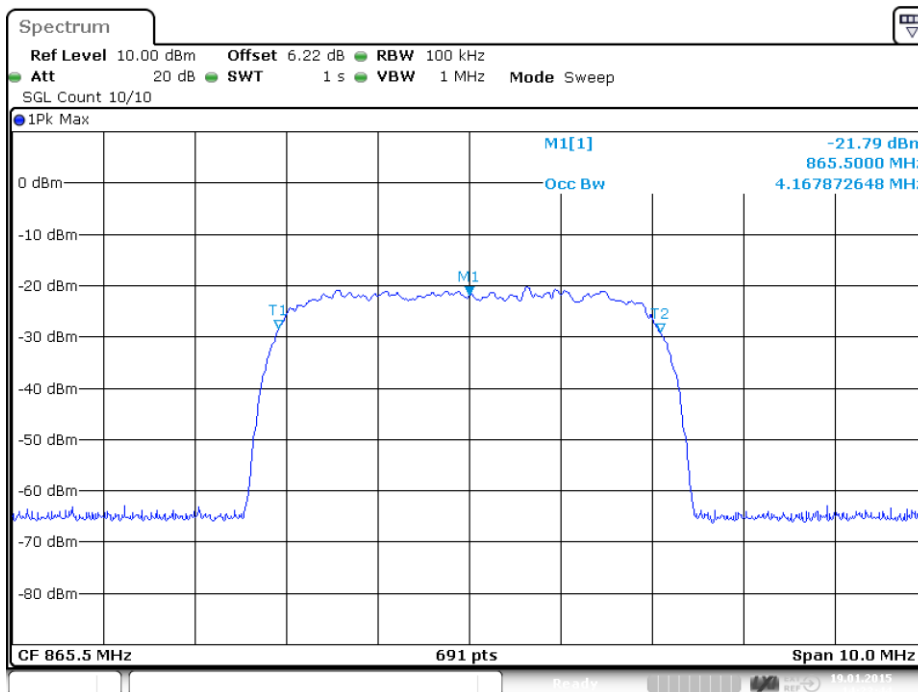

Date: 19.JAN.2015 14:23:45

plot 6.3.1.4-#2 Occupied Bandwidth: §90.210, §2.1049; Test results; Downlink; WCDMA Input



6.3.1.5 LTE

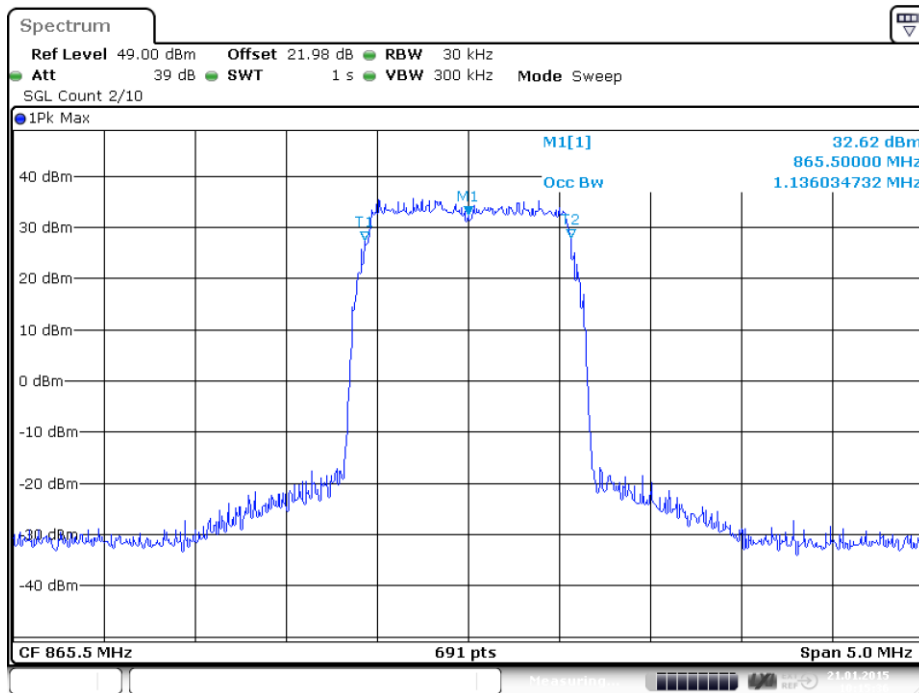

plot 6.3.1.5-#1 Occupied Bandwidth: \$90.210, \$2.1049; Test results; Downlink; LTE Output

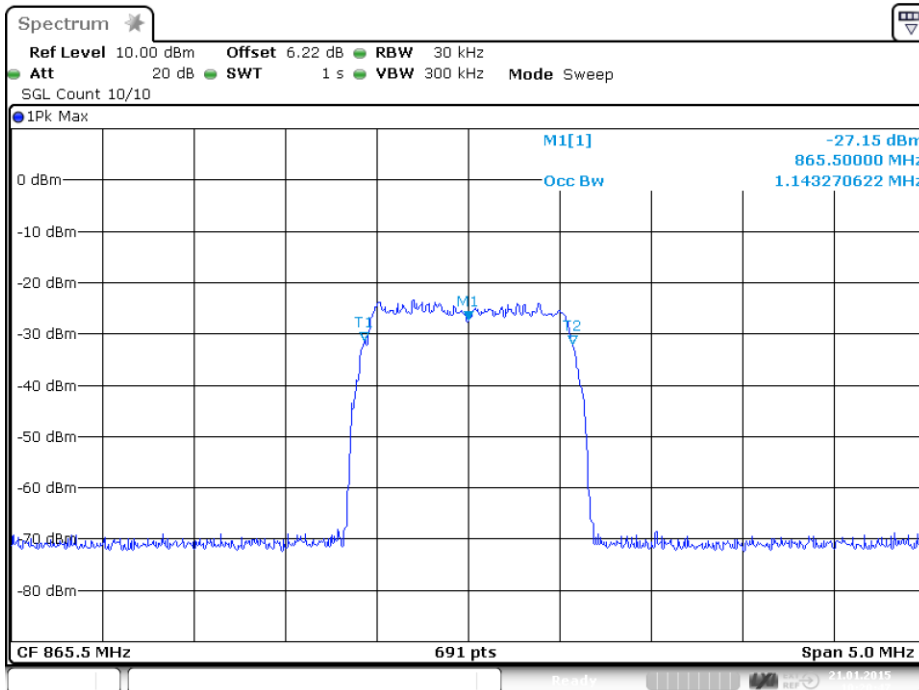

plot 6.3.1.5-#2 Occupied Bandwidth: \$90.210, \$2.1049; Test results; Downlink; LTE Input



6.3.2 26dB Bandwidth

6.3.2.1 GSM

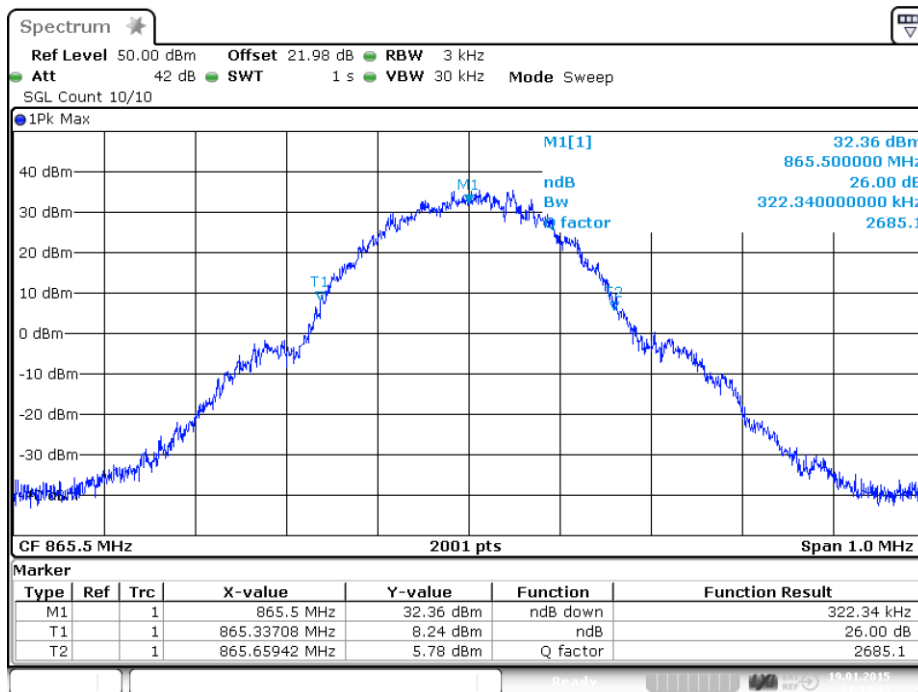

Date: 19.JAN.2015 14:44:44

plot 6.3.2.1-#1 Occupied Bandwidth: §90.210, §2.1049; Test results; 26dB Bandwidth; GSM Output

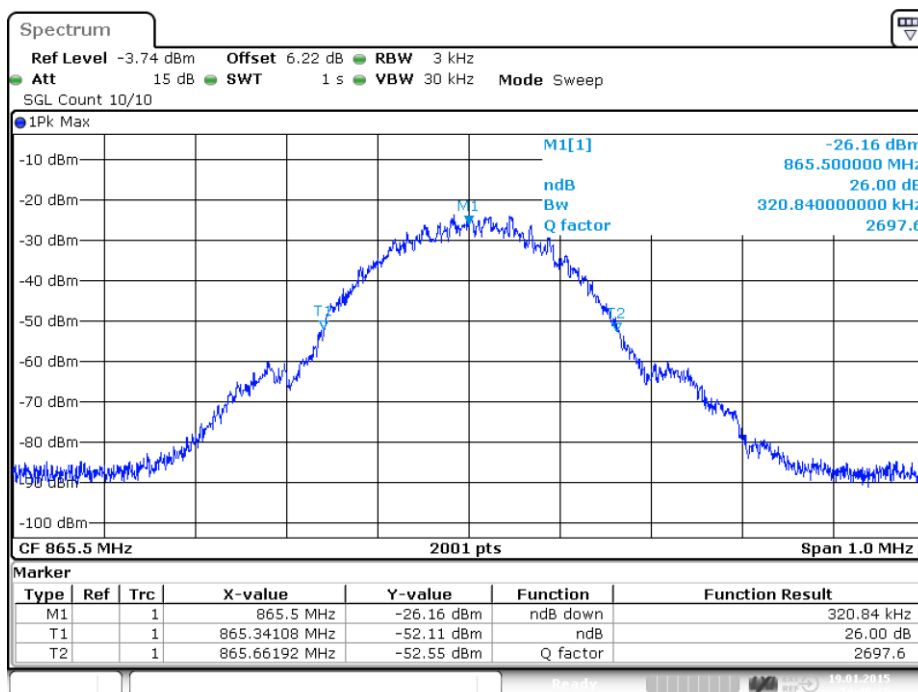

Date: 19.JAN.2015 14:46:16

plot 6.3.2.1-#2 Occupied Bandwidth: §90.210, §2.1049; Test results; 26dB Bandwidth; GSM Input



6.3.2.2 EDGE

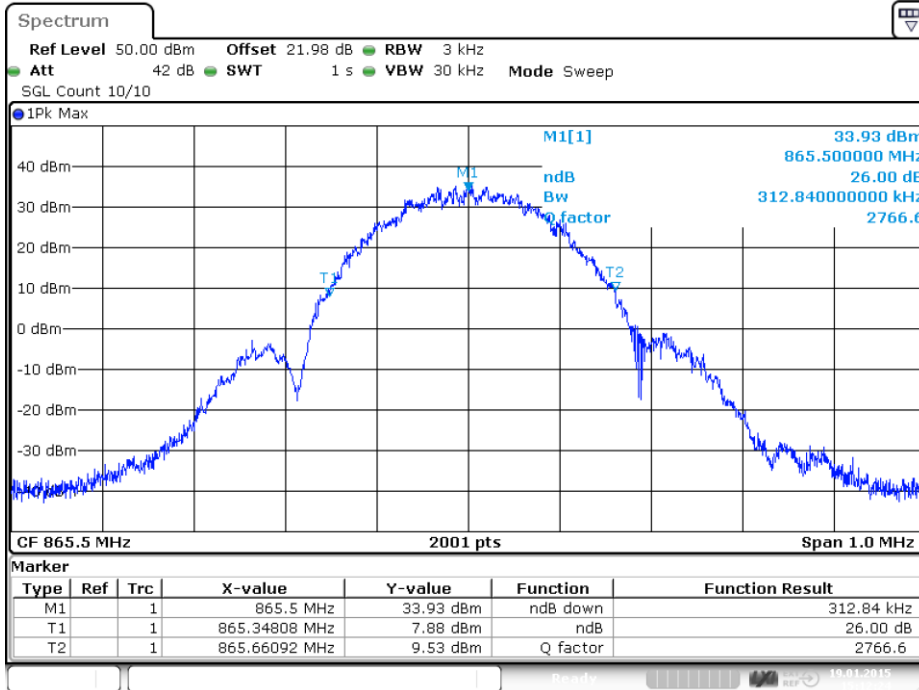

Date: 19.JAN.2015 15:12:25

plot 6.3.2.2-#1 Occupied Bandwidth: §90.210, §2.1049; Test results; 26dB Bandwidth; EDGE Output

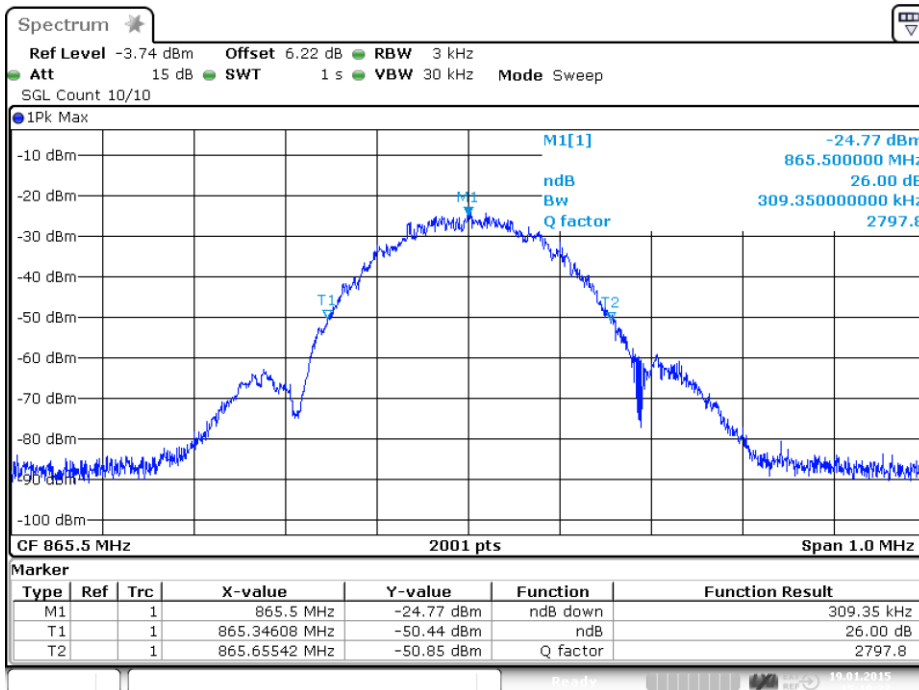

Date: 19.JAN.2015 15:10:23

plot 6.3.2.2-#2 Occupied Bandwidth: §90.210, §2.1049; Test results; 26dB Bandwidth; EDGE Input



6.3.2.3 CDMA

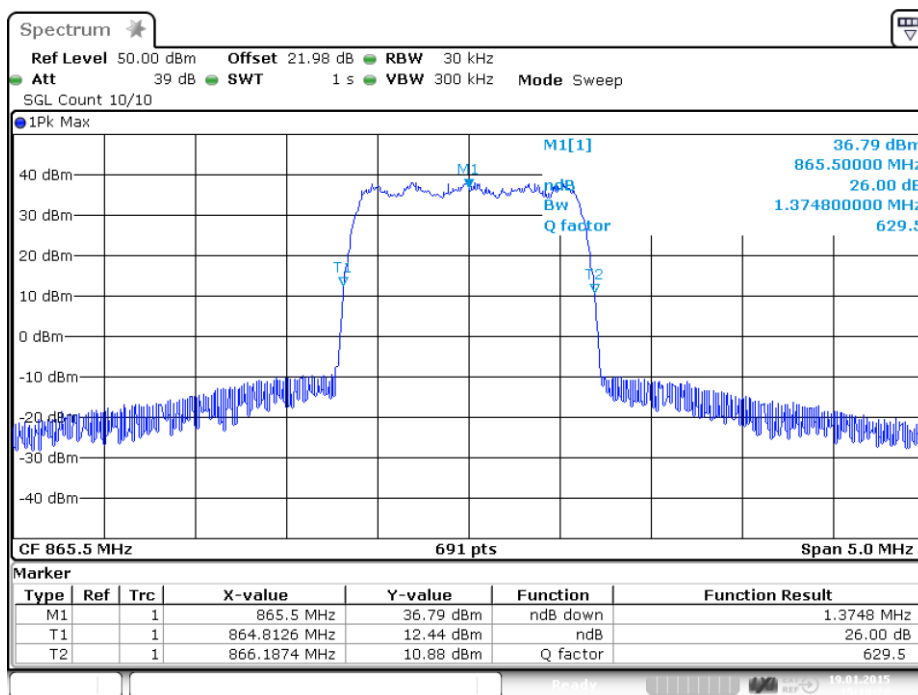

Date: 19.JAN.2015 15:18:23

plot 6.3.2.3-#1 Occupied Bandwidth: §90.210, §2.1049; Test results; 26dB Bandwidth; CDMA Output

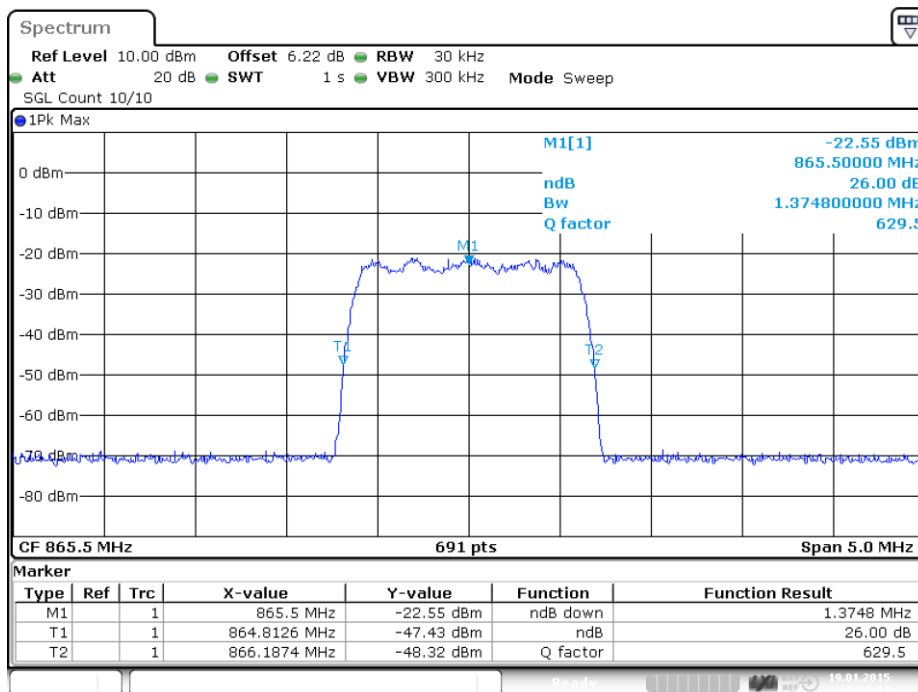

Date: 19.JAN.2015 15:20:01

plot 6.3.2.3-#2 Occupied Bandwidth: §90.210, §2.1049; Test results; 26dB Bandwidth; CDMA Input



6.3.2.4 WCDMA

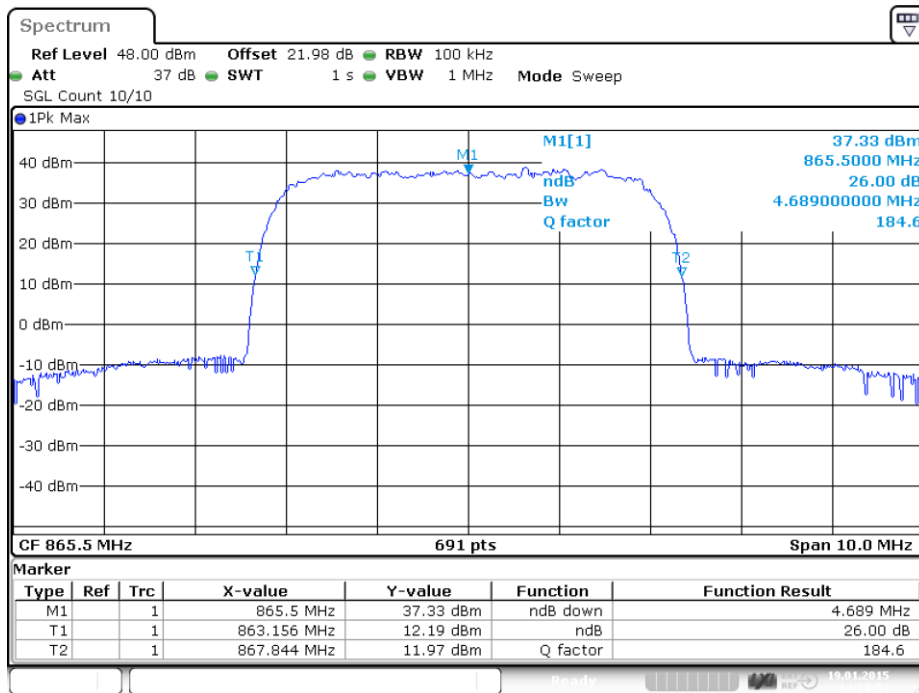

Date: 19.JAN.2015 14:28:52

plot 6.3.2.4-#1 Occupied Bandwidth: §90.210, §2.1049; Test results; 26dB Bandwidth; WCDMA Output

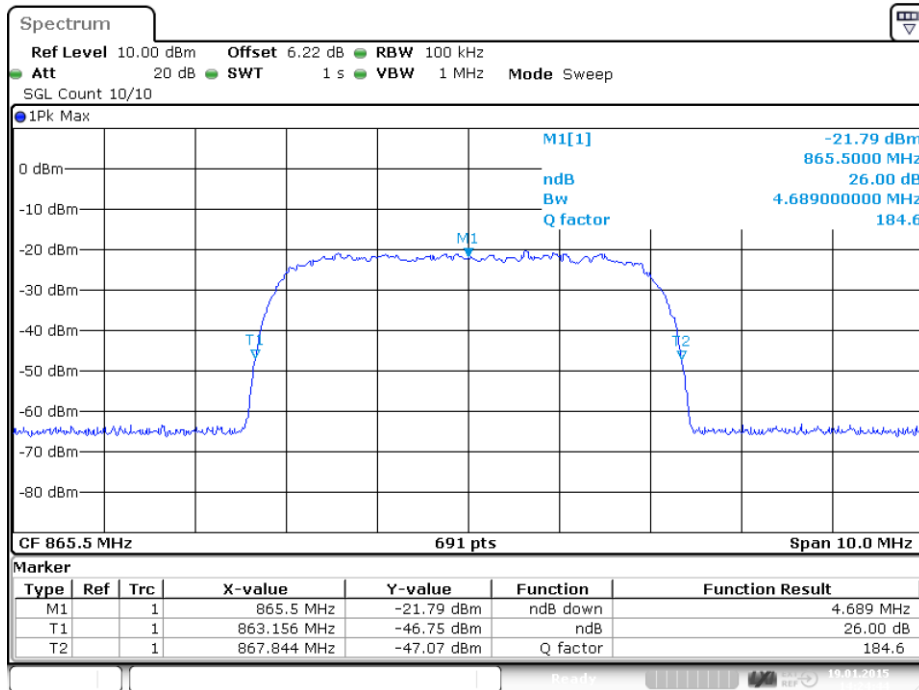

Date: 19.JAN.2015 14:24:45

plot 6.3.2.4-#2 Occupied Bandwidth: §90.210, §2.1049; Test results; 26dB Bandwidth; WCDMA Input



6.3.2.5 LTE

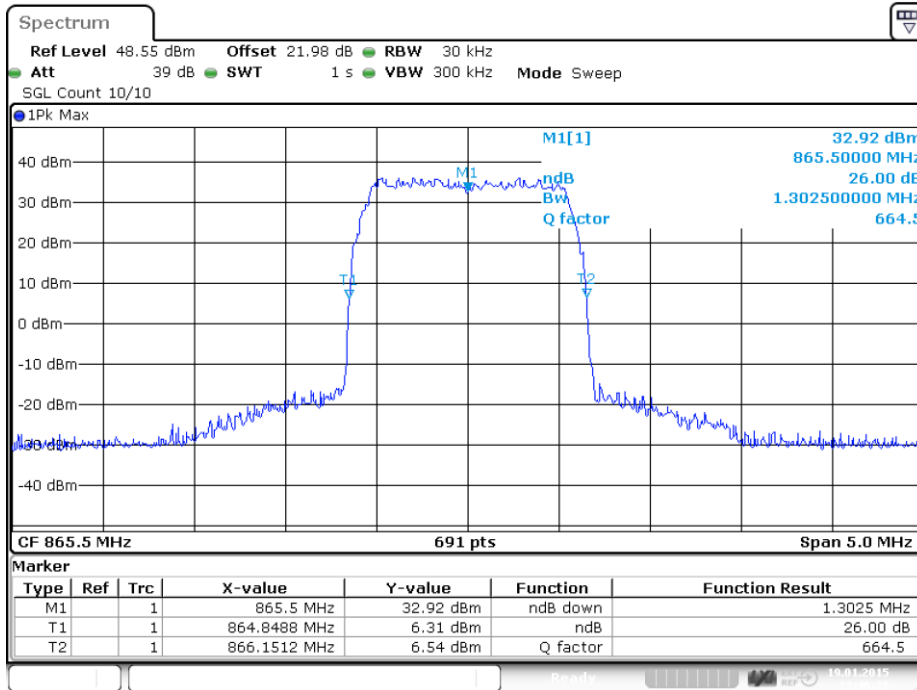

Date: 19.JAN.2015 13:46:29

plot 6.3.2.5-#1 Occupied Bandwidth: \$90.210, \$2.1049; Test results; 26dB Bandwidth; LTE Output

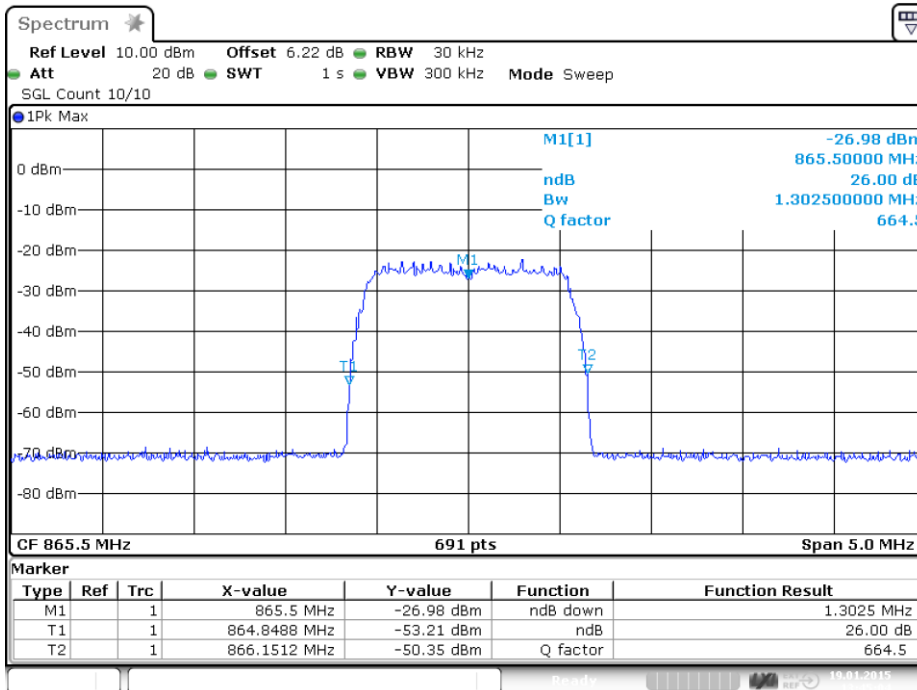

Date: 19.JAN.2015 13:45:05

plot 6.3.2.5-#2 Occupied Bandwidth: \$90.210, \$2.1049; Test results; 26dB Bandwidth; LTE Input

Test Report No.: 15-020

FCC ID: XS5-UH781719P



BUREAU
VERITAS

6.3.3 Uplink

n.a.

Note: The EUT does not transmit over the air in the uplink direction.

6.4 Summary test result

Test result	complies, according the plots above
Tested by:	F. Bengesser
Date:	21.01.2015



7 Spurious Emissions at Antenna Terminals: §90.210, §2.1051

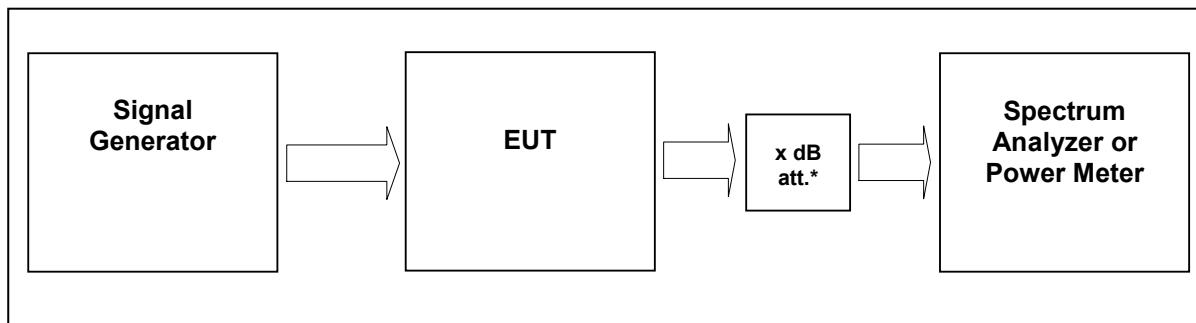

External Attenuator DL x dB = 20 dB
figure 7-#1 Test setup: Spurious Emissions at Antenna Terminals: §90.210, §2.1051

Measurement uncertainty	± 0,54 dB ± 1,2 dB ± 1,5 dB	9 kHz to 3 GHz 3 GHz to 7 GHz 7 GHz to 26 GHz
Test equipment used	9069, 9046, 9236, 7406, 7157, 7158, 7289, 7290, 7385	

7.1 Limit

MASK	Spurious Limit
A,B,C,G,H,I	-13dBm

7.2 Test method

Para. No 2.1051 Measurements required: Spurious emissions at antenna terminals.

The radio frequency voltage or powers generated within the equipment and appearing on a spurious frequency shall be checked at the equipment output terminals when properly loaded with a suitable artificial antenna. Curves or equivalent data shall show the magnitude of each harmonic and other spurious emission that can be detected when the equipment is operated under the conditions specified in § 2.1049 as appropriate. The magnitude of spurious emissions which are attenuated more than 20 dB below the permissible value need not be specified.

[39 FR 5919, Feb. 15, 1974. Redesignated and amended at 63 FR 36599, July 7, 1998]



7.3 Test results

7.3.1 Downlink

Detector: RMS.

Modulation	Carrier	RBW VBW Span	Max. level (dBm)	MIMO Max. level (dBm)	Plot -
GSM	865,5 MHz	1MHz 3MHz 30MHz – 10GHz	-27.8	-24.8	7.3.1.1 #1
EDGE	865,5 MHz	1MHz 3MHz 30MHz – 10GHz	-28.0	-25.8	7.3.1.2 #1
CDMA	865,5 MHz	1MHz 3MHz 30MHz – 10GHz	-27.7	-24.7	7.3.1.3 #1
WCDMA	865,5 MHz	1MHz 3MHz 30MHz – 10GHz	-27.1	-24.1	7.3.1.4 #1
LTE	865,5 MHz	1MHz 3MHz 30MHz – 10GHz	-28.1	-25.1	7.3.1.5 #1

table 7.3-#1 Spurious Emissions at Antenna Terminals: §90.210, §2.1051 Test results

If the DUT used in MIMO configuration according to KDB 662911, the summed emission (MIMO Max. Level) is calculated (Max. Level) of the output port plus $10 \log(N_{ANT})$. With ($N_{ANT}=2$) the MIMO Max. Level (dBm) equals Max. Level (dBm) plus 3dB.



7.3.1.1 GSM

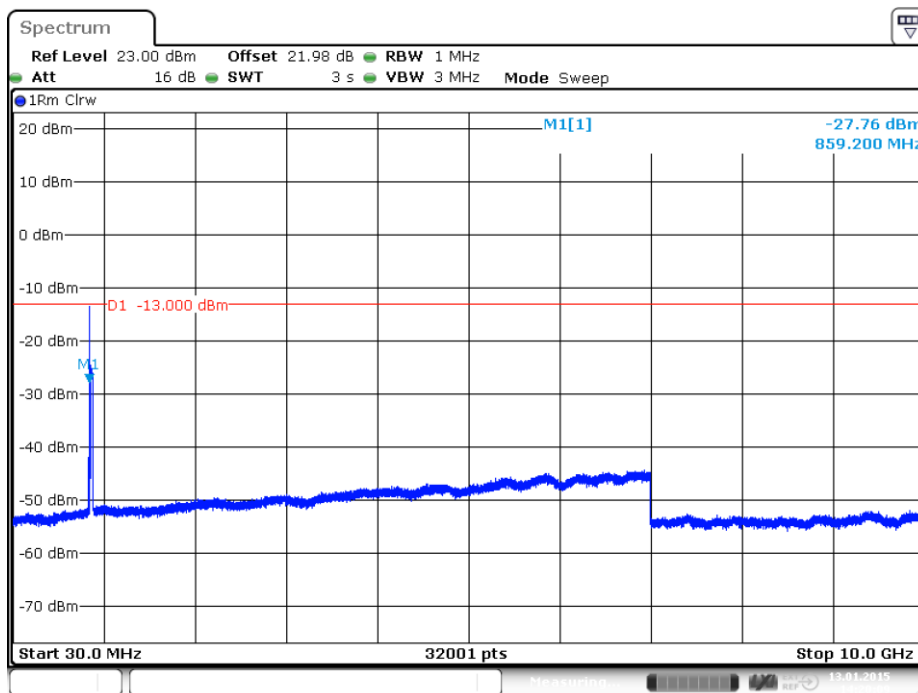

Date: 13.JAN.2015 14:20:10

plot 7.3.1.1-#1 Spurious Emissions at Antenna Terminals: §90.210, §2.1051; Test results; Downlink; GSM; carrier (865,5MHz) notched

7.3.1.2 EDGE

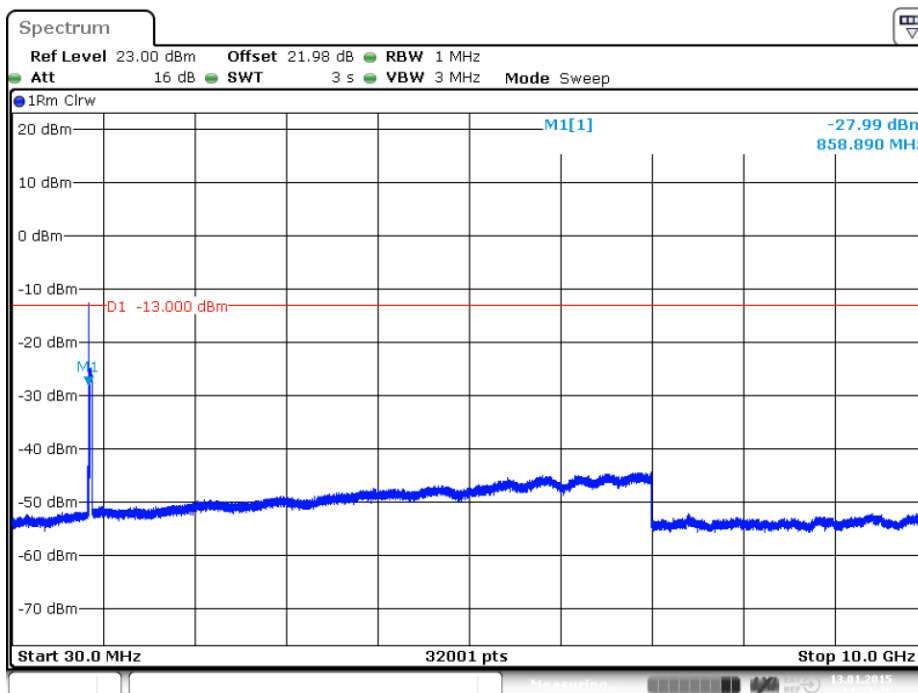

Date: 13.JAN.2015 14:21:36

plot 7.3.1.2-#1 Spurious Emissions at Antenna Terminals: §90.210, §2.1051; Test results; Downlink; EDGE; carrier (865,5MHz) notched



7.3.1.3 CDMA

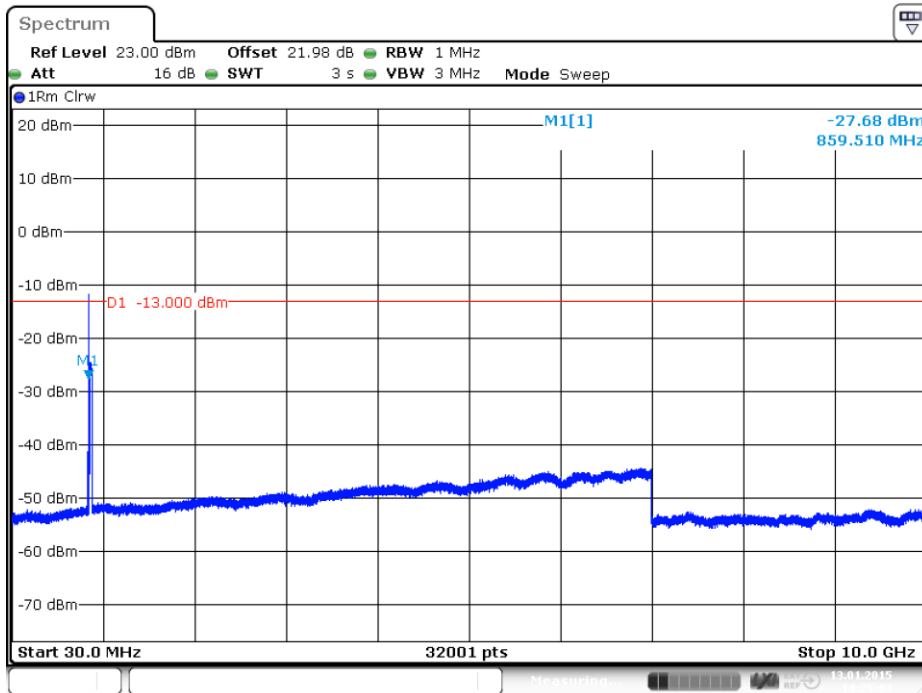

Date: 13.JAN.2015 14:25:05

plot 7.3.1.3-#1 Spurious Emissions at Antenna Terminals: §90.210, §2.1051; Test results; Downlink; CDMA; carrier (865,5MHz) notched

7.3.1.4 WCDMA

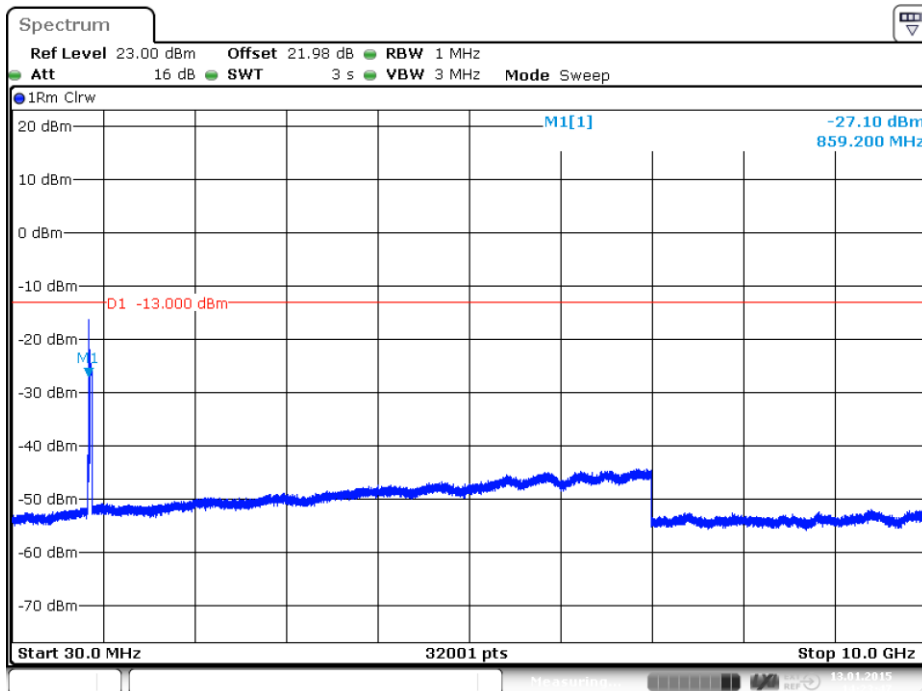

Date: 13.JAN.2015 14:23:48

plot 7.3.1.4-#1 Spurious Emissions at Antenna Terminals: §90.210, §2.1051; Test results; Downlink; WCDMA; carrier (865,5MHz) notched



7.3.1.5 LTE

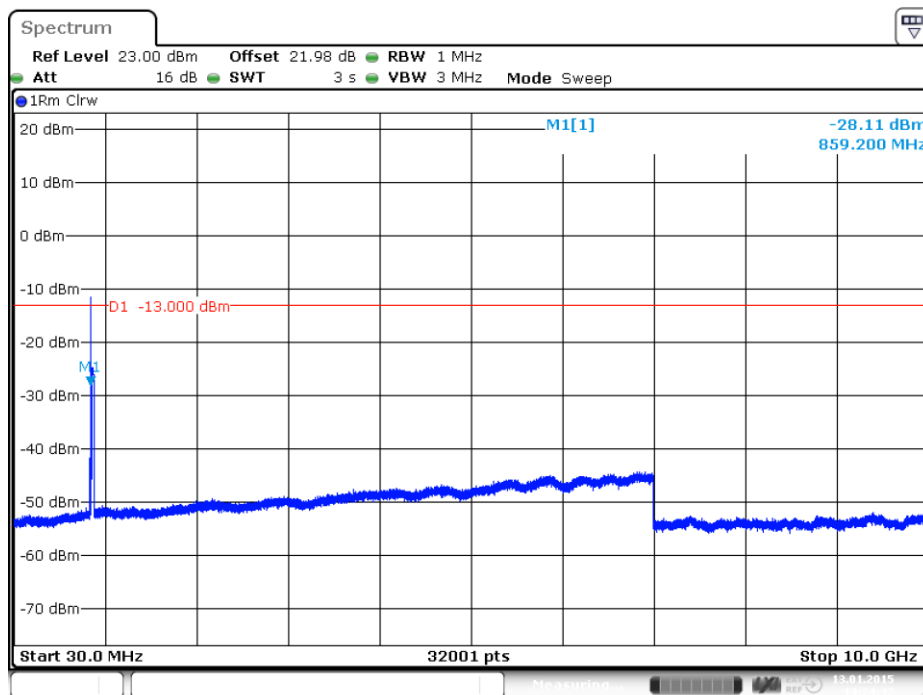

Date: 13.JAN.2015 14:24:33

plot 7.3.1.5-#1 Spurious Emissions at Antenna Terminals: §90.210, §2.1051; Test results; Downlink; LTE; carrier (865,5MHz) notched

7.3.2 Uplink

n.a.

Note: The EUT does not transmit over the air in the uplink direction.

7.4 Summary test result

Test result	complies, according the plots above
Tested by:	F. Bengesser
Date:	13.01.2015



8 Intermodulation: §90.691, §2.1051

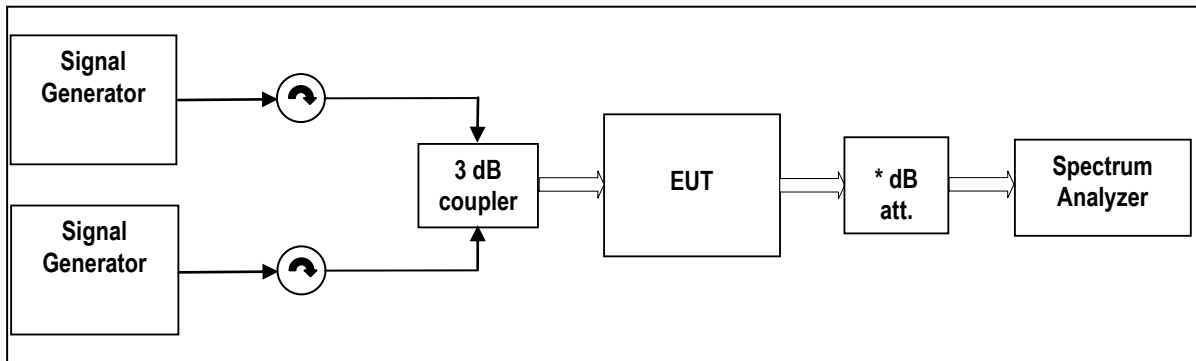

External Attenuator DL x dB = 20 dB
figure 8-#1 Test setup: Intermodulation: §90.691, §2.1051

Measurement uncertainty	± 0,54 dB ± 1,2 dB ± 1,5 dB	9 kHz to 3 GHz 3 GHz to 7 GHz 7 GHz to 26 GHz
Test equipment used	9069, 9046, 9236, 7406, 7157, 7158, 7289, 7290, 7385	

8.1 Limit

MASK	Spurious Limit
A,B,C,G,H,I	-13dBm

8.2 Test method

Para. No 2.1051 Measurements required: Spurious emissions at antenna terminals.

The radio frequency voltage or powers generated within the equipment and appearing on a spurious frequency shall be checked at the equipment output terminals when properly loaded with a suitable artificial antenna. Curves or equivalent data shall show the magnitude of each harmonic and other spurious emission that can be detected when the equipment is operated under the conditions specified in § 2.1049 as appropriate. The magnitude of spurious emissions which are attenuated more than 20 dB below the permissible value need not be specified.

[39 FR 5919, Feb. 15, 1974. Redesignated and amended at 63 FR 36599, July 7, 1998]



8.3 Test results

8.3.1 Downlink

Detector: RMS.

Modulation	Measured at Band Edge	Carriers	RBW VBW Span	Max. level (dBm)	MIMO Max. level (dBm)	Plot -
GSM	Lower Edge	862.4 MHz 862.6 MHz	3kHz 30kHz 2MHz	-39.3	-36.3	8.3.1.1 #1
	Upper Edge	868.4 MHz 868.6 MHz				#2
EDGE	Lower Edge	862.4 MHz 862.6 MHz	3kHz 30kHz 2MHz	-39.1	-36.1	8.3.1.2 #1
	Upper Edge	868.4 MHz 868.6 MHz				#2
CDMA	Lower Edge	862.775 MHz 864.025 MHz	30kHz 300kHz 6MHz	-31.3	-28.3	8.3.1.3 #1
	Upper Edge	866.975 MHz 868.225 MHz				#2
WCDMA	Lower Edge	864.6 MHz 869.6 MHz	100kHz 1MHz 15MHz	-28.4	-25.4	8.3.1.4 #1
	Upper Edge	861.4 MHz 866.4 MHz				#2
LTE	Lower Edge	862.7 MHz 864.1 MHz	30kHz 300kHz 6MHz	-31.5	-28.5	8.3.1.5 #1
	Upper Edge	866.9 MHz 868.3 MHz				#2

table 8.3-#1 Intermodulation: §90.691, §2.1051 Test results



8.3.1.1 GSM

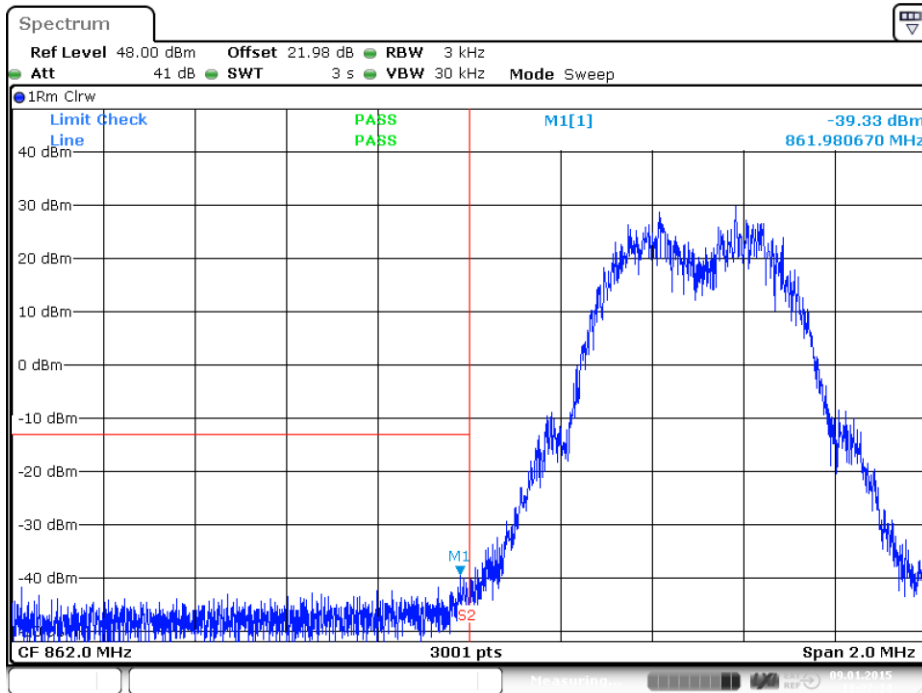

Date: 9.JAN.2015 11:32:34

plot 8.3.1.1-#1 Intermodulation: §90.691, §2.1051; Test results; Downlink; GSM Lower Band Edge

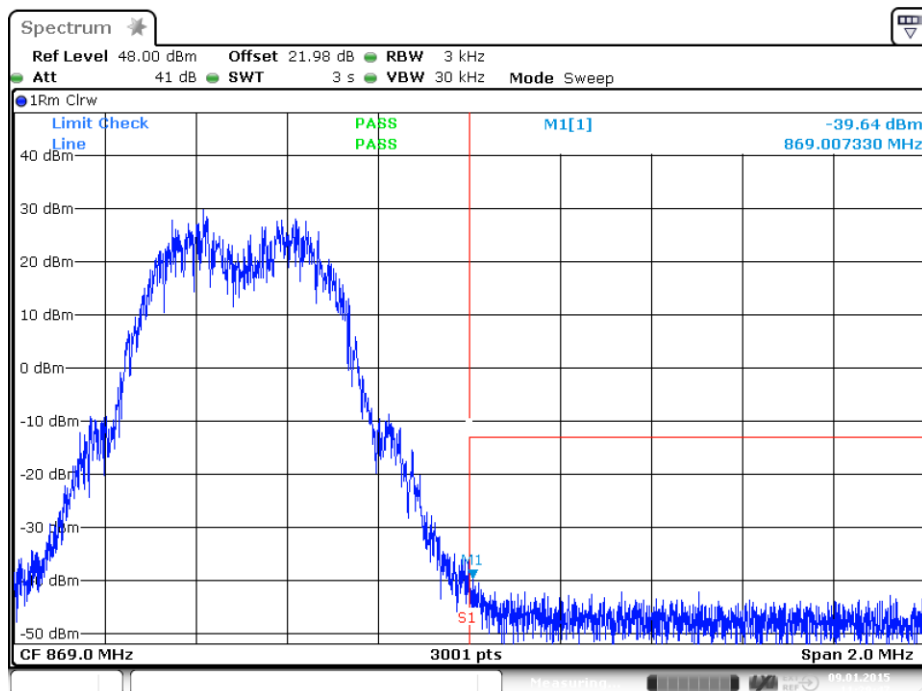

Date: 9.JAN.2015 11:29:47

plot 8.3.1.1-#2 Intermodulation: §90.691, §2.1051; Test results; Downlink; GSM Upper Band Edge



8.3.1.2 EDGE

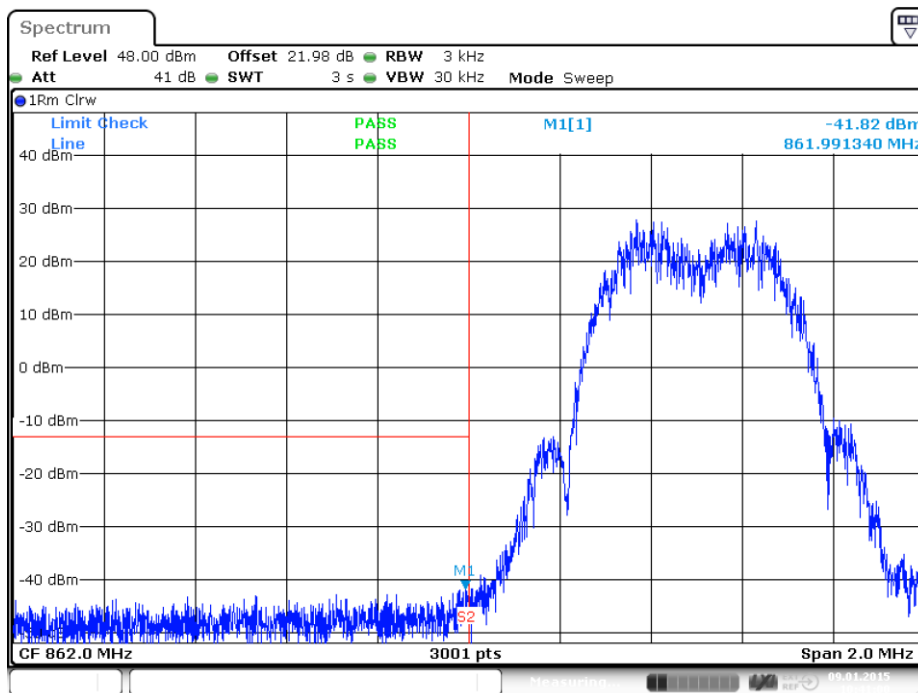

Date: 9.JAN.2015 10:41:00

plot 8.3.1.2-#1 Intermodulation: §90.691, §2.1051; Test results; Downlink; EDGE Lower Band Edge

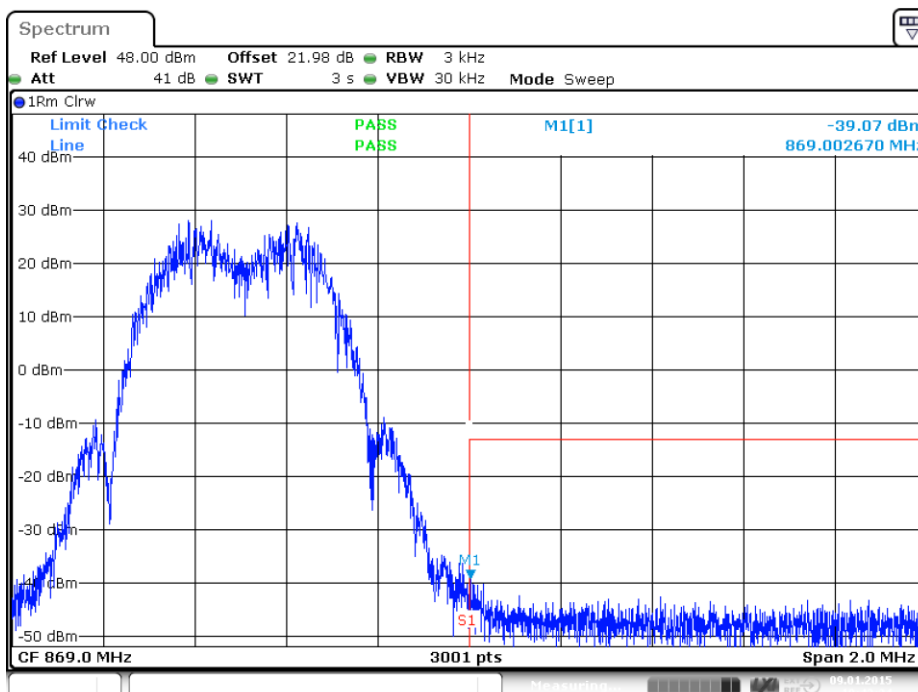

Date: 9.JAN.2015 10:43:24

plot 8.3.1.2-#2 Intermodulation: §90.691, §2.1051; Test results; Downlink; EDGE Upper Band Edge



8.3.1.3 CDMA

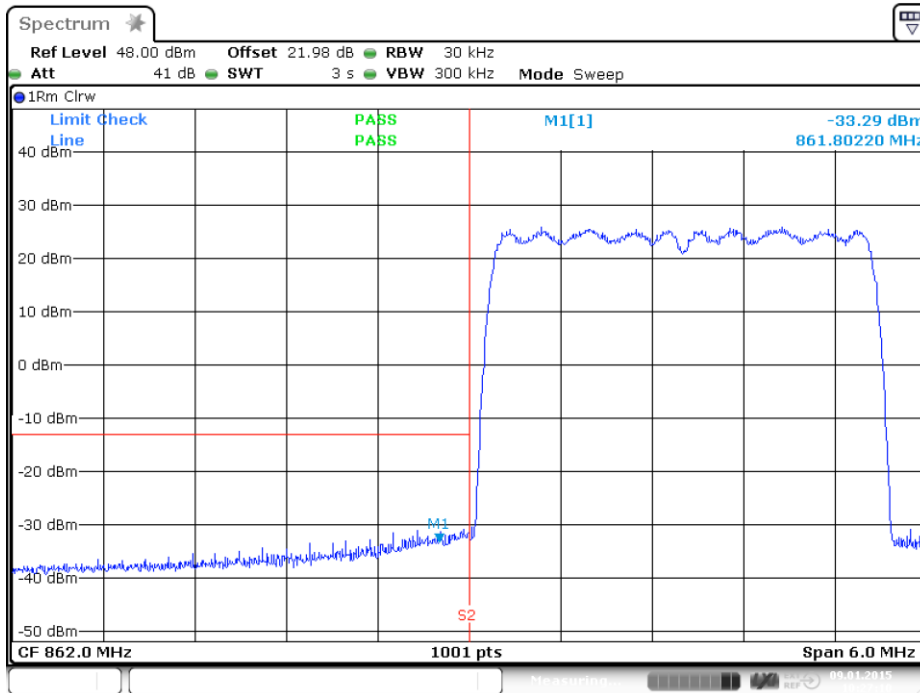

Date: 9.JAN.2015 10:27:10

plot 8.3.1.3-#1 Intermodulation: §90.691, §2.1051; Test results; Downlink; CDMA Lower Band Edge

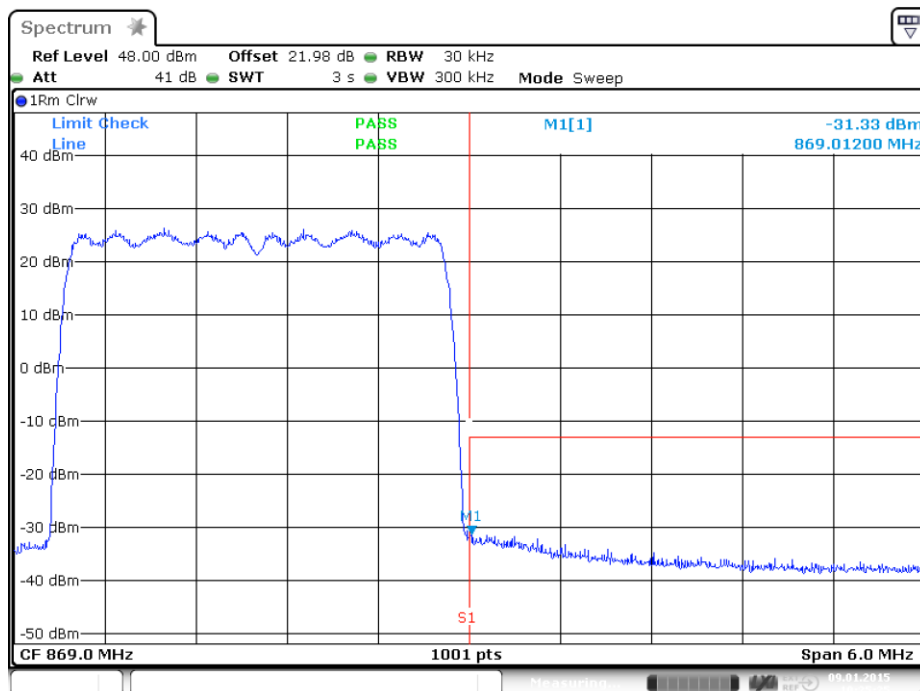

Date: 9.JAN.2015 10:25:25

plot 8.3.1.3-#2 Intermodulation: §90.691, §2.1051; Test results; Downlink; CDMA Upper Band Edge



8.3.1.4 WCDMA

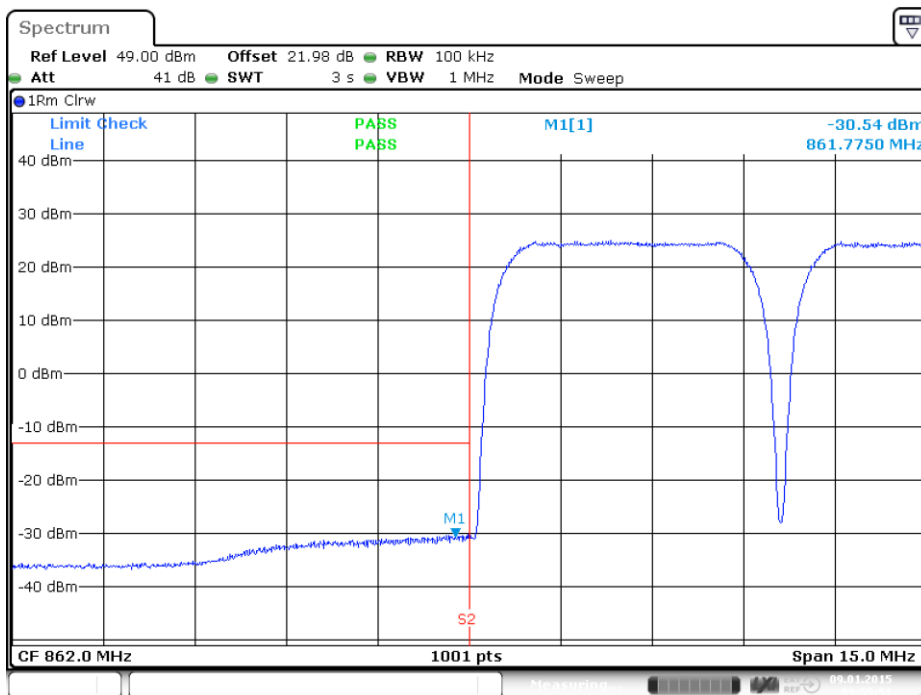

Date: 9.JAN.2015 09:55:51

plot 8.3.1.4-#1 Intermodulation: §90.691, §2.1051; Test results; Downlink; WCDMA Lower Band Edge

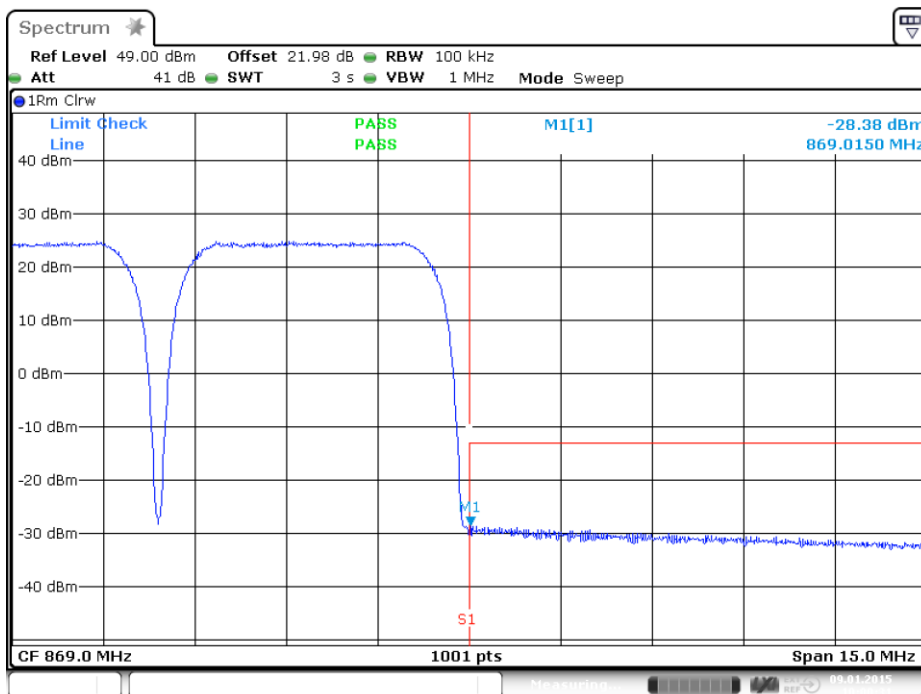

Date: 9.JAN.2015 10:00:31

plot 8.3.1.4-#2 Intermodulation: §90.691, §2.1051; Test results; Downlink; WCDMA Upper Band Edge



8.3.1.5 LTE

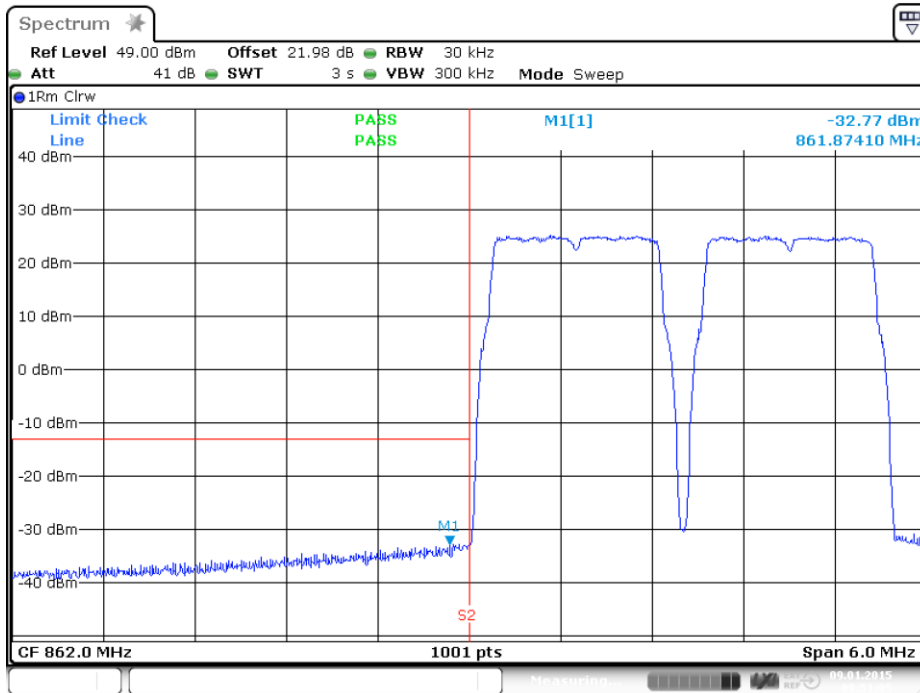

Date: 9.JAN.2015 09:51:05

plot 8.3.1.5-#1 Intermodulation: §90.691, §2.1051; Test results; Downlink; LTE Lower Band Edge

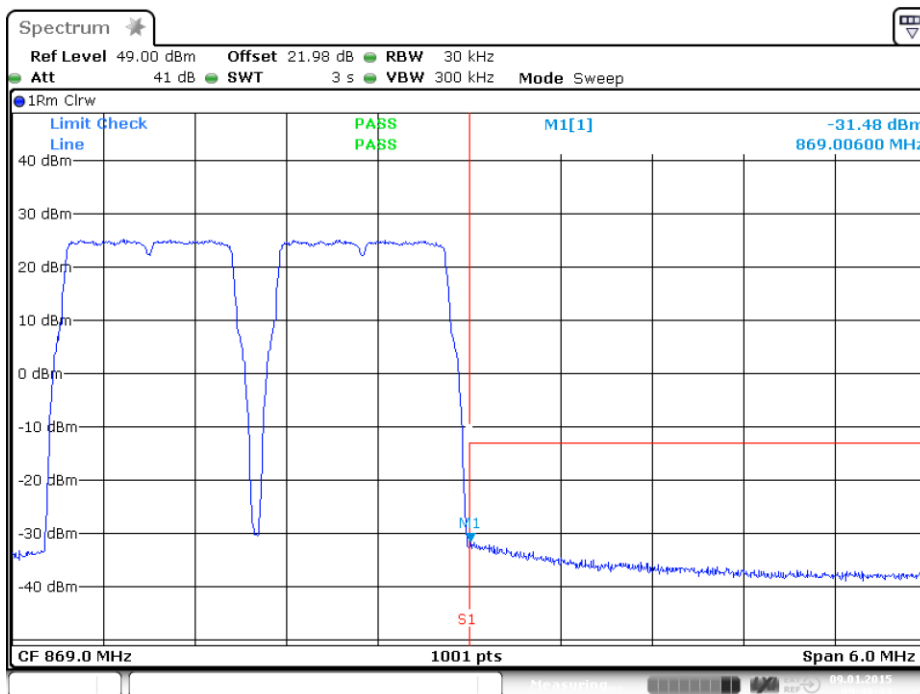

Date: 9.JAN.2015 09:48:33

plot 8.3.1.5-#2 Intermodulation: §90.691, §2.1051; Test results; Downlink; LTE Upper Band Edge

Test Report No.: 15-020

FCC ID: XS5-UH781719P



BUREAU
VERITAS

8.3.2 Uplink

n.a.

Note: The EUT does not transmit over the air in the uplink direction.

8.4 Summary test result

Test result	complies, according the plots above
Tested by:	F. Bengesser
Date:	09.01.2015



9 Emission Mask: §90.691, §2.1051

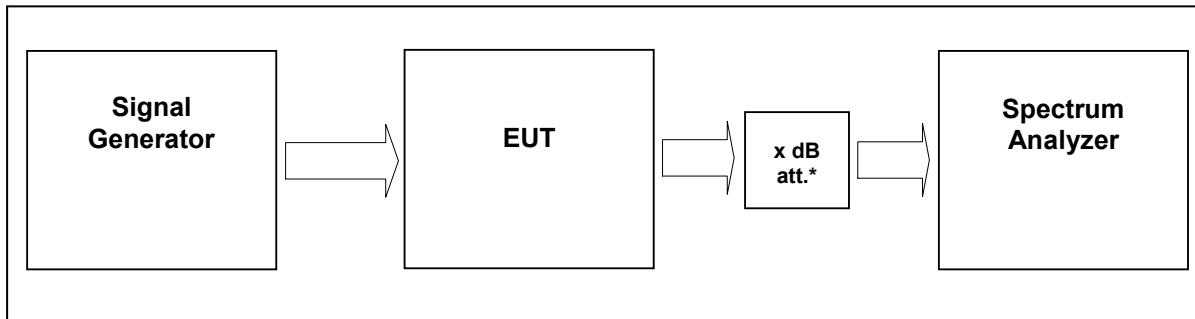

External Attenuator DL x dB = 20 dB
figure 9-#1 Test setup: Emission Mask: §90.691, §2.1051

Measurement uncertainty	± 0,54 dB ± 1,2 dB ± 1,5 dB	9 kHz to 3 GHz 3 GHz to 7 GHz 7 GHz to 26 GHz
Test equipment used	9069, 9046, 9236, 7406, 7157, 7158, 7289, 7290, 7385	

9.1 Limit

§90.691 Emission mask requirements for EA-based systems.

(a) Out-of-band emission requirement shall apply only to the “outer” channels included in an EA license and to spectrum adjacent to interior channels used by incumbent licensees. The emission limits are as follows:

(1) For any frequency removed from the EA licensee's frequency block by up to and including 37.5 kHz, the power of any emission shall be attenuated below the transmitter power (P) in watts by at least $116 \text{ Log}_{10}(f/6.1)$ decibels or $50 + 10 \text{ Log}_{10}(P)$ decibels or 80 decibels, whichever is the lesser attenuation, where f is the frequency removed from the center of the outer channel in the block in kilohertz and where f is greater than 12.5 kHz.

(2) For any frequency removed from the EA licensee's frequency block greater than 37.5 kHz, the power of any emission shall be attenuated below the transmitter power (P) in watts by at least $43 + 10 \text{ Log}_{10}(P)$ decibels or 80 decibels, whichever is the lesser attenuation, where f is the frequency removed from the center of the outer channel in the block in kilohertz and where f is greater than 37.5 kHz.

(b) When an emission outside of the authorized bandwidth causes harmful interference, the Commission may, at its discretion, require greater attenuation than specified in this section.



9.2 Test method

Para. No 2.1051 Measurements required: Spurious emissions at antenna terminals.

The radio frequency voltage or powers generated within the equipment and appearing on a spurious frequency shall be checked at the equipment output terminals when properly loaded with a suitable artificial antenna. Curves or equivalent data shall show the magnitude of each harmonic and other spurious emission that can be detected when the equipment is operated under the conditions specified in § 2.1049 as appropriate. The magnitude of spurious emissions which are attenuated more than 20 dB below the permissible value need not be specified.

[39 FR 5919, Feb. 15, 1974. Redesignated and amended at 63 FR 36599, July 7, 1998]

9.3 Test results

9.3.1 Downlink

>1MHz from Band Edge

Detector: RMS

Modulation	Measured at Band Edge	Carriers	RBW VBW Span	Max. level (dBm)	MIMO Max. level (dBm)	Plot -
GSM	Lower Edge	862.4 MHz	3kHz 30kHz 2MHz	-39.3	-36.3	9.3.1.1 #1
	Upper Edge	868.6 MHz				#2
EDGE	Lower Edge	862.4 MHz	3kHz 30kHz 2MHz	-39.1	-36.1	9.3.1.2 #1
	Upper Edge	868.6 MHz				#2
CDMA	Lower Edge	862.775 MHz	30kHz 300kHz 6MHz	-31.3	-28.3	9.3.1.3 #1
	Upper Edge	868.225 MHz				#2
WCDMA	Lower Edge	864.6 MHz	100kHz 1MHz 15MHz	-28.4	-25.4	9.3.1.4 #1
	Upper Edge	866.4 MHz				#2
LTE	Lower Edge	862.7 MHz	30kHz 300kHz 6MHz	-31.5	-28.5	9.3.1.5 #1
	Upper Edge	868.3 MHz				#2

table 9.3-#1 Emission Mask: §90.691, §2.1051 Test results <1MHz from Band Edge



9.3.1.1 GSM < 1MHz to band edge

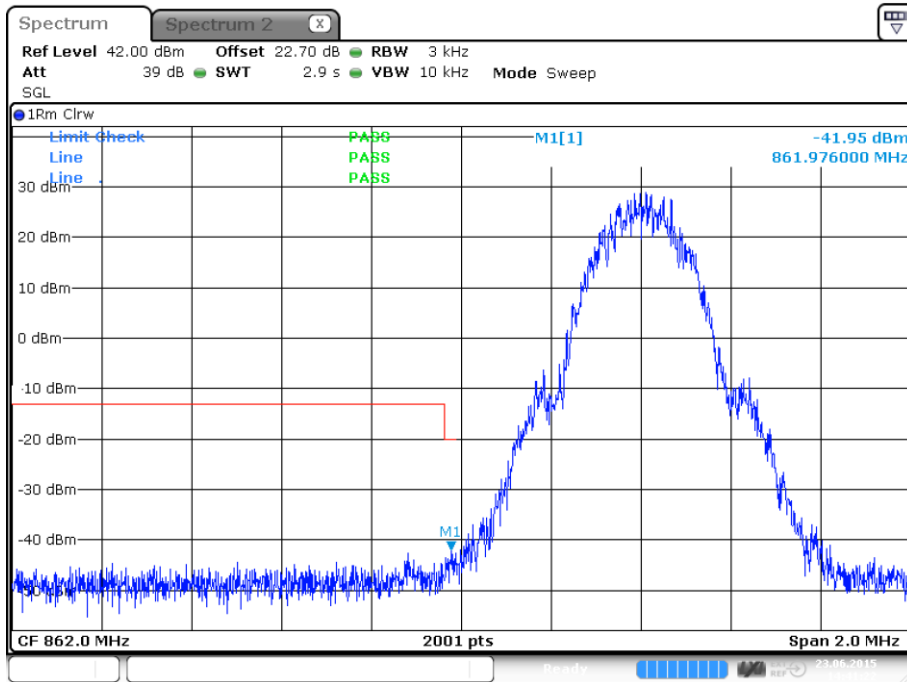

Date: 23 JUN 2015 14:41:22

plot 9.3.1.1-#1 Emission Mask: §90.691, §2.1051; Test results; Downlink; GSM < 1MHz to band edge Lower Band Edge

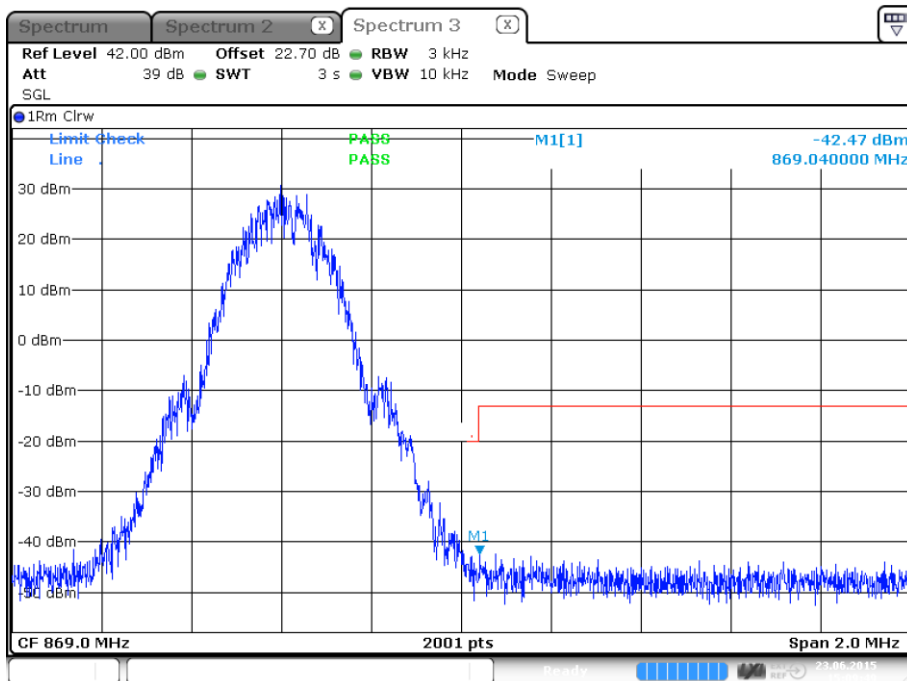

Date: 23 JUN 2015 15:09:49

plot 9.3.1.1-#2 Emission Mask: §90.691, §2.1051; Test results; Downlink; GSM < 1MHz to band edge Upper Band Edge



9.3.1.2 EDGE < 1MHz to band edge

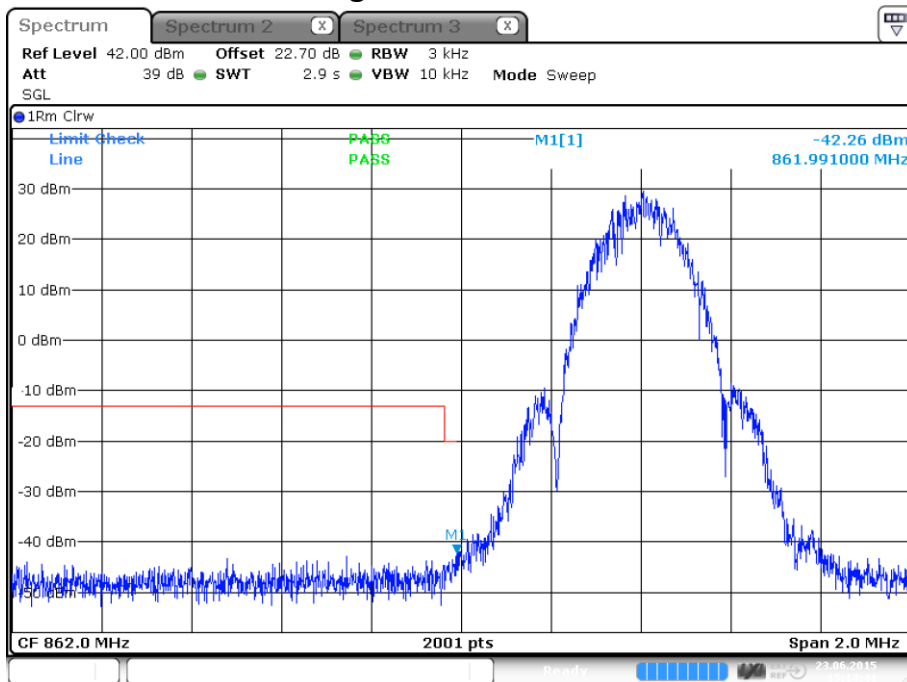

plot 9.3.1.2-#1 Emission Mask: §90.691, §2.1051; Test results; Downlink; EDGE < 1MHz to band edge Lower Band Edge

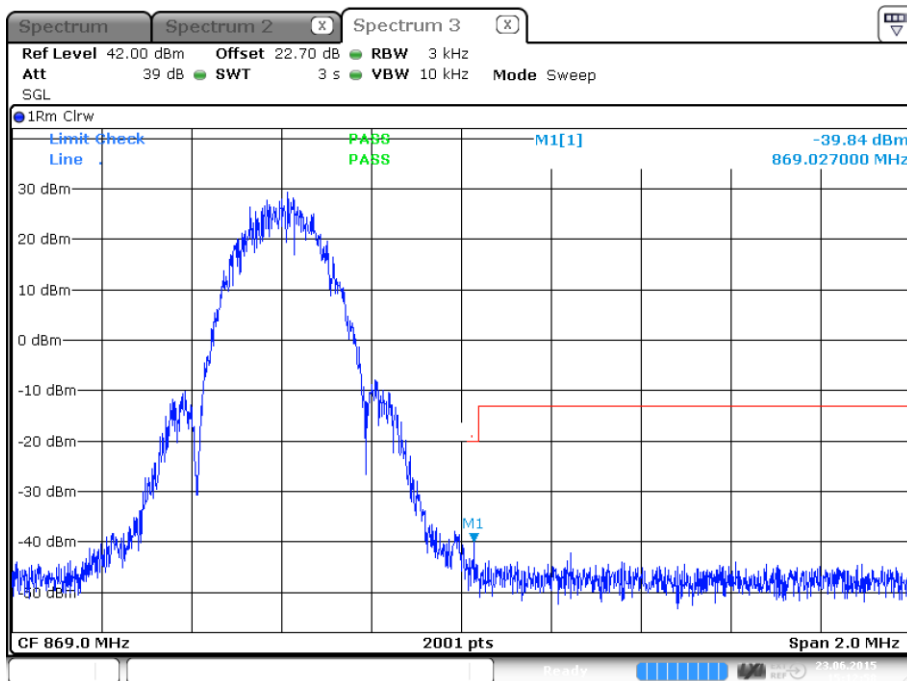

plot 9.3.1.2-#2 Emission Mask: §90.691, §2.1051; Test results; Downlink; EDGE < 1MHz to band edge Upper Band Edge



9.3.1.3 CDMA < 1MHz to band edge

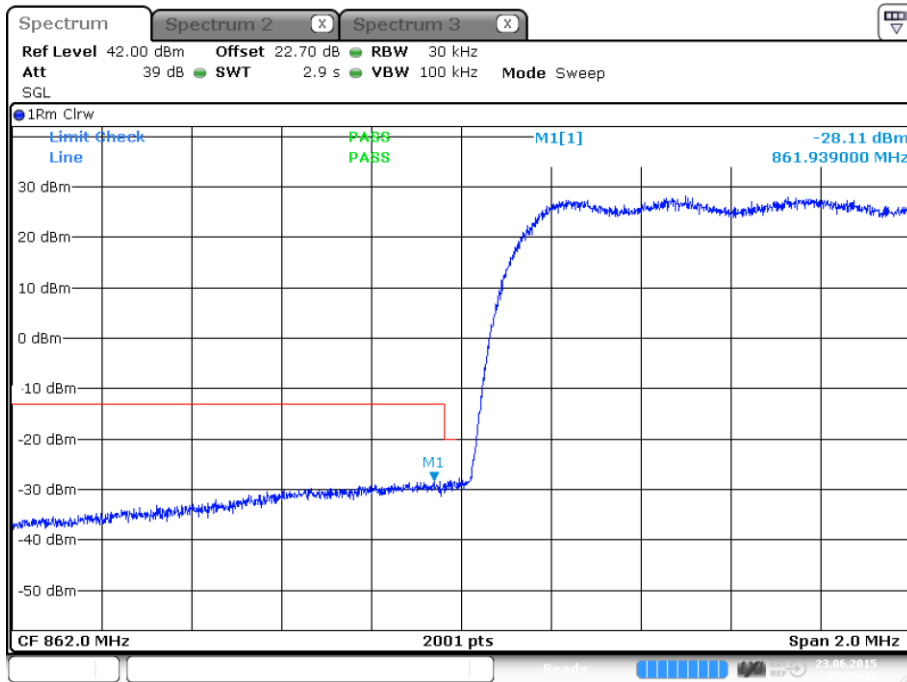

Date: 23.JUN.2015 15:20:11

plot 9.3.1.3-#1 Emission Mask: §90.691, §2.1051; Test results; Downlink; CDMA < 1MHz to band edge Lower Band Edge

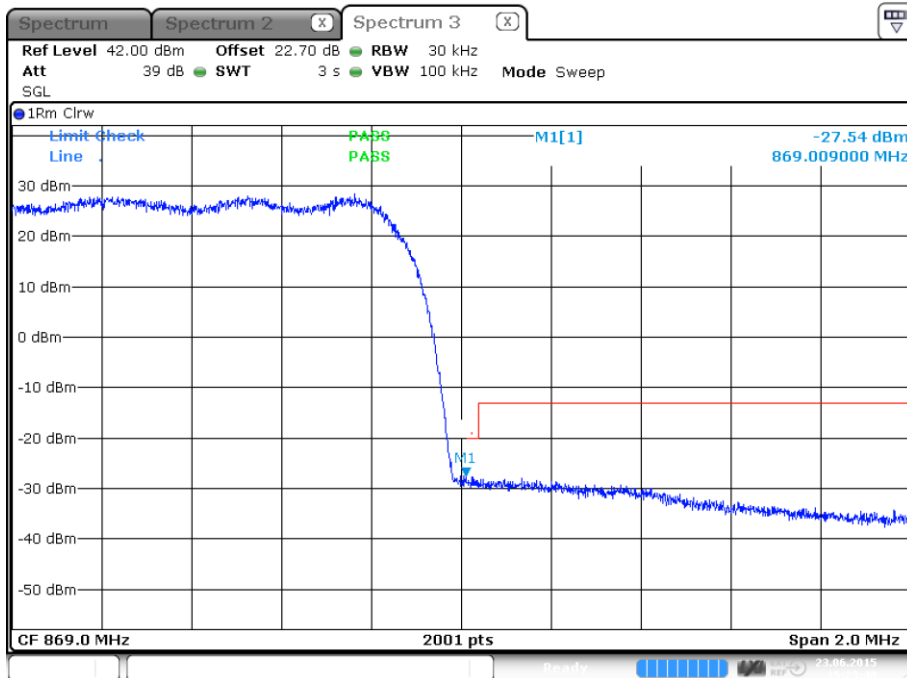

Date: 23.JUN.2015 15:23:40

plot 9.3.1.3-#2 Emission Mask: §90.691, §2.1051; Test results; Downlink; CDMA < 1MHz to band edge Upper Band Edge



9.3.1.4 WCDMA < 1MHz to band edge

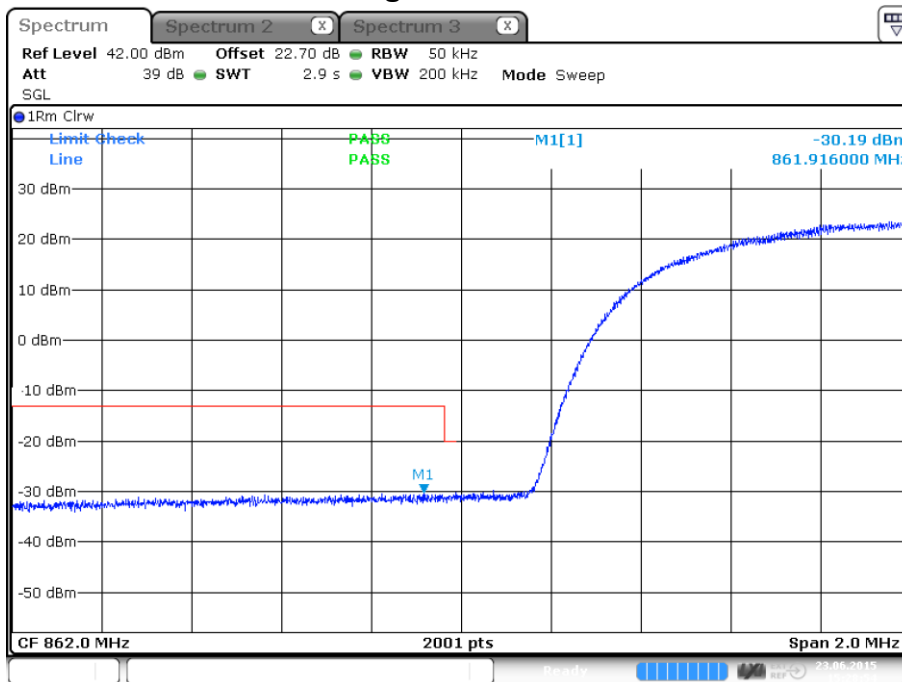

Date: 23 JUN 2015 15:28:54

plot 9.3.1.4-#1 Emission Mask: §90.691, §2.1051; Test results; Downlink; WCDMA < 1MHz to band edge Lower Band Edge

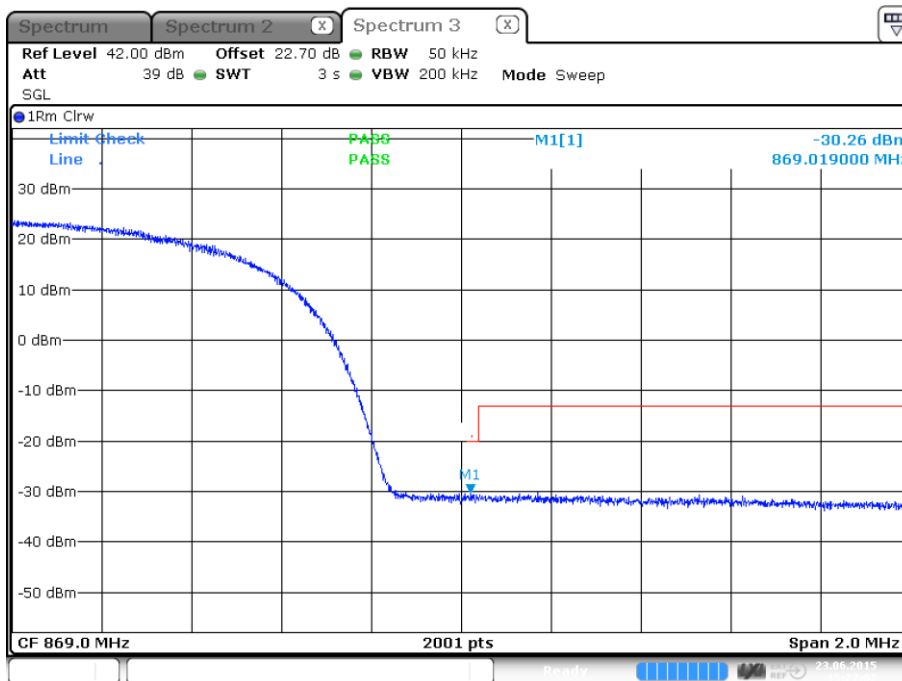

Date: 23 JUN 2015 15:27:03

plot 9.3.1.4-#2 Emission Mask: §90.691, §2.1051; Test results; Downlink; WCDMA < 1MHz to band edge Upper Band Edge



9.3.1.5 LTE < 1MHz to band edge

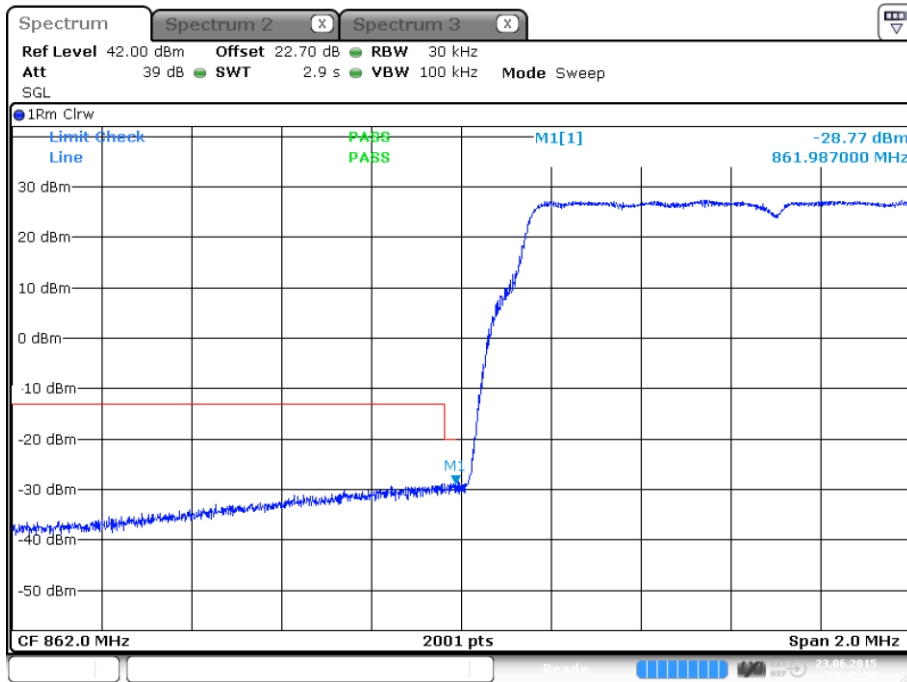

Date: 23.JUN.2015 15:42:29

plot 9.3.1.5-#1 Emission Mask: §90.691, §2.1051; Test results; Downlink; LTE < 1MHz to band edge Lower Band Edge

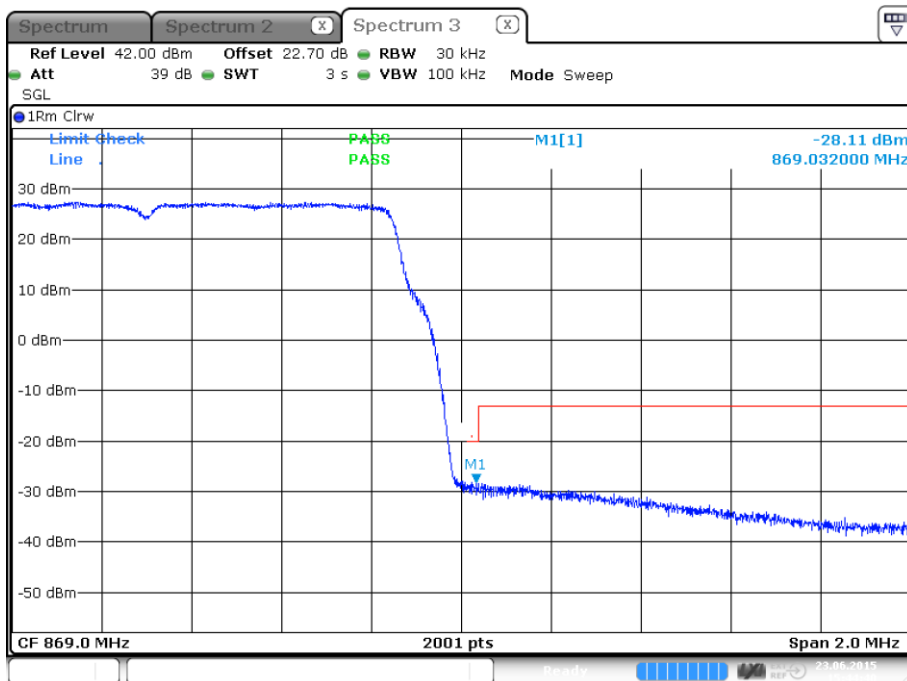

Date: 23.JUN.2015 15:44:40

plot 9.3.1.5-#2 Emission Mask: §90.691, §2.1051; Test results; Downlink; LTE < 1MHz to band edge Upper Band Edge

Test Report No.: 15-020

FCC ID: XS5-UH781719P



BUREAU
VERITAS

9.3.2 Uplink

n.a.

Note: The EUT does not transmit over the air in the uplink direction.

9.4 Summary test result

Test result	complies, according the plots above
Tested by:	M. Leinfelder
Date:	23.06.2015



10 Out of Band Rejection

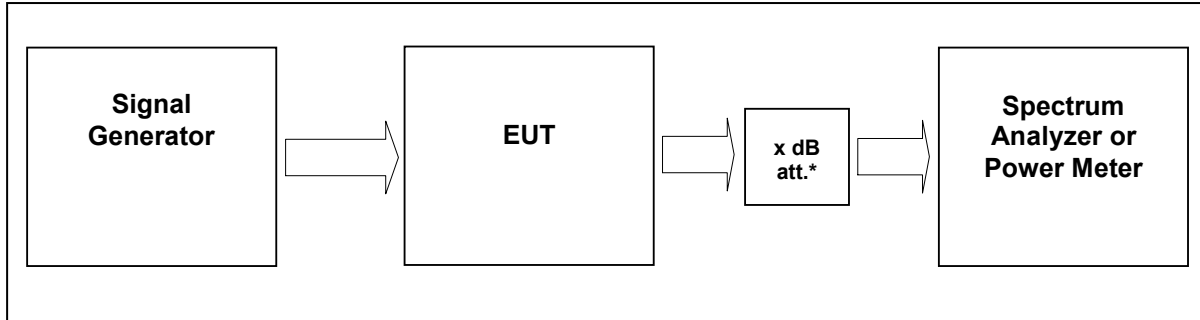

External Attenuator DL x dB = 20 dB
 figure 10-#1 Test setup: Out of Band Rejection

Measurement uncertainty	± 0,38 dB
Test equipment used	9069, 9046, 9236, 7406, 7157, 7158, 7289, 7290, 7385

10.1 Limit

KDB 935210 D02 v02

Test for rejection of out of band signals. Filter frequency response plots are acceptable.

10.2 Test method

935210 D03 v02

7.1 Authorized frequency band verification test

10.3 Test results

Detector Peak max hold



10.3.1 Downlink

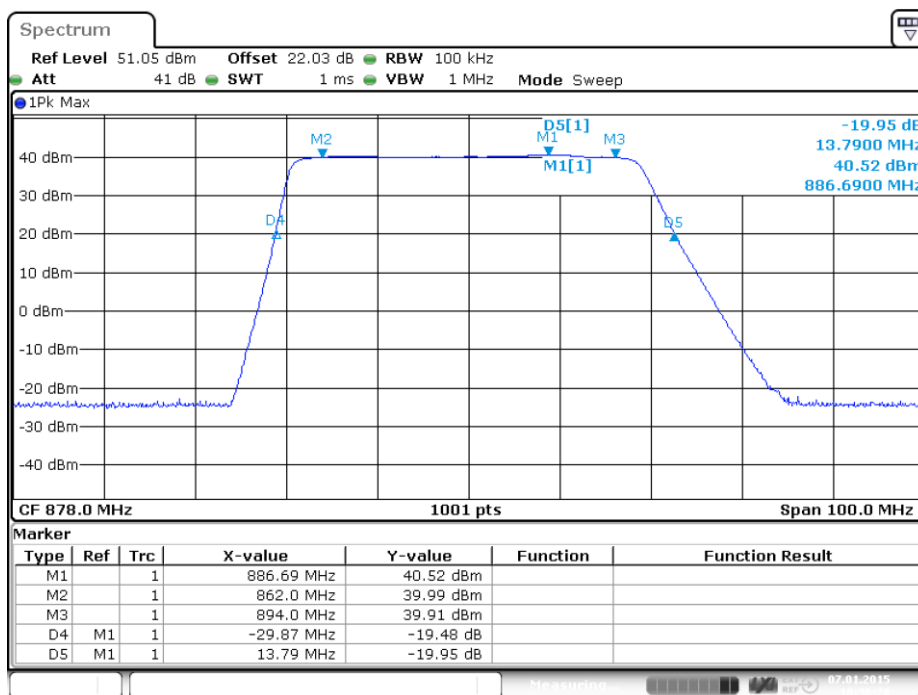

Date: 7.JAN.2015 10:36:28

plot 10.3.1-#1 Out of Band Rejection; Test results; Downlink;

10.3.2 Uplink

n.a.

Note: The EUT does not transmit over the air in the uplink direction.

10.4 Summary test result

Test result	complies, according the plots above
Tested by:	F. Bengesser
Date:	07.01.2015



11 Noise

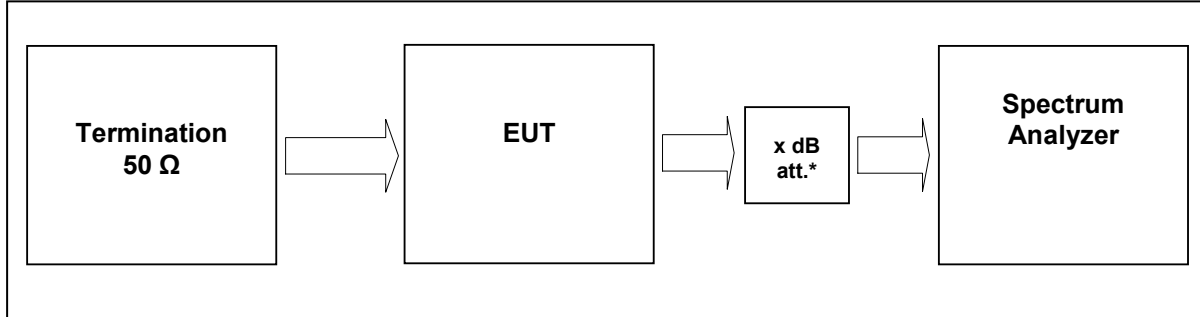

External Attenuator DL x dB = 20 dB
 figure 11-#1 Test setup: Noise

Measurement uncertainty	± 0,38 dB
Test equipment used	9069, 9046, 9236, 7406, 7157, 7158, 7289, 7290, 7385

11.1 Limit

§90.219 (d) (6) (ii) In general, the ERP of noise within the passband should not exceed -43 dBm in 10 kHz measurement bandwidth.

11.2 Test method

KDB 935210 D03 v02r01 7.7



11.3 Test results

11.3.1 Downlink

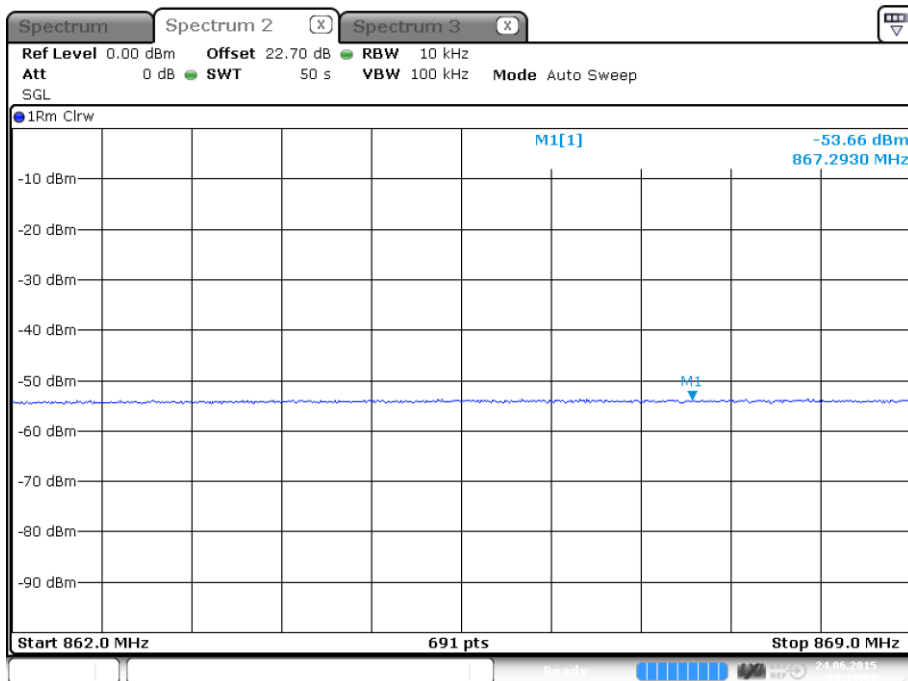

Date: 24 JUN 2015 11:13:51

plot 11.3.1-#1 Noise; Test results; Downlink;

11.3.2 Uplink

n.a.

Note: The EUT does not transmit over the air in the uplink direction.

11.4 Summary test result

Test result	complies, according the plots above
Tested by:	M. Leinfelder
Date:	24.06.2015

12 Field Strength of Spurious Emissions: §90.210, §2.1053

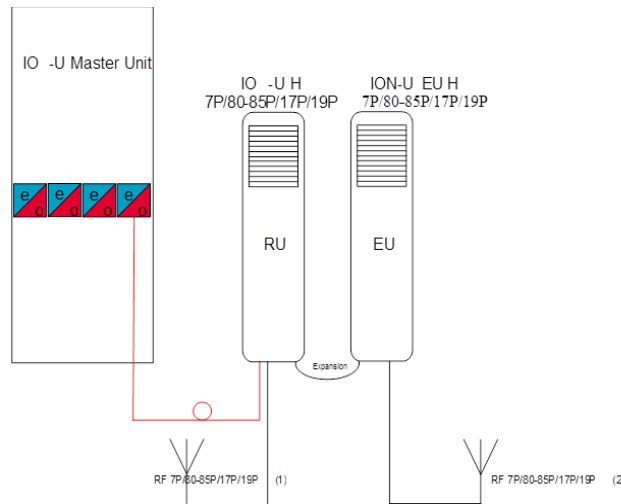

The frequencies bands of the extension unit will be implemented on the master unit with a compensation frequency bands.
 About the optical fiber all frequencies will be forwarded to the RU.
 At the RU the optical signals will be converted into RF signals.
 The frequency bands, which were not changed will be filtered by the duplexer, then amplified and transmitted by the RU.
 The replaced frequency bands filtered out and forwarded via the Cable Bridge to the EU. These frequencies converted back by the conversion module (FCM) to their original frequencies band and then they were amplified and sent out.

The worst case mode for the radiated emission is the MIMO mode. Both devices are operated with the maximum power, at the same time.



picture 8.1: label (EUT)



picture 8.2: label (auxiliary equipment)

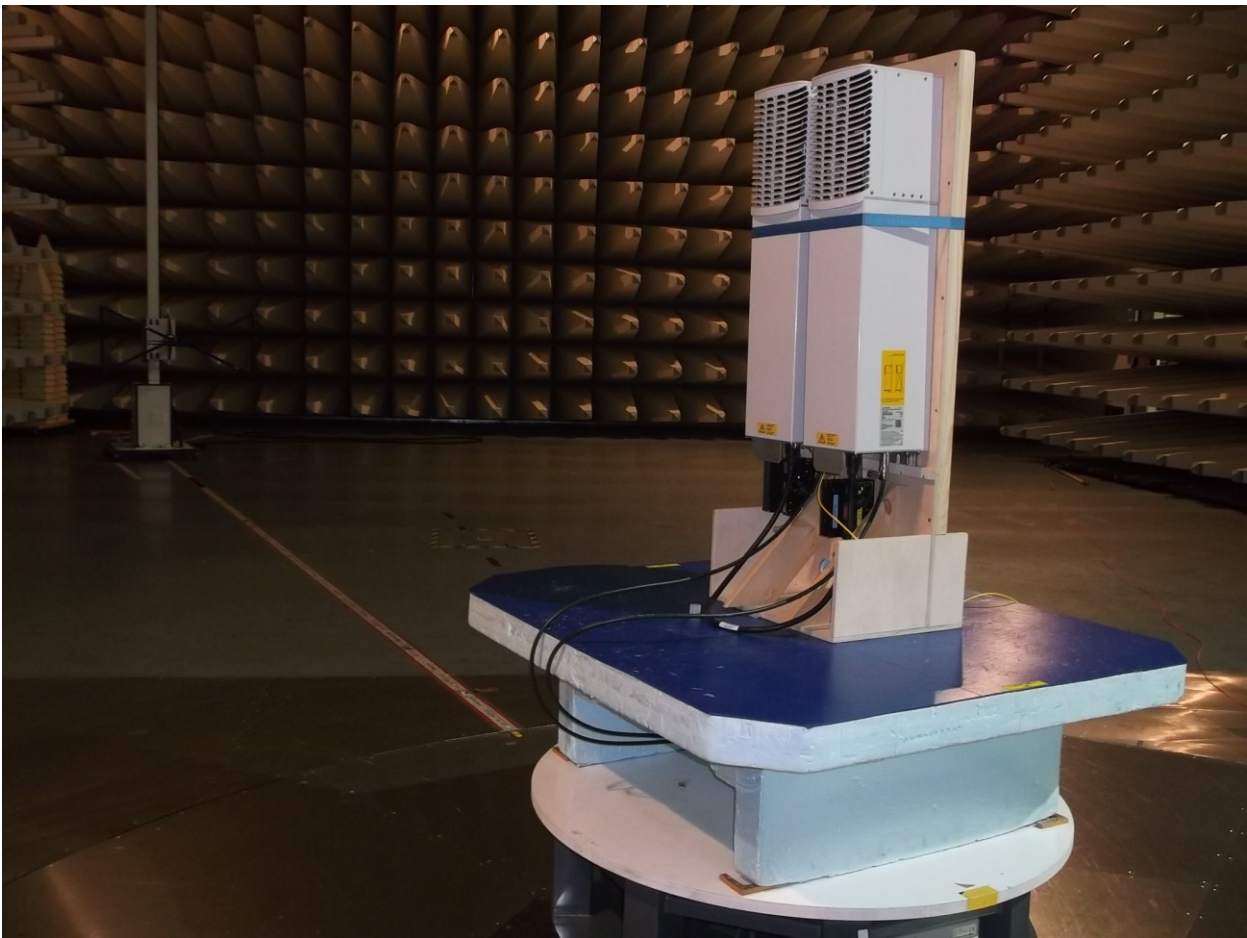

picture 8.3: Test setup: Field Strength Emission <1 GHz @10m in the SAC

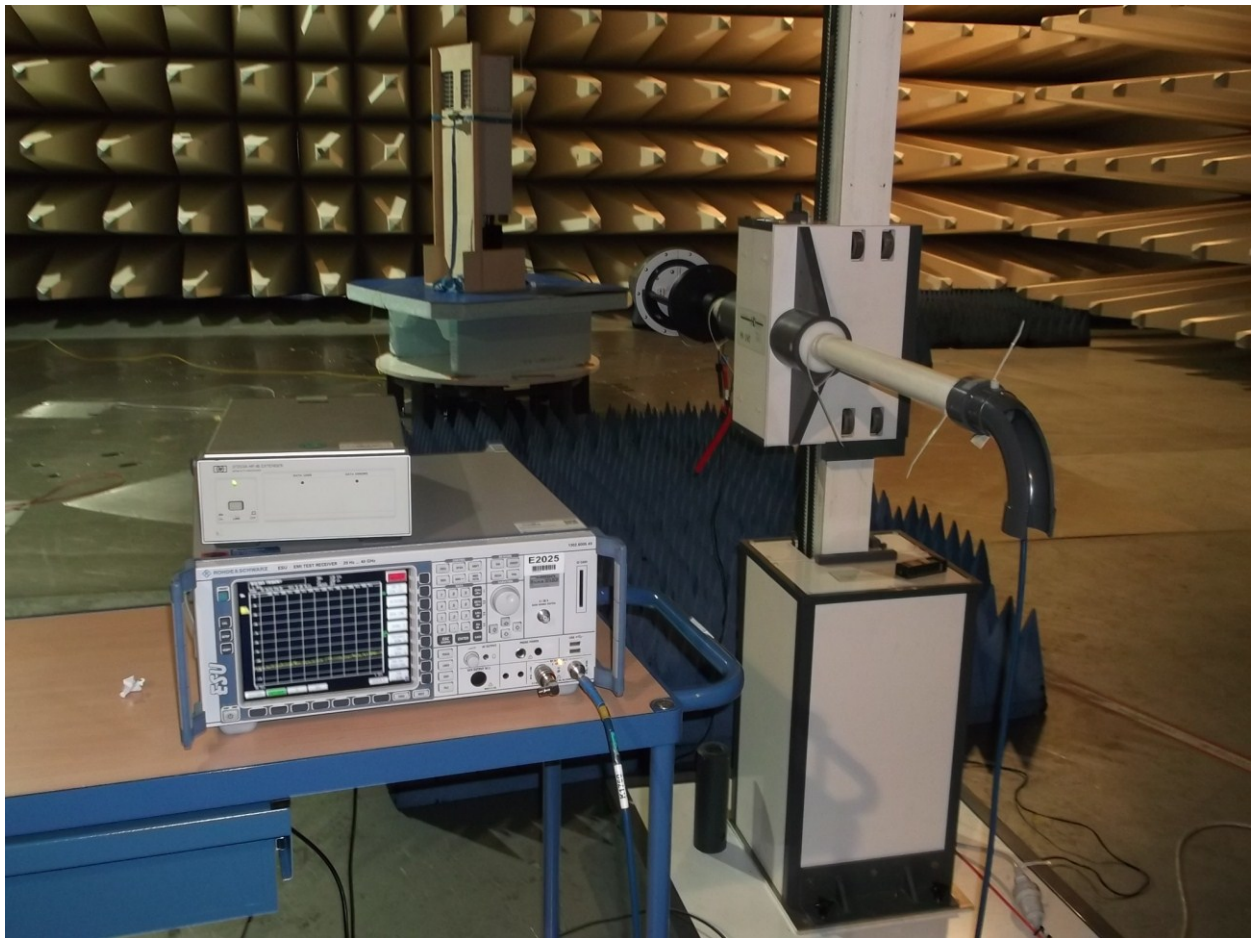

picture 8.4: Test setup: Field Strength Emission >1 GHz @3m in the SAC



This clause specifies requirements for the measurement of radiated emission.

Frequency range	Distance: EUT <-> antenna / location	Limit	Test method
30 MHz – 1 GHz	10 metres / SAC	FCC 47 CFR Part §90.210	TIA/EIA-603-C:2004
1 GHz – 20 GHz	3 metres / SAC	IC RSS-131 sec. 4.4	

Test equipment used:

Designation	Type	Manufacturer	Invent.-no.	Cal.-date	due Cal.- date	used
EMI test receiver	ESU40	Rohde & Schwarz	E2025	12.09.2014	12.09.2015	X
Antenna	CBL 6111	Chase	K1026	27.06.2014	27.06.2015	X
RF Cable	RG214	Frankonia	K1121	20.02.2013	20.02.2015	X
Antenna	HL 025	R&S	K1114	03.03.2014	03.03.2015	X
Preamplifier	AFS4-00102000	Miteq	K838	03.04.2014	03.04.2015	X
RF Cable	Sucoflex 100	Suhner	K1760	03.07.2014	03.07.2015	X

The REMI version 2.135 has been used to maximize radiated emission from the EUT with regards to ANSI C63.4:2009.

Test set-up:

Test location: SAC
 Both, the Fully Anechoic Chamber (FAC) and the Semi Anechoic Chamber (SAC) fulfil the requirements of ANSI C63.4 and CISPR 16-1-4 with regards to NSA and SVSWR.

Test Voltage: 110V / 60 Hz
 Type of EUT: Wall mounted

Measurement uncertainty:

Measurement uncertainty expanded (95% or K=2)	± 4,7 dB for ANSI C63.4 measurement ± 0,5 dB for TIA-603 measurement
--	---



12.1 Limit §22.917

The rules in this section govern the spectral characteristics of emissions in the Broadband Personal Communications Service.

(a) *Out of band emissions.* The power of any emission outside of the authorized operating frequency ranges must be attenuated below the transmitting power (P) by a factor of at least $43 + 10 \log(P)$ dB.

(b) *Measurement procedure.* Compliance with these rules is based on the use of measurement instrumentation employing a resolution bandwidth of 1 MHz or greater. However, in the 1 MHz bands immediately outside and adjacent to the frequency block a resolution bandwidth of at least one percent of the emission bandwidth of the fundamental emission of the transmitter may be employed. A narrower resolution bandwidth is permitted in all cases to improve measurement accuracy provided the measured power is integrated over the full required measurement bandwidth (i.e. 1 MHz or 1 percent of emission bandwidth, as specified). The emission bandwidth is defined as the width of the signal between two points, one below the carrier center frequency and one above the carrier center frequency, outside of which all emissions are attenuated at least 26 dB below the transmitter power.

The emission measurements have been made with transmission at Bottom/Middle/Top frequency

The limit is -13dBm (e.i.r.p).

If the DUT used in MIMO configuration according to KDB 662911, the summed emission (MIMO Max. Level) is calculated (Max. Level) of the output port plus $10 \log(N_{ANT})$. With ($N_{ANT} = 2$) the MIMO Max. Level (dBm) equals Max. Level (dBm) plus 3dB.

12.2 Test method ANSI/TIA/EA-603-C

Measurement procedure. TIA-603-C

The antenna substitution method is used to determine the equivalent radiated power at spurious frequencies. The spurious emissions are measured at a distance of 3 meters. The EUT is then replaced with a reference substitution antenna with a known gain referenced to a dipole. This antenna is fed with a signal at the spurious frequency. The level of the signal is adjusted to repeat the previously measured level. The resulting eirp is the signal level fed to the reference antenna corrected for gain referenced to an isotropic dipole (see Figure 7.2).

From KDB (AMPLIFIER, BOOSTER, AND REPEATER REMINDER SHEET):

Radiated spurs (enclosure) – Use of CW signal (low, mid. and high freq.) is acceptable rather than all modulations.

The maximum RFI field strength was determined during the measurement by rotating the turntable (± 180 degrees) and varying the height of the receive antenna ($h = 1 \dots 4$ m) as like defined in ANSI C63.4. A measurement receiver has been used with a RBW 120 kHz up to 1 GHz and 1 MHz above 1 GHz. Steps with during pre measurement was half the RBW.

Both, the Fully Anechoic Chamber (FAC) and the Semi Anechoic Chamber (SAC) fulfil the requirements of ANSI C63.4 and CISPR 16-1-4 with regards to NSA and SVSWR.

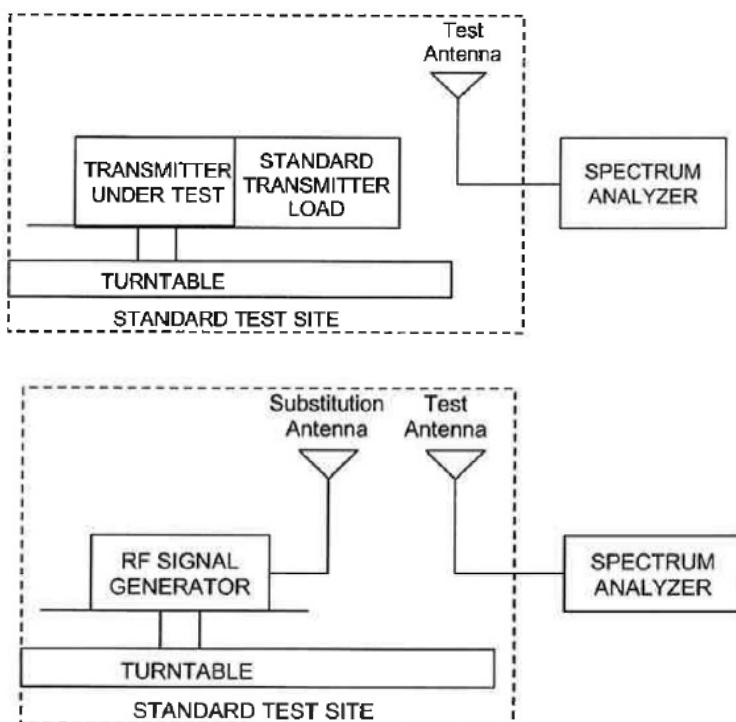

picture 8.3: Substitution method

12.3 Climatic values in the lab

Temperature: 20°
 Relative Humidity: 45%
 Air-pressure: 1009hPa



12.4 Test results

12.4.1 30 MHz to 1 GHz Downlink (Bottom – Middle – Top) Subpart H

B/M/T: 862 MHz/ 865,5 MHz/ 869 MHz

Vertikal

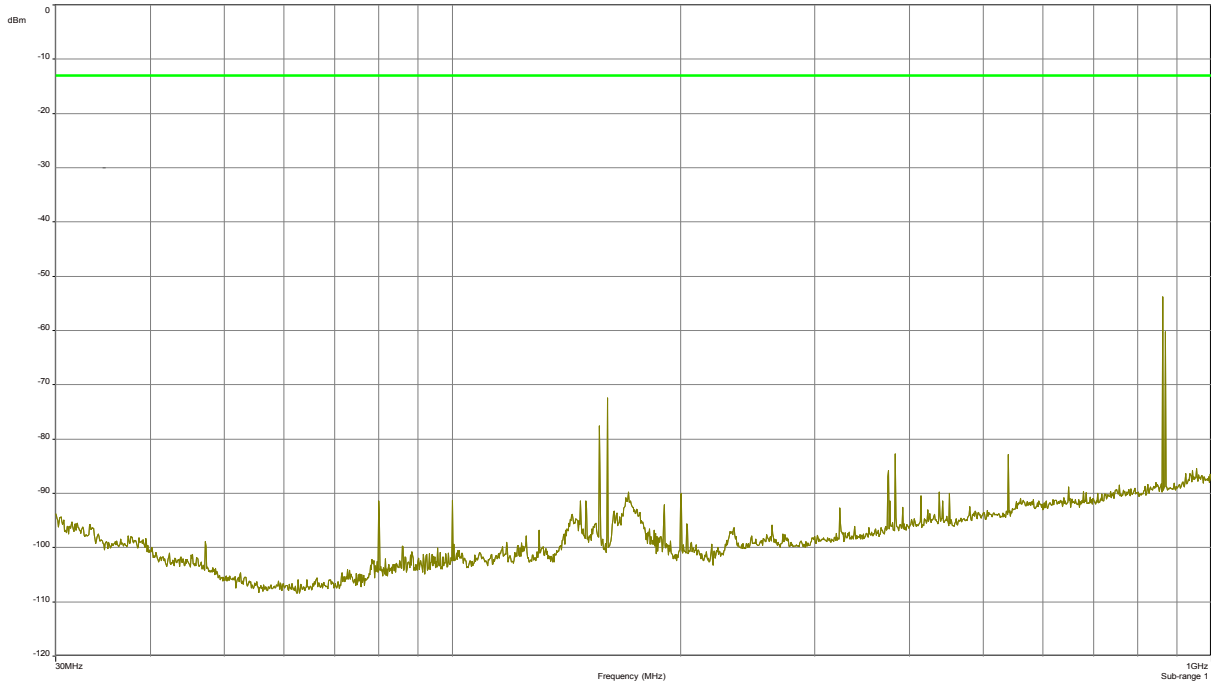

Horizontal

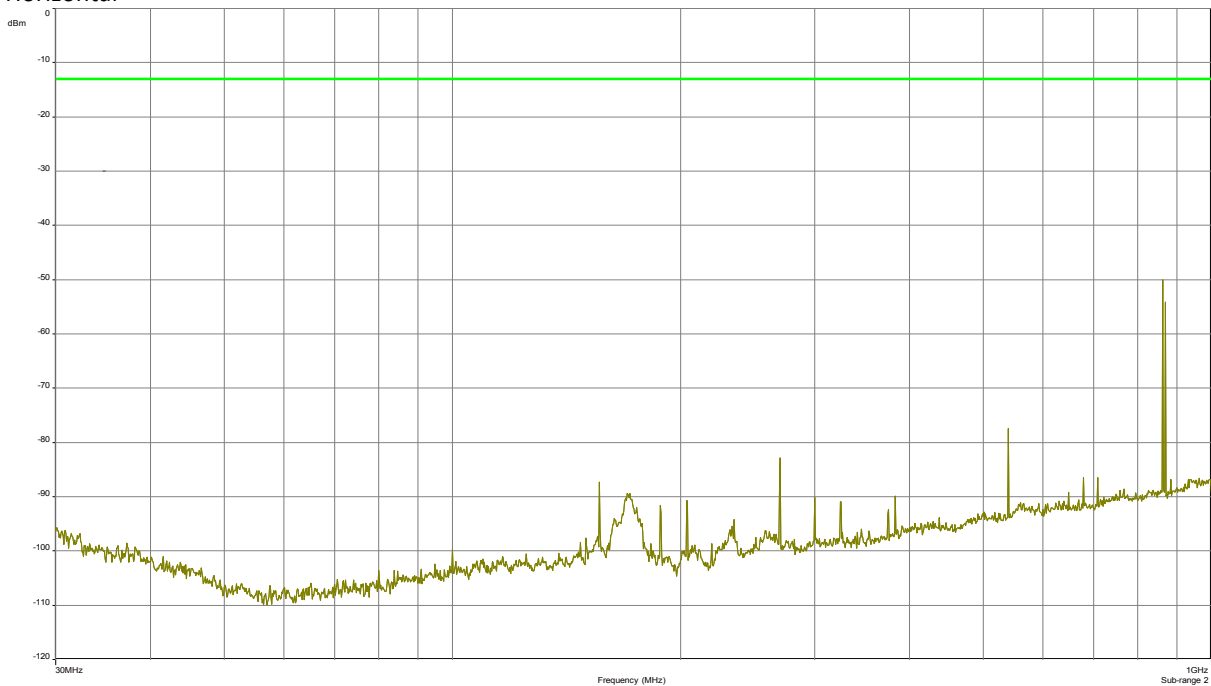

The RF output power is terminated.



12.4.2 30 MHz to 1 GHz Downlink (Middle of all paths)

F1: 742.5 MHz; F2: 878 MHz; F3: 1962,5 MHz; F4: 2132,5 MHz

Vertikal

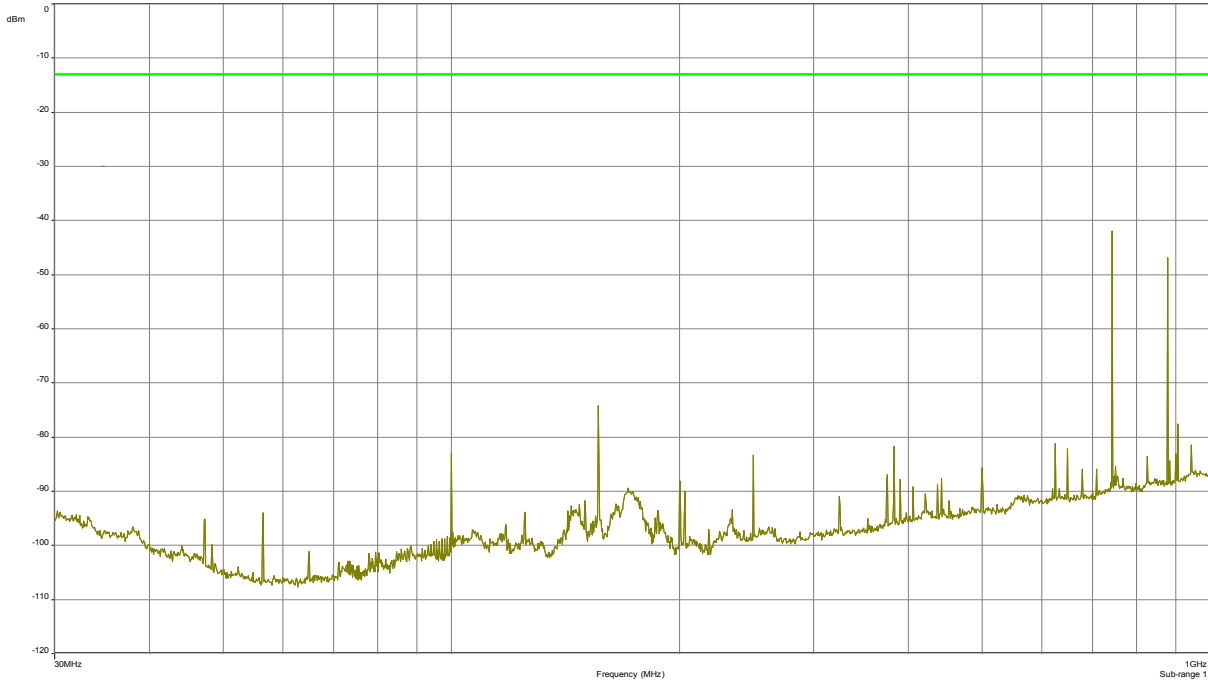

Horizontal

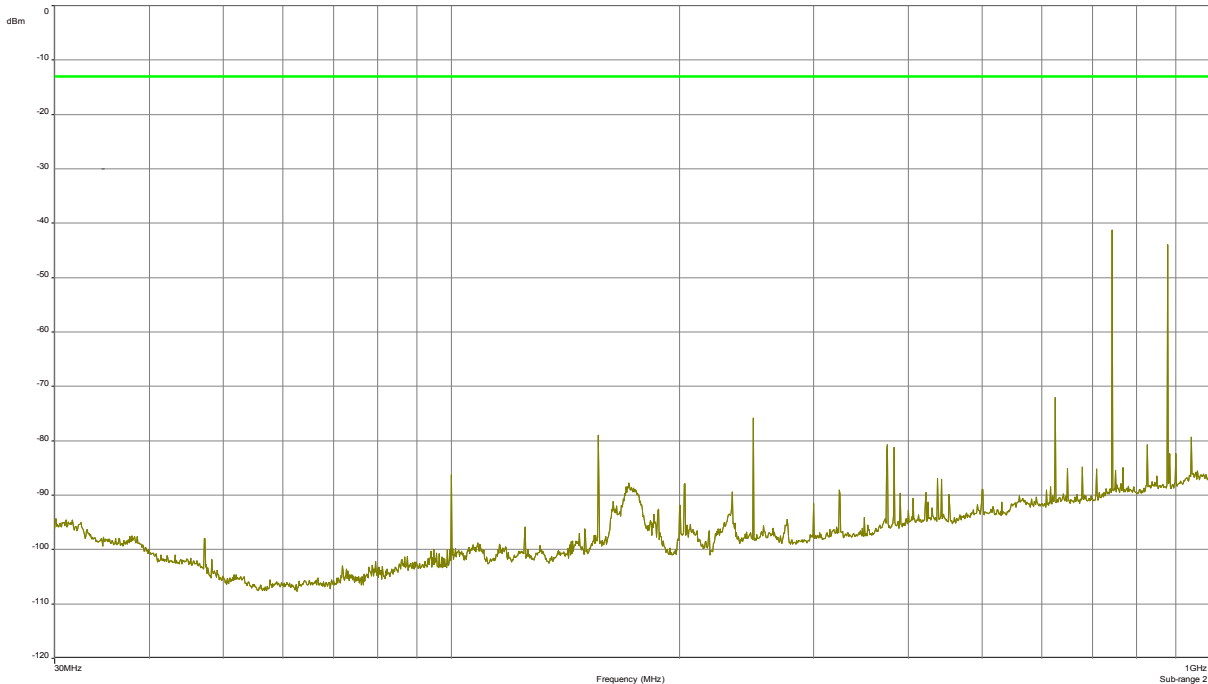

The RF output power is terminated.



12.4.3 1 GHz to 20 GHz Downlink (Bottom – Middle – Top) Subpart H

B/M/T: 862 MHz/ 865,5 MHz/ 869 MHz

Vertikal

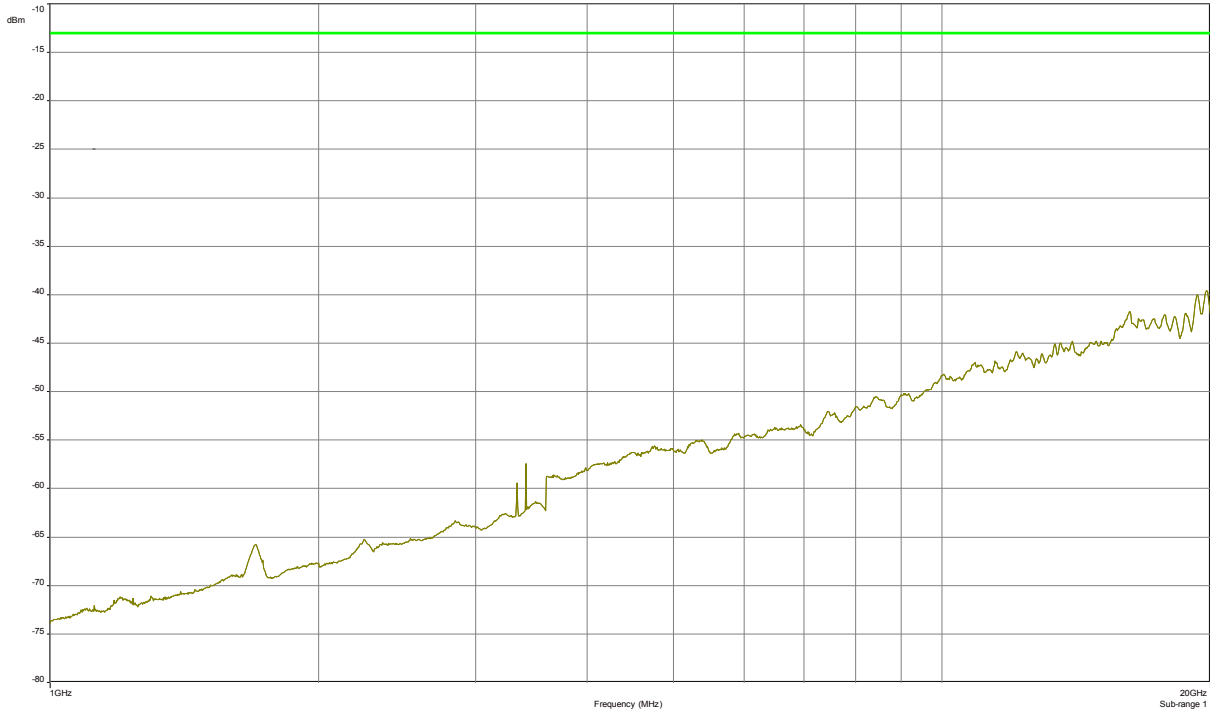

Horizontal

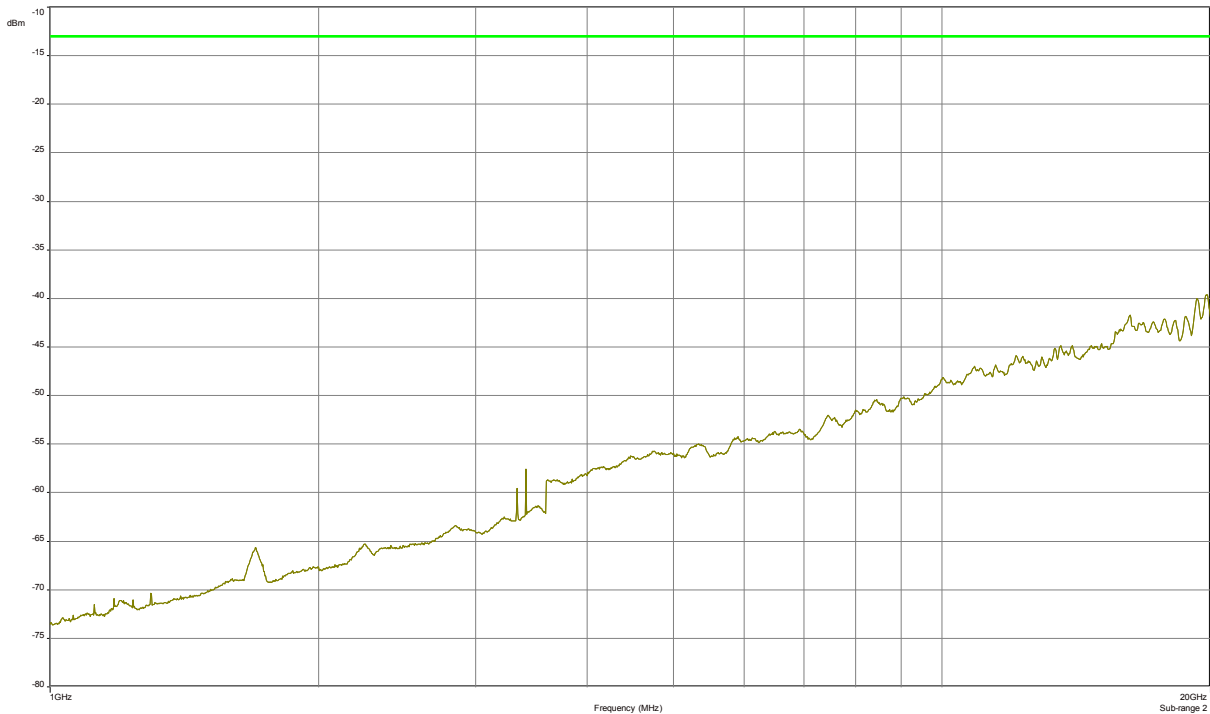

The RF output power is terminated.



12.4.4 1 GHz to 20 GHz Downlink (Middle of all paths)

F1: 742,5 MHz; F2: 878 MHz; F3: 1962,5 MHz; F4: 2132,5 MHz

Vertikal

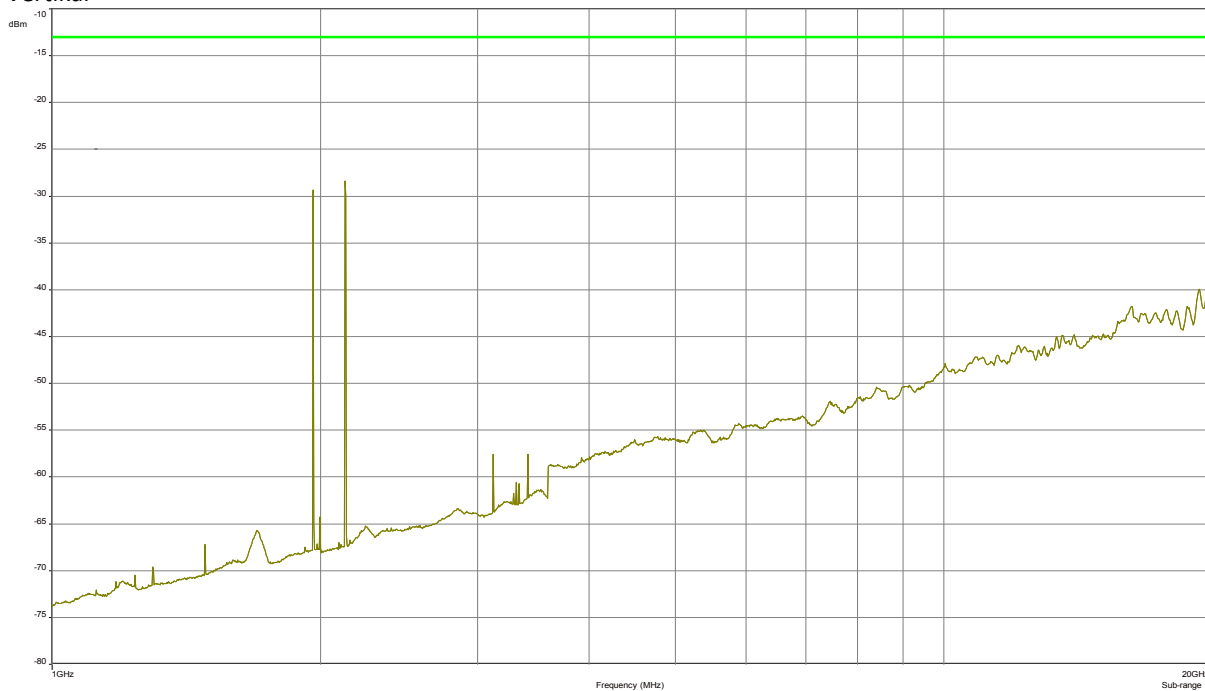

Horizontal

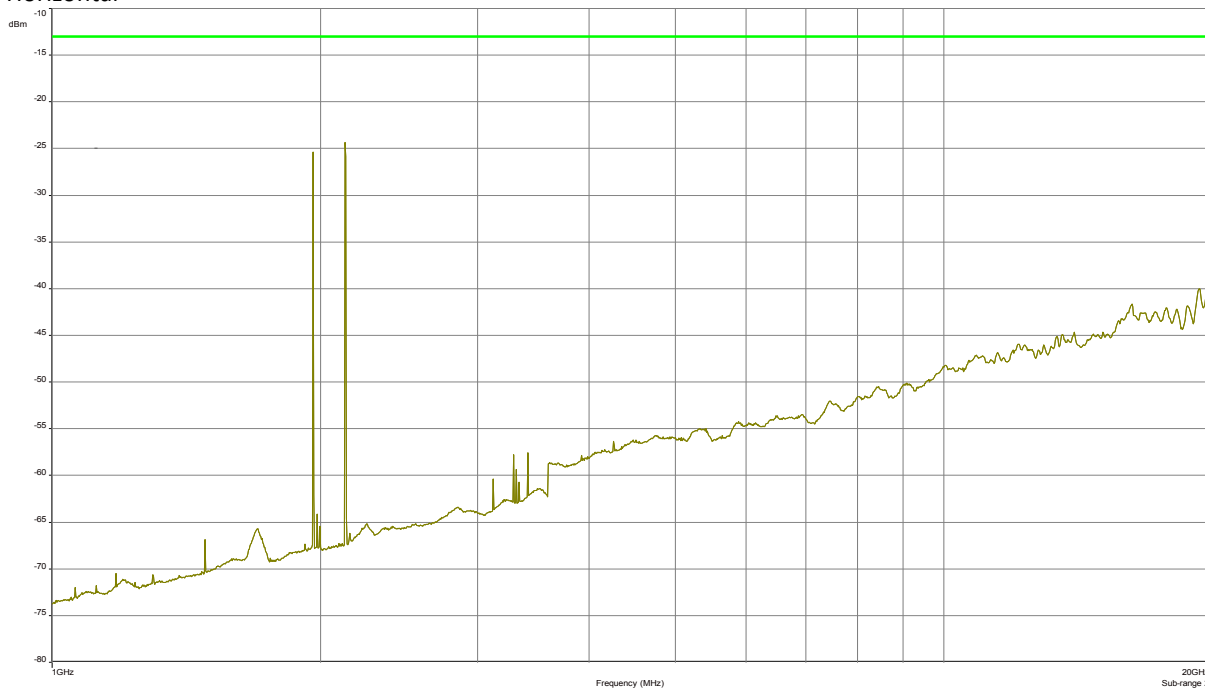

The RF output power is terminated.

Za / 14.12.2014

The radiated spurious emission measurements have been passed!

Test Report No.: 15-020

FCC ID: XS5-UH781719P



**BUREAU
VERITAS**

13 History

Revision	Modification	Date	Name
01.00	Initial Test report	14.04.2015	Tom Zahlmann

******* End of test report *******