

Test Site:
FCC Test Site No.: 96997



BUREAU
VERITAS

ECL-EMC Test Report No.: 15-019

Equipment under test: ION-U H 7P/80-85P/17P/19P
700MHz main path

FCC ID: XS5-UH781719P

Type of test: FCC 47 CFR Part 27 Subpart H, F: 2015
Miscellaneous Wireless Communication Services

Measurement Procedures: 47 CFR Parts 2: 2015 (*Frequency Allocations and Radio Treaty Matters; General Rules and Regulations*),
Part 27: 2015 (*Miscellaneous Wireless Communication Services*),
ANSI/TIA-603-C:2004, *Land Mobile FM or PM Communications Equipment Measurement and Performance Standards*

Test result: Passed

Date of issue:	29.06.15	Signature:	
Issue-No.:	01	Author:	
Date of delivery:	27.01.15	Checked:	
Test dates:	15.12.14 – 17.01.15		
Pages:	47		



Manufacturer: ANDREW Wireless Systems GmbH
Industriering 10

D-86675 Buchdorf

Tel.: +49 (0)9099 69 0

Fax: +49 (0)9099 69 140

Test Location: Bureau Veritas Consumer Products Services
Germany GmbH
European Compliance Laboratory (ECL)
Thurn-und-Taxis-Straße 18

D-90411 Nürnberg

Tel.: +49 40 74041 0

Fax: +49 40 74041-2755

General:

The purpose of this report is to show compliance to the FCC regulations for devices operating under Part 27 of the Code of Federal Regulations title 47.

This report informs about the results of the EMC tests, it only refers to the equipment under test. No part of this report may be reproduced in any form, without written permission.



Table of contents

1	TEST RESULTS SUMMARY	5
2	EQUIPMENT UNDER TEST (E.U.T.)	6
2.1	DESCRIPTION	6
2.1.1	DOWNLINK	6
2.1.2	UPLINK	6
2.1.3	DESCRIPTION OF EUT	7
2.1.4	BLOCK DIAGRAM OF MEASUREMENT REFERENCE POINTS	8
2.1.5	DOWNLINK SYSTEM GAIN AND OUTPUT POWER	8
3	TEST SITE (ANDREW BUCHDORF)	9
3.1	TEST ENVIRONMENT	9
3.2	TEST EQUIPMENT	9
3.3	INPUT AND OUTPUT LOSSES	10
3.4	MEASUREMENT UNCERTAINTY	10
4	TEST SITE (BUREAU VERITAS CONSUMER PRODUCTS SERVICES)	10
5	RF POWER OUT: §27.50, §2.1046	11
5.1	LIMIT	11
5.2	TEST METHOD	11
5.3	TEST RESULTS	12
5.3.1	DOWNLINK	12
5.3.1.1	LTE 728 – 746MHz	13
5.3.1.2	LTE 746 – 757MHz	14
5.3.2	UPLINK	14
5.4	SUMMARY TEST RESULT	14
6	OCCUPIED BANDWIDTH: §2.1049	15
6.1	LIMIT	15
6.2	TEST METHOD	15
6.3	TEST RESULTS	15
6.3.1	DOWNLINK	15
6.3.1.1	LTE 728 – 746MHz	16
6.3.1.2	LTE 746 – 757MHz	17
6.3.2	26DB BANDWIDTH	18
6.3.2.1	LTE 728 – 746MHz	18
6.3.2.2	LTE 746 – 757MHz	19
6.3.3	UPLINK	20
6.4	SUMMARY TEST RESULT	20
7	SPURIOUS EMISSIONS AT ANTENNA TERMINALS: §27.53, §2.1051	21
7.1	LIMIT	21
7.2	TEST METHOD	22
7.3	TEST RESULTS	22
7.3.1	DOWNLINK	22



7.3.1.1	LTE 728 – 746MHz.....	24
7.3.1.2	LTE 746 – 757MHz.....	25
7.3.1.3	Measurement in the band of 1559 MHz – 1610 MHz acc. to 27.53(f).....	27
7.3.2	UPLINK.....	27
7.4	SUMMARY TEST RESULT.....	27
8	INTERMODULATION: §27.53, §2.1051.....	28
8.1	LIMIT.....	28
8.2	TEST METHOD.....	29
8.3	TEST RESULTS.....	29
8.3.1	DOWNLINK.....	29
8.3.1.1	LTE 728 – 746MHz.....	30
8.3.1.2	LTE 746 – 757MHz.....	31
8.3.2	UPLINK.....	32
8.4	SUMMARY TEST RESULT.....	32
9	OUT OF BAND REJECTION.....	33
9.1	LIMIT.....	33
9.2	TEST METHOD.....	33
9.3	TEST RESULTS.....	33
9.3.1	DOWNLINK.....	34
9.3.2	UPLINK.....	34
9.4	SUMMARY TEST RESULT.....	34
10	RADIATED SPURIOUS EMISSIONS AT THE ECL (BV): §27.53, §2.1053.....	35
10.1	METHOD OF MEASUREMENT.....	39
10.2	LIMIT.....	40
10.3	RECEIVER SETTINGS.....	40
10.4	CLIMATIC VALUES IN THE LAB.....	40
10.5	TEST RESULTS.....	41
10.5.1	30 MHz TO 1 GHz DOWNLINK (BOTTOM – MIDDLE – TOP) SUBPART H.....	41
10.5.2	30 MHz TO 1 GHz DOWNLINK (BOTTOM – MIDDLE – TOP) SUBPART F.....	42
10.5.3	30 MHz TO 1 GHz DOWNLINK (MIDDLE OF ALL PATHS).....	43
10.5.4	1 GHz TO 20 GHz DOWNLINK (BOTTOM – MIDDLE – TOP) SUBPART H.....	44
10.5.5	1 GHz TO 20 GHz DOWNLINK (BOTTOM – MIDDLE – TOP) SUBPART F.....	45
10.5.6	1 GHz TO 20 GHz DOWNLINK (MIDDLE OF ALL PATHS).....	46
11	HISTORY.....	47



1 Test Results Summary

Name of Test	FCC Para. No.	FCC Method	FCC Spec.	Result
RF Power Output	27.50(b)(c)	2.1046	1000 Watts ERP	Complies
Occupied Bandwidth	2.1049	2.1049	Input/Output	Complies
Spurious Emissions at Antenna Terminals	27.53(c)(d)(g)	2.1051	-13dBm	Complies
Radiated Spurious emission	27.53(m)	2.1053 TIA/EA-603	-13dBm E.I.R.P	Complies
Intermodulation	KDB 935210 D02 v02r01 D.3(i)	KDB 935210 D02 v02r01 D.3(i)	KDB 935210 D02 v02r01 D.3(i)	Complies
Frequency Stability	27.54	2.1055	Must stay in band	NA
Out of Band Rejection	KDB 935210 D02 v02	KDB 935210 D03 v02	KDB 935210 D03 v02	Complies

Frequency stability is given by: The system gets an electrical analog signal from the BSS which is converted into an analog optical signal, transmitted by the optical links and then reconverted in the Remote Unit into an analog electrical signal. During this process happens no frequency change/modification, so input and output have same frequency what can be seen under clause "Occupied Bandwidth".



2 Equipment under test (E.U.T.)

2.1 Description

Kind of equipment	ION-U H 7P/80-85P/17P/19P-Vac-M2 (Remote Unit)
Andrew Ident. Number	7698400-0001
Serial no.(SN)	11
Revision	00
Software version and ID	1.69.0
Type of modulation and Designator	LTE (G7D) <input checked="" type="checkbox"/>
Frequency Translation	F1-F1 <input checked="" type="checkbox"/>
	F1-F2 <input type="checkbox"/>
	N/A <input type="checkbox"/>
Band Selection	Software <input type="checkbox"/>
	Duplexer <input checked="" type="checkbox"/>
	Full band <input type="checkbox"/>

2.1.1 Downlink

Pass band	Path 728 MHz – 757 MHz
Pass band under test	Path 728 MHz – 746 MHz Path 746 MHz – 756 MHz
Max. composite output power based on one carrier per path (rated)	43.0 dBm = 20 W
MIMO max. composite output power based on one carrier per path (rated)	46.0 dBm = 40 W
System Gain*	10 dB @ Pout BTS of 33 dBm

*see 2.1.5

2.1.2 Uplink

Pass band	Path 698 MHz – 716 MHz, 776 MHz - 787MHz
Maximum rated output power	n. a.
System Gain*	n. a.

*see 2.1.5

Note: The EUT does not transmit over the air in the uplink direction.



2.1.3 Description of EUT

CommScope's ION-U H 7P/80-85P/17P/19P-Vac-M2 is a multi-band, multi-operator Remote Unit. It is used in conjunction with a Master Unit in the ION optical distribution system. This system transports up to four frequency bands simultaneously, providing a cost-effective solution for distributing capacity from one or more base stations. In single use the ION-U H 7P/80-85P/17P/19P-Vac-M2 is a SISO system. In combination with a ION-U EU H 7P/80-85P/17P/19P-Vac-M2 and or ION-U EU H 23/23-Vac-M2 the ION-U system can use for MIMO application in all RF paths.

This Test Report describes only the approval of the 700 MHz main path.

The ION-U H 7P/80-85P/17P/19P-Vac-M2 Repeater system consists of one 700 MHz path, one 800-850 MHz path, one 1700/2100 MHz path and one 1900 MHz path with the intended use of simultaneous transmission.

The antenna(s) used with device must be fixed-mounted on permanent structures.



2.1.4 Block diagram of measurement reference points

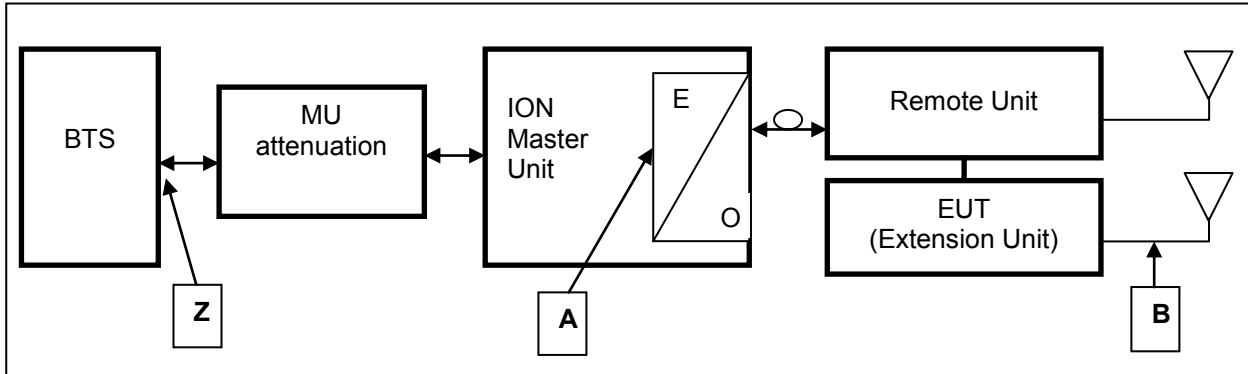

figure 2.1.4-#1 Block diagram of measurement reference points

Remote Unit (RU) is the EUT

O/E Opitcal/Electrical converter
 MU Master Unit

Reference point A MU UL output, DL input
 Reference point B Remote Unit DL output, UL input
 Reference point Z BTS DL output, UL input

Since a signal generator does not supply a good output signal with +33 or +43dBm, for the downlink measurement the MU Attenuation is not used. That means for downlink measurements the signal generator is connected to measurement point A at the master optical / electrical converter and the analyzer to the measurement point B at the RU.

2.1.5 Downlink System Gain and Output Power

System optimized for BTS power (fixed value)	MU Attenuation (manual leveling)	Maximum rated input power at the MU OTRX (fixed value)	RU Gain (fixed value)	Maximum rated output power at RU Antenna port (fixed value)
Z		A	A to B	B
+33 dBm	55 dB	-22 dBm	+65 dB	+43.0 dBm @ 1 carrier
System Gain Z to B	+10 dB			
+43 dBm	65 dB	-22 dBm	+65 dB	+43.0 dBm @ 1 carrier
System Gain Z to B	+0 dB			

table 2.1.5-#1 Equipment under test (E.U.T.) Description Downlink System Gain and Output Power



3 Test site (Andrew Buchdorf)

3.1 Test environment

All tests were performed under the following environmental conditions:

Condition	Minimum value	Maximum value
Barometric pressure	86 kPa	106 kPa
Temperature	15°C	30°C
Relative Humidity	20 %	75 %
Power supply range	±5% of rated voltages	

3.2 Test equipment

ANDREW Inv. No.	Test equipment	Type	Manufacturer	Serial No.	Calibration
9266	Network Analyzer	ZNB 20	R&S	101490	12/2015
9236	Spectrum Analyzer	FSV 30	R&S	101345	9/2015
9069	Generator	SMBV100A	R&S	256275	08/2015
9046	Generator	SMBV100A	R&S	255090	06/2015
8542	Power Meter	E4418A	Agilent	GB38273230	02/2015
8544	Power Sensor	E8481H	Agilent	3318A19208	07/2015
7157	RF-Cable	Succoflex	Suhner	36180/4P	CIU
7158	RF-Cable	Succoflex	Suhner	36182/4P	CIU
7289	RF-Cable	Succoflex	Suhner	28443/4PE	CIU
7290	RF-Cable	Succoflex	Suhner	28444/4PE	CIU
7385	RF-Cable	Succoflex	Suhner	36267/4P	CIU
7387	RF-Cable	Succoflex	Suhner	36267/4P	CIU
7390	RF-Cable	Succoflex	Suhner	40193/4P	CIU
7381	RF-Cable	Succoflex	Suhner	40200/4P	CIU
7457	Notch filter	WRCT728/757-723/762-60/16EE	Wainwright Instruments	1	CIU
7406	Switch-Matrix		Andrew		CIU

CIU = Calibrate in use



3.3 Input and output losses

All recorded power levels should be referenced to the input and output connectors of the repeater, unless explicitly stated otherwise.

The test equipment used in this test has to be calibrated, so that the functionality is also checked.

All cables, attenuators, splitter, isolator, circulator and combiner etc. must be measured before testing and used for compensation during testing.

3.4 Measurement uncertainty

The extended measurement uncertainty corresponds to the measurement results from the standard measurement uncertainty multiplied by the coverage factor $k=2$. The true value is located in the corresponding interval with a probability of 95 %.

4 Test site (Bureau Veritas Consumer Products Services)

FCC Test site: 96997

See relevant dates under section 9 of this test report.



5 RF Power Out: §27.50, §2.1046

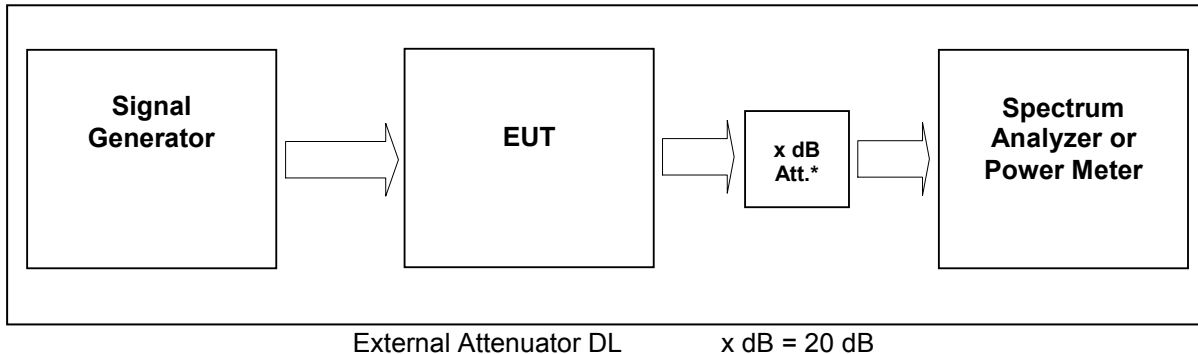

figure 5-#1 Test setup: RF Power Out: §27.50, §2.1046

Measurement uncertainty	± 0,38 dB
Test equipment used	9069, 9046, 9236, 7406, 7157, 7158, 7289, 7290, 7385

5.1 Limit

Minimum standard:

Para. No.27.50(b)(4) and (c)(1) and (c) (3)

(b) The following power and antenna height limits apply to transmitters operating in the 746–763 MHz, 775–793 MHz and 805–806 MHz bands:

(4) Fixed and base stations transmitting a signal in the 746–757 MHz, 758–763 MHz, 776–787 MHz, and 788–793 MHz bands with an emission bandwidth greater than 1 MHz must not exceed an ERP of 1000 watts/MHz and an antenna height of 305 m HAAT, except that antenna heights greater than 305 m HAAT are permitted if power levels are reduced below 1000 watts/MHz ERP accordance with Table 3 of this section.

(c) The following power and antenna height requirements apply to stations transmitting in the 698–746 MHz band:

(1) Fixed and base stations transmitting a signal with an emission bandwidth of 1 MHz or less must not exceed an effective radiated power (ERP) of 1000 watts and an antenna height of 305 m height above average terrain (HAAT), except that antenna heights greater than 305 m HAAT are permitted if power levels are reduced below 1000 watts ERP in accordance with Table 1 of this section;

(3) Fixed and base stations transmitting a signal with an emission bandwidth greater than 1 MHz must not exceed an ERP of 1000 watts/MHz and an antenna height of 305 m HAAT, except that antenna heights greater than 305 m HAAT are permitted if power levels are reduced below 1000 watts/MHz ERP in accordance with Table 3 of this section;

5.2 Test method

§ 2.1046 Measurements required: RF power output.

(a) For transmitters other than single sideband, independent sideband and controlled carrier radiotelephone, power output shall be measured at the RF output terminals when the transmitter is adjusted in accordance with the tune-up procedure to give the values of current and voltage on the circuit elements specified in § 2.1033(c)(8). The electrical characteristics of the radio frequency load attached to the output terminals when this test is made shall be stated.



(c) For measurements conducted pursuant to paragraphs (a) and (b) of this section, all calculations and methods used by the applicant for determining carrier power or peak envelope power, as appropriate, on the basis of measured power in the radio frequency load attached to the transmitter output terminals shall be shown. Under the test conditions specified, no components of the emission spectrum shall exceed the limits specified in the applicable rule parts as necessary for meeting occupied bandwidth or emission limitations

5.3 Test Results

Detector RMS.

Test signal LTE:

Signal waveform according to Test Model 1.1, E-TM1.1, clause 6.1.1.1-1, table 6.1.1.1-1 of standard specification 3GPP TS 36.141 V9.3.0 (2010-03).

5.3.1 Downlink

Modulation	Measured at	Path	RBW VBW Span	RF Power (dBm)	RF Power (W)	MIMO* RF Power (W)	Plot -
LTE	Middle	737 MHz (Band 12 (Band Class 19))	3MHz 10MHz 50MHz	43.0	20	40	5.3.1.1 #1
LTE	Middle	751,5 MHz (Band 13 (Band Class 7))	3MHz 10MHz 50MHz	43.0	20	40	5.3.1.2 #1
Maximum output power = 43.0 dBm = 20 W							
Limit Maximum output power (erp) = 1000 W							

table 5.3.1-#1 RF Power Out: §27.50, §2.1046 Test Results Downlink

SISO:

The max RF Power out is 43 dBm, so the maximum antenna gain (x) can be calculated as follow:

Limit = 1000W (erp) = **60 dBm**

Info: 1000W (erp) = 1640W (eirp)

$60 \text{ dBm} > 43 \text{ dBm} + x \rightarrow x = 60 \text{ dBm} - 43 \text{ dBm} = \underline{17 \text{ dBd}}$

$x \text{ dBi} = 17 \text{ dBd} + 2.15 = \underline{19.15 \text{ dBi}}$

=> The antenna that will be used for the complete system have to have a gain lower than 19.15 dBi, relative to a dipol.

*MIMO:

MIMO path test results see FCC ID XS5-UEUH781719P.

If the DUT used in MIMO configuration according to KDB 662911, the MIMO Max RF Power is the sum of the RF power from the SISO path and MIMO path.

MIMO Max RF Power = SISO path RF Power + MIMO path RF Power

MIMO Max RF Power = 20 W + 20 W = 40 W = 46 dBm



The MIMO max RF Power out is 46 dBm, so the maximum antenna gain (x) can be calculated as follow:

Limit = 1000W (erp) = **60 dBm**

Info: 1000W (erp) = 1640W (eirp)

$$60 \text{ dBm} > 46 \text{ dBm} + x \text{ -----> } x = 60 \text{ dBm} - 46 \text{ dBm} = \underline{14 \text{ dBd}}$$

$$x \text{ dBi} = 14 \text{ dBd} + 2.15 = \underline{16.15 \text{ dBi}}$$

=> The antenna that will be used for the complete system have to have a gain lower than 16.15 dBi, relative to a dipol.

Modulation	Pin / dBm (Ref. point A)
LTE (Band 12 (Band Class 19))	-21.8
LTE (Band 13 (Band Class 7))	-22.1

table 5.3.1-#2 RF Power Out: §27.50, §2.1046 Test Results Downlink Input power

5.3.1.1 LTE 728 – 746MHz

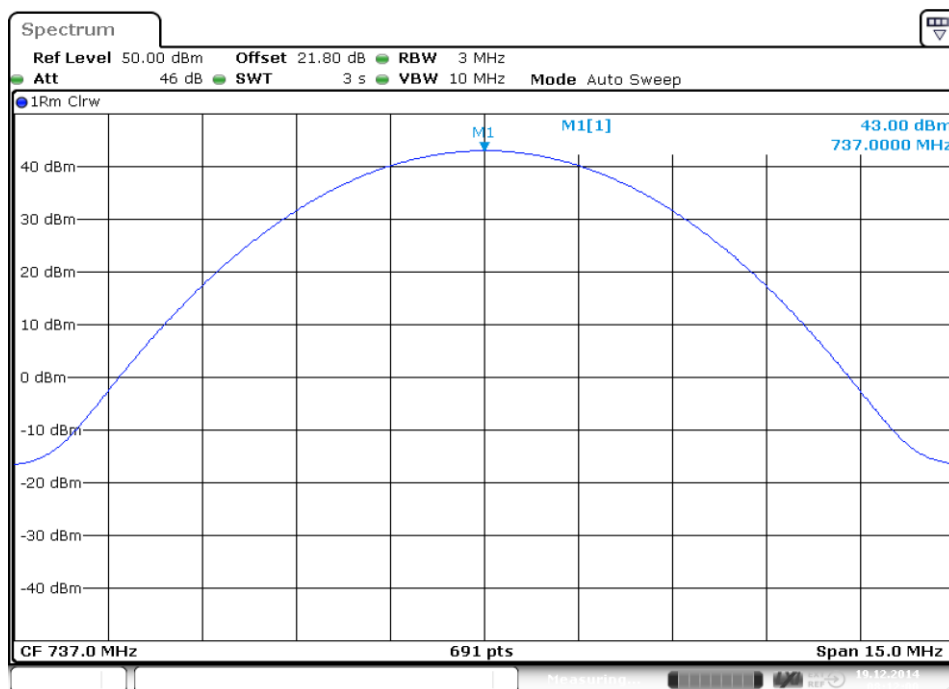

Date: 19.DEC.2014 08:12:00

plot 5.3.1.1-#1 RF Power Out: §27.50, §2.1046; Downlink; LTE 728 – 746MHz Middle



5.3.1.2 LTE 746 – 757MHz

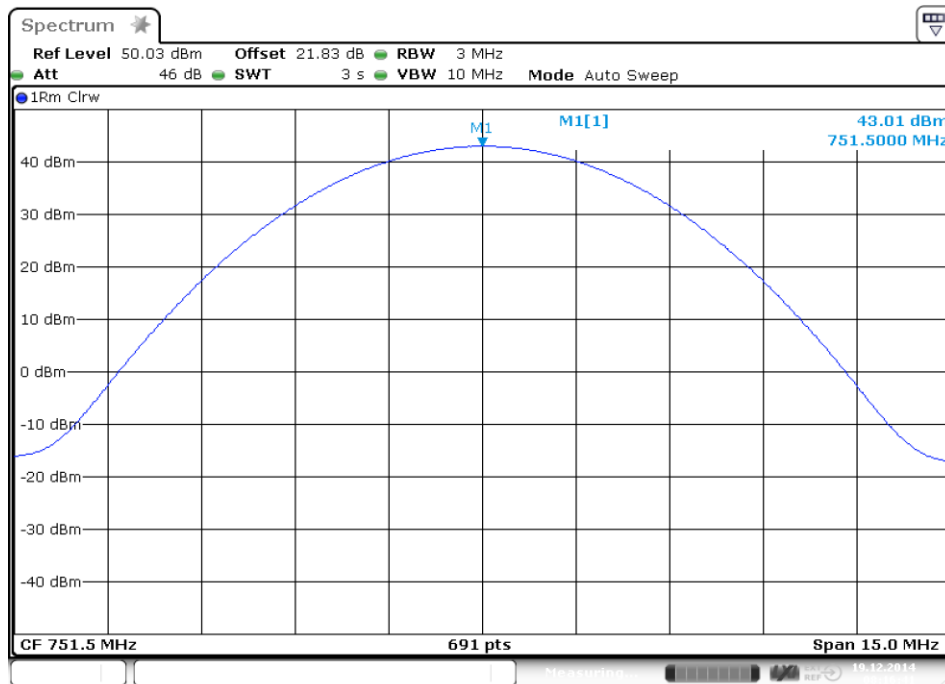

Date: 19.DEC.2014 08:16:41

plot 5.3.1.2-#1 RF Power Out: §27.50, §2.1046; Downlink; LTE 746 – 757MHz Middle

5.3.2 Uplink

n.a.

Note: The EUT does not transmit over the air in the uplink direction.

5.4 Summary test result

Test result	complies, according the plots above
Tested by:	F. Bengesser
Date:	19.12.2014



6 Occupied Bandwidth: §2.1049

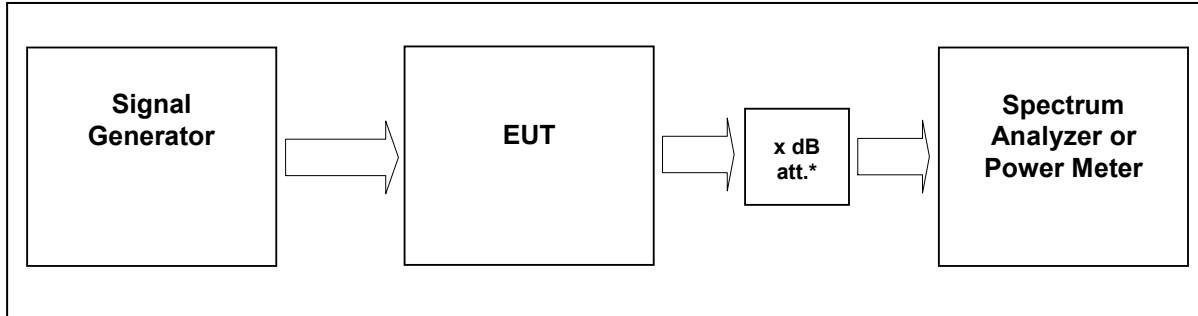

External Attenuator DL x dB = 20 dB
figure 6-#1 Test setup: Occupied Bandwidth: §2.1049

Measurement uncertainty	± 0,38 dB
Test equipment used	9069, 9046, 9236, 7406, 7157, 7158, 7289, 7290, 7385

6.1 Limit

The spectral shape of the output should look similar to input for all modulations.

6.2 Test method

Para. No.2.1049

The occupied bandwidth, that is the frequency bandwidth such that, below its lower and above its upper frequency limits, the mean powers radiated are each equal to 0.5 percent of the total mean power radiated by a given emission shall be measured under the following conditions as applicable:

6.3 Test results

6.3.1 Downlink

Detector PK.

Modulation	Measured at	Path	RBW VBW Span	Occupied Bandwidth / MHz	Plot #
LTE	Middle	737 MHz Band 12 (Band Class 19)	30 kHz 300 kHz 5 MHz	1.136	6.3.1.1 #1, #2
LTE	Middle	751,5 MHz Band 13 (Band Class 7)	30 kHz 300 kHz 5 MHz	1.143	6.3.1.2 #1, #2



Modulation	Measured at	Path	RBW VBW Span	26dB Bandwidth / MHz	Plot #
LTE	Middle	737 MHz Band 12 (Band Class 19)	30 kHz 300 kHz 5 MHz	1.302	6.3.2.1 #1, #2
LTE	Middle	751,5 MHz Band 13 (Band Class 7)	30 kHz 300 kHz 5 MHz	1.302	6.3.2.2 #1, #2

table 6.3-#1 Occupied Bandwidth: §2.1049 Test results

6.3.1.1 LTE 728 – 746MHz

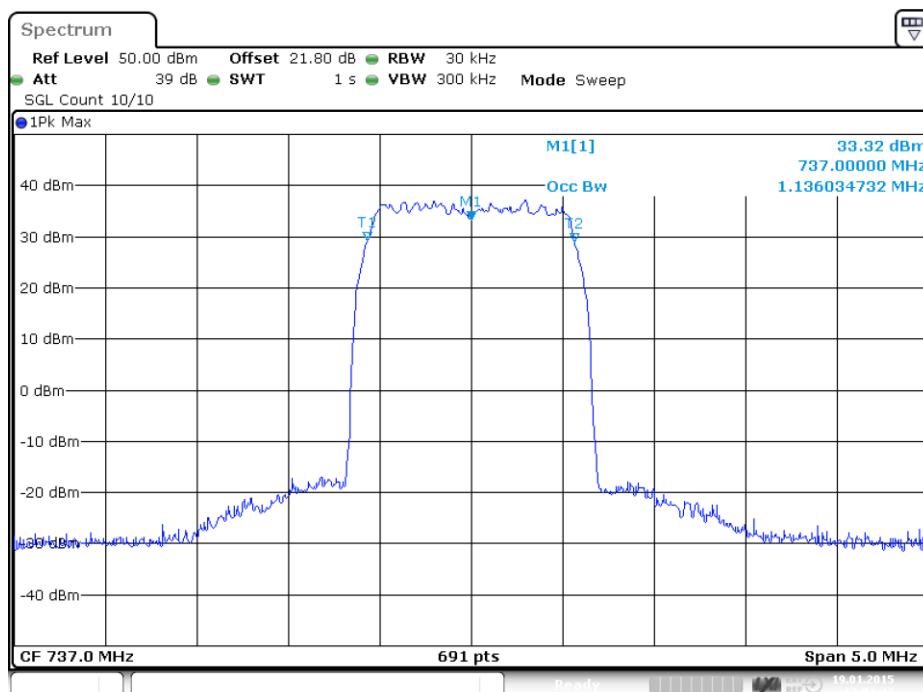

Date: 19.JAN.2015 12:04:22

plot 6.3.1.1-#1 Occupied Bandwidth: §2.1049; Test results; Downlink; LTE 728 – 746MHz Output

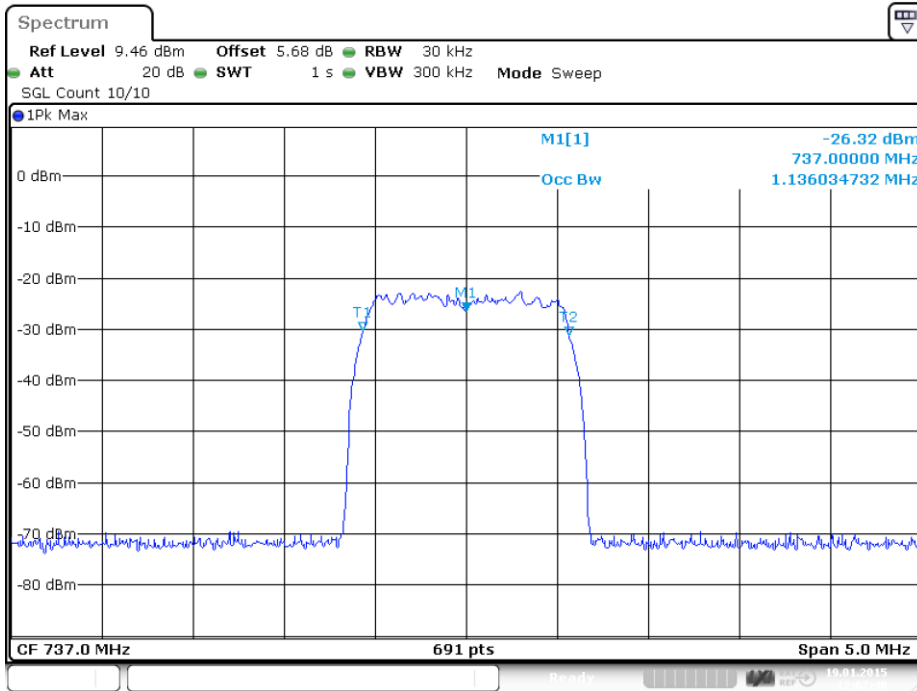

Date: 19.JAN.2015 12:07:40

plot 6.3.1.1-#2 Occupied Bandwidth: \$2.1049; Test results; Downlink; LTE 728 – 746MHz Input

6.3.1.2 LTE 746 – 757MHz

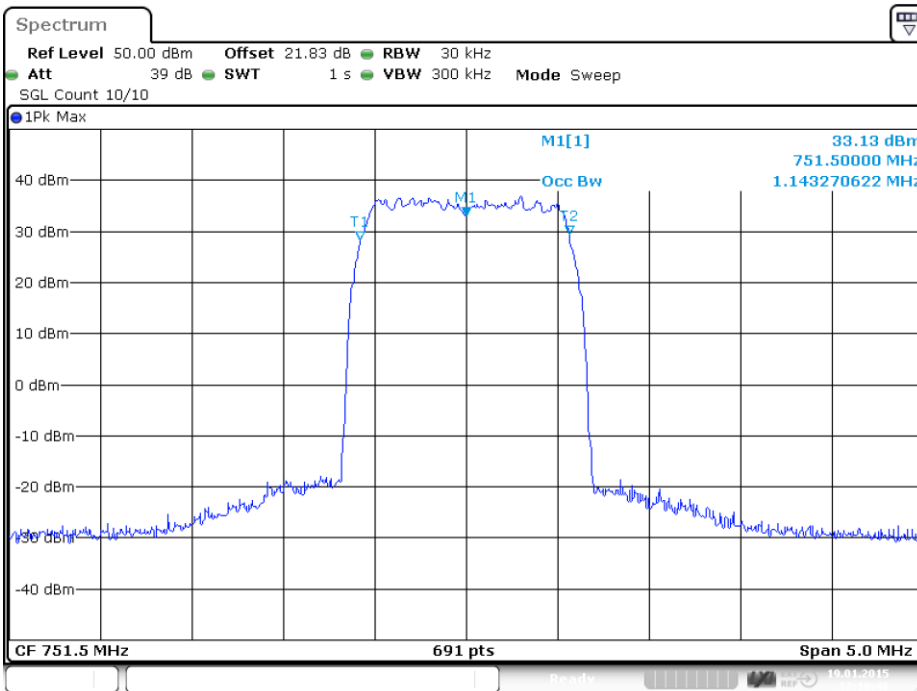

Date: 19.JAN.2015 12:10:48

plot 6.3.1.2-#1 Occupied Bandwidth: \$2.1049; Test results; Downlink; LTE 746 – 757MHz Output

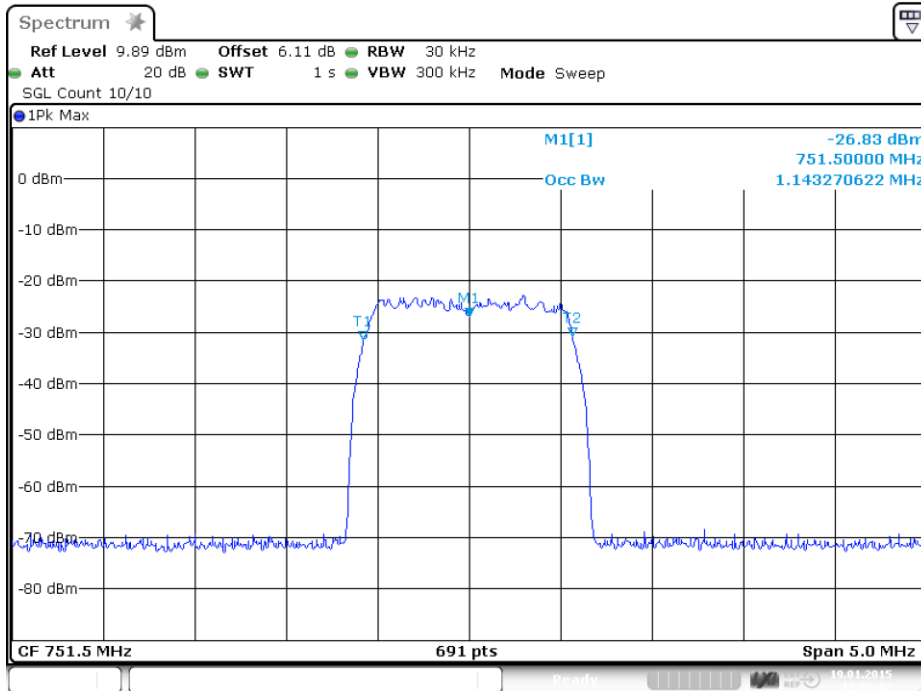

plot 6.3.1.2-#2 Occupied Bandwidth: §2.1049; Test results; Downlink; LTE 746 – 757MHz Input

6.3.2 26dB Bandwidth

6.3.2.1 LTE 728 – 746MHz

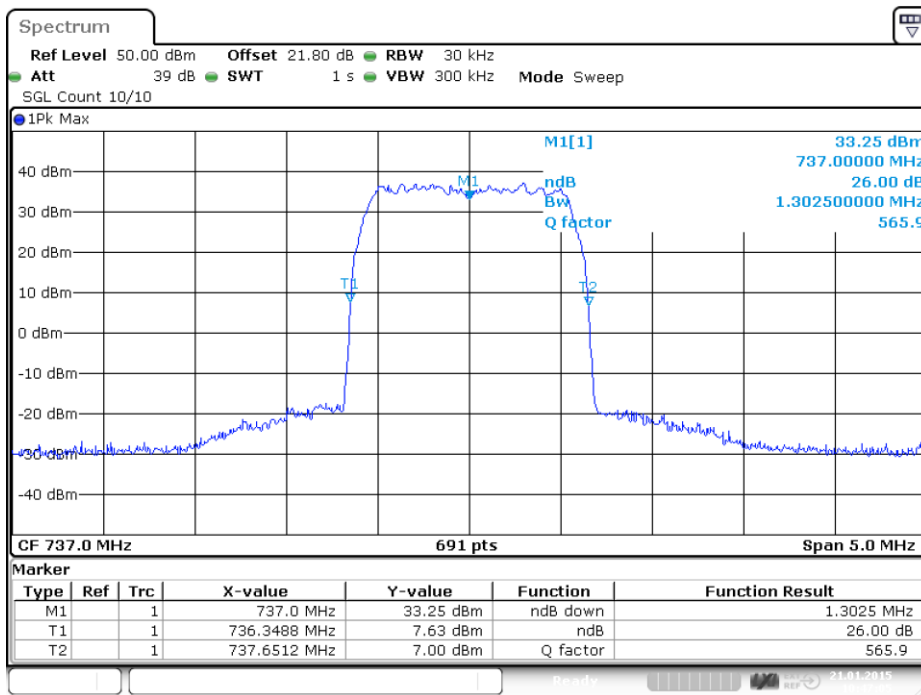

plot 6.3.2.1-#1 Occupied Bandwidth: §2.1049; Test results; 26dB Bandwidth; LTE 728 – 746MHz Output

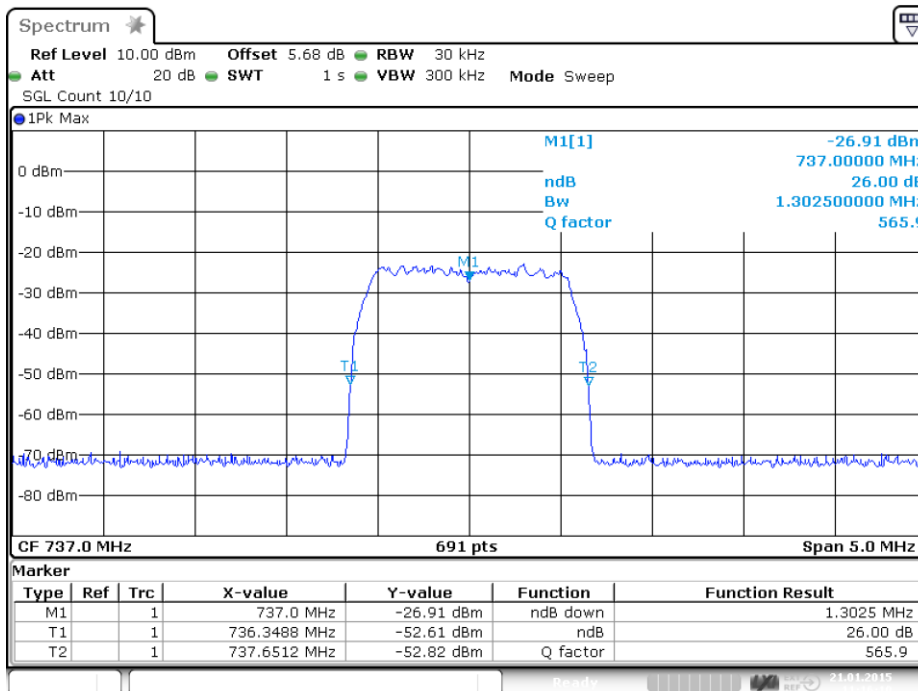

Date: 21.JAN.2015 11:16:10

plot 6.3.2.1-#2 Occupied Bandwidth: \$2.1049; Test results; 26dB Bandwidth; LTE 728 – 746MHz Input

6.3.2.2 LTE 746 – 757MHz

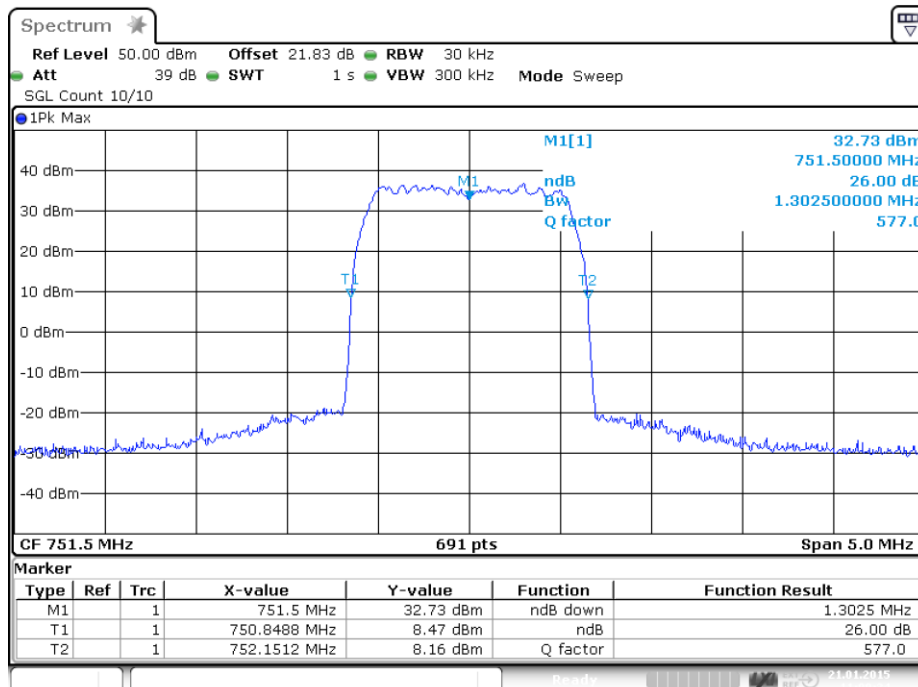

Date: 21.JAN.2015 11:09:33

plot 6.3.2.2-#1 Occupied Bandwidth: \$2.1049; Test results; 26dB Bandwidth; LTE 746 – 757MHz Output

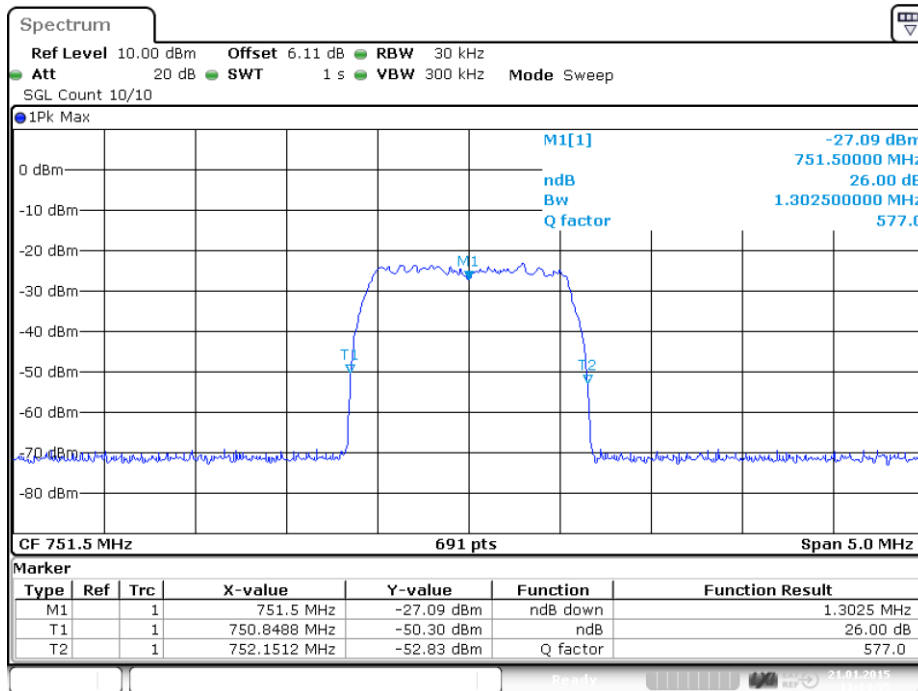

Date: 21.JAN.2015 11:14:55

plot 6.3.2.2-#2 Occupied Bandwidth: §2.1049; Test results; 26dB Bandwidth; LTE 746 – 757MHz Input

6.3.3 Uplink

n.a.

Note: The EUT does not transmit over the air in the uplink direction.

6.4 Summary test result

Test result	complies, according the plots above
Tested by:	F. Bengesser
Date:	21.01.2015



7 Spurious Emissions at Antenna Terminals: §27.53, §2.1051

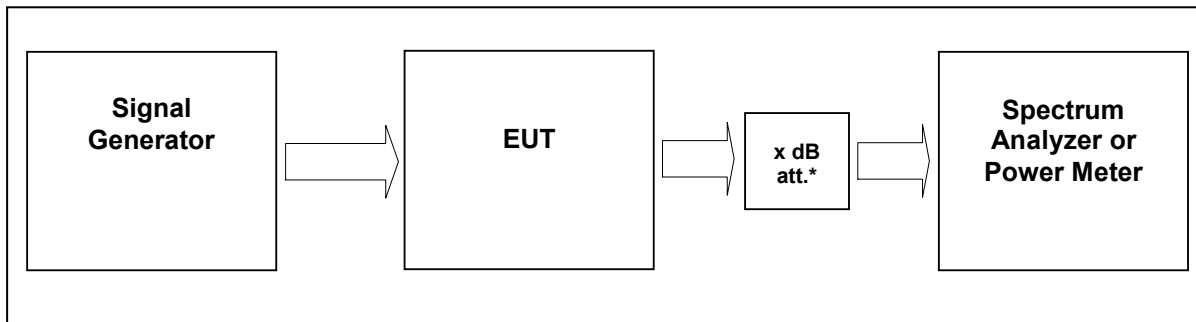

External Attenuator DL x dB = 20 dB
 figure 7-#1 Test setup: Spurious Emissions at Antenna Terminals: §27.53, §2.1051

Measurement uncertainty	± 0,54 dB ± 1,2 dB ± 1,5 dB	9 kHz to 3 GHz 3 GHz to 7 GHz 7 GHz to 26 GHz
Test equipment used	9069, 9046, 9236, 7406, 7157, 7158, 7289, 7290, 7385	

7.1 Limit

Minimum standard:

Para. No.27.53 (c), (f) and (g)

(c) For operations in the 746–758 MHz band and the 776–788 MHz band, the power of any emission outside the licensee's frequency band(s) of operation shall be attenuated below the transmitter power (P) within the licensed band(s) of operation, measured in watts, in accordance with the following:

(1) On any frequency outside the 746–758 MHz band, the power of any emission shall be attenuated outside the band below the transmitter power (P) by at least $43 + 10 \log (P)$ dB;

(3) On all frequencies between 763–775 MHz and 793–805 MHz, by a factor not less than $76 + 10 \log (P)$ dB in a 6.25 kHz band segment, for base and fixed stations;

(f) For operations in the 746–763 MHz, 775–793 MHz, and 805–806 MHz bands, emissions in the band 1559–1610 MHz shall be limited to -70 dBW/MHz equivalent isotropically radiated power (EIRP) for wideband signals, and -80 dBW EIRP for discrete emissions of less than 700 Hz bandwidth. For the purpose of equipment authorization, a transmitter shall be tested with an antenna that is representative of the type that will be used with the equipment in normal operation.

(g) For operations in the 698–746 MHz band, the power of any emission outside a licensee's frequency band(s) of operation shall be attenuated below the transmitter power (P) within the licensed band(s) of operation, measured in watts, by at least $43 + 10 \log (P)$ dB. Compliance with this provision is based on the use of measurement instrumentation employing a resolution bandwidth of 100 kilohertz or greater. However, in the 100 kilohertz bands immediately outside and adjacent to a licensee's frequency block, a resolution bandwidth of at least 30 kHz may be employed



7.2 Test method

Para. No 2.1051 Measurements required: Spurious emissions at antenna terminals.

The radio frequency voltage or powers generated within the equipment and appearing on a spurious frequency shall be checked at the equipment output terminals when properly loaded with a suitable artificial antenna. Curves or equivalent data shall show the magnitude of each harmonic and other spurious emission that can be detected when the equipment is operated under the conditions specified in § 2.1049 as appropriate. The magnitude of spurious emissions which are attenuated more than 20 dB below the permissible value need not be specified.

[39 FR 5919, Feb. 15, 1974. Redesignated and amended at 63 FR 36599, July 7, 1998]

7.3 Test results

7.3.1 Downlink

Detector: RMS.

Modulation	Carrier	RBW VBW Span	Max. level (dBm)	MIMO Max. level (dBm)	Plot -
LTE Band 12 (Band Class 19)	737 MHz	1MHz 3MHz 30MHz – 8GHz	-32.8	-29.8	7.3.1.1 #1
LTE Band 13 (Band Class 7)	751.5 MHz	1MHz 3MHz 30MHz – 8GHz	-32.4	-29.4	7.3.1.2 #1

table 7.3-#1 Spurious Emissions at Antenna Terminals: §27.53, §2.1051 Test results

If the DUT used in MIMO configuration according to KDB 662911, the summed emission (MIMO Max. Level) is calculated (Max. Level) of the output port plus $10 \log(N_{ANT})$. With ($N_{ANT} = 2$) the MIMO Max. Level (dBm) equals Max. Level (dBm) plus 3dB.



Calculation of the limit according to §27.53 (c)(3):

On all frequencies between 763–775 MHz and 793–805 MHz, by a factor not less than $76 + 10 \log (P)$ dB in a 6.25 kHz band segment, for base and fixed stations;

$P_{out} = 43 \text{ dBm} = 20 \text{ W}$.

$76 + 10 \cdot \log(20\text{W}/1\text{W}) \text{ dB} = 89 \text{ dB Attenuation} \Rightarrow 43\text{dBm} - 89\text{dB} = -46 \text{ dBm}$ in a 6.25 kHz band segment
Spurious measured in the plot with a RBW of 1MHz so the limit is calculated:

$\Rightarrow -46\text{dBm} / 6,25\text{kHz} + 10 \cdot \log(1\text{MHz}/6,25\text{kHz}) = -23,96\text{dBm} / 1\text{MHz}$
(in the frequency range 763–775 MHz and 793–805 MHz)

maximum measured emission level for frequencies between 763–775 MHz and 793–805 MHz is below -30 dBm / 1MHz.

Test passed.

Plots with test result see

plot 7.3.1.3 #2

plot 7.3.1.3 #3

plot 7.3.1.4 #2

plot 7.3.1.4 #3

Considerations to §27.53 (f):

To see if the standard 27.53(f) were met a calculation of the radiated power is necessary. The modulated carrier in the range of 747-757 MHz is working with maximum power and the frequency range of 1559-1610MHz is measured. For the calculation of the radiated power in this band, it was calculated with a typical antenna gain and typical cable loss.

Used 700 MHz narrow band antennas offer a gain of 0 dBi in the in the frequency range 1559 - 1610 MHz, furthermore an antenna cable with a loss of 2 dB is used.

The measured conducted emissions in the frequency range of 1599 - 1610 MHz are below -42.9dBm/MHz (see at plot 7.3.1.3).

Conducted emissions (<-42.9 dBm) + antenna gain (0 dBi) - cable loss (0 dB) = radiated emissions (<-42.9 dBm) which is below the limit of Part 27.53(f).

Even with an antenna gain of 2 dBi (more than worst case) in the frequency range of 1599 - 1610 MHz, we are still under the limit of Part 27.53(f) with a radiated emission of -40.9 dBm.

Therefore the emission limit is met.

Test passed.

Plots with test result see

7.3.1.3

Measurement in the band of 1559 MHz – 1610 MHz



7.3.1.1 LTE 728 – 746MHz

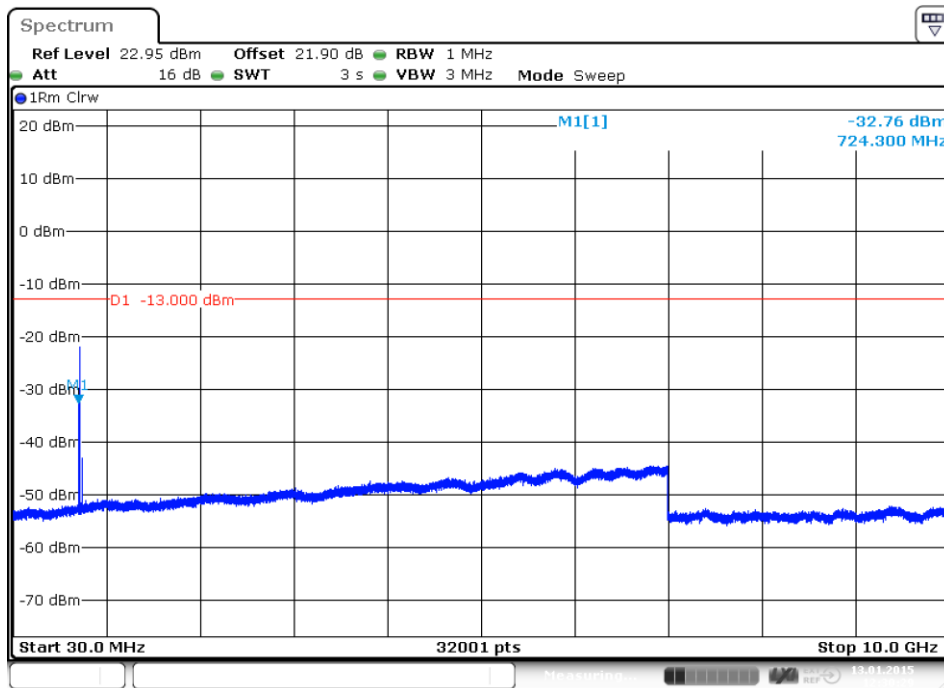

plot 7.3.1.1-#1 Spurious Emissions at Antenna Terminals: §27.53, §2.1051; Test results; Downlink; LTE 728 – 746MHz; 30 MHz – 10 GHz; carrier (737MHz) notched

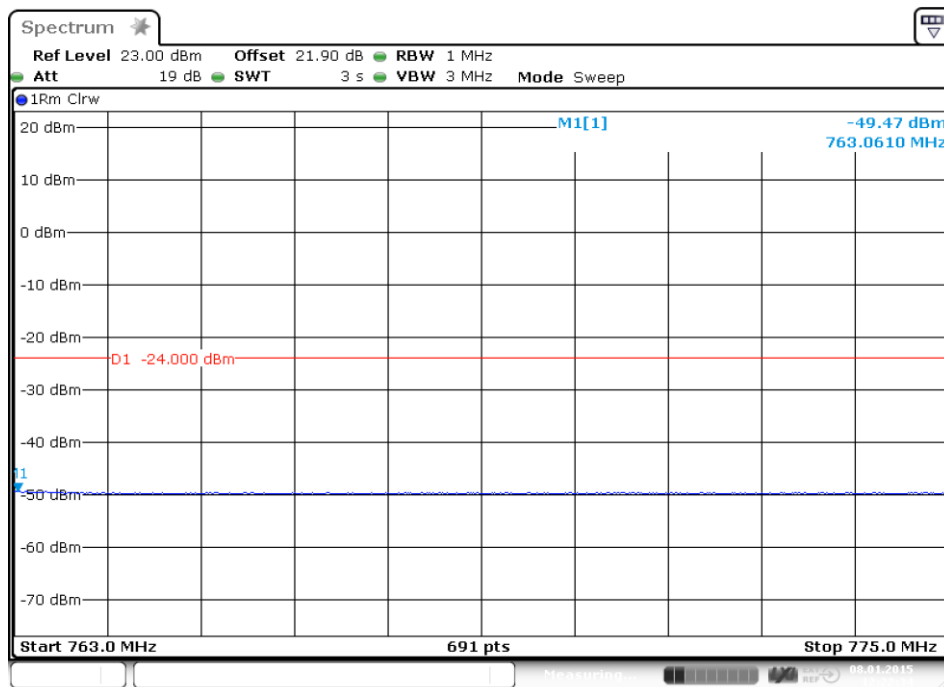

plot 7.3.1.1-#2 Spurious Emissions at Antenna Terminals: §27.53, §2.1051; Test results; Downlink; LTE 728 – 746MHz; 763 MHz – 775 MHz

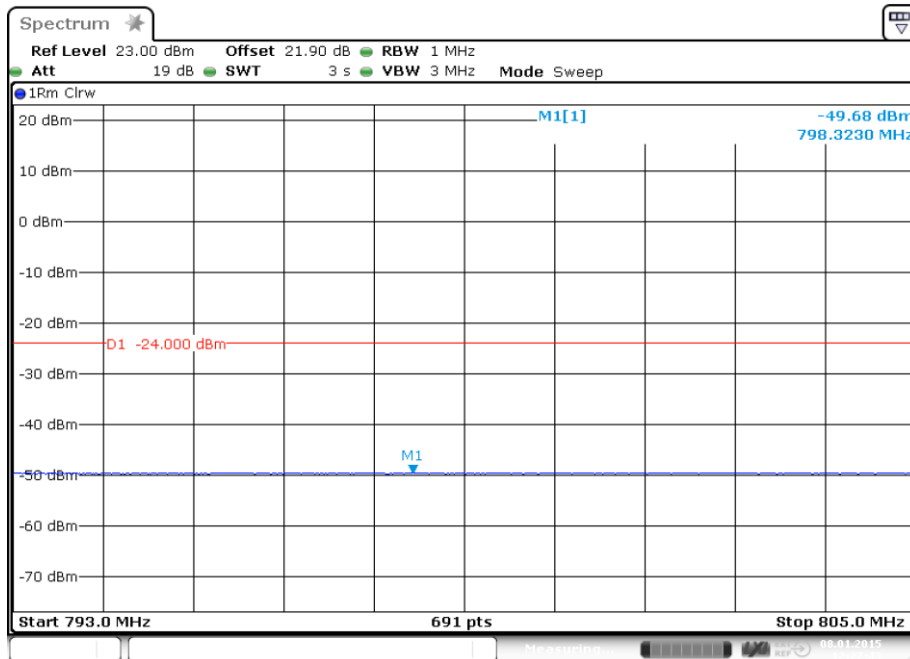

Date: 8.JAN.2015 12:27:43

plot 7.3.1.1-#3 Spurious Emissions at Antenna Terminals: §27.53, §2.1051; Test results; Downlink; LTE 728 – 746MHz; 793 MHz – 805 MHz

7.3.1.2 LTE 746 – 757MHz

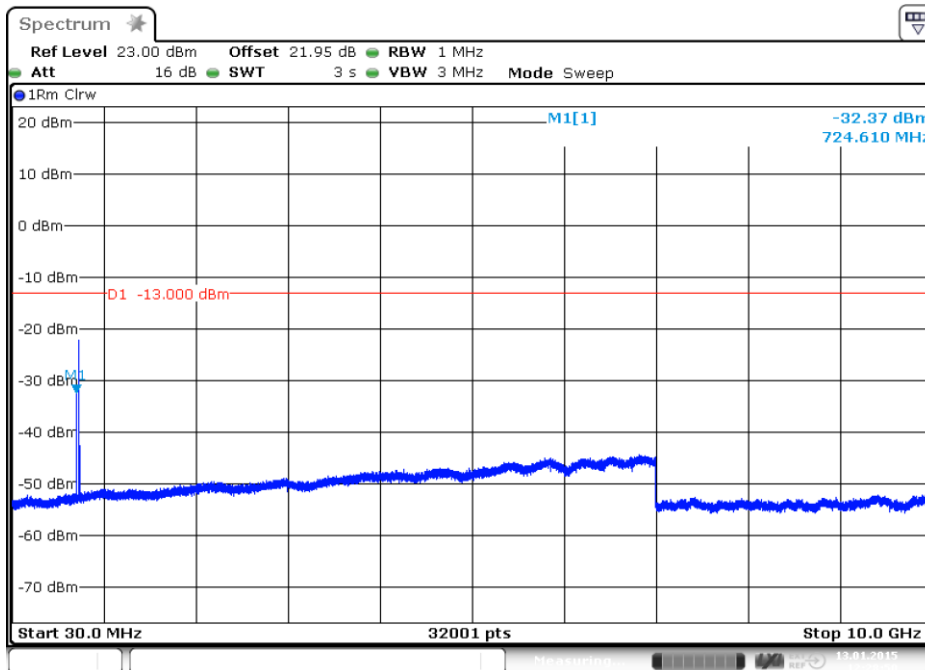

Date: 13.JAN.2015 12:28:50

plot 7.3.1.2-#1 Spurious Emissions at Antenna Terminals: §27.53, §2.1051; Test results; Downlink; LTE 746 – 757MHz; 30 MHz – 10 GHz; carrier (751,5MHz) notched

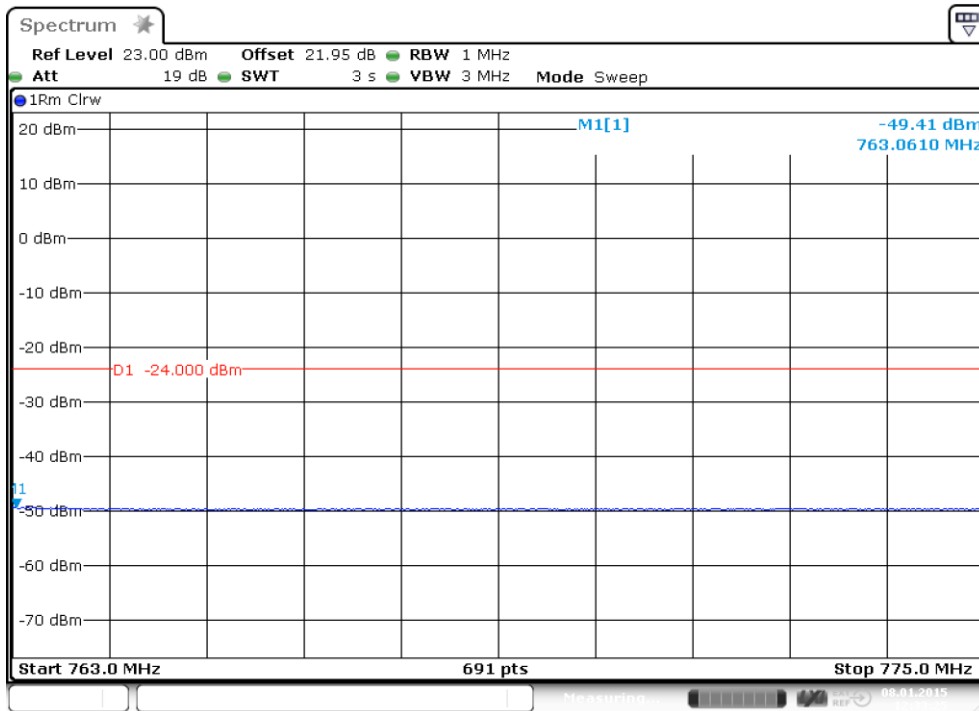

Date: 8.JAN.2015 12:33:25

plot 7.3.1.2-#2 Spurious Emissions at Antenna Terminals: §27.53, §2.1051; Test results; Downlink; LTE 746 – 757MHz; 763 MHz – 775 MHz

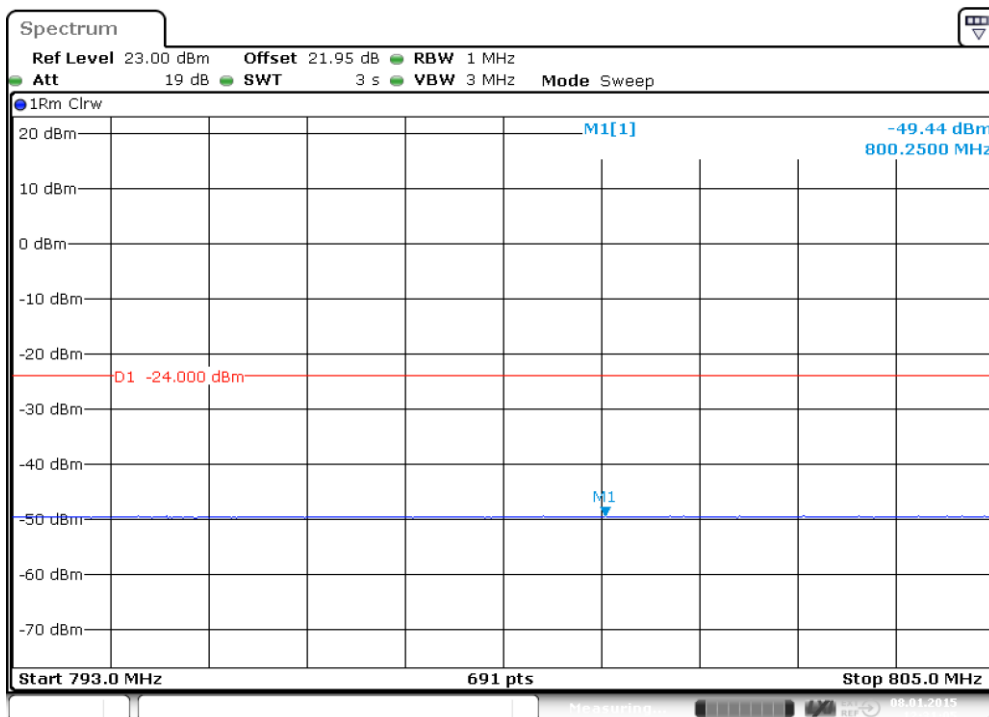

Date: 8.JAN.2015 12:31:05

plot 7.3.1.2-#3 Spurious Emissions at Antenna Terminals: §27.53, §2.1051; Test results; Downlink; LTE 746 – 757MHz; 793 MHz – 805 MHz



7.3.1.3 Measurement in the band of 1559 MHz – 1610 MHz acc. to 27.53(f)

Calculation see 7.3.1 Test results Downlink

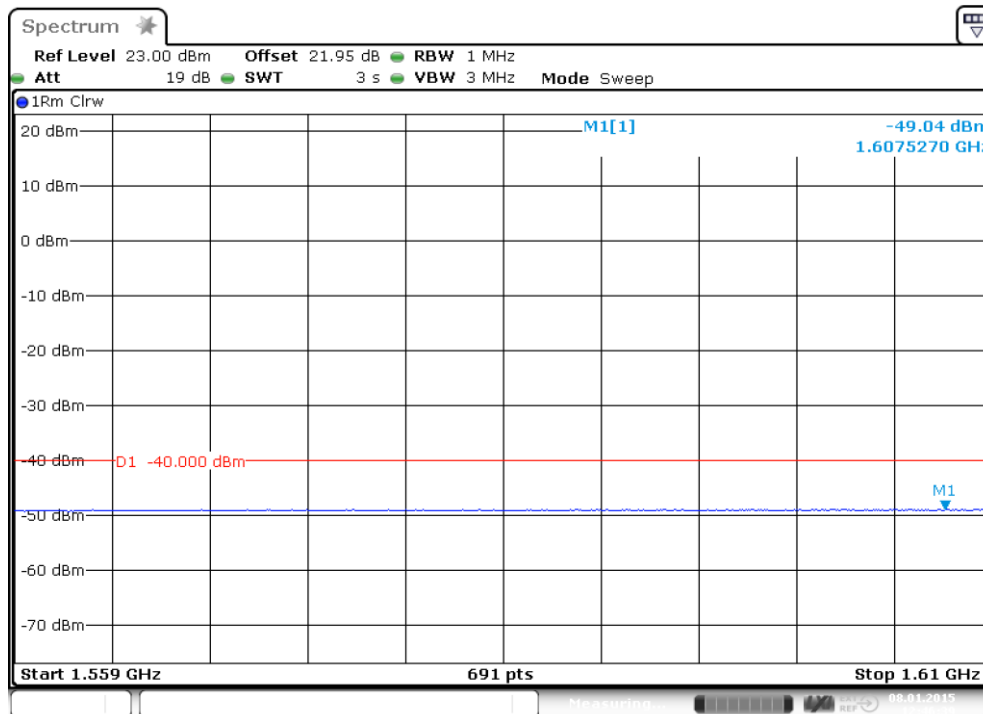

Date: 8.JAN.2015 12:46:39

plot 7.3.1.3-#1 Spurious Emissions at Antenna Terminals: §27.53, §2.1051; Test results; Downlink; Measurement in the band of 1559 MHz – 1610 MHz acc. to 27.53(f)

7.3.2 Uplink

n.a.

Note: The EUT does not transmit over the air in the uplink direction.

7.4 Summary test result

Test result	complies, according the plots above
Tested by:	F. Bengesser
Date:	13.01.2015



8 Intermodulation: §27.53, §2.1051

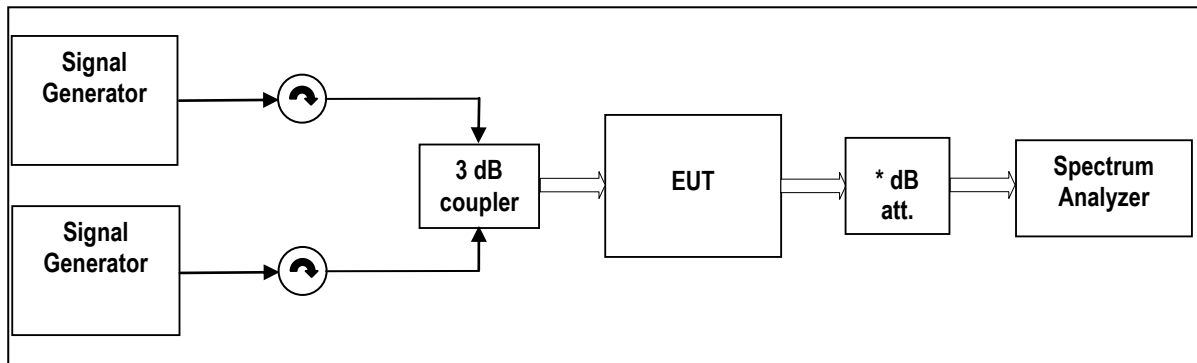

External Attenuator DL x dB = 20 dB
figure 8-#1 Test setup: Intermodulation: §27.53, §2.1051

Measurement uncertainty	± 0,54 dB ± 1,2 dB ± 1,5 dB	9 kHz to 3 GHz 3 GHz to 7 GHz 7 GHz to 26 GHz
Test equipment used	9069, 9046, 9236, 7406, 7157, 7158, 7289, 7290, 7385	

8.1 Limit

Minimum standard:

Para. No.27.53 (c), (f) and (g)

(c) For operations in the 746–758 MHz band and the 776–788 MHz band, the power of any emission outside the licensee's frequency band(s) of operation shall be attenuated below the transmitter power (P) within the licensed band(s) of operation, measured in watts, in accordance with the following:

(1) On any frequency outside the 746–758 MHz band, the power of any emission shall be attenuated outside the band below the transmitter power (P) by at least $43 + 10 \log (P)$ dB;

(3) On all frequencies between 763–775 MHz and 793–805 MHz, by a factor not less than $76 + 10 \log (P)$ dB in a 6.25 kHz band segment, for base and fixed stations;

(f) For operations in the 746–763 MHz, 775–793 MHz, and 805–806 MHz bands, emissions in the band 1559–1610 MHz shall be limited to -70 dBW/MHz equivalent isotropically radiated power (EIRP) for wideband signals, and -80 dBW EIRP for discrete emissions of less than 700 Hz bandwidth. For the purpose of equipment authorization, a transmitter shall be tested with an antenna that is representative of the type that will be used with the equipment in normal operation.

(g) For operations in the 698–746 MHz band, the power of any emission outside a licensee's frequency band(s) of operation shall be attenuated below the transmitter power (P) within the licensed band(s) of operation, measured in watts, by at least $43 + 10 \log (P)$ dB. Compliance with this provision is based on the use of measurement instrumentation employing a resolution bandwidth of 100 kilohertz or greater. However, in the 100 kilohertz bands immediately outside and adjacent to a licensee's frequency block, a resolution bandwidth of at least 30 kHz may be employed



8.2 Test method

Para. No 2.1051 Measurements required: Spurious emissions at antenna terminals.

The radio frequency voltage or powers generated within the equipment and appearing on a spurious frequency shall be checked at the equipment output terminals when properly loaded with a suitable artificial antenna. Curves or equivalent data shall show the magnitude of each harmonic and other spurious emission that can be detected when the equipment is operated under the conditions specified in § 2.1049 as appropriate. The magnitude of spurious emissions which are attenuated more than 20 dB below the permissible value need not be specified.

[39 FR 5919, Feb. 15, 1974. Redesignated and amended at 63 FR 36599, July 7, 1998]

8.3 Test results

8.3.1 Downlink

Detector: RMS.

Modulation	Measured at Band Edge	Carriers	RBW VBW Span	Max. level (dBm)	MIMO Max. level (dBm)	Plot -
LTE Band 12 (Band Class 19)	Lower Edge	728,7 MHz 730,1 MHz	30kHz 300kHz 6MHz	-30.9	-27.9	8.3.1.1 #1
	Upper Edge	743,9 MHz 745,3 MHz				#2
LTE Band 13 (Band Class 7)	Lower Edge	746,7 MHz 748,1 MHz	30kHz 300kHz 6MHz	-32.1	-29.1	8.3.1.2 #1
	Upper Edge	754,9 MHz 756,3 MHz				#2

table 8.3-#1 Intermodulation: §27.53, §2.1051 Test results

If the DUT used in MIMO configuration according to KDB 662911, the summed emission (MIMO Max. Level) is calculated (Max. Level) of the output port plus $10 \log(N_{ANT})$. With ($N_{ANT} = 2$) the MIMO Max. Level (dBm) equals Max. Level (dBm) plus 3dB.



8.3.1.1 LTE 728 – 746MHz

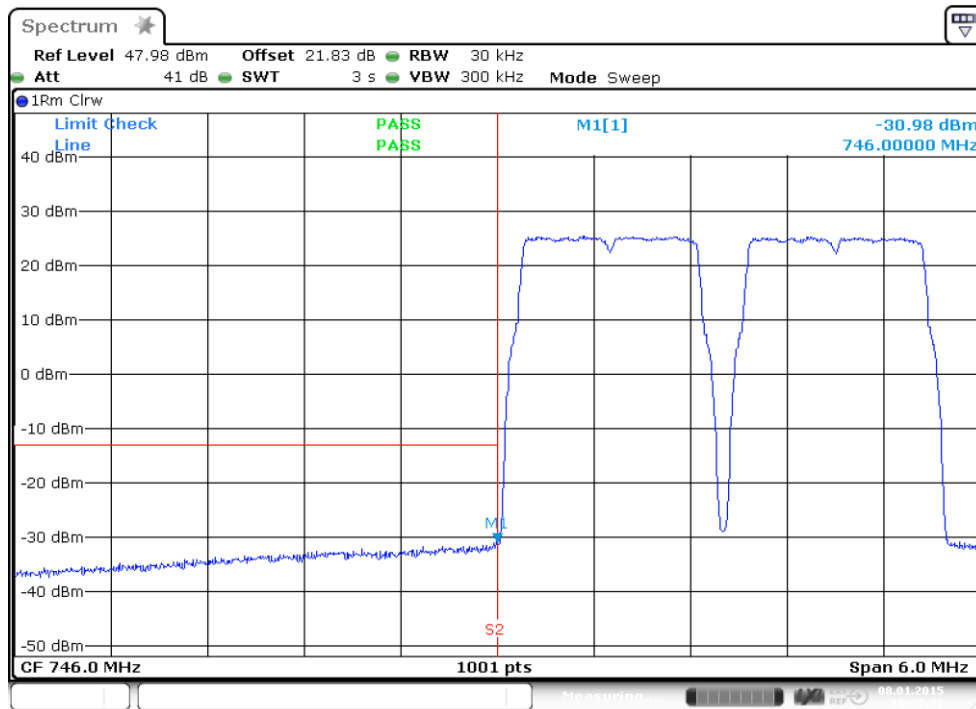

Date: 8.JAN.2015 10:29:33

plot 8.3.1.1-#1 Intermodulation: §27.53, §2.1051; Test results; Downlink; LTE 728 – 746MHz Lower Band Edge

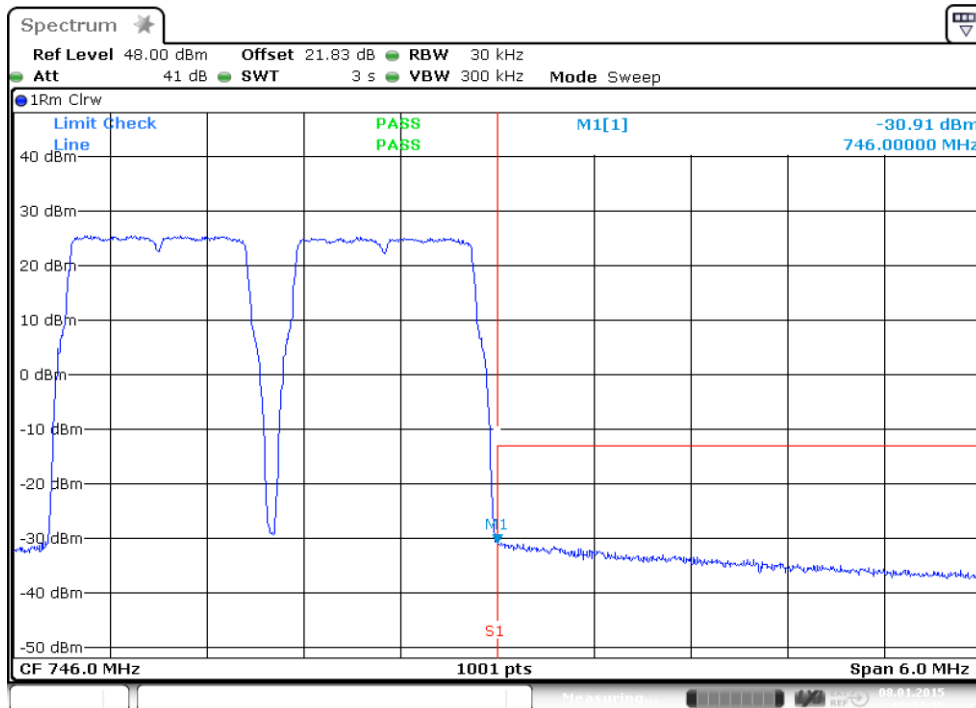

Date: 8.JAN.2015 10:33:17

plot 8.3.1.1-#2 Intermodulation: §27.53, §2.1051; Test results; Downlink; LTE 728 – 746MHz Upper Band Edge



8.3.1.2 LTE 746 – 757MHz

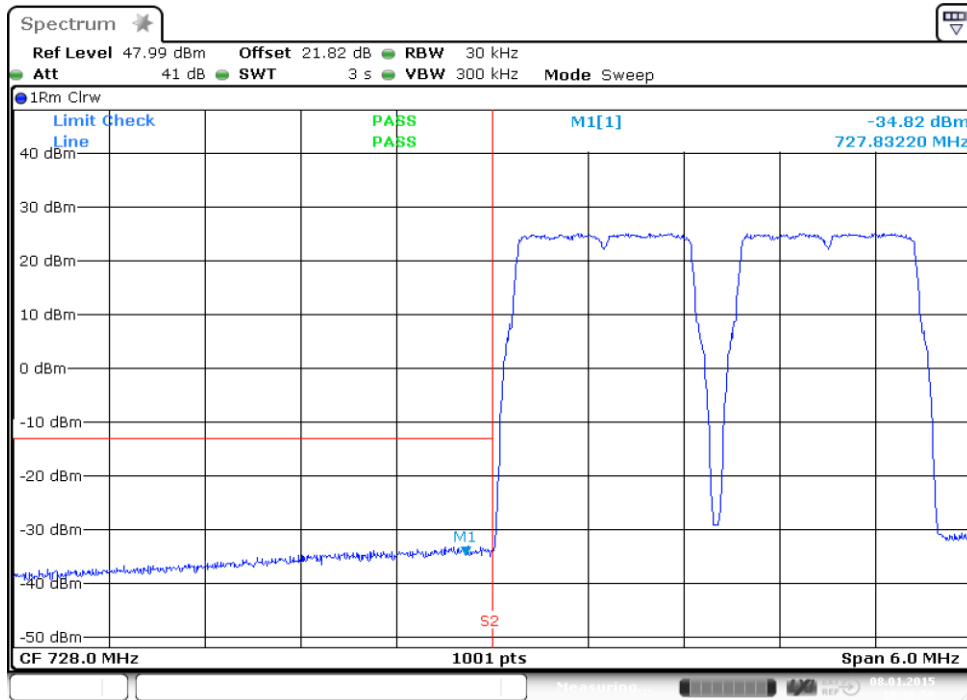

Date: 8.JAN.2015 10:36:51

plot 8.3.1.2-#1 Intermodulation: §27.53, §2.1051; Test results; Downlink; LTE 746 – 757MHz Lower Band Edge

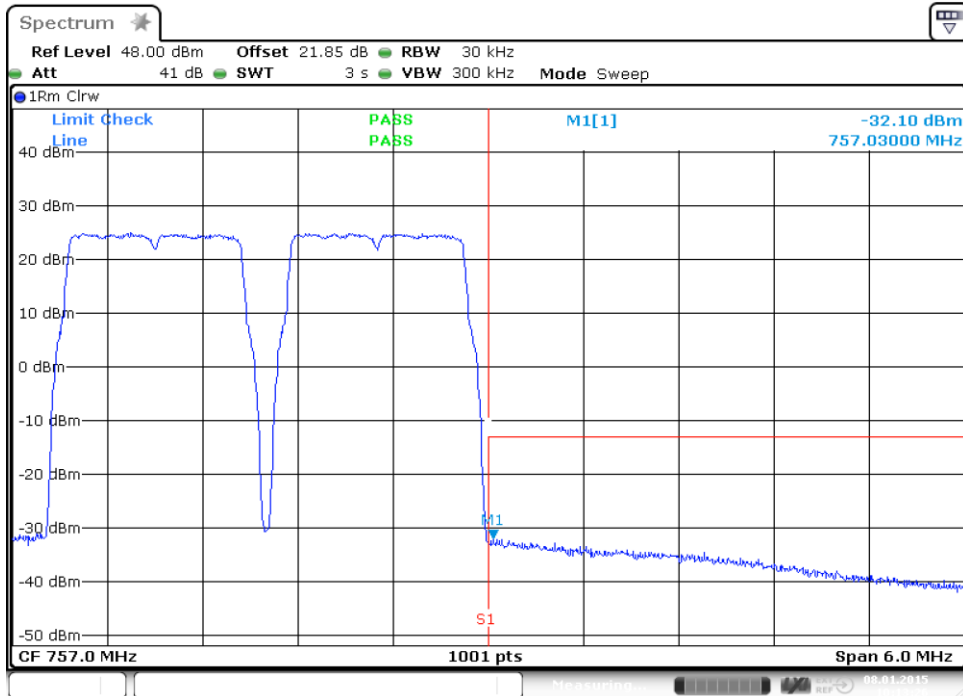

Date: 8.JAN.2015 10:13:26

plot 8.3.1.2-#2 Intermodulation: §27.53, §2.1051; Test results; Downlink; LTE 746 – 757MHz Upper Band Edge



8.3.2 Uplink

n.a.

Note: The EUT does not transmit over the air in the uplink direction.

8.4 Summary test result

Test result	complies, according the plots above
Tested by:	F. Bengesser
Date:	13.01.2015

9 Out of Band Rejection

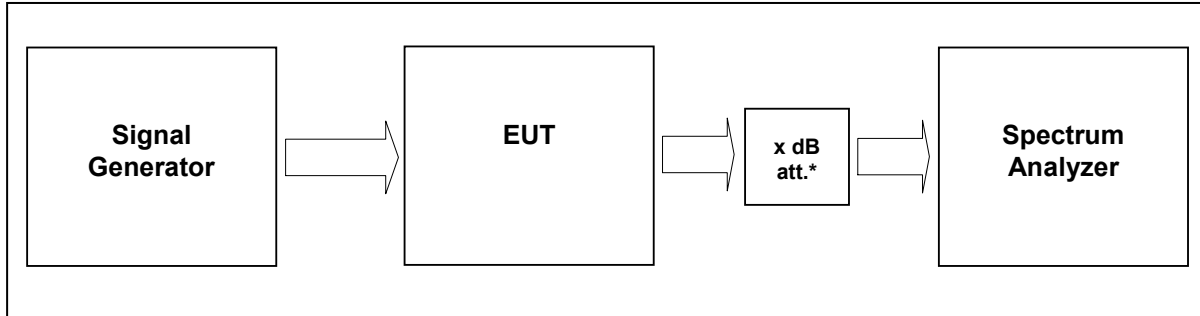

External Attenuator DL x dB = 20 dB
figure 9-#1 Test setup: Out of Band Rejection

Measurement uncertainty	± 0,38 dB
Test equipment used	9069, 9046, 9236, 7406, 7157, 7158, 7289, 7290, 7385

9.1 Limit

KDB 935210 D02 v02

Test for rejection of out of band signals. Filter frequency response plots are acceptable.

9.2 Test method

935210 D03 v02

7.1 Authorized frequency band verification test

9.3 Test results

Detector Peak max hold



9.3.1 Downlink

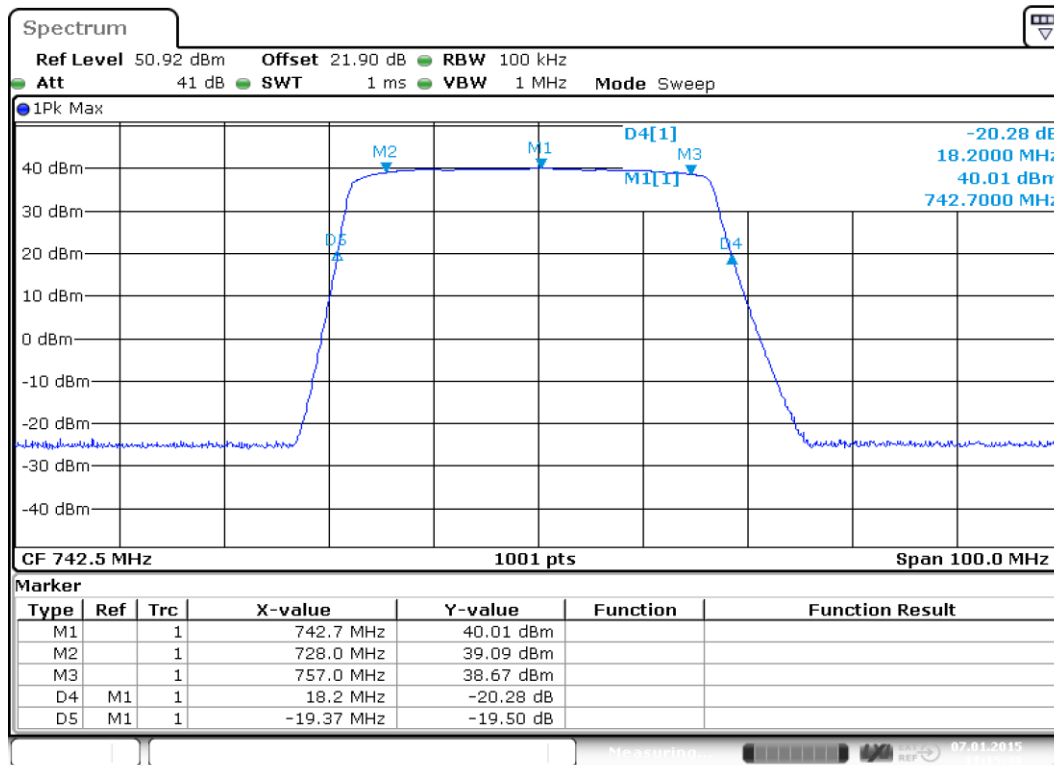

Date: 7.JAN.2015 11:15:50

plot 9.3.1-#1 Out of Band Rejection; Test results; Downlink;

9.3.2 Uplink

n.a.

Note: The EUT does not transmit over the air in the uplink direction.

9.4 Summary test result

Test result	complies, according the plots above
Tested by:	F. Bengesser
Date:	07.01.2015

10 Radiated Spurious Emissions at the ECL (BV): §27.53, §2.1053

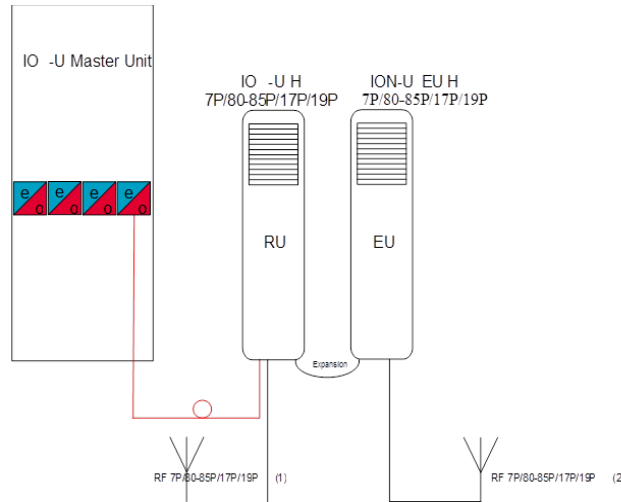

The frequencies bands of the extension unit will be implemented on the master unit with a compensation frequency bands.

About the optical fiber all frequencies will be forwarded to the RU.

At the RU the optical signals will be converted into RF signals.

The frequency bands, which were not changed will be filtered by the duplexer, then amplified and transmitted by the RU.

The replaced frequency bands filtered out and forwarded via the Cable Bridge to the EU. These frequencies converted back by the conversion module (FCM) to their original frequencies band and then they were amplified and sent out.

The worst case mode for the radiated emission is the MIMO mode. Both devices are operated with the maximum power, at the same time.



picture 8.1: label (EUT)



picture 8.2: label (auxiliary equipment)

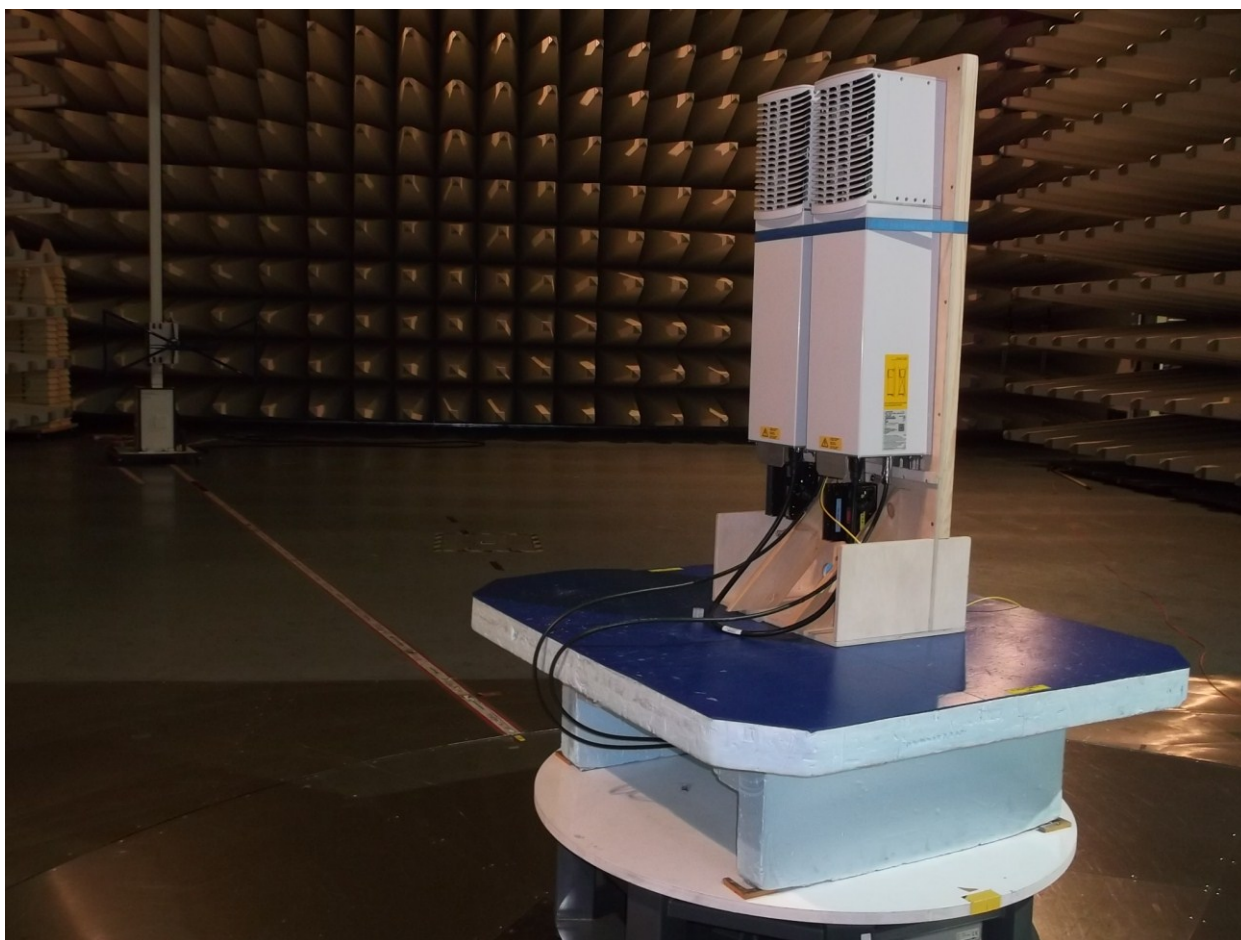

picture 8.3: Test setup: Field Strength Emission <1 GHz @10m in the SAC

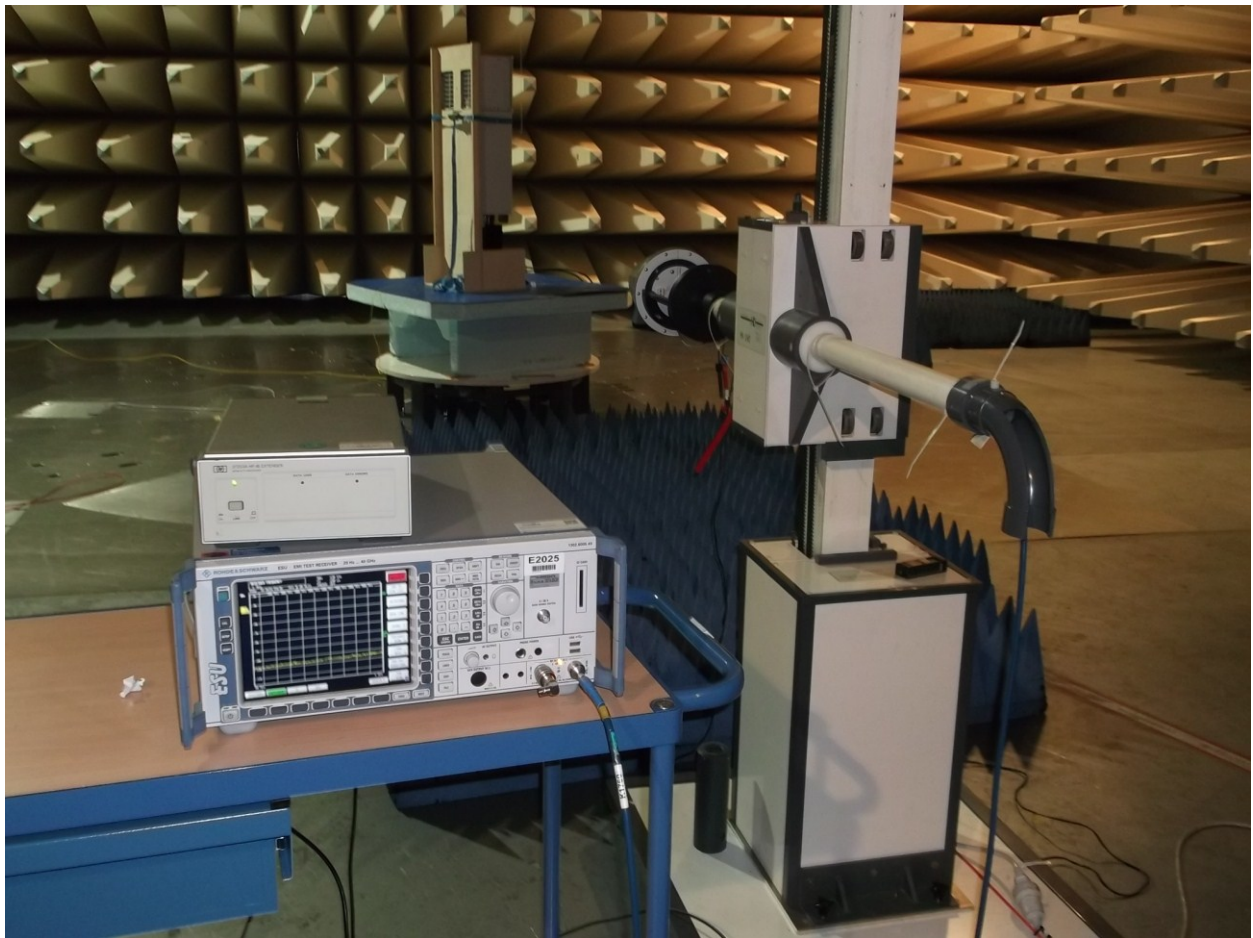

picture 8.4: Test setup: Field Strength Emission >1 GHz @3m in the SAC



This clause specifies requirements for the measurement of radiated emission.

Frequency range	Distance: EUT <-> antenna / location	Limit	Test method
30 MHz – 1 GHz	10 metres / SAC	FCC 47 CFR Part 27.53	TIA/EIA-603-C:2004
1 GHz – 20 GHz	3 metres / SAC	IC RSS-131 sec. 4.4	

Test equipment used:

Designation	Type	Manufacturer	Invent.-no.	Cal.-date	due Cal.- date	used
EMI test receiver	ESU40	Rohde & Schwarz	E2025	12.09.2014	12.09.2015	X
Antenna	CBL 6111	Chase	K1026	27.06.2014	27.06.2015	X
RF Cable	RG214	Frankonia	K1121	20.02.2013	20.02.2015	X
Antenna	HL 025	R&S	K1114	03.03.2014	03.03.2015	X
Preamplifier	AFS4-00102000	Miteq	K838	03.04.2014	03.04.2015	X
RF Cable	Sucoflex 100	Suhner	K1760	03.07.2014	03.07.2015	X

The REMI version 2.135 has been used to maximize radiated emission from the EUT with regards to ANSI C63.4:2009.

Test set-up:

Test location: SAC
 Both, the Fully Anechoic Chamber (FAC) and the Semi Anechoic Chamber (SAC) fulfil the requirements of ANSI C63.4 and CISPR 16-1-4 with regards to NSA and SVSWR.

Test Voltage: 110V / 60 Hz
 Type of EUT: Wall mounted

Measurement uncertainty:

Measurement uncertainty expanded (95% or K=2)	± 4,7 dB for ANSI C63.4 measurement ± 0,5 dB for TIA-603 measurement
--------------------------------------------------	-------------------------------------------------------------------------

10.1 Method of Measurement

Measurement procedure. TIA-603-C

The antenna substitution method is used to determine the equivalent radiated power at spurious frequencies. The spurious emissions are measured at a distance of 3 meters. The EUT is then replaced with a reference substitution antenna with a known gain referenced to a dipole. This antenna is fed with a signal at the spurious frequency. The level of the signal is adjusted to repeat the previously measured level. The resulting eirp is the signal level fed to the reference antenna corrected for gain referenced to an isotropic dipole (see Figure 7.2).

From KDB (AMPLIFIER, BOOSTER, AND REPEATER REMINDER SHEET):

Radiated spurs (enclosure) – Use of CW signal (low, mid, and high freq.) is acceptable rather than all modulations. The Bottom/Middle/Top frequencies for Part 27 F/H are as follows:

- 728/737/746 MHz (§27 Subpart H)
- 746/755/763 MHz (§27 Subpart F)

The maximum RFI field strength was determined during the measurement by rotating the turntable (± 180 degrees) as like defined in ANSI C63.4. A measurement receiver has been used with a RBW 120 kHz up to 1 GHz and 1 MHz above 1 GHz. Steps width during the measurement was half the RBW.

Both, the Fully Anechoic Chamber (FAC) and the Semi Anechoic Chamber (SAC) fulfil the requirements of ANSI C63.4 and CISPR 16-1-4 with regards to NSA and SVSWR.

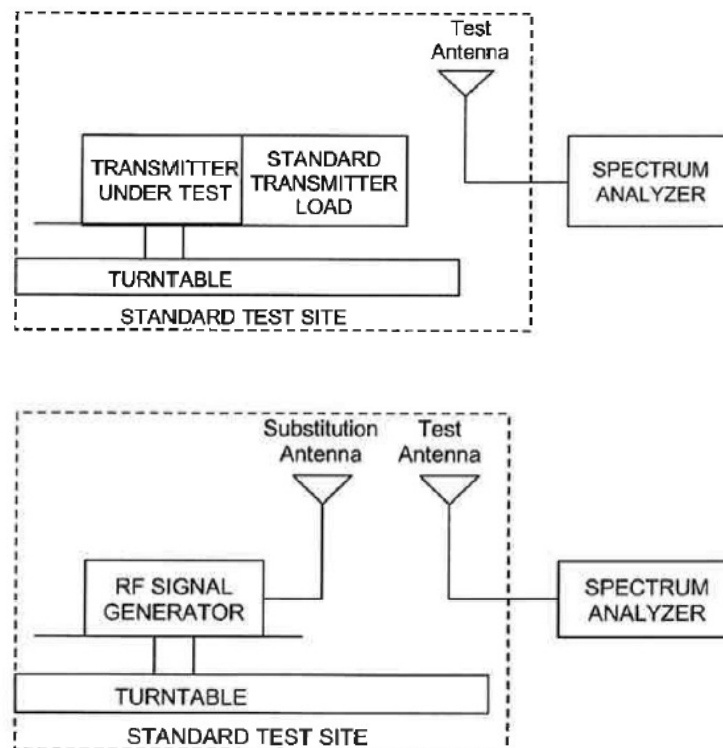

Figure #8.3 Substitution methods TIA/EIA-603-C



10.2 Limit

§27.53 Emission limitations / RSS-GEN sec. 4.9; RSS-131 sec. 4.4

Minimum standard:

Para. No.27.53 (c/d/g)

(c) For operations in the 746–758 MHz band and the 776–788 MHz band, the power of any emission outside the licensee's frequency band(s) of operation shall be attenuated below the transmitter power (P) within the licensed band(s) of operation, measured in watts, in accordance with the following:

(1) On any frequency outside the 746–758 MHz band, the power of any emission shall be attenuated outside the band below the transmitter power (P) by at least $43 + 10 \log (P)$ dB.

(g) For operations in the 698–746 MHz band, the power of any emission outside a licensee's frequency band(s) of operation shall be attenuated below the transmitter power (P) within the licensed band(s) of operation, measured in watts, by at least $43 + 10 \log (P)$ dB. Compliance with this provision is based on the use of measurement instrumentation employing a resolution bandwidth of 100 kilohertz or greater. However, in the 100 kilohertz bands immediately outside and adjacent to a licensee's frequency block, a resolution bandwidth of at least 30 kHz may be employed

The Emission limit is **-13dBm**.

(d) For operations in the 758–763 MHz and 788–793 MHz bands, the power of any emission outside the licensee's frequency bands of operation shall be attenuated below the transmitter power (P) within the licensed band(s) of operation, measured in watts, in accordance with the following:

(1) On all frequencies between 769–775 MHz and 799–805 MHz, by a factor not less than $76 + 10 \log (P)$ dB in a 6.25 kHz band segment, for base and fixed stations;

The Emission limit is:

- **-33dBm** for measurements up to 1GHz
- **-24dBm** for measurements above 1 GHz

These Values have been calculated by a formula, which was a result of an inquiry (No. 141765) of the KDB:

$$Limit = P_{OUT} - (76 + 10LOG(P_{OUT})) - 10LOG(Bwidth / 6.25kHz)$$

10.3 Receiver Settings

	up to 1 GHz	above 1 GHz
Measurement bandwidth	120 kHz	1 MHz
Step width	60 kHz	500 kHz
Dwell time	20ms	
Detector	Peak	Average

10.4 Climatic values in the lab

Temperature	18,5°C
Relative Humidity	45%
Air-pressure	1014 hPa



10.5 Test results

10.5.1 30 MHz to 1 GHz Downlink (Bottom – Middle – Top) Subpart H

Bottom: 728MHz; Middle: 737MHz; Top: 746MHz

Vertical

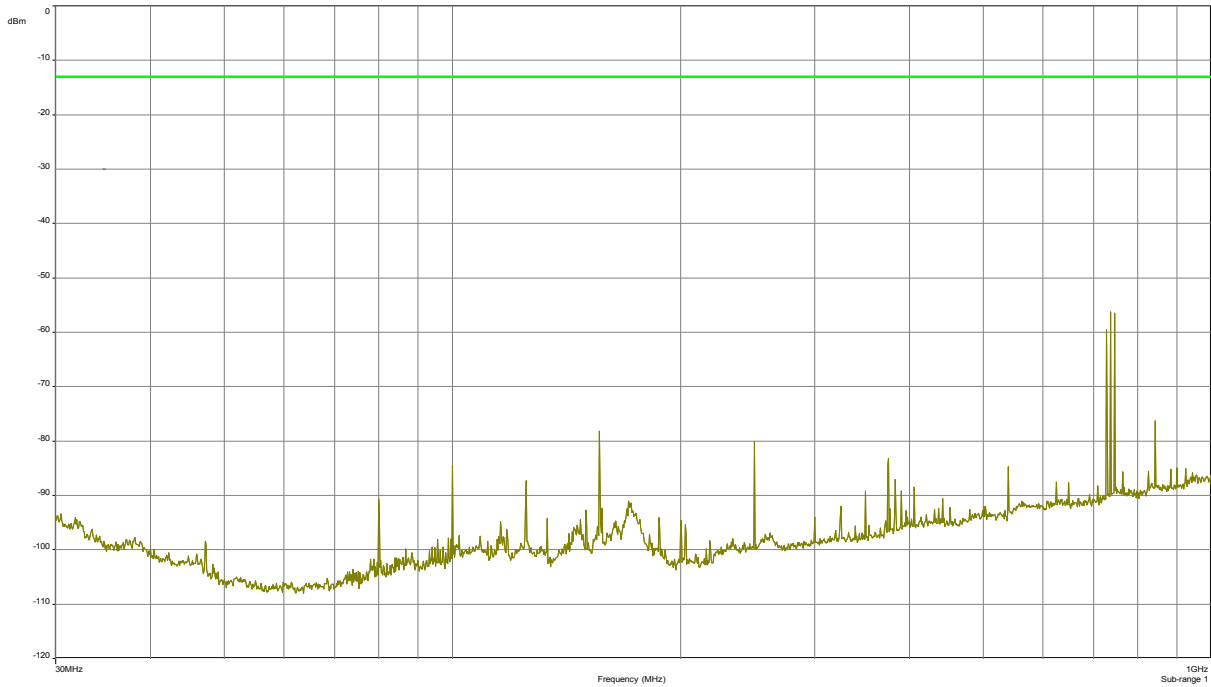

Horizontal

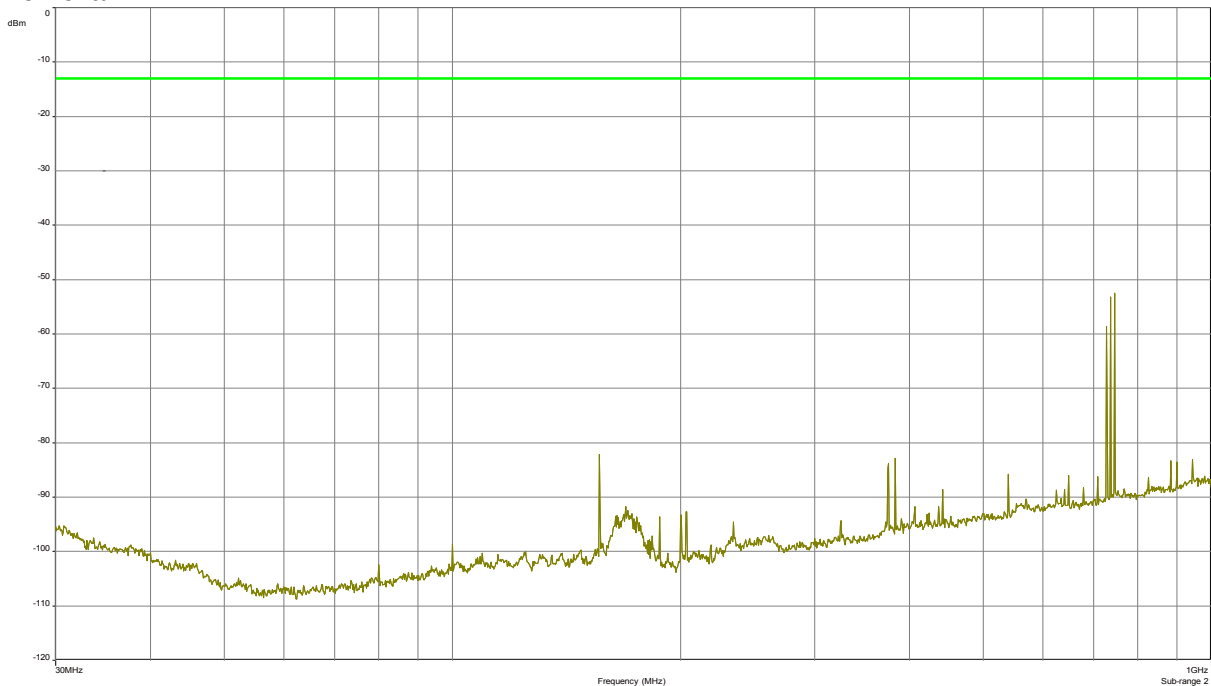

The RF output power is terminated.



10.5.2 30 MHz to 1 GHz Downlink (Bottom – Middle – Top) Subpart F

Bottom: 746MHz; Middle: 751,5MHz; Top: 757MHz

Vertical

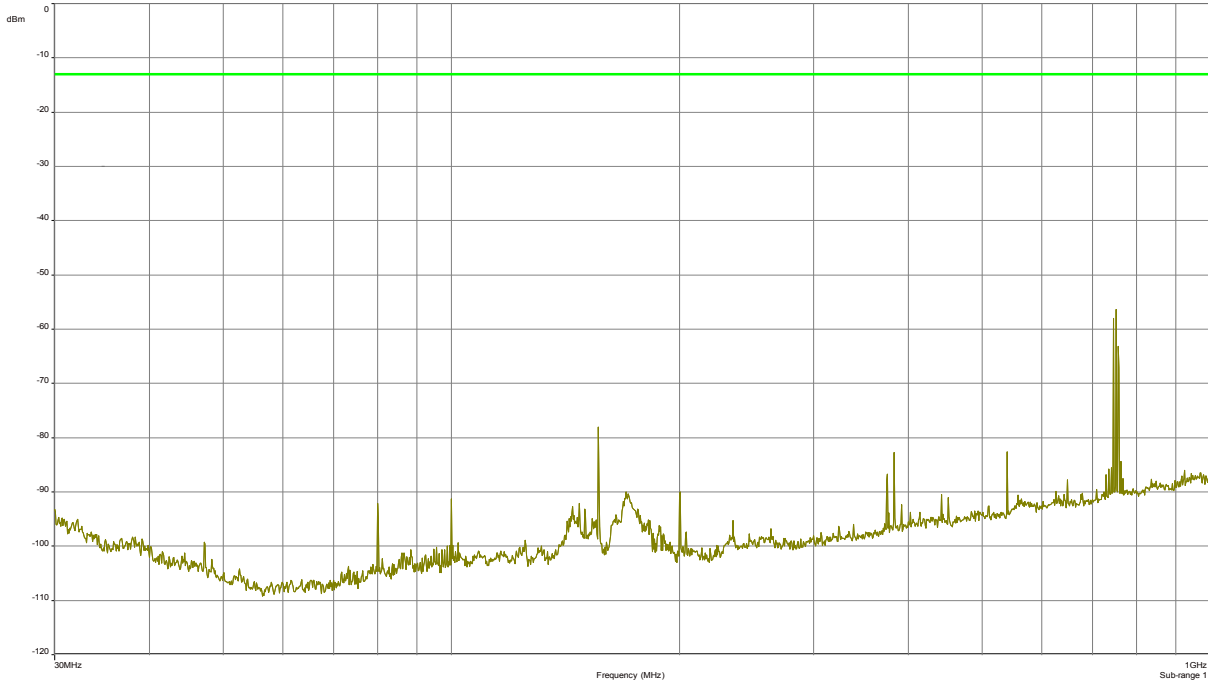

Horizontal

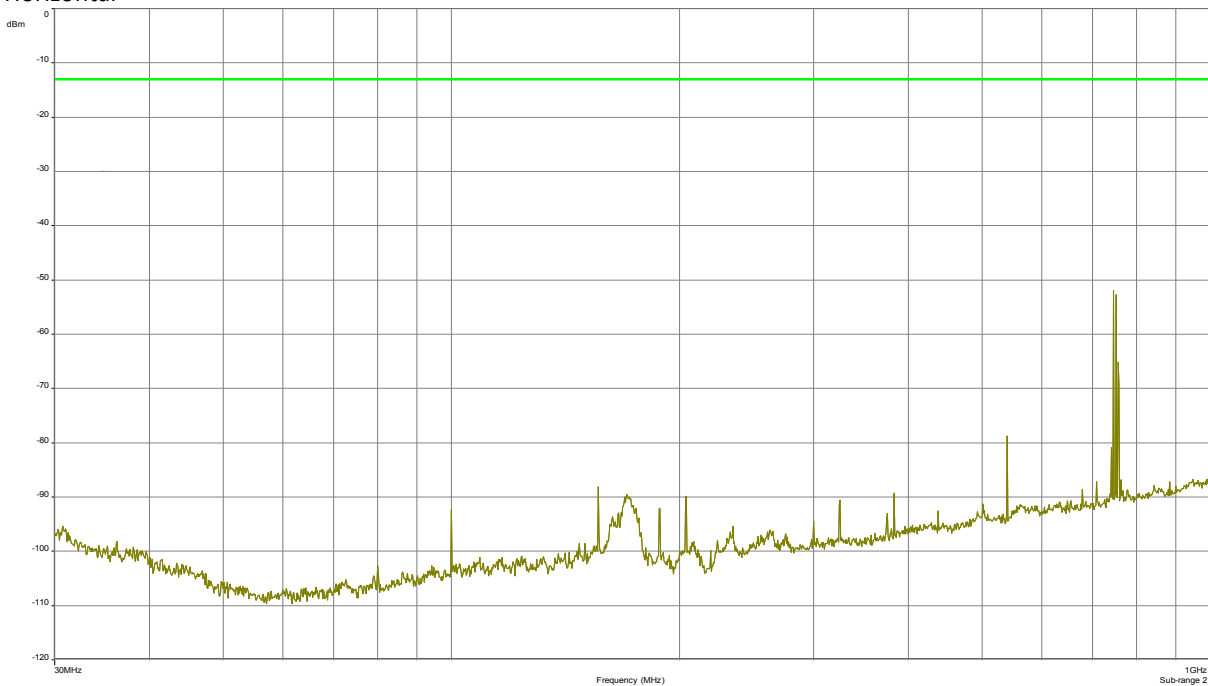

The RF output power is terminated.



10.5.3 30 MHz to 1 GHz Downlink (Middle of all paths)

F1: 742,5 MHz; F2: 878 MHz; F3: 1962,5 MHz; F4: 2132,5 MHz

Vertikal

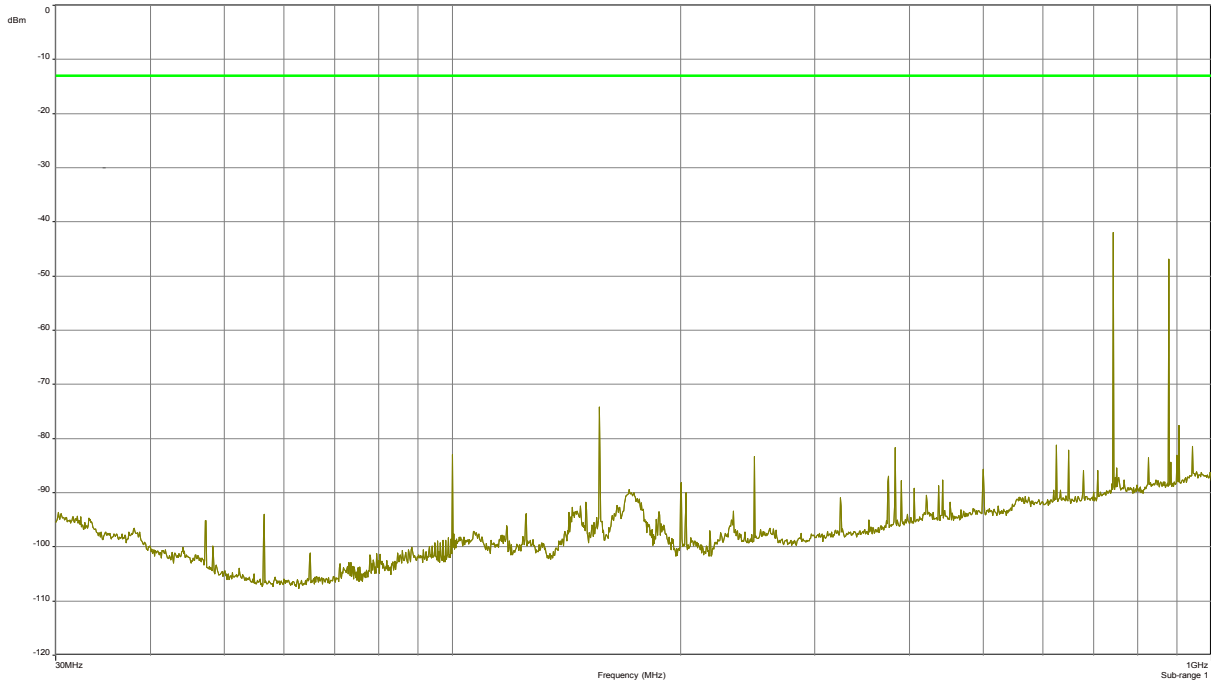

Horizontal

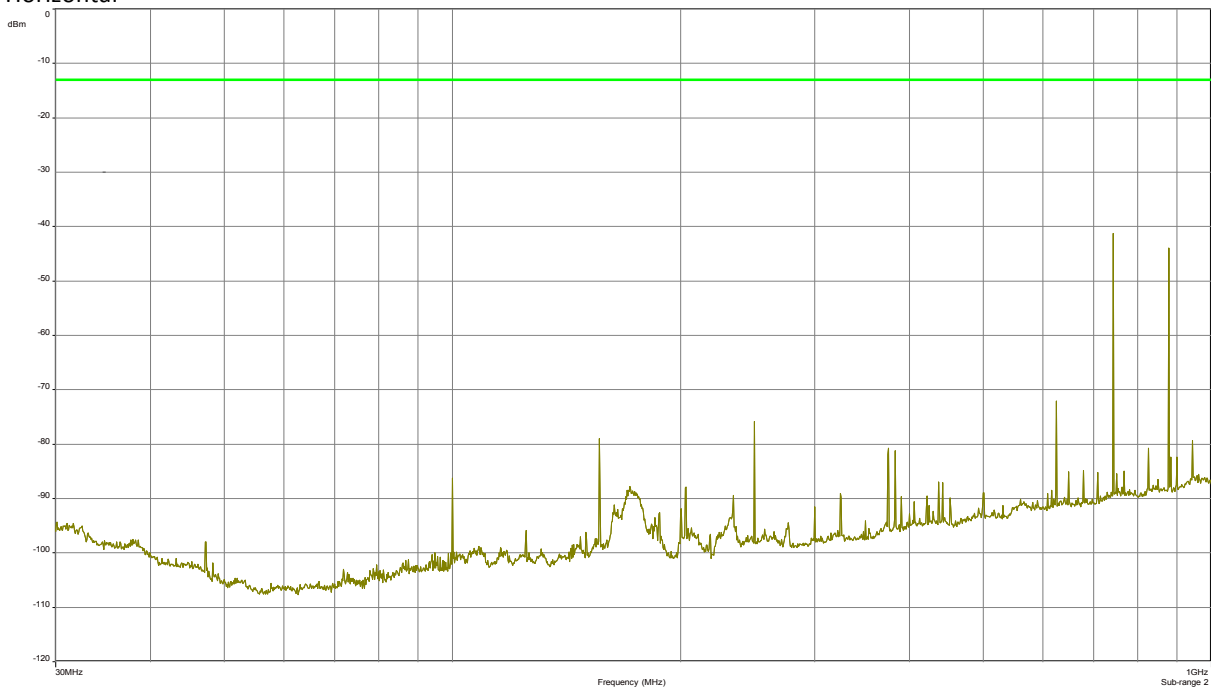

The RF output power is terminated.



10.5.4 1 GHz to 20 GHz Downlink (Bottom – Middle – Top) Subpart H

Bottom: 728MHz; Middle: 737MHz; Top: 746MHz

Vertical

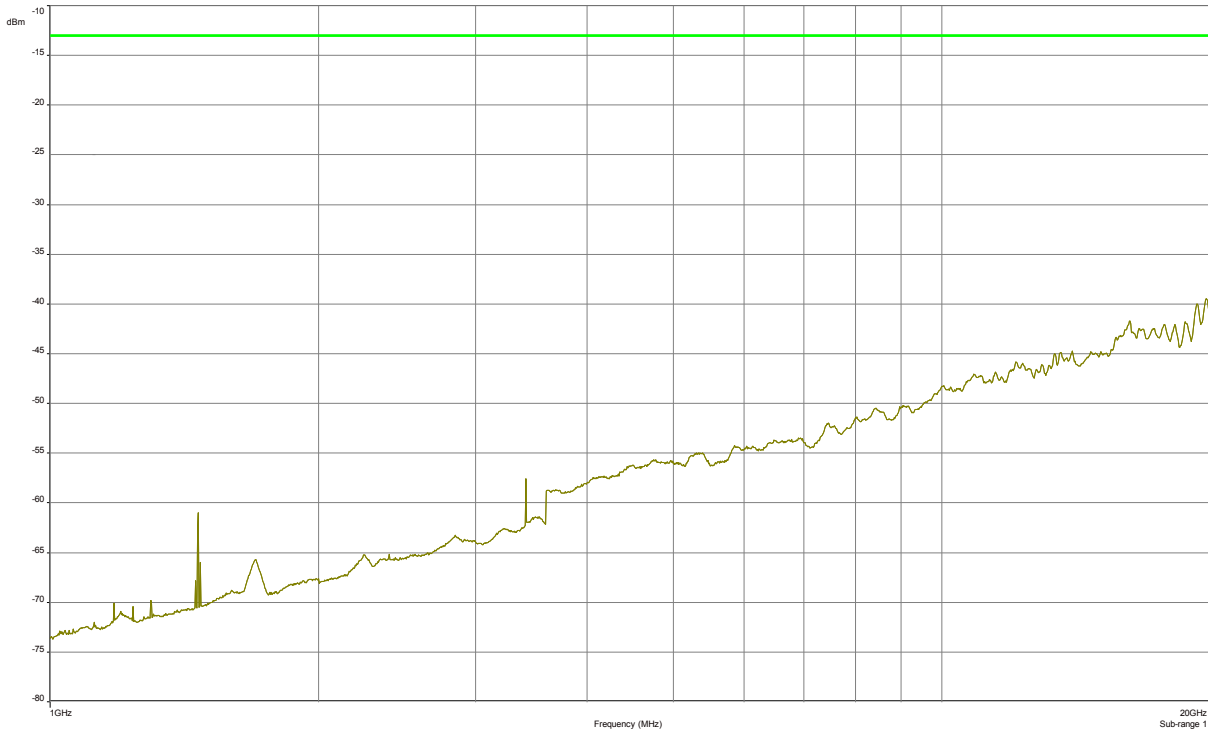

Horizontal

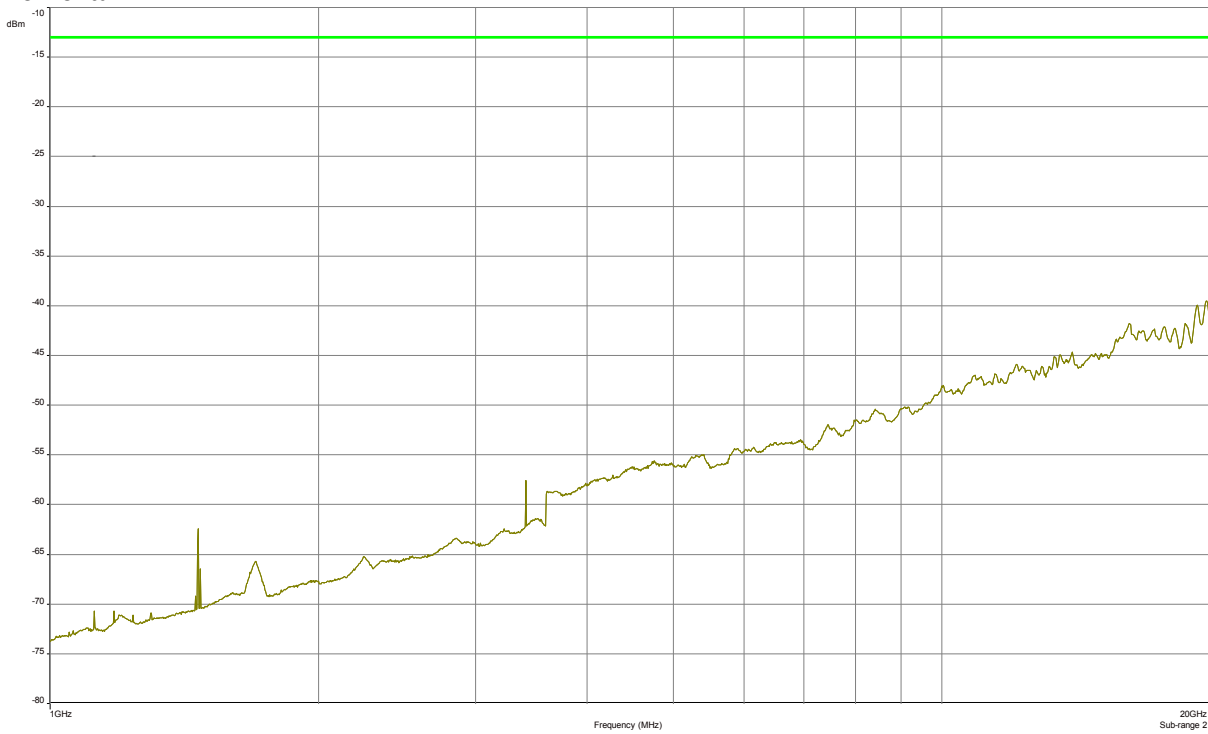

The RF output power is terminated.



10.5.5 1 GHz to 20 GHz Downlink (Bottom – Middle – Top) Subpart F

Bottom: 746MHz; Middle: 751,5MHz; Top: 757MHz

Vertical

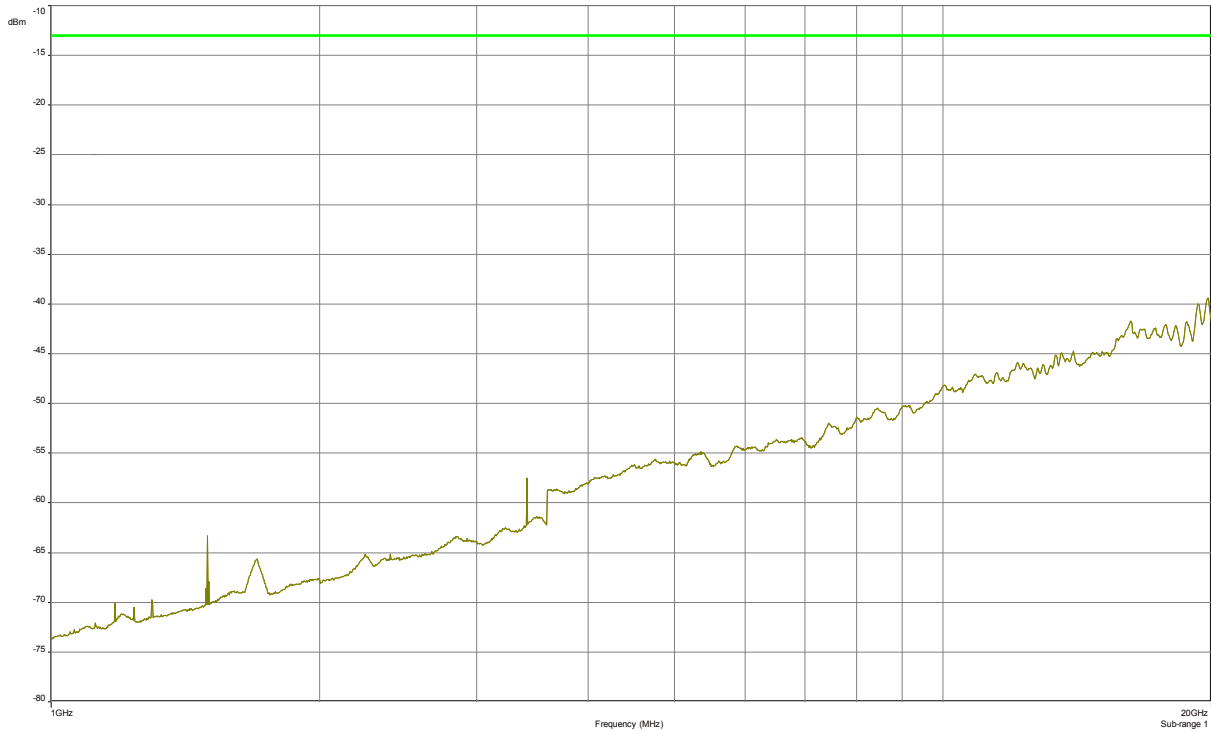

Horizontal

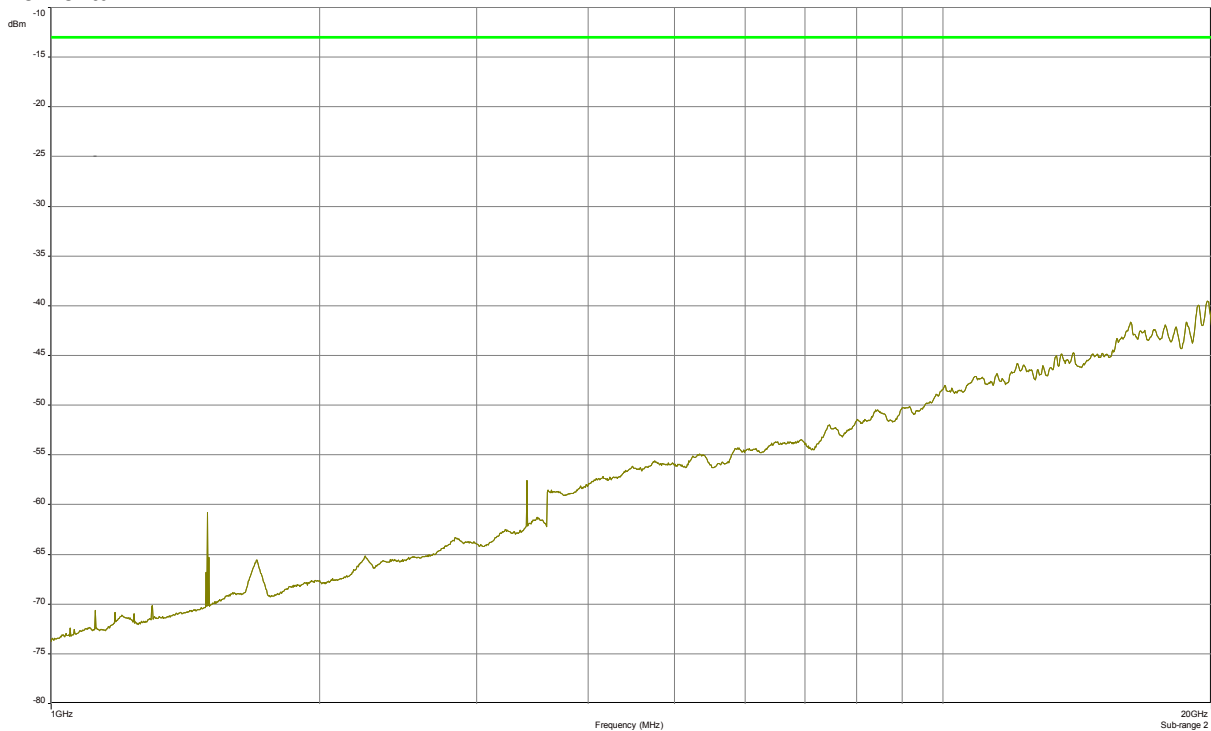

The RF output power is terminated.



10.5.6 1 GHz to 20 GHz Downlink (Middle of all paths)

F1: 742,5 MHz; F2: 878 MHz; F3: 1962,5 MHz; F4: 2132,5 MHz

Vertikal

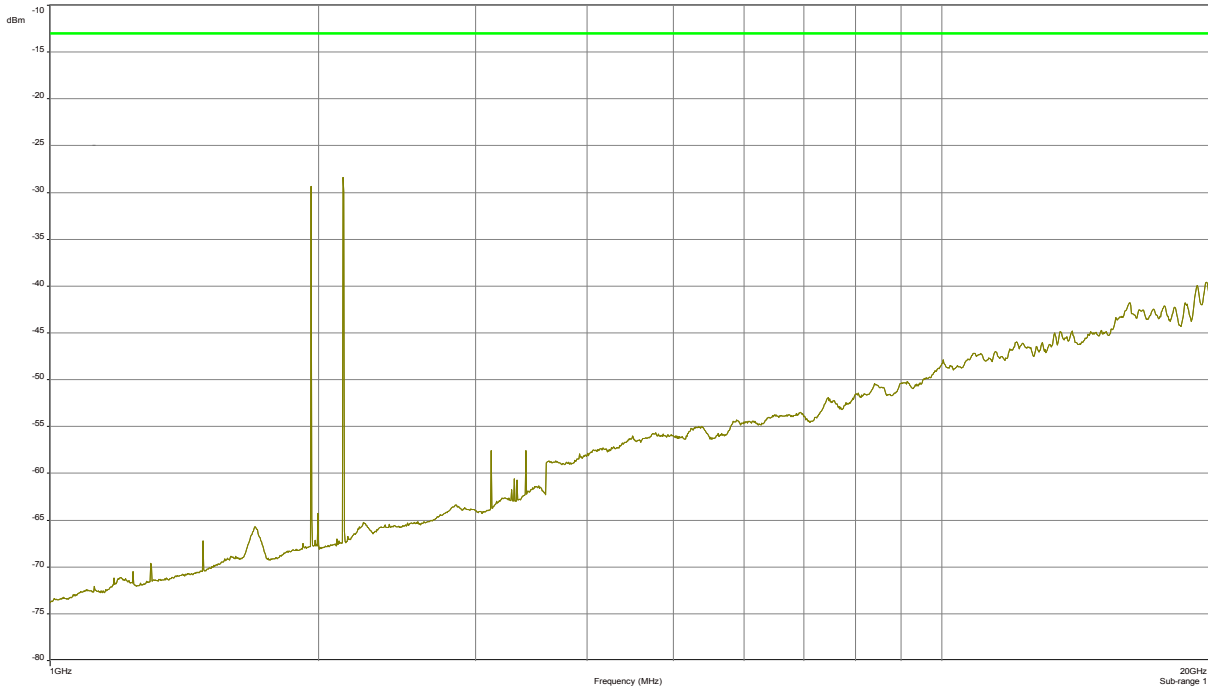

Horizontal

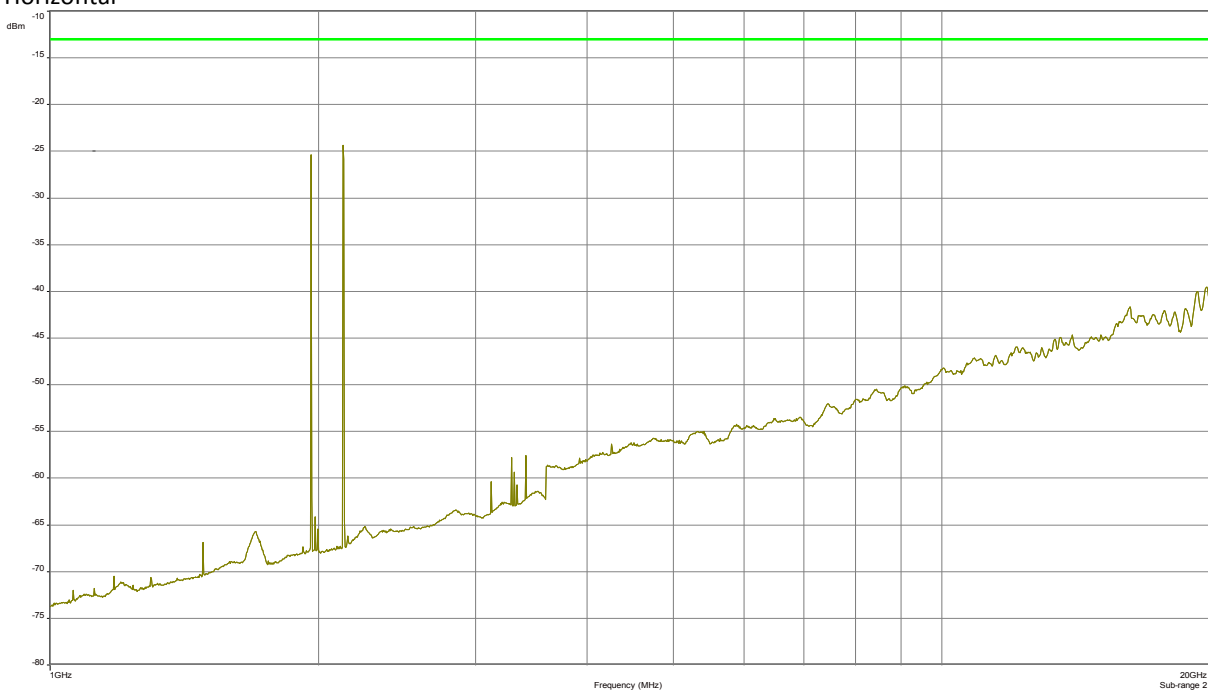

The RF output power is terminated.

Za / 14.12.2014



11 History

Revision	Modification	Date	Name
01.00	Initial Test report	14.04.2015	Tom Zahlmann

******* End of test report *******