

FCC Measurement/Technical Report on

ION-U System

EU L 25T/25T-Vac

Cellular Repeater

FCC ID: XS5-UEUL2525
IC: -

Test Report Reference: MDE_BVNBG_1803_FCCc_REV1

Test Laboratory:

7layers GmbH
Borsigstrasse 11
40880 Ratingen
Germany



Note:

The following test results relate only to the devices specified in this document. This report shall not be reproduced in parts without the written approval of the test laboratory.

7layers GmbH
Borsigstraße 11
40880 Ratingen, Germany
T +49 (0) 2102 749 0
F +49 (0) 2102 749 350

Geschäftsführer/
Managing Directors:
Frank Spiller
Bernhard Retka
Alexandre Norré-Oudard

Registergericht/registered:
Düsseldorf HRB 75554
USt-Id.-Nr./VAT-No. DE203159652
Steuer-Nr./TAX-No. 147/5869/0385

a Bureau Veritas
Group Company

www.7layers.com

Table of Contents

1.1	Applied Standards	3
1.2	FCC-IC Correlation Table	4
1.3	Measurement Summary / Signatures	5
2	Administrative Data	6
2.1	Testing Laboratory	6
2.2	Project Data	6
2.3	Applicant Data	6
2.4	Manufacturer Data	6
3	Test object Data	7
3.1	General EUT Description	7
3.2	EUT Main components	8
3.3	Ancillary Equipment	8
3.4	Auxiliary Equipment	8
3.5	EUT Setups	9
3.6	Operating Modes	9
3.7	Product labelling	10
4	Test Results	11
4.1	Field strength of spurious radiation	11
5	Test Equipment	25
6	Antenna Factors, Cable Loss and Sample Calculations	27
6.1	LISN R&S ESH3-Z5 (150 kHz – 30 MHz)	27
6.2	Antenna R&S HFH2-Z2 (9 kHz – 30 MHz)	28
6.3	Antenna R&S HL562 (30 MHz – 1 GHz)	29
6.4	Antenna R&S HF907 (1 GHz – 18 GHz)	30
6.5	Antenna EMCO 3160-09 (18 GHz – 26.5 GHz)	31
6.6	Antenna EMCO 3160-10 (26.5 GHz – 40 GHz)	32
7	Measurement Uncertainties	33
8	Photo Report	33

1. APPLIED STANDARDS AND TEST SUMMARY

1.1 APPLIED STANDARDS

Type of Authorization

Certification for an Industrial Signal Booster.

Applicable FCC Rules

Prepared in accordance with the requirements of FCC Rules and Regulations as listed in 47 CFR Ch.1 Parts 2 and 20, 27, (10/1/16 Edition). The following subparts are applicable to the results in this test report.

Part 2, Subpart J - Equipment Authorization Procedures, Certification

Part 20, Commercial Mobiles Services

§ 20.21 Signal Boosters

Part 27; Miscellaneous Wireless Communications Services
Subpart C – Technical standards

§ 27.50 – Power and duty cycle limits

§ 27.53 – Emission limits

§ 27.54 – Frequency stability

The tests were selected and performed with reference to:

- FCC Public Notice 935210 applying “Signal Boosters Basic Certification Requirements” 935210 D02 v04, 2017-10-27.
- FCC Public Notice 935210 applying “Measurement guidance for industrial and non-consumer signal booster, repeater and amplifier devices” 935210 D05 v01r02, 2017-10-27.
- FCC Public Notice 971168 applying “Measurement guidance for certification of licensed digital transmitters” 971168 D01 v03,2017-10-27
- ANSI C63.26: 2015

Summary Test Results:

The EUT complied with all performed tests as listed in chapter 1.3 Measurement Summary / Signatures.

1.2 FCC-IC CORRELATION TABLE

Correlation of measurement requirements for Industrial Signal Booster from FCC and ISED Canada

Measurement	FCC reference	ISED reference
Effective radiated power, mean output power and zone enhancer gain	§2.1046 §27.50 KDB 935210 D05 v01r02: 3.5	RSS-GEN Issue 4, 6.12 RSS-139 Issue 3, 6.5 SRSP-513, Issue 3, 5.1.1 RSS-130 Issue 1, 4.4 SRSP-518, Issue 1, 5.1.1 RSS-131 Issue 3: 5.2.3
Peak to Average Ratio	§27.50	RSS 139 Issue 3: 6.5 RSS-130 Issue 1, 4.4
Occupied bandwidth Input-versus-output spectrum	§2.1049 KDB 935210 D05 v01r02: 3.4	RSS-GEN Issue 4, 6.6 RSS-131 Issue 3: 5.2.2
Conducted spurious Emission at Antenna Terminal	§2.1051 §27.53	RSS-GEN Issue 4, 6.13 RSS-139 Issue 3, 6.6 RSS-130 Issue 1: 4.6
Out-of-band emissions limits	§2.1051 §27.53 KDB 935210 D05 v01r02: 3.6	RSS-GEN Issue 4, 6.13 RSS-139 Issue 3, 6.6 RSS-130 Issue 1: 4.6
Frequency stability	§2.1055 §27.54	RSS-GEN Issue 4, 6.11 RSS-139 Issue 3: 6.4 RSS-130 Issue 1: 4.3 RSS-131 Issue 3: 5.2.4
Field strength of spurious radiation	§2.1053 §27.53	RSS-GEN Issue 4, 6.13 RSS-139 Issue 3: 6.6 RSS-130 Issue 1: 4.6
Out-of-band rejection	KDB 935210 D05 v01r02: 3.3	RSS-131 Issue 3: 5.2.1

1.3 MEASUREMENT SUMMARY / SIGNATURES

47 CFR CHAPTER I FCC PART 27 Subpart C [Base Stations/Repeater] §2.1053, §27.53

Field strength of spurious radiation

The measurement was performed according to ANSI C63.26

Final Result

OP-Mode

Frequency Band, Test Frequency, Direction

Band 4/10/65, high, RF downlink

Band 4/10/65, low, RF downlink

Band 4/10/65, mid, RF downlink

Band 12, high, RF downlink

Band 12, low, RF downlink

Band 12, mid, RF downlink

Band 13, high, RF downlink

Band 13, low, RF downlink

Band 13, mid, RF downlink

Setup

FCC

IC

S01_AA01

Passed

Passed

S01_AA01

Passed

Passed

S01_AA01

Passed

Passed

S01_AA01

Passed

Passed

S01_AA01

Passed

Passed

S01_AA01

Passed

Passed

S01_AA01

Passed

Passed

S01_AA01

Passed

Passed

S01_AA01

Passed

Passed

N/A: Not applicable

N/P: Not performed

Only the test case "Field strength of spurious radiation" has been performed, for the frequency bands, which are additionally supported by the remote units.

Both remote units were connected and switched.

Report version control			
Version	Release date	Change Description	Version validity
initial	2018-07-27	--	invalid
REV1	2018-08-30	<ul style="list-style-type: none"> Page 5: Statement added, that the remote units were connected and switched. Page 8: FCC-ID and IC-ID added for both remote units 	valid



7 layers GmbH, Borsigstr. 11
40880 Ratingen, Germany
Phone +49 (0)2102 749 0



(responsible for accreditation scope)
Dipl.-Ing. Marco Kullik



(responsible for testing and report)
Dipl.-Ing. Daniel Gall

2 ADMINISTRATIVE DATA

2.1 TESTING LABORATORY

Company Name: 7layers GmbH
Address: Borsigstr. 11
40880 Ratingen
Germany

This facility has been fully described in a report submitted to the ISED and accepted under the registration number: Site# 3699A-1.

The test facility is also accredited by the following accreditation organisation:

Laboratory accreditation no: DAKKS D-PL-12140-01-00
FCC Designation Number: DE0015
FCC Test Firm Registration: 929146
Responsible for accreditation scope: Dipl.-Ing. Marco Kullik
Report Template Version: 2018-01-03

2.2 PROJECT DATA

Responsible for testing and report: Dipl.-Ing. Daniel Gall
Employees who performed the tests: documented internally at 7Layers
Date of Report: 2018-08-30
Testing Period: 2018-06-11 to 2018-06-25

2.3 APPLICANT DATA

Company Name: Commscope
Andrew Wireless Systems GmbH
Address: Industriering 10
86675 Buchdorf
Germany
Contact Person: Mr. Frank Futter

2.4 MANUFACTURER DATA

Company Name: please see applicant data

3 TEST OBJECT DATA

3.1 GENERAL EUT DESCRIPTION

Kind of Device product description	Cellular Repeater
Product name	Cellular Repeater
Type	ION-U System EU L 25T/25T-Vac
Declared EUT data by the supplier	
General Product Description	<p>The EUT is an industrial signal booster supporting the following:</p> <ul style="list-style-type: none"> Band 41 (TD 2500) Broadband Radio Service (BRS): 2496 – 2690 MHz <p>The Remote Units support the following bands: Band 2/25 / 1900 PCS/1900+ Band 4/10/65 (partly) / AWS 1/AWS 1+ / AWS 3 (partly) Band 5 / 850 Band 12 / 700 a Band 13 / 700 c Band 18/26/27 (partly) / 800 Lower/850+/800 SMR (partly) A RF operation is only supported for the downlink.</p>
Booster Type	Industrial Signal Booster
Voltage Type	AC
Voltage Level	100 V – 240 V, 50 – 60 Hz
Maximum Output Donor Port [Uplink]	-
Maximum Output Server Port [Downlink]	Band 41: 2496-2690 MHz [Module 2.]: 30.9 dBm Band 41: 2496-2690 MHz [Module 1.]: 31.2 dBm
Maximum Gain [Uplink]	-
Maximum Gain [Downlink]	Band 41: 2496-2690 MHz [Module 2.]: 36.1 dB Band 41: 2496-2690 MHz [Module 1.]: 34.3 dB

The main components of the EUT are listed and described in chapter 3.2 EUT Main components.

3.2 EUT MAIN COMPONENTS

Sample Name	Sample Code	Description
EUT A	DE1277005aa01	FCC sample
Sample Parameter	Value	
Serial Number	779-0001	
HW Version	ID No: 7776915-0002	
SW Version	V1.0.0.25	
Comment	-	

NOTE: The short description is used to simplify the identification of the EUT in this test report.

3.3 ANCILLARY EQUIPMENT

For the purposes of this test report, ancillary equipment is defined as equipment which is used in conjunction with the EUT to provide operational and control features to the EUT. It is necessary to configure the system in a typical fashion, as a customer would normally use it. But nevertheless Ancillary Equipment can influence the test results.

Device	Details (Manufacturer, Type Model, S/N, HW, SW)	Description
ANC1	FCC-ID: XS5-U7885L17E19P IC ID: 2237E-U78L17E19P EUT Setups Commscope, ION-U L 7/80-85/17EP/19P-Vac, P05, V1.00.01.05	Remote Unit 1
ANC2	FCC-ID: XS5-U7885L17E19P IC ID: 2237E-U78L17E19P Commscope, ION-U L 7/80-85/17EP/19P-Vac, P01, V1.00.01.05	Remote Unit 2

3.4 AUXILIARY EQUIPMENT

For the purposes of this test report, auxiliary equipment is defined as equipment which is used temporarily to enable operational and control features especially used for the tests of the EUT which is not used during normal operation or equipment that is used during the tests in combination with the EUT but is not subject of this test report. It is necessary to configure the system in a typical fashion, as a customer would normally use it. But nevertheless Auxiliary Equipment can influence the test results.

Device	Details (Manufacturer, HW, SW, S/N)	Description
-	-	-

3.5 EUT SETUPS

This chapter describes the combination of EUTs and equipment used for testing. The rationale for selecting the EUTs, ancillary and auxiliary equipment and interconnecting cables, is to test a representative configuration meeting the requirements of the referenced standards.

Setup	Combination of EUTs	Description and Rationale
S01_AA01	EUT A, ANC1, ANC2,	Setup for all tests

3.6 OPERATING MODES

This chapter describes the operating modes of the EUTs used for testing.

3.6.1 TEST CHANNELS

Band	Direction	Lower Frequency Band Edge [MHz]	Upper Frequency Band Edge [MHz]	Center Frequency [MHz]	Port
4/10/65	downlink	2110.00	2180.00	2145.00	Donor
12	downlink	729.00	746.00	737.50	Donor
13	downlink	746.00	756.00	751.00	Donor

3.6.2 AUTOMATIC GAIN CONTROL LEVELS

AGC Levels							
Band	Direction	Signal Type	AGC Start Pin [dBm]	AGC Start Pin -0.3 dB [dBm]	AGC Start Pin +3 dB [dBm]	Frequency [MHz]	Frequency
4/10/65	downlink	Narrowband	-	-	-	2145.0	Mid
4/10/65	downlink	Wideband	-	-	-	2145.0	
4/10/65	downlink	Narrowband	-	-	-	2111.2	Low
4/10/65	downlink	Wideband	-	-	-	2111.2	
4/10/65	downlink	Narrowband	-	-	-	2178.8	High
4/10/65	downlink	Wideband	-	-	-	2178.8	
4/10/65	downlink	Narrowband	-	-	-	-	Max.Power
4/10/65	downlink	Wideband	-	-	-	-	
12	downlink	Narrowband	-	-	-	737.5	Mid
12	downlink	Wideband	-	-	-	737.5	
12	downlink	Narrowband	-	-	-	729.2	Low
12	downlink	Wideband	-	-	-	729.2	
12	downlink	Narrowband	-	-	-	745.8	High
12	downlink	Wideband	-	-	-	745.8	
12	downlink	Narrowband	-	-	-	-	Max.Power
12	downlink	Wideband	-	-	-	-	
13	downlink	Narrowband	-	-	-	751.0	Mid
13	downlink	Wideband	-	-	-	751.0	
13	downlink	Narrowband	-	-	-	746.2	Low
13	downlink	Wideband	-	-	-	746.2	
13	downlink	Narrowband	-	-	-	755.8	High
13	downlink	Wideband	-	-	-	755.8	
13	downlink	Narrowband	-	-	-	-	Max.Power
13	downlink	Wideband	-	-	-	-	

Note: Because only the test case "Field strength of spurious radiation" have been performed, the AGC power levels have not been determined.

3.7 PRODUCT LABELLING

3.7.1 FCC ID LABEL

Please refer to the documentation of the applicant.

3.7.2 LOCATION OF THE LABEL ON THE EUT

Please refer to the documentation of the applicant.

4 TEST RESULTS

4.1 FIELD STRENGTH OF SPURIOUS RADIATION

Standard FCC Part 27, §24.53

The test was performed according to:
ANSI C63.26

4.1.1 TEST DESCRIPTION

This test case is intended to demonstrate compliance to the applicable radiated spurious emission measurements per § 2.1053

The EUT was connected to the test setup according to the following diagram:

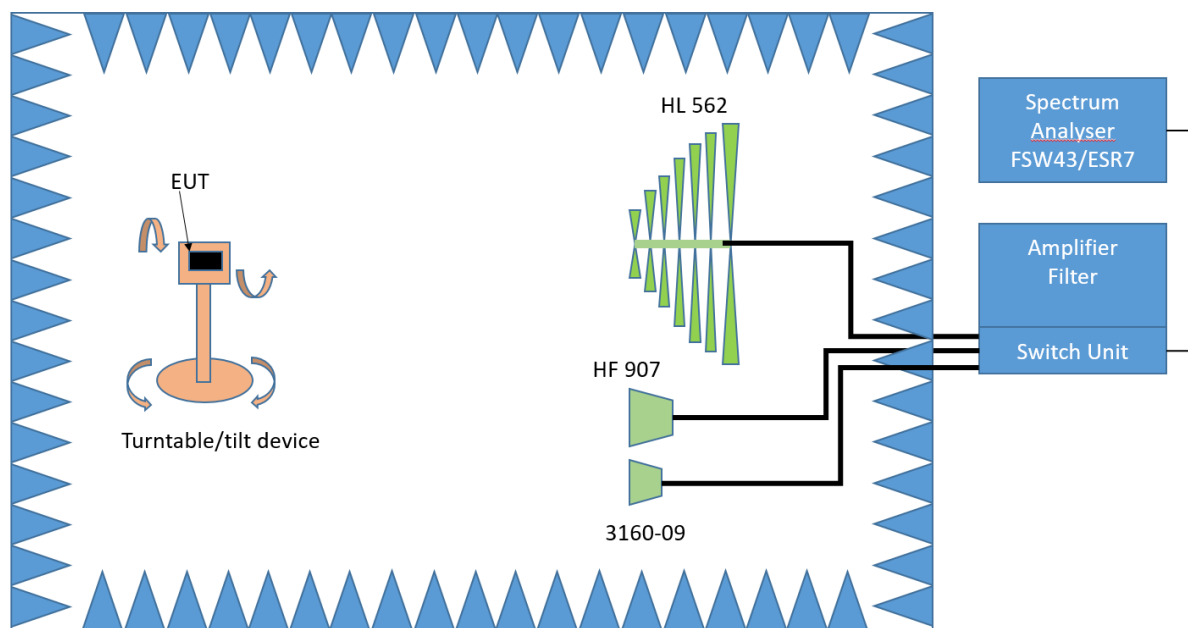

FCC Part 22/24/27/90; Industrial Signal Booster – Test Setup; Field Strength of Spurious Radiation

The test set-up was made in accordance to the general provisions of ANSI C63.4 in a typical installation configuration. The Equipment Under Test (EUT) was set up on a non-conductive table 1.0 x 2.0 m² in the semi-anechoic chamber. The influence of the EUT support table that is used between 30–1000 MHz was evaluated.

The measurement procedure is implemented into the EMI test software EMC32 from R&S. Exploratory tests are performed at 3 orthogonal axes to determine the worst-case orientation of a body-worn or handheld EUT. The final test on all kind of EUTs is also performed at 3 axes. A pre-check is performed while the EUT is powered from a DC power source.

1. Measurement above 30 MHz and up to 1 GHz

Step 1: Preliminary scan

This is a preliminary test to identify the highest amplitudes relative to the limit. Settings for step 1:

- Antenna distance: 3 m
- Detector: Peak-Maxhold / Quasipeak (FFT-based)
- Frequency range: 30 – 1000 MHz
- Frequency steps: 30 kHz
- IF-Bandwidth: 120 kHz
- Measuring time / Frequency step: 100 ms
- Turntable angle range: -180° to 90°
- Turntable step size: 90°
- Height variation range: 1 – 3 m
- Height variation step size: 2 m
- Polarisation: Horizontal + Vertical

Intention of this step is, to determine the radiated EMI-profile of the EUT. Afterwards the relevant emissions for the final measurement are identified.

Step 2: Adjustment measurement

In this step the accuracy of the turntable azimuth and antenna height will be improved. This is necessary to find out the maximum value of every frequency.

For each frequency, which was determined the turntable azimuth and antenna height will be adjusted. The turntable azimuth will slowly vary by $\pm 45^{\circ}$ around this value. During this action, the value of emission is continuously measured. The turntable azimuth at the highest emission will be recorded and adjusted. In this position, the antenna height will also slowly vary by ± 100 cm around the antenna height determined. During this action, the value of emission is also continuously measured. The antenna height of the highest emission will also be recorded and adjusted.

- Detector: Peak – Maxhold
- Measured frequencies: in step 1 determined frequencies
- IF – Bandwidth: 120 kHz
- Measuring time: 100 ms
- Turntable angle range: $\pm 45^{\circ}$ around the determined value
- Height variation range: ± 100 cm around the determined value
- Antenna Polarisation: max. value determined in step 1

Step 3: Final measurement with QP detector

With the settings determined in step 3, the final measurement will be performed:

EMI receiver settings for step 4:

- Detector: Quasi-Peak (< 1 GHz)
- Measured frequencies: in step 1 determined frequencies
- IF – Bandwidth: 120 kHz
- Measuring time: 1 s

After the measurement a plot will be generated which contains a diagram with the results of the preliminary scan and a chart with the frequencies and values of the results of the final measurement.

3. Measurement above 1 GHz

The following modifications apply to the measurement procedure for the frequency range above 1 GHz:

Step 1:

The Equipment Under Test (EUT) was set up on a non-conductive support (tilt device) at 1.5 m height in the fully-anechoic chamber.

All steps were performed with one height (1.5 m) of the receiving antenna only.

The EUT is turned during the preliminary measurement across the elevation axis, with a step size of 90° .

The turn table step size (azimuth angle) for the preliminary measurement is 45° .

Step 2:

Due to the fact, that in this frequency range the test is performed in a fully anechoic room, the height scan of the receiving antenna instead 2 is omitted. Instead of this, a maximum search with a step size $\pm 45^\circ$ for the elevation axis is performed.

The turn table azimuth will slowly vary by $\pm 22.5^\circ$.

The elevation angle will slowly vary by $\pm 45^\circ$

EMI receiver settings (for all steps):

- Detector: Peak, Average
- IF Bandwidth = 1 MHz

Step 3:

Spectrum analyser settings for step 3:

- Detector: Peak / Average
- Measured frequencies: in step 1 determined frequencies
- IF – Bandwidth: 1 MHz
- Measuring time: 1 s

4.1.2 TEST REQUIREMENTS / LIMITS

FCC Part 2.1053; Measurement required: Field strength of spurious radiation:

Measurements shall be made to detect spurious emissions that may be radiated directly from the cabinet, control circuits, power leads, or intermediate circuit elements under normal conditions of installation and operation. Curves or equivalent data shall be supplied showing the magnitude of each harmonic and other spurious emission. For this test, single sideband, independent sideband, and controlled carrier transmitters shall be modulated under the conditions specified in paragraph (c) of §2.1049, as appropriate.

Part 27; Miscellaneous Wireless Communication Services

Subpart C – Technical standards

§27.53 – Emission limits

Band 13

(c) For operations in the 746-758 MHz band and the 776-788 MHz band, the power of any emission outside the licensee's frequency band(s) of operation shall be attenuated below the transmitter power (P) within the licensed band(s) of operation, measured in watts, in accordance with the following:

- (1) On any frequency outside the 746-758 MHz band, the power of any emission shall be attenuated outside the band below the transmitter power (P) by at least $43 + 10 \log (P)$ dB;
- (2) On any frequency outside the 776-788 MHz band, the power of any emission shall be attenuated outside the band below the transmitter power (P) by at least $43 + 10 \log (P)$ dB;
- (3) On all frequencies between 763-775 MHz and 793-805 MHz, by a factor not less than $76 + 10 \log (P)$ dB in a 6.25 kHz band segment, for base and fixed stations;
- (4) On all frequencies between 763-775 MHz and 793-805 MHz, by a factor not less than $65 + 10 \log (P)$ dB in a 6.25 kHz band segment, for mobile and portable stations;
- (5) Compliance with the provisions of paragraphs (c)(1) and (c)(2) of this section is based on the use of measurement instrumentation employing a resolution bandwidth of 100 kHz or greater. However, in the 100 kHz bands immediately outside and adjacent to the frequency block, a resolution bandwidth of at least 30 kHz may be employed;
- (f) For operations in the 746-758 MHz, 775-788 MHz, and 805-806 MHz bands, emissions in the band 1559-1610 MHz shall be limited to -70 dBW/MHz equivalent isotropically radiated

power (EIRP) for wideband signals, and -80 dBW EIRP for discrete emissions of less than 700 Hz bandwidth. For the purpose of equipment authorization, a transmitter shall be tested with an antenna that is representative of the type that will be used with the equipment in normal operation.

(6) Compliance with the provisions of paragraphs (c)(3) and (c)(4) of this section is based on the use of measurement instrumentation such that the reading taken with any resolution bandwidth setting should be adjusted to indicate spectral energy in a 6.25 kHz segment.

Band 12:

(g) For operations in the 600 MHz band and the 698-746 MHz band, the power of any emission outside a licensee's frequency band(s) of operation shall be attenuated below the transmitter power (P) within the licensed band(s) of operation, measured in watts, by at least $43 + 10 \log(P)$ dB. Compliance with this provision is based on the use of measurement instrumentation employing a resolution bandwidth of 100 kilohertz or greater. However, in the 100 kilohertz bands immediately outside and adjacent to a licensee's frequency block, a resolution bandwidth of at least 30 kHz may be employed.

Band 4/10/65:

(h) *AWS emission limits—(1) General protection levels.* Except as otherwise specified below, for operations in the 1695-1710 MHz, 1710-1755 MHz, 1755-1780 MHz, 1915-1920 MHz, 1995-2000 MHz, 2000-2020 MHz, 2110-2155 MHz, 2155-2180 MHz, and 2180-2200 bands, the power of any emission outside a licensee's frequency block shall be attenuated below the transmitter power (P) in watts by at least $43 + 10 \log_{10}(P)$ dB.

RSS-130; 4.6 Transmitter Unwanted Emissions

4.6.1 The power of any unwanted emissions in any 100 kHz bandwidth on any frequency outside the frequency range(s) within which the equipment is designed to operate shall be attenuated below the transmitter power, P (dBW), by at least $43 + 10 \log_{10} p$ (watts), dB. However, in the 100 kHz band immediately outside the equipment's operating frequency range, a resolution bandwidth of 30 kHz may be employed.

4.6.2 In addition to the limit outlined in Section 4.6.1 above, equipment operating in the frequency bands 746-756 MHz and 777-787 MHz shall also comply with the following restrictions:

- (a) The power of any unwanted emissions in any 6.25 kHz bandwidth for all frequencies between 763-775 MHz and 793-806 MHz shall be attenuated below the transmitter power, P (dBW), by at least:
 - (i) $76 + 10 \log_{10} p$ (watts), dB, for base and fixed equipment, and
 - (ii) $65 + 10 \log_{10} p$ (watts), dB, for mobile and portable equipment.
- (b) The e.i.r.p. in the band 1559-1610 MHz shall not exceed -70 dBW/MHz for wideband signal and -80 dBW for discrete emission with bandwidth less than 700 Hz.

RSS-139; 6.6 Transmitter Unwanted Emissions

Equipment shall comply with the limits in (i) and (ii) below.

- i. In the first 1.0 MHz bands immediately outside and adjacent to the equipment's smallest operating frequency block, which can contain the equipment's occupied bandwidth, the emission power per any 1% of the emission bandwidth shall be attenuated below the transmitter output power P (in dBW) by at least $43 + 10 \log_{10} p$ (watts) dB.
- ii. After the first 1.0 MHz outside the equipment's smallest operating frequency block, which can contain the equipment's occupied bandwidth, the emission power in any 1 MHz bandwidth shall be attenuated below the transmitter output power P (in dBW) by at least $43 + 10 \log_{10} p$ (watts) dB.

4.1.3 TEST PROTOCOL

Band 4/10/65 (partly), downlink;						
Spurious Freq. [MHz]	Spurious Level [dBm]	Pin [dBm]	Detector	RBW [kHz]	Limit [dBm]	Margin to Limit [dB]
-	-	-6.6/-6.8/-7.4	RMS	100	-13.0	---
-	-	-6.6/-6.8/-7.4	RMS	100	-13.0	---
-	-	-6.6/-6.8/-7.4	RMS	100	-13.0	---
-	-	-6.6/-6.8/-7.4	RMS	100	-13.0	---
-	-	-6.6/-6.8/-7.4	RMS	100	-13.0	---

Band 12, downlink;						
Spurious Freq. [MHz]	Spurious Level [dBm]	Pin [dBm]	Detector	RBW [kHz]	Limit [dBm]	Margin to Limit [dB]
-	-	-6.0/-6.0/-6.0	RMS	100	-13.0	---
-	-	-6.0/-6.0/-6.0	RMS	100	-13.0	---
-	-	-6.0/-6.0/-6.0	RMS	100	-13.0	---
-	-	-6.0/-6.0/-6.0	RMS	100	-13.0	---
-	-	-6.0/-6.0/-6.0	RMS	100	-13.0	---

Band 13, downlink;						
Spurious Freq. [MHz]	Spurious Level [dBm]	Pin [dBm]	Detector	RBW [kHz]	Limit [dBm]	Margin to Limit [dB]
-	-	-5.9/-5.9/-6.0	RMS	100	-13.0	---
-	-	-5.9/-5.9/-6.0	RMS	100	-13.0	---
-	-	-5.9/-5.9/-6.0	RMS	100	-13.0	---
-	-	-5.9/-5.9/-6.0	RMS	100	-13.0	---
-	-	-5.9/-5.9/-6.0	RMS	100	-13.0	---

Remark: Please see next sub-clause for the measurement plot.

The three required test frequencies (low, mid, high) were injected simultaneously conducted into the EUT.
 The RF output ports were terminated with 50 Ohm
 Measurement Plot (showing the highest value, "worst case")

Frequency Band = Band 4/10/65, Test Frequency = low, Direction = RF downlink
(S01_AA01)

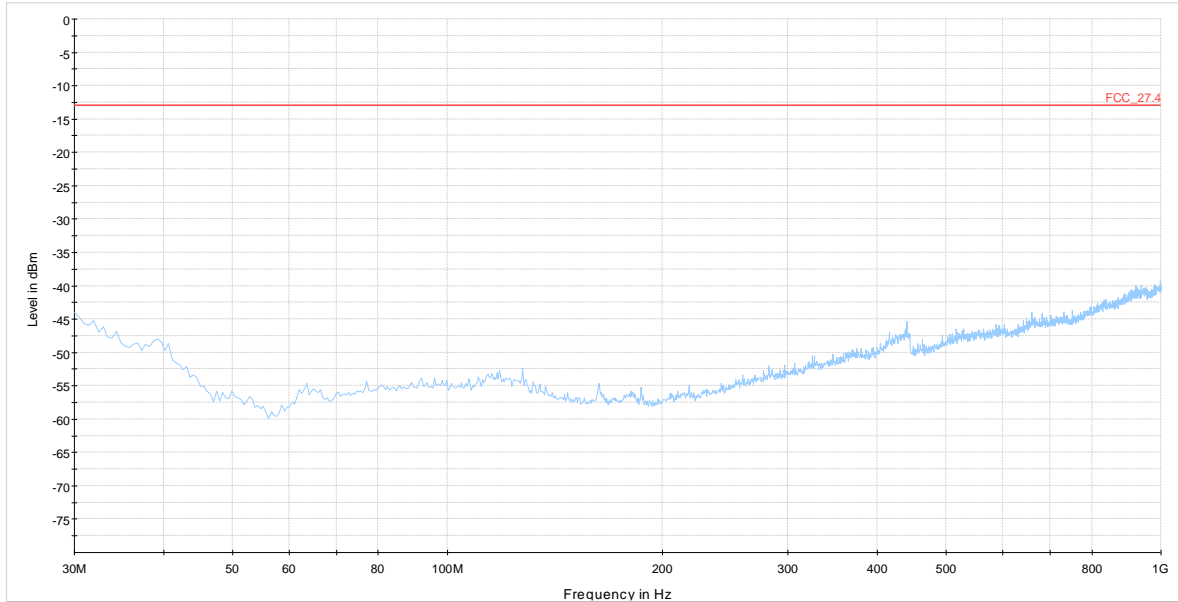

30 MHz - 1 GHz

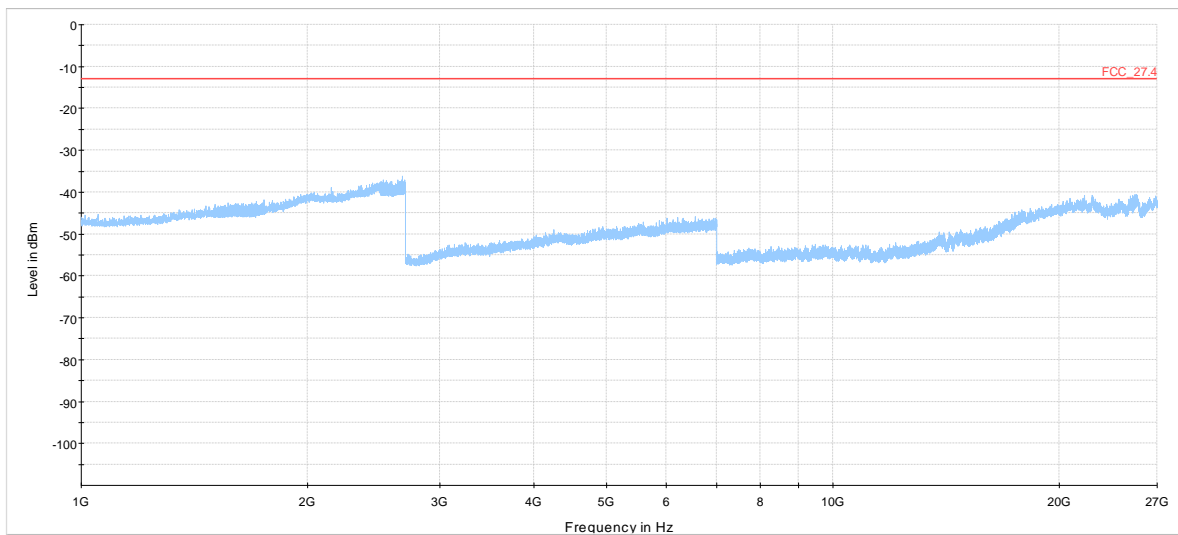

1 GHz - 27 GHz

Frequency Band = Band 4/10/65, Test Frequency = mid, Direction = RF downlink
(S01_AA01)

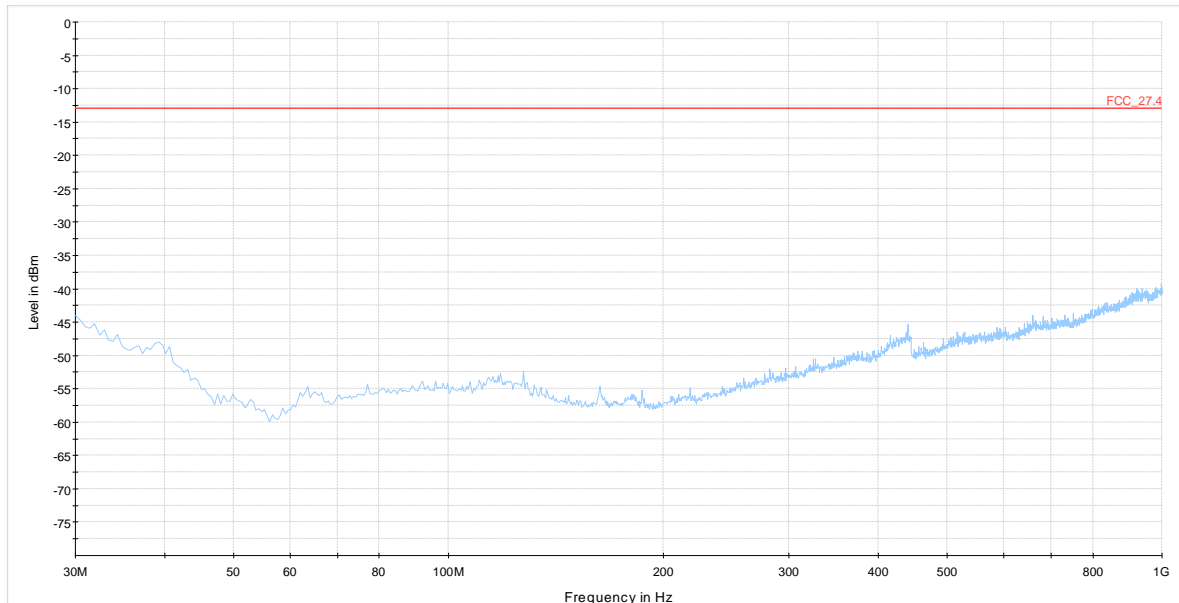

30 MHz - 1 GHz

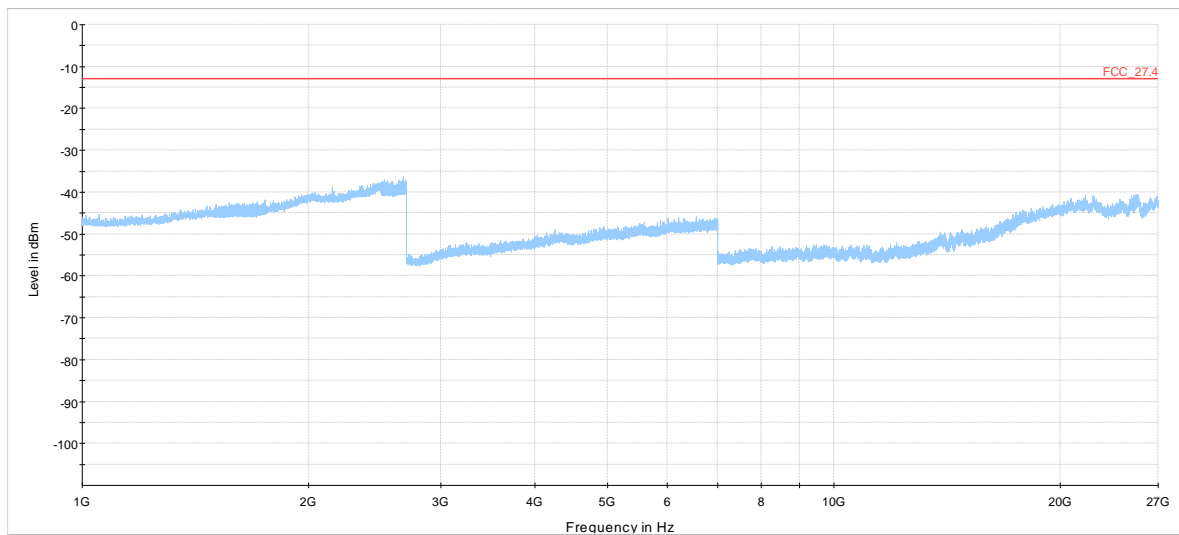

1 GHz - 27 GHz

Frequency Band = Band 4/10/65, Test Frequency = high, Direction = RF downlink
(S01_AA01)

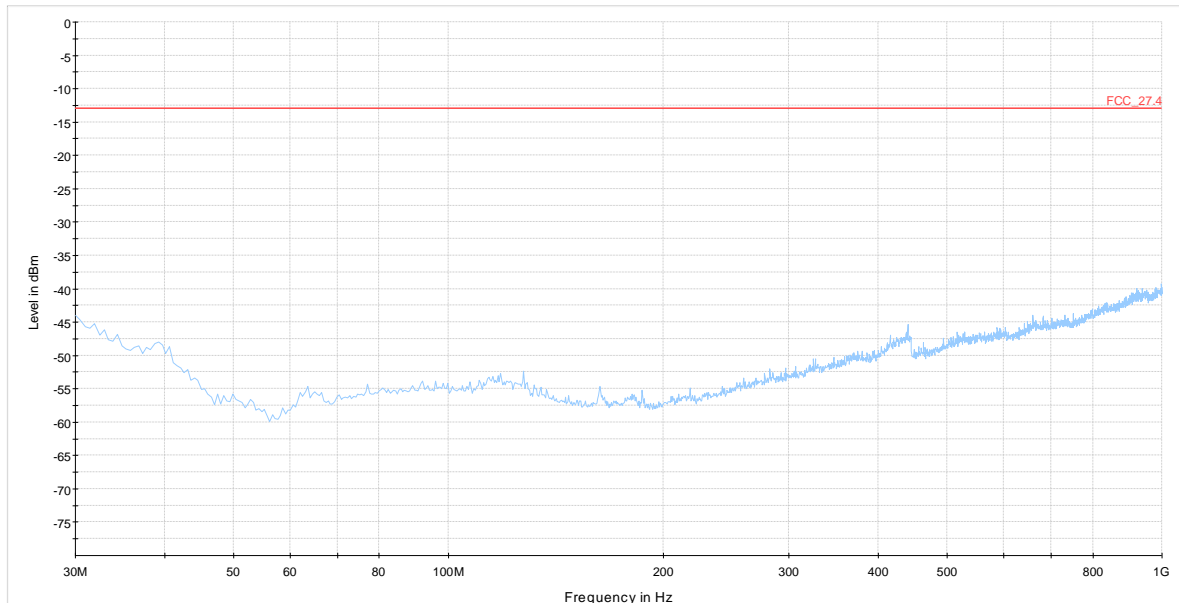

30 MHz - 1 GHz

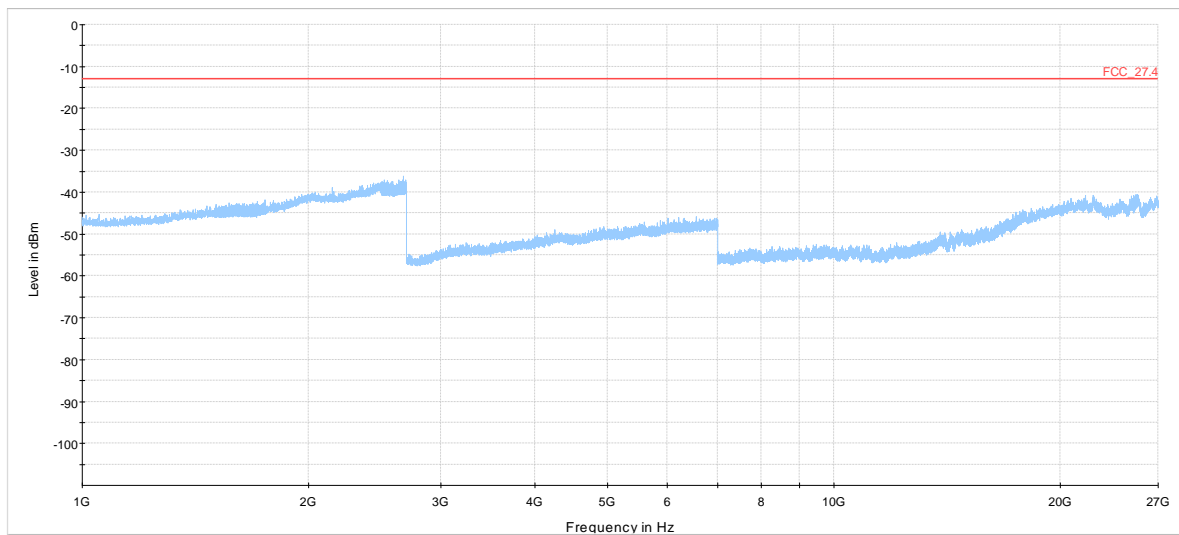

1 GHz - 27 GHz

Frequency Band = Band 12, Test Frequency = low, Direction = RF downlink
(S01_AA01)

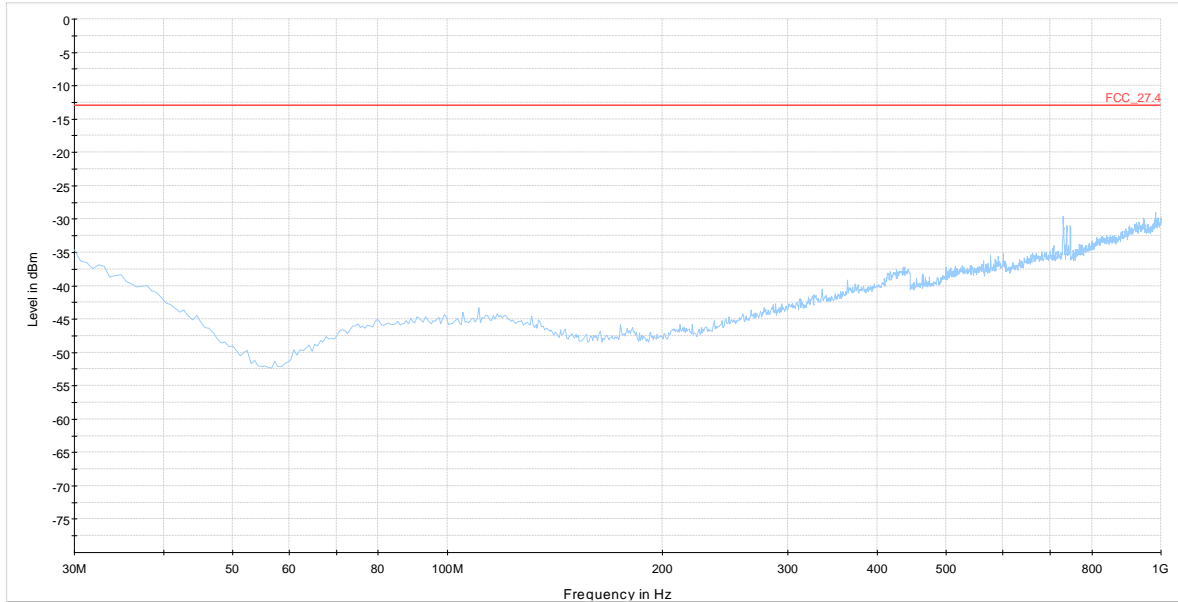

30 MHz - 1 GHz

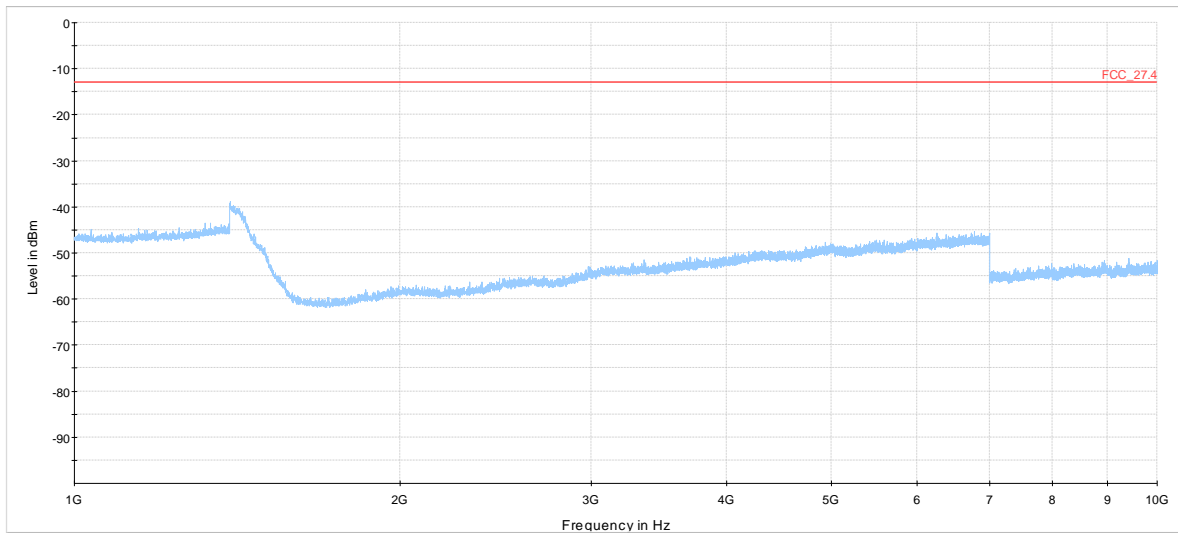

1 GHz - 10 GHz

Frequency Band = Band 12, Test Frequency = mid, Direction = RF downlink
(S01_AA01)

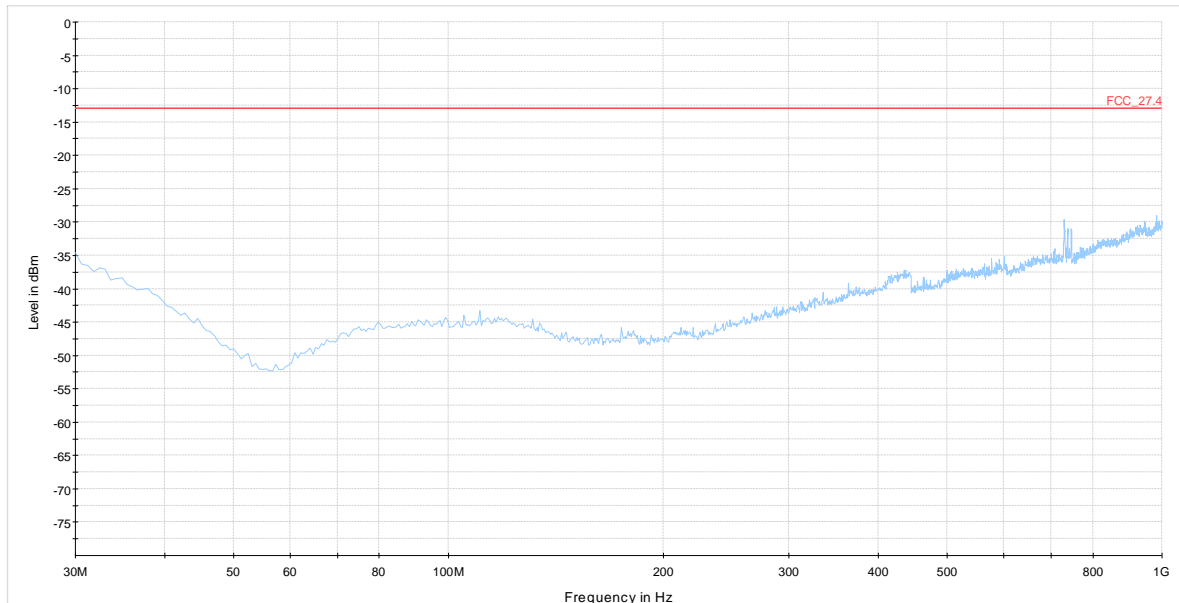

30 MHz - 1 GHz

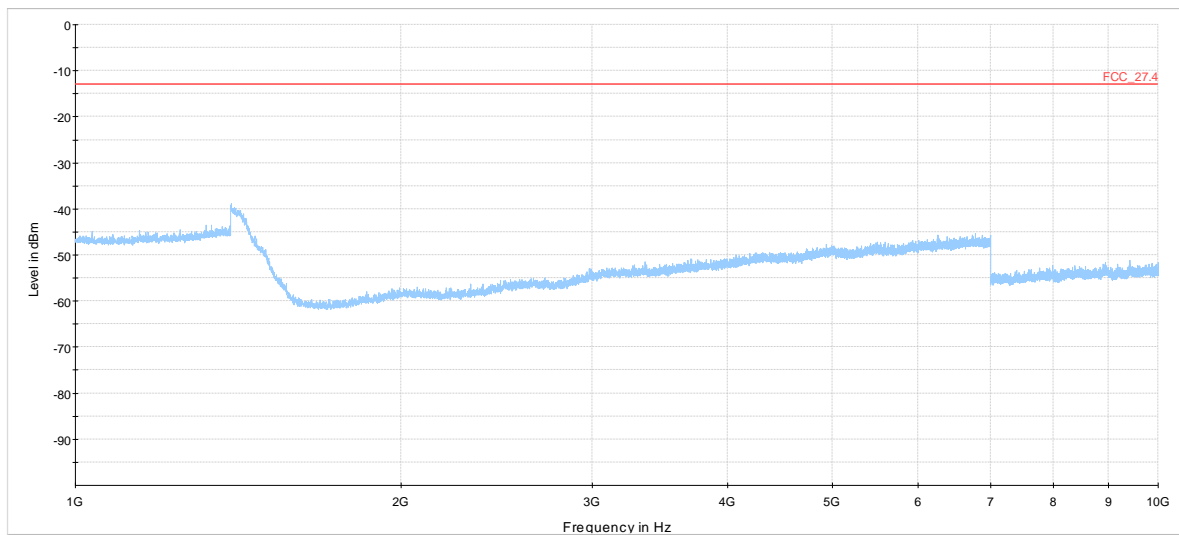

1 GHz - 10 GHz

Frequency Band = Band 12, Test Frequency = high, Direction = RF downlink
(S01_AA01)

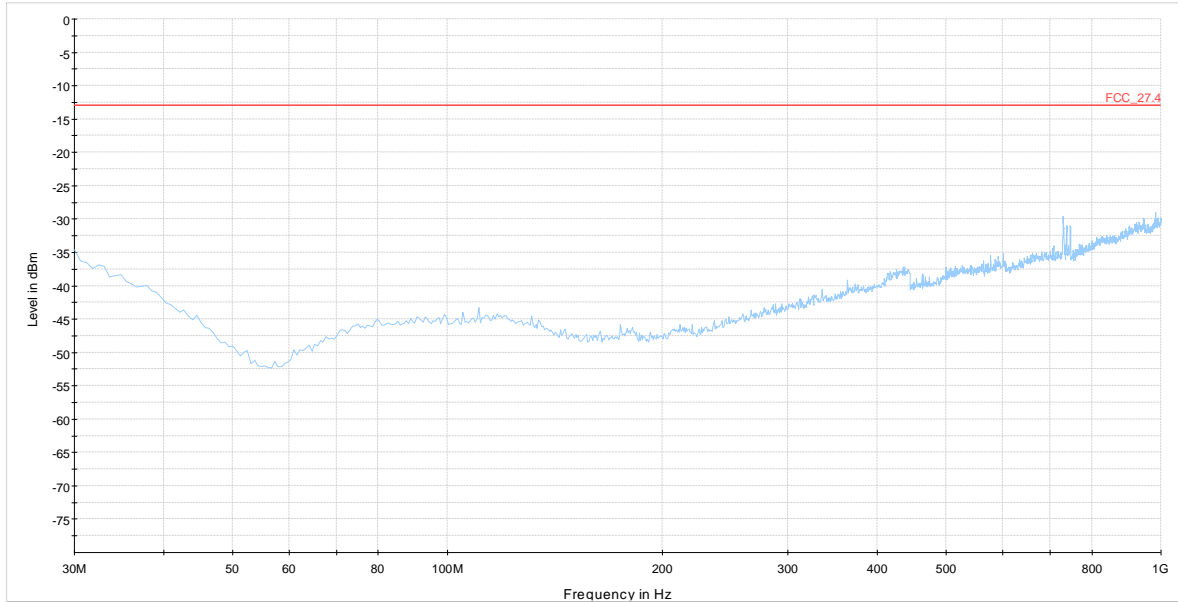

30 MHz - 1 GHz

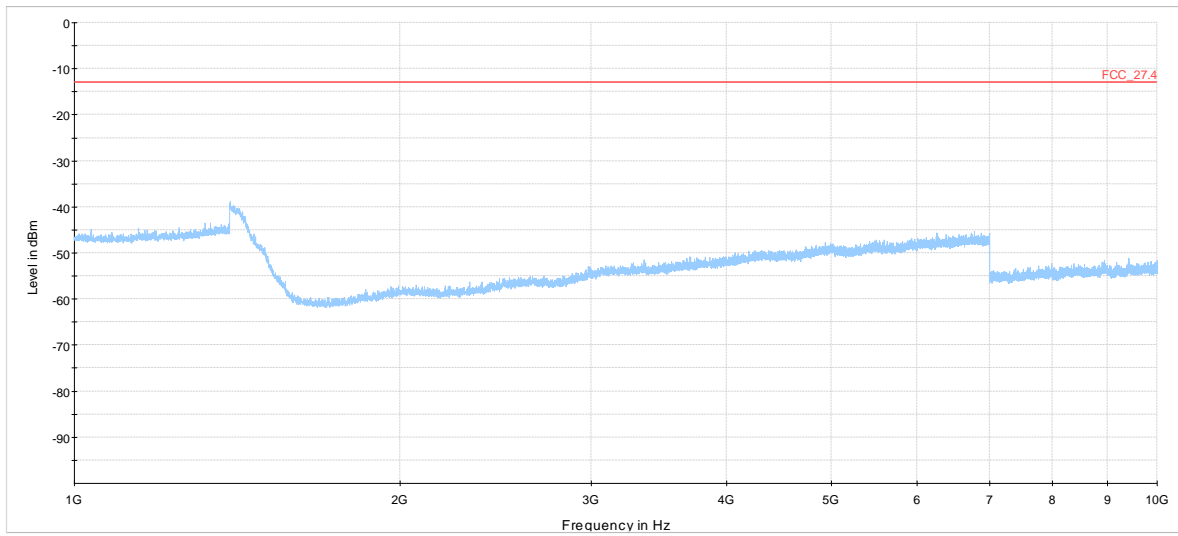

1 GHz - 10 GHz

Frequency Band = Band 13, Test Frequency = low, Direction = RF downlink
(S01_AA01)

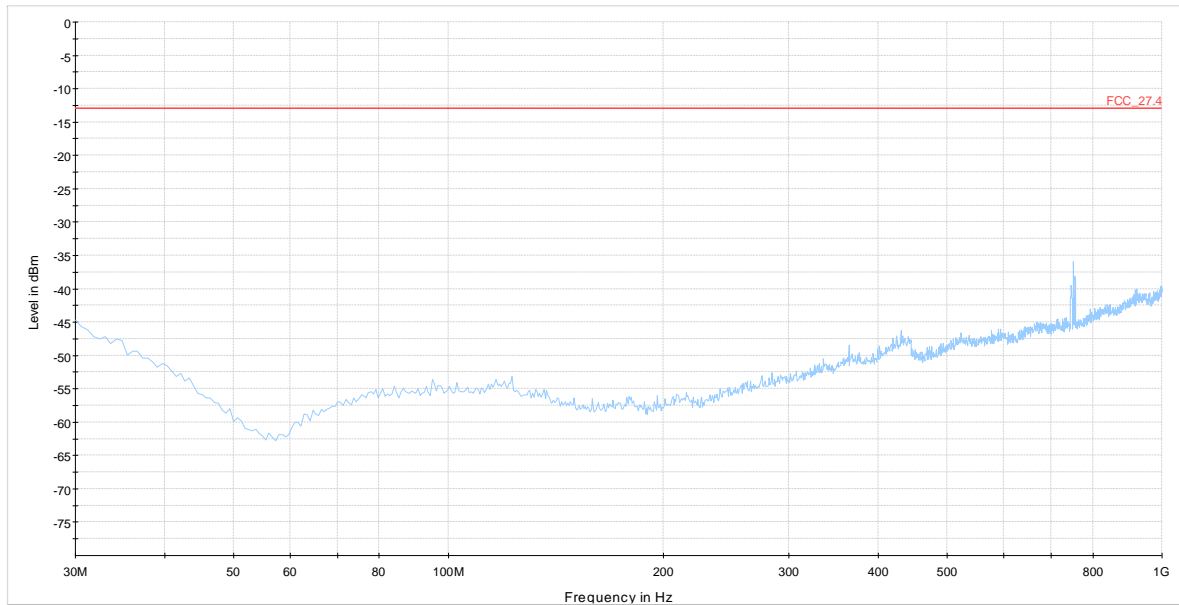

30 MHz - 1 GHz

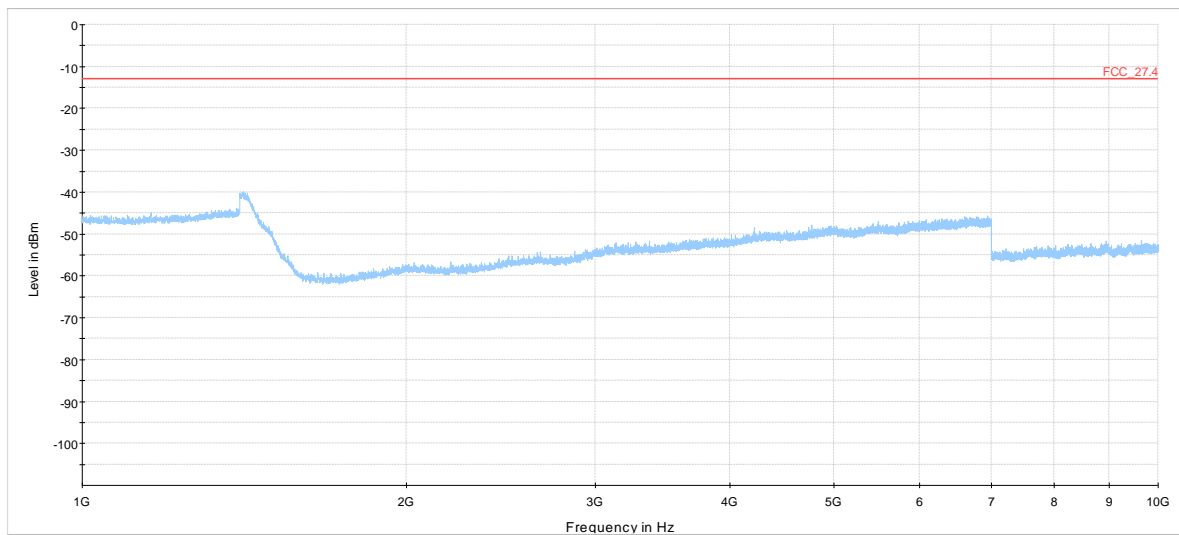

1 GHz - 10 GHz

Frequency Band = Band 13, Test Frequency = mid, Direction = RF downlink
(S01_AA01)

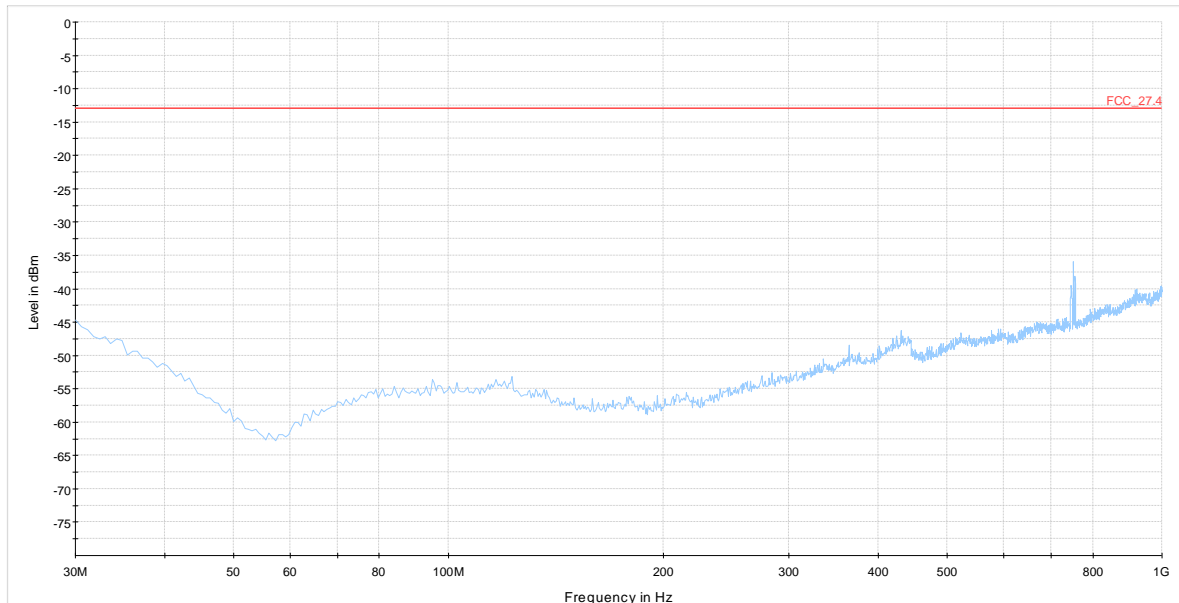

30 MHz - 1 GHz

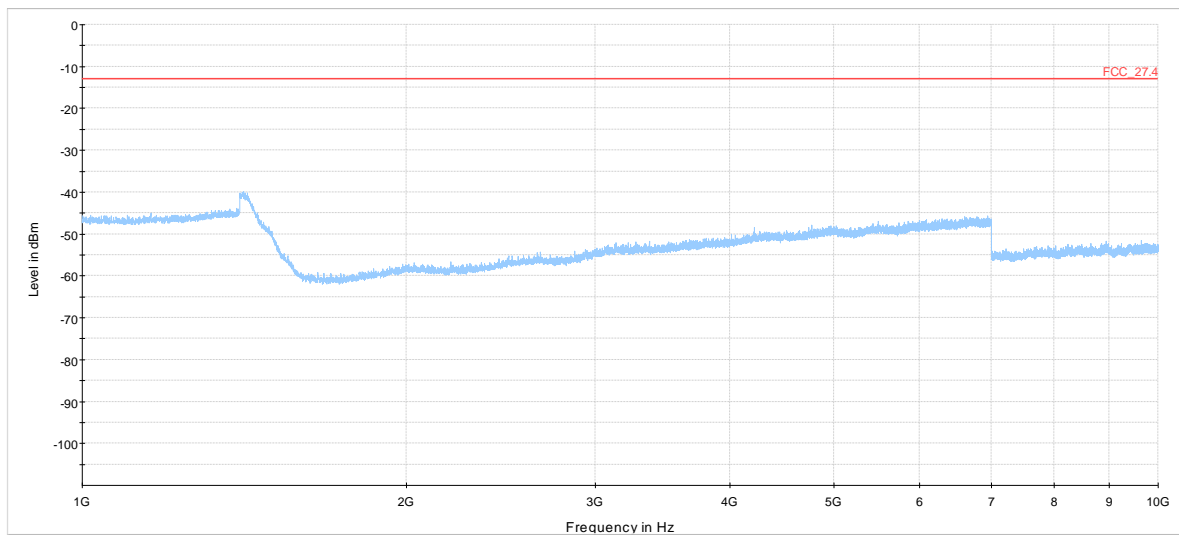

1 GHz - 10 GHz

Frequency Band = Band 13, Test Frequency = high, Direction = RF downlink
(S01_AA01)

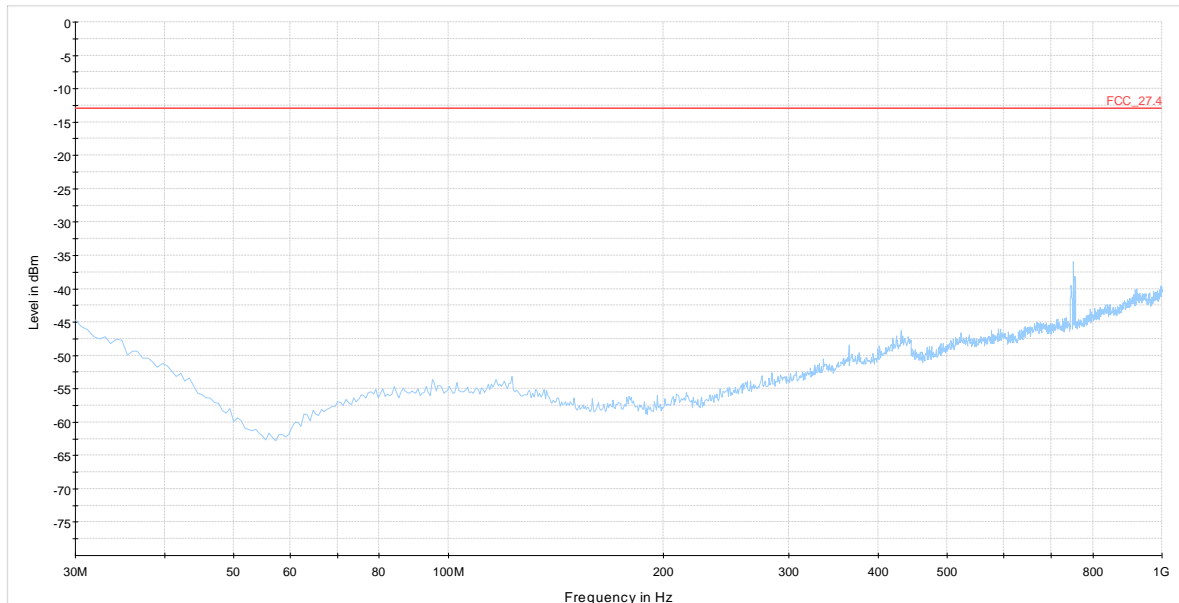

30 MHz - 1 GHz

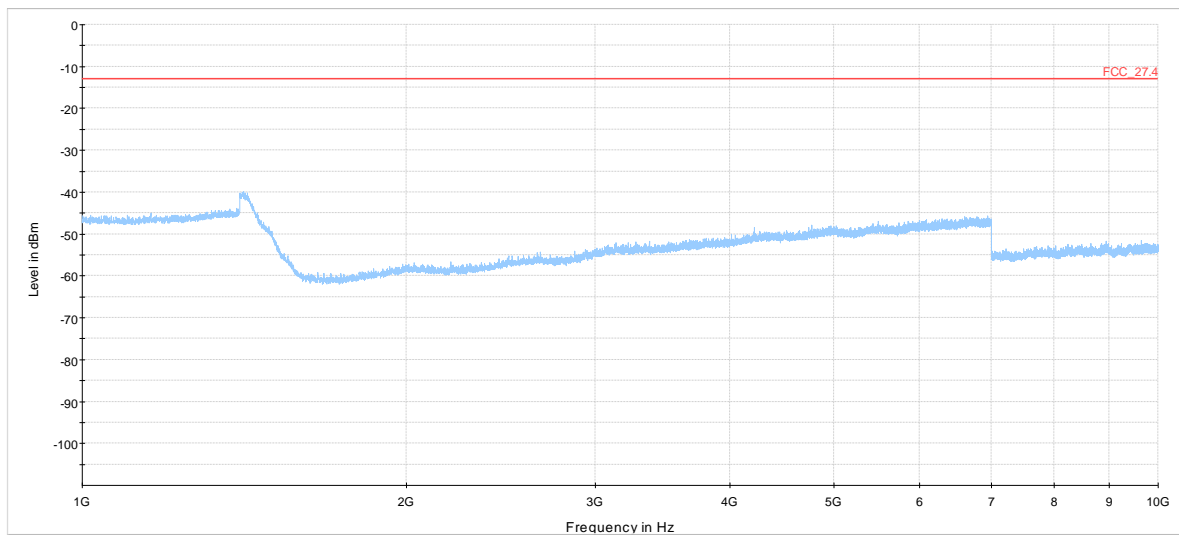

1 GHz - 22 GHz

4.1.4 TEST EQUIPMENT USED

- Radiated Emissions

5 TEST EQUIPMENT

- 1 Radiated Emissions
Lab to perform radiated emission tests

Ref.No.	Device Name	Description	Manufacturer	Serial Number	Last Calibration	Calibration Due
1.1	MFS	Rubidium Frequency Normal MFS	Datum GmbH	002	2017-10	2018-10
1.2	Opus10 TPR (8253.00)	ThermoAirpressure Datalogger 13 (Environ)	Lufft Mess- und Regeltechnik GmbH	13936	2017-04	2019-04
1.3	Anechoic Chamber	10.58 x 6.38 x 6.00 m ³	Frankonia	none	2016-05	2019-05
1.4	HL 562	Ultralog new biconicals	Rohde & Schwarz	830547/003	2015-06	2018-06
1.5	5HC2700/12750-1.5-KK	High Pass Filter	Trilithic	9942012		
1.6	ASP 1.2/1.8-10 kg	Antenna Mast	Maturo GmbH	-		
1.7	Fully Anechoic Room	8.80m x 4.60m x 4.05m (l x w x h)	Albatross Projects	P26971-647-001-PRB	2015-06	2018-06
1.8	Fluke 177	Digital Multimeter 03 (Multimeter)	Fluke Europe B.V.	86670383	2018-04	2020-04
1.9	JS4-18002600-32-5P	Broadband Amplifier 18 GHz - 26 GHz	Miteq	849785		
1.10	FSW 43	Spectrum Analyzer	Rohde & Schwarz	103779	2016-12	2018-12
1.11	3160-09	Standard Gain / Pyramidal Horn Antenna 26.5 GHz	EMCO Elektronik GmbH	00083069		
1.12	WHKX 7.0/18G-8SS	High Pass Filter	Wainwright	09		
1.13	4HC1600/12750-1.5-KK	High Pass Filter	Trilithic	9942011		
1.14	Chroma 6404	AC Power Source	Chroma ATE INC.	64040001304		
1.15	JS4-00102600-42-5A	Broadband Amplifier 30 MHz - 26 GHz	Miteq	619368		
1.16	TT 1.5 WI	Turn Table	Maturo GmbH	-		
1.17	HL 562 Ultralog	Log.-per. Antenna	Rohde & Schwarz	100609	2016-04	2019-04
1.18	3160-10	Standard Gain / Pyramidal Horn Antenna 40 GHz	EMCO Elektronik GmbH	00086675		
1.19	5HC3500/18000-1.2-KK	High Pass Filter	Trilithic	200035008		
1.20	Opus10 THI (8152.00)	ThermoHygro Datalogger 12 (Environ)	Lufft Mess- und Regeltechnik GmbH	12482	2017-03	2019-03

Ref.No.	Device Name	Description	Manufacturer	Serial Number	Last Calibration	Calibration Due
1.21	ESR 7	EMI Receiver / Spectrum Analyzer	Rohde & Schwarz	101424	2016-11	2018-11
1.22	JS4-00101800-35-5P	Broadband Amplifier 30 MHz - 18 GHz	Miteq	896037		
1.23	AS 620 P	Antenna mast	HD GmbH	620/37		
1.24	Tilt device Maturo (Rohacell)	Antrieb TD1.5-10kg	Maturo GmbH	TD1.5-10kg/024/3790709		
1.25	ESW 44	Spectrum Analyzer	1Rohde & Schwarz	101603	2018-05	2020-05
1.26	PAS 2.5 - 10 kg	Antenna Mast	Maturo GmbH	-		
1.27	AM 4.0	Antenna mast	Maturo GmbH	AM4.0/180/11920513		
1.28	HF 906	Double-ridged horn	Rohde & Schwarz	357357/001	2018-03	2021-03

2 FCC Conducted Base Station / Repeater
EN300328/301893/FCC cond. Test Lab

Ref.No.	Device Name	Description	Manufacturer	Serial Number	Last Calibration	Calibration Due
2.1	FSV40	Signal Analyzer 10 Hz - 40 GHz	Rohde & Schwarz	100886	2017-08	2018-08
2.2	SMBV100A	Vector Signal Generator 9 kHz - 6 GHz	Rohde & Schwarz	255975	2017-08	2020-08
2.3	SMIQ	Vector Signal Generator 9 kHz - 3.3 GHz	Rohde & Schwarz	831389/062	2016-08	2018-08
2.4	SMIQ	Vector Signal Generator 9 kHz - 3.3 GHz	Rohde & Schwarz	831389/063	2016-10	2018-10

The calibration interval is the time interval between "Last Calibration" and "Calibration Due"

6 ANTENNA FACTORS, CABLE LOSS AND SAMPLE CALCULATIONS

This chapter contains the antenna factors with their corresponding path loss of the used measurement path for all antennas as well as the insertion loss of the LISN.

6.1 LISN R&S ESH3-Z5 (150 KHZ – 30 MHZ)

Frequency MHz	Corr. dB	LISN insertion loss ESH3- Z5 dB	cable loss (incl. 10 dB atten- uator) dB
0.15	10.1	0.1	10.0
5	10.3	0.1	10.2
7	10.3	0.2	10.3
10	10.3	0.2	10.3
12	10.7	0.3	10.4
14	10.7	0.3	10.4
16	10.8	0.4	10.4
18	10.9	0.4	10.3
20	10.9	0.4	10.3
22	11.1	0.3	10.6
24	11.1	0.3	10.6
26	11.2	0.3	10.7
28	11.2	0.3	10.7
30	11.3	0.3	10.8

Sample calculation

$$U_{\text{LISN}} (\text{dB } \mu\text{V}) = U (\text{dB } \mu\text{V}) + \text{Corr. (dB)}$$

U = Receiver reading

LISN Insertion loss = Voltage Division Factor of LISN

Corr. = sum of single correction factors of used LISN, cables, switch units (if used)

Linear interpolation will be used for frequencies in between the values in the table.

6.2 ANTENNA R&S HFH2-Z2 (9 KHZ – 30 MHZ)

Frequency MHz	AF HFH-Z2) dB (1/m)	Corr. dB	cable loss 1 (inside chamber) dB	cable loss 2 (outside chamber) dB	cable loss 3 (switch unit) dB	cable loss 4 (to receiver) dB	distance corr. (-40 dB/ decade) dB	d _{Limit} (meas. distance (limit) m	d _{used} (meas. distance (used) m
0.009	20.30	-79.6	0.1	0.1	0.1	0.1	-80	300	3
0.01	20.45	-79.6	0.1	0.1	0.1	0.1	-80	300	3
0.015	20.37	-79.6	0.1	0.1	0.1	0.1	-80	300	3
0.02	20.36	-79.6	0.1	0.1	0.1	0.1	-80	300	3
0.025	20.38	-79.6	0.1	0.1	0.1	0.1	-80	300	3
0.03	20.32	-79.6	0.1	0.1	0.1	0.1	-80	300	3
0.05	20.35	-79.6	0.1	0.1	0.1	0.1	-80	300	3
0.08	20.30	-79.6	0.1	0.1	0.1	0.1	-80	300	3
0.1	20.20	-79.6	0.1	0.1	0.1	0.1	-80	300	3
0.2	20.17	-79.6	0.1	0.1	0.1	0.1	-80	300	3
0.3	20.14	-79.6	0.1	0.1	0.1	0.1	-80	300	3
0.49	20.12	-79.6	0.1	0.1	0.1	0.1	-80	300	3
0.490001	20.12	-39.6	0.1	0.1	0.1	0.1	-40	30	3
0.3	20.11	-39.6	0.1	0.1	0.1	0.1	-40	30	3
0.8	20.10	-39.6	0.1	0.1	0.1	0.1	-40	30	3
1	20.09	-39.6	0.1	0.1	0.1	0.1	-40	30	3
2	20.08	-39.6	0.1	0.1	0.1	0.1	-40	30	3
3	20.06	-39.6	0.1	0.1	0.1	0.1	-40	30	3
4	20.05	-39.5	0.2	0.1	0.1	0.1	-40	30	3
5	20.05	-39.5	0.2	0.1	0.1	0.1	-40	30	3
6	20.02	-39.5	0.2	0.1	0.1	0.1	-40	30	3
8	19.95	-39.5	0.2	0.1	0.1	0.1	-40	30	3
10	19.83	-39.4	0.2	0.1	0.2	0.1	-40	30	3
12	19.71	-39.4	0.2	0.1	0.2	0.1	-40	30	3
14	19.54	-39.4	0.2	0.1	0.2	0.1	-40	30	3
16	19.53	-39.3	0.3	0.1	0.2	0.1	-40	30	3
18	19.50	-39.3	0.3	0.1	0.2	0.1	-40	30	3
20	19.57	-39.3	0.3	0.1	0.2	0.1	-40	30	3
22	19.61	-39.3	0.3	0.1	0.2	0.1	-40	30	3
24	19.61	-39.3	0.3	0.1	0.2	0.1	-40	30	3
26	19.54	-39.3	0.3	0.1	0.2	0.1	-40	30	3
28	19.46	-39.2	0.3	0.1	0.3	0.1	-40	30	3
30	19.73	-39.1	0.4	0.1	0.3	0.1	-40	30	3

Sample calculation

$E \text{ (dB } \mu\text{V/m)} = U \text{ (dB } \mu\text{V)} + AF \text{ (dB 1/m)} + Corr. \text{ (dB)}$
 U = Receiver reading
 AF = Antenna factor
 Corr. = sum of single correction factors of used cables, switch unit, distance correction, amplifier (if applicable)
 distance correction = $-40 * LOG(d_{Limit} / d_{used})$
 Linear interpolation will be used for frequencies in between the values in the table.
 Table shows an extract of values

6.3 ANTENNA R&S HL562 (30 MHz – 1 GHz)

($d_{Limit} = 3\text{ m}$)

Frequency	AF R&S HL562	Corr.
MHz	dB (1/m)	dB
30	18.6	0.6
50	6.0	0.9
100	9.7	1.2
150	7.9	1.6
200	7.6	1.9
250	9.5	2.1
300	11.0	2.3
350	12.4	2.6
400	13.6	2.9
450	14.7	3.1
500	15.6	3.2
550	16.3	3.5
600	17.2	3.5
650	18.1	3.6
700	18.5	3.6
750	19.1	4.1
800	19.6	4.1
850	20.1	4.4
900	20.8	4.7
950	21.1	4.8
1000	21.6	4.9

cable loss 1 (inside chamber)	cable loss 2 (outside chamber)	cable loss 3 (switch unit)	cable loss 4 (to receiver)	distance corr. (-20 dB/decade)	d_{Limit} (meas. distance (limit))	d_{used} (meas. distance (used))
dB	dB	dB	dB	dB	m	m
0.29	0.04	0.23	0.02	0.0	3	3
0.39	0.09	0.32	0.08	0.0	3	3
0.36	0.14	0.47	0.08	0.0	3	3
0.73	0.20	0.39	0.12	0.0	3	3
0.84	0.21	0.70	0.11	0.0	3	3
0.98	0.24	0.80	0.13	0.0	3	3
1.04	0.26	0.89	0.15	0.0	3	3
1.18	0.31	0.96	0.13	0.0	3	3
1.28	0.35	1.03	0.19	0.0	3	3
1.39	0.38	1.11	0.22	0.0	3	3
1.44	0.39	1.20	0.19	0.0	3	3
1.55	0.46	1.24	0.23	0.0	3	3
1.59	0.43	1.29	0.23	0.0	3	3
1.67	0.34	1.35	0.22	0.0	3	3
1.67	0.42	1.41	0.15	0.0	3	3
1.87	0.34	1.46	0.25	0.0	3	3
1.90	0.46	1.51	0.25	0.0	3	3
1.99	0.60	1.56	0.27	0.0	3	3
2.14	0.60	1.63	0.29	0.0	3	3
2.22	0.60	1.66	0.33	0.0	3	3
2.23	0.61	1.71	0.30	0.0	3	3

($d_{Limit} = 10\text{ m}$)

30	18.6	-9.9
50	6.0	-9.6
100	9.7	-9.2
150	7.9	-8.8
200	7.6	-8.6
250	9.5	-8.3
300	11.0	-8.1
350	12.4	-7.9
400	13.6	-7.6
450	14.7	-7.4
500	15.6	-7.2
550	16.3	-7.0
600	17.2	-6.9
650	18.1	-6.9
700	18.5	-6.8
750	19.1	-6.3
800	19.6	-6.3
850	20.1	-6.0
900	20.8	-5.8
950	21.1	-5.6
1000	21.6	-5.6

0.29	0.04	0.23	0.02	-10.3	10	3
0.39	0.09	0.32	0.08	-10.3	10	3
0.36	0.14	0.47	0.08	-10.3	10	3
0.73	0.20	0.39	0.12	-10.3	10	3
0.84	0.21	0.70	0.11	-10.3	10	3
0.98	0.24	0.80	0.13	-10.3	10	3
1.04	0.26	0.89	0.15	-10.3	10	3
1.18	0.31	0.96	0.13	-10.3	10	3
1.28	0.35	1.03	0.19	-10.3	10	3
1.39	0.38	1.11	0.22	-10.3	10	3
1.44	0.39	1.20	0.19	-10.3	10	3
1.55	0.46	1.24	0.23	-10.3	10	3
1.59	0.43	1.29	0.23	-10.3	10	3
1.67	0.34	1.35	0.22	-10.3	10	3
1.67	0.42	1.41	0.15	-10.3	10	3
1.87	0.34	1.46	0.25	-10.3	10	3
1.90	0.46	1.51	0.25	-10.3	10	3
1.99	0.60	1.56	0.27	-10.3	10	3
2.14	0.60	1.63	0.29	-10.3	10	3
2.22	0.60	1.66	0.33	-10.3	10	3
2.23	0.61	1.71	0.30	-10.3	10	3

Sample calculation

$$E \text{ (dB } \mu\text{V/m)} = U \text{ (dB } \mu\text{V)} + \text{AF (dB 1/m)} + \text{Corr. (dB)}$$

U = Receiver reading

AF = Antenna factor

Corr. = sum of single correction factors of used cables, switch unit, distance correction, amplifier (if applicable)

distance correction = $-20 * \text{LOG} (d_{Limit} / d_{used})$

Linear interpolation will be used for frequencies in between the values in the table.

Tables show an extract of values.

6.4 ANTENNA R&S HF907 (1 GHZ – 18 GHZ)

Frequency MHz	AF R&S HF907 dB (1/m)	Corr. dB
1000	24.4	-19.4
2000	28.5	-17.4
3000	31.0	-16.1
4000	33.1	-14.7
5000	34.4	-13.7
6000	34.7	-12.7
7000	35.6	-11.0

cable loss 1 (relay + cable inside chamber) dB	cable loss 2 (outside chamber) dB	cable loss 3 (switch unit, atten- uator & pre-amp) dB	cable loss 4 (to receiver) dB
0.99	0.31	-21.51	0.79
1.44	0.44	-20.63	1.38
1.87	0.33	-19.85	1.33
2.41	0.67	-19.13	1.31
2.78	0.86	-18.71	1.40
2.74	0.90	-17.83	1.47
2.82	0.86	-16.19	1.46

Frequency MHz	AF R&S HF907 dB (1/m)	Corr. dB
3000	31.0	-23.4
4000	33.1	-23.3
5000	34.4	-21.7
6000	34.7	-21.2
7000	35.6	-19.8

cable loss 1 (relay inside chamber) dB	cable loss 2 (inside chamber) dB	cable loss 3 (outside chamber) dB	cable loss 4 (switch unit, atten- uator & pre-amp) dB	cable loss 5 (to receiver) dB	used for FCC 15.247
0.47	1.87	0.33	-27.58	1.33	
0.36	2.41	0.67	-28.23	1.31	
0.61	2.78	0.86	-27.35	1.40	
0.38	2.74	0.90	-26.89	1.47	
0.66	2.82	0.86	-25.58	1.46	

Frequency MHz	AF R&S HF907 dB (1/m)	Corr. dB
7000	35.6	-57.3
8000	36.3	-56.3
9000	37.1	-55.3
10000	37.5	-56.2
11000	37.5	-55.3
12000	37.6	-53.7
13000	38.2	-53.5
14000	39.9	-56.3
15000	40.9	-54.1
16000	41.3	-54.1
17000	42.8	-54.4
18000	44.2	-54.7

cable loss 1 (relay inside chamber) dB	cable loss 2 (High Pass) dB	cable loss 3 (pre- amp) dB	cable loss 4 (inside chamber) dB	cable loss 5 (outside chamber) dB	cable loss 6 (to receiver) dB
0.36	1.28	-62.72	2.66	0.94	1.46
0.69	0.71	-61.49	2.84	1.00	1.53
0.68	0.65	-60.80	3.06	1.09	1.60
0.70	0.34	-61.91	3.28	1.20	1.67
0.80	0.61	-61.40	3.43	1.27	1.70
0.84	0.42	-59.70	3.53	1.26	1.73
0.83	0.44	-59.81	3.75	1.32	1.83
0.91	0.33	-63.03	3.91	1.40	1.77
0.98	0.34	-61.05	4.02	1.44	1.83
1.23	0.49	-61.51	4.17	1.51	1.85
1.36	0.76	-62.36	4.34	1.53	2.00
1.70	0.33	-62.88	4.41	1.55	1.91

Sample calculation

$$E \text{ (dB } \mu\text{V/m)} = U \text{ (dB } \mu\text{V)} + \text{AF (dB 1/m)} + \text{Corr. (dB)}$$

U = Receiver reading

AF = Antenna factor

Corr. = sum of single correction factors of used cables, switch unit, distance correction, amplifier (if applicable)

Linear interpolation will be used for frequencies in between the values in the table.

Tables show an extract of values.

6.5 ANTENNA EMCO 3160-09 (18 GHZ – 26.5 GHZ)

Frequency MHz	AF EMCO 3160-09 dB (1/m)	Corr. dB	cable loss 1 (inside chamber) dB	cable loss 2 (pre- amp) dB	cable loss 3 (inside chamber) dB	cable loss 4 (switch unit) dB	cable loss 5 (to receiver) dB
18000	40.2	-23.5	0.72	-35.85	6.20	2.81	2.65
18500	40.2	-23.2	0.69	-35.71	6.46	2.76	2.59
19000	40.2	-22.0	0.76	-35.44	6.69	3.15	2.79
19500	40.3	-21.3	0.74	-35.07	7.04	3.11	2.91
20000	40.3	-20.3	0.72	-34.49	7.30	3.07	3.05
20500	40.3	-19.9	0.78	-34.46	7.48	3.12	3.15
21000	40.3	-19.1	0.87	-34.07	7.61	3.20	3.33
21500	40.3	-19.1	0.90	-33.96	7.47	3.28	3.19
22000	40.3	-18.7	0.89	-33.57	7.34	3.35	3.28
22500	40.4	-19.0	0.87	-33.66	7.06	3.75	2.94
23000	40.4	-19.5	0.88	-33.75	6.92	3.77	2.70
23500	40.4	-19.3	0.90	-33.35	6.99	3.52	2.66
24000	40.4	-19.8	0.88	-33.99	6.88	3.88	2.58
24500	40.4	-19.5	0.91	-33.89	7.01	3.93	2.51
25000	40.4	-19.3	0.88	-33.00	6.72	3.96	2.14
25500	40.3	-20.4	0.89	-34.07	6.90	3.66	2.22
26000	40.3	-21.3	0.86	-35.11	7.02	3.69	2.28
26500	40.3	-21.1	0.90	-35.20	7.15	3.91	2.36

Sample calculation

$$E \text{ (dB } \mu\text{V/m)} = U \text{ (dB } \mu\text{V)} + AF \text{ (dB 1/m)} + Corr. \text{ (dB)}$$

U = Receiver reading

AF = Antenna factor

Corr. = sum of single correction factors of used cables, switch unit, distance correction, amplifier (if applicable)

Linear interpolation will be used for frequencies in between the values in the table.

Table shows an extract of values.

6.6 ANTENNA EMCO 3160-10 (26.5 GHZ – 40 GHZ)

Frequency GHz	AF EMCO 3160-10 dB (1/m)	Corr. dB	cable loss 1 (inside chamber) dB	cable loss 2 (outside chamber) dB	cable loss 3 (switch unit) dB	cable loss 4 (to receiver) dB	distance corr. (-20 dB/ decade) dB	d _{Limit} (meas. distance (limit) m	d _{used} (meas. distance (used) m
26.5	43.4	-11.2	4.4				-15.6	3	0.3
27.0	43.4	-11.2	4.4				-15.6	3	0.3
28.0	43.4	-11.1	4.5				-15.6	3	0.3
29.0	43.5	-11.0	4.6				-15.6	3	0.3
30.0	43.5	-10.9	4.7				-15.6	3	0.3
31.0	43.5	-10.8	4.7				-15.6	3	0.3
32.0	43.5	-10.7	4.8				-15.6	3	0.3
33.0	43.6	-10.7	4.9				-15.6	3	0.3
34.0	43.6	-10.6	5.0				-15.6	3	0.3
35.0	43.6	-10.3	5.1				-15.6	3	0.3
36.0	43.6	-10.4	5.1				-15.6	3	0.3
37.0	43.7	-10.3	5.2				-15.6	3	0.3
38.0	43.7	-10.2	5.3				-15.6	3	0.3
39.0	43.7	-10.2	5.4				-15.6	3	0.3
40.0	43.8	-10.1	5.5				-15.6	3	0.3

Sample calculation

$$E \text{ (dB } \mu\text{V/m)} = U \text{ (dB } \mu\text{V)} + \text{AF (dB 1/m)} + \text{Corr. (dB)}$$

U = Receiver reading

AF = Antenna factor

Corr. = sum of single correction factors of used cables, switch unit, distance correction, amplifier (if applicable)

Linear interpolation will be used for frequencies in between the values in the table.

$$\text{distance correction} = -20 * \text{LOG} (d_{\text{Limit}} / d_{\text{used}})$$

Linear interpolation will be used for frequencies in between the values in the table.

Table shows an extract of values.

7 MEASUREMENT UNCERTAINTIES

Test Case(s)	Parameter	Uncertainty
- Field strength of spurious radiation	Power	± 5.5 dB
- Out-of-band rejection - Occupied Bandwidth - Input versus output spectrum	Power Frequency	± 2.9 dB ± 11.2 kHz
- Effective radiated power, mean output power and zone enhancer gain - Peak to Average Ratio	Power	± 2.2 dB
- Out-of-band emission limits - Conducted Spurious Emissions at Antenna Terminal	Power Frequency	± 2.2 dB ± 11.2 kHz

8 PHOTO REPORT

Please see separate photo report.