

# FCC Measurement/Technical Report on

## ION-U System

### EU L 17EP/17EP-Vac

### Cellular Repeater

FCC ID: XS5-UEUL17E17E  
IC: 2237E-UEUL17E17E

Test Report Reference: MDE\_COMMS\_1703\_FCCa\_REV1

#### Test Laboratory:

7layers GmbH  
Borsigstrasse 11  
40880 Ratingen  
Germany



#### Note:

The following test results relate only to the devices specified in this document. This report shall not be reproduced in parts without the written approval of the test laboratory.

**7layers GmbH**  
Borsigstraße 11  
40880 Ratingen, Germany  
T +49 (0) 2102 749 0  
F +49 (0) 2102 749 350

Geschäftsführer/  
Managing Directors:  
Frank Spiller  
Bernhard Retka  
Alexandre Norré-Oudard

Registergericht/registered:  
Düsseldorf HRB 75554  
USt-Id.-Nr./VAT-No. DE203159652  
Steuer-Nr./TAX-No. 147/5869/0385

a Bureau Veritas  
Group Company

[www.7layers.com](http://www.7layers.com)

## Table of Contents

1.1	Applied Standards	3
1.2	FCC-IC Correlation Table	4
1.3	Measurement Summary / Signatures	5
<b>2</b>	<b>Administrative Data</b>	<b>11</b>
2.1	Testing Laboratory	11
2.2	Project Data	11
2.3	Applicant Data	11
2.4	Manufacturer Data	11
<b>3</b>	<b>Test object Data</b>	<b>12</b>
3.1	General EUT Description	12
3.2	EUT Main components	12
3.3	Ancillary Equipment	13
3.4	Auxiliary Equipment	13
3.5	EUT Setups	13
3.6	Operating Modes	14
3.7	Product labelling	15
<b>4</b>	<b>Test Results</b>	<b>16</b>
4.1	Effective Radiated Power, mean output power and zone enhancer gain	16
4.2	Peak to Average Ratio	26
4.3	Occupied Bandwidth / Input-versus-output Spectrum	32
4.4	Conducted spurious emissions at antenna terminals	43
4.5	Out-of-band emission limits	57
4.6	Out-of-band rejection	77
4.7	Field strength of spurious radiation	80
<b>5</b>	<b>Test Equipment</b>	<b>88</b>
<b>6</b>	<b>Antenna Factors, Cable Loss and Sample Calculations</b>	<b>91</b>
6.1	LISN R&S ESH3-Z5 (150 kHz – 30 MHz)	91
6.2	Antenna R&S HFH2-Z2 (9 kHz – 30 MHz)	92
6.3	Antenna R&S HL562 (30 MHz – 1 GHz)	93
6.4	Antenna R&S HF907 (1 GHz – 18 GHz)	94
6.5	Antenna EMCO 3160-09 (18 GHz – 26.5 GHz)	95
6.6	Antenna EMCO 3160-10 (26.5 GHz – 40 GHz)	96
<b>7</b>	<b>Measurement Uncertainties</b>	<b>97</b>
<b>8</b>	<b>Photo Report</b>	<b>97</b>

## Applied Standards and Test Summary

### 1.1 APPLIED STANDARDS

#### **Type of Authorization**

Certification for an Industrial Signal Booster.

#### **Applicable FCC Rules**

Prepared in accordance with the requirements of FCC Rules and Regulations as listed in 47 CFR Ch.1 Parts 2 and 20, 27, (10/1/16 Edition). The following subparts are applicable to the results in this test report.

Part 2, Subpart J - Equipment Authorization Procedures, Certification

Part 20, Commercial Mobiles Services

§ 20.21 Signal Boosters

Part 27; Miscellaneous Wireless Communications Services  
Subpart C – Technical standards

§ 27.50 – Power and duty cycle limits

§ 27.53 – Emission limits

§ 27.54 – Frequency stability

The tests were selected and performed with reference to:

- FCC Public Notice 935210 applying “Signal Boosters Basic Certification Requirements” 935210 D02 v04, 2017-10-27.
- FCC Public Notice 935210 applying “Measurement guidance for industrial and non-consumer signal booster, repeater and amplifier devices” 935210 D05 v01r02, 2017-10-27.
- FCC Public Notice 971168 applying “Measurement guidance for certification of licensed digital transmitters” 971168 D01 v03,2017-10-27
- ANSI C63.26: 2015

**Summary Test Results:**

The EUT complied with all performed tests as listed in chapter 1.3 Measurement Summary / Signatures.

1.2 FCC-IC CORRELATION TABLE

**Correlation of measurement requirements for  
Industrial Signal Booster  
from  
FCC and ISED Canada**

Measurement	FCC reference	ISED reference
Effective radiated power, mean output power and zone enhancer gain	§2.1046 §27.50 KDB 935210 D05 v01r02: 3.5	RSS-GEN Issue 4, 6.12 RSS-139 Issue 3, 6.5 SRSP-513, Issue 3, 5.1.1 RSS-130 Issue 1, 4.4 SRSP-518, Issue 1, 5.1.1 RSS-131 Issue 3: 5.2.3
Peak to Average Ratio	§27.50	RSS 139 Issue 3: 6.5 RSS-130 Issue 1, 4.4
Occupied bandwidth Input-versus-output spectrum	§2.1049 KDB 935210 D05 v01r02: 3.4	RSS-GEN Issue 4, 6.6 RSS-131 Issue 3: 5.2.2
Conducted spurious Emission at Antenna Terminal	§2.1051 §27.53	RSS-GEN Issue 4, 6.13 RSS-139 Issue 3, 6.6 RSS-130 Issue 1: 4.6
Out-of-band emissions limits	§2.1051 §27.53 KDB 935210 D05 v01r02: 3.6	RSS-GEN Issue 4, 6.13 RSS-139 Issue 3, 6.6 RSS-130 Issue 1: 4.6
Frequency stability	§2.1055 §27.54	RSS-GEN Issue 4, 6.11 RSS-139 Issue 3: 6.4 RSS-130 Issue 1: 4.3 RSS-131 Issue 3: 5.2.4
Field strength of spurious radiation	§2.1053 §27.53	RSS-GEN Issue 4, 6.13 RSS-139 Issue 3: 6.6 RSS-130 Issue 1: 4.6
Out-of-band rejection	KDB 935210 D05 v01r02: 3.3	RSS-131 Issue 3: 5.2.1

### 1.3 MEASUREMENT SUMMARY / SIGNATURES

#### Module 1:

#### 47 CFR CHAPTER I FCC PART 27 Subpart C [Base Stations/Repeater] \$2.1046, \$27.50

Effective Radiated Power, mean output power and zone enhancer gain  
The measurement was performed according to ANSI C63.26, KDB 935210 D05 v01r02: 3.5

#### Final Result

OP-Mode	Setup	FCC	IC
Frequency Band, Direction, Input Power, Signal Type			
Band 4/10/66, RF downlink, 0.3 dB < AGC, Narrowband	S01_AA01	Passed	Passed
Band 4/10/66, RF downlink, 0.3 dB < AGC, Wideband	S01_AA01	Passed	Passed
Band 4/10/66, RF downlink, 3 dB > AGC, Narrowband	S01_AA01	Passed	Passed
Band 4/10/66, RF downlink, 3 dB > AGC, Wideband	S01_AA01	Passed	Passed

#### 47 CFR CHAPTER I FCC PART 27 Subpart C [Base Stations/Repeater] \$27.50

Peak to Average Ratio  
The measurement was performed according to ANSI C63.26

#### Final Result

OP-Mode	Setup	FCC	IC
Frequency Band, Direction, Input Power, Signal Type			
Band 4/10/66, RF downlink, 0.3 dB < AGC, Narrowband	S01_AA01	Passed	Passed
Band 4/10/66, RF downlink, 0.3 dB < AGC, Wideband	S01_AA01	Passed	Passed
Band 4/10/66, RF downlink, 3 dB > AGC, Narrowband	S01_AA01	Passed	Passed
Band 4/10/66, RF downlink, 3 dB > AGC, Wideband	S01_AA01	Passed	Passed

#### 47 CFR CHAPTER I FCC PART 27 Subpart C [Base Stations/Repeater] \$2.1049

Occupied Bandwidth / Input-versus-output Spectrum  
The measurement was performed according to ANSI C63.26, KDB 935210 D05 v01r02: 3.4

#### Final Result

OP-Mode	Setup	FCC	IC
Frequency Band, Direction, Input Power, Signal Type			
Band 4/10/66, RF downlink, 0.3 dB < AGC, Narrowband	S01_AA01	Passed	Passed
Band 4/10/66, RF downlink, 0.3 dB < AGC, Wideband	S01_AA01	Passed	Passed
Band 4/10/66, RF downlink, 3 dB > AGC, Narrowband	S01_AA01	Passed	Passed
Band 4/10/66, RF downlink, 3 dB > AGC, Wideband	S01_AA01	Passed	Passed

**47 CFR CHAPTER I FCC PART 27 Subpart C [Base §2.1051, §27.53 Stations/Repeater]**

Conducted spurious emissions at antenna terminals

The measurement was performed according to ANSI C63.26

**Final Result**

OP-Mode	Setup	FCC	IC
Frequency Band, Test Frequency, Direction, Signal Type			
Band 4/10/66, high, RF downlink, Narrowband	S01_AA01	Passed	Passed
Band 4/10/66, high, RF downlink, Wideband	S01_AA01	Passed	Passed
Band 4/10/66, low, RF downlink, Narrowband	S01_AA01	Passed	Passed
Band 4/10/66, low, RF downlink, Wideband	S01_AA01	Passed	Passed
Band 4/10/66, mid, RF downlink, Narrowband	S01_AA01	Passed	Passed
Band 4/10/66, mid, RF downlink, Wideband	S01_AA01	Passed	Passed

**47 CFR CHAPTER I FCC PART 27 Subpart C [Base §2.1051, § 27.53 Stations/Repeater]**

Out-of-band emission limits

The measurement was performed according to ANSI C63.26, KDB 935210 D05 v01r02: 3.6

**Final Result**

OP-Mode	Setup	FCC	IC
Band Edge, Frequency Band, Number of signals, Direction, Input Power, Signal Type			
Lower, Band 4/10/66, 1, RF downlink, 0.3 dB < AGC, Narrowband	S01_AA01	Passed	Passed
Lower, Band 4/10/66, 1, RF downlink, 0.3 dB < AGC, Wideband	S01_AA01	Passed	Passed
Lower, Band 4/10/66, 1, RF downlink, 3 dB > AGC, Narrowband	S01_AA01	Passed	Passed
Lower, Band 4/10/66, 1, RF downlink, 3 dB > AGC, Wideband	S01_AA01	Passed	Passed
Lower, Band 4/10/66, 2, RF downlink, 0.3 dB < AGC, Narrowband	S01_AA01	Passed	Passed
Lower, Band 4/10/66, 2, RF downlink, 0.3 dB < AGC, Wideband	S01_AA01	Passed	Passed
Lower, Band 4/10/66, 2, RF downlink, 3 dB > AGC, Narrowband	S01_AA01	Passed	Passed
Lower, Band 4/10/66, 2, RF downlink, 3 dB > AGC, Wideband	S01_AA01	Passed	Passed
Upper, Band 4/10/66, 1, RF downlink, 0.3 dB < AGC, Narrowband	S01_AA01	Passed	Passed
Upper, Band 4/10/66, 1, RF downlink, 0.3 dB < AGC, Wideband	S01_AA01	Passed	Passed
Upper, Band 4/10/66, 1, RF downlink, 3 dB > AGC, Narrowband	S01_AA01	Passed	Passed
Upper, Band 4/10/66, 1, RF downlink, 3 dB > AGC, Wideband	S01_AA01	Passed	Passed
Upper, Band 4/10/66, 2, RF downlink, 0.3 dB < AGC, Narrowband	S01_AA01	Passed	Passed
Upper, Band 4/10/66, 2, RF downlink, 0.3 dB < AGC, Wideband	S01_AA01	Passed	Passed
Upper, Band 4/10/66, 2, RF downlink, 3 dB > AGC, Narrowband	S01_AA01	Passed	Passed
Upper, Band 4/10/66, 2, RF downlink, 3 dB > AGC, Wideband	S01_AA01	Passed	Passed

**47 CFR CHAPTER I FCC PART 27 Subpart C [Base KDB 935210 D05 v01r02: 3.3 Stations/Repeater]**

Out-of-band rejection

The measurement was performed according to ANSI C63.26

**Final Result**

OP-Mode	Setup	FCC	IC
Frequency Band, Direction			
Band 4/10/66, RF downlink	S01_AA01	Passed	Passed

**47 CFR CHAPTER I FCC PART 27 Subpart C [Base Stations/Repeater] §2.1053, §27.53**

---

Field strength of spurious radiation

The measurement was performed according to ANSI C63.26

**Final Result**

**OP-Mode**

Frequency Band, Test Frequency, Direction

Band 4/10/66, high, RF downlink

Band 4/10/66, low, RF downlink

Band 4/10/66, mid, RF downlink

**Setup**

S01\_AA01

S01\_AA01

S01\_AA01

**FCC**

Passed

Passed

Passed

**IC**

Passed

Passed

Passed

**Module 2:**

**47 CFR CHAPTER I FCC PART 27 Subpart C [Base Stations/Repeater] §2.1046, §27.50**

Effective Radiated Power, mean output power and zone enhancer gain  
The measurement was performed according to ANSI C63.26, KDB 935210 D05 v01r02: 3.5

**Final Result**

OP-Mode	Setup	FCC	IC
Frequency Band, Direction, Input Power, Signal Type			
Band 4/10/66, RF downlink, 0.3 dB < AGC, Narrowband	S01_AA01	Passed	Passed
Band 4/10/66, RF downlink, 0.3 dB < AGC, Wideband	S01_AA01	Passed	Passed
Band 4/10/66, RF downlink, 3 dB > AGC, Narrowband	S01_AA01	Passed	Passed
Band 4/10/66, RF downlink, 3 dB > AGC, Wideband	S01_AA01	Passed	Passed

**47 CFR CHAPTER I FCC PART 27 Subpart C [Base Stations/Repeater] §27.50**

Peak to Average Ratio  
The measurement was performed according to ANSI C63.26

**Final Result**

OP-Mode	Setup	FCC	IC
Frequency Band, Direction, Input Power, Signal Type			
Band 4/10/66, RF downlink, 0.3 dB < AGC, Narrowband	S01_AA01	Passed	Passed
Band 4/10/66, RF downlink, 0.3 dB < AGC, Wideband	S01_AA01	Passed	Passed
Band 4/10/66, RF downlink, 3 dB > AGC, Narrowband	S01_AA01	Passed	Passed
Band 4/10/66, RF downlink, 3 dB > AGC, Wideband	S01_AA01	Passed	Passed

**47 CFR CHAPTER I FCC PART 27 Subpart C [Base Stations/Repeater] §2.1049**

Occupied Bandwidth / Input-versus-output Spectrum  
The measurement was performed according to ANSI C63.26, KDB 935210 D05 v01r02: 3.4

**Final Result**

OP-Mode	Setup	FCC	IC
Frequency Band, Direction, Input Power, Signal Type			
Band 4/10/66, RF downlink, 0.3 dB < AGC, Narrowband	S01_AA01	Passed	Passed
Band 4/10/66, RF downlink, 0.3 dB < AGC, Wideband	S01_AA01	Passed	Passed
Band 4/10/66, RF downlink, 3 dB > AGC, Narrowband	S01_AA01	Passed	Passed
Band 4/10/66, RF downlink, 3 dB > AGC, Wideband	S01_AA01	Passed	Passed



**47 CFR CHAPTER I FCC PART 27 Subpart C [Base §2.1051, §27.53 Stations/Repeater]**

Conducted spurious emissions at antenna terminals

The measurement was performed according to ANSI C63.26

**Final Result**

<b>OP-Mode</b>	<b>Setup</b>	<b>FCC</b>	<b>IC</b>
Frequency Band, Test Frequency, Direction, Signal Type			
Band 4/10/66, high, RF downlink, Narrowband	S01_AA01	Passed	Passed
Band 4/10/66, high, RF downlink, Wideband	S01_AA01	Passed	Passed
Band 4/10/66, low, RF downlink, Narrowband	S01_AA01	Passed	Passed
Band 4/10/66, low, RF downlink, Wideband	S01_AA01	Passed	Passed
Band 4/10/66, mid, RF downlink, Narrowband	S01_AA01	Passed	Passed
Band 4/10/66, mid, RF downlink, Wideband	S01_AA01	Passed	Passed

**47 CFR CHAPTER I FCC PART 27 Subpart C [Base §2.1051, § 27.53 Stations/Repeater]**

Out-of-band emission limits

The measurement was performed according to ANSI C63.26, KDB 935210 D05 v01r02: 3.6

**Final Result**

<b>OP-Mode</b>	<b>Setup</b>	<b>FCC</b>	<b>IC</b>
Band Edge, Frequency Band, Number of signals, Direction, Input Power, Signal Type			
Lower, Band 4/10/66, 1, RF downlink, 0.3 dB < AGC, Narrowband	S01_AA01	Passed	Passed
Lower, Band 4/10/66, 1, RF downlink, 0.3 dB < AGC, Wideband	S01_AA01	Passed	Passed
Lower, Band 4/10/66, 1, RF downlink, 3 dB > AGC, Narrowband	S01_AA01	Passed	Passed
Lower, Band 4/10/66, 1, RF downlink, 3 dB > AGC, Wideband	S01_AA01	Passed	Passed
Lower, Band 4/10/66, 2, RF downlink, 0.3 dB < AGC, Narrowband	S01_AA01	Passed	Passed
Lower, Band 4/10/66, 2, RF downlink, 0.3 dB < AGC, Wideband	S01_AA01	Passed	Passed
Lower, Band 4/10/66, 2, RF downlink, 3 dB > AGC, Narrowband	S01_AA01	Passed	Passed
Lower, Band 4/10/66, 2, RF downlink, 3 dB > AGC, Wideband	S01_AA01	Passed	Passed
Upper, Band 4/10/66, 1, RF downlink, 0.3 dB < AGC, Narrowband	S01_AA01	Passed	Passed
Upper, Band 4/10/66, 1, RF downlink, 0.3 dB < AGC, Wideband	S01_AA01	Passed	Passed
Upper, Band 4/10/66, 1, RF downlink, 3 dB > AGC, Narrowband	S01_AA01	Passed	Passed
Upper, Band 4/10/66, 1, RF downlink, 3 dB > AGC, Wideband	S01_AA01	Passed	Passed
Upper, Band 4/10/66, 2, RF downlink, 0.3 dB < AGC, Narrowband	S01_AA01	Passed	Passed
Upper, Band 4/10/66, 2, RF downlink, 0.3 dB < AGC, Wideband	S01_AA01	Passed	Passed
Upper, Band 4/10/66, 2, RF downlink, 3 dB > AGC, Narrowband	S01_AA01	Passed	Passed
Upper, Band 4/10/66, 2, RF downlink, 3 dB > AGC, Wideband	S01_AA01	Passed	Passed

**47 CFR CHAPTER I FCC PART 27 Subpart C [Base KDB 935210 D05 v01r02: 3.3 Stations/Repeater]**

Out-of-band rejection

The measurement was performed according to ANSI C63.26

**Final Result**

<b>OP-Mode</b>	<b>Setup</b>	<b>FCC</b>	<b>IC</b>
Frequency Band, Direction			
Band 4/10/66, RF downlink	S01_AA01	Passed	Passed

**47 CFR CHAPTER I FCC PART 27 Subpart C [Base §2.1053, §27.53 Stations/Repeater]**

Field strength of spurious radiation

The measurement was performed according to ANSI C63.26

**Final Result**

**OP-Mode**

Frequency Band, Test Frequency, Direction

Band 4/10/66, high, RF downlink

Band 4/10/66, low, RF downlink

Band 4/10/66, mid, RF downlink

**Setup**

S01\_AA01

S01\_AA01

S01\_AA01

**FCC**

Passed

Passed

Passed

**IC**

Passed

Passed

Passed

N/A: Not applicable

N/P: Not performed

The test case frequency stability was not performed, since the EUT is not equipped with signal processing capabilities.

Report version control			
Version	Release date	Change Description	Version validity
initial	2018-03-19	--	invalid
REV1	2018-05-04	<ul style="list-style-type: none"> <li>Chapter 4.1.3; Table for Composite [MIMO] Power added</li> <li>Chapter 4.7.3; Clarification added, that during the tests both modules were active simultaneously [each module was feed with three input signals.</li> <li>Chapter 4.7.3; Input separated for module 1 &amp; module 2</li> </ul>	invalid
REV2	2018-05-14	<ul style="list-style-type: none"> <li>Corrected values for gain and maximum output power in the EUT description.</li> </ul>	valid



7 layers GmbH, Borsigstr. 11  
40880 Ratingen, Germany  
Phone +49 (0)2102 749 0

  
(responsible for accreditation scope)  
Dipl.-Ing. Marco Kullik

  
(responsible for testing and report)  
B.Sc. Jens Dörwald

## 2 ADMINISTRATIVE DATA

### 2.1 TESTING LABORATORY

Company Name: 7layers GmbH  
Address: Borsigstr. 11  
40880 Ratingen  
Germany

This facility has been fully described in a report submitted to the ISED and accepted under the registration number: Site# 3699A-1.

The test facility is also accredited by the following accreditation organisation:

Laboratory accreditation no: DAKKS D-PL-12140-01-00  
FCC Designation Number: DE0015  
FCC Test Firm Registration: 929146  
Responsible for accreditation scope: Dipl.-Ing. Marco Kullik  
Report Template Version: 2018-01-03

### 2.2 PROJECT DATA

Responsible for testing and report: B.Sc. Jens Dörwald  
Employees who performed the tests: documented internally at 7Layers  
Date of Report: 2018-05-14  
Testing Period: 2017-11-30 to 2018-01-17

### 2.3 APPLICANT DATA

Company Name: Commscope  
Andrew Wireless Systems GmbH  
Address: Industriering 10  
86675 Buchdorf  
Germany  
Contact Person: Mr. Frank Futter

### 2.4 MANUFACTURER DATA

Company Name: please see applicant data

### 3 TEST OBJECT DATA

#### 3.1 GENERAL EUT DESCRIPTION

Kind of Device product description	Cellular Repeater
Product name	ION®-U Low Power Extension Unit for AWS 1700 Band Applications
Type	ION-U System EU L 17EP/17EP-Vac
<b>Declared EUT data by the supplier</b>	
General Product Description	The EUT is an industrial signal booster supporting the following bands: Band 4 / AWS-1 Band 10 / AWS-1+ Band 66 / AWS-3 (partly A RF operation is only supported for the downlink.
Booster Type	Industrial Signal Booster
Voltage Type	AC
Voltage Level	100 V – 240, 50 – 60 Hz
Maximum Output Donor Port [Uplink]	-
Maximum Output Server Port [Downlink]	Band 4/10/66 [Module 1]: 60.7 dBm Band 4/10/66 [Module 2]: 61.0 dBm
Maximum Gain [Uplink]	-
Maximum Gain [Downlink]	Band 4/10/66 [Module 1]: 32.9 dB Band 4/10/66 [Module 2]: 32.9 dB

The main components of the EUT are listed and described in chapter 3.2 EUT Main components.

#### 3.2 EUT MAIN COMPONENTS

Sample Name	Sample Code	Description
aa01	DE1277002aa01	FCC sample
Sample Parameter	Value	
Serial Number	10	
HW Version	7769134-0001	
SW Version	V1.0.0.1	
Comment		

NOTE: The short description is used to simplify the identification of the EUT in this test report.

### 3.3 ANCILLARY EQUIPMENT

For the purposes of this test report, ancillary equipment is defined as equipment which is used in conjunction with the EUT to provide operational and control features to the EUT. It is necessary to configure the system in a typical fashion, as a customer would normally use it. But nevertheless Ancillary Equipment can influence the test results.

Device	Details (Manufacturer, Type Model, OUT Code)	Description
-	-	-

### 3.4 AUXILIARY EQUIPMENT

For the purposes of this test report, auxiliary equipment is defined as equipment which is used temporarily to enable operational and control features especially used for the tests of the EUT which is not used during normal operation or equipment that is used during the tests in combination with the EUT but is not subject of this test report. It is necessary to configure the system in a typical fashion, as a customer would normally use it. But nevertheless Auxiliary Equipment can influence the test results.

Device	Details (Manufacturer, HW, SW, S/N)	Description
-	--	-

### 3.5 EUT SETUPS

This chapter describes the combination of EUTs and equipment used for testing. The rationale for selecting the EUTs, ancillary and auxiliary equipment and interconnecting cables, is to test a representative configuration meeting the requirements of the referenced standards.

Setup	Combination of EUTs	Description and Rationale
S01_AA01	aa01	Setup for all tests

### 3.6 OPERATING MODES

This chapter describes the operating modes of the EUTs used for testing.

#### 3.6.1 TEST CHANNELS

Band	Direction	Lower Frequency Band Edge [MHz]	Upper Frequency Band Edge [MHz]	Center Frequency [MHz]	Port
4/10/66	downlink	2110.00	2180.00	2145.00	Donor [Module 1]
4/10/66	downlink	2110.00	2180.00	2145.00	Donor [Module 2]

#### 3.6.2 AUTOMATIC GAIN CONTROL LEVELS

AGC Levels [Module 1]							
Band	Direction	Signal Type	AGC Start Pin [dBm]	AGC Start Pin -0.3 dB [dBm]	AGC Start Pin +3 dB [dBm]	Frequency [MHz]	Frequency
4/10/66	downlink	Narrowband	-27.6	-27.9	-24.6	2145.0	Center
4/10/66	downlink	Wideband	-27.2	-27.5	-24.2	2145.0	
4/10/66	downlink	Narrowband	-27.8	-28.1	-24.8	2110.0	Low
4/10/66	downlink	Wideband	-27.6	-27.9	-24.6	2110.0	
4/10/66	downlink	Narrowband	-28.2	-28.5	-25.2	2180.0	High
4/10/66	downlink	Wideband	-28.2	-28.5	-25.2	2180.0	
4/10/66	downlink	Narrowband	-28.0	-28.3	-25.0	2138.6	Max. Power
4/10/66	downlink	Wideband	-27.0	-27.3	-24.0	2138.6	

AGC Levels [Module 2]							
Band	Direction	Signal Type	AGC Start Pin [dBm]	AGC Start Pin -0.3 dB [dBm]	AGC Start Pin +3 dB [dBm]	Frequency [MHz]	Frequency
4/10/66	downlink	Narrowband	-27.6	-27.9	-24.6	2145.0	Center
4/10/66	downlink	Wideband	-27.8	-28.1	-24.8	2145.0	
4/10/66	downlink	Narrowband	-28.0	-28.3	-25.0	2110.0	Low
4/10/66	downlink	Wideband	-27.8	-28.1	-24.8	2110.0	
4/10/66	downlink	Narrowband	-28.2	-28.5	-25.2	2180.0	High
4/10/66	downlink	Wideband	-28.0	-28.3	-25.0	2180.0	
4/10/66	downlink	Narrowband	-27.6	-27.9	-24.6	2140.3	Max. Power
4/10/66	downlink	Wideband	-28.0	-28.3	-25.0	2140.3	

## 3.7 PRODUCT LABELLING

### 3.7.1 FCC ID LABEL

Please refer to the documentation of the applicant.

### 3.7.2 LOCATION OF THE LABEL ON THE EUT

Please refer to the documentation of the applicant.

## 4 TEST RESULTS

### 4.1 EFFECTIVE RADIATED POWER, MEAN OUTPUT POWER AND ZONE ENHANCER GAIN

Standard FCC Part 27, §27.50

**The test was performed according to:**  
ANSI C63.26, KDB 935210 D05 v01r02: 3.5

#### 4.1.1 TEST DESCRIPTION

This test case is intended to demonstrate compliance to the signal booster power and gain limits and requirements for industrial signal boosters.

The EUT was connected to the test setup according to the following diagram:

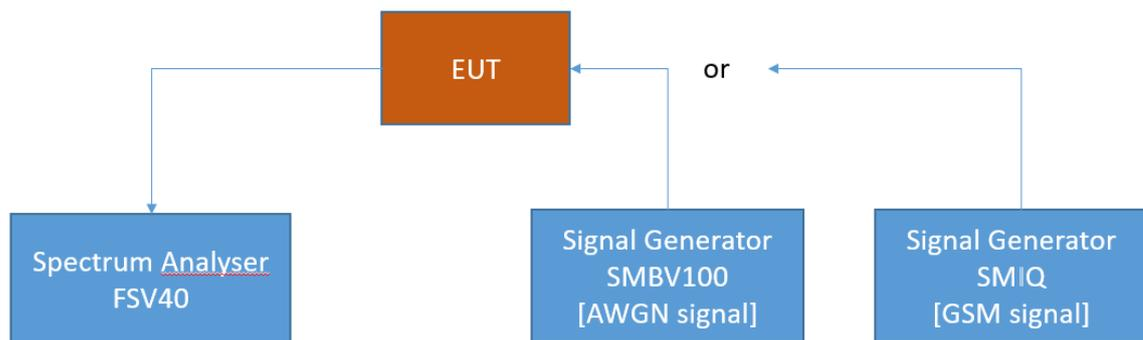

FCC Part 22/24/27/90 Industrial signal booster – Test Setup; RF Output Power / Gain

The attenuation of the measuring and stimulus path are known for each measured frequency and are considered.

The Spectrum Analyzer settings can be directly found in the measurement diagrams.

#### 4.1.2 TEST REQUIREMENTS / LIMITS

##### **Part 27; Miscellaneous Wireless Communication Services**

##### **Subpart C – Technical standards**

##### **§ 27.50**

##### **Band 13:**

(2) Fixed and base stations transmitting a signal in the 746-757 MHz and 776-787 MHz bands with an emission bandwidth of 1 MHz or less must not exceed an ERP of 1000 watts and an antenna height of 305 m HAAT, except that antenna heights greater than 305 m HAAT are



permitted if power levels are reduced below 1000 watts ERP in accordance with Table 1 of this section.

(3) Fixed and base stations located in a county with population density of 100 or fewer persons per square mile, based upon the most recently available population statistics from the Bureau of the Census, and transmitting a signal in the 746-757 MHz and 776-787 MHz bands with an emission bandwidth of 1 MHz or less must not exceed an ERP of 2000 watts and an antenna height of 305 m HAAT, except that antenna heights greater than 305 m HAAT are permitted if power levels are reduced below 2000 watts ERP in accordance with Table 2 of this section.

(4) Fixed and base stations transmitting a signal in the 746-757 MHz and 776-787 MHz bands with an emission bandwidth greater than 1 MHz must not exceed an ERP of 1000 watts/MHz and an antenna height of 305 m HAAT, except that antenna heights greater than 305 m HAAT are permitted if power levels are reduced below 1000 watts/MHz ERP in accordance with Table 3 of this section.

(5) Fixed and base stations located in a county with population density of 100 or fewer persons per square mile, based upon the most recently available population statistics from the Bureau of the Census, and transmitting a signal in the 746-757 MHz and 776-787 MHz bands with an emission bandwidth greater than 1 MHz must not exceed an ERP of 2000 watts/MHz and an antenna height of 305 m HAAT, except that antenna heights greater than 305 m HAAT are permitted if power levels are reduced below 2000 watts/MHz ERP in accordance with Table 4 of this section.

(6) Licensees of fixed or base stations transmitting a signal in the 746-757 MHz and 776-787 MHz bands at an ERP greater than 1000 watts must comply with the provisions set forth in paragraph (b)(8) of this section and §27.55(c).

**Band 12:**

c) The following power and antenna height requirements apply to stations transmitting in the 600 MHz band and the 698-746 MHz band:

(1) Fixed and base stations transmitting a signal with an emission bandwidth of 1 MHz or less must not exceed an effective radiated power (ERP) of 1000 watts and an antenna height of 305 m height above average terrain (HAAT), except that antenna heights greater than 305 m HAAT are permitted if power levels are reduced below 1000 watts ERP in accordance with Table 1 of this section;

(2) Fixed and base stations located in a county with population density of 100 or fewer persons per square mile, based upon the most recently available population statistics from the Bureau of the Census, and transmitting a signal with an emission bandwidth of 1 MHz or less must not exceed an ERP of 2000 watts and an antenna height of 305 m HAAT, except that antenna heights greater than 305 m HAAT are permitted if power levels are reduced below 2000 watts ERP in accordance with Table 2 of this section;

(3) Fixed and base stations transmitting a signal with an emission bandwidth greater than 1 MHz must not exceed an ERP of 1000 watts/MHz and an antenna height of 305 m HAAT, except that antenna heights greater than 305 m HAAT are permitted if power levels are reduced below 1000 watts/MHz ERP in accordance with Table 3 of this section;

(4) Fixed and base stations located in a county with population density of 100 or fewer persons per square mile, based upon the most recently available population statistics from the Bureau of the Census, and transmitting a signal with an emission bandwidth greater than 1 MHz must not exceed an ERP of 2000 watts/MHz and an antenna height of 305 m HAAT, except that antenna heights greater than 305 m HAAT are permitted if power levels are reduced below 2000 watts/MHz ERP in accordance with Table 4 of this section;

**Band 4/10/66:**

d) The following power and antenna height requirements apply to stations transmitting in the 1695-1710 MHz, 1710-1755 MHz, 1755-1780 MHz, 1915-1920 MHz, 1995-2000 MHz, 2000-2020 MHz, 2110-2155 MHz, 2155-2180 MHz and 2180-2200 MHz bands:

(1) The power of each fixed or base station transmitting in the 1995-2000 MHz, 2110-2155 MHz, 2155-2180 MHz or 2180-2200 MHz band and located in any county with population density of 100 or fewer persons per square mile, based upon the most recently available population statistics from the Bureau of the Census, is limited to:

(i) An equivalent isotropically radiated power (EIRP) of 3280 watts when transmitting with an emission bandwidth of 1 MHz or less;

(ii) An EIRP of 3280 watts/MHz when transmitting with an emission bandwidth greater than 1 MHz.

(2) The power of each fixed or base station transmitting in the 1995-2000 MHz, the 2110-2155 MHz 2155-2180 MHz band, or 2180-2200 MHz band and situated in any geographic location other than that described in paragraph (d)(1) of this section is limited to:

(i) An equivalent isotropically radiated power (EIRP) of 1640 watts when transmitting with an emission bandwidth of 1 MHz or less;

(ii) An EIRP of 1640 watts/MHz when transmitting with an emission bandwidth greater than 1 MHz.

(3) A licensee operating a base or fixed station in the 2110-2155 MHz band utilizing a power greater than 1640 watts EIRP and greater than 1640 watts/MHz EIRP must coordinate such operations in advance with all Government and non-Government satellite entities in the 2025-2110 MHz band. A licensee operating a base or fixed station in the 2110-2180 MHz band utilizing power greater than 1640 watts EIRP and greater than 1640 watts/MHz EIRP must be coordinated in advance with the following licensees authorized to operate within 120 kilometers (75 miles) of the base or fixed station operating in this band: All Broadband Radio Service (BRS) licensees authorized under this part in the 2155-2160 MHz band and all advanced wireless services (AWS) licensees authorized to operate on adjacent frequency blocks in the 2110-2180 MHz band.

(4) Fixed, mobile, and portable (hand-held) stations operating in the 1710-1755 MHz band and mobile and portable stations operating in the 1695-1710 MHz and 1755-1780 MHz bands are limited to 1 watt EIRP. Fixed stations operating in the 1710-1755 MHz band are limited to a maximum antenna height of 10 meters above ground. Mobile and portable stations operating in these bands must employ a means for limiting power to the minimum necessary for successful communications.

(5) Equipment employed must be authorized in accordance with the provisions of §24.51. Power measurements for transmissions by stations authorized under this section may be made either in accordance with a Commission-approved average power technique or in compliance with paragraph (d)(6) of this section. In measuring transmissions in this band using an average power technique, the peak-to-average ratio (PAR) of the transmission may not exceed 13 dB.

(6) Peak transmit power must be measured over any interval of continuous transmission using instrumentation calibrated in terms of an rms-equivalent voltage. The measurement results shall be properly adjusted for any instrument limitations, such as detector response times, limited resolution bandwidth capability when compared to the emission bandwidth, sensitivity, etc., so as to obtain a true peak measurement for the emission in question over the full bandwidth of the channel.

## **RSS-130; 4.4 Transmitter Output Power and Equivalent Isotropically Radiated Power (e.i.r.p.)**

The transmitter output power shall be measured in terms of average power.

For base and fixed equipment, refer to SRSP-518 for power limits

### **SRSP-518**

#### **5.1 Radiated Power and Antenna Height Limits**

##### **5.1.1 Fixed and base stations**

5.1.1.1 For fixed and base stations transmitting in accordance with sections 4.1.1 to 4.1.3 within the frequency range 716-756 MHz with a channel bandwidth equal to or less than 1 MHz, the maximum permissible equivalent isotropically radiated power (e.i.r.p.) is 1640 watts with an antenna height above average terrain (HAAT)<sup>Footnote 3</sup> up to 305 metres. The same e.i.r.p. limit also applies to fixed and base stations operating at any frequency in the 700 MHz band in accordance with Section 4.1.4.

5.1.1.2 For fixed and base stations transmitting in accordance with sections 4.1.1 to 4.1.3 within the frequency range 716-756 MHz with a channel bandwidth greater than 1 MHz, the maximum permissible e.i.r.p. is 1640 watts/MHz (i.e. no more than 1640 watts e.i.r.p. in any 1 MHz band segment) with a HAAT up to 305 metres. The same e.i.r.p. limit also applies to fixed and base stations operating at any frequency in the 700 MHz band in accordance with Section 4.1.4.

5.1.1.3 Fixed and base stations located in geographical areas at a distance greater than 26 km from large or medium population centres<sup>Footnote 4</sup> and transmitting in accordance with sections 4.1.1 to 4.1.3 within the frequency range 716-756 MHz, may increase their e.i.r.p. up to a maximum of 3280 watts/MHz (i.e. no more than 3280 watts e.i.r.p. in any 1 MHz band segment), with an antenna HAAT up to 305 metres.

Within 26 km of any large or medium population centre, fixed and base stations may operate at increased e.i.r.p. if more than 50% of the population within a particular sector's coverage<sup>Footnote 5</sup> is located outside these large and medium population centres.

Fixed and base stations with increased e.i.r.p. must not be used to provide coverage to large and medium population centres. However, some incidental coverage of these large and medium population centres by stations with increased e.i.r.p. is permitted.

This provision also applies for fixed and base stations with a channel bandwidth equal to or less than 1 MHz (i.e. e.i.r.p. may be increased up to a maximum of 3280 watts).

5.1.1.4 For all installations with an antenna HAAT in excess of 305 metres, a corresponding reduction in e.i.r.p. according to the following formula shall be applied:

$$\text{EIRP}_{\text{reduction}} = 20 \log_{10}(\text{HAAT}/305) \text{ dB}$$

### **RSS-139; 6.5 Transmitter Output Power**

The equivalent isotropically radiated power (e.i.r.p.) for mobile and portable transmitters shall not exceed one watt. The e.i.r.p. for fixed and base stations in the band 1710-1780 MHz shall not exceed one watt.

Consult SRSP-513 for e.i.r.p. limits on fixed and base stations operating in the band 2110-2180 MHz.

## SRSP-513

### 5.1 Radiated Power and Antenna Height Limits

#### 5.1.1 Fixed and Base Stations

5.1.1.1 For fixed and base stations operating within the frequency range 2110-2180 MHz with a channel bandwidth equal to or less than 1 MHz, the maximum permissible equivalent isotropically radiated power (e.i.r.p.) is 1640 watts with an antenna height above average terrain (HAAT)Footnote 4 up to 300 metres.

5.1.1.2 For fixed and base stations operating within the frequency range 2110-2180 MHz with a channel bandwidth greater than 1 MHz, the maximum permissible e.i.r.p. is 1640 watts/MHz e.i.r.p. (i.e. no more than 1640 watts e.i.r.p. in any 1 MHz band segment) with an antenna height above average terrain (HAAT) up to 300 metres.

5.1.1.3 Fixed and base stations located in geographic areas at a distance greater than 26 km from large or medium population centres,Footnote 5 and transmitting within the frequency range 2110-2180 MHz, may increase their e.i.r.p. up to a maximum of 3280 watts/MHz (i.e. no more than 3280 watts e.i.r.p. in any 1 MHz band segment), with an antenna HAAT up to 300 metres.

Within 26 km of any large or medium population centre, fixed and base stations may operate at increased e.i.r.p. if more than 50% of the population within a particular sector's coverageFootnote 6 is located outside these large and medium population centres.

Fixed and base stations with increased e.i.r.p. must not be used to provide coverage to large and medium population centres. However, some incidental coverage of these large and medium population centres by stations with increased e.i.r.p. is permitted.

This provision also applies for fixed and base stations with a channel bandwidth equal to or less than 1 MHz (i.e. the e.i.r.p. may be increased up to a maximum of 3280 watts).

5.1.1.4 Fixed and base station antenna heights above average terrain may exceed 300 metres with a reduction in e.i.r.p. The maximum permissible e.i.r.p. for installations with antenna HAAT in excess of 300 metres is given in the following table:

Table 2 — Reduction to Maximum Allowable E.I.R.P. for HAAT > 300 m

HAAT (in metres)	Maximum e.i.r.p. (watts or watts per MHz <sup>a</sup> )
HAAT ≤ 300	1640 (or 3280 <sup>b</sup> )
300 < HAAT ≤ 500	1070
500 < HAAT ≤ 1000	490
1000 < HAAT ≤ 1500	270
1500 < HAAT ≤ 2000	160

Notes:

a Depending on the channel bandwidth: watts if less than 1 MHz bandwidth or else watts per MHz.

b If Section 5.1.1.3 applies.

5.1.1.5 Fixed or base stations transmitting in the lower sub-band (1710-1780 MHz) shall comply with the power limits set forth in Section 5.1.2.

#### 4.1.3 TEST PROTOCOL

Band 4/10/66, downlink [Module 1]							
Signal Type	Input Power	Frequency [MHz]	Input Power [dBm]	Maximum Average Output Power [dBm]	Limit Average Output Power [dBm]	Margin to Limit [dB]	Gain [dB]
Wideband	0.3 dB < AGC	2138.600	-27.3	32.8	60.0	27.2	60.1
Wideband	3 dB > AGC	2138.600	-24.0	32.6	60.0	27.4	56.6
Narrowband	0.3 dB < AGC	2138.600	-27.9	32.8	60.0	27.3	60.7
Narrowband	3 dB > AGC	2138.600	-24.6	32.9	60.0	27.1	57.5

Band 4/10/66, downlink [Module 2]							
Signal Type	Input Power	Frequency [MHz]	Input Power [dBm]	Maximum Average Output Power [dBm]	Limit Average Output Power [dBm]	Margin to Limit [dB]	Gain [dB]
Wideband	0.3 dB < AGC	2140.300	-28.3	32.6	60.0	27.4	61.0
Wideband	3 dB > AGC	2140.300	-25.0	32.7	60.0	27.3	57.7
Narrowband	0.3 dB < AGC	2140.300	-27.9	33.1	60.0	26.9	61.0
Narrowband	3 dB > AGC	2140.300	-24.6	32.9	60.0	27.1	57.5

Band 4/10/66, downlink, Composite Power Module 1 & Module 2 [MIMO]										
Signal Type	Input Power	Freq. Module 1 [MHz]	Freq. Module 2 [MHz]	Input Power Module 1 [dBm]	Input Power Module 2 [dBm]	Maximum Average Output Power Module 1 [dBm]	Maximum Average Output Power Module 2 [dBm]	Maximum Average Composite Output Power [dBm]	Limit Average Output Power [dBm]	Margin to Limit [dB]
WB	0.5 dB < AGC	2138.6	2140.3	-28.3	-28.3	32.8	32.6	35.7	60.0	24.3
WB	3 dB > AGC	2138.6	2140.3	-25.0	-25.0	32.6	32.7	35.7	60.0	24.3
NB	0.5 dB < AGC	2138.6	2140.3	-27.9	-27.9	32.8	33.1	35.9	60.0	24.1
NB	3 dB > AGC	2138.6	2140.3	-24.6	-24.6	32.9	32.9	35.9	60.0	24.1

Remark: Please see next sub-clause for the measurement plot.

#### 4.1.4 MEASUREMENT PLOT (SHOWING THE HIGHEST VALUE, "WORST CASE")

##### MODULE 1:

Frequency Band = Band 4/10/66, Direction = RF downlink, Input Power = 3 dB > AGC, Signal Type = Narrowband (S01\_AA01)

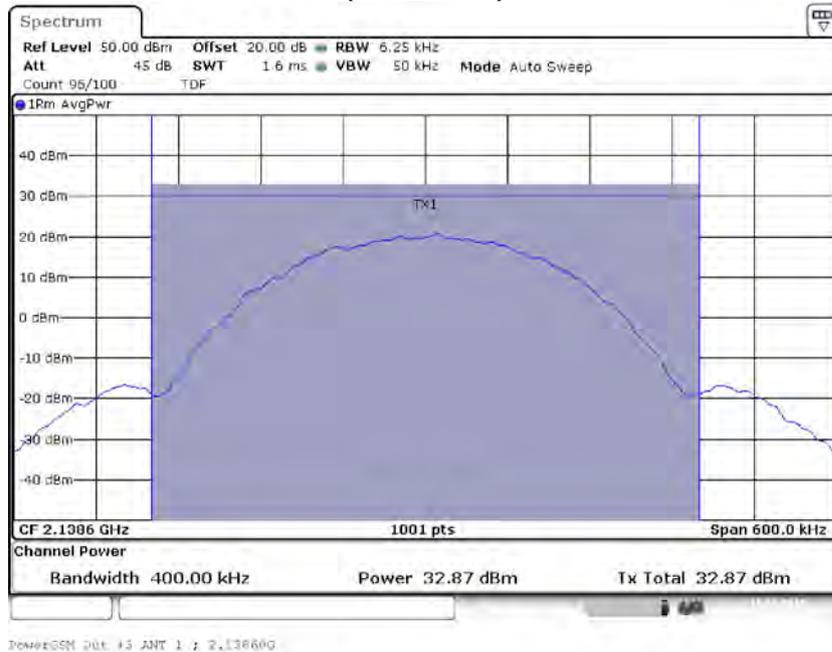

Frequency Band = Band 4/10/66, Direction = RF downlink, Input Power = 3 dB > AGC, Signal Type = Wideband (S01\_AA01)

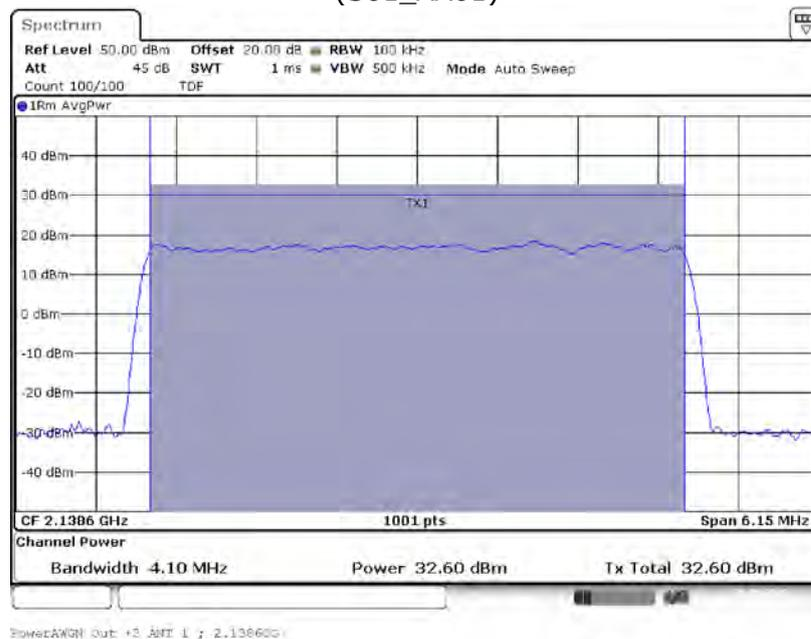

Frequency Band = Band 4/10/66, Direction = RF downlink, Input Power = 0.3 dB < AGC,  
Signal Type = Narrowband  
(S01\_AA01)

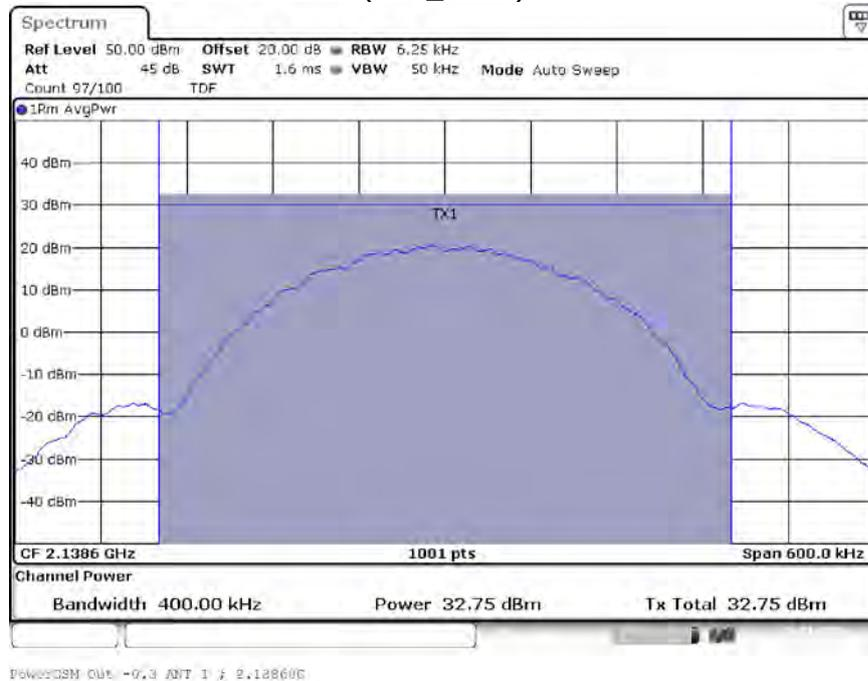

Frequency Band = Band 4/10/66, Direction = RF downlink, Input Power = 0.3 dB < AGC,  
Signal Type = Wideband  
(S01\_AA01)

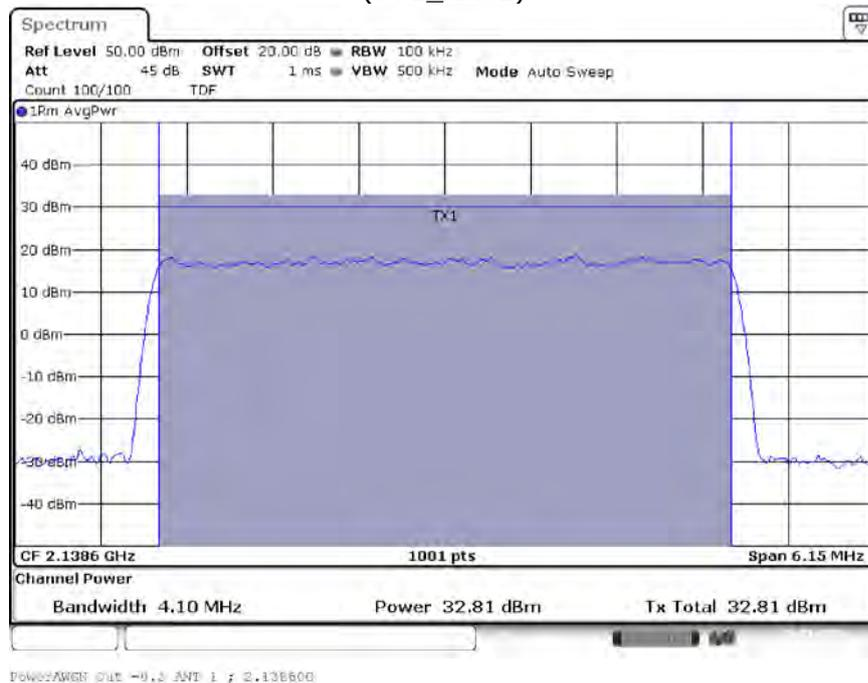

**MODULE 2:**

Frequency Band = Band 4/10/66, Direction = RF downlink, Input Power = 3 dB > AGC, Signal Type = Narrowband (S01\_AA01)

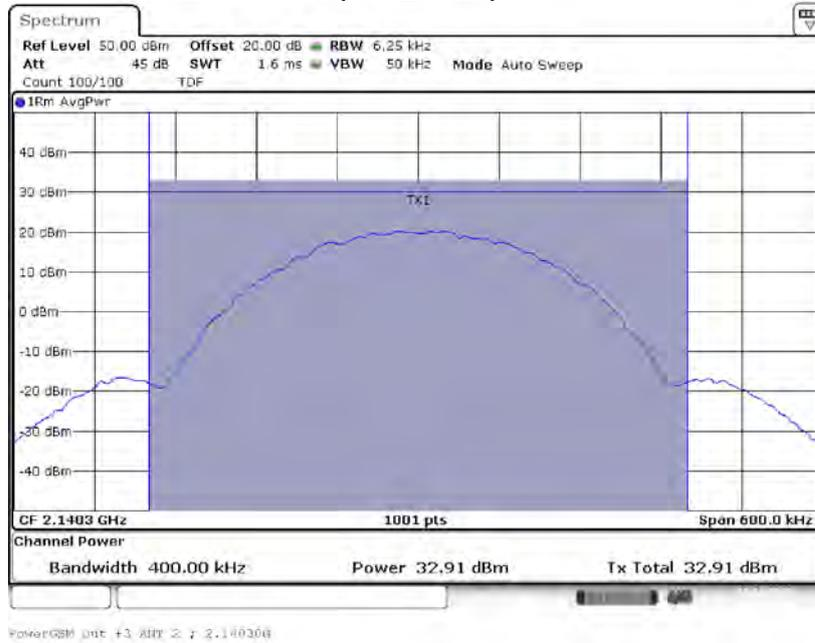

Frequency Band = Band 4/10/66, Direction = RF downlink, Input Power = 3 dB > AGC, Signal Type = Wideband (S01\_AA01)

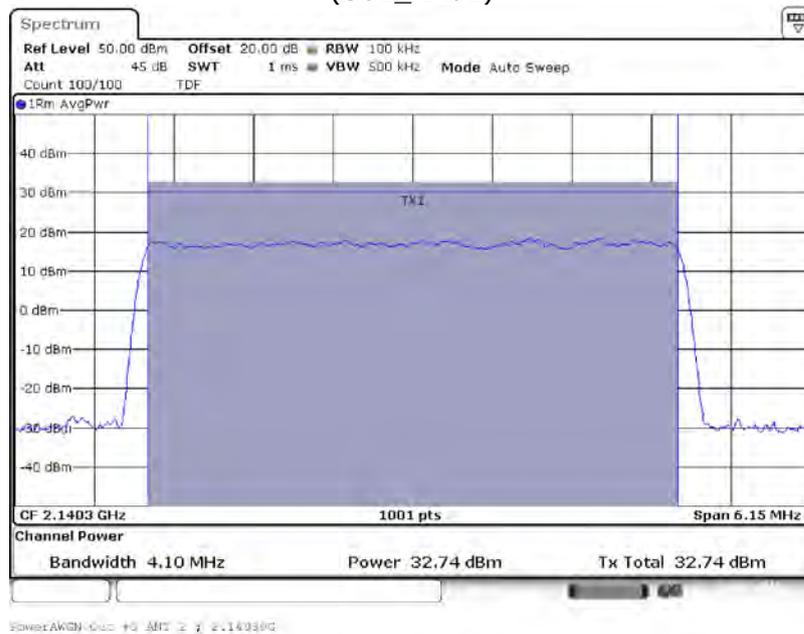



Frequency Band = Band 4/10/66, Direction = RF downlink, Input Power = 0.3 dB < AGC,  
Signal Type = Narrowband  
(S01\_AA01)

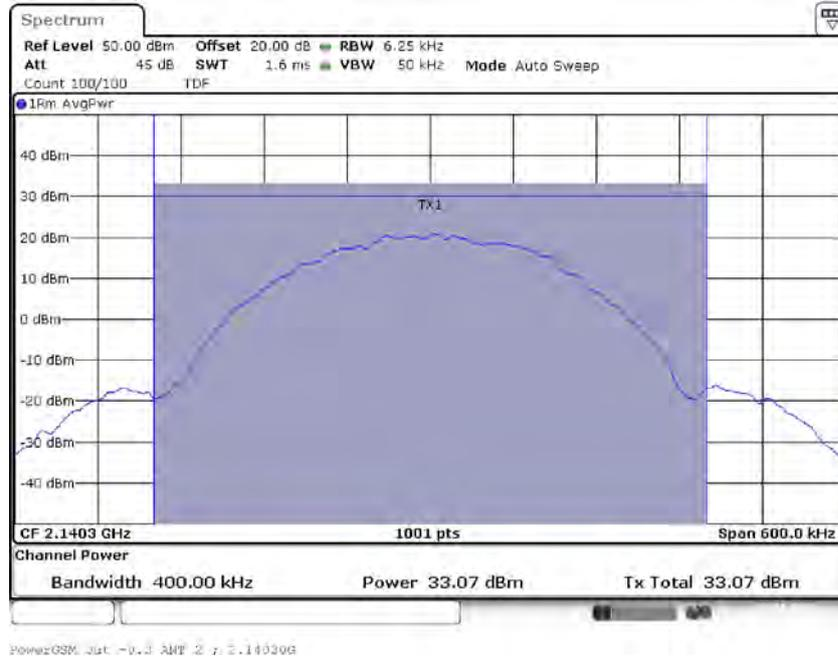

Frequency Band = Band 4/10/66, Direction = RF downlink, Input Power = 0.3 dB < AGC,  
Signal Type = Wideband  
(S01\_AA01)

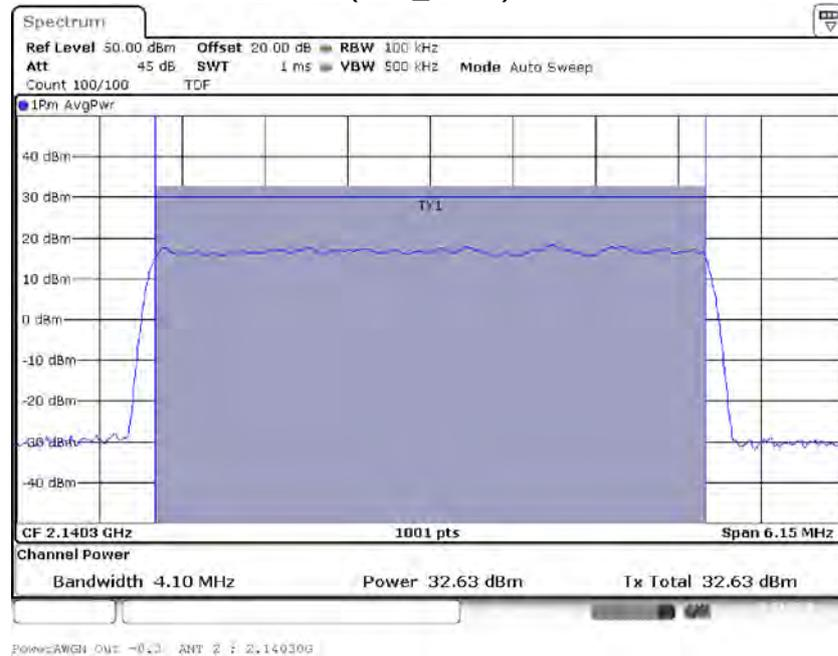

#### 4.1.5 TEST EQUIPMENT USED

- FCC Conducted Base Station / Repeater

## 4.2 PEAK TO AVERAGE RATIO

Standard FCC Part 27, §27.50

The test was performed according to:  
ANSI C63.26

### 4.2.1 TEST DESCRIPTION

This test case is intended to demonstrate compliance to the signal booster power and gain limits and requirements for industrial signal boosters.

The EUT was connected to the test setup according to the following diagram:

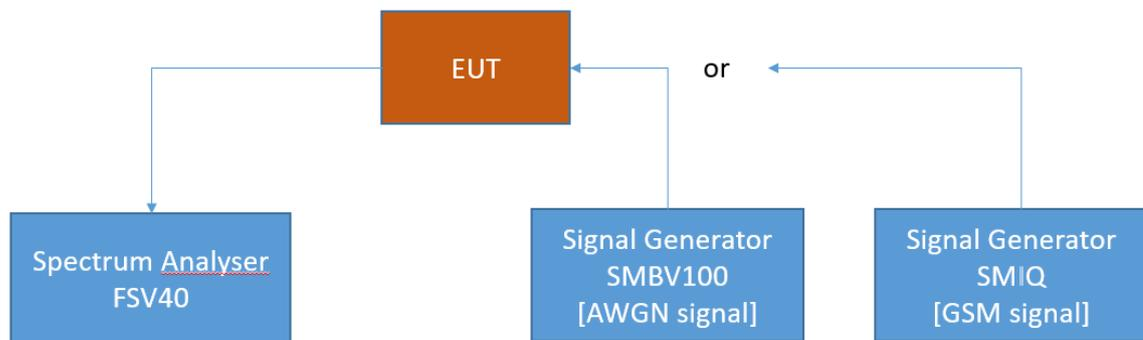

FCC Part 22/24/27/90 Industrial signal booster – Test Setup; RF Output Power / Gain

The attenuation of the measuring and stimulus path are known for each measured frequency and are considered.

The Spectrum Analyzer settings can be directly found in the measurement diagrams.

### 4.2.2 TEST REQUIREMENTS / LIMITS

#### Part 27; Miscellaneous Wireless Communication Services

##### Subpart C – Technical standards

##### § 27.50

For the bands 4, 12, 13 exist no FCC peak-to-average power ratio (PAPR) limit.

#### RSS-130; 4.4 Transmitter Output Power and Equivalent Isotropically Radiated Power (e.i.r.p.)

In addition, the peak-to-average power ratio (PAPR) of the transmitter shall not exceed 13 dB for more than 0.1% of the time and shall use a signal corresponding to the highest PAPR during periods of continuous transmission.

### RSS-139; 6.5 Transmitter Output Power

In addition, the peak to average power ratio (PAPR) of the equipment shall not exceed 13 dB for more than 0.1% of the time, using a signal that corresponds to the highest PAPR during periods of continuous transmission.

#### 4.2.3 TEST PROTOCOL

Band 4/10/66, downlink [Module 1]						
Signal Type	Input Power	Frequency [MHz]	Input Power [dBm]	PAPR [dB]	Limit PAPR [dB]	Margin to Limit [dB]
Wideband	0.3 dB < AGC	2138.600	-27.5	8.7	13.0	4.3
Wideband	3 dB > AGC	2138.600	-24.6	8.7	13.0	4.3
Narrowband	0.3 dB < AGC	2138.600	-27.9	0.1	13.0	12.9
Narrowband	3 dB > AGC	2138.600	-24.6	0.2	13.0	12.8

Band 4/10/66, downlink [Module 2]						
Signal Type	Input Power	Frequency [MHz]	Input Power [dBm]	PAPR [dB]	Limit PAPR [dB]	Margin to Limit [dB]
Wideband	0.3 dB < AGC	2140.300	-28.1	8.8	13.0	4.3
Wideband	3 dB > AGC	2140.300	-24.8	8.7	13.0	4.3
Narrowband	0.3 dB < AGC	2140.300	-27.9	0.1	13.0	12.9
Narrowband	3 dB > AGC	2140.300	-24.6	0.2	13.0	12.8

Remark: Please see next sub-clause for the measurement plot.

#### 4.2.4 MEASUREMENT PLOT (SHOWING THE HIGHEST VALUE, "WORST CASE")

##### MODULE 1:

Frequency Band = Band 4/10/66, Direction = RF downlink, Input Power = 3 dB > AGC, Signal Type = Narrowband (S01\_AA01)

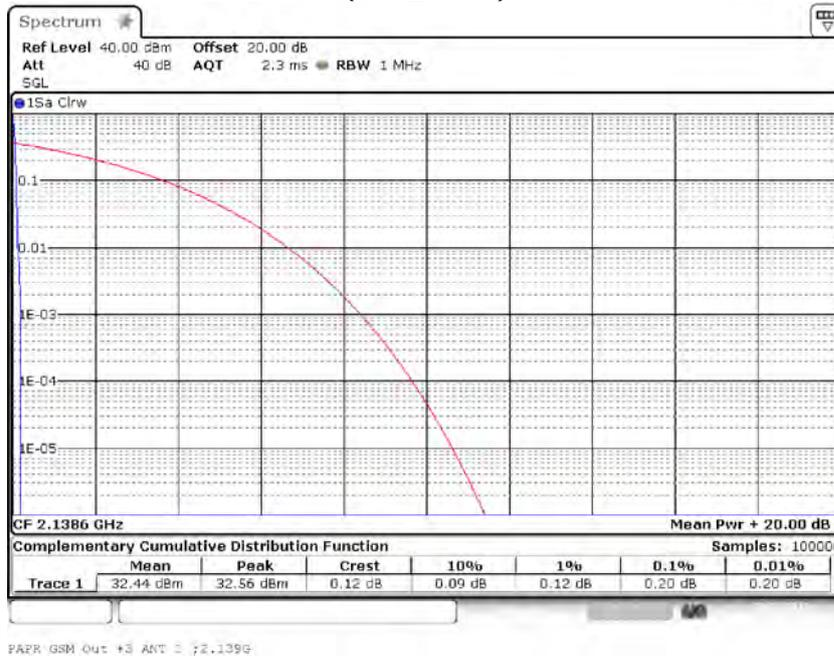

Frequency Band = Band 4/10/66, Direction = RF downlink, , Input Power = 3 dB > AGC, Signal Type = Wideband (S01\_AA01)

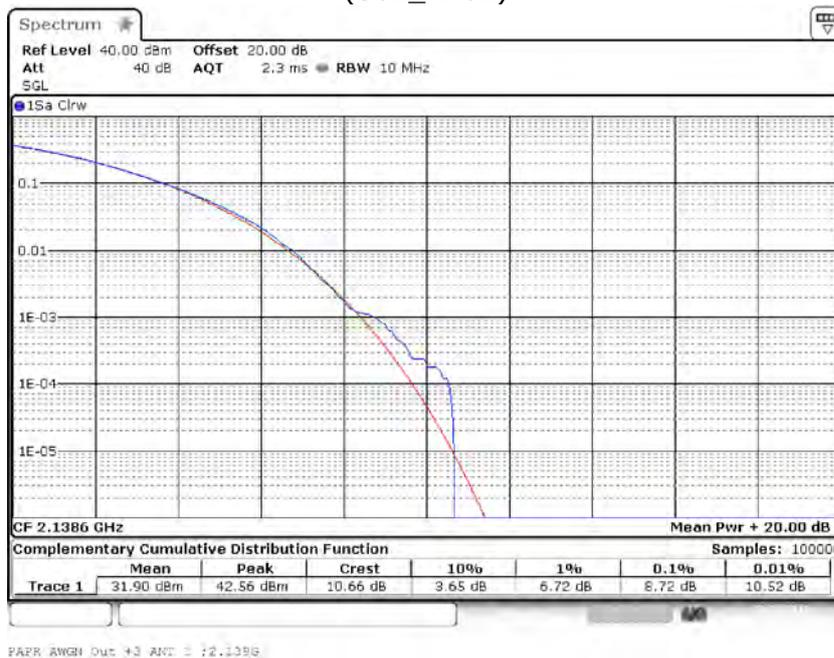

Frequency Band = Band 4/10/66, Direction = RF downlink, Input Power = 0.3 dB < AGC,  
Signal Type = Narrowband  
(S01\_AA01)

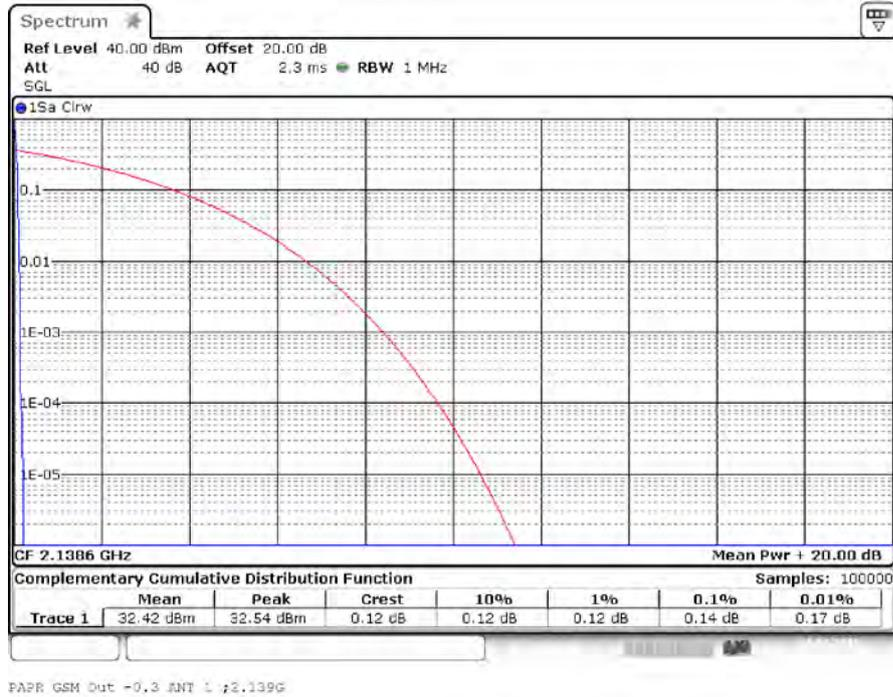

Frequency Band = Band 4/10/66, Direction = RF downlink, Input Power = 0.3 dB < AGC,  
Signal Type = Wideband  
(S01\_AA01)



**MODULE 2:**

Frequency Band = Band 4/10/66, Direction = RF downlink, Input Power = 3 dB > AGC, Signal Type = Narrowband (S01\_AA01)

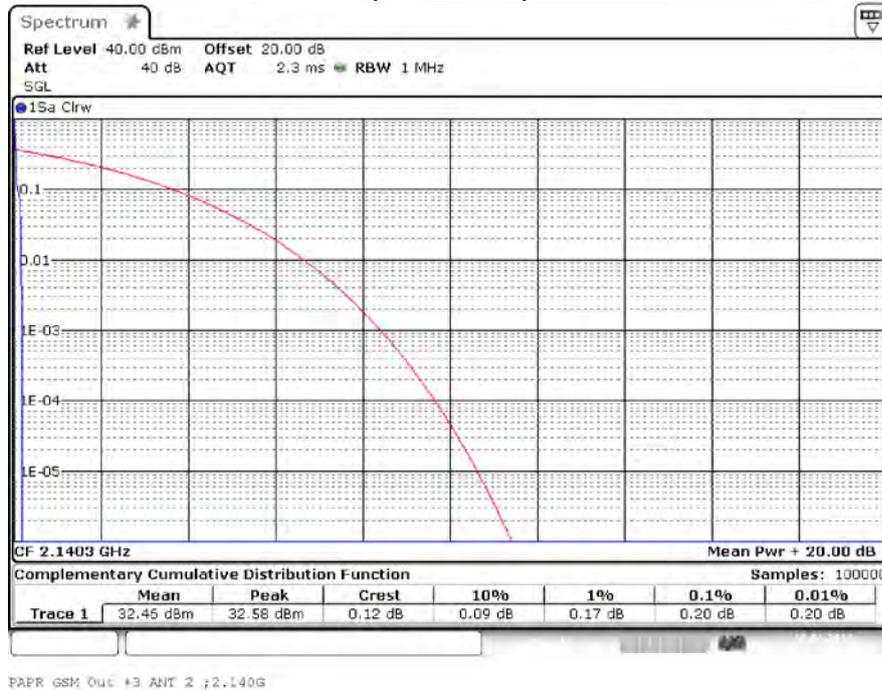

FAPR GSM 04c +3 ANT 2 ; 2.140G

Frequency Band = Band 4/10/66, Direction = RF downlink, , Input Power = 3 dB > AGC, Signal Type = Wideband (S01\_AA01)

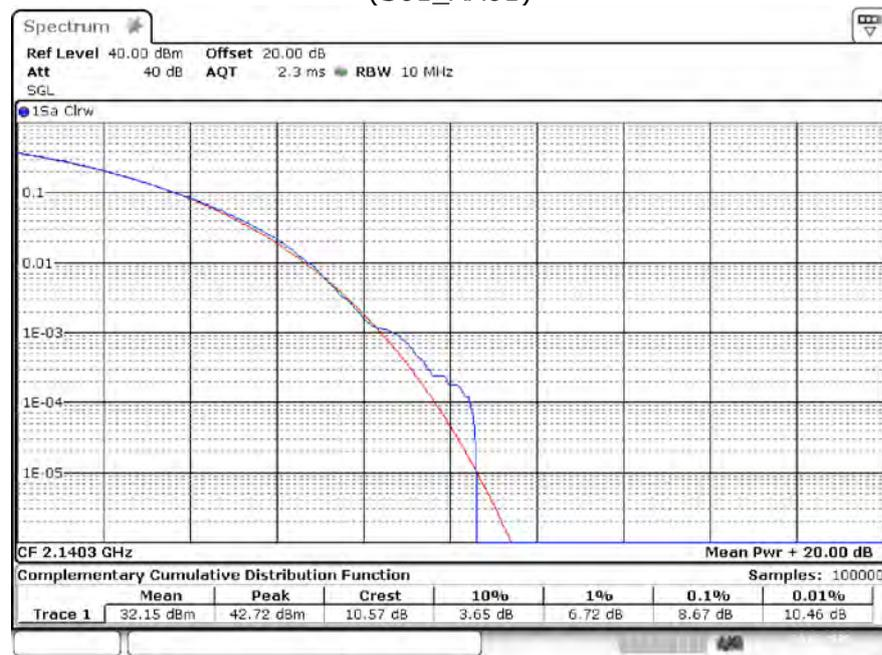

FAPR AWGN DUE 13 ANT 2 ; 2.140G

Frequency Band = Band 4/10/66, Direction = RF downlink, Input Power = 0.3 dB < AGC,  
Signal Type = Narrowband  
(S01\_AA01)

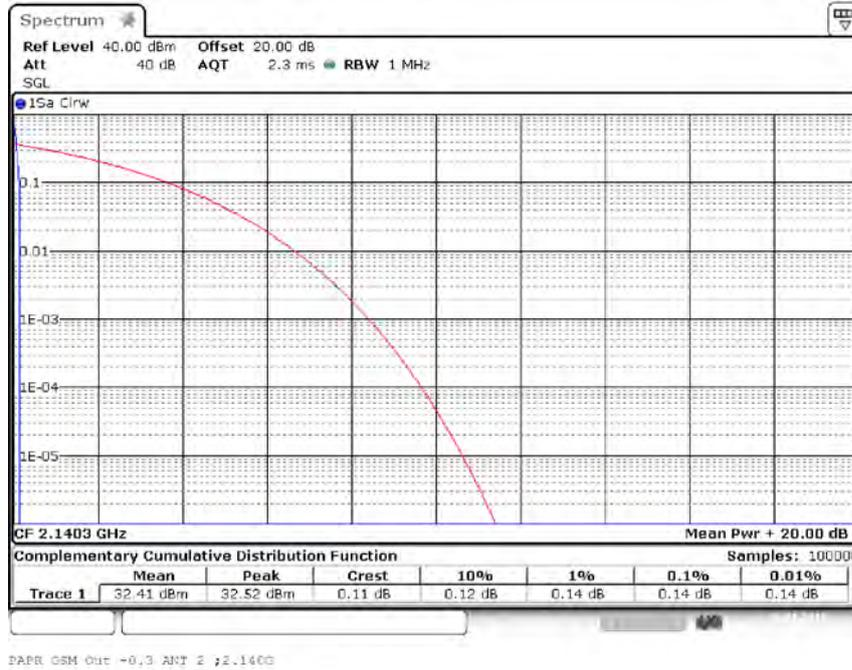

Frequency Band = Band 4/10/66, Direction = RF downlink, Input Power = 0.3 dB < AGC,  
Signal Type = Wideband  
(S01\_AA01)

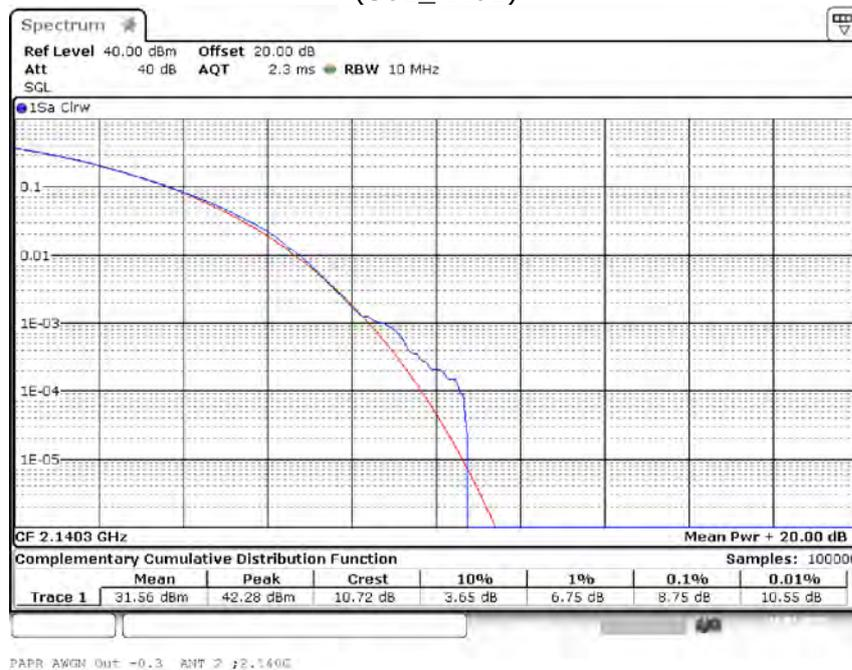

#### 4.2.5 TEST EQUIPMENT USED

- FCC Conducted Base Station / Repeater

### 4.3 OCCUPIED BANDWIDTH / INPUT-VERSUS-OUTPUT SPECTRUM

Standard FCC Part 2.1049; Occupied Bandwidth

**The test was performed according to:**  
ANSI C63.26, KDB 935210 D05 v01r02: 3.4

#### 4.3.1 TEST DESCRIPTION

This test case is intended to demonstrate compliance to the applicable conducted spurious emission limits per FCC §2.1049, RSS-GEN 6.4 and RSS-131-5.2.2

The EUT was connected to the test setups according to the following diagram:

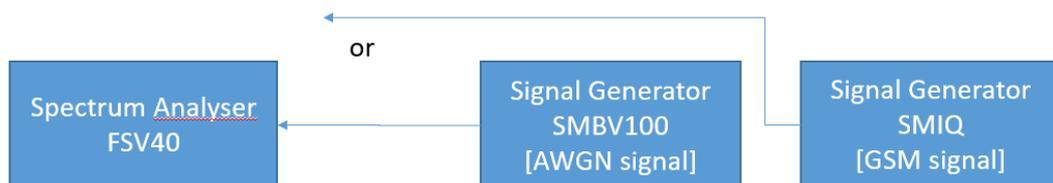

FCC Part 22/24/27/90; Industrial Signal Booster  
Test Setup step 1: Measuring characteristics of test signals

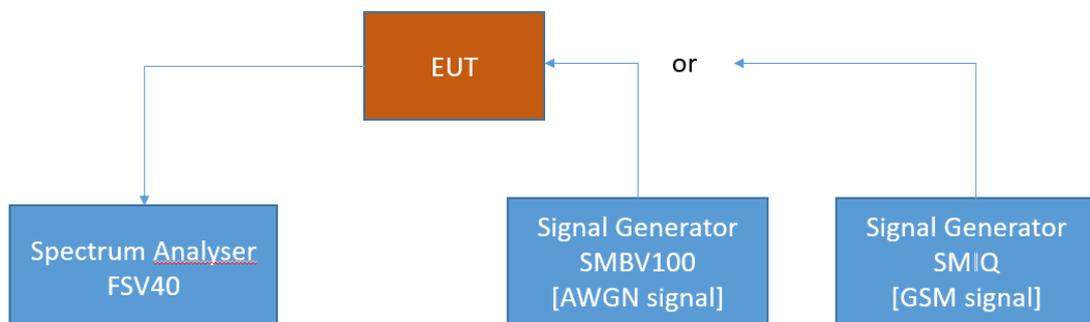

FCC Part 22/24/27/90; Industrial Signal Booster  
Test Setup step 2; Occupied Bandwidth/Input-versus-output spectrum

The attenuation of the measuring and stimulus path are known for each measured frequency and are considered.

The Spectrum Analyzer settings can be directly found in the measurement diagrams.

#### 4.3.2 TEST REQUIREMENTS / LIMITS

##### **FCC Part 2.1049; Occupied Bandwidth:**

The occupied bandwidth, that is the frequency bandwidth such that, below its lower and above its upper frequency limits, the mean powers radiated are each equal to 0.3 percent of the total mean power radiated by a given emission shall be measured under the following conditions as applicable:



(h) Transmitters employing digital modulation techniques—when modulated by an input signal such that its amplitude and symbol rate represent the maximum rated conditions under which the equipment will be operated. The signal shall be applied through any filter networks, pseudo-random generators or other devices required in normal service. Additionally, the occupied bandwidth shall be shown for operation with any devices used for modifying the spectrum when such devices are optional at the discretion of the user.

(i) Transmitters designed for other types of modulation—when modulated by an appropriate signal of sufficient amplitude to be representative of the type of service in which used. A description of the input signal should be supplied.

### **RSS-GEN; 6.6 Occupied Bandwidth**

The emission bandwidth ( $\times$ dB) is defined as the frequency range between two points, one above and one below the carrier frequency, at which the spectral density of the emission is attenuated  $\times$  dB below the maximum in-band spectral density of the modulated signal. Spectral density (power per unit bandwidth) is to be measured with a detector of resolution bandwidth in the range of 1% to 5% of the anticipated emission bandwidth, and a video bandwidth at least  $3\times$  the resolution bandwidth.

When the occupied bandwidth limit is not stated in the applicable RSS or reference measurement method, the transmitted signal bandwidth shall be reported as the 99% emission bandwidth, as calculated or measured.

The transmitter shall be operated at its maximum carrier power measured under normal test conditions.

The span of the analyzer shall be set to capture all products of the modulation process, including the emission skirts.

The resolution bandwidth (RBW) shall be in the range of 1% to 5% of the occupied bandwidth (OBW) and video bandwidth (VBW) shall be approximately  $3\times$ RBW.

Note: Video averaging is not permitted.

A peak, or peak hold, may be used in place of the sampling detector as this may produce a wider bandwidth than the actual bandwidth (worst-case measurement). Use of a peak hold may be necessary to determine the occupied bandwidth if the device is not transmitting continuously.

The trace data points are recovered and are directly summed in linear power level terms. The recovered amplitude data points, beginning at the lowest frequency, are placed in a running sum until 0.3% of the total is reached and that frequency recorded. The process is repeated for the highest frequency data points (starting at the highest frequency, at the right side of the span, and going down in frequency). This frequency is then recorded. The difference between the two recorded frequencies is the 99% occupied bandwidth.

### RSS-131; 5.2.2 Input-versus-output spectrum

The spectral growth of the 26 dB bandwidth of the output signal shall be less than 5% of the input signal spectrum.

#### 4.3.3 TEST PROTOCOL

Band 4/10/66, downlink [Module 1]							
Signal Type	Input Power	Signal Frequency [MHz]	Occupied Bandwidth SG [kHz]	Occupied Bandwidth Booster [kHz]	Delta Occupied Bandwidth [kHz]	Limit Delta Occupied Bandwidth [kHz]	Margin to Limit [kHz]
Wideband	0.3 dB < AGC	2145.00	4335.3	4326.7	8.6	205.0	196.4
Wideband	3 dB > AGC	2145.00	4330.4	4326.7	3.7	205.0	201.3
Narrowband	0.3 dB < AGC	2145.00	314.7	313.8	1.0	10.0	9.0
Narrowband	3 dB > AGC	2145.00	309.8	315.5	5.6	10.0	4.4

Band 4/10/66, downlink [Module 2]							
Signal Type	Input Power	Signal Frequency [MHz]	Occupied Bandwidth SG [kHz]	Occupied Bandwidth Booster [kHz]	Delta Occupied Bandwidth [kHz]	Limit Delta Occupied Bandwidth [kHz]	Margin to Limit [kHz]
Wideband	0.3 dB < AGC	2145.00	4332.9	4326.7	6.2	205.0	198.8
Wideband	3 dB > AGC	2145.00	4331.6	4326.7	4.9	205.0	200.1
Narrowband	0.3 dB < AGC	2145.00	314.7	315.8	1.1	10.0	8.9
Narrowband	3 dB > AGC	2145.00	309.8	315.1	5.3	10.0	4.7

Remark: Please see next sub-clause for the measurement plot.

#### 4.3.4 MEASUREMENT PLOT (SHOWING THE HIGHEST VALUE, "WORST CASE")

##### MODULE 1:

Frequency Band = Band 4/10/66, Direction = RF downlink, Input Power = 0.3 dB < AGC,  
Signal Type = Narrowband  
(S01\_AA01)

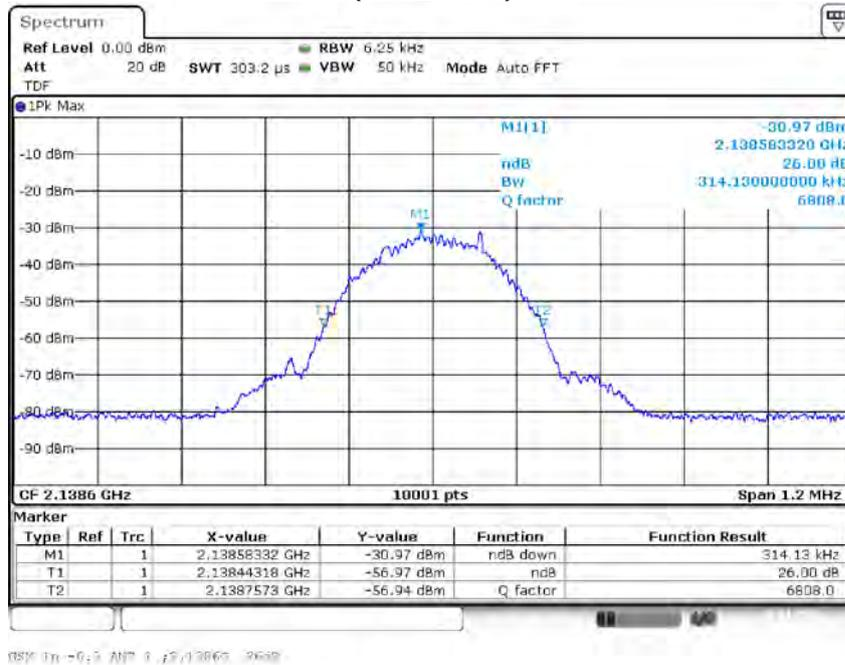

Input Signal

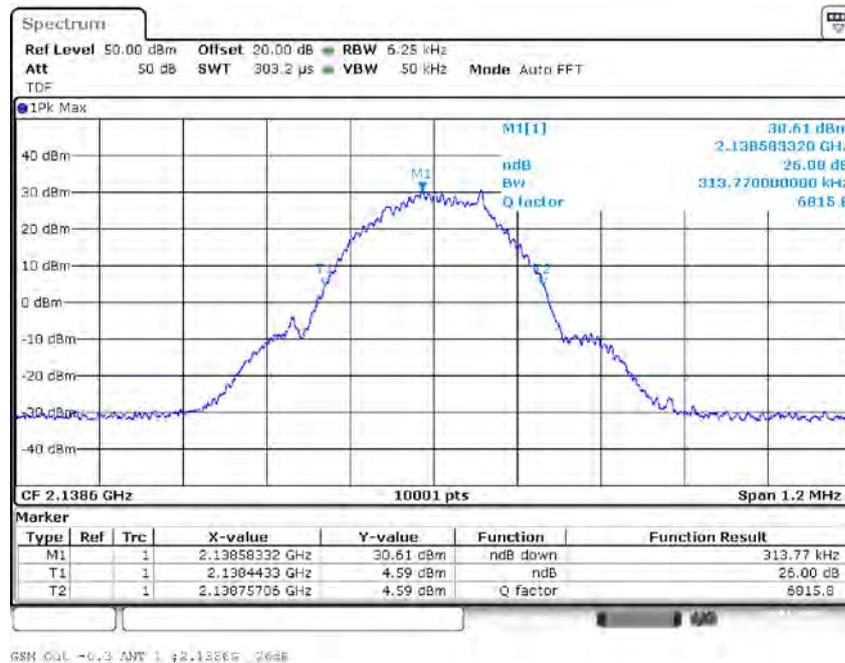

Output Signal

Frequency Band = Band 4/10/66, Direction = RF downlink, Input Power = 0.3 dB < AGC,  
Signal Type = Wideband  
(S01\_AA01)

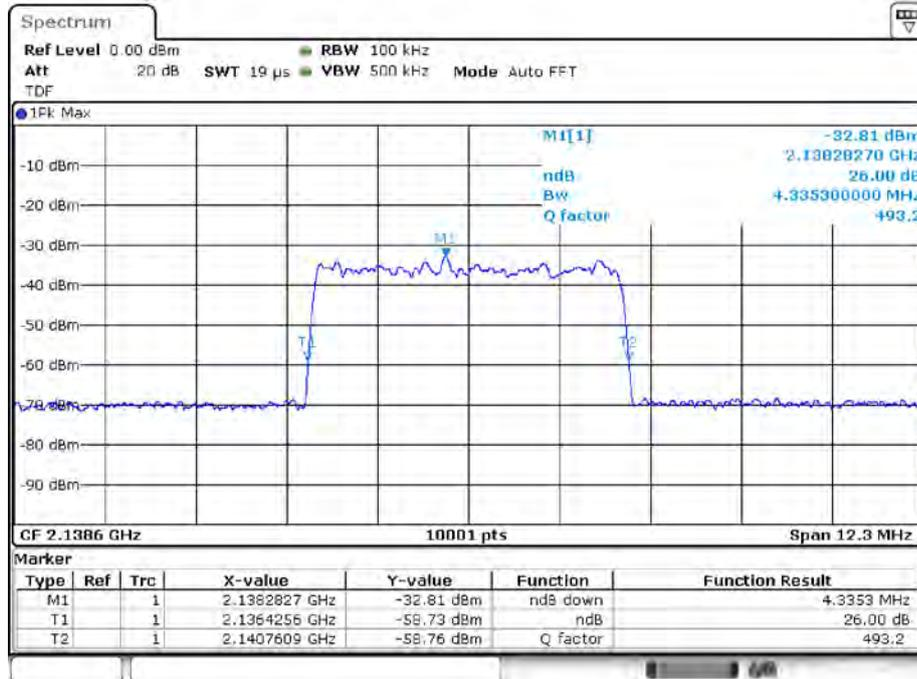

Input Signal

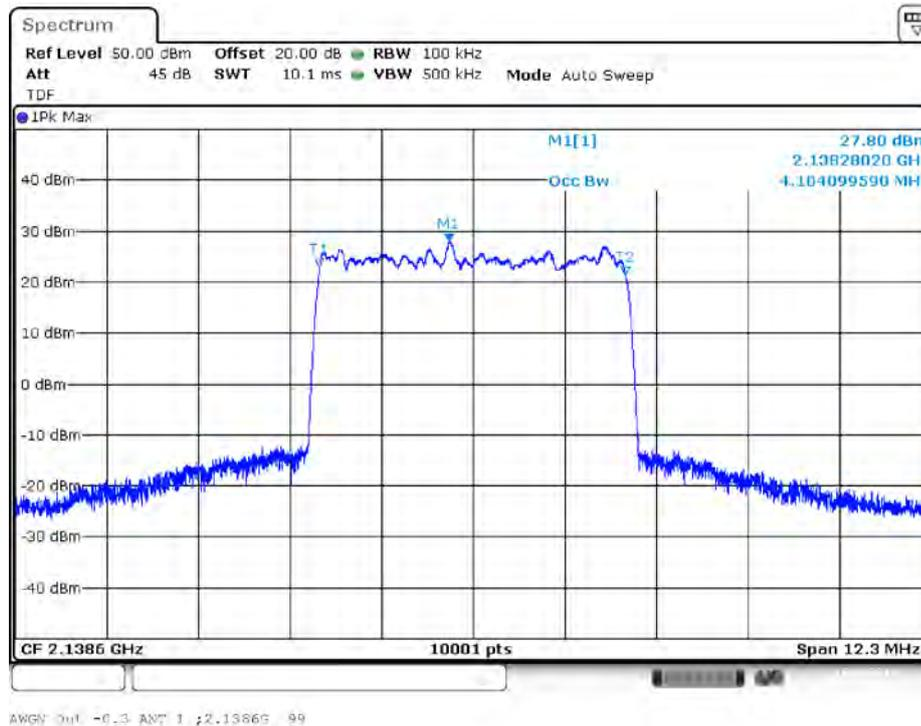

Output Signal

Frequency Band = Band 4/10/66, Direction = RF downlink, Input Power = 3 dB > AGC, Signal Type = Narrowband (S01\_AA01)

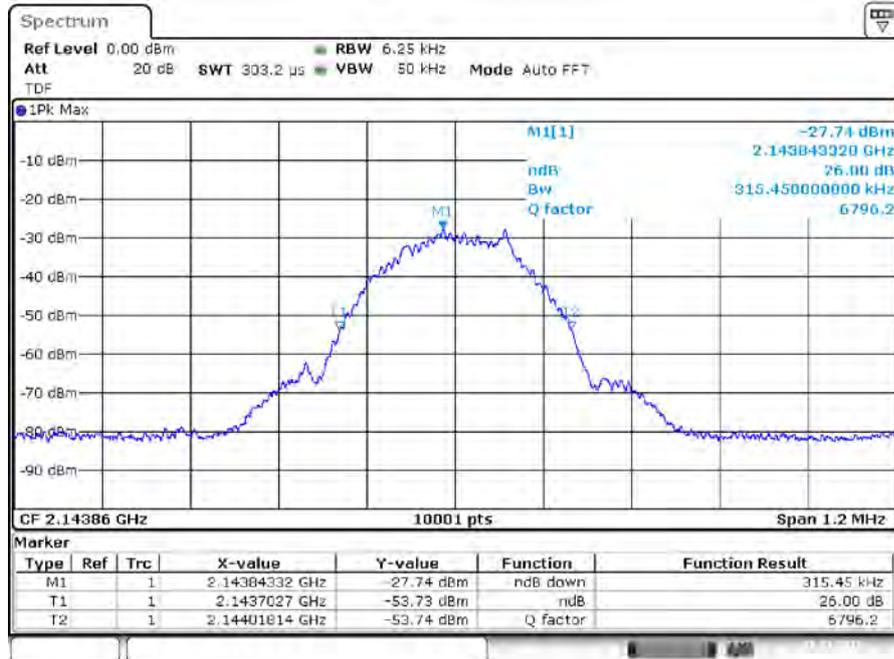

GSM In #2 ANT 1 ; 2.14396\_26dB

Input Signal

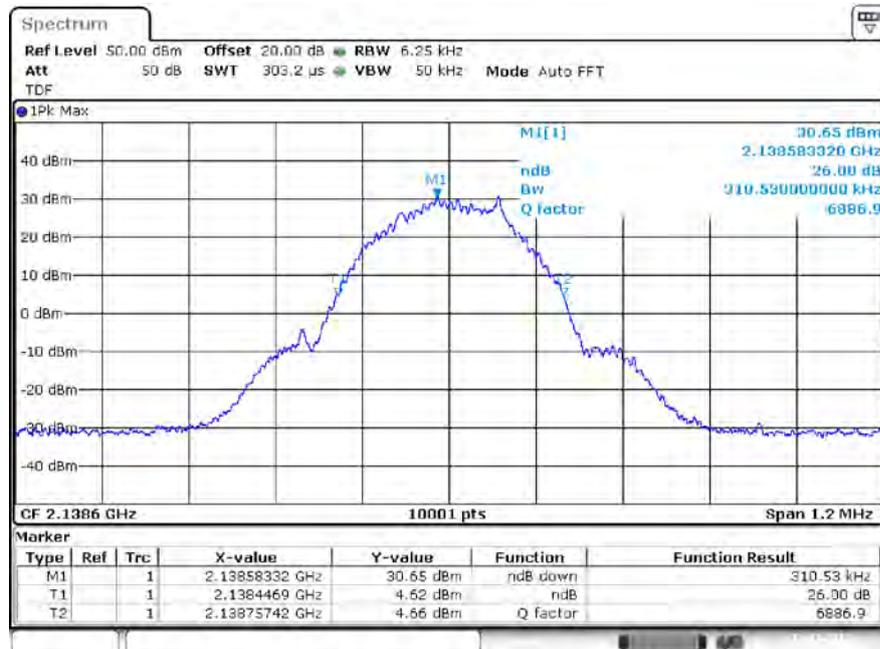

GSM out #3 ANT 1 ; 2.13869\_26dB

Output Signal

Frequency Band = Band 4/10/66, Direction = RF downlink, Input Power = 3 dB > AGC, Signal Type = Wideband (S01\_AA01)



Input Signal

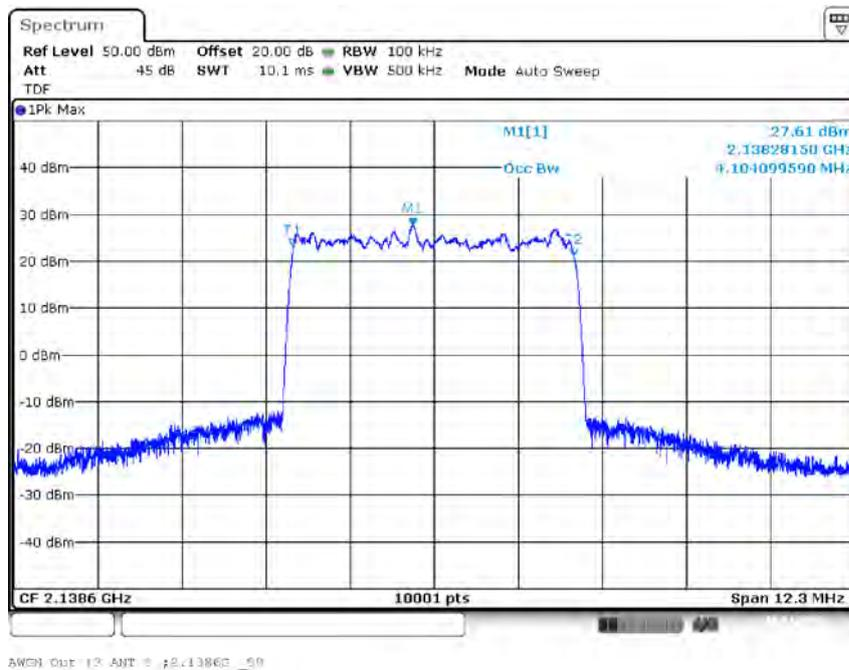

Output Signal

**MODULE 2:**

Frequency Band = Band 4/10/66, Direction = RF downlink, Input Power = 0.3 dB < AGC,  
Signal Type = Narrowband  
(S01\_AA01)

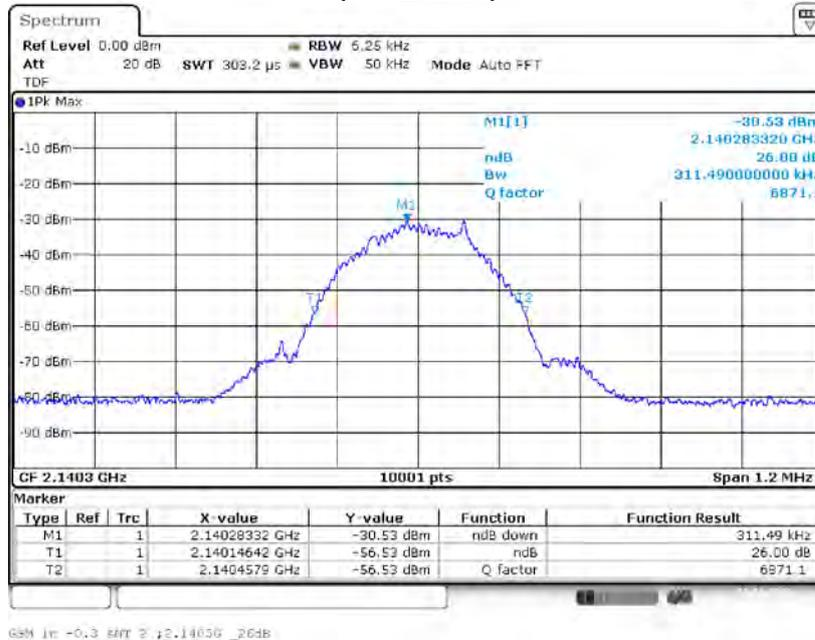

Input Signal



Output Signal

Frequency Band = Band 4/10/66, Direction = RF downlink, Input Power = 0.3 dB < AGC,  
Signal Type = Wideband  
(S01\_AA01)

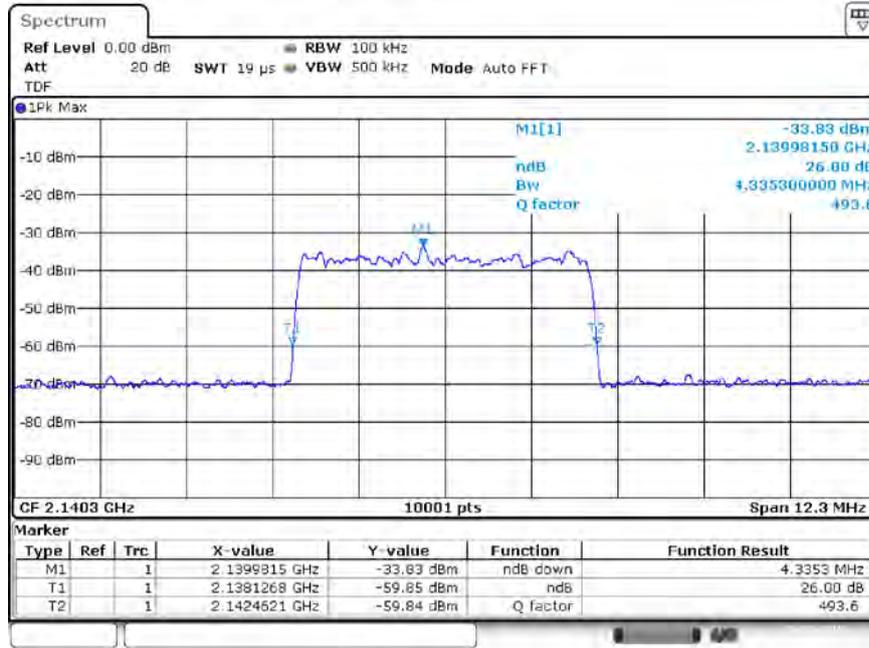

AWGN In -0.3 ANT 2 #2.1403G \_26dB

Input Signal

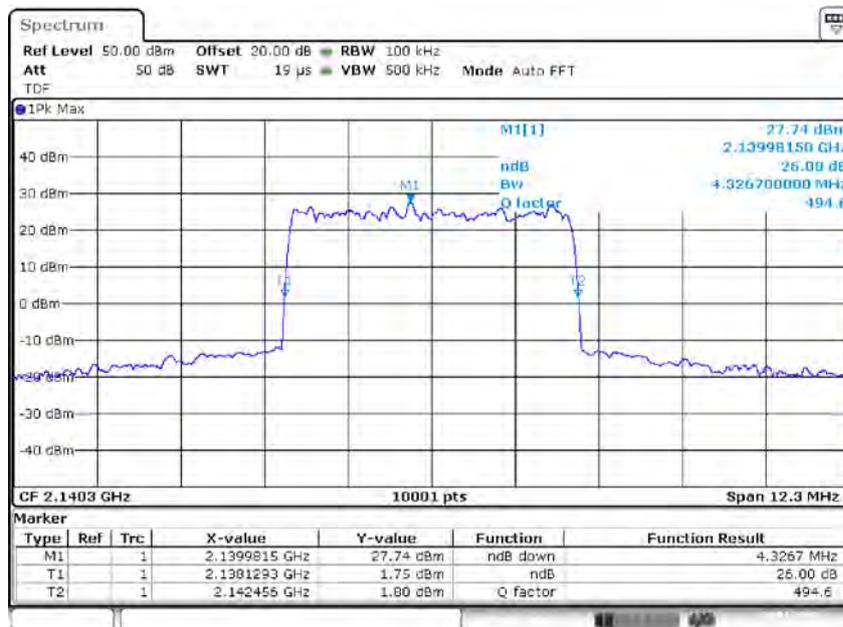

AWGN Out -0.3 ANT 2 #2.1403G \_26dB

Output Signal



Frequency Band = Band 4/10/66, Direction = RF downlink, Input Power = 3 dB > AGC, Signal Type = Narrowband (S01\_AA01)

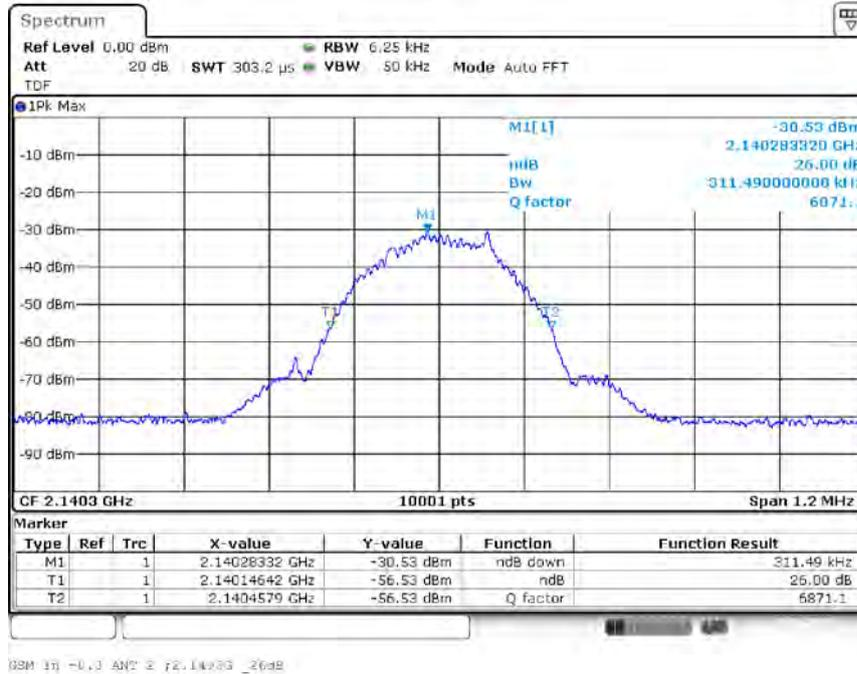

Input Signal

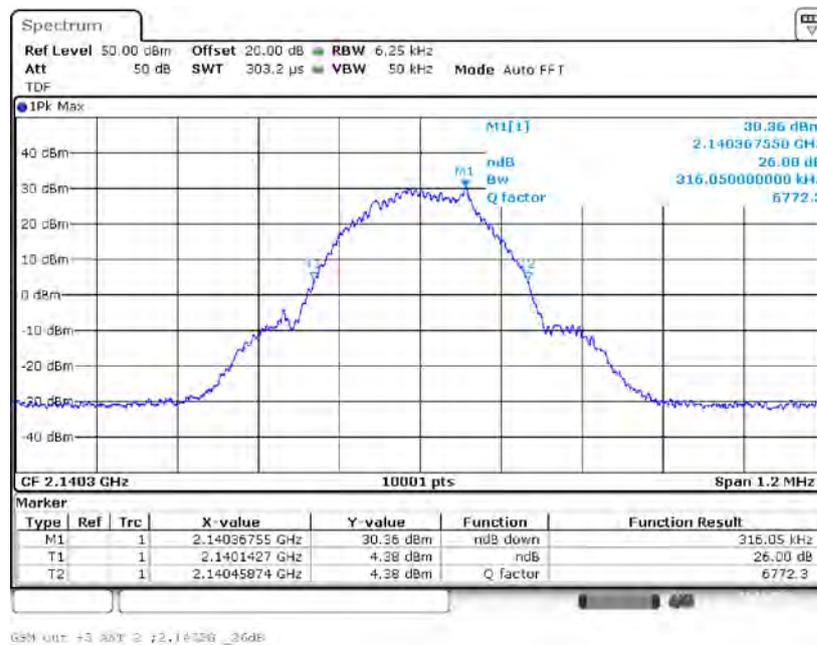

Output Signal

Frequency Band = Band 4/10/66, Direction = RF downlink, Input Power = 3 dB > AGC, Signal Type = Wideband (S01\_AA01)

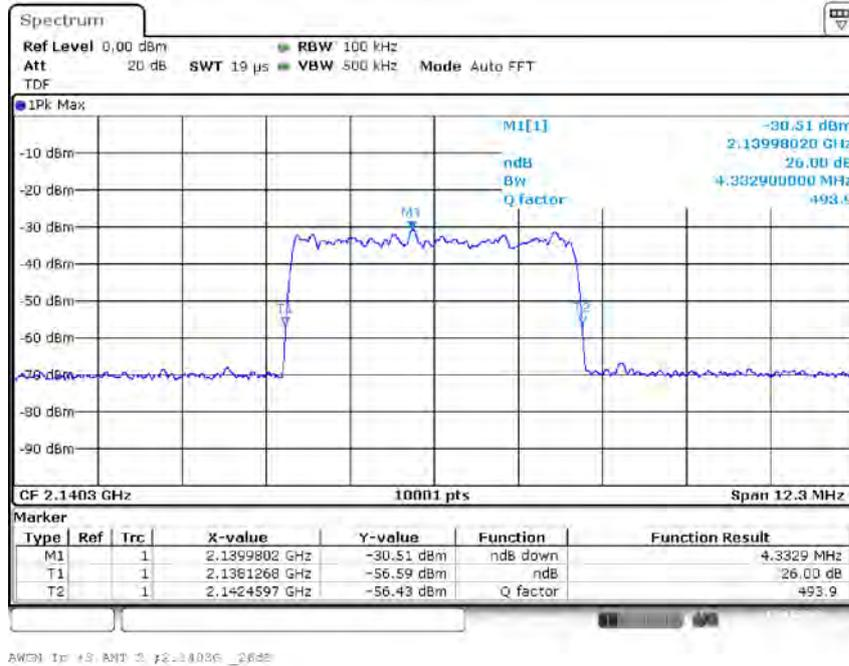

Input Signal



Output Signal

#### 4.3.5 TEST EQUIPMENT USED

FCC Conducted Base Station / Repeater

#### 4.4 CONDUCTED SPURIOUS EMISSIONS AT ANTENNA TERMINALS

Standard FCC Part §2.1051, §27.53

**The test was performed according to:**  
ANSI C63.26

##### 4.4.1 TEST DESCRIPTION

This test case is intended to demonstrate compliance to the signal booster power and gain limits and requirements for industrial signal boosters.

The EUT was connected to the test setup according to the following diagram:

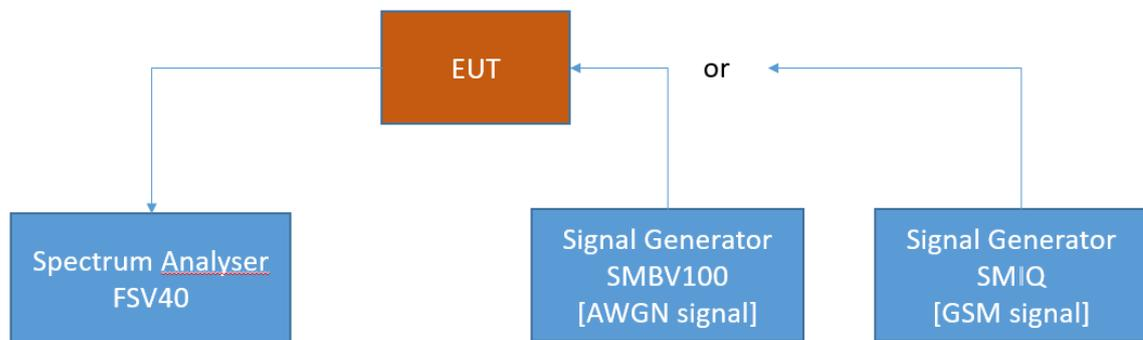

FCC Part 22/24/27/90 Industrial signal booster – Test Setup; RF Output Power / Gain

The attenuation of the measuring and stimulus path are known for each measured frequency and are considered.

The Spectrum Analyzer settings can be directly found in the measurement diagrams.

##### 4.4.2 TEST REQUIREMENTS / LIMITS

**FCC Part 2.1051; Measurement required: Spurious emissions at antenna terminal:**

The radio frequency voltage or powers generated within the equipment and appearing on a spurious frequency shall be checked at the equipment output terminals when properly loaded with a suitable artificial antenna. Curves or equivalent data shall show the magnitude of each harmonic and other spurious emission that can be detected when the equipment is operated under the conditions specified in §2.1049 as appropriate. The magnitude of spurious emissions which are attenuated more than 20 dB below the permissible value need not be specified.

## Part 27; Miscellaneous Wireless Communication Services

### Subpart C – Technical standards

#### §27.53 – Emission limits

##### Band 13

(c) For operations in the 746-758 MHz band and the 776-788 MHz band, the power of any emission outside the licensee's frequency band(s) of operation shall be attenuated below the transmitter power (P) within the licensed band(s) of operation, measured in watts, in accordance with the following:

(1) On any frequency outside the 746-758 MHz band, the power of any emission shall be attenuated outside the band below the transmitter power (P) by at least  $43 + 10 \log (P)$  dB;

(2) On any frequency outside the 776-788 MHz band, the power of any emission shall be attenuated outside the band below the transmitter power (P) by at least  $43 + 10 \log (P)$  dB;

(3) On all frequencies between 763-775 MHz and 793-805 MHz, by a factor not less than  $76 + 10 \log (P)$  dB in a 6.25 kHz band segment, for base and fixed stations;

(4) On all frequencies between 763-775 MHz and 793-805 MHz, by a factor not less than  $65 + 10 \log (P)$  dB in a 6.25 kHz band segment, for mobile and portable stations;

(5) Compliance with the provisions of paragraphs (c)(1) and (c)(2) of this section is based on the use of measurement instrumentation employing a resolution bandwidth of 100 kHz or greater. However, in the 100 kHz bands immediately outside and adjacent to the frequency block, a resolution bandwidth of at least 30 kHz may be employed;

(f) For operations in the 746-758 MHz, 775-788 MHz, and 805-806 MHz bands, emissions in the band 1559-1610 MHz shall be limited to  $-70$  dBW/MHz equivalent isotropically radiated power (EIRP) for wideband signals, and  $-80$  dBW EIRP for discrete emissions of less than 700 Hz bandwidth. For the purpose of equipment authorization, a transmitter shall be tested with an antenna that is representative of the type that will be used with the equipment in normal operation.

(6) Compliance with the provisions of paragraphs (c)(3) and (c)(4) of this section is based on the use of measurement instrumentation such that the reading taken with any resolution bandwidth setting should be adjusted to indicate spectral energy in a 6.25 kHz segment.

##### Band 12:

(g) For operations in the 600 MHz band and the 698-746 MHz band, the power of any emission outside a licensee's frequency band(s) of operation shall be attenuated below the transmitter power (P) within the licensed band(s) of operation, measured in watts, by at least  $43 + 10 \log (P)$  dB. Compliance with this provision is based on the use of measurement instrumentation employing a resolution bandwidth of 100 kilohertz or greater. However, in the 100 kilohertz bands immediately outside and adjacent to a licensee's frequency block, a resolution bandwidth of at least 30 kHz may be employed.

##### Band 4:

(h) *AWS emission limits—(1) General protection levels.* Except as otherwise specified below, for operations in the 1695-1710 MHz, 1710-1755 MHz, 1755-1780 MHz, 1915-1920 MHz, 1995-2000 MHz, 2000-2020 MHz, 2110-2155 MHz, 2155-2180 MHz, and 2180-2200 bands, the power of any emission outside a licensee's frequency block shall be attenuated below the transmitter power (P) in watts by at least  $43 + 10 \log_{10} (P)$  dB.

#### **RSS-130; 4.6 Transmitter Unwanted Emissions**

4.6.1 The power of any unwanted emissions in any 100 kHz bandwidth on any frequency outside the frequency range(s) within which the equipment is designed to operate shall be attenuated below the transmitter power, P (dBW), by at least  $43 + 10 \log_{10} p$  (watts), dB. However, in the 100 kHz band immediately outside the equipment's operating frequency range, a resolution bandwidth of 30 kHz may be employed.

4.6.2 In addition to the limit outlined in Section 4.6.1 above, equipment operating in the frequency bands 746-756 MHz and 777-787 MHz shall also comply with the following restrictions:

- (a) The power of any unwanted emissions in any 6.25 kHz bandwidth for all frequencies between 763-775 MHz and 793-806 MHz shall be attenuated below the transmitter power, P (dBW), by at least:
  - (i)  $76 + 10 \log_{10} p$  (watts), dB, for base and fixed equipment, and
  - (ii)  $65 + 10 \log_{10} p$  (watts), dB, for mobile and portable equipment.
- (b) The e.i.r.p. in the band 1559-1610 MHz shall not exceed  $-70$  dBW/MHz for wideband signal and  $-80$  dBW for discrete emission with bandwidth less than 700 Hz.
- 

#### **RSS-139; 6.6 Transmitter Unwanted Emissions**

Equipment shall comply with the limits in (i) and (ii) below.

- i. In the first 1.0 MHz bands immediately outside and adjacent to the equipment's smallest operating frequency block, which can contain the equipment's occupied bandwidth, the emission power per any 1% of the emission bandwidth shall be attenuated below the transmitter output power P (in dBW) by at least  $43 + 10 \log_{10} p$  (watts) dB.
- ii. After the first 1.0 MHz outside the equipment's smallest operating frequency block, which can contain the equipment's occupied bandwidth, the emission power in any 1 MHz bandwidth shall be attenuated below the transmitter output power P (in dBW) by at least  $43 + 10 \log_{10} p$  (watts) dB.

#### 4.4.3 TEST PROTOCOL

<b>Band 4/10/66, downlink [Module 1]</b>							
<b>Test Frequency</b>	<b>Signal Type</b>	<b>Spurious Freq. [MHz]</b>	<b>Spurious Level [dBm]</b>	<b>Detector</b>	<b>RBW [kHz]</b>	<b>Limit [dBm]</b>	<b>Margin to Limit [dB]</b>
low	Wideband	-	-	RMS	1000	-13.0	---
mid	Wideband	-	-	RMS	1000	-13.0	---
high	Wideband	-	-	RMS	1000	-13.0	---
low	Narrowband	-	-	RMS	1000	-13.0	---
mid	Narrowband	-	-	RMS	1000	-13.0	---
high	Narrowband	-	-	RMS	1000	-13.0	---

<b>Band 4/10/66, downlink [Module 2]</b>							
<b>Test Frequency</b>	<b>Signal Type</b>	<b>Spurious Freq. [MHz]</b>	<b>Spurious Level [dBm]</b>	<b>Detector</b>	<b>RBW [kHz]</b>	<b>Limit [dBm]</b>	<b>Margin to Limit [dB]</b>
low	Wideband	-	-	RMS	1000	-13.0	---
mid	Wideband	-	-	RMS	1000	-13.0	---
high	Wideband	-	-	RMS	1000	-13.0	---
low	Narrowband	-	-	RMS	1000	-13.0	---
mid	Narrowband	-	-	RMS	1000	-13.0	---
high	Narrowband	-	-	RMS	1000	-13.0	---

Remark: Please see next sub-clause for the measurement plot.

#### 4.4.4 MEASUREMENT PLOT (SHOWING THE HIGHEST VALUE, "WORST CASE")

##### Module 1:

Frequency Band = Band 4/10/66, Test Frequency = mid, Direction = RF downlink, Signal Type = Narrowband (S01\_AA01)

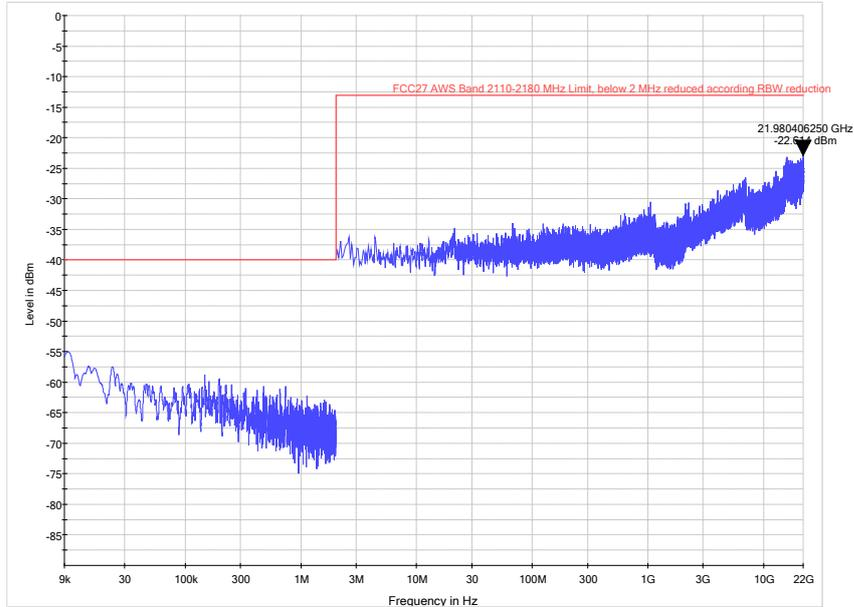

Frequency Band = Band 4/10/66, Test Frequency = mid, Direction = RF downlink, Signal Type = Wideband (S01\_AA01)

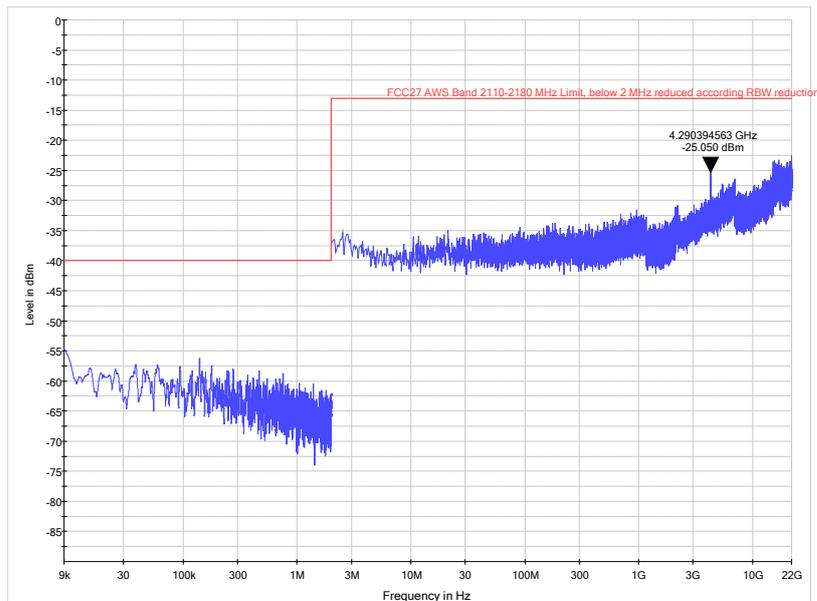

Frequency Band = Band 4/10/66, Test Frequency = low, Direction = RF downlink, Signal Type = Narrowband (S01\_AA01)

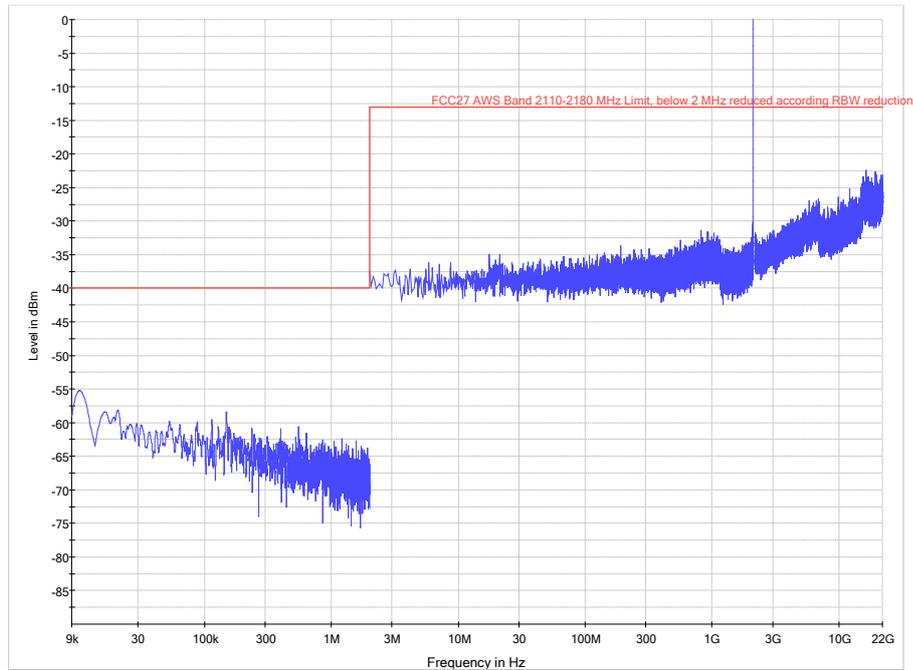

Frequency Band = Band 4/10/66, Test Frequency = low, Direction = RF downlink, Signal Type = Narrowband, Final Measurement (S01\_AA01)

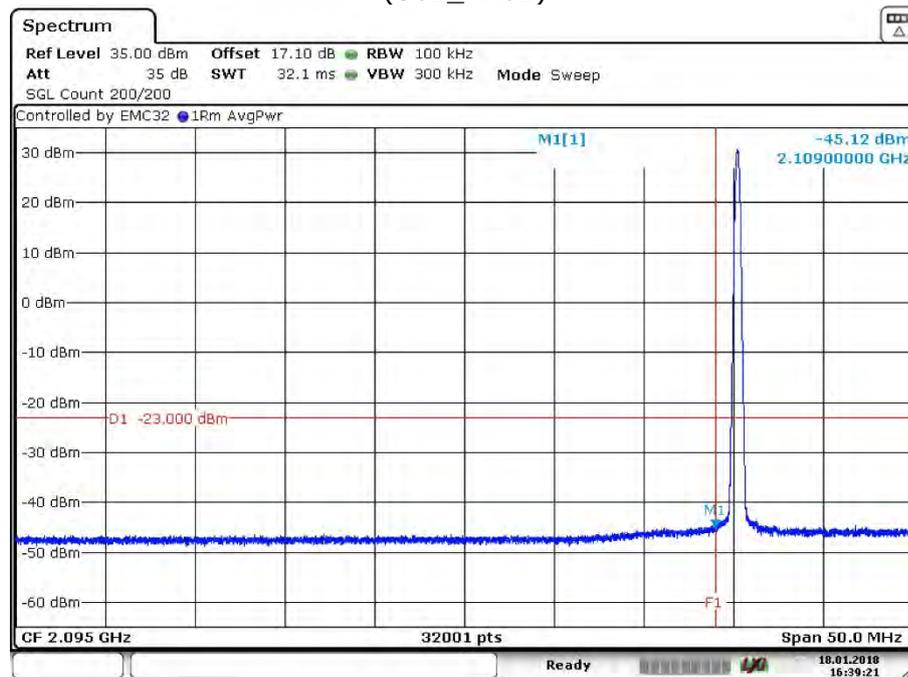

Date: 18 JAN 2018 16:39:22



Frequency Band = Band 4/10/66, Test Frequency = low, Direction = RF downlink, Signal Type = Wideband (S01\_AA01)

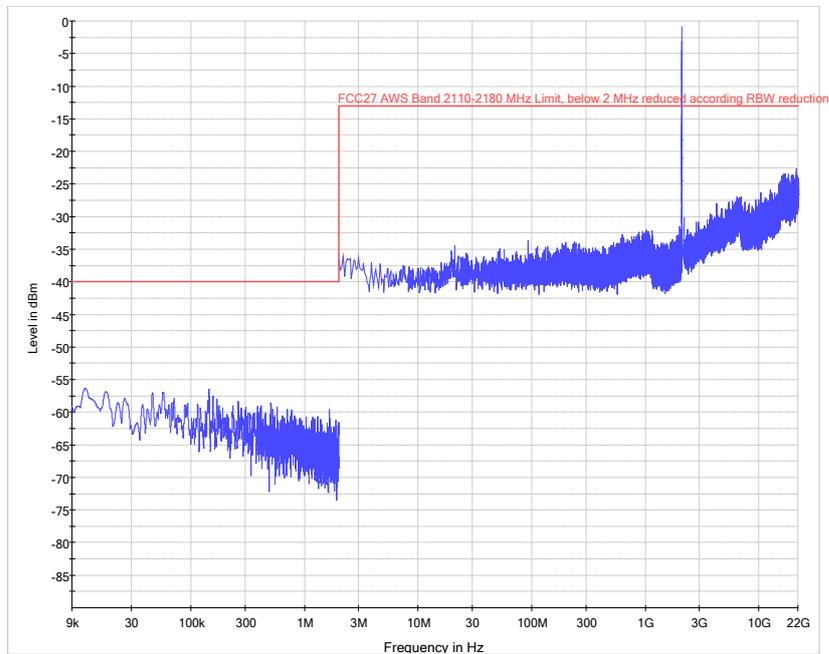

Frequency Band = Band 4/10/66, Test Frequency = low, Direction = RF downlink, Signal Type = Wideband, Final Measurement (S01\_AA01)

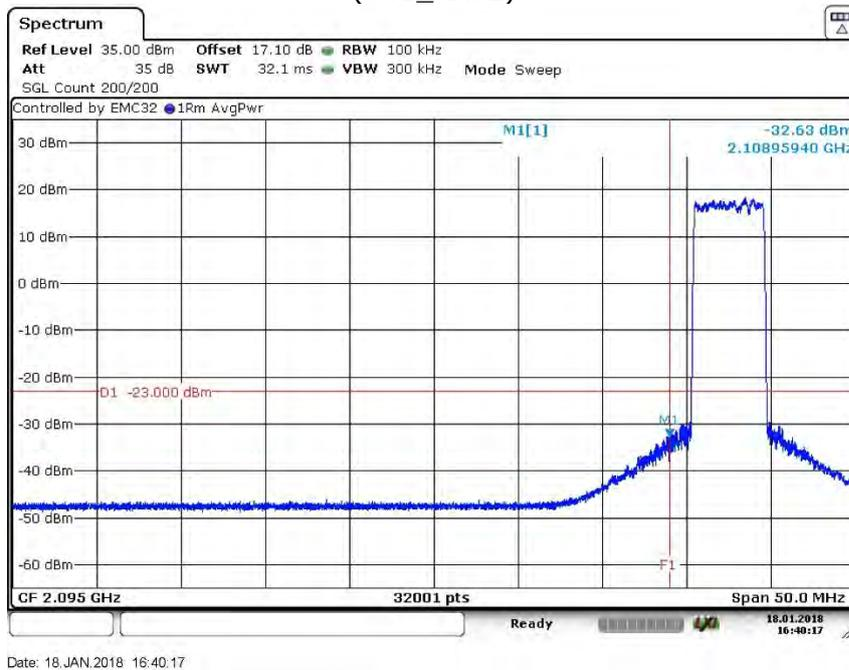

Frequency Band = Band 4/10/66, Test Frequency = high, Direction = RF downlink, Signal Type = Narrowband (S01\_AA01)

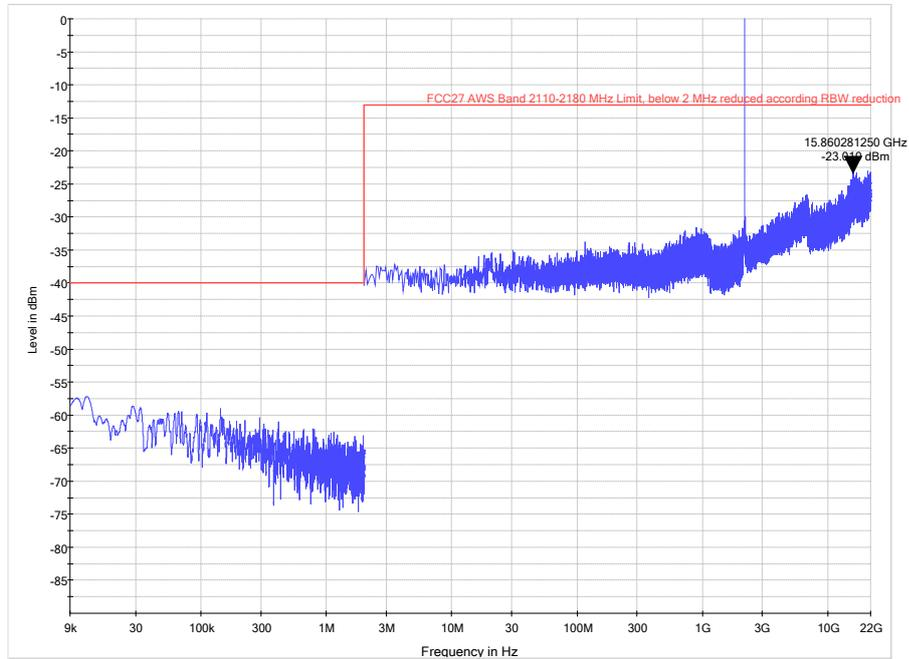

Frequency Band = Band 4/10/66, Test Frequency = high, Direction = RF downlink, Signal Type = Narrowband, Final Measurement (S01\_AA01)

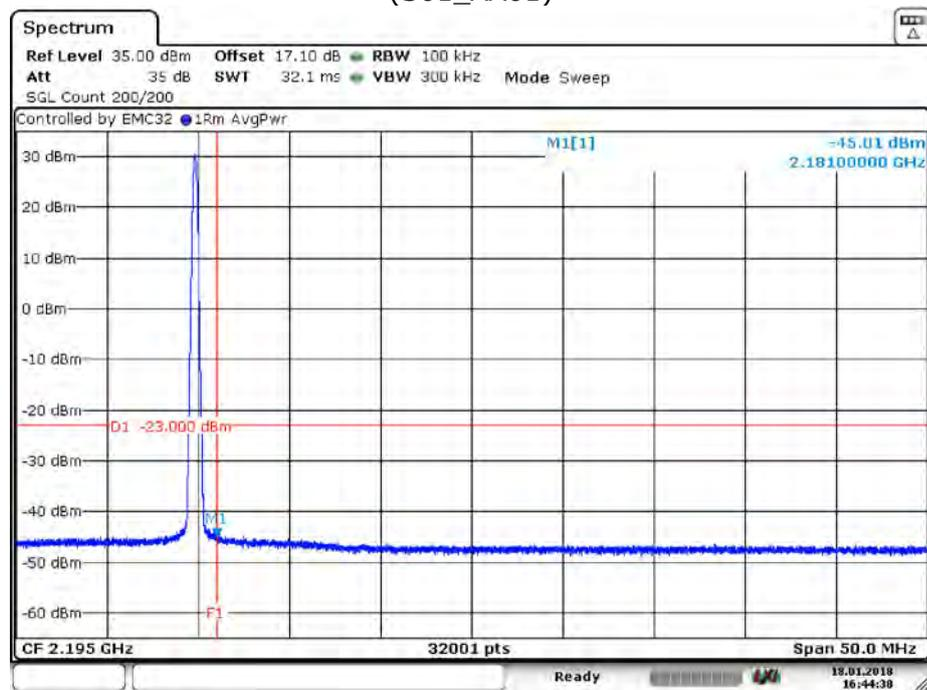

Date: 18. JAN. 2018 16:44:38

Frequency Band = Band 4/10/66, Test Frequency = high, Direction = RF downlink, Signal Type = Wideband (S01\_AA01)

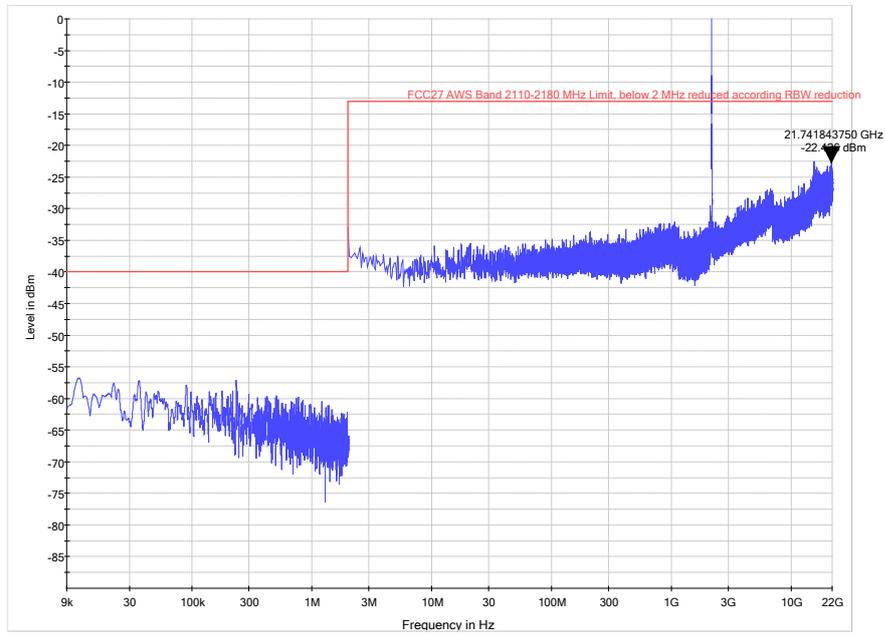

Frequency Band = Band 4/10/66, Test Frequency = high, Direction = RF downlink, Signal Type = Wideband, Final Measurement (S01\_AA01)

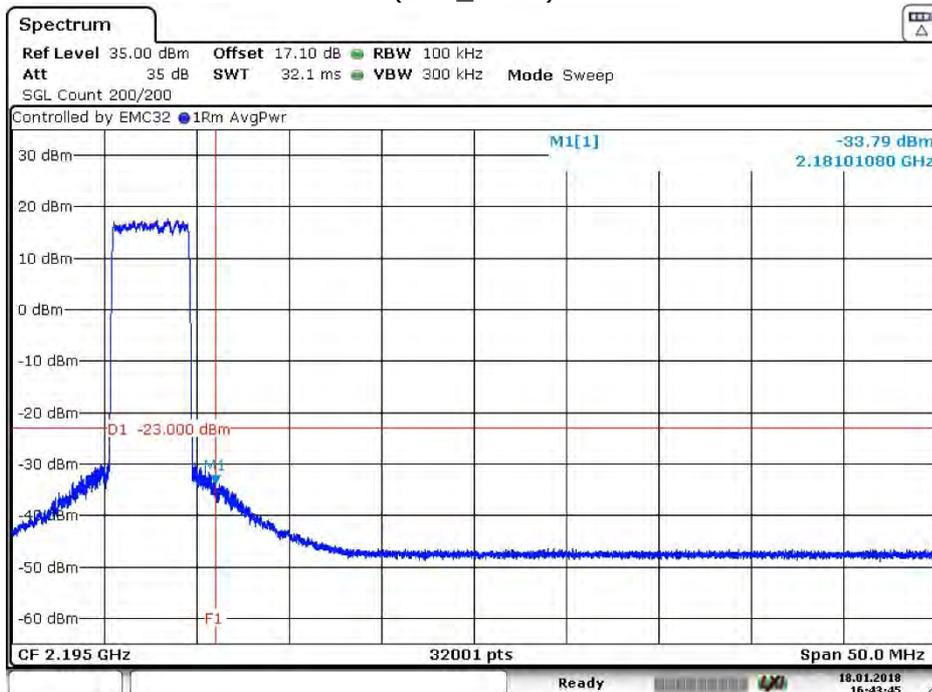

Date: 18.JAN.2018 16:43:45

## Module 2

:

Frequency Band = Band 4/10/66, Test Frequency = mid, Direction = RF downlink, Signal Type = Narrowband (S01\_AA01)

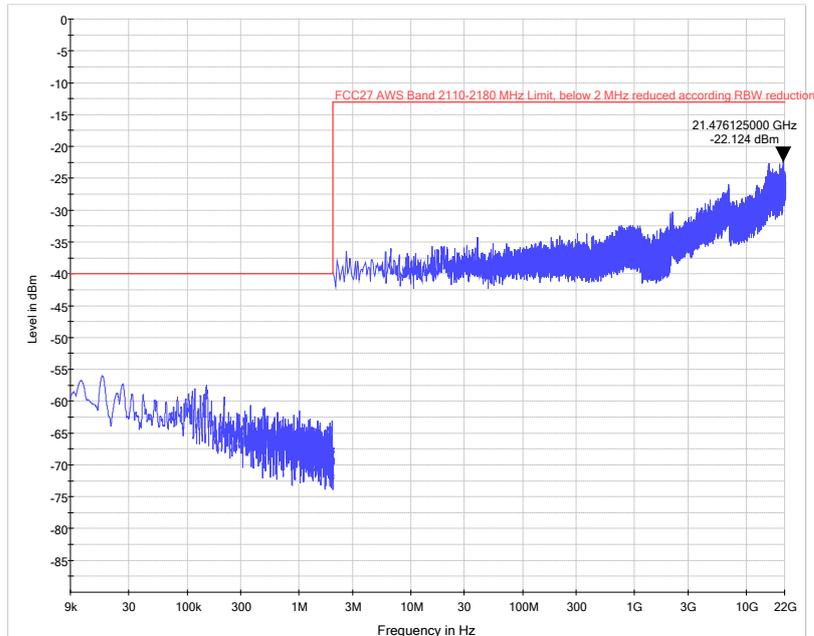

Frequency Band = Band 4/10/66, Test Frequency = mid, Direction = RF downlink, Signal Type = Wideband (S01\_AA01)

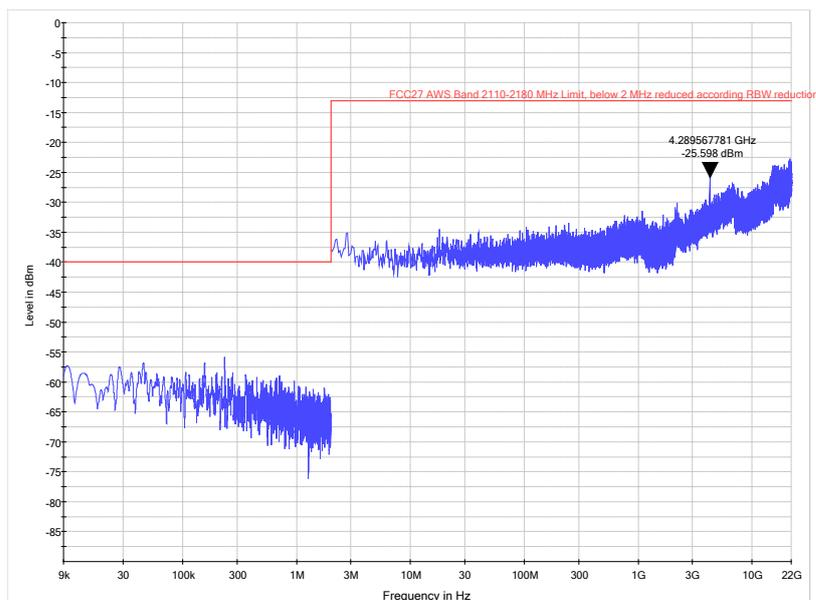

Frequency Band = Band 4/10/66, Test Frequency = low, Direction = RF downlink, Signal Type = Narrowband (S01\_AA01)

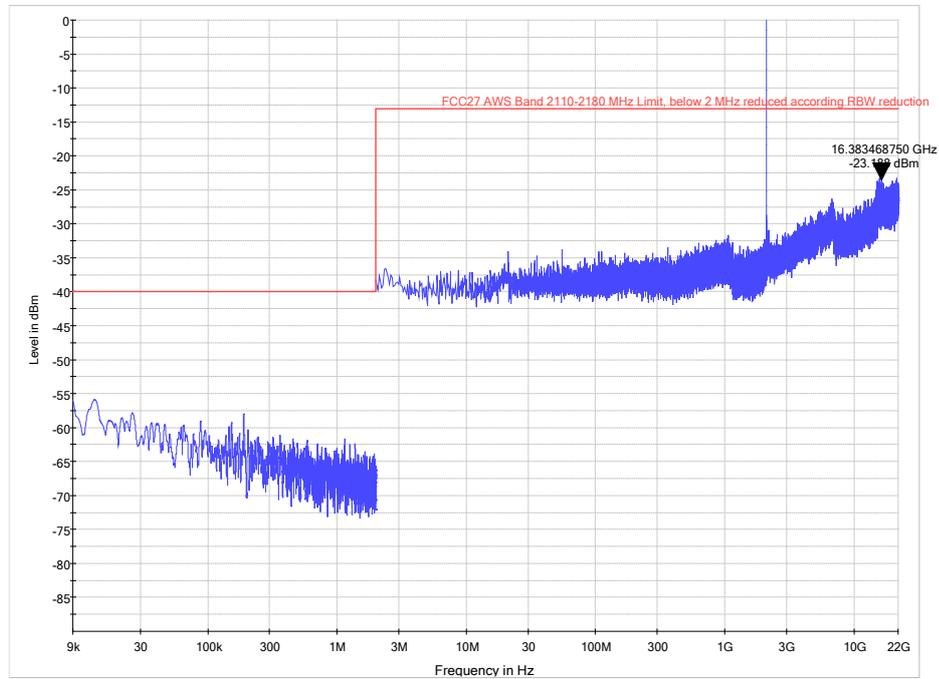

Frequency Band = Band 4/10/66, Test Frequency = low, Direction = RF downlink, Signal Type = Narrowband, Final Measurement (S01\_AA01)

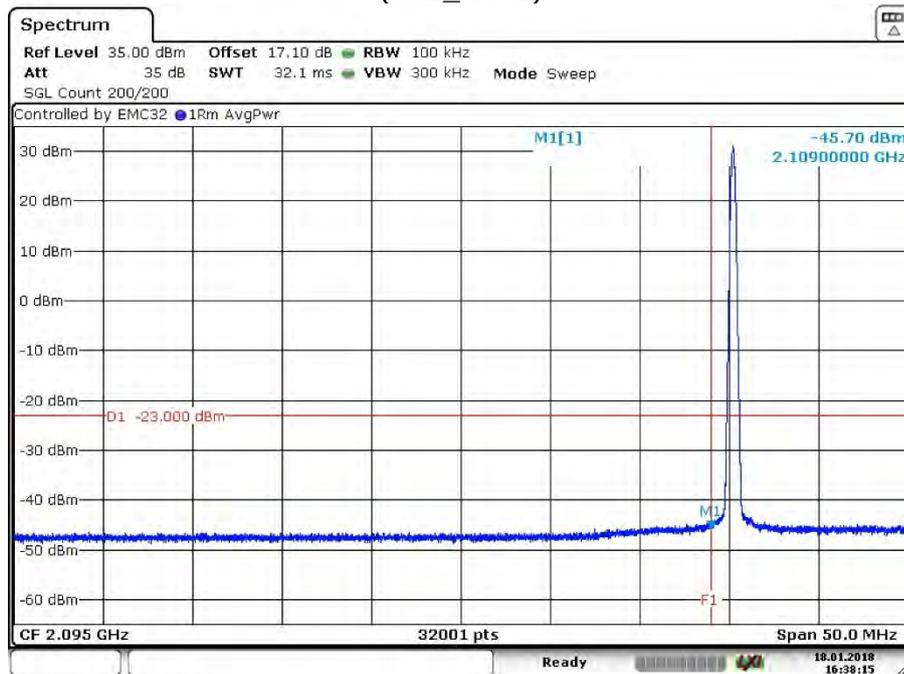

Date: 18.JAN.2018 16:38:15

Frequency Band = Band 4/10/66, Test Frequency = low, Direction = RF downlink, Signal Type = Wideband (S01\_AA01)

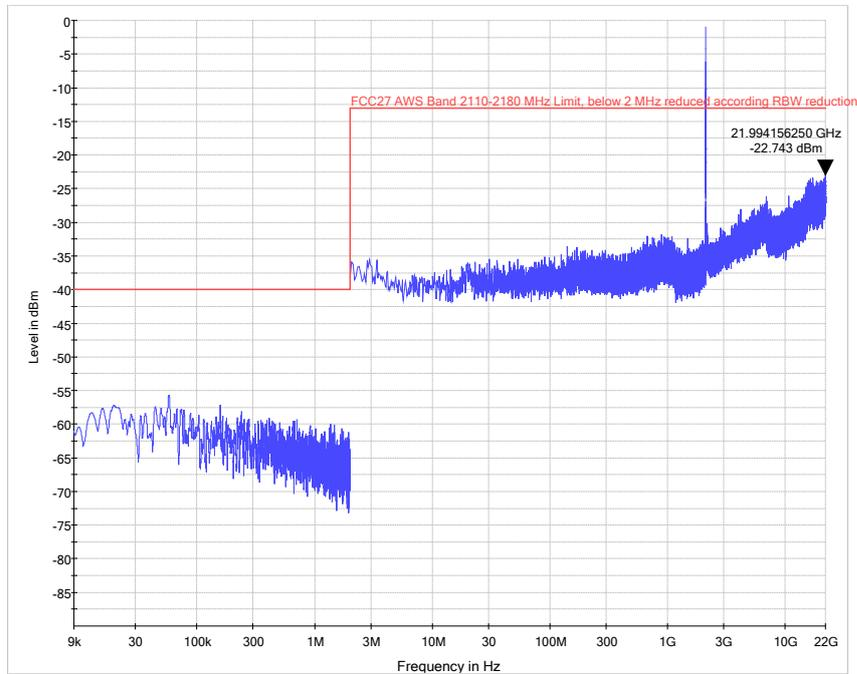

Frequency Band = Band 4/10/66, Test Frequency = low, Direction = RF downlink, Signal Type = Wideband, Final Measurement (S01\_AA01)

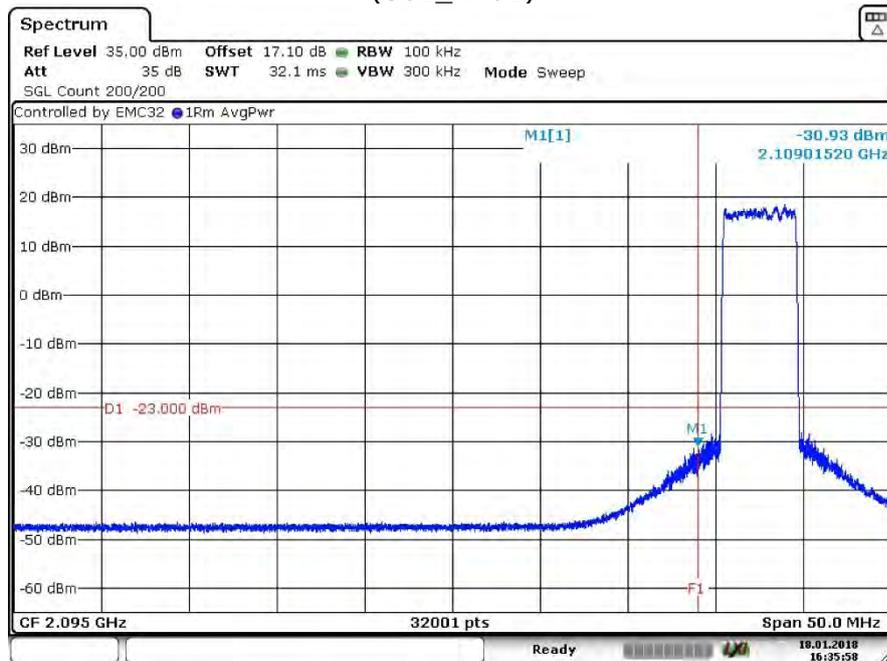

Date: 18.JAN.2018 16:35:59

Frequency Band = Band 4/10/66, Test Frequency = high, Direction = RF downlink, Signal Type = Narrowband (S01\_AA01)

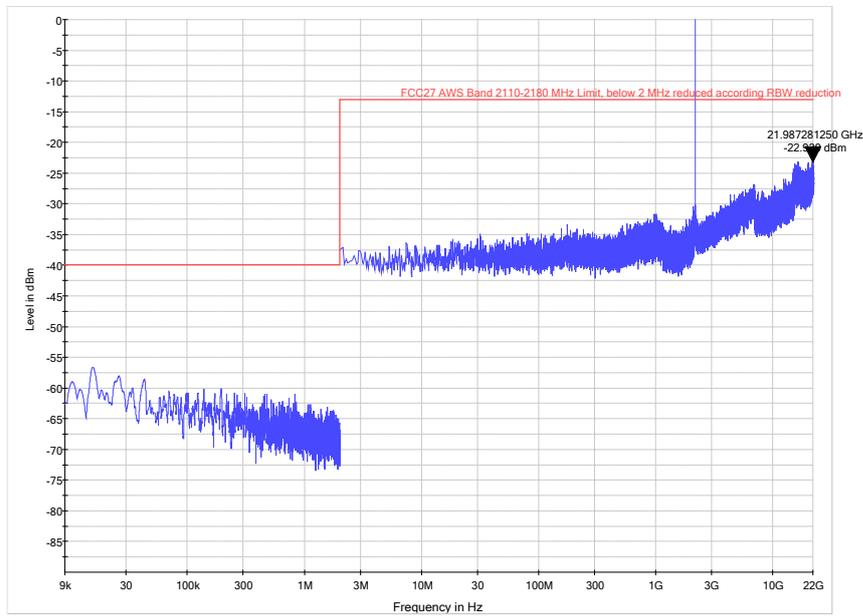

Frequency Band = Band 4/10/66, Test Frequency = high, Direction = RF downlink, Signal Type = Narrowband, Final Measurement (S01\_AA01)

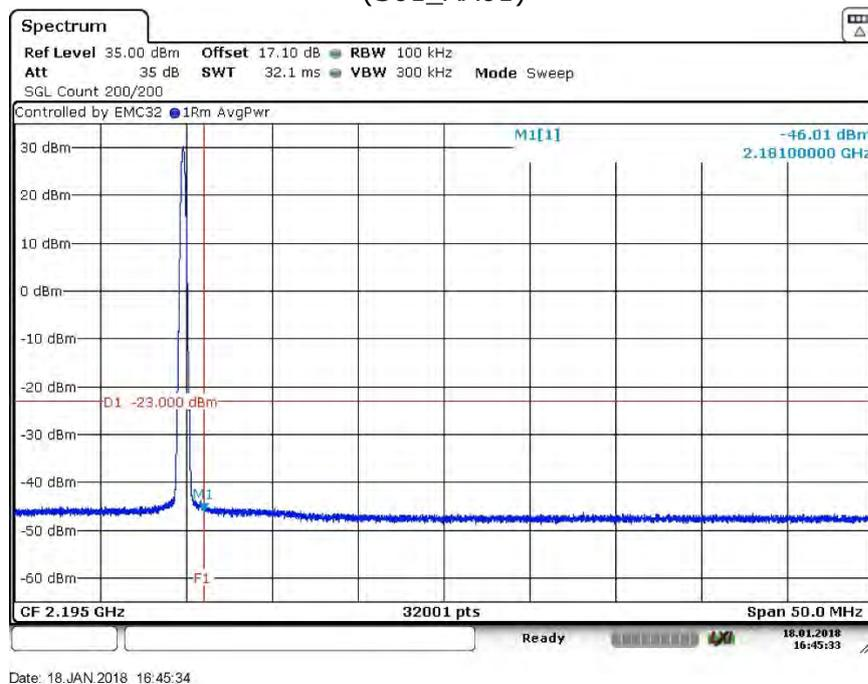

Frequency Band = Band 4/10/66, Test Frequency = high, Direction = RF downlink, Signal Type = Wideband (S01\_AA01)

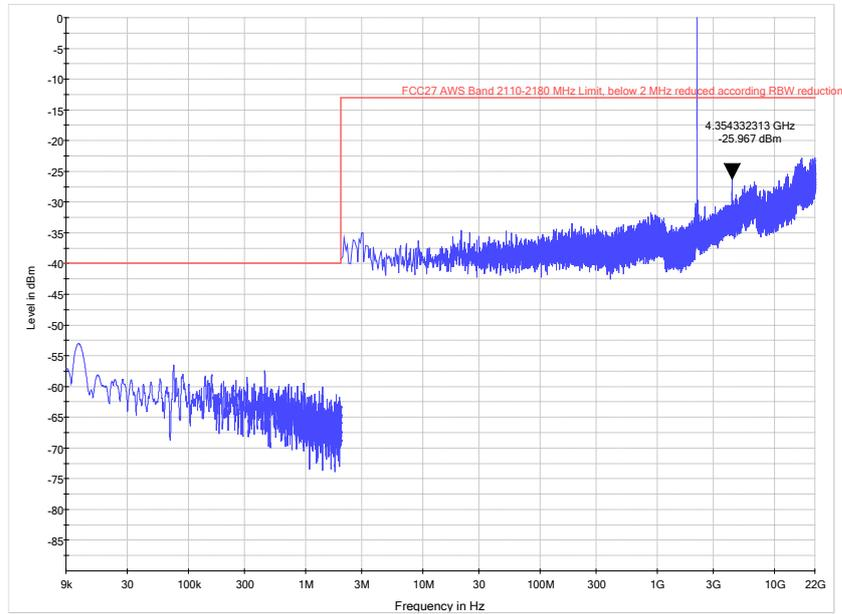

Frequency Band = Band 4/10/66, Test Frequency = high, Direction = RF downlink, Signal Type = Wideband, Final Measurement (S01\_AA01)

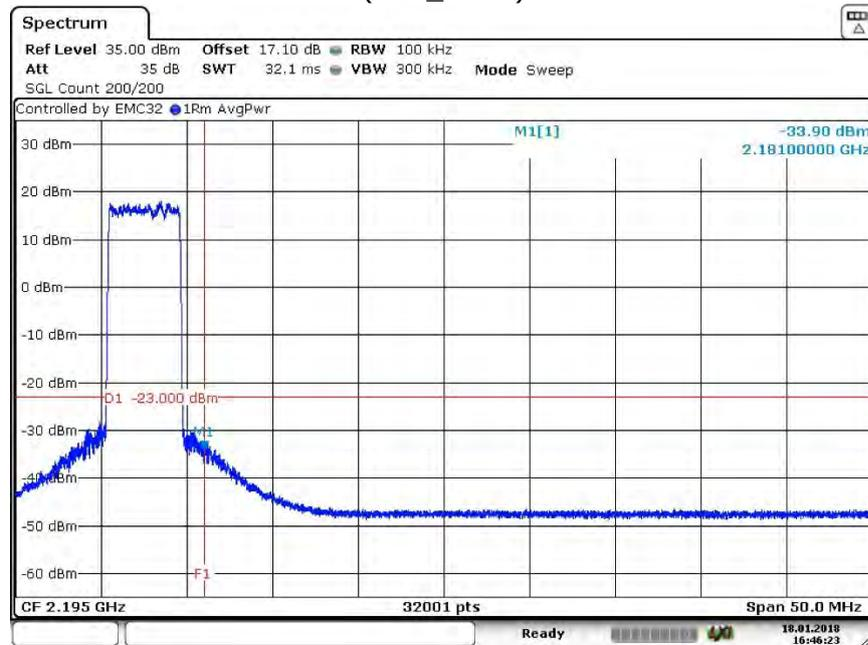

Date: 18.JAN.2018 16:46:24

#### 4.4.5 TEST EQUIPMENT USED

- R&S TS8997



## 4.5 OUT-OF-BAND EMISSION LIMITS

Standard FCC Part §2.1051, §27.53

**The test was performed according to:**  
ANSI C63.26, KDB 935210 D05 v01r02: 3.6

### 4.5.1 TEST DESCRIPTION

This test case is intended to demonstrate compliance to the out-of-band emission limit for industrial signal boosters. The limits itself come from the applicable rule part for each operating band.

The EUT was connected to the test setup according to the following diagram:

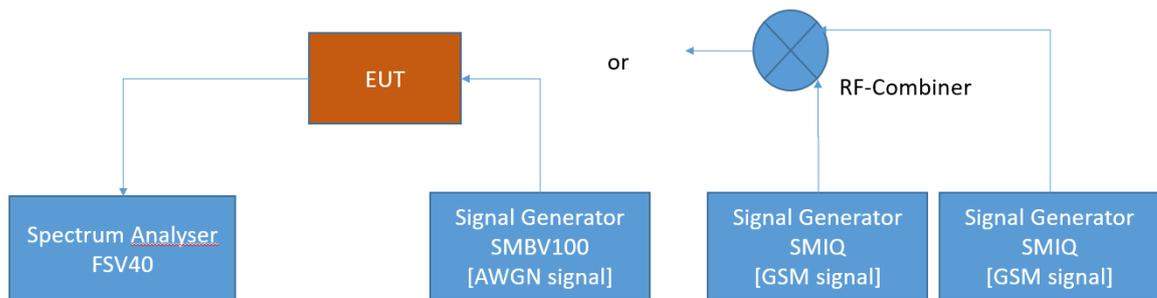

FCC Part 22/24/27/90 Industrial signal booster – Test Setup; Out-of-band emissions

The attenuation of the measuring and stimulus path are known for each measured frequency and are considered.

The Spectrum Analyzer settings can be directly found in the measurement diagrams.

### 4.5.2 TEST REQUIREMENTS / LIMITS

#### Part 27; Miscellaneous Wireless Communication Services

##### Subpart C – Technical standards

##### §27.53 – Emission limits

##### Band 13

(c) For operations in the 746-758 MHz band and the 776-788 MHz band, the power of any emission outside the licensee's frequency band(s) of operation shall be attenuated below the transmitter power (P) within the licensed band(s) of operation, measured in watts, in accordance with the following:

- (1) On any frequency outside the 746-758 MHz band, the power of any emission shall be attenuated outside the band below the transmitter power (P) by at least  $43 + 10 \log (P)$  dB;
- (2) On any frequency outside the 776-788 MHz band, the power of any emission shall be attenuated outside the band below the transmitter power (P) by at least  $43 + 10 \log (P)$  dB;

(3) On all frequencies between 763-775 MHz and 793-805 MHz, by a factor not less than  $76 + 10 \log (P)$  dB in a 6.25 kHz band segment, for base and fixed stations;

(4) On all frequencies between 763-775 MHz and 793-805 MHz, by a factor not less than  $65 + 10 \log (P)$  dB in a 6.25 kHz band segment, for mobile and portable stations;

(5) Compliance with the provisions of paragraphs (c)(1) and (c)(2) of this section is based on the use of measurement instrumentation employing a resolution bandwidth of 100 kHz or greater. However, in the 100 kHz bands immediately outside and adjacent to the frequency block, a resolution bandwidth of at least 30 kHz may be employed;

(f) For operations in the 746-758 MHz, 775-788 MHz, and 805-806 MHz bands, emissions in the band 1559-1610 MHz shall be limited to  $-70$  dBW/MHz equivalent isotropically radiated power (EIRP) for wideband signals, and  $-80$  dBW EIRP for discrete emissions of less than 700 Hz bandwidth. For the purpose of equipment authorization, a transmitter shall be tested with an antenna that is representative of the type that will be used with the equipment in normal operation.

(6) Compliance with the provisions of paragraphs (c)(3) and (c)(4) of this section is based on the use of measurement instrumentation such that the reading taken with any resolution bandwidth setting should be adjusted to indicate spectral energy in a 6.25 kHz segment.

#### **Band 12:**

(g) For operations in the 600 MHz band and the 698-746 MHz band, the power of any emission outside a licensee's frequency band(s) of operation shall be attenuated below the transmitter power (P) within the licensed band(s) of operation, measured in watts, by at least  $43 + 10 \log (P)$  dB. Compliance with this provision is based on the use of measurement instrumentation employing a resolution bandwidth of 100 kilohertz or greater. However, in the 100 kilohertz bands immediately outside and adjacent to a licensee's frequency block, a resolution bandwidth of at least 30 kHz may be employed.

#### **Band 4:**

(h) *AWS emission limits—(1) General protection levels.* Except as otherwise specified below, for operations in the 1695-1710 MHz, 1710-1755 MHz, 1755-1780 MHz, 1915-1920 MHz, 1995-2000 MHz, 2000-2020 MHz, 2110-2155 MHz, 2155-2180 MHz, and 2180-2200 bands, the power of any emission outside a licensee's frequency block shall be attenuated below the transmitter power (P) in watts by at least  $43 + 10 \log_{10} (P)$  dB.

### **RSS-130; 4.6 Transmitter Unwanted Emissions**

4.6.1 The power of any unwanted emissions in any 100 kHz bandwidth on any frequency outside the frequency range(s) within which the equipment is designed to operate shall be attenuated below the transmitter power, P (dBW), by at least  $43 + 10 \log_{10} p$  (watts), dB. However, in the 100 kHz band immediately outside the equipment's operating frequency range, a resolution bandwidth of 30 kHz may be employed.

4.6.2 In addition to the limit outlined in Section 4.6.1 above, equipment operating in the frequency bands 746-756 MHz and 777-787 MHz shall also comply with the following restrictions:

- (a) The power of any unwanted emissions in any 6.25 kHz bandwidth for all frequencies between 763-775 MHz and 793-806 MHz shall be attenuated below the transmitter power, P (dBW), by at least:
  - (i)  $76 + 10 \log_{10} p$  (watts), dB, for base and fixed equipment, and
  - (ii)  $65 + 10 \log_{10} p$  (watts), dB, for mobile and portable equipment.
- (b) The e.i.r.p. in the band 1559-1610 MHz shall not exceed  $-70$  dBW/MHz for wideband signal and  $-80$  dBW for discrete emission with bandwidth less than 700 Hz.

### RSS-139; 6.6 Transmitter Unwanted Emissions

Equipment shall comply with the limits in (i) and (ii) below.

- i. In the first 1.0 MHz bands immediately outside and adjacent to the equipment's smallest operating frequency block, which can contain the equipment's occupied bandwidth, the emission power per any 1% of the emission bandwidth shall be attenuated below the transmitter output power P (in dBW) by at least  $43 + 10 \log_{10} p$  (watts) dB.
- ii. After the first 1.0 MHz outside the equipment's smallest operating frequency block, which can contain the equipment's occupied bandwidth, the emission power in any 1 MHz bandwidth shall be attenuated below the transmitter output power P (in dBW) by at least  $43 + 10 \log_{10} p$  (watts) dB.

#### 4.5.3 TEST PROTOCOL

Band 4/10/66, downlink, Number of input signals = 1 [Module 1]							
Signal Type	Input Power	Band Edge	Signal Frequency [MHz]	Input Power [dBm]	Maximum Out-of-band Power [dBm]	Limit Out-of-band Power [dBm]	Margin to Limit [dB]
Wideband	0.3 dB < AGC	upper	2177.50	-27.5	-39.4	-13.0	26.4
Wideband	3 dB > AGC	upper	2177.50	-24.6	-38.2	-13.0	25.2
Narrowband	0.3 dB < AGC	upper	2179.80	-27.5	-24.6	-13.0	11.6
Narrowband	3 dB > AGC	upper	2179.80	-24.6	-25.1	-13.0	12.1
Wideband	0.3 dB < AGC	lower	2112.50	-27.5	-37.5	-13.0	24.5
Wideband	3 dB > AGC	lower	2112.50	-24.6	-36.9	-13.0	23.9
Narrowband	0.3 dB < AGC	lower	2110.20	-27.5	-23.7	-13.0	10.7
Narrowband	3 dB > AGC	lower	2110.20	-24.6	-24.4	-13.0	11.4

Band 4/10/66, downlink, Number of input signals = 2 [Module 1]								
Signal Type	Input Power	Band Edge	Signal Frequency f1 [MHz]	Signal Frequency f2 [MHz]	Input Power [dBm]	Maximum Out-of-band Power [dBm]	Limit Out-of-band Power [dBm]	Margin to Limit [dB]
WB	0.3 dB < AGC	upper	2177.50	2172.50	-27.5	-34.4	-13.0	21.4
WB	3 dB > AGC	upper	2177.50	2172.50	-24.6	-33.8	-13.0	20.8
NB	0.3 dB < AGC	upper	2179.80	2179.60	-27.5	-27.9	-13.0	14.9
NB	3 dB > AGC	upper	2179.80	2179.60	-24.6	-27.6	-13.0	14.6
WB	0.3 dB < AGC	lower	2112.50	2117.50	-27.5	-33.2	-13.0	20.2
WB	3 dB > AGC	lower	2112.50	2117.50	-24.6	-33.9	-13.0	20.9
NB	0.3 dB < AGC	lower	2110.20	2110.40	-27.5	-27.8	-13.0	14.8
NB	3 dB > AGC	lower	2110.20	2110.40	-24.6	-27.3	-13.0	14.3

Band 4/10/66, downlink, Number of input signals = 1 [Module 2]							
Signal Type	Input Power	Band Edge	Signal Frequency [MHz]	Input Power [dBm]	Maximum Out-of-band Power [dBm]	Limit Out-of-band Power [dBm]	Margin to Limit [dB]
Wideband	0.3 dB < AGC	upper	2177.50	-27.5	-38.3	-13.0	25.3
Wideband	3 dB > AGC	upper	2177.50	-24.6	-37.6	-13.0	24.6
Narrowband	0.3 dB < AGC	upper	2179.80	-27.5	-24.1	-13.0	11.1
Narrowband	3 dB > AGC	upper	2179.80	-24.6	-24.5	-13.0	11.5
Wideband	0.3 dB < AGC	lower	2182.50	-27.5	-37.1	-13.0	24.1
Wideband	3 dB > AGC	lower	2182.50	-24.6	-37.2	-13.0	24.2
Narrowband	0.3 dB < AGC	lower	2180.20	-27.5	-24.6	-13.0	11.6
Narrowband	3 dB > AGC	lower	2180.20	-24.6	-23.9	-13.0	10.9

Band 4/10/66, downlink, Number of input signals = 2 [Module 2]								
Signal Type	Input Power	Band Edge	Signal Frequency f1 [MHz]	Signal Frequency f2 [MHz]	Input Power [dBm]	Maximum Out-of-band Power [dBm]	Limit Out-of-band Power [dBm]	Margin to Limit [dB]
WB	0.3 dB < AGC	upper	2177.50	2175.00	-27.5	-33.4	-13.0	20.4
WB	3 dB > AGC	upper	2177.50	2175.00	-24.6	-33.9	-13.0	20.9
NB	0.3 dB < AGC	upper	2179.80	2179.60	-27.5	-28.6	-13.0	15.6
NB	3 dB > AGC	upper	2179.80	2179.60	-24.6	-27.5	-13.0	14.5
WB	0.3 dB < AGC	lower	2182.50	2115.00	-27.5	-34.4	-13.0	21.4
WB	3 dB > AGC	lower	2182.50	2115.00	-24.6	-32.8	-13.0	19.8
NB	0.3 dB < AGC	lower	2180.20	2110.40	-27.5	-27.6	-13.0	14.6
NB	3 dB > AGC	lower	2180.20	2110.40	-24.6	-27.4	-13.0	14.4

Remark: Please see next sub-clause for the measurement plot.

#### 4.5.4 MEASUREMENT PLOT (SHOWING THE HIGHEST VALUE, "WORST CASE")

##### Module 1:

Band Edge = Lower, Frequency Band = Band 4/10/66, Number of signals = 1, Direction = RF downlink, Input Power = 3 dB > AGC, Signal Type = Wideband (S01\_AA01)

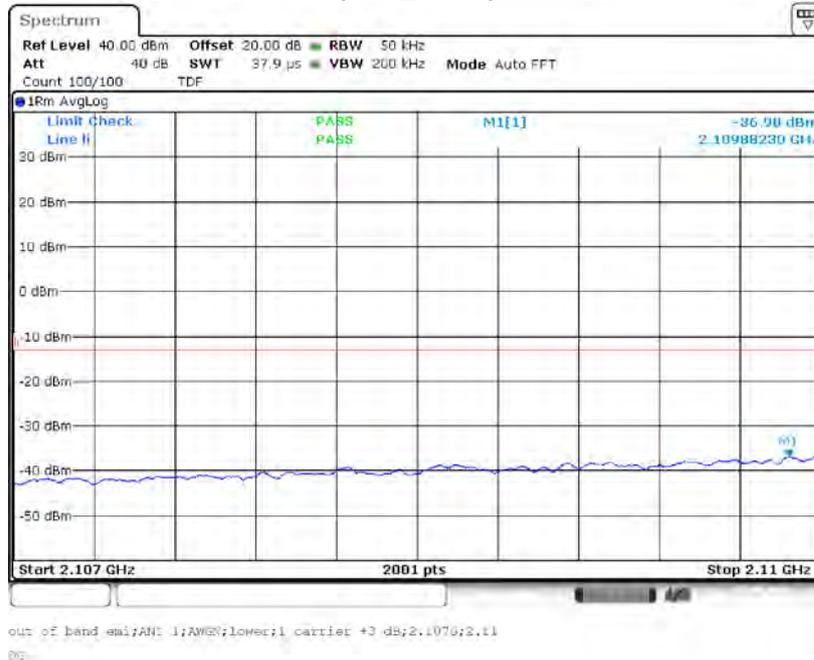

Band Edge = Lower, Frequency Band = Band 4/10/66, Number of signals = 1, Direction = RF downlink, Input Power = 0.3 dB < AGC, Signal Type = Wideband (S01\_AA01)

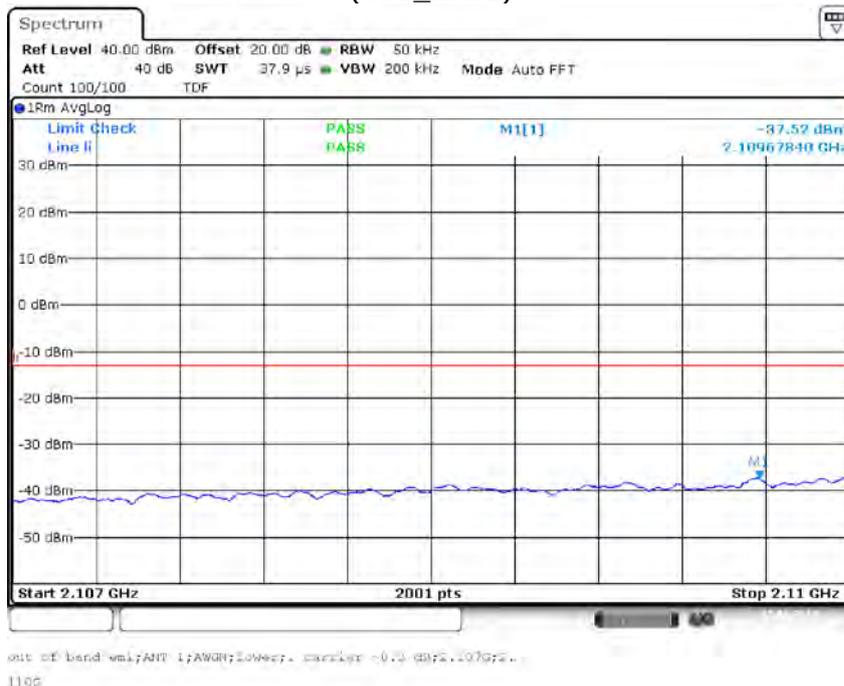

Band Edge = Lower, Frequency Band = Band 4/10/66, Number of signals = 2, Direction = RF downlink, Input Power = 3 dB > AGC, Signal Type = Wideband (S01\_AA01)

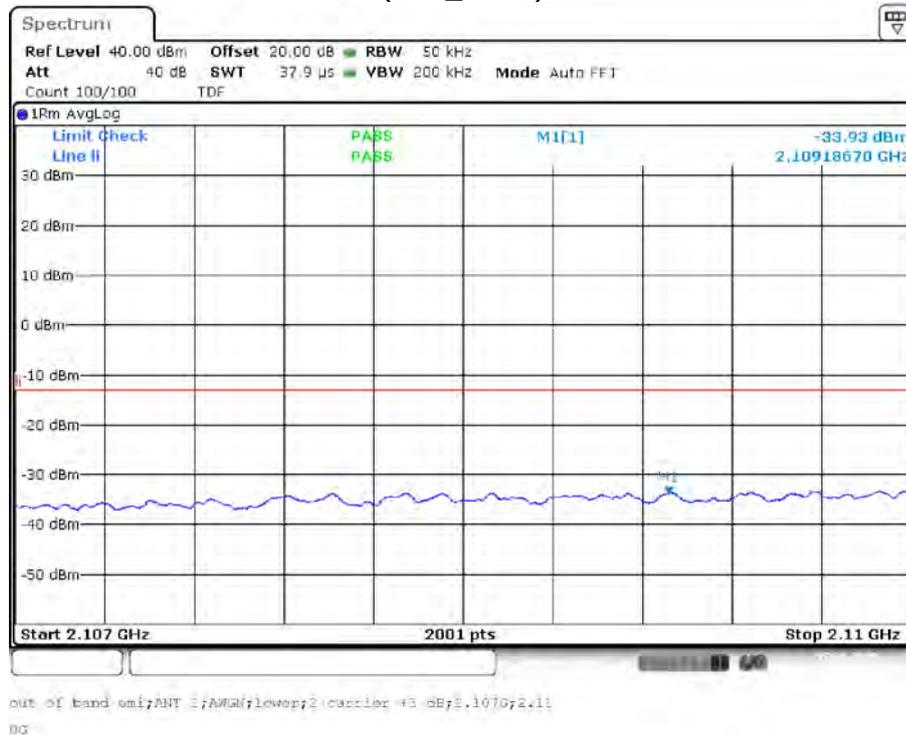

Band Edge = Lower, Frequency Band = Band 4/10/66, Number of signals = 2, Direction = RF downlink, Input Power = 0.3 dB < AGC, Signal Type = Wideband (S01\_AA01)

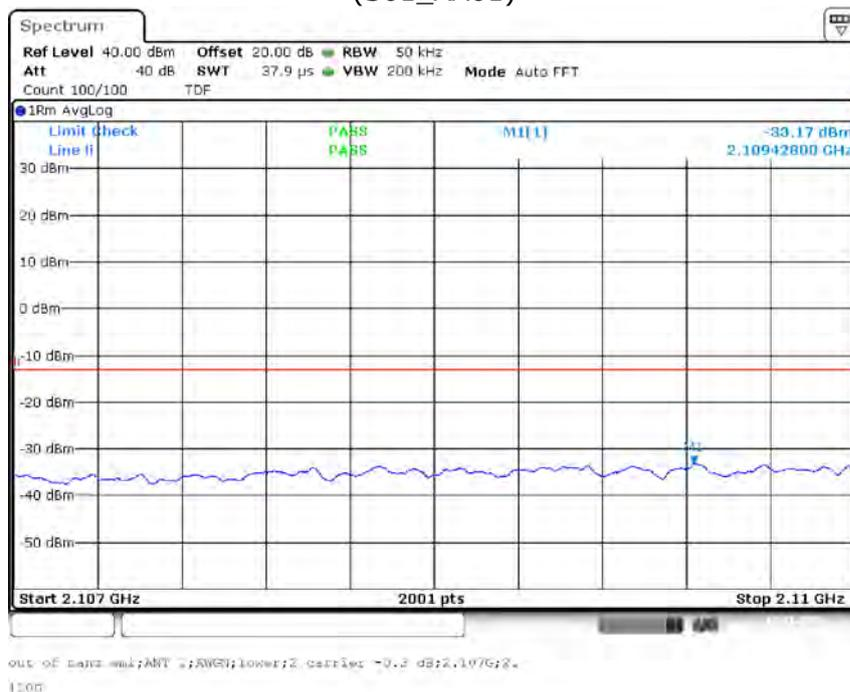

Band Edge = Upper, Frequency Band = Band 4/10/66, Number of signals = 1, Direction = RF downlink, Input Power = 3 dB > AGC, Signal Type = Wideband (S01\_AA01)

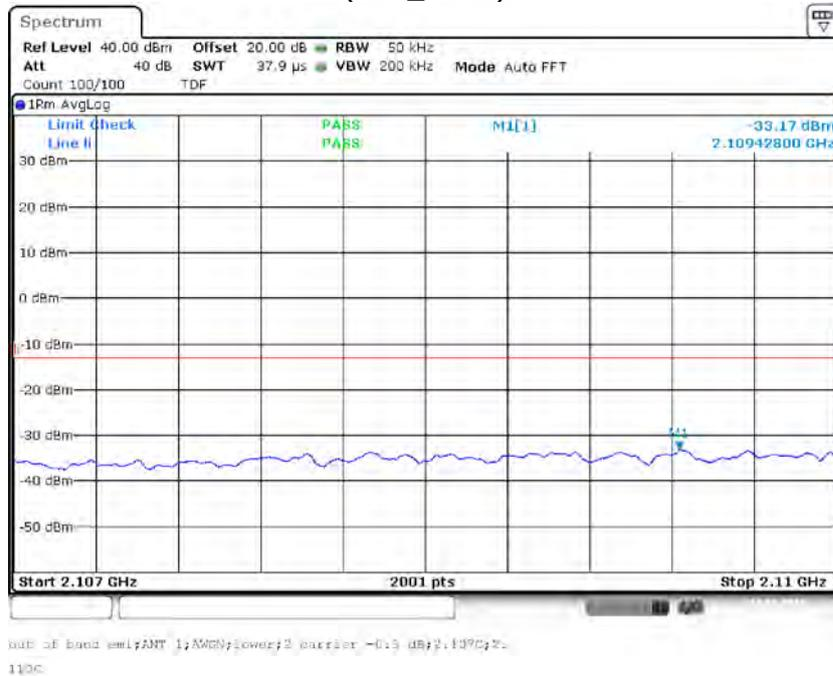

Band Edge = Upper, Frequency Band = Band 4/10/66, Number of signals = 1, Direction = RF downlink, Input Power = 0.3 dB < AGC, Signal Type = Wideband (S01\_AA01)

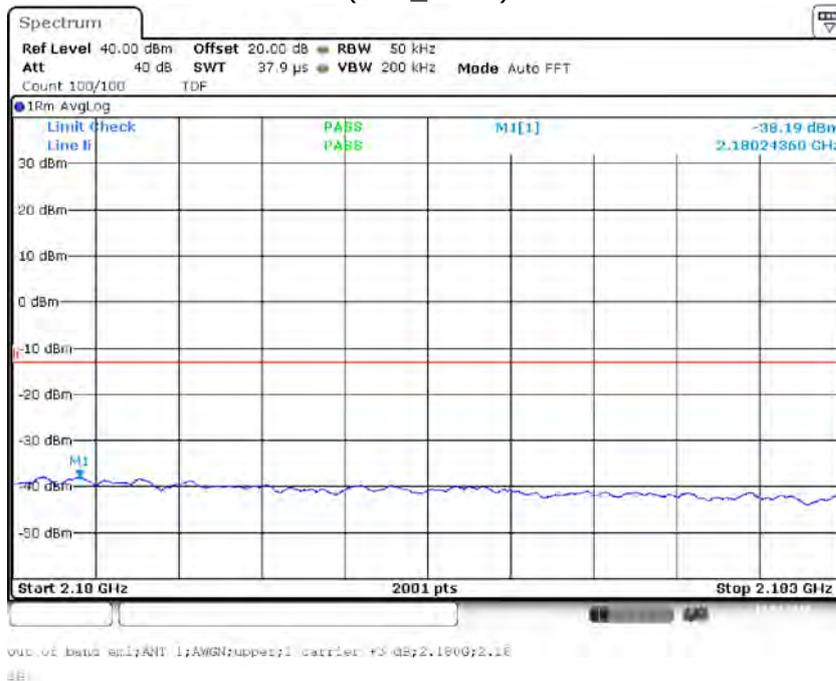

Band Edge = Upper, Frequency Band = Band 4/10/66, Number of signals = 2, Direction = RF downlink, Input Power = 3 dB > AGC, Signal Type = Wideband (S01\_AA01)

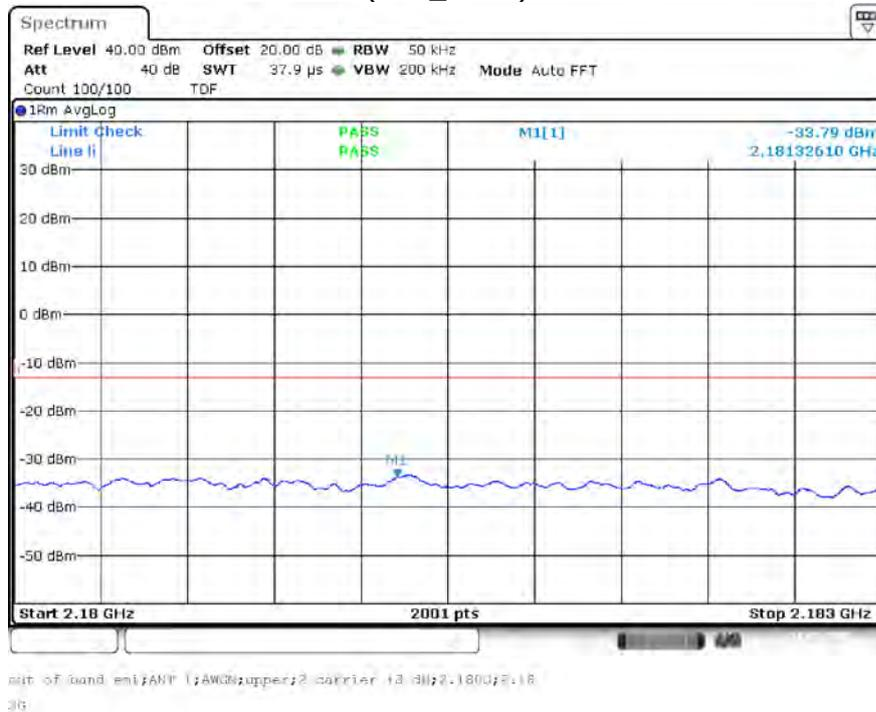

Band Edge = Upper, Frequency Band = Band 4/10/66, Number of signals = 2, Direction = RF downlink, Input Power = 0.3 dB < AGC, Signal Type = Wideband (S01\_AA01)

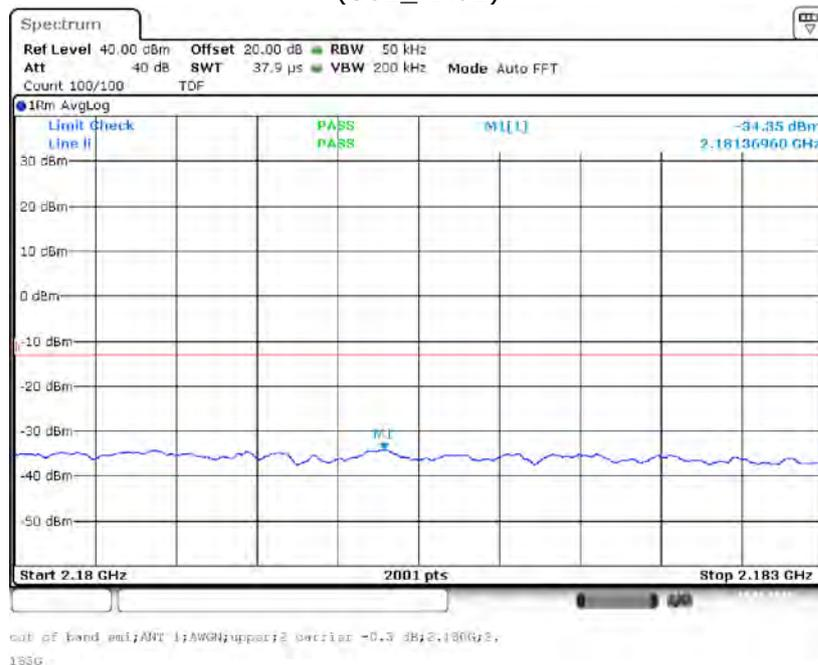



Band Edge = Lower, Frequency Band = Band 4/10/66, Number of signals = 1, Direction = RF downlink, Input Power = 3 dB > AGC, Signal Type = Narrowband (S01\_AA01)

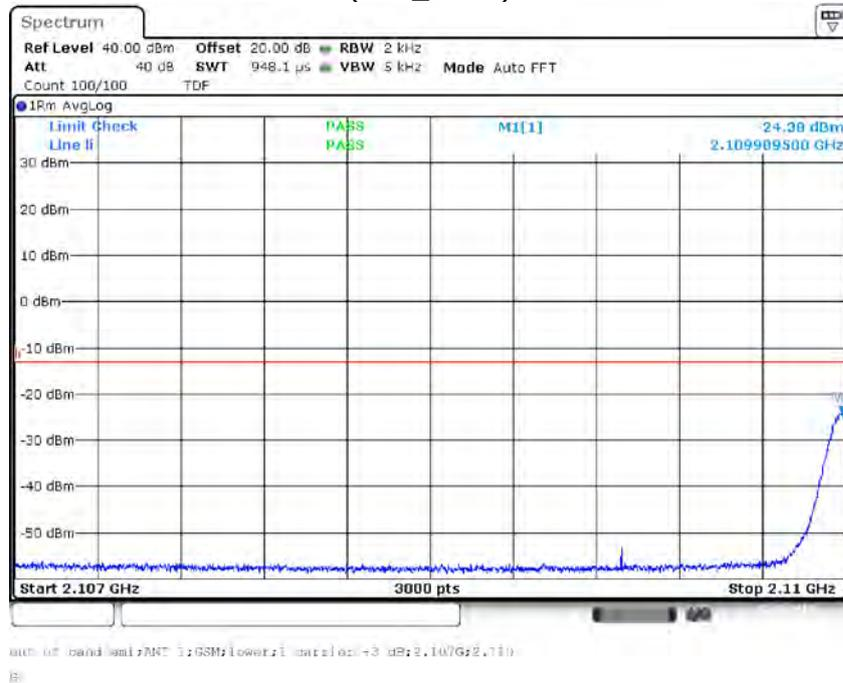

Band Edge = Lower, Frequency Band = Band 4/10/66, Number of signals = 1, Direction = RF downlink, Input Power = 0.3 dB < AGC, Signal Type = Narrowband (S01\_AA01)

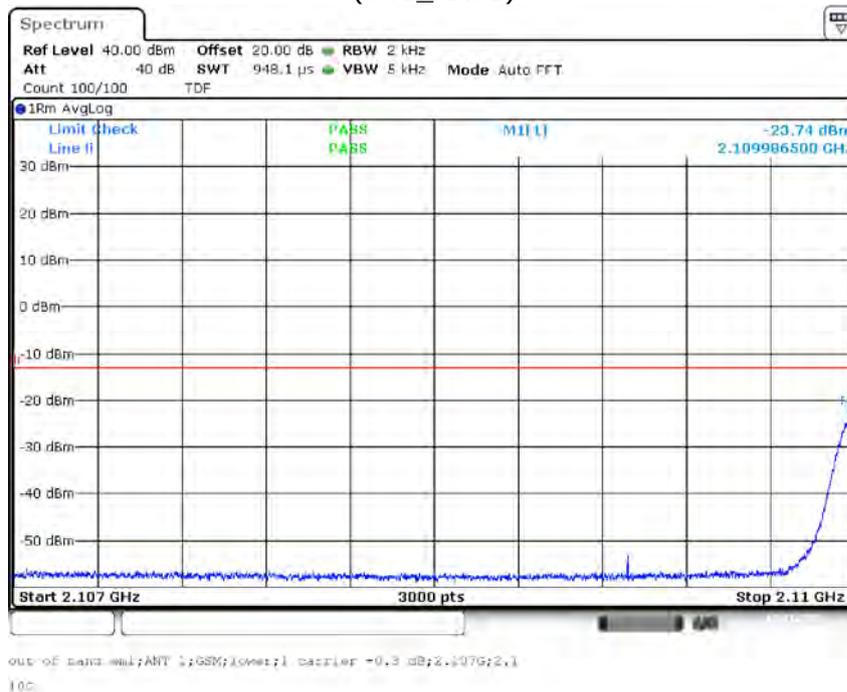

Band Edge = Lower, Frequency Band = Band 4/10/66, Number of signals = 2, Direction = RF downlink, Input Power = 3 dB > AGC, Signal Type = Narrowband (S01\_AA01)

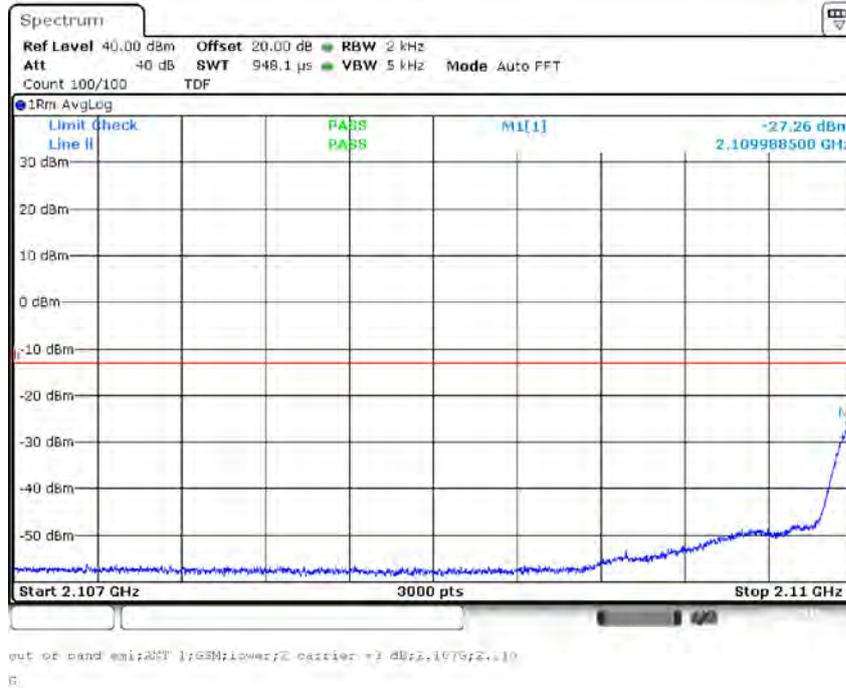

Band Edge = Lower, Frequency Band = Band 4/10/66, Number of signals = 2, Direction = RF downlink, Input Power = 0.3 dB < AGC, Signal Type = Narrowband (S01\_AA01)

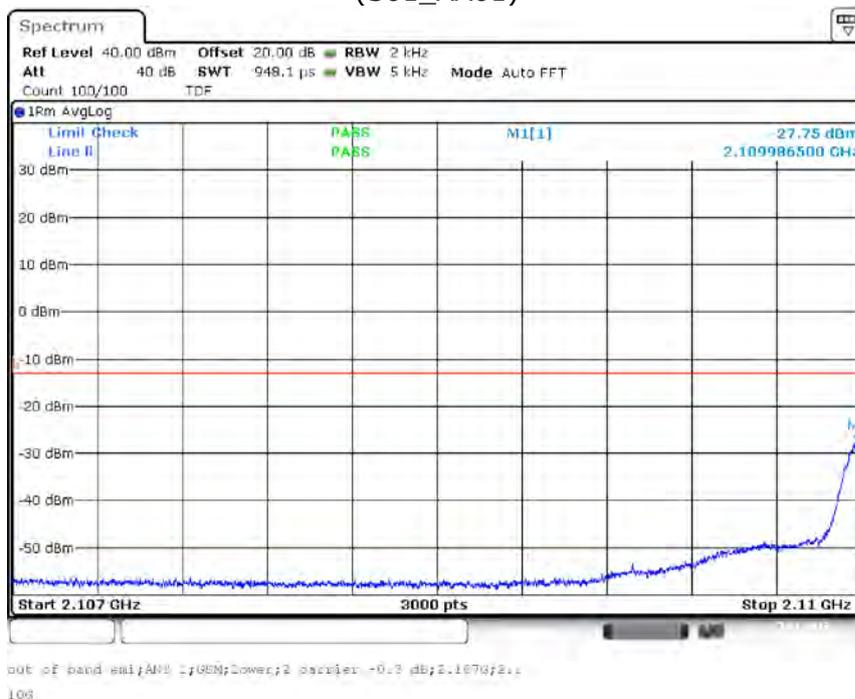

Band Edge = Upper, Frequency Band = Band 4/10/66, Number of signals = 1, Direction = RF downlink, Input Power = 3 dB > AGC, Signal Type = Narrowband (S01\_AA01)

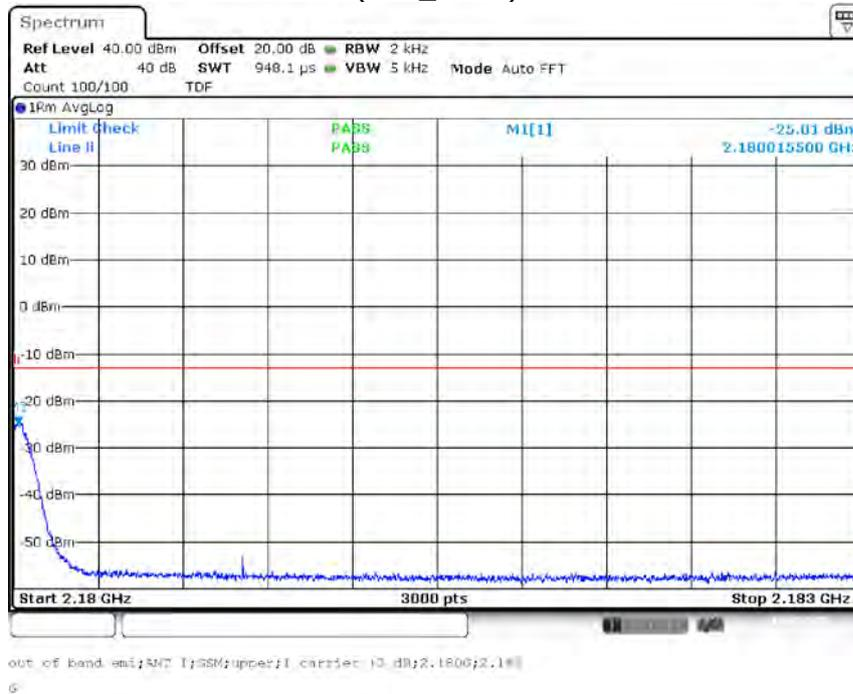

Band Edge = Upper, Frequency Band = Band 4/10/66, Number of signals = 1, Direction = RF downlink, Input Power = 0.3 dB < AGC, Signal Type = Narrowband (S01\_AA01)

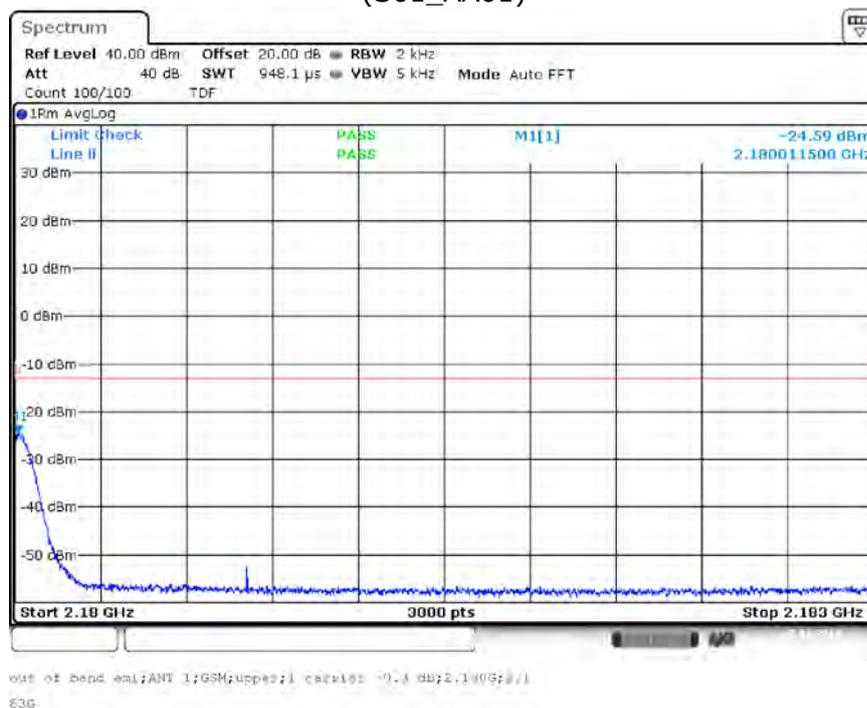

Band Edge = Upper, Frequency Band = Band 4/10/66, Number of signals = 2, Direction = RF downlink, Input Power = 0.3 dB < AGC, Signal Type = Narrowband (S01\_AA01)

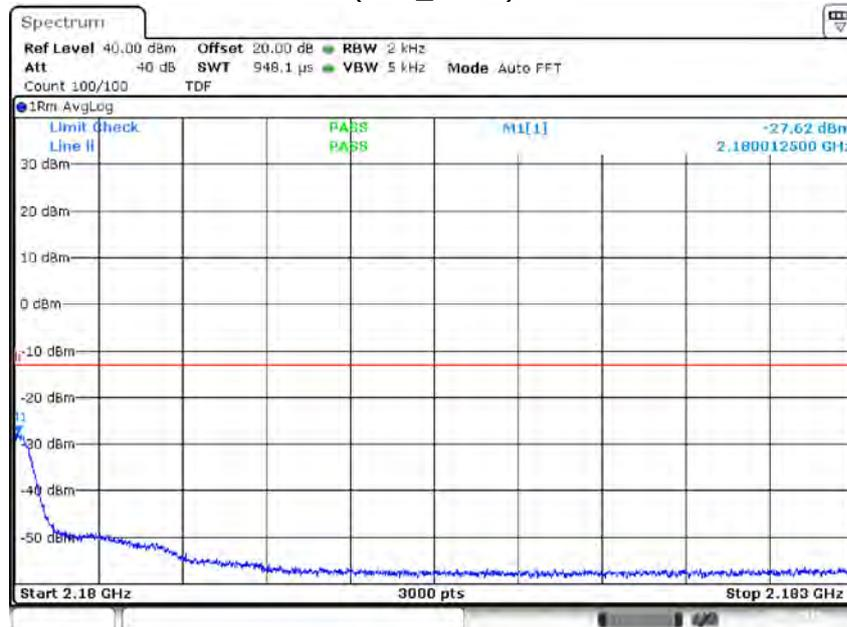

out of band emi:ANT 1;GSM;upper;2 carrier =3 dB;2.1800;2.183

Band Edge = Upper, Frequency Band = Band 4/10/66, Number of signals = 2, Direction = RF downlink, Input Power = 3 dB > AGC, Signal Type = Narrowband (S01\_AA01)

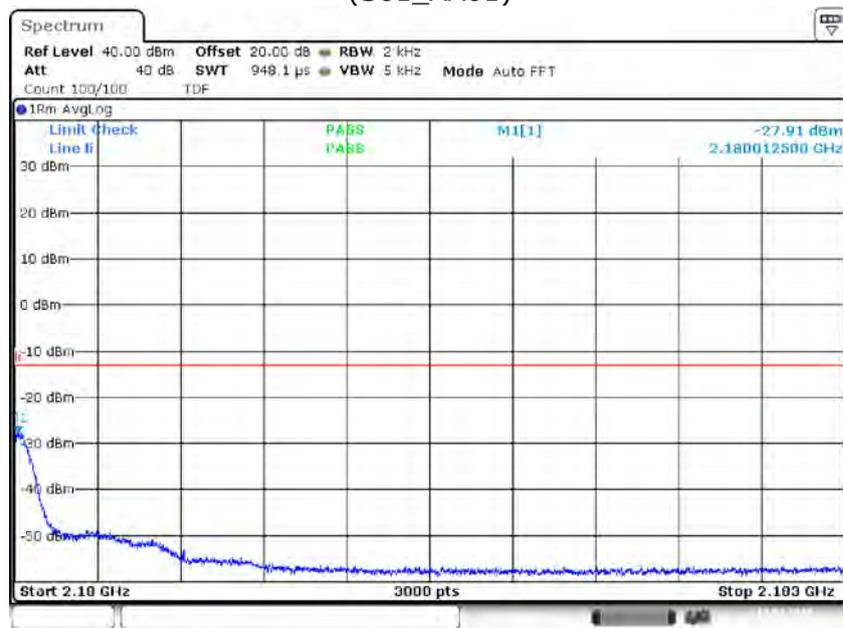

out of band emi:ANT 1;GSM;upper;2 carrier =0.3 dB;2.1800;2.183

**Module 2:**

Band Edge = Lower, Frequency Band = Band 4/10/66, Number of signals = 1, Direction = RF downlink, Input Power = 3 dB > AGC, Signal Type = Wideband (S01\_AA01)

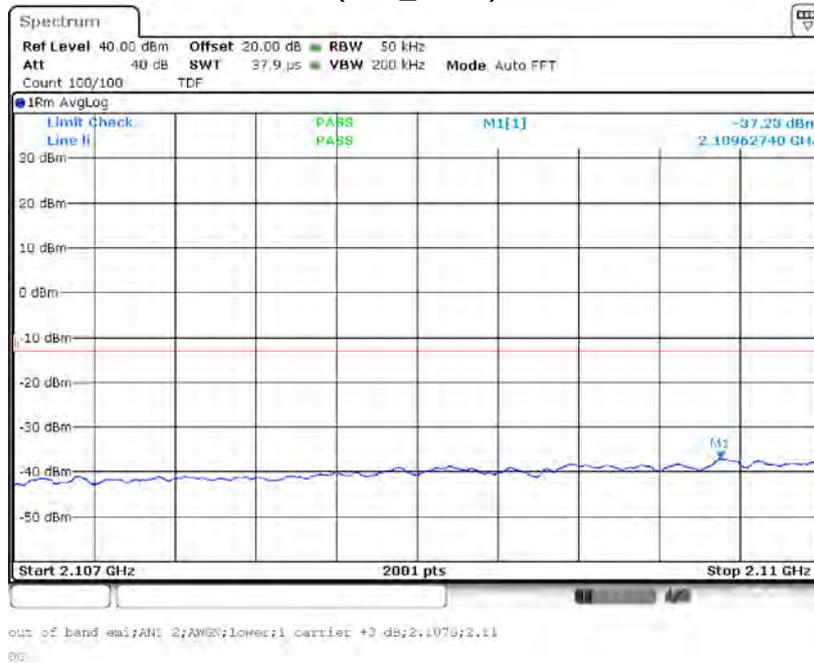

Band Edge = Lower, Frequency Band = Band 4/10/66, Number of signals = 1, Direction = RF downlink, Input Power = 0.3 dB < AGC, Signal Type = Wideband (S01\_AA01)

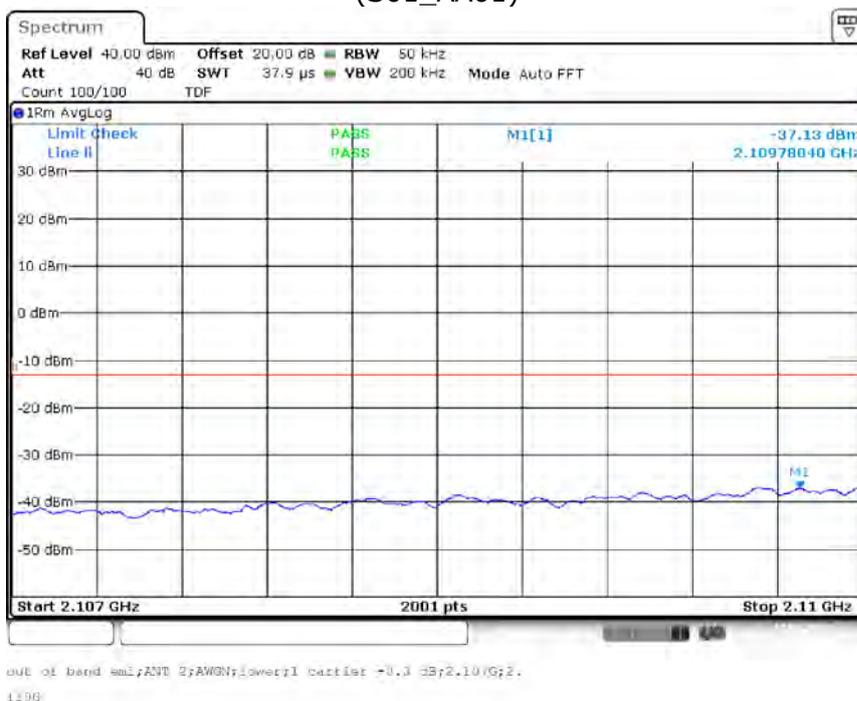

Band Edge = Lower, Frequency Band = Band 4/10/66, Number of signals = 2, Direction = RF downlink, Input Power = 3 dB > AGC, Signal Type = Wideband (S01\_AA01)

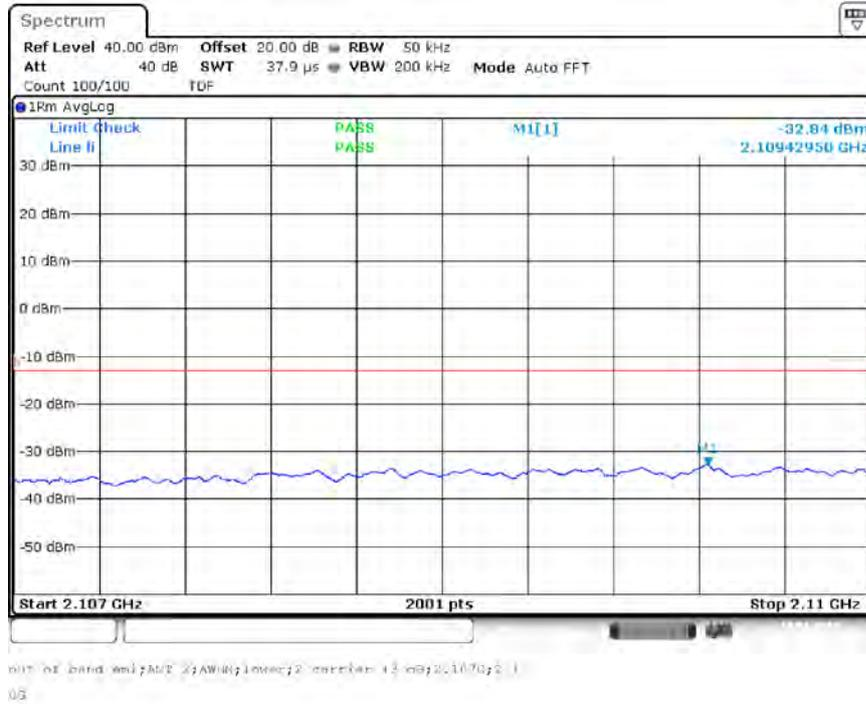

Band Edge = Lower, Frequency Band = Band 4/10/66, Number of signals = 2, Direction = RF downlink, Input Power = 0.3 dB < AGC, Signal Type = Wideband (S01\_AA01)

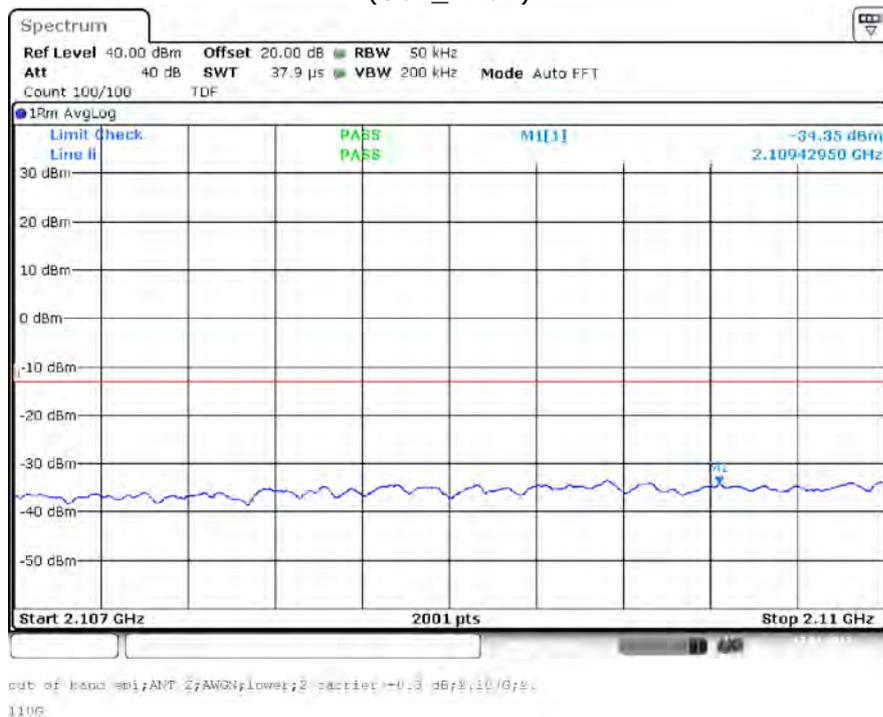



Band Edge = Upper, Frequency Band = Band 4/10/66, Number of signals = 2, Direction = RF downlink, Input Power = 3 dB > AGC, Signal Type = Wideband (S01\_AA01)

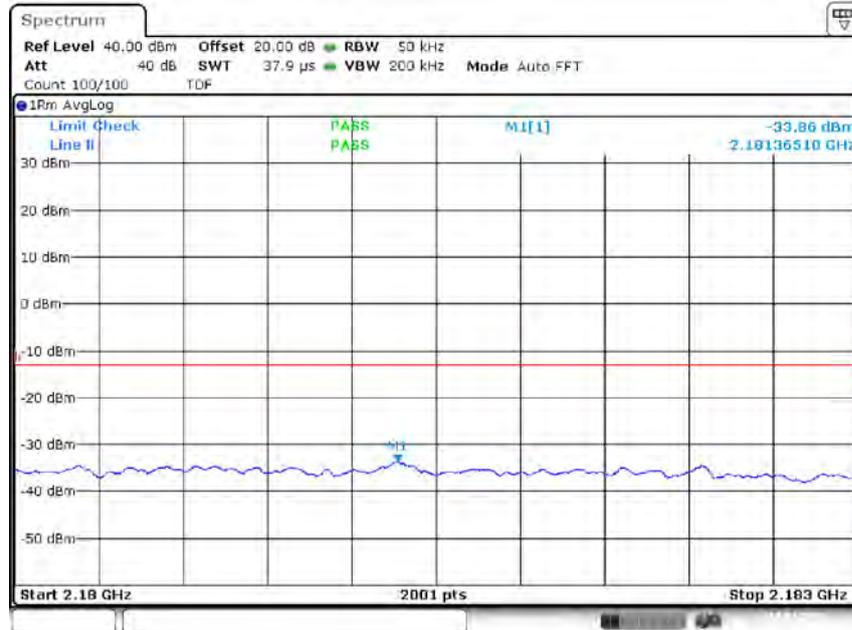

out of band emi:ANT 2:AWG1:upper:2 carrier +3 dB;2.180G;2.18  
 3G

Band Edge = Upper, Frequency Band = Band 4/10/66, Number of signals = 2, Direction = RF downlink, Input Power = 0.3 dB < AGC, Signal Type = Wideband (S01\_AA01)

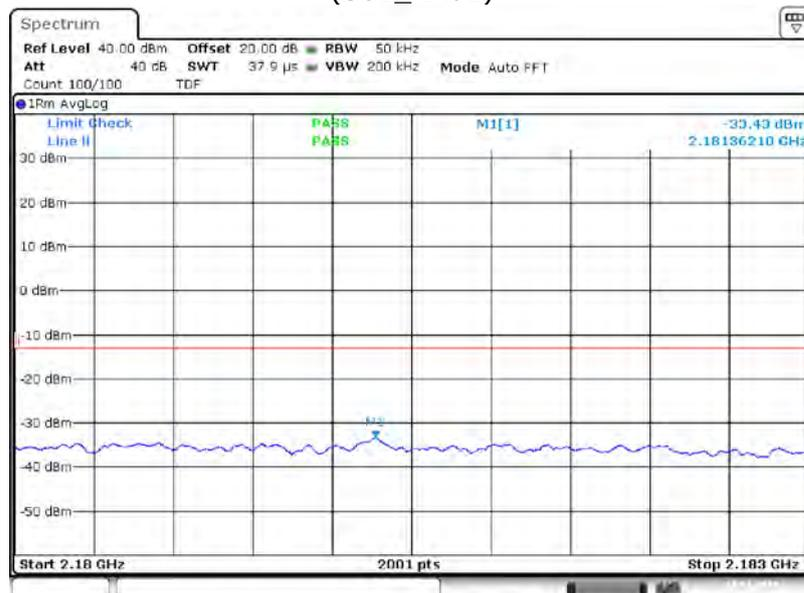

out of band emi:ANT 2:AWG1:upper:2 carrier -0.3 dB;2.180G;2.  
 183G



Band Edge = Lower, Frequency Band = Band 4/10/66, Number of signals = 1, Direction = RF downlink, Input Power = 3 dB > AGC, Signal Type = Narrowband (S01\_AA01)

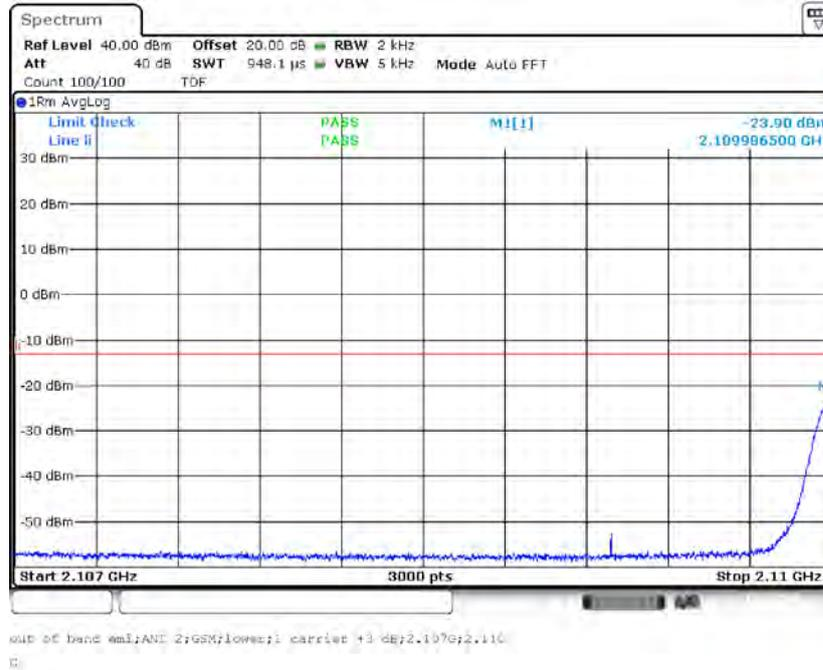

Band Edge = Lower, Frequency Band = Band 4/10/66, Number of signals = 1, Direction = RF downlink, Input Power = 0.3 dB < AGC, Signal Type = Narrowband (S01\_AA01)

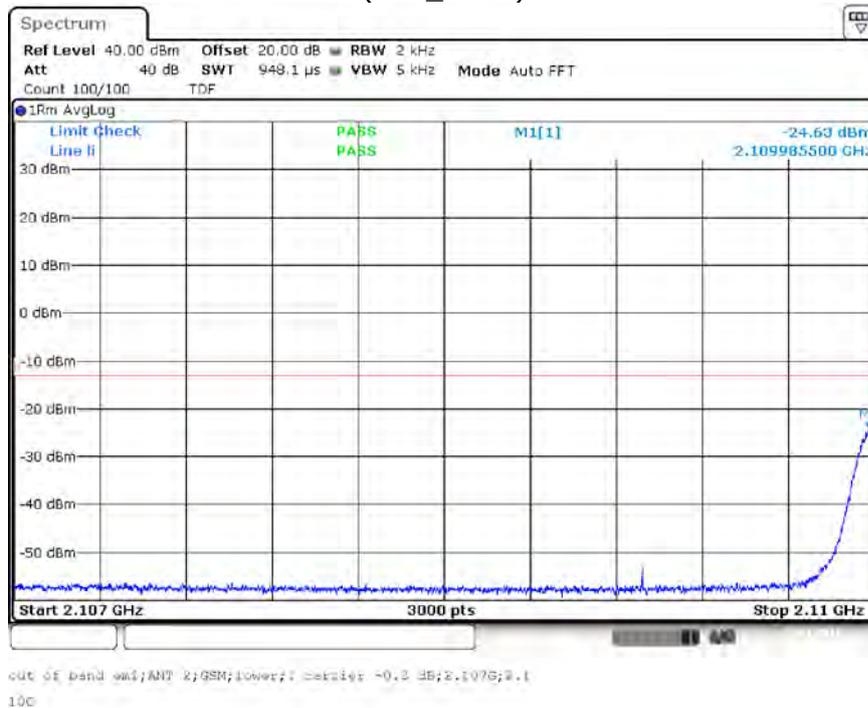

Band Edge = Lower, Frequency Band = Band 4/10/66, Number of signals = 2, Direction = RF downlink, Input Power = 3 dB > AGC, Signal Type = Narrowband (S01\_AA01)

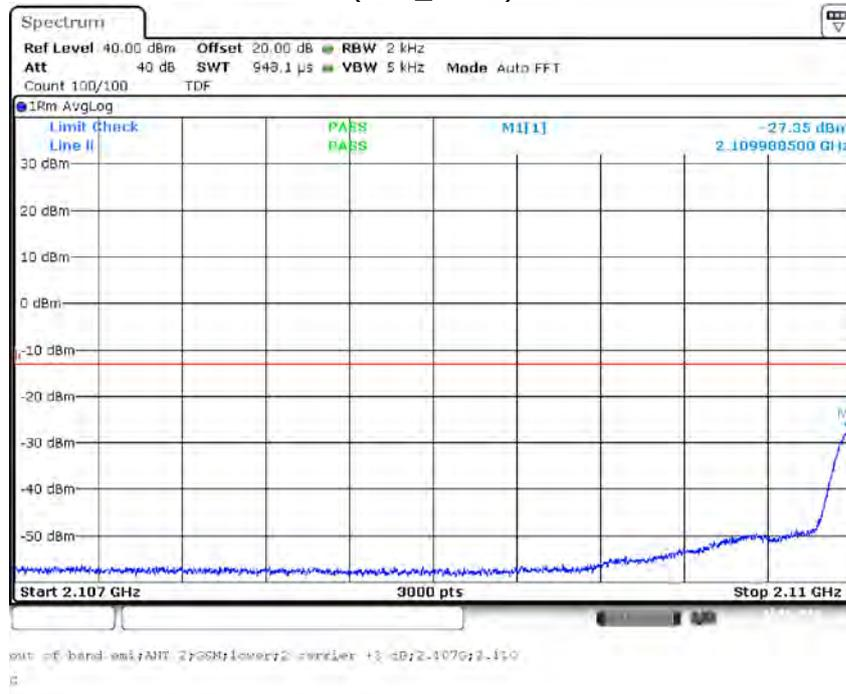

Band Edge = Lower, Frequency Band = Band 4/10/66, Number of signals = 2, Direction = RF downlink, Input Power = 0.3 dB < AGC, Signal Type = Narrowband (S01\_AA01)

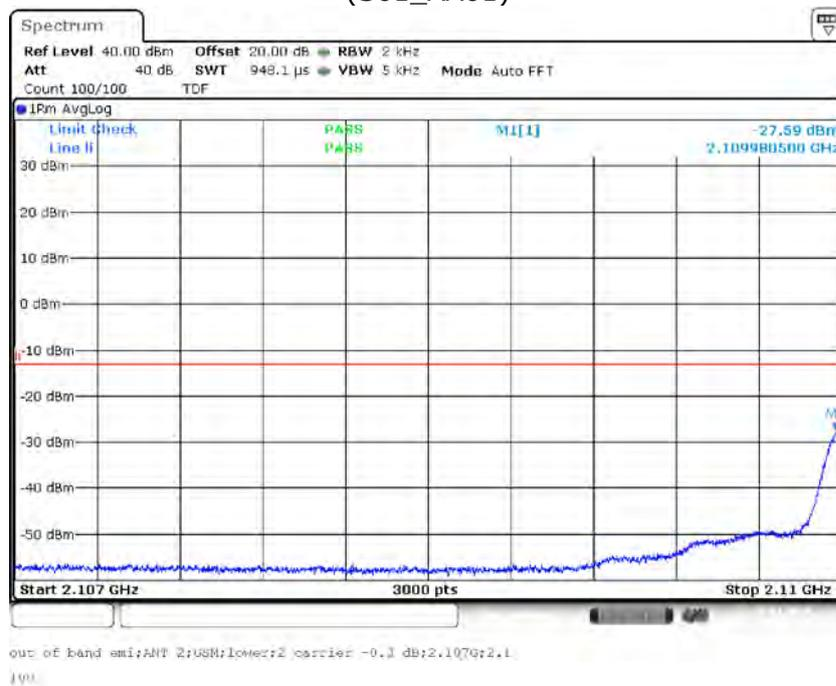

Band Edge = Upper, Frequency Band = Band 4/10/66, Number of signals = 1, Direction = RF downlink, Input Power = 3 dB > AGC, Signal Type = Narrowband (S01\_AA01)

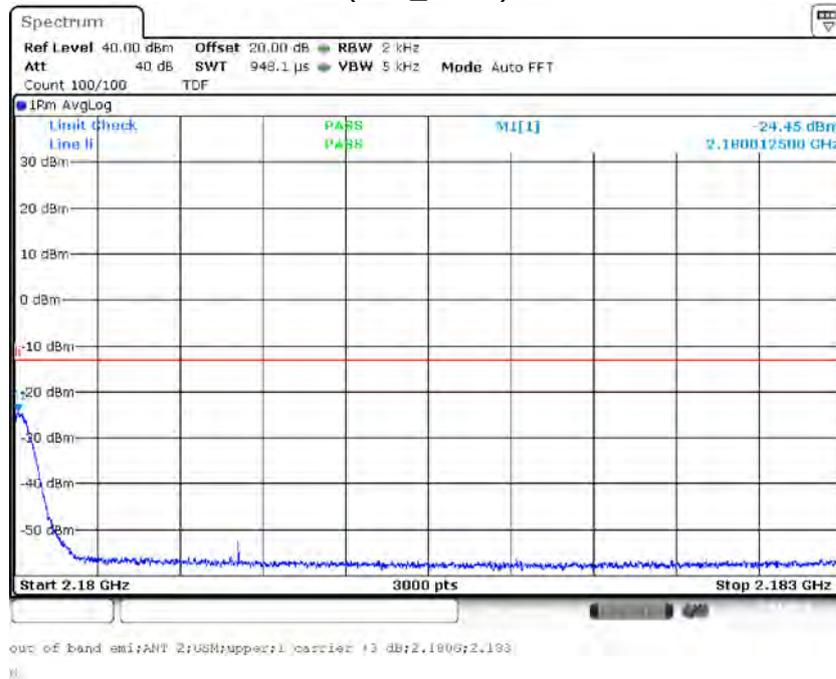

Band Edge = Upper, Frequency Band = Band 4/10/66, Number of signals = 1, Direction = RF downlink, Input Power = 0.3 dB < AGC, Signal Type = Narrowband (S01\_AA01)

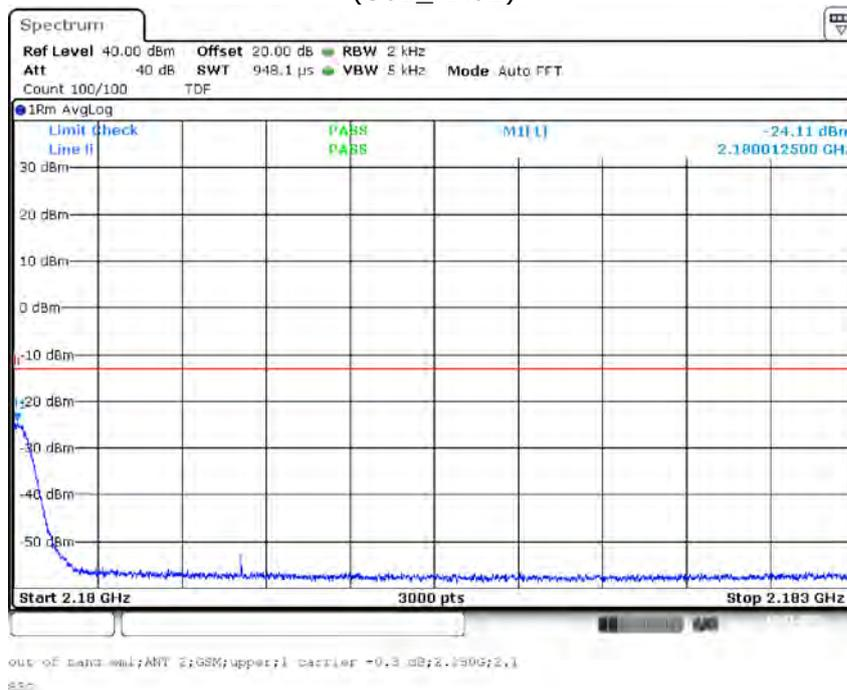

Band Edge = Upper, Frequency Band = Band 4/10/66, Number of signals = 2, Direction = RF downlink, Input Power = 0.3 dB < AGC, Signal Type = Narrowband (S01\_AA01)

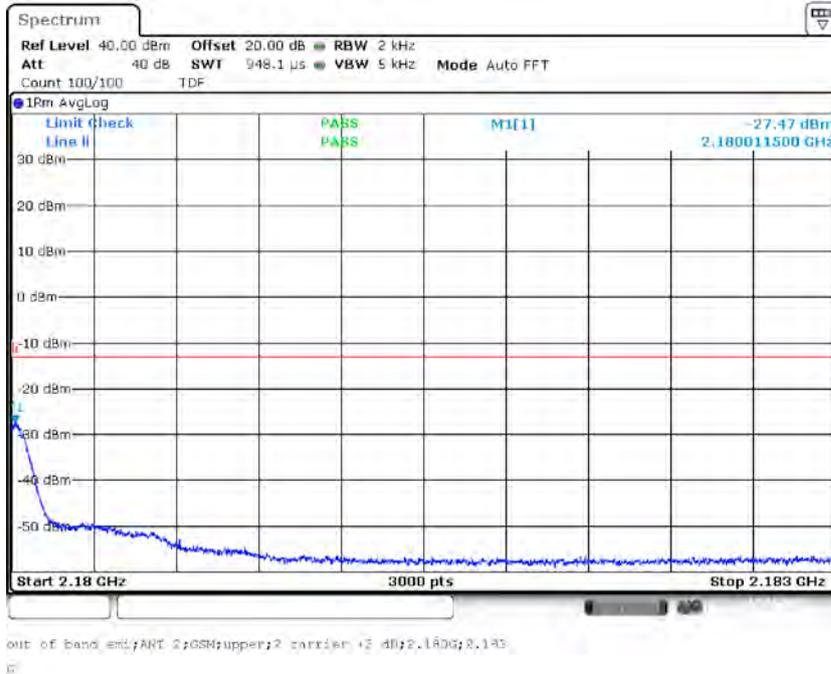

Band Edge = Upper, Frequency Band = Band 4/10/66, Number of signals = 2, Direction = RF downlink, Input Power = 3 dB > AGC, Signal Type = Narrowband (S01\_AA01)

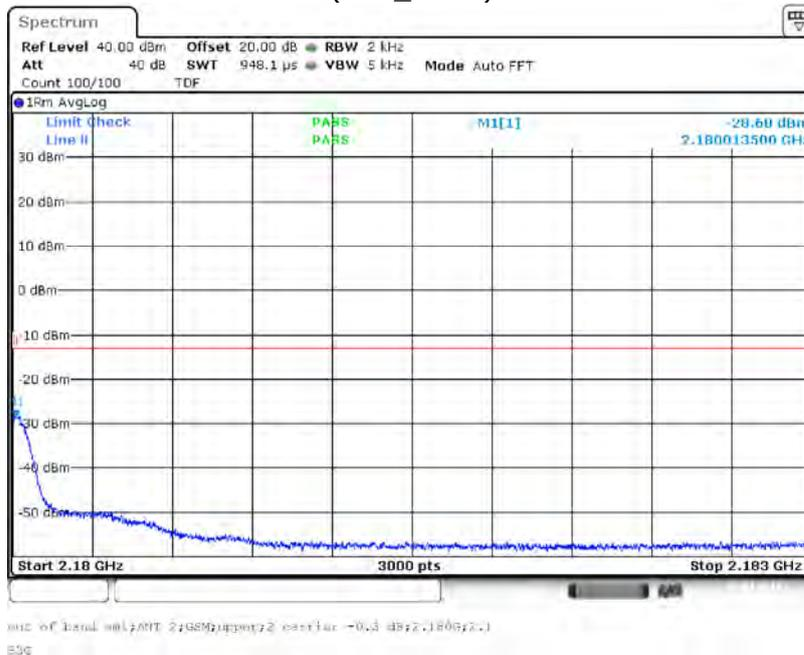

#### 4.5.5 TEST EQUIPMENT USED

- FCC Conducted Base Station / Repeater

## 4.6 OUT-OF-BAND REJECTION

Standard FCC Part 27

**The test was performed according to:**  
ANSI C63.26

### 4.6.1 TEST DESCRIPTION

This test case is intended to demonstrate compliance to the out-of-band rejection test case for industrial signal boosters.

The EUT was connected to the test setup according to the following diagram:

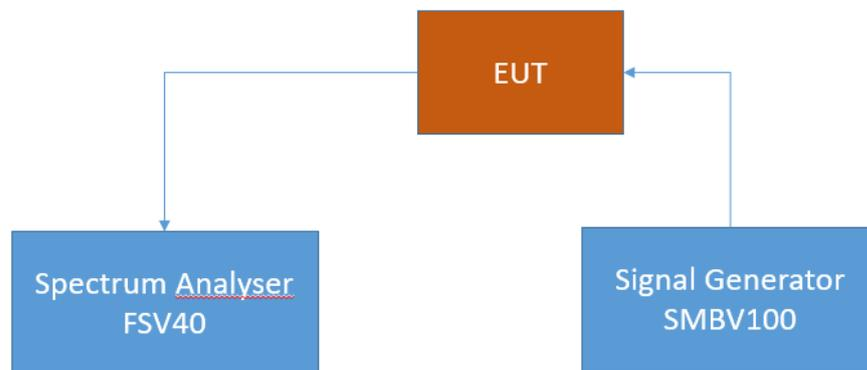

FCC Part 22/24/27/90 Industrial signal booster – Test Setup; Out-of-band rejection

The attenuation of the measuring and stimulus path are known for each measured frequency and are considered.

The Spectrum Analyzer settings can be directly found in the measurement diagrams.

### 4.6.2 TEST REQUIREMENTS / LIMITS

For this test case exists no applicable limit

### 4.6.3 TEST PROTOCOL

<b>Band 4/10/66, downlink [Module 1]</b>				
<b>Highest Power Frequency [MHz]</b>	<b>Output Power [dBm]</b>	<b>Lower Highest Power -20 dB Frequency [MHz]</b>	<b>Upper Highest Power -20 dB Frequency [MHz]</b>	<b>20 dB Bandwidth [kHz]</b>
2138.600	20.940	2100.290	2190.520	90230.0

<b>Band 4/10/66, downlink [Module 2]</b>				
<b>Highest Power Frequency [MHz]</b>	<b>Output Power [dBm]</b>	<b>Lower Highest Power -20 dB Frequency [MHz]</b>	<b>Upper Highest Power -20 dB Frequency [MHz]</b>	<b>20 dB Bandwidth [kHz]</b>
2140.300	21.250	2099.660	2190.100	90440.0

Remark: Please see next sub-clause for the measurement plot.

#### 4.6.4 MEASUREMENT PLOT (SHOWING THE HIGHEST VALUE, "WORST CASE")

##### Module 1:

Frequency Band = Band 4/10/66, Direction = RF downlink (S01\_AA01)

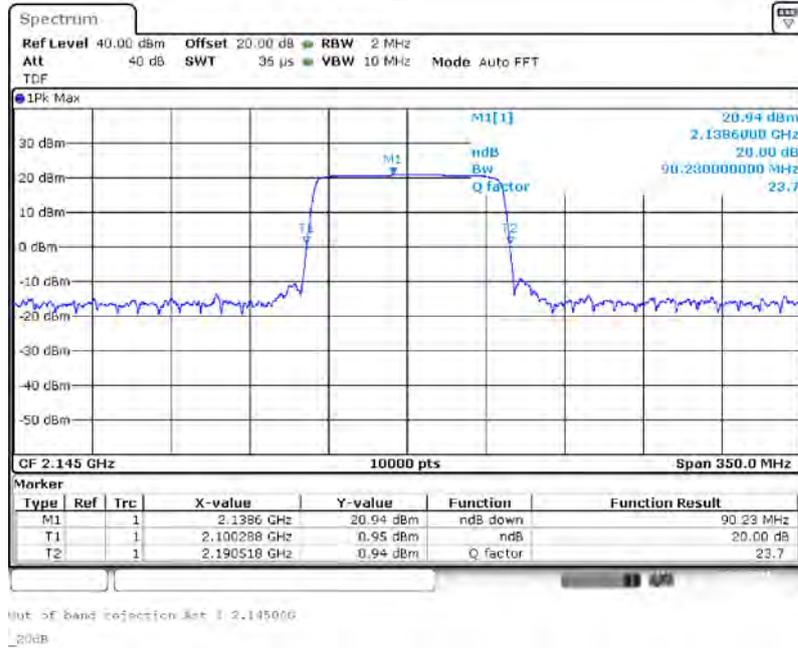

##### Module 2:

Frequency Band = Band 4/10/66, Direction = RF downlink (S01\_AA01)

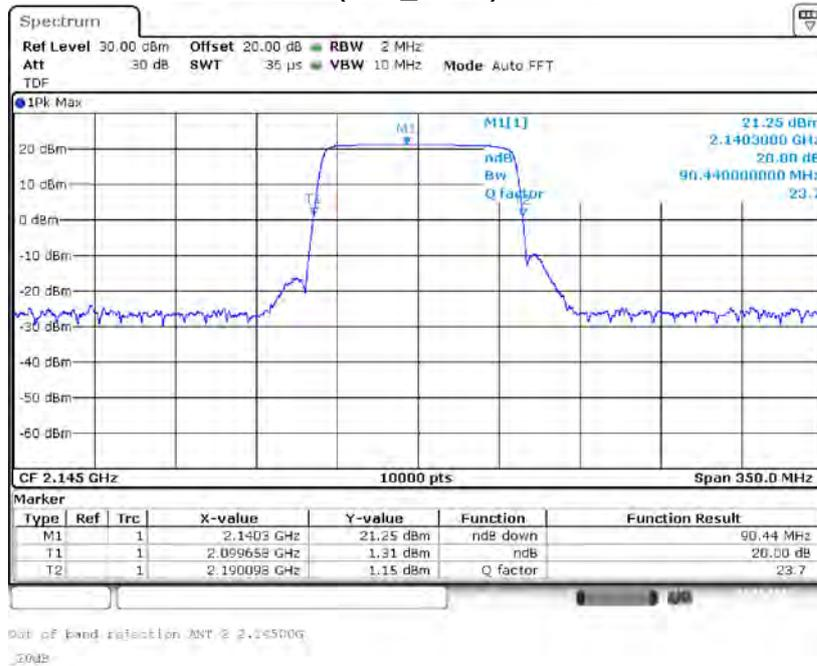

#### 4.6.5 TEST EQUIPMENT USED

- FCC Conducted Base Station / Repeater

## 4.7 FIELD STRENGTH OF SPURIOUS RADIATION

Standard FCC Part 27, §24.53

The test was performed according to:  
ANSI C63.26

### 4.7.1 TEST DESCRIPTION

This test case is intended to demonstrate compliance to the applicable radiated spurious emission measurements per § 2.1053

The EUT was connected to the test setup according to the following diagram:

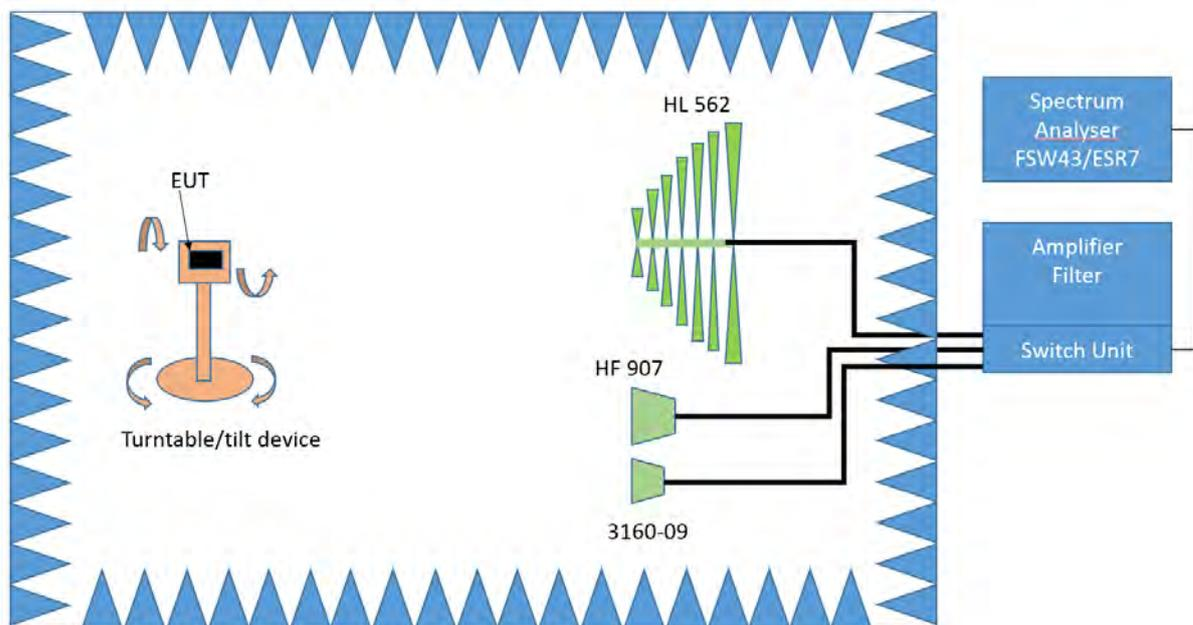

FCC Part 22/24/27/90; Industrial Signal Booster – Test Setup; Field Strength of Spurious Radiation

The test set-up was made in accordance to the general provisions of ANSI C63.4 in a typical installation configuration. The Equipment Under Test (EUT) was set up on a non-conductive table 1.0 x 2.0 m<sup>2</sup> in the semi-anechoic chamber. The influence of the EUT support table that is used between 30–1000 MHz was evaluated.

The measurement procedure is implemented into the EMI test software EMC32 from R&S. Exploratory tests are performed at 3 orthogonal axes to determine the worst-case orientation of a body-worn or handheld EUT. The final test on all kind of EUTs is also performed at 3 axes. A pre-check is performed while the EUT is powered from a DC power source.

### 1. Measurement above 30 MHz and up to 1 GHz

#### Step 1: Preliminary scan

This is a preliminary test to identify the highest amplitudes relative to the limit.

Settings for step 1:

- Antenna distance: 3 m
- Detector: Peak-Maxhold / Quasipeak (FFT-based)
- Frequency range: 30 – 1000 MHz



- Frequency steps: 30 kHz
- IF-Bandwidth: 120 kHz
- Measuring time / Frequency step: 100 ms
- Turntable angle range:  $-180^{\circ}$  to  $90^{\circ}$
- Turntable step size:  $90^{\circ}$
- Height variation range: 1 – 3 m
- Height variation step size: 2 m
- Polarisation: Horizontal + Vertical

Intention of this step is, to determine the radiated EMI-profile of the EUT. Afterwards the relevant emissions for the final measurement are identified.

### **Step 2: Adjustment measurement**

In this step the accuracy of the turntable azimuth and antenna height will be improved. This is necessary to find out the maximum value of every frequency.

For each frequency, which was determined the turntable azimuth and antenna height will be adjusted. The turntable azimuth will slowly vary by  $\pm 45^{\circ}$  around this value. During this action, the value of emission is continuously measured. The turntable azimuth at the highest emission will be recorded and adjusted. In this position, the antenna height will also slowly vary by  $\pm 100$  cm around the antenna height determined. During this action, the value of emission is also continuously measured. The antenna height of the highest emission will also be recorded and adjusted.

- Detector: Peak – Maxhold
- Measured frequencies: in step 1 determined frequencies
- IF – Bandwidth: 120 kHz
- Measuring time: 100 ms
- Turntable angle range:  $\pm 45^{\circ}$  around the determined value
- Height variation range:  $\pm 100$  cm around the determined value
- Antenna Polarisation: max. value determined in step 1

### **Step 3: Final measurement with QP detector**

With the settings determined in step 3, the final measurement will be performed:

EMI receiver settings for step 4:

- Detector: Quasi-Peak ( $< 1$  GHz)
- Measured frequencies: in step 1 determined frequencies
- IF – Bandwidth: 120 kHz
- Measuring time: 1 s

After the measurement a plot will be generated which contains a diagram with the results of the preliminary scan and a chart with the frequencies and values of the results of the final measurement.

## **3. Measurement above 1 GHz**

The following modifications apply to the measurement procedure for the frequency range above 1 GHz:

### **Step 1:**

The Equipment Under Test (EUT) was set up on a non-conductive support (tilt device) at 1.5 m height in the fully-anechoic chamber.

All steps were performed with one height (1.5 m) of the receiving antenna only.

The EUT is turned during the preliminary measurement across the elevation axis, with a step size of  $90^{\circ}$ .

The turn table step size (azimuth angle) for the preliminary measurement is  $45^{\circ}$ .

### **Step 2:**

Due to the fact, that in this frequency range the test is performed in a fully anechoic room, the height scan of the receiving antenna instep 2 is omitted. Instead of this, a maximum search with a step size  $\pm 45^{\circ}$  for the elevation axis is performed.

The turn table azimuth will slowly vary by  $\pm 22.5^\circ$ .

The elevation angle will slowly vary by  $\pm 45^\circ$

EMI receiver settings (for all steps):

- Detector: Peak, Average
- IF Bandwidth = 1 MHz

**Step 3:**

Spectrum analyser settings for step 3:

- Detector: Peak / Average
- Measured frequencies: in step 1 determined frequencies
- IF – Bandwidth: 1 MHz
- Measuring time: 1 s

## 4.7.2 TEST REQUIREMENTS / LIMITS

### **FCC Part 2.1053; Measurement required: Field strength of spurious radiation:**

Measurements shall be made to detect spurious emissions that may be radiated directly from the cabinet, control circuits, power leads, or intermediate circuit elements under normal conditions of installation and operation. Curves or equivalent data shall be supplied showing the magnitude of each harmonic and other spurious emission. For this test, single sideband, independent sideband, and controlled carrier transmitters shall be modulated under the conditions specified in paragraph (c) of §2.1049, as appropriate.

### **Part 27; Miscellaneous Wireless Communication Services**

#### **Subpart C – Technical standards**

#### **§27.53 – Emission limits**

##### **Band 13**

(c) For operations in the 746-758 MHz band and the 776-788 MHz band, the power of any emission outside the licensee's frequency band(s) of operation shall be attenuated below the transmitter power (P) within the licensed band(s) of operation, measured in watts, in accordance with the following:

(1) On any frequency outside the 746-758 MHz band, the power of any emission shall be attenuated outside the band below the transmitter power (P) by at least  $43 + 10 \log (P)$  dB;

(2) On any frequency outside the 776-788 MHz band, the power of any emission shall be attenuated outside the band below the transmitter power (P) by at least  $43 + 10 \log (P)$  dB;

(3) On all frequencies between 763-775 MHz and 793-805 MHz, by a factor not less than  $76 + 10 \log (P)$  dB in a 6.25 kHz band segment, for base and fixed stations;

(4) On all frequencies between 763-775 MHz and 793-805 MHz, by a factor not less than  $65 + 10 \log (P)$  dB in a 6.25 kHz band segment, for mobile and portable stations;

(5) Compliance with the provisions of paragraphs (c)(1) and (c)(2) of this section is based on the use of measurement instrumentation employing a resolution bandwidth of 100 kHz or greater. However, in the 100 kHz bands immediately outside and adjacent to the frequency block, a resolution bandwidth of at least 30 kHz may be employed;

(f) For operations in the 746-758 MHz, 775-788 MHz, and 805-806 MHz bands, emissions in the band 1559-1610 MHz shall be limited to  $-70$  dBW/MHz equivalent isotropically radiated power (EIRP) for wideband signals, and  $-80$  dBW EIRP for discrete emissions of less than 700 Hz bandwidth. For the purpose of equipment authorization, a transmitter shall be tested with

an antenna that is representative of the type that will be used with the equipment in normal operation.

(6) Compliance with the provisions of paragraphs (c)(3) and (c)(4) of this section is based on the use of measurement instrumentation such that the reading taken with any resolution bandwidth setting should be adjusted to indicate spectral energy in a 6.25 kHz segment.

#### **Band 12:**

(g) For operations in the 600 MHz band and the 698-746 MHz band, the power of any emission outside a licensee's frequency band(s) of operation shall be attenuated below the transmitter power (P) within the licensed band(s) of operation, measured in watts, by at least  $43 + 10 \log(P)$  dB. Compliance with this provision is based on the use of measurement instrumentation employing a resolution bandwidth of 100 kilohertz or greater. However, in the 100 kilohertz bands immediately outside and adjacent to a licensee's frequency block, a resolution bandwidth of at least 30 kHz may be employed.

#### **Band 4:**

(h) *AWS emission limits—(1) General protection levels.* Except as otherwise specified below, for operations in the 1695-1710 MHz, 1710-1755 MHz, 1755-1780 MHz, 1915-1920 MHz, 1995-2000 MHz, 2000-2020 MHz, 2110-2155 MHz, 2155-2180 MHz, and 2180-2200 bands, the power of any emission outside a licensee's frequency block shall be attenuated below the transmitter power (P) in watts by at least  $43 + 10 \log_{10}(P)$  dB.

#### **RSS-130; 4.6 Transmitter Unwanted Emissions**

4.6.1 The power of any unwanted emissions in any 100 kHz bandwidth on any frequency outside the frequency range(s) within which the equipment is designed to operate shall be attenuated below the transmitter power, P (dBW), by at least  $43 + 10 \log_{10} p$  (watts), dB. However, in the 100 kHz band immediately outside the equipment's operating frequency range, a resolution bandwidth of 30 kHz may be employed.

4.6.2 In addition to the limit outlined in Section 4.6.1 above, equipment operating in the frequency bands 746-756 MHz and 777-787 MHz shall also comply with the following restrictions:

- (a) The power of any unwanted emissions in any 6.25 kHz bandwidth for all frequencies between 763-775 MHz and 793-806 MHz shall be attenuated below the transmitter power, P (dBW), by at least:
  - (i)  $76 + 10 \log_{10} p$  (watts), dB, for base and fixed equipment, and
  - (ii)  $65 + 10 \log_{10} p$  (watts), dB, for mobile and portable equipment.
- (b) The e.i.r.p. in the band 1559-1610 MHz shall not exceed  $-70$  dBW/MHz for wideband signal and  $-80$  dBW for discrete emission with bandwidth less than 700 Hz.

**RSS-139; 6.6 Transmitter Unwanted Emissions**

Equipment shall comply with the limits in (i) and (ii) below.

- i. In the first 1.0 MHz bands immediately outside and adjacent to the equipment’s smallest operating frequency block, which can contain the equipment’s occupied bandwidth, the emission power per any 1% of the emission bandwidth shall be attenuated below the transmitter output power P (in dBW) by at least  $43 + 10 \log_{10} p$  (watts) dB.
- ii. After the first 1.0 MHz outside the equipment’s smallest operating frequency block, which can contain the equipment’s occupied bandwidth, the emission power in any 1 MHz bandwidth shall be attenuated below the transmitter output power P (in dBW) by at least  $43 + 10 \log_{10} p$  (watts) dB.

**4.7.3 TEST PROTOCOL**

Band 4/10/66, downlink [Module 1 &2]							
Spurious Freq. [MHz]	Spurious Level [dBm]	Pin Module 1 [dBm]	Pin Module 2 [dBm]	Detector	RBW [kHz]	Limit [dBm]	Margin to Limit [dB]
-	-	-27.9	-27.9	RMS	100	-13.0	- - -
-	-	-27.9	-27.9	RMS	100	-13.0	- - -
-	-	-27.9	-27.9	RMS	100	-13.0	- - -
-	-	-27.9	-27.9	RMS	100	-13.0	- - -
-	-	-27.9	-27.9	RMS	100	-13.0	- - -

Remark: Please see next sub-clause for the measurement plot.  
 Both modules were transmitting simultaneously  
 The three required test frequencies (low, mid, high) were injected simultaneously conducted into the EUT.  
 The RF output ports were terminated with 50 Ohm  
 Pin: The composite power of all three channels.

#### 4.7.4 MEASUREMENT PLOT (SHOWING THE HIGHEST VALUE, "WORST CASE")

Frequency Band = Band 4/10/66, Test Frequency = low, Direction = RF downlink  
(S01\_AA01)

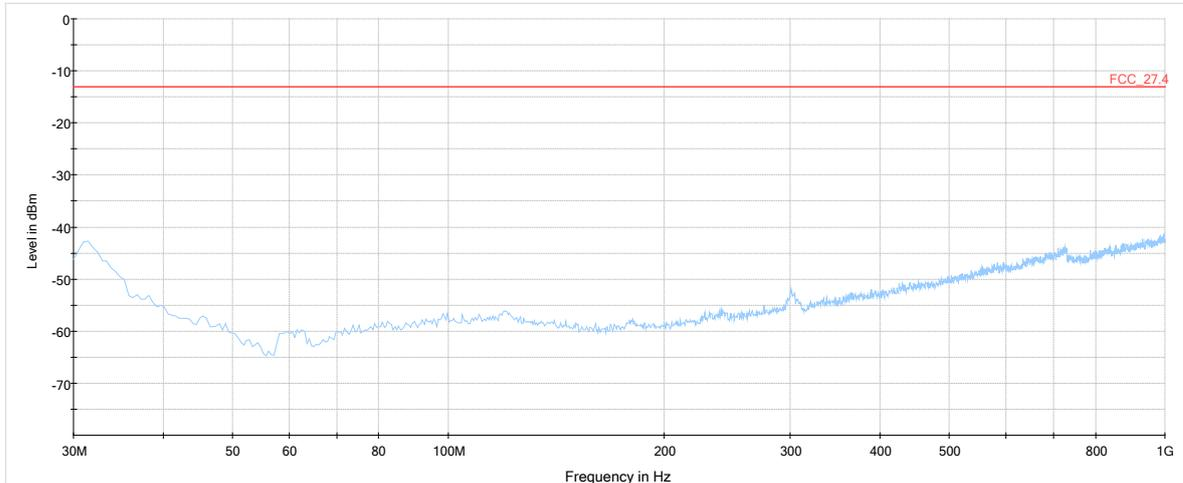

30 MHz - 1 GHz

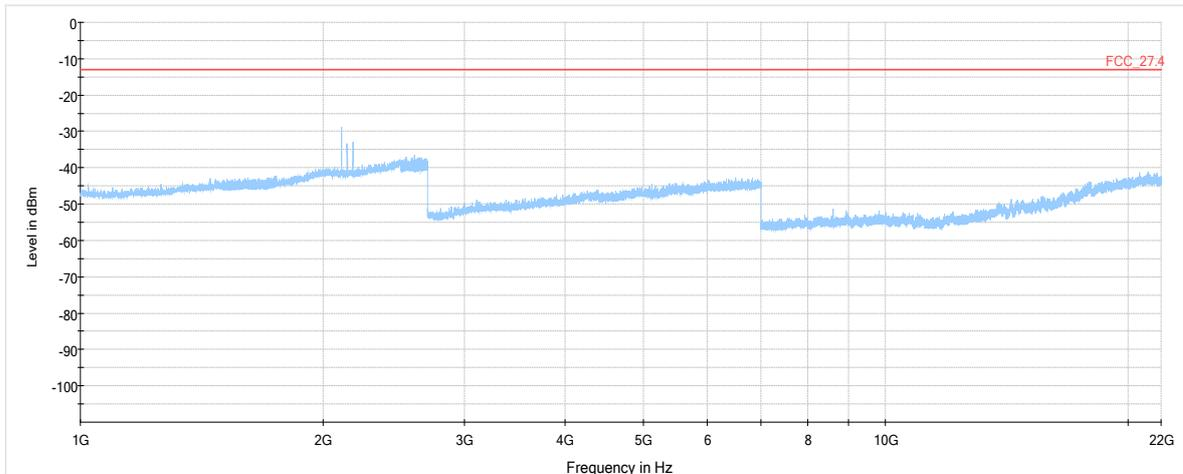

1 GHz - 22 GHz

Frequency Band = Band 4/10/66, Test Frequency = mid, Direction = RF downlink  
(S01\_AA01)

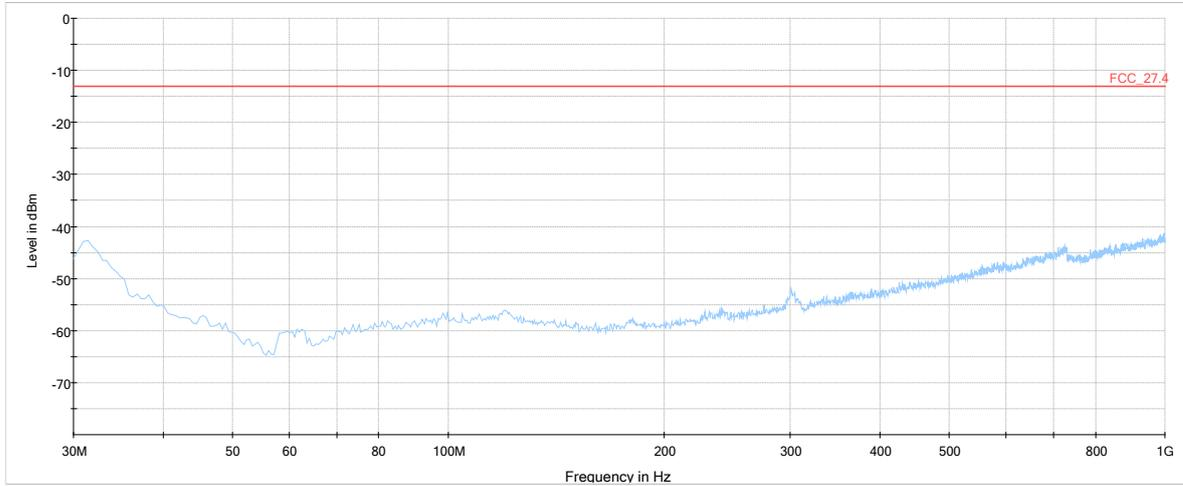

30 MHz - 1 GHz

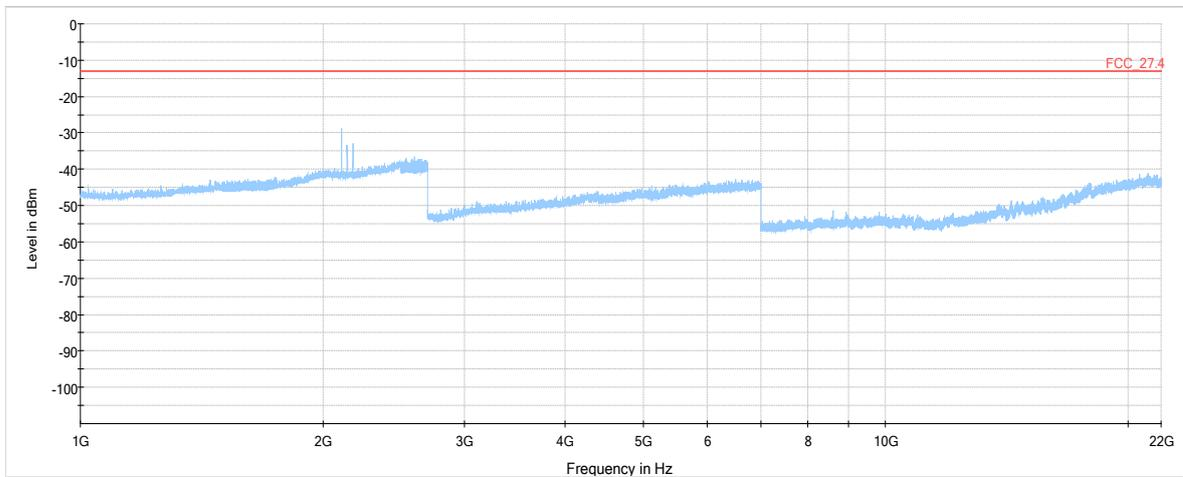

1 GHz - 22 GHz

Frequency Band = Band 4/10/66, Test Frequency = high, Direction = RF downlink  
(S01\_AA01)

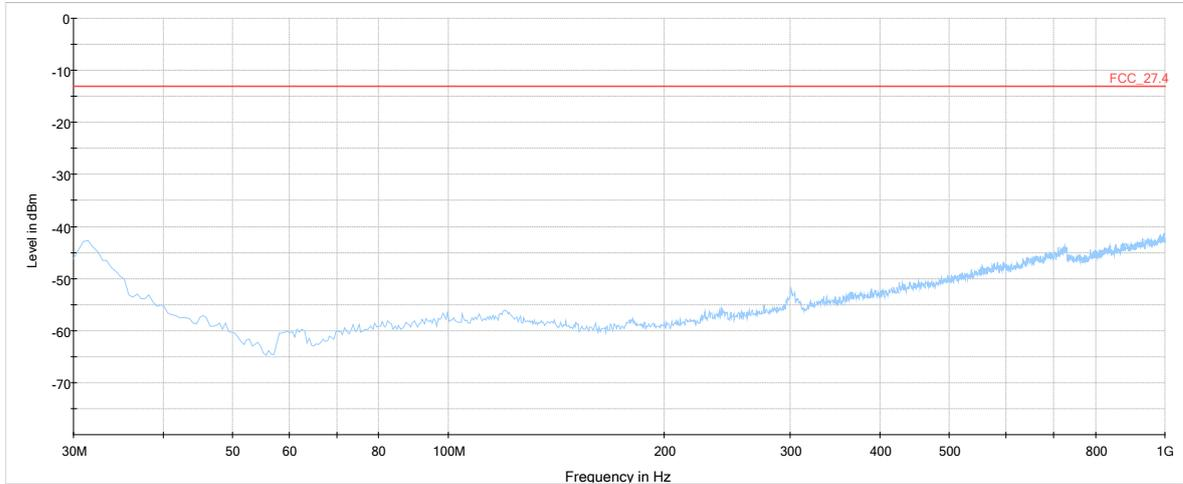

30 MHz - 1 GHz

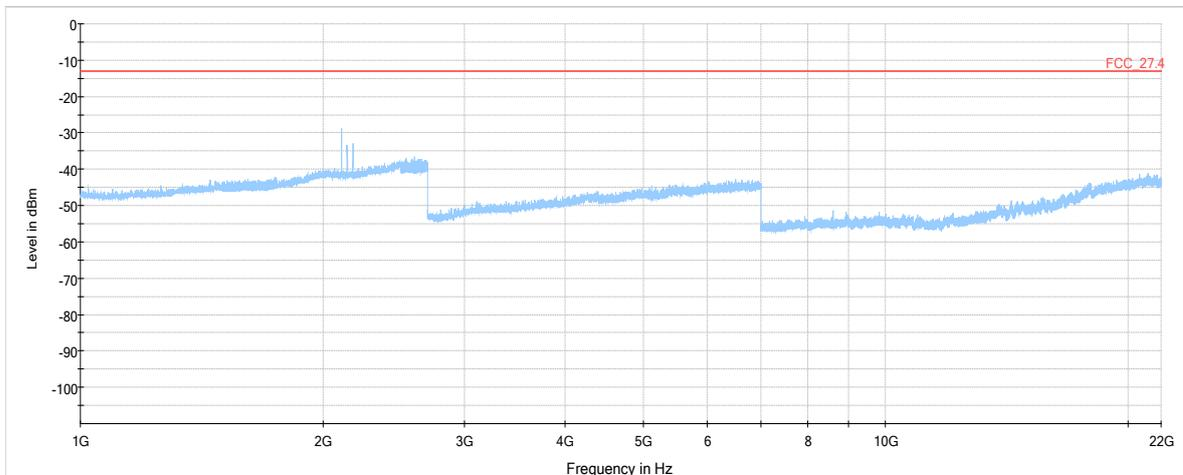

1 GHz - 22 GHz

#### 4.7.5 TEST EQUIPMENT USED

- Radiated Emissions

## 5 TEST EQUIPMENT

- 1 R&S TS8997  
EN300328/301893/FCC cond. Test Lab

Ref.No.	Device Name	Description	Manufacturer	Serial Number	Last Calibration	Calibration Due
1.1	SMB100A	Signal Generator 9 kHz - 6 GHz	Rohde & Schwarz	107695	2017-07	2020-07
1.2	MFS	Rubidium Frequency Standard	Datum-Beverly	5489/001	2017-07	2018-07
1.3	1515 / 93459	Broadband Power Divider SMA (Aux)	Weinschel Associates	LN673		
1.4	FSV30	Signal Analyzer 10 Hz - 30 GHz	Rohde & Schwarz	103005	2016-02	2018-02
1.5	Fluke 177	Digital Multimeter 03 (Multimeter)	Fluke Europe B.V.	86670383	2016-02	2018-02
1.6	VT 4002	Climatic Chamber	Vötsch	58566002150010	2016-03	2018-03
1.7	A8455-4	4 Way Power Divider (SMA)		-		
1.8	Opus10 THI (8152.00)	ThermoHygro Datalogger 03 (Environ)	Lufft Mess- und Regeltechnik GmbH	7482	2017-03	2019-03
1.9	SMBV100A	Vector Signal Generator 9 kHz - 6 GHz	Rohde & Schwarz	259291	2016-10	2019-10
1.10	OSP120	Switching Unit with integrated power meter	Rohde & Schwarz	101158	2016-11	2018-11

- 2 Radiated Emissions  
Lab to perform radiated emission tests

Ref.No.	Device Name	Description	Manufacturer	Serial Number	Last Calibration	Calibration Due
2.1	NRV-Z1	Sensor Head A	Rohde & Schwarz	827753/005	2017-05	2018-05
2.2	MFS	Rubidium Frequency Normal MFS	Datum GmbH	002	2017-10	2018-10
2.3	Opus10 TPR (8253.00)	ThermoAirpressure Datalogger 13 (Environ)	Lufft Mess- und Regeltechnik GmbH	13936	2017-04	2019-04
2.4	Anechoic Chamber	10.38 x 6.38 x 6.00 m <sup>3</sup>	Frankonia	none	2016-05	2019-05
2.5	HL 562	Ultralog new biconicals	Rohde & Schwarz	830547/003	2015-06	2018-06
2.6	5HC2700/12750 -1.5-KK	High Pass Filter	Trilithic	9942012		
2.7	ASP 1.2/1.8-10 kg	Antenna Mast	Maturo GmbH	-		



Ref.No.	Device Name	Description	Manufacturer	Serial Number	Last Calibration	Calibration Due
2.8	Fully Anechoic Room	8.80m x 4.60m x 4.05m (l x w x h)	Albatross Projects	P26971-647-001-PRB	2015-06	2018-06
2.9	Fluke 177	Digital Multimeter 03 (Multimeter)	Fluke Europe B.V.	86670383	2016-02	2018-02
2.10	JS4-18002600-32-5P	Broadband Amplifier 18 GHz - 26 GHz	Miteq	849785		
2.11	FSW 43	Spectrum Analyzer	Rohde & Schwarz	103779	2016-12	2018-12
2.12	3160-09	Standard Gain / Pyramidal Horn Antenna 26.5 GHz	EMCO Elektronik GmbH	00083069		
2.13	WHKX 7.0/18G-8SS	High Pass Filter	Wainwright	09		
2.14	4HC1600/12750-1.5-KK	High Pass Filter	Trilithic	9942011		
2.15	Chroma 6404	AC Power Source	Chroma ATE INC.	64040001304		
2.16	JS4-00102600-42-5A	Broadband Amplifier 30 MHz - 26 GHz	Miteq	619368		
2.17	TT 1.5 WI	Turn Table	Maturo GmbH	-		
2.18	HL 562 Ultralog	Log.-per. Antenna	Rohde & Schwarz	100609	2016-04	2019-04
2.19	3160-10	Standard Gain / Pyramidal Horn Antenna 40 GHz	EMCO Elektronik GmbH	00086675		
2.20	5HC3500/18000-1.2-KK	High Pass Filter	Trilithic	200035008		
2.21	Opus10 THI (8152.00)	ThermoHygro Datalogger 12 (Environ)	Lufft Mess- und Regeltechnik GmbH	12482	2017-03	2019-03
2.22	ESR 7	EMI Receiver / Spectrum Analyzer	Rohde & Schwarz	101424	2016-11	2018-11
2.23	JS4-00101800-35-5P	Broadband Amplifier 30 MHz - 18 GHz	Miteq	896037		
2.24	AS 620 P	Antenna mast	HD GmbH	620/37		
2.25	Tilt device Maturo (Rohacell)	Antrieb TD1.5-10kg	Maturo GmbH	TD1.5-10kg/024/3790709		
2.26	PAS 2.5 - 10 kg	Antenna Mast	Maturo GmbH	-		
2.27	AM 4.0	Antenna mast	Maturo GmbH	AM4.0/180/11920513		
2.28	HF 907	Double-ridged horn	Rohde & Schwarz	102444	2015-05	2018-05

3 FCC Conducted Base Station / Repeater  
EN300328/301893/FCC cond. Test Lab

Ref.No.	Device Name	Description	Manufacturer	Serial Number	Last Calibration	Calibration Due
3.1	FSV40	Signal Analyzer 10 Hz - 40 GHz	Rohde & Schwarz	100886	2017-08	2018-08
3.2	SMBV100A	Vector Signal Generator 9 kHz - 6 GHz	Rohde & Schwarz	255975	2017-08	2020-08
3.3	SMIQ	Vector Signal Generator 9 kHz - 3.3 GHz	Rohde & Schwarz	831389/062	2016-08	2018-08
3.4	SMIQ	Vector Signal Generator 9 kHz - 3.3 GHz	Rohde & Schwarz	831389/063	2016-10	2018-10

The calibration interval is the time interval between "Last Calibration" and "Calibration Due"

## 6 ANTENNA FACTORS, CABLE LOSS AND SAMPLE CALCULATIONS

This chapter contains the antenna factors with their corresponding path loss of the used measurement path for all antennas as well as the insertion loss of the LISN.

### 6.1 LISN R&S ESH3-Z5 (150 KHZ – 30 MHZ)

Frequency MHz	Corr. dB	LISN insertion loss ESH3- Z5 dB	cable loss (incl. 10 dB atten- uator) dB
0.15	10.1	0.1	10.0
5	10.3	0.1	10.2
7	10.3	0.2	10.3
10	10.3	0.2	10.3
12	10.7	0.3	10.4
14	10.7	0.3	10.4
16	10.8	0.4	10.4
18	10.9	0.4	10.3
20	10.9	0.4	10.3
22	11.1	0.3	10.6
24	11.1	0.3	10.6
26	11.2	0.3	10.7
28	11.2	0.3	10.7
30	11.3	0.3	10.8

#### Sample calculation

$$U_{\text{LISN}} \text{ (dB } \mu\text{V)} = U \text{ (dB } \mu\text{V)} + \text{Corr. (dB)}$$

U = Receiver reading

LISN Insertion loss = Voltage Division Factor of LISN

Corr. = sum of single correction factors of used LISN, cables, switch units (if used)

Linear interpolation will be used for frequencies in between the values in the table.

## 6.2 ANTENNA R&S HFH2-Z2 (9 KHZ – 30 MHZ)

Frequency MHz	AF HFH-Z2) dB (1/m)	Corr. dB	cable loss 1 (inside chamber) dB	cable loss 2 (outside chamber) dB	cable loss 3 (switch unit) dB	cable loss 4 (to receiver) dB	distance corr. (-40 dB/ decade) dB	d <sub>Limit</sub> (meas. distance (limit) m	d <sub>used</sub> (meas. distance (used) m
0.009	20.30	-79.6	0.1	0.1	0.1	0.1	-80	300	3
0.01	20.45	-79.6	0.1	0.1	0.1	0.1	-80	300	3
0.015	20.37	-79.6	0.1	0.1	0.1	0.1	-80	300	3
0.02	20.36	-79.6	0.1	0.1	0.1	0.1	-80	300	3
0.025	20.38	-79.6	0.1	0.1	0.1	0.1	-80	300	3
0.03	20.32	-79.6	0.1	0.1	0.1	0.1	-80	300	3
0.05	20.35	-79.6	0.1	0.1	0.1	0.1	-80	300	3
0.08	20.30	-79.6	0.1	0.1	0.1	0.1	-80	300	3
0.1	20.20	-79.6	0.1	0.1	0.1	0.1	-80	300	3
0.2	20.17	-79.6	0.1	0.1	0.1	0.1	-80	300	3
0.3	20.14	-79.6	0.1	0.1	0.1	0.1	-80	300	3
0.49	20.12	-79.6	0.1	0.1	0.1	0.1	-80	300	3
0.490001	20.12	-39.6	0.1	0.1	0.1	0.1	-40	30	3
0.3	20.11	-39.6	0.1	0.1	0.1	0.1	-40	30	3
0.8	20.10	-39.6	0.1	0.1	0.1	0.1	-40	30	3
1	20.09	-39.6	0.1	0.1	0.1	0.1	-40	30	3
2	20.08	-39.6	0.1	0.1	0.1	0.1	-40	30	3
3	20.06	-39.6	0.1	0.1	0.1	0.1	-40	30	3
4	20.05	-39.5	0.2	0.1	0.1	0.1	-40	30	3
5	20.05	-39.5	0.2	0.1	0.1	0.1	-40	30	3
6	20.02	-39.5	0.2	0.1	0.1	0.1	-40	30	3
8	19.95	-39.5	0.2	0.1	0.1	0.1	-40	30	3
10	19.83	-39.4	0.2	0.1	0.2	0.1	-40	30	3
12	19.71	-39.4	0.2	0.1	0.2	0.1	-40	30	3
14	19.54	-39.4	0.2	0.1	0.2	0.1	-40	30	3
16	19.53	-39.3	0.3	0.1	0.2	0.1	-40	30	3
18	19.50	-39.3	0.3	0.1	0.2	0.1	-40	30	3
20	19.57	-39.3	0.3	0.1	0.2	0.1	-40	30	3
22	19.61	-39.3	0.3	0.1	0.2	0.1	-40	30	3
24	19.61	-39.3	0.3	0.1	0.2	0.1	-40	30	3
26	19.54	-39.3	0.3	0.1	0.2	0.1	-40	30	3
28	19.46	-39.2	0.3	0.1	0.3	0.1	-40	30	3
30	19.73	-39.1	0.4	0.1	0.3	0.1	-40	30	3

### Sample calculation

$$E \text{ (dB } \mu\text{V/m)} = U \text{ (dB } \mu\text{V)} + AF \text{ (dB 1/m)} + Corr. \text{ (dB)}$$

U = Receiver reading

AF = Antenna factor

Corr. = sum of single correction factors of used cables, switch unit, distance correction, amplifier (if applicable)

distance correction =  $-40 * \text{LOG} (d_{\text{Limit}} / d_{\text{used}})$

Linear interpolation will be used for frequencies in between the values in the table.

Table shows an extract of values

### 6.3 ANTENNA R&S HL562 (30 MHz – 1 GHz)

( $d_{Limit} = 3\text{ m}$ )

Frequency	AF R&S HL562	Corr.
MHz	dB (1/m)	dB
30	18.6	0.6
50	6.0	0.9
100	9.7	1.2
150	7.9	1.6
200	7.6	1.9
250	9.5	2.1
300	11.0	2.3
350	12.4	2.6
400	13.6	2.9
450	14.7	3.1
500	15.6	3.2
550	16.3	3.5
600	17.2	3.5
650	18.1	3.6
700	18.5	3.6
750	19.1	4.1
800	19.6	4.1
850	20.1	4.4
900	20.8	4.7
950	21.1	4.8
1000	21.6	4.9

cable loss 1 (inside chamber)	cable loss 2 (outside chamber)	cable loss 3 (switch unit)	cable loss 4 (to receiver)	distance corr. (-20 dB/decade)	$d_{Limit}$ (meas. distance (limit))	$d_{used}$ (meas. distance (used))
dB	dB	dB	dB	dB	m	m
0.29	0.04	0.23	0.02	0.0	3	3
0.39	0.09	0.32	0.08	0.0	3	3
0.36	0.14	0.47	0.08	0.0	3	3
0.73	0.20	0.39	0.12	0.0	3	3
0.84	0.21	0.70	0.11	0.0	3	3
0.98	0.24	0.80	0.13	0.0	3	3
1.04	0.26	0.89	0.15	0.0	3	3
1.18	0.31	0.96	0.13	0.0	3	3
1.28	0.35	1.03	0.19	0.0	3	3
1.39	0.38	1.11	0.22	0.0	3	3
1.44	0.39	1.20	0.19	0.0	3	3
1.55	0.46	1.24	0.23	0.0	3	3
1.59	0.43	1.29	0.23	0.0	3	3
1.67	0.34	1.35	0.22	0.0	3	3
1.67	0.42	1.41	0.15	0.0	3	3
1.87	0.34	1.46	0.25	0.0	3	3
1.90	0.46	1.51	0.25	0.0	3	3
1.99	0.60	1.56	0.27	0.0	3	3
2.14	0.60	1.63	0.29	0.0	3	3
2.22	0.60	1.66	0.33	0.0	3	3
2.23	0.61	1.71	0.30	0.0	3	3

( $d_{Limit} = 10\text{ m}$ )

30	18.6	-9.9
50	6.0	-9.6
100	9.7	-9.2
150	7.9	-8.8
200	7.6	-8.6
250	9.5	-8.3
300	11.0	-8.1
350	12.4	-7.9
400	13.6	-7.6
450	14.7	-7.4
500	15.6	-7.2
550	16.3	-7.0
600	17.2	-6.9
650	18.1	-6.9
700	18.5	-6.8
750	19.1	-6.3
800	19.6	-6.3
850	20.1	-6.0
900	20.8	-5.8
950	21.1	-5.6
1000	21.6	-5.6

0.29	0.04	0.23	0.02	-10.3	10	3
0.39	0.09	0.32	0.08	-10.3	10	3
0.36	0.14	0.47	0.08	-10.3	10	3
0.73	0.20	0.39	0.12	-10.3	10	3
0.84	0.21	0.70	0.11	-10.3	10	3
0.98	0.24	0.80	0.13	-10.3	10	3
1.04	0.26	0.89	0.15	-10.3	10	3
1.18	0.31	0.96	0.13	-10.3	10	3
1.28	0.35	1.03	0.19	-10.3	10	3
1.39	0.38	1.11	0.22	-10.3	10	3
1.44	0.39	1.20	0.19	-10.3	10	3
1.55	0.46	1.24	0.23	-10.3	10	3
1.59	0.43	1.29	0.23	-10.3	10	3
1.67	0.34	1.35	0.22	-10.3	10	3
1.67	0.42	1.41	0.15	-10.3	10	3
1.87	0.34	1.46	0.25	-10.3	10	3
1.90	0.46	1.51	0.25	-10.3	10	3
1.99	0.60	1.56	0.27	-10.3	10	3
2.14	0.60	1.63	0.29	-10.3	10	3
2.22	0.60	1.66	0.33	-10.3	10	3
2.23	0.61	1.71	0.30	-10.3	10	3

#### Sample calculation

$$E \text{ (dB } \mu\text{V/m)} = U \text{ (dB } \mu\text{V)} + \text{AF (dB 1/m)} + \text{Corr. (dB)}$$

U = Receiver reading

AF = Antenna factor

Corr. = sum of single correction factors of used cables, switch unit, distance correction, amplifier (if applicable)

distance correction =  $-20 * \text{LOG} (d_{Limit} / d_{used})$

Linear interpolation will be used for frequencies in between the values in the table.

Tables show an extract of values.

### 6.4 ANTENNA R&S HF907 (1 GHZ – 18 GHZ)

Frequency	AF R&S HF907	Corr.
MHz	dB (1/m)	dB
1000	24.4	-19.4
2000	28.5	-17.4
3000	31.0	-16.1
4000	33.1	-14.7
5000	34.4	-13.7
6000	34.7	-12.7
7000	35.6	-11.0

cable loss 1 (relay + cable inside chamber)	cable loss 2 (outside chamber)	cable loss 3 (switch unit, attenuator & pre-amp)	cable loss 4 (to receiver)		
dB	dB	dB	dB		
0.99	0.31	-21.51	0.79		
1.44	0.44	-20.63	1.38		
1.87	0.33	-19.85	1.33		
2.41	0.67	-19.13	1.31		
2.78	0.86	-18.71	1.40		
2.74	0.90	-17.83	1.47		
2.82	0.86	-16.19	1.46		

Frequency	AF R&S HF907	Corr.
MHz	dB (1/m)	dB
3000	31.0	-23.4
4000	33.1	-23.3
5000	34.4	-21.7
6000	34.7	-21.2
7000	35.6	-19.8

cable loss 1 (relay inside chamber)	cable loss 2 (inside chamber)	cable loss 3 (outside chamber)	cable loss 4 (switch unit, attenuator & pre-amp)	cable loss 5 (to receiver)	used for FCC 15.247
dB	dB	dB	dB	dB	
0.47	1.87	0.33	-27.58	1.33	
0.36	2.41	0.67	-28.23	1.31	
0.61	2.78	0.86	-27.35	1.40	
0.38	2.74	0.90	-26.89	1.47	
0.66	2.82	0.86	-25.58	1.46	

Frequency	AF R&S HF907	Corr.
MHz	dB (1/m)	dB
7000	35.6	-57.3
8000	36.3	-56.3
9000	37.1	-55.3
10000	37.5	-56.2
11000	37.5	-55.3
12000	37.6	-53.7
13000	38.2	-53.5
14000	39.9	-56.3
15000	40.9	-54.1
16000	41.3	-54.1
17000	42.8	-54.4
18000	44.2	-54.7

cable loss 1 (relay inside chamber)	cable loss 2 (High Pass)	cable loss 3 (pre-amp)	cable loss 4 (inside chamber)	cable loss 5 (outside chamber)	cable loss 6 (to receiver)
dB	dB	dB	dB	dB	dB
0.36	1.28	-62.72	2.66	0.94	1.46
0.69	0.71	-61.49	2.84	1.00	1.53
0.68	0.65	-60.80	3.06	1.09	1.60
0.70	0.34	-61.91	3.28	1.20	1.67
0.80	0.61	-61.40	3.43	1.27	1.70
0.84	0.42	-59.70	3.53	1.26	1.73
0.83	0.44	-59.81	3.75	1.32	1.83
0.91	0.33	-63.03	3.91	1.40	1.77
0.98	0.34	-61.05	4.02	1.44	1.83
1.23	0.49	-61.51	4.17	1.51	1.85
1.36	0.76	-62.36	4.34	1.53	2.00
1.70	0.33	-62.88	4.41	1.55	1.91

#### Sample calculation

$E \text{ (dB } \mu\text{V/m)} = U \text{ (dB } \mu\text{V)} + AF \text{ (dB 1/m)} + Corr. \text{ (dB)}$   
 U = Receiver reading  
 AF = Antenna factor  
 Corr. = sum of single correction factors of used cables, switch unit, distance correction, amplifier (if applicable)  
 Linear interpolation will be used for frequencies in between the values in the table.  
 Tables show an extract of values.

## 6.5 ANTENNA EMCO 3160-09 (18 GHZ – 26.5 GHZ)

Frequency MHz	AF EMCO 3160-09 dB (1/m)	Corr. dB
18000	40.2	-23.5
18500	40.2	-23.2
19000	40.2	-22.0
19500	40.3	-21.3
20000	40.3	-20.3
20500	40.3	-19.9
21000	40.3	-19.1
21500	40.3	-19.1
22000	40.3	-18.7
22500	40.4	-19.0
23000	40.4	-19.5
23500	40.4	-19.3
24000	40.4	-19.8
24500	40.4	-19.5
25000	40.4	-19.3
25500	40.3	-20.4
26000	40.3	-21.3
26500	40.3	-21.1

cable loss 1 (inside chamber) dB	cable loss 2 (pre- amp) dB	cable loss 3 (inside chamber) dB	cable loss 4 (switch unit) dB	cable loss 5 (to receiver) dB
0.72	-35.85	6.20	2.81	2.65
0.69	-35.71	6.46	2.76	2.59
0.76	-35.44	6.69	3.15	2.79
0.74	-35.07	7.04	3.11	2.91
0.72	-34.49	7.30	3.07	3.05
0.78	-34.46	7.48	3.12	3.15
0.87	-34.07	7.61	3.20	3.33
0.90	-33.96	7.47	3.28	3.19
0.89	-33.57	7.34	3.35	3.28
0.87	-33.66	7.06	3.75	2.94
0.88	-33.75	6.92	3.77	2.70
0.90	-33.35	6.99	3.52	2.66
0.88	-33.99	6.88	3.88	2.58
0.91	-33.89	7.01	3.93	2.51
0.88	-33.00	6.72	3.96	2.14
0.89	-34.07	6.90	3.66	2.22
0.86	-35.11	7.02	3.69	2.28
0.90	-35.20	7.15	3.91	2.36

### Sample calculation

$$E \text{ (dB } \mu\text{V/m)} = U \text{ (dB } \mu\text{V)} + AF \text{ (dB 1/m)} + Corr. \text{ (dB)}$$

U = Receiver reading

AF = Antenna factor

Corr. = sum of single correction factors of used cables, switch unit, distance correction, amplifier (if applicable)

Linear interpolation will be used for frequencies in between the values in the table.

Table shows an extract of values.

## 6.6 ANTENNA EMCO 3160-10 (26.5 GHZ – 40 GHZ)

Frequency GHz	AF EMCO 3160-10 dB (1/m)	Corr. dB	cable loss 1 (inside chamber) dB	cable loss 2 (outside chamber) dB	cable loss 3 (switch unit) dB	cable loss 4 (to receiver) dB	distance corr. (-20 dB/ decade) dB	d <sub>Limit</sub> (meas. distance (limit) m	d <sub>used</sub> (meas. distance (used) m
26.5	43.4	-11.2	4.4				-15.6	3	0.3
27.0	43.4	-11.2	4.4				-15.6	3	0.3
28.0	43.4	-11.1	4.5				-15.6	3	0.3
29.0	43.5	-11.0	4.6				-15.6	3	0.3
30.0	43.5	-10.9	4.7				-15.6	3	0.3
31.0	43.5	-10.8	4.7				-15.6	3	0.3
32.0	43.5	-10.7	4.8				-15.6	3	0.3
33.0	43.6	-10.7	4.9				-15.6	3	0.3
34.0	43.6	-10.6	5.0				-15.6	3	0.3
35.0	43.6	-10.3	5.1				-15.6	3	0.3
36.0	43.6	-10.4	5.1				-15.6	3	0.3
37.0	43.7	-10.3	5.2				-15.6	3	0.3
38.0	43.7	-10.2	5.3				-15.6	3	0.3
39.0	43.7	-10.2	5.4				-15.6	3	0.3
40.0	43.8	-10.1	5.5				-15.6	3	0.3

### Sample calculation

$$E \text{ (dB } \mu\text{V/m)} = U \text{ (dB } \mu\text{V)} + \text{AF (dB 1/m)} + \text{Corr. (dB)}$$

U = Receiver reading

AF = Antenna factor

Corr. = sum of single correction factors of used cables, switch unit, distance correction, amplifier (if applicable)

Linear interpolation will be used for frequencies in between the values in the table.

distance correction =  $-20 * \text{LOG} (d_{\text{Limit}} / d_{\text{used}})$

Linear interpolation will be used for frequencies in between the values in the table.

Table shows an extract of values.



## 7 MEASUREMENT UNCERTAINTIES

Test Case(s)	Parameter	Uncertainty
- Field strength of spurious radiation	Power	$\pm 5.5$ dB
- Out-of-band rejection - Occupied Bandwidth - Input versus output spectrum	Power Frequency	$\pm 2.9$ dB $\pm 11.2$ kHz
- Effective radiated power, mean output power and zone enhancer gain - Peak to Average Ratio	Power	$\pm 2.2$ dB
- Out-of-band emission limits - Conducted Spurious Emissions at Antenna Terminal	Power Frequency	$\pm 2.2$ dB $\pm 11.2$ kHz

## 8 PHOTO REPORT

Please see separate photo report.