

CommScope ERA[®] UAP2 with Fiber Interface Installation Guide Release

P/N M0203AB, DRAFT Rev D
31 Aug 2023

Copyright Statement

Copyright statement for DAS and Small Cell documents.

Copyright © 2023 CommScope, All rights reserved.

THIS DOCUMENT HAS BEEN DEVELOPED BY COMMScope, AND IS INTENDED FOR THE USE OF ITS CUSTOMERS AND CUSTOMER SUPPORT PERSONNEL.

THE SPECIFICATIONS AND INFORMATION REGARDING THE PRODUCTS IN THIS MANUAL ARE SUBJECT TO CHANGE WITHOUT NOTICE. ALL STATEMENTS, INFORMATION, AND RECOMMENDATIONS IN THIS MANUAL ARE BELIEVED TO BE ACCURATE BUT ARE PRESENTED WITHOUT WARRANTY OF ANY KIND, EXPRESS OR IMPLIED. USERS MUST TAKE FULL RESPONSIBILITY FOR THEIR APPLICATION OF ANY PRODUCTS.

THE SOFTWARE LICENSE AND LIMITED WARRANTY FOR THE ACCOMPANYING PRODUCT ARE SET FORTH IN THE INFORMATION PACKET THAT SHIPPED WITH THE PRODUCT AND ARE INCORPORATED HEREIN BY REFERENCE. IF YOU ARE UNABLE TO LOCATE THE SOFTWARE LICENSE OR LIMITED WARRANTY, CONTACT YOUR COMMScope SALES REPRESENTATIVE FOR A COPY.

Document Revision History

This is the fourth release of the UAP2 with Fiber Interface Installation Guide. This release

- revises [Table 3: Maximum Power Output by Frequency](#) (page 12)
- added 2 new points in [Powering on a Fiber UAP2](#) (page 39).

Contents

Copyright Statement.....	2
Document Revision History.....	3
Chapter 1. Document Overview.....	6
Document Cautions and Notes.....	6
Abbreviations Used in this Guide.....	7
Safely Working with ERA Hardware.....	8
Health and Safety Precautions.....	8
Property Damage Warnings.....	8
General Installation Safety Requirements.....	9
Guard Against Damage from Electro-Static Discharge.....	9
Compliance.....	10
Equipment Symbols Used / Compliance.....	11
Maximum Output Power Levels.....	12
Chapter 2. Fiber UAP2	14
Overview.....	14
UAP2 Accessories and Options.....	15
Mounting and Power Kits.....	15
SFP+ Modules.....	15
Chapter 3. Plan and Prepare For A Fiber UAP2 Installation.....	18
Determine the Power Consumption of the UAP2.....	18
UAP2 Dimensions.....	18
Unpack and Inspect the UAP2 and Accessories.....	19
Obtain the Required Materials.....	19
Chapter 4. Mount the Fiber UAP2.....	20
General Mounting Cautions.....	20
Mounting a UAP2 with an AC/DC Power Supply Kit.....	20
Attach the Power Supply to the UAP2.....	20
Mounting a UAP2 with a Hybrid Splice Kit.....	21
Assembling and Wiring the Hybrid Fiber Splice Box.....	21
Mounting a UAP2 on a Ceiling.....	29
Mounting a UAP2 on a Wall.....	34

Connect the Fiber UAP2 to a Classic CAN or TEN..... 38

Chapter 5. Powering on a Fiber UAP2..... 39

Contacting CommScope..... 40

 Hardware to Software Mapping Information.....40

 DAS and Small Cell Technical Support.....40

 Telephone Helplines..... 40

 Online Support.....40

 Waste Electrical and Electronic Equipment Recycling..... 41

 DAS and Small Cell Technical Training..... 41

 Accessing ERA User Documentation..... 41

Document Overview

This installation guide describes the Fiber UAP2 that interfaces with a Classic CAN or TEN via an optical link.

This guide provides a product overview and installation instructions for installing the UAP2 fiber model. UAP2 is for indoor installations only.

In addition, this installation guide describes the Fiber UAP2 that interfaces with a Classic CAN or TEN via an optical link.

[Table 1: Supported UAP 2 Models](#) (page 6) lists the UAP2 variants that this installation guide supports.

TABLE 1: Supported UAP 2 Models

Part Number ¹	Model Name
7845389-1009	UAP 2 9/18/21/26 F-DC
7845389-1013	UAP 2 7-8/9/18/21 F-DC
7845389-1016	UAP 2 18/21 F-DC
7845389-1025	UAP 2 17E/19 F-DC
7845389-1028	UAP 2 25T/37T F-DC
7845389-1029	UAP 2 34T/37T F-DC
7845389-1030	UAP 2 25T/34T/37T/37T F-DC
7845389-1031	UAP 2 17E/19/25T/37T F-DC
7845389-1032	UAP 2 7E/17E/19/37T F-DC
7845389-1033	UAP 2 80-85/25T/34T/37T F-DC
7845389-1034	UAP 2 80-85/17E/19/37T F-DC
7845389-1036	UAP 2 35L T/35HT F-DC

















Note: For information on how to find the minimum software requirements for ERA hardware, refer to [Hardware to Software Mapping Information](#).

Document Cautions and Notes

This document may contain any of the following notes, cautions, and warning icons.



Note: This symbol without additional icons indicates a general note. Notes provide information about special circumstances.

-  **Note:**  This icon indicates a caution or warning. Cautions and warnings indicate operations or steps that could cause personal injury, induce a safety problem in a managed device, destroy or corrupt information, or interrupt or stop services.
-  **Note:**  This icon indicates a caution or warning that pertains to laser equipment.
-  **Note:**  This icon indicates a caution or warning that pertains to Radio Frequency (RF).
-  **Note:**  This icon indicates that the hardware is susceptible to Electro-Static Discharge (ESD) damage.
-  **Note:**  This icon indicates a caution or warning that pertains to an electrical hazard.
-  **Note:**  This icon indicates a caution or warning that pertains to a fire hazard.
-  **Note:**  This icon indicates a system configuration that can only be performed by a specific user role. The required user login credential will be identified.

Abbreviations Used in this Guide







Abbreviation	Description	Abbreviation	Description
AC	Alternating Current	ISDE	Innovation, Sciences et Développement économique Canada
AP	Access Point	ISED	Innovation, Science and Economic Development Canada
AUX	Auxiliary	kg	Kilogram
C	Celsius	LED	Light Emitting Diode
CAN	Central Area Node	MHz	Megahertz
CAP H	Carrier Access Point, High Power	mm	Millimeter
CAP L	Carrier Access Point, Low Power	MMF	Multi-Mode Fiber
CAP M	Carrier Access Point, Medium Power	OPT	Optical Transport
Cat	Category	PoE	Power over Ethernet
CAT	Copper Transport	PN	Part Number
CMS	CommScope Mobility Solutions	RAN	Regional-Area Network
dB	Decibel	RF	Radio Frequency
dBm	Decibel-milliwatts	RU	Rack Unit
DC	Direct Current	RX	Receive
EFTA	European Free Trade Association	SFP	Small Form-Factor Pluggable
EMC	Electromagnetic Compatibility	TEN	Transport Expansion Node
EMEA	Europe, Middle East, Africa	TX	Transmit
EU	European Union	UAP	Universal Access Point

Abbreviation	Description	Abbreviation	Description
F	Fahrenheit	Vac	Voltage in Alternating Current
FCC	Federal Communications Commission	Vdc	Voltage in Direct Current
Gb	Gigabit	W	Watts
GHz	Gigahertz	WIN	Wide-Area Integration Node
GUI	Graphical User Interface	WCS	Wireless Communications Switch
ION	Intelligent Optical Network		









Safely Working with ERA Hardware









The following sections provide important information that you should read and know before working with any ERA hardware. Observe all cautions and warnings listed in this section.

Health and Safety Precautions









-  **Note:**  A high leakage current ground (earth) connection to the Power Supply Unit (PSU) is essential before making any other connections to the PSU.
-  **Note:**  Laser radiation. Risk of eye injury in operation. Do not stare into the laser beam; do not view the laser beam directly or with optical instruments.
-  **Note:**  High frequency radiation in operation. Risk of health hazards associated with radiation from the antenna(s) connected to the unit. Implement prevention measures to avoid the possibility of close proximity to the antenna(s) while in operation.

Property Damage Warnings



-  **Note:**  Keep operating instructions within easy reach and make them available to all users.
-  **Note:**  Only license holders for the respective frequency range are allowed to operate this unit.
-  **Note:**  Read and obey all the warning labels attached to the unit. Keep all warning labels are kept in a legible condition. Replace missing or damaged labels.
-  **Note:**  Make sure the unit's settings are correct for the intended use (refer to the manufacturer product information) and regulatory requirements are met. Do not carry out any modifications or fit any spare parts, which are not sold or recommended by the manufacturer.

-  **Note:**  Due to power dissipation, the CAP M may reach a very high temperature. Do not operate this equipment on or close to flammable materials. Use caution when servicing the CAP M.
-  **Note:**  Only authorized and trained personnel are allowed to open the unit and get access to the inside.
-  **Note:**  Only suitably qualified personnel are allowed to work on this unit and only after becoming familiar with all safety notices, installation, operation and maintenance procedures contained in this installation guide.
-  **Note:**  Although the unit is internally protected against overvoltage, it is strongly recommended to ground (earth) the antenna cables close to the antenna connectors of the unit for protection against atmospheric discharge. In areas with strong lightning, it is strongly recommended to install additional lightning protection.

General Installation Safety Requirements

-  **Note:**  Wet conditions increase the potential for receiving an electrical shock when installing or using electrically powered equipment. To prevent electrical shock, never install or use electrical equipment in a wet location or during a lightning storm.
-  **Note:**  This system is a RF Transmitter and continuously emits RF energy. Maintain a minimum twelve inches (30 cm) clearance from the antenna while the system is operating. Whenever possible, power down the UAP2 before servicing the antenna.
-  **Note:**  Do not remove protective caps from any of the connectors until instructed to do so.
-  **Note:**  The UAP2 is to be used only with CommScope (NEC Class 2) or Limited Power Source ERA Subrack, or equivalent.

Guard Against Damage from Electro-Static Discharge

-  **Note:**  Electro-Static Discharge (ESD) can damage electronic components. To prevent ESD damage, always wear an ESD wrist strap when working with hardware components. Not all ERA hardware requires grounding. For those ERA hardware components for which grounding is required, connect the ground wire on the ESD wrist strap to an earth ground source before touching the component. Wear the wrist strap the entire time that you work with the ERA hardware.

Compliance

1. **Notice:** For installations, which have to comply with FCC RF exposure requirements, the antenna selection and installation must be completed in a way to ensure compliance with those FCC requirements. Depending on the RF frequency, rated output power, antenna gain, and the loss between the repeater and antenna, the minimum distance D to be maintained between the antenna location and human beings is calculated according to this formula:

$$D_{[cm]} = \sqrt{\frac{P_{[mW]}}{4 * \pi * PD_{[mW/cm^2]}}}$$

where

- P (mW) is the radiated power at the antenna, i.e. the max. rated repeater output power in addition to the antenna gain minus the loss between the repeater and the antenna.
- PD (mW/cm²) is the allowed Power Density limit acc. to 47 CFR 1.1310 (B) for general population / uncontrolled exposures which is
 - f (MHz) / 1500 for frequencies from 300MHz to 1500MHz
 - 1 for frequencies from 1500MHz to 100,000MHz

RF exposure compliance may need to be addressed at the time of licensing, as required by the responsible FCC Bureau(s), including antenna co-location requirements of 1.1307(b)(3).

2. **Notice:** For installations which have to comply with European EN50385 exposure compliance requirements, the following Power Density limits/guidelines (mW/cm²) according to ICNIRP are valid:
 - 0.2 for frequencies from 10 MHz to 400 MHz
 - F (MHz) / 2000 for frequencies from 400 MHz to 2 GHz
 - 1 for frequencies from 2 GHz to 300 GHz
3. **Notice:** Installation of this equipment is in full responsibility of the installer, who has also the responsibility, that cables and couplers are calculated into the maximum gain of the antennas, so that this value, which is filed in the FCC Grant and can be requested from the FCC data base, is not exceeded. The industrial boosters are shipped only as a naked booster without any installation devices or antennas as it needs for professional installation.
4. **Notice:** For installations which have to comply with FCC/ISED requirements:

English:

This device complies with FCC Part 15. Operation is subject to the following two conditions: (1) this device may not cause interference, and (2) this device must accept any interference, including interference that may cause undesired operation of the device.

This device complies with Health Canada's Safety Code. The installer of this device should ensure that RF radiation is not emitted in excess of the Health Canada's requirement. Information can be obtained at http://www.hc-sc.gc.ca/ewh-semt/pubs/radiation/radio_guide-lignes_direct-eng.php.

Changes or modifications not expressly approved by the party responsible for compliance could void the user's authority to operate the equipment.

5. **Notice:** For Class B signal boosters

WARNING. This is NOT a CONSUMER device. It is designed for installation by FCC LICENSEES and QUALIFIED INSTALLERS. You MUST have an FCC LICENSE or express consent of an FCC Licensee to operate this device. You MUST register Class B signal boosters (as defined in 47 CFR 90.219) online at <http://www.fcc.gov/signal-boosters/registration>. Unauthorized use may result in significant forfeiture penalties, including penalties in excess of \$100,000 for each continuing violation.

6. **Notice:** The unit complies with Overvoltage Category II. It also complies with the surge requirement according to EN 61000-4-5 (fine protection); however, installation of an additional medium (via local supply connection) and/or coarse protection (external surge protection) is recommended depending on the individual application in order to avoid damage caused by overcurrent.

For Canada and US, components used to reduce the Overvoltage Category shall comply with the requirements of IEC 61643-series. As an alternative, components used to reduce the Overvoltage Category may comply with ANSI/IEEE C62.11, CSA Certification Notice No. 516, CSA C22.2 No. 1, or UL 1449. Suitability of the component for the application shall be determined for the intended installation.

7. **Notice:** Corresponding local particularities and regulations must be observed. For national deviations, please refer to the respective documents included in the manual CD that is delivered with the unit.

8. **Note:** For a Class B digital device or peripheral:

This equipment has been tested and found to comply with the limits for a Class B digital device, pursuant to part 15 of the FCC Rules. These limits are designed to provide reasonable protection against harmful interference in a residential installation. This equipment generates, uses and can radiate radio frequency energy and, if not installed and used in accordance with the instructions, may cause harmful interference to radio communications. However, there is no guarantee that interference will not occur in a particular installation. If this equipment does cause harmful interference to radio or television reception, which can be determined by turning the equipment off and on, the user is encouraged to try to correct the interference.

9. **Notice:** For a Class A digital device or peripheral.

This equipment has been tested and found to comply with the limits for a Class A digital device, pursuant to Part 15 of the FCC Rules. These limits are designed to provide reasonable protection against harmful interference when the equipment is operated in a commercial environment. This equipment generates, uses, and can radiate radio frequency energy and, if not installed and used in accordance with the instruction manual, may cause harmful interference to radio communications. Operation of this equipment in a residential area is likely to cause harmful interference in which case the user will be required to correct the interference at his own expense.

10. **Note:** This unit complies with European standard EN62368-1.

Equipment Symbols Used / Compliance

Please observe the meanings of the following symbols used in our equipment and the compliance warnings listed in [Table 2: Compliance Labels](#) (page 12).

TABLE 2: Compliance Labels

Symbol	Compliance	Meaning
-	FCC	For industrial (Part 20) signal booster: WARNING: This is NOT a CONSUMER device. It is designed for installation by FCC LICENSEES and QUALIFIED INSTALLERS. You MUST have an FCC LICENSE or express consent of an FCC Licensee to operate this device. Unauthorized use may result in significant forfeiture penalties, including penalties in excess of \$100,000 for each continuing violation.
-	ISED	WARNING: This is NOT a CONSUMER device. It is designed for installation by an installer approved by an ISED licensee. You MUST have an ISED LICENCE or the express consent of an ISED licensee to operate this device. AVERTISSEMENT: Ce produit N'EST PAS un appareil de CONSOMMATION. Il est conçu pour être installé par un installateur approuvé par un titulaire de licence d'ISDE. Pour utiliser cet appareil, vous DEVEZ détenir une LICENCE d'ISDE ou avoir obtenu le consentement exprès d'un titulaire de licence autorisé par ISDE.
CE	CE	To be sold exclusively to mobile operators or authorized installers - no harmonized frequency bands, operation requires license. Intended use: EU and EFTA countries. Indicates conformity with the RED directive 2014/53/EU and/or RoHS directive 2011/65/EU.
CE 0700	CE	Indicates conformity with the RED directive 2014/53/EU and RoHS directive 2011/65/EU certified by the notified body no. 0700.

Maximum Output Power Levels

Table 3: [Maximum Power Output by Frequency](#) (page 12) lists the frequencies and maximum power output for bands supported in the UAP2 variants.

TABLE 3: Maximum Power Output by Frequency

UAP2 Band	DL Frequency Range (MHz)	Power Output (dBm)
7E	729 - 756, 758 - 768	22
7 - 8	758 - 821	22
80 - 85	862 - 894	22
9	925 - 960	22
18	1805 - 1880	24
19	1930 - 1995	24
17E	2110 - 2180	24
21	2110 - 2170	24
25T	2496 - 2690	24
26	2620 - 2690	24
34T	3450 - 3550	24

*Nominal Conducted Power Output for Single Port

TABLE 3: Maximum Power Output by Frequency (continued)

UAP2 Band	DL Frequency Range (MHz)	Power Output (dBm)
35L	3410 - 3640	24
35H	3580 - 3800	24
37T	3700 - 3980	24

*Nominal Conducted Power Output for Single Port

Fiber UAP2

Overview

UAP2 is a low power AP (Access Point). It supports up to four independent radio modules that allows up to four 2x2 MIMO bands. The UAP2 contains four internal antennas that are associated with up to four radio modules.

The Fiber UAP2 interfaces with a Classic CAN or TEN via an optical link. This allows the Fiber UAP 2 to provide data over Single-Mode Fiber (SMF) or Multi-Mode Fiber (MMF). Power for Fiber UAP 2s is provided over External AC/DC or remotely through hybrid fiber.

On the downlink, the Fiber UAP2 converts data arriving at the UAP2 to analog signals and sends them to the Antenna ports. On the uplink, received signals are digitized and serialized into data streams, which are sent back to the Classic CAN or TEN.

The Fiber UAP2

- is actively cooled with an operating temperature range of: +0°C to +40°C (32°F to 104°F) • is indoor rated (IP20)
- has a typical power consumption, which depending on the configuration, ranges from 130W to 143W
- supports up to two 10G SFP+ optical fiber interfaces

The Fiber UAP2 has two fiber ports. The ports must be connected to an OPT card in a Classic CAN or TEN. The red Primary port is always used. The blue Secondary port is used if more than 320 MHz of transport bandwidth is required.

FIGURE 1: UAP2 Ports

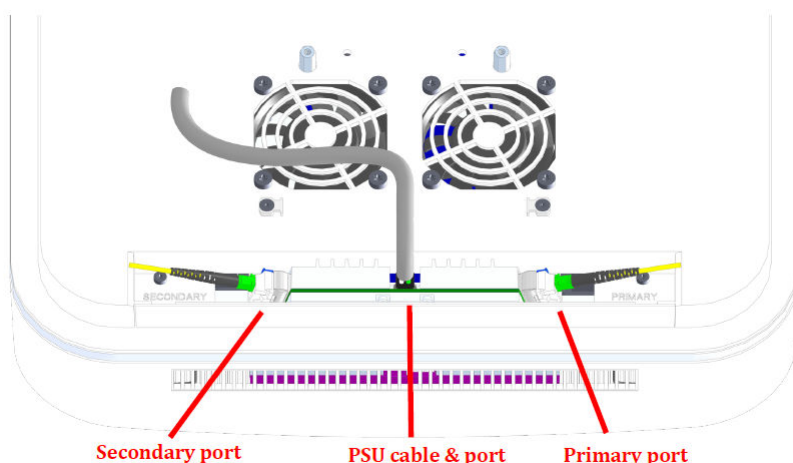

UAP2 Accessories and Options

The Fiber UAP2 accessories and options are described in the following sections:

- [Mounting and Power Kits](#)
- [SFP+ Modules](#)

Mounting and Power Kits

Wall and Ceiling mounting brackets are included with the UAP2. For Ceiling mounting, a 24" drop rail is also needed. In the NAR market, this drop rail can be ordered as part OC-BA50A. In other markets the drop rail may not be available as a CommScope part number; look for compatible third-party options such as the Eaton BA50A.

The UAP2 does not include a power cable. Either the Local AC Power Supply or both the Hybrid Splice Kit and a UAP2 Power cable must also be ordered.



Note: The Wall / Ceiling Mount adds an additional ~45 mm (1.77") of depth to the UAP2, totaling a depth of ~142 mm (5.59"). When the Hybrid Fiber Splice Kit is used, the total depth increases to ~171 mm (6.73").

TABLE 4: Power Kits and Spare / Replacement Mounting Kits

Mounting/Power Kit	CommScope PN	See
Wall / Ceiling Mount (without drop rail for Ceiling Mount)	7849969	"Mounting a UAP2 on a Ceiling" on page 22 / "Mounting a UAP2 on a Wall" on page 31
UAP2 Hybrid Fiber Splice Kit	7693816-xx	"Mounting a UAP2 with a Hybrid Splice Kit" on page 15
UAP2 Power Cable, 0.5m	7850085-xx	
UAP2 Power Cable, 3m	7850084-xx	
UAP2 AC Power Supply	7850080-xx	"Mounting a UAP2 with an AC/DC Power Supply Kit" on page 14

SFP+ Modules

Obtain SFP+ Module pairs (one placed in the TEN and paired with another in the Classic CAN) that are appropriate for this installation. Two pairs are needed for each UAP 2 with more than 320MHz RF Bandwidth.

[Table 5: Supported SFP+ Modules](#) (page 15) identifies the available SFP+ modules and the maximum range for each.

TABLE 5: Supported SFP+ Modules

CommScope PN	Description	Maximum Range
7660511	SFP+, 10GBase-SRR, Multi Mode	OM3 300m OM4 400m

TABLE 5: Supported SFP+ Modules (continued)

CommScope PN	Description	Maximum Range
7680813	SFP+, 10GBase-LR, Single Mode	10km
7803247	SFP+, 10GBase CWDM-270	40km
7803249	SFP+, 10GBase CWDM-290	40km
7803291	SFP+, 10GBase CWDM-310	40km
7803293	SFP+, 10GBase CWDM-330	40km
7803295	SFP+, 10GBase CWDM-350	40km
7803298	SFP+, 10GBase CWDM-370	40km
7803900	SFP+, 10GBase CWDM-390	40km
7803902	SFP+, 10GBase CWDM-410	40km
7803904	SFP+, 10GBase CWDM-430	40km
7803906	SFP+, 10GBase CWDM-450	40km
7801330	SFP+, 10GBase CWDM-470	40km
7801340	SFP+, 10GBase CWDM-490	40km
7801342	SFP+, 10GBase CWDM-510	40km
7801344	SFP+, 10GBase CWDM-530	40km
7801360	SFP+, 10GBase CWDM-550	40km
7801363	SFP+, 10GBase CWDM-570	40km
7801365	SFP+, 10GBase CWDM-590	40km
7801367	SFP+, 10GBase CWDM-610	40km
7832200	10G BIDI SFP+ TX1270/RX1330 10km I-temp	40km
7832202	10G BIDI SFP+ TX1330/RX1270 10km I-temp	40km
A 7832204	10G BIDI SFP+ TX1270/RX1330 40km I-temp	40km
A 7832206	10G BIDI SFP+ TX1330/RX1270 40km I-temp	40km
7843514	SFP+, LC, 1310nm, max. 40Km	40km
A 7845627	10G BIDI SFP+ TX1270/RX1330 20km I-temp	20km

TABLE 5: Supported SFP+ Modules (continued)

CommScope PN	Description	Maximum Range
A 7846857	BIDI 40km Kit 1 x Attenuator ^(a) , LC/UPC, 7dB A7843668 1 x 10G BIDI SFP+ TX1270/RX1330 40km A7832204 1 x 10G BIDI SFP+ TX1330/RX1270 40km A7832206	40km

^(a) The attenuator is needed when the measured loss is less than 5.5 dB.

Plan and Prepare For A Fiber UAP2 Installation

Do the following before beginning installation.

1. Review and know the information in [Determine the Power Consumption of the UAP2](#).
2. [UAP2 Dimensions](#).
3. Map out all cable runs.
4. Obtain any accessories required for this installation; see [UAP2 Accessories and Options](#).
5. [Unpack and Inspect the UAP2 and Accessories](#).

Determine the Power Consumption of the UAP2

Refer to individual spec sheets for the power consumption of the specific UAP2 and SFP+ models used. Consider that what is specified is the consumption at the unit itself and that voltage drop over feeder cables must be accounted for when dimensioning a remote power supply. Also consider that voltage out of a remote power supply must be sufficient such that it is in the range of -42 to -57V at the unit, after accounting for voltage drop from the feeder cables.

For example, if the UAP2 and installed SFP+ require 140W and there is a 10V drop over the feeder cables:

- The power supply must be able to output at least -52V and no more than -67V.
- At -52V output, the power supply must support 3.33A to supply 140W ($140 / 42 = 3.33$).
- If the parameters of the power supply are -52V and 3.33A, the consumption at the supply is 173W even though the demand at the unit is only 140W. This is before considering efficiency losses between mains power and power supply.

UAP2 Dimensions

Use the dimensions shown in the section applicable to this installation to determine the space required at the mounting site. Using the Hybrid Splice Box will increase the needed space; see [Figure 3: UAP2 Dimensions with Hybrid Splice Box](#) (page 21).

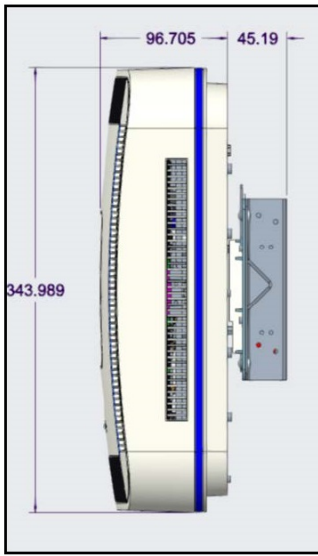
FIGURE 2: Dimensions of the UAP2 with Mounting Kit**TABLE 6:** UAP2 Dimensions & Weight

Height	344 mm (13.54")
Width	344 mm (13.54")
Depth	97 mm (3.82") + 45 mm (1.77") (Mounting Kit)
Weight	6 kg (13.2 lbs)

Unpack and Inspect the UAP2 and Accessories

1. Inspect the exterior of the shipping container(s) for evidence of rough handling that may have damaged the components in the container.
2. Unpack each container while carefully checking the contents for damage and verify with the packing slip.
3. If damage is found or parts are missing, file a claim with the commercial carrier and notify CommScope Technical Support (see [DAS and Small Cell Support](#)). Save the damaged cartons for inspection by the carrier.
4. Save all shipping containers for use if the equipment requires shipment at a future date.

Obtain the Required Materials

Contact your local CommScope sales representative to obtain the following components, as required, for this installation.

- Obtain the cable required for this installation.
 - Per the installation plan, obtain either Single Mode Fiber (SMF) or Multi Mode Fiber (MMF) that is of sufficient length to reach from the UAP2 to the Classic CAN or TEN.
- Obtain SFP+ Module pairs that are appropriate for this installation; see [SFP+ Modules](#).









Mount the Fiber UAP2

The UAP2 fiber supports the following mounting options:

- Ceiling, see [Mounting a UAP2 on a Ceiling](#)
- Wall, see [Mounting a UAP2 on a Wall](#)

General Mounting Cautions

The following cautions apply to all Fiber UAP2 installations; there may be other mounting cautions applicable to a specific mounting option, which will be defined in the applicable mounting procedure.

-  **Note:**  Attach all UAP2 securely to a stationary object as described in this installation guide.
-  **Note:**  To maintain proper ventilation, keep at least 76 mm (3-inch) clearance around the UAP2 .
-  **Note:**  The installation site must be able to bear the weight of the UAP2 ; see [Table 6: UAP2 Dimensions & Weight](#) (page 19).
-  **Note:**  The minimum distance between two UAP2s with different frequency bands is 35 cm (13.8 inches)

Mounting a UAP2 with an AC/DC Power Supply Kit

An AC/DC Power Supply Kit provides a 48V External Power Supply that converts local AC power to DC power for the UAP2 . An AC/DC Power Supply Kit can be used when an AC power source is located near the UAP2 .

Do the following to mount a UAP2 using an AC/DC Power Supply Kit.

1. Refer to and observe all cautions listed in [General Mounting Cautions](#).
2. Refer to [UAP2 Dimensions](#) to determine the mounting location, which must be able to support the weight and dimensions of the UAP2 .
3. Follow the steps in [Unpack and Inspect the UAP2 and Accessories](#).

Attach the Power Supply to the UAP2

1. Attach the Power Supply L bracket to the U bracket with the four screws provided in the Power Supply Kit.
2. Slide the Power Supply onto the L bracket and secure with the four screws provided in the Power Supply Kit.
3. Connect the Local Power Jumper Cable to the UAP2 -42 to -57 Vdc Power connector.
4. Plug AC power cord into an AC power source.

Mounting a UAP2 with a Hybrid Splice Kit

FIGURE 3: UAP2 Dimensions with Hybrid Splice Box

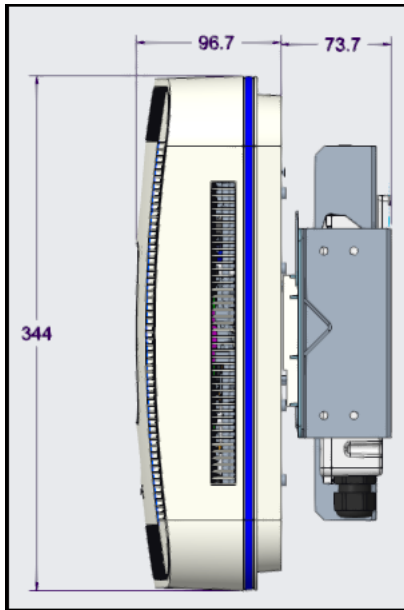

The UAP2 Hybrid Fiber Splice Box Kit (CommScope PN 7693816-xx) provides a connection solution for both power and optical signals to a UAP2. You have the option to use composite cable to transport signals from a TEN or Classic CAN via fiber and power from a remote DC supply, and then use the UAP2 Hybrid Fiber Splice Box Kit to terminate the power and fiber at the UAP2.



Note:  It is the responsibility of the customer/installer to observe the local regulations of the DC service provider and to comply with Limited Power Source (LPS) requirements where applicable.



Note:  When planning your installation, please note that the Hybrid Fiber Splice Kit increases the total depth of the installation to ~171 mm (6.73") as shown in [Figure 3: UAP2 Dimensions with Hybrid Splice Box](#) (page 21).

1. Follow the steps in [Unpack and Inspect the UAP2 and Accessories](#).
2. Refer to [UAP2 Dimensions](#) to determine the mounting location, which must be able to support the weight and dimensions of the UAP2.

Assembling and Wiring the Hybrid Fiber Splice Box

The following subsections describe how to assemble the Hybrid Fiber Splice Box and then how to wire it to provide power to the UAP2 :

- [Assembling and Wiring the Hybrid Fiber Splice Box](#) tells you how to place the wires into the Hybrid Fiber Splice Box.

- You then need to follow one of the following procedures that meets the powering requirements of this installation.
 - [Wire a Hybrid Fiber Splice Box for 4-Wire Power with Limited Power Source](#)
 - [Wire a Hybrid Fiber Splice Box for 2-Wire Power without Limited Power Source](#)

Wire the Hybrid Fiber Splice Box

Do the following to assemble and wire the Hybrid Fiber Splice Box.

1. Open the Hybrid Fiber Splice Box and remove the installation kit that is inside.

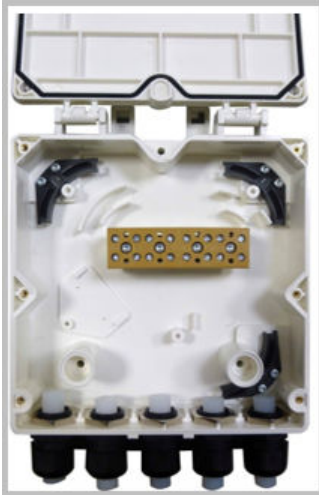

2. Using the parts from the Hybrid Fiber Splice Box, insert the Splice Holder and fasten it using a PTK 30x6 screw and one M4 washer.

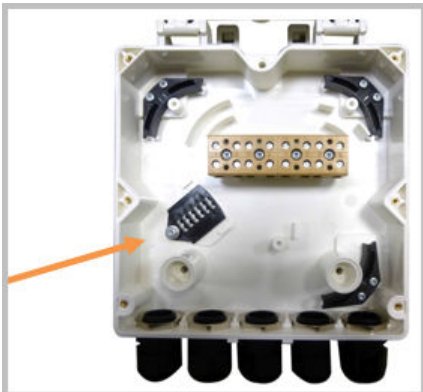

3. From the UAP2 Hybrid Fiber Splice Box Kit, insert Fiber Patch Cord in one of the cable glands indicated in the graphic.



4. Strip the insulation of the composite cable for 100 cm and the fibers for 90 cm, and then shorten the copper cables to 25 cm.

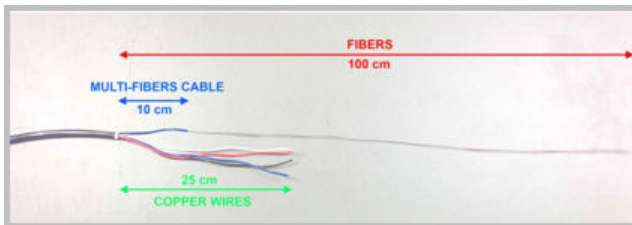

5. Insert the composite cable in the first cable gland and separate the multi-fibers cable from the copper wires. It is necessary to remove the nut to perform this action. The cable must be fed through the nut and it must be retightened once finished.

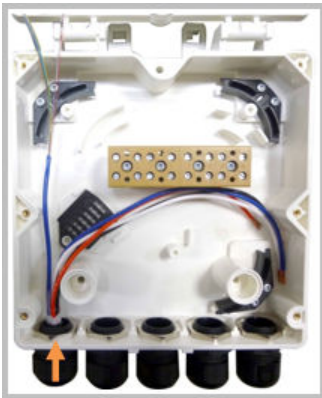

6. Bend the spliced fibers using the corner guides and fix the splices to the splice holder.

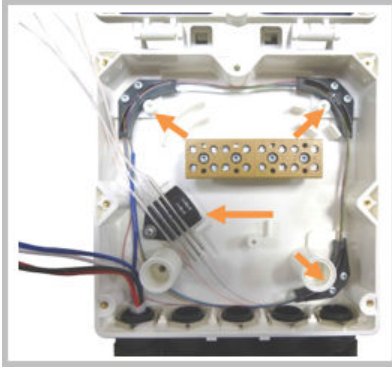

7. Bend the optical cables as shown in the picture.

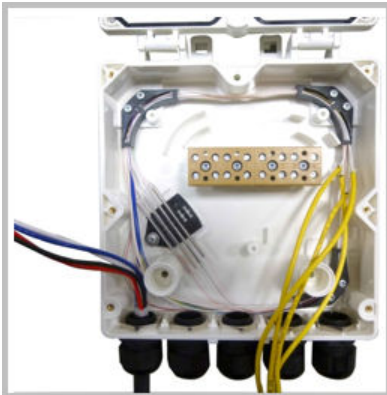

8. If a second splice holder is needed, it can be assembled using the M4 insulating washer and two M4 plain washers, as shown. The required screw is a PTK30 x 12.



9. Remove the sealing nut and rubber of the cable gland and insert the optical cables.



10. Place each cable into one of the grooves of the seal insert.



11. Press the seal insert into the clamp ring opening.

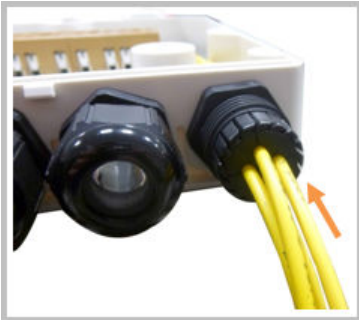

12. Fix the optical cables inside the box using one cable tie and tighten the sealing nut.

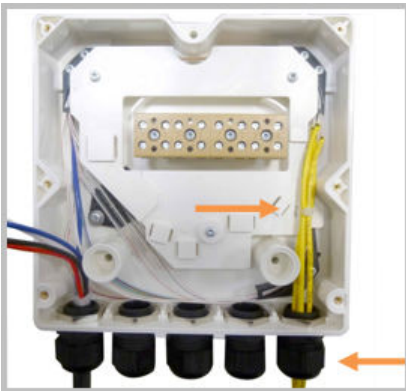

13. It is possible to separate the optical cables and use two different cable glands. Remove the sealing nut and rubber on each cable gland.

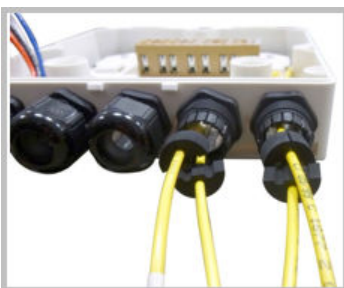

14. Close all unused grooves with the plastic cylinders, no matter if one or two cable glands are used.



15. Insert the copper wires in the first multiple terminal connectors. See markings on the internal support. Then fasten the copper cables inside the box using one cable tie.

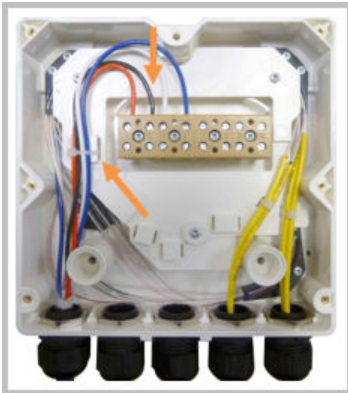

16. Remove the sealing nut and insert the UAP2 supply cable and tighten the sealing nut.



17. Connect the supply cable to the terminal strip and fix it inside the box using one cable tie.

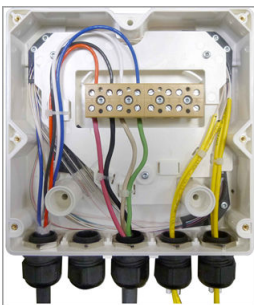

18. Complete the steps in [Mount the Fiber UAP2](#).

Wire a Hybrid Fiber Splice Box for 4-Wire Power with Limited Power Source

Use the 4-wire power setup when Limited Power Source (LPS) is required by local electrical/safety codes. Each UAP2 can accept two Limited Power Sources from the DC PSU where local regulations require it.

In the following wiring procedure, you will connect the power wires from the Hybrid Fiber Splice Box to a DC Power Supply Unit (PSU).



Note:  The color code of the hybrid fiber cable in the following tables and diagrams is for example purposes only. The color of the wires may be different than the examples depending on the type and manufacturer of the composite hybrid cable.

1. Refer to [Table 7: 4-Wire Power Wiring with LPS](#) (page 27) and [Figure 4: Wiring a Hybrid Fiber Splice Box for 4-Wire Power with LPS](#) (page 27) to wire a Hybrid Fiber Splice Box for 4-Wire power with Limited Power Source (LPS).



Note:  All four pins of the proprietary UAP2 4-pin -42 to -57 Vdc Power connector must be terminated.

TABLE 7: 4-Wire Power Wiring with LPS

Hybrid Cable Two Circuits	UAP2 Power Cable		
	Wire	Pin	Function
Circuit 1 (0V)	Red	1	V1+
Circuit 1 (-42 to -57V)	White	2	V1-
Circuit 2 (0V)	Black	3	V2+
Circuit 2 (-42 to -57V)	Green	4	V2-

FIGURE 4: Wiring a Hybrid Fiber Splice Box for 4-Wire Power with LPS

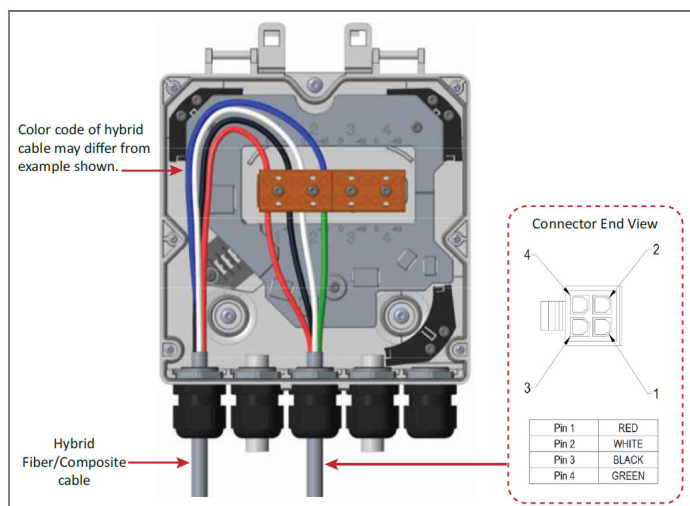

2. After you have wired the Hybrid Fiber Splice box, complete the steps in [Mounting a UAP2 on a Ceiling](#) or [Mounting a UAP2 on a Wall](#).

Wire a Hybrid Fiber Splice Box for 2-Wire Power without Limited Power Source

Each UAP2 can be powered by 2 wires if LPS from the DC PSU are not required by local regulations.



Note: ⚠ All four pins of the proprietary UAP2 4-pin -42 to -57 Vdc Power connector must be terminated.

1. Refer to [Table 8: Wiring Single Circuit Source to a UAP2](#) (page 28) and [Figure 5: Wiring a Hybrid Fiber Splice Box for 2-Wire Power without LPS](#) (page 28) to wire a Hybrid Fiber Splice Box for 2-Wire power without an Limited Power Source (LPS).

In this power variation you must tie the following power cables together:

- V1+ (PIN 1) and V2+ (PIN 3) (UAP2 DC Jumper Power Cable Red and White wires)
- V1- (PIN 2) and V2- (PIN 4) (UAP2 DC Jumper Power Cable Black and Green wires)

TABLE 8: Wiring Single Circuit Source to a UAP2

Source Cable	UAP2 Power Cable		
	Wire	Pin	Function
Circuit 1 (0V)	Red	1	V1+
	White	3	V2+
Circuit 1 (--42 to --57V)	Black	2	V1-
	Green	4	V2-

FIGURE 5: Wiring a Hybrid Fiber Splice Box for 2-Wire Power without LPS

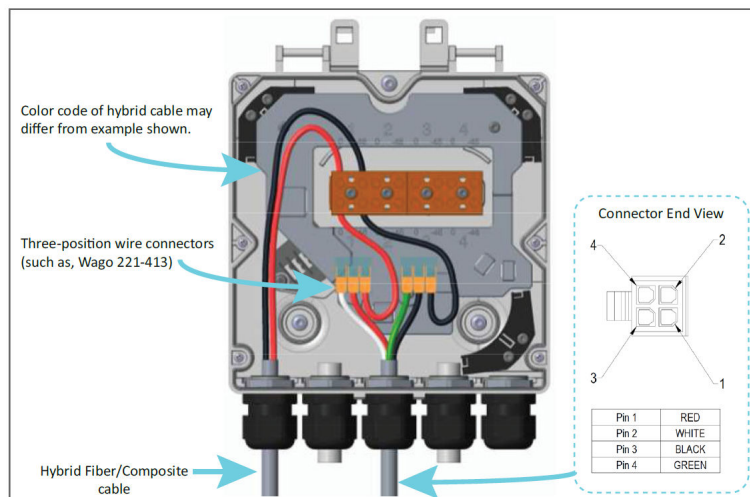

2. After you have wired the Hybrid Fiber Splice box, complete the steps in [Mounting a UAP2 on a Ceiling](#) or [Mounting a UAP2 on a Wall](#).

Mounting a UAP2 on a Ceiling



Note: The drop rail is NOT included with the UAP2 and needs to be ordered separately. In the NAR market, this drop rail can be ordered as part OC-BA50A. In other markets the drop rail may not be available as a CommScope part number; look for compatible third-party options such as the Eaton BA50A.

Before starting the UAP2 ceiling installation, go to [Connect the Fiber UAP2 to a Classic CAN or TEN](#).

1. Follow the steps in [Unpack and Inspect the UAP2 and Accessories](#).
2. Refer to and observe all cautions listed in [General Mounting Cautions](#).
3. Refer to [UAP2 Dimensions](#) to determine the mounting location, which must be able to support the weight and dimensions of the UAP2.
4. Remove two adjacent ceiling tiles.

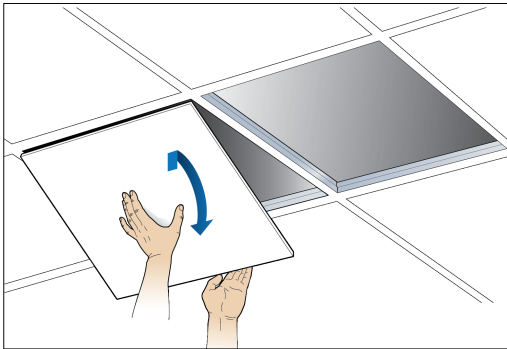

5. Mark and cut the opening according to the dimensions in the following drawing.

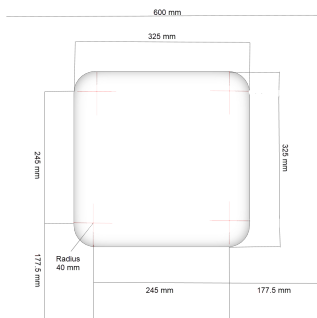

6. Replace the cutout tile in the ceiling. (Leaving the adjacent tile out.)

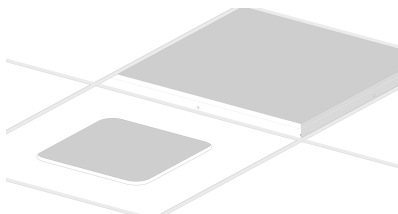

7. Attach the splice box U-bracket to the drop rail.

- a. Slide the tab on the clamp into the U-bracket hole.
- b. Align the hole on the clamp with the hole on the U-bracket.
- c. Tighten the screws (torque 14 nm).

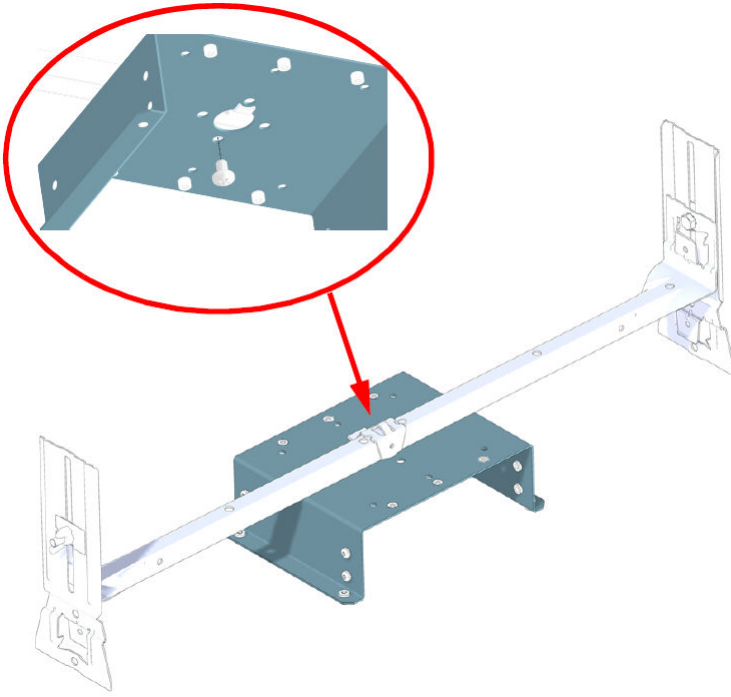

8. For AC power configurations only, attach the Power Supply L-bracket to the U-bracket with the four screws provided in the UAP2 kit.

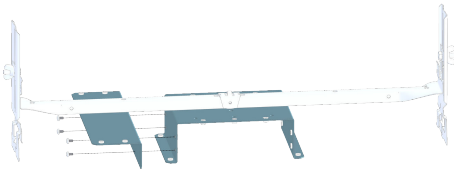

9. Slide the Power Supply onto the L-bracket and secure with the four screws provided in the Power Supply Kit.

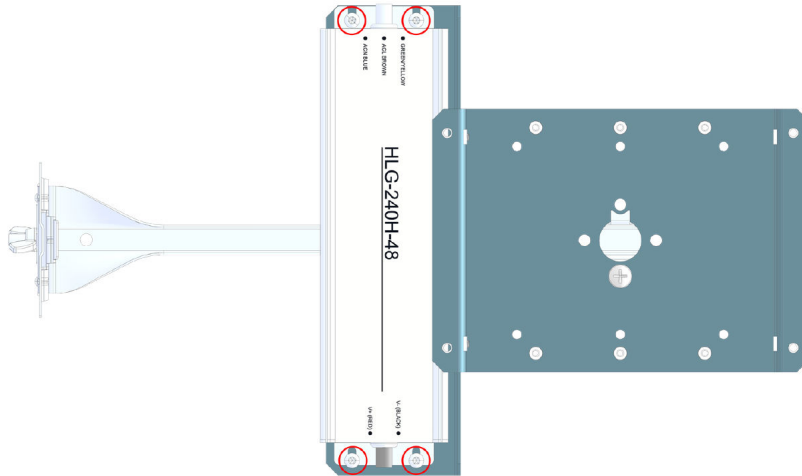

10. Insert the drop rail on the ceiling tile rails over the cut out tile.

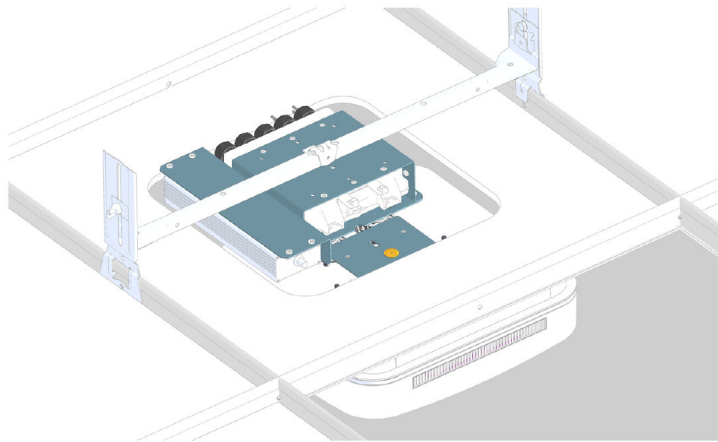

11. Loosen the six screws and open splice box cover and connect the wires to the wire block. For information on the splice box wiring, see [Mounting a UAP2 with a Hybrid Splice Kit](#).

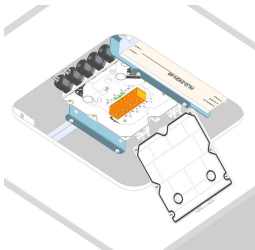

12. Close splice box cover and tighten screws.

13. Remove the angle brackets from the splice box plate.

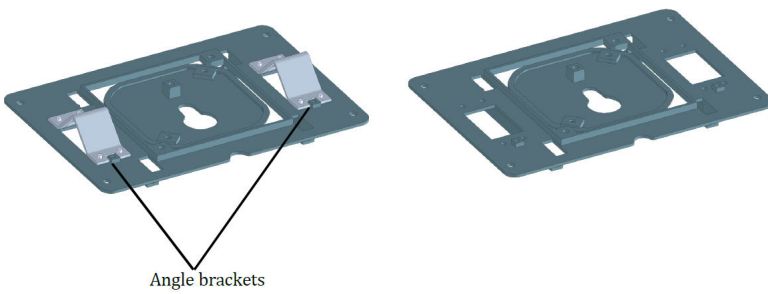

14. Attach the splice box plate to the splice box with the four screws included in the mounting kit.

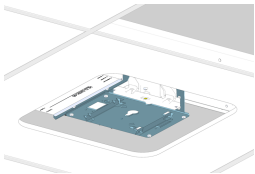

15. Attach the base plate to the UAP2 .

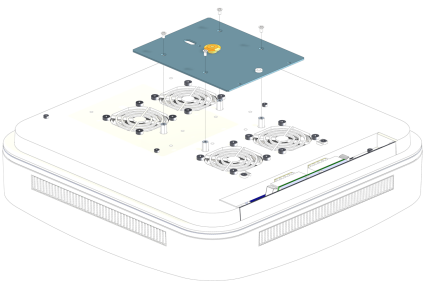

16. Insert the SFP+ modules in the UAP2 Primary and Secondary ports. Depending on the configuration, one or two SFP+ modules (Primary and Secondary) may be required.

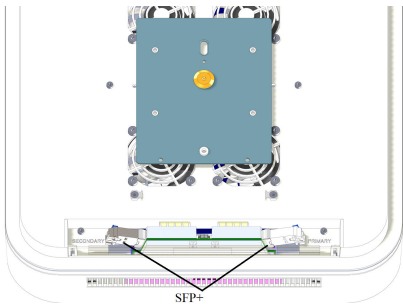

17. Lift the UAP2 to the splice box plate.

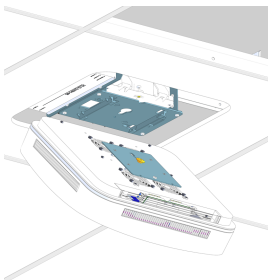

18. Connect the cables from the splice box to the UAP2 SFP+ modules. Depending on the configuration, there may be one cable (Primary) or two cables (Primary and Secondary).
19. If using a PSU, connect the PSU cable to the connector on the UAP2.

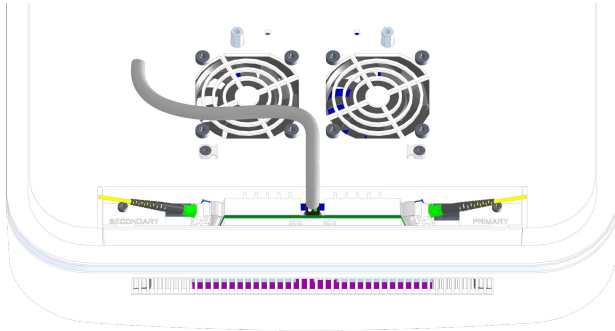

20. Attach the UAP2 to the splice box base plate.

- a. Align the keyhole opening on the splice box mounting plate with the button on the AP mounting

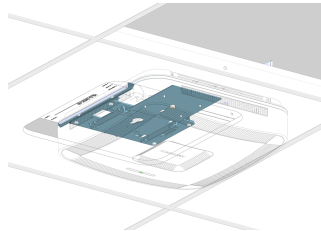
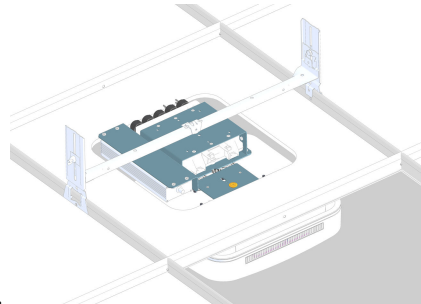

plate.

- b. Insert the AP into the splice box mounting plate slot and slide until the AP plate meets the tabs on



the splice box plate.

- c. Tilt up the drop rail bar to insert the UAP2 in the ceiling tile cut out.

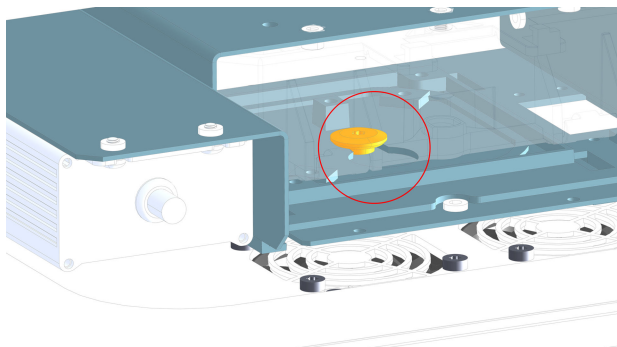

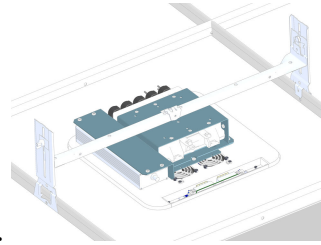

- d. Lift the UAP2 vertically and slide it into the locked position.
21. If using a PSU, plug the AC power cord into an AC power source.
22. Replace the ceiling tile next to the UAP2.

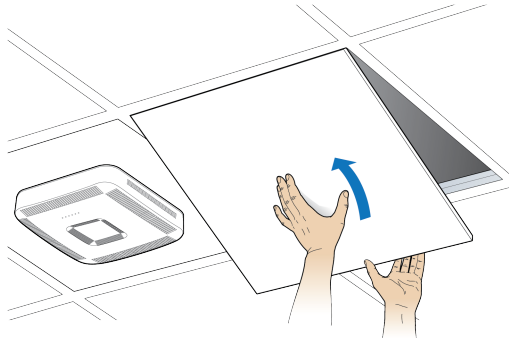

Mounting a UAP2 on a Wall

Before starting the UAP2 wall installation, go to [Connect the Fiber UAP2 to a Classic CAN or TEN](#).

1. Follow the steps in [Unpack and Inspect the UAP2 and Accessories](#).
2. Refer to and observe all cautions listed in [General Mounting Cautions](#).
3. Refer to [UAP2 Dimensions](#) to determine the mounting location, which must be able to support the weight and dimensions of the UAP2 .
4. On the wall, use the U-bracket as a template to mark the holes at the location where you will mount the UAP2.

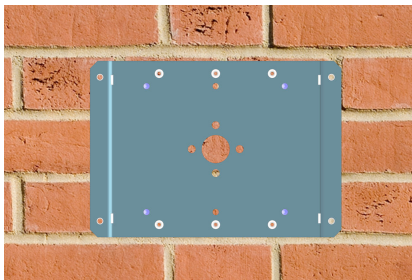

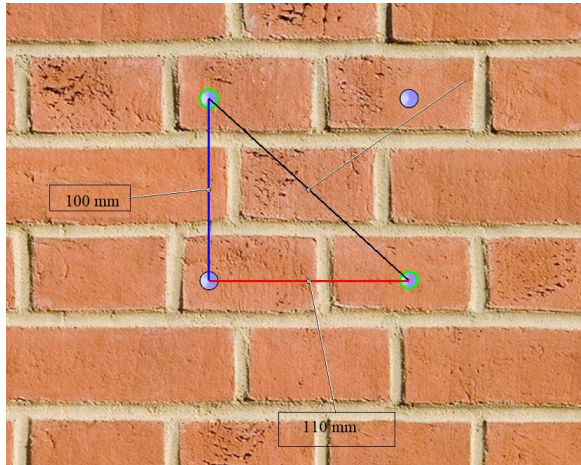

5. Attach the U-bracket to the wall with four anchor screws.



Note:  The anchor screws are not provided by CommScope. Follow the local building codes to determine the anchor screw and torque required.

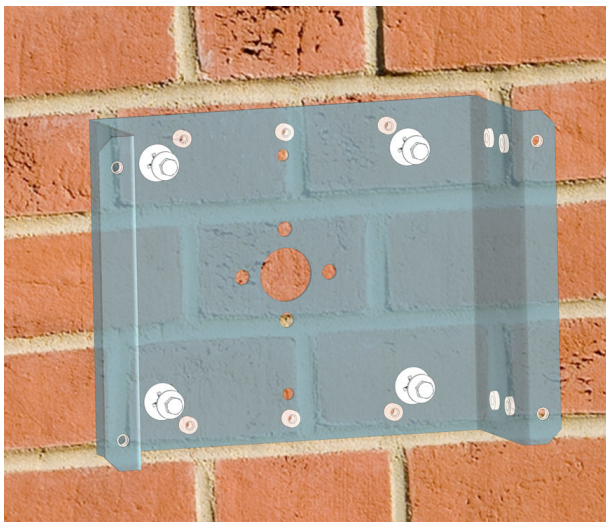

6. For AC power configurations only, attach the PSU L-bracket to the U-bracket using the four M4 screws provided in the mounting kit.

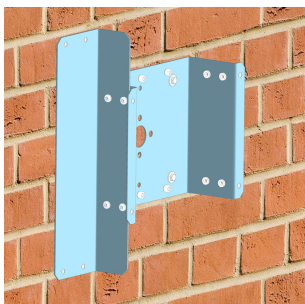

7. For AC power configurations only, attach the PSU to the L-bracket using the four M4 screws provided in the mounting kit.

8. Attach the splice box to the U-bracket.
 - a. Open the splice box cover.
 - b. Attach the splice box to the U-bracket using the three M4 screws provided in the mounting kit.
 - c. Close the cover and tighten the screws.
9. Remove the angle brackets from the splice box plate.

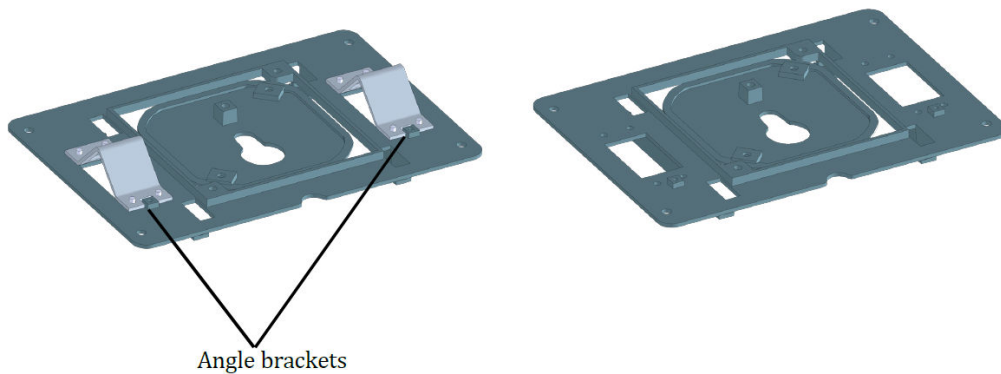

10. Attach the splice box plate to the splice box with the four M4 screws included in the mounting kit.

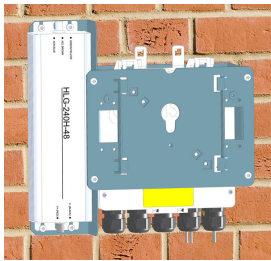

11. Attach the base plate to the UAP2.

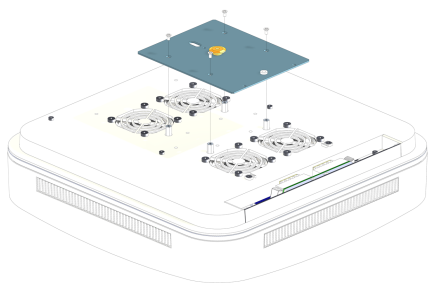

12. Insert the SFP+ modules in the UAP2 Primary and Secondary ports. Depending on the configuration, one or two SFP+ modules (Primary and Secondary) may be required.

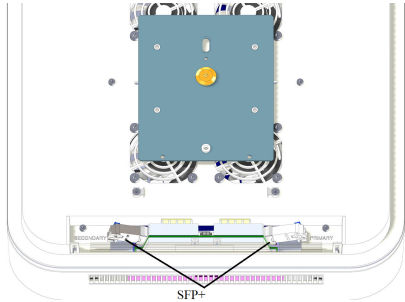

13. Lift the UAP2 close to the splice box plate.

- a. Connect the cables from the splice box to the UAP2 SFP+ modules. Depending on the configuration, there may be one cable (Primary) or two cables (Primary and Secondary).
- b. For AC power configurations only, connect the PSU cable to the connector on the UAP2.

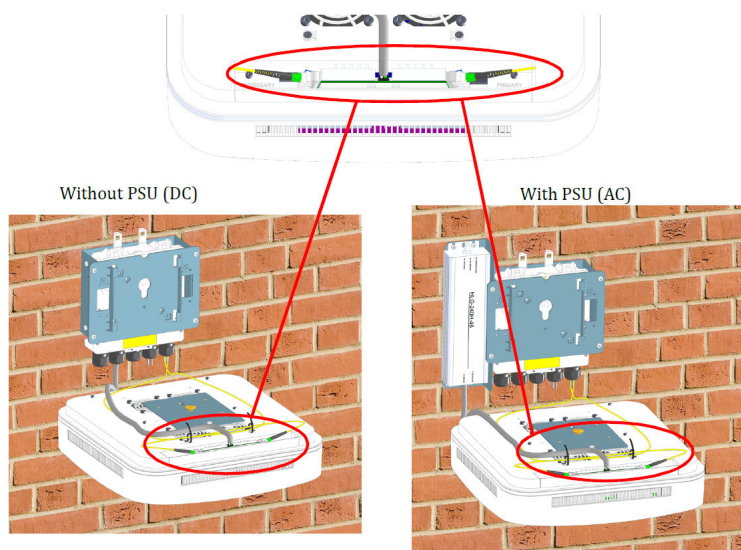

14. Attach the UAP2 to the splice box base plate.

- a. Align the keyhole opening on the splice box mounting plate with the button on the AP mounting plate.
- b. Insert the AP into the splice box mounting plate slot and slide until the AP plate meets the tabs on the splice box plate.

15. Push the UAP2 downward and slide it into the locked position.

16. If using a PSU, plug the AC power cord into an AC power source.

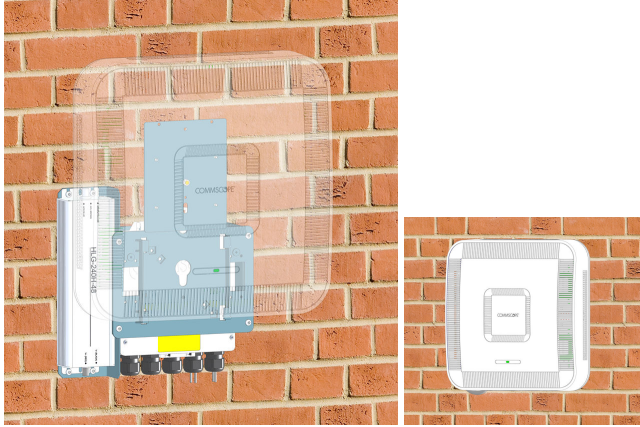

Connect the Fiber UAP2 to a Classic CAN or TEN

1. Connect the UAP2 Primary (red) Port for this installation.
2. Clean the connectors on the SMF or MMF following the fiber supplier's recommendations.
3. Install the SFP+ connector on the end of the SMF or MMF that will connect to the UAP2 .
Follow the limitations per the maximum range described in [SFP+ Modules](#).
4. Connect the other end of the SMF or MMF to a matching SFP+ in an open port on an OPT Card installed in Slots L1-L4 in the TEN or Classic CAN. WCS Slots L5-L8 cannot be used to connect APs.



Note: If installing a UAP2 with the Hybrid Fiber Splice Box Kit (PN 7781091-xx), the fiber optical cable will be hanging from the Hybrid Fiber Splice Box.

5. To support more than 320MHz RF Bandwidth, repeat [Step 1](#) (page 38) to [Step 4](#) (page 38) using the blue Secondary port on the UAP2 and an adjacent port on the same OPT card.

Powering on a Fiber UAP2

The UAP2 is powered on as soon as power is connected to it. Under normal operating conditions, the Power LED turns on briefly when the unit is first detected. It will then go out briefly, followed by an initialization period during which the Power LED flashes slowly while the UAP2 is configured. The Power LED remains a steady green (not flashing) once the unit reaches a fully operational state, which typically occurs within 45 seconds.

The Power LED behavior for a Fiber UAP2 is as follows:

- Initial flash on and then off—UAP2 has power applied but no fiber link is established to a CAN/TEN or to a primary fiber UAP2.
- Steady green—UAP2 is powered on and operational.
- Slow flashing green—UAP2 is powered on and initializing.
- Rapid flashing green—UAP2 Unit Identifier active via the **Flash LED** function in the ERA GUI.
- Slow-Flashing Red—The ERA GUI is reporting a critical alarm for the unit. The AP can be recovered without replacing hardware.
- Steady Red—The ERA GUI is reporting a critical alarm for the unit. The AP or SFP+ must be replaced.

Contacting CommScope

This chapter tells you how to contact CommScope for additional information or for assistance.

Hardware to Software Mapping Information

- To view or download a document that lists the minimum software requirements for ERA and ION-E hardware, do one of the following:
 - Scan the QR Code below.
 
 - If viewing this document online as a PDF, click on the following URL link: <http://www.commscope.com/resources/in-building-wireless/era>
- Click on the **ERA SW to HW Mapping** document link to open it, or right click on the link and select the **Save Target as...** option from the contextual menu.

DAS and Small Cell Technical Support

The following sections tell you how to contact the DAS and Small Cell Technical Support team. Support is available 7 days a week, 24 hours a day.

Telephone Helplines

Use the following Helpline telephone numbers to get live support, 24 hours a day:

24x7	+1 888-297-6433 (Toll free for U.S. and Canada)
EMEA 8:00-17:00 (UTC +1)	+ 800 73732837 (Toll free for parts of EMEA and Australia)
	+ 49 909969333 (Toll charge incurred)
	Calls to an EMEA Helpline outside of the 8:00 to 17:00 time frame will be forwarded to the 24x7 Helpline.

Online Support

To go to the CommScope Wireless Support Request web site from which you can initiate a Technical Support ticket, do one of the following:

- Scan the QR Code below.



- If viewing this document online as a PDF, click on the following URL link: <http://www.commscope.com/wisupport>
- Enter the preceding URL into your web browser, and then press **ENTER** on your keyboard.

Waste Electrical and Electronic Equipment Recycling

Country specific information about collection and recycling arrangements per the Waste Electrical and Electronic Equipment (WEEE) Directive and implementing regulations is available on CommScope's website. To access information on the CommScope recycling program, do any of the following:

- Scan the QR Code below.



- If viewing this document online as a PDF, click on the following URL link: <http://www.commscope.com/corporate-responsibility-and-sustainability/environment/weee-customer-recycling/>
- Enter the preceding URL into your web browser, and then press **ENTER** on your keyboard.

DAS and Small Cell Technical Training

1. To access training on the online technical training site, please use the following web address or scan the



QR code to the right: <https://commscopeuniversity.com>

2. Once you have logged in, you can search for training by typing search words in the **Search** bar or by going to the **Catalog** page to view the available courses.
3. Instructor-led courses are conducted in North America and Europe. Before choosing a course, please verify the region.
4. For training related questions, please contact us: icn_training@commscope.com

Accessing ERA User Documentation

1. Access to the Customer Portal requires a user account. If you don't have an account:
 - a. Visit My CommScope at <https://www.mycommscope.com>.
 - b. Click New User Registration and follow the prompts.
 - c. After you've registered in My CommScope, click the Request Additional Access button and select the DAS and Small Cell Customer Portal from the list of applications.
2. Scan the QR Code below to go directly to the DAS and Small Cell Customer Portal.



Alternatively, visit MyCommScope and use the DAS and Small Cell Customer Portal Application.

3. In Tools and Documentation, search by product, document category or title.
4. Click on the title of any document to open it.

