

Test Site:  
 FCC Test Site No.: 96997  
 IC OATS No.: IC3475A-1



# ECL-EMC Test Report No.: 14-196

**Equipment under test:** TFAH-ES70/80/50 500MHz Path  
**FCC ID:** XS5-TFAHES7850

**Type of test:** FCC 47 CFR Part 90 Subpart I: 2014  
 Private Land Mobile Repeater

**Measurement Procedures:** 47 CFR Parts 2:2014 (*Frequency Allocations and Radio Treaty Matters; General Rules and Regulations*), Part 90:2014 (Private Land Mobile), ANSI/TIA-603-C (2004), *Land Mobile FM or PM Communications Equipment Measurement and Performance Standards*

**Test result:** Passed

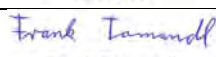
Date of issue:	11.09.14		Signature:
Issue-No.:	01	Author:	 Tom Zahlmann Test engineer Digitally signed by Tom Zahlmann DN: cn=Tom Zahlmann, o=Bureau Veritas CPS, ou=ECL, email=tom.zahlmann@de.bureauveritas.com, c=DE Date: 2014.09.11 10:41:00 +02'00'
Date of delivery:	11.08.14	Checked:	 Frank Tomandl Project manager EMC Digital unterschrieben von Frank Tomandl DN: cn=Frank Tomandl, o=Bureau Veritas CPS, ou=ECL, email=frank.tomandl@de.bureauveritas.com, c=DE Datum: 2014.09.11 14:51:18 +02'00'
Test dates:	17.02. – 12.08.14		
Pages:	76		

Test Report No.: 14-196

FCC ID: XS5-TFAHES7850



**Manufacturer:** ANDREW Wireless Systems GmbH  
Industriering 10

D-86675 Buchdorf

Tel.: +49 (0)9099 69 0

Fax: +49 (0)9099 69 140

**Test Location:** Bureau Veritas Consumer Products Services  
Germany GmbH

European Compliance Laboratory (ECL)

Thurn-und-Taxis-Straße 18

D-90411 Nürnberg

Tel.: +49 40 74041 0

Fax: +49 40 74041-2755

**General:**

The purpose of this report is to show compliance to the FCC regulations for licensed devices operating under section 90 of the Code of Federal Regulations title 47.

This report informs about the results of the RF tests, it only refers to the equipment under test. No part of this report may be reproduced in any form, without written permission.



## Table of contents

1	TEST RESULTS SUMMARY .....	5
2	EQUIPMENT UNDER TEST (E.U.T.) .....	6
2.1	DESCRIPTION .....	6
2.1.1	DOWNLINK .....	6
2.1.2	UPLINK .....	6
2.1.3	DESCRIPTION OF EUT .....	6
2.1.4	BLOCK DIAGRAM OF MEASUREMENT REFERENCE POINTS .....	7
2.1.5	DOWNLINK SYSTEM GAIN AND OUTPUT POWER .....	7
3	TEST SITE (ANDREW BUCHDORF) .....	8
3.1	TEST ENVIRONMENT .....	8
3.2	TEST EQUIPMENT .....	8
3.3	INPUT AND OUTPUT LOSSES .....	9
3.4	MEASUREMENT UNCERTAINTY .....	9
4	TEST SITE (BUREAU VERITAS CONSUMER PRODUCTS SERVICES) .....	9
5	RF POWER OUT: §90.635, §2.1046 .....	10
5.1	LIMIT .....	10
5.2	TEST METHOD .....	10
5.3	TEST RESULTS .....	11
5.3.1	DOWNLINK .....	12
5.3.1.1	Band # 1 .....	14
5.3.1.2	Band # 2 .....	15
5.3.1.3	Band # 3 .....	17
5.3.1.4	Band # 4 .....	18
5.3.2	UPLINK .....	20
5.4	SUMMARY TEST RESULT .....	20
6	OCCUPIED BANDWIDTH: §90.210, §2.1049 .....	21
6.1	LIMIT .....	21
6.2	TEST METHOD .....	21
6.3	TEST RESULTS .....	22
6.3.1	DOWNLINK .....	22
6.3.1.1	Band # 1 .....	23
6.3.1.2	Band # 2 .....	26
6.3.1.3	Band # 3 .....	29
6.3.1.4	Band # 4 .....	32
6.3.2	UPLINK .....	35
6.4	SUMMARY TEST RESULT .....	35
7	SPURIOUS EMISSIONS AT ANTENNA TERMINALS: §90.210, §2.1051 .....	36
7.1	LIMIT .....	36



7.2	TEST METHOD .....	36
7.3	TEST RESULTS .....	37
7.3.1	DOWNLINK .....	37
7.3.1.1	Band # 1 .....	40
7.3.1.2	Band # 2 .....	43
7.3.1.3	Band # 3 .....	46
7.3.1.4	Band # 4 .....	49
7.3.1.5	Band # 1 .....	52
7.3.1.6	Band # 2 .....	53
7.3.1.7	Band # 3 .....	55
7.3.1.8	Band # 4 .....	56
7.3.2	UPLINK .....	58
7.4	SUMMARY TEST RESULT .....	58
8	OUT OF BAND REJECTION .....	58
8.1	LIMIT .....	58
8.2	TEST METHOD .....	58
8.3	TEST RESULTS .....	58
8.3.1	DOWNLINK .....	59
8.3.2	UPLINK .....	59
8.4	SUMMARY TEST RESULT .....	59
9	NOISE FLOOR .....	60
10	RADIATED SPURIOUS EMISSIONS AT THE ECL (BUREAU VERITAS): §90.210, §2.1053, RSS-GEN, RSS-131 .....	61
10.1	METHOD OF MEASUREMENT .....	64
10.2	LIMIT .....	65
10.3	CLIMATIC VALUES IN THE LAB .....	65
10.4	TEST RESULTS .....	66
10.4.1.1	30 MHz to 1 GHz Downlink ( <u>B</u> ottom – <u>M</u> iddle – <u>T</u> op).....	66
10.4.1.2	30 MHz to 1 GHz Downlink (Middle of all bands).....	70
10.4.1.3	1 GHz to 21 GHz Downlink ( <u>B</u> ottom – <u>M</u> iddle – <u>T</u> op).....	71
10.4.1.4	30 MHz to 1 GHz Downlink (Middle of all bands).....	75
11	HISTORY .....	76



## 1 Test Results Summary

Name of Test	FCC Para. No.	FCC Method	FCC Spec.	Result
RF Power Output	90.635	2.1046	1000 Watts	Complies
Occupied Bandwidth	90.210	2.1049	Input/Output	Complies
Spurious Emissions at Antenna Terminals	90.210	2.1051	-13dBm	Complies
Radiated Spurious emission	90.543	2.1053	-13dBm	Complies
Frequency Stability	90.213	2.1055	1 ppm	NA
Out of Band Rejection	KDB 935210 D02 v02	KDB 935210 D02 v02	KDB 935210 D02 v02	Complies
Noise floor	KDB 935210 D02 v02	KDB 935210 D02 v02	KDB 935210 D02 v02	Complies

Frequency stability is given by: The system gets an electrical analog signal from the BSS which is converted into an analog optical signal, transmitted by the optical links and then reconverted in the Remote Unit into an analog electrical signal. During this process happens no frequency change/modification, so input and output have same frequency what can be seen under capture "Occupied Bandwidth".



## 2 Equipment under test (E.U.T.)

### 2.1 Description

Kind of equipment	TFAH-ES70/80/50
Andrew Ident. Number	Id. No. TFAH-ES70/80/50
Serial no.(SN)	10
Revision	00
Software version and ID	n. a.
Type of modulation and Designator	F3E (Voice) <input checked="" type="checkbox"/> C4FM (D7W) <input checked="" type="checkbox"/> H-DQPSK (D1W) <input checked="" type="checkbox"/>
Frequency Translation	F1-F1 <input checked="" type="checkbox"/> F1-F2 <input type="checkbox"/> N/A <input type="checkbox"/>
Band Selection	Software <input type="checkbox"/> Duplexer <input type="checkbox"/> Full band <input checked="" type="checkbox"/>

#### 2.1.1 Downlink

Pass band	406 MHz – 512 MHz
Band # 1	406.1 MHz – 454 MHz
Band # 2	456.0 MHz – 462.5375 MHz
Band # 3	462.7375 MHz – 467.5375 MHz
Band # 4	467.7375 MHz – 512 MHz
Max. composite output power based on one carrier per pass band (rated)	18 dBm = 0.063 W
Gain*	15 dB

\*see 2.1.5

#### 2.1.2 Uplink

Pass band	n. a.
Gain*	n. a.

\*see 2.1.5

Note: The EUT does not transmit over the air in the uplink direction.

#### 2.1.3 Description of EUT

TFAH-ES70/80/50 is a multi-band, multi-operator remote unit configuration used in conjunction with a master unit in the ION optical distribution system. This system transports up to three frequency bands simultaneously (500 MHz, 700 MHz, and 800MHz), providing a cost-effective solution for distributing capacity from one or more base stations.

This Test Report describes only the approval of the 500 MHz path



### 2.1.4 Block diagram of measurement reference points

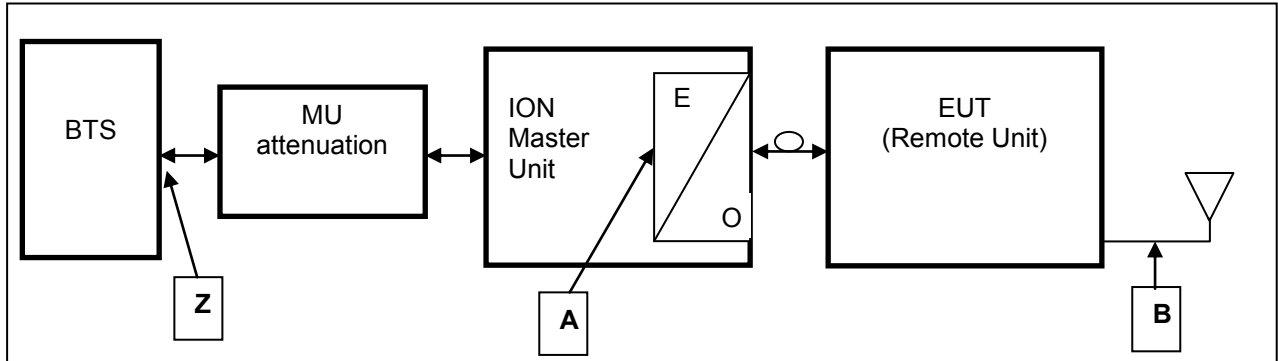

figure 2.1.4-#1 Block diagram of measurement reference points

Remote Unit is the EUT

O/E                      Optical / Electrical converter  
 SRMU                    Sub Rack Master Unit

Reference point A	SRMU	UL output,	DL input
Reference point B	Remote Unit	DL output,	UL input
Reference point Z	BTS	DL output,	UL input

Downlink:                      Measure from reference point B to A

Since a signal generator does not supply a good output signal with +33 or +43dBm, for the downlink measurement the MU Attenuation is not used.

That means for downlink measurements the signal generator is connected to measurement point A at the master optical / electrical converter and the analyzer to the measurement point B at the RU.

### 2.1.5 Downlink System Gain and Output Power

System optimized for BTS power	MU Attenuation <i>(manual leveling)</i>	Maximum rated input power at the MU OTRX	RU Gain	Maximum rated output power at RU Antenna port
<b>Z</b>		<b>B</b>	<b>B to A</b>	<b>A</b>
<b>+33 dBm</b>	<b>30 dB</b>	<b>3 dBm</b>	<b>+15 dB</b>	<b>+18.0 dBm</b> <i>@ 1 carrier</i>
<b>System Gain Z to B</b>	<b>-15 dB</b>			
<b>+43 dBm</b>	<b>40 dB</b>	<b>3 dBm</b>	<b>+15 dB</b>	<b>+18.0 dBm</b> <i>@ 1 carrier</i>
<b>System Gain Z to B</b>	<b>-25 dB</b>			

table 2.1.5-#1 Equipment under test (E.U.T.) Description Downlink System Gain and Output Power



### 3 Test site (Andrew Buchdorf)

#### 3.1 Test environment

All tests were performed under the following environmental conditions:

Condition	Minimum value	Maximum value
Barometric pressure	86 kPa	106 kPa
Temperature	15°C	30°C
Relative Humidity	20 %	75 %
Power supply range	±5% of rated voltages	
Test Voltage	230V AC 50Hz	

#### 3.2 Test equipment

ANDREW Inv. No.	Test equipment	Type	Manufacturer	Serial No.	Calibration
9102	Network Analyzer	ZVB14	R&S	100118	08/14
9054	Spectrum Analyzer	FSV13	R&S	100859	12/14
9233	Signal Generator	SMBV100A	R&S	257777	06/15
8849	Signal Generator	SMU200A	R&S	101732	04/15
8671	Power Meter	E4418B	Agilent	GB39513094	06/15
8672	Power Sensor	E9300H	Agilent	US41090179	06/15
7306	Circulator	C25E-1FFF	AEROTEK	12580	CIU
7307	Circulator	C25E-1FFF	AEROTEK	12581	CIU
7408	RF-Cable	2,0m; N-N	Andrew	---	CIU
7409	RF-Cable	2,0m; N-N	Andrew	---	CIU
7410	RF-Cable	1,0m; N-N	Andrew	---	CIU
7411	RF-Cable	2,0m; N-N	Andrew	---	CIU
7373	RF-Cable	Multiflex141	Andrew	---	CIU
7374	RF-Cable	Multiflex141	Andrew	---	CIU
7437	RF-Cable	Multiflex141	Andrew	---	CIU
7438	RF-Cable	Multiflex141	Andrew	---	CIU
7439	RF-Cable	Multiflex141	Andrew	---	CIU
7443	RF-Cable	Multiflex141	Andrew	---	CIU
7444	RF-Cable	Multiflex141	Andrew	---	CIU
7445	RF-Cable	Multiflex141	Andrew	---	CIU
7446	RF-Cable	Multiflex141	Andrew	---	CIU
7447	RF-Cable	Multiflex141	Andrew	---	CIU
7448	RF-Cable	Multiflex141	Andrew	---	CIU
7449	RF-Cable	Multiflex141	Andrew	---	CIU
7450	RF-Cable	Multiflex141	Andrew	---	CIU
7440	RF-Cable	RG-223 0.8m	Andrew	---	CIU
7441	RF-Cable	RG-223 0.8m	Andrew	---	CIU
7453	RF-Cable	RG223 2m SMA.	Andrew	---	CIU
7454	RF-Cable	RG223 2m SMA.	Andrew	---	CIU
7455	RF-Cable	RG223 2m SMA.	Andrew	---	CIU
7144	Attenuator	2N-20dB	Inmet 64671	---	CIU
7341	Power Attenuator	768-20	Narda	---	CIU
7368	Matrix		COMMSCOPE	---	weekly

CIU = Calibrate in use





### 3.3 Input and output losses

All recorded power levels should be referenced to the input and output connectors of the repeater, unless explicitly stated otherwise.

The test equipment used in this test has to be calibrated, so that the functionality is also checked.

All cables, attenuators, splitter, isolator, circulator and combiner etc. must be measured before testing and used for compensation during testing.

### 3.4 Measurement uncertainty

The extended measurement uncertainty corresponds to the measurement results from the standard measurement uncertainty multiplied by the coverage factor  $k=2$ . The true value is located in the corresponding interval with a probability of 95 %.

## 4 Test site (Bureau Veritas Consumer Products Services)

FCC Test site: 96997  
IC OATS: IC3475A-1

See relevant dates under section 10 of this test report.



## 5 RF Power Out: §90.635, §2.1046

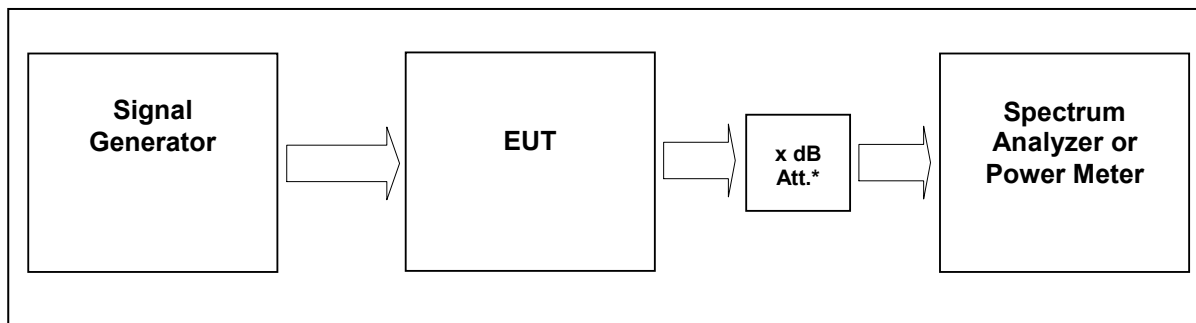

External Attenuator DL      x dB = 20 dB  
figure 5-#1 Test setup: RF Power Out: §90.635, §2.1046

Measurement uncertainty	± 0,38 dB
Test equipment used	9054, 9233, 7444; 7306; 7144; 7454; 7453; 7341; 7449; 7368

### 5.1 Limit

Para. No. 90.205. The maximum allowable station ERP is dependent upon the stations HAAT and required service area and will be authorized in accordance with Table 1 and 2 of 90.205(g) (h) (i).

### 5.2 Test method

§ 2.1046 Measurements required: RF power output.

(a) For transmitters other than single sideband, independent sideband and controlled carrier radiotelephone, power output shall be measured at the RF output terminals when the transmitter is adjusted in accordance with the tune-up procedure to give the values of current and voltage on the circuit elements specified in § 2.1033(c)(8). The electrical characteristics of the radio frequency load attached to the output terminals when this test is made shall be stated.

(c) For measurements conducted pursuant to paragraphs (a) and (b) of this section, all calculations and methods used by the applicant for determining carrier power or peak envelope power, as appropriate, on the basis of measured power in the radio frequency load attached to the transmitter output terminals shall be shown. Under the test conditions specified, no components of the emission spectrum shall exceed the limits specified in the applicable rule parts as necessary for meeting occupied bandwidth or emission limitations

Test Report No.: 14-196

FCC ID: XS5-TFAHES7850



---

### 5.3 Test Results

Detector RMS.

Test signal Analog:

FM signal with 3.0 kHz deviation and 2.5 kHz rate and sine waveform.

Test signal APCO Phase1 C4FM:

Modulation 4FSK, with 1.8 kHz deviation and 4.8 ksym/s symbol rate

Test signal APCO Phase2 H-DQPSK:

Modulation pi/4-DQPSK, 6 ksym/s symbol rate

According to ANSI C63.4 section 13.1 Table 5 for operating frequencies more than 10MHz: The test shall be performed at Bottom, Middle and Top frequencies.



**5.3.1 Downlink**

Band #	Modulation	Measured at		RBW VBW Span	RF Power [dBm]	RF Power [W]	Plot -
1	Analog	Middle	430.05 MHz	100kHz 300kHz 1,5MHz	18.0	0.063	5.3.1.1.1 #1
	APCO Phase1 C4FM	Middle	430.05 MHz	100kHz 300kHz 1,5MHz	18.0	0.063	5.3.1.1.2 #1
	APCO Phase2 H-DQPSK	Middle	430.05 MHz	100kHz 300kHz 1,5MHz	18.0	0.063	5.3.1.1.3 #1
2	Analog	Middle	459.26875 MHz	100kHz 300kHz 1,5MHz	18.0	0.063	5.3.1.2.1 #1
	APCO Phase1 C4FM	Middle	459.26875 MHz	100kHz 300kHz 1,5MHz	18.0	0.063	5.3.1.2.2 #1
	APCO Phase2 H-DQPSK	Middle	459.26875 MHz	100kHz 300kHz 1,5MHz	18.0	0.063	5.3.1.2.3 #1
3	Analog	Middle	465.1375 MHz	100kHz 300kHz 1,5MHz	18.0	0.063	5.3.1.3.1 #1
	APCO Phase1 C4FM	Middle	465.1375 MHz	100kHz 300kHz 1,5MHz	18.0	0.063	5.3.1.3.2 #1
	APCO Phase2 H-DQPSK	Middle	465.1375 MHz	100kHz 300kHz 1,5MHz	18.0	0.063	5.3.1.3.3 #1
4	Analog	Middle	489.86875 MHz	100kHz 300kHz 1,5MHz	18.0	0.063	5.3.1.4.1 #1
	APCO Phase1 C4FM	Middle	489.86875 MHz	100kHz 300kHz 1,5MHz	18.0	0.063	5.3.1.4.2 #1
	APCO Phase2 H-DQPSK	Middle	489.86875 MHz	100kHz 300kHz 1,5MHz	18.0	0.063	5.3.1.4.3 #1
Maximum output power = 18.0 dBm = 0.063 W							
Limit Maximum output power = 60 dBm = 1000 W (erp)							

table 5.3.1-#1 RF Power Out: §90.635, §2.1046 Test Results Downlink



The max RF Power out is 18 dBm, so the maximum antenna gain (x) can be calculated as follow:

Limit = 1000W (erp) = **60 dBm**

Info: 1000W (erp) = 1640W (eirp)

$$60 \text{ dBm} > 18 \text{ dBm} + x \quad \text{----->} \quad x = 60 \text{ dBm} - 18 \text{ dBm} = \underline{42 \text{ dBd}}$$

$$x \text{ dBi} = 42 \text{ dBd} + 2.15 = \underline{44.15 \text{ dBi}}$$

=> The antenna that will use for the complete system have to have a gain lower than 44.15 dBi, relative to a dipol.

Band #	Modulation	Pin / dBm (Ref. point A)
1	Analog	3.5
	APCO Phase1 C4FM	3.7
	APCO Phase2 H- DQPSK	3.0
2	Analog	3.6
	APCO Phase1 C4FM	2.7
	APCO Phase2 H- DQPSK	2.7
3	Analog	2.6
	APCO Phase1 C4FM	2.5
	APCO Phase2 H- DQPSK	2.6
4	Analog	3.0
	APCO Phase1 C4FM	3.1
	APCO Phase2 H- DQPSK	3.1

table 5.3.1-#2 RF Power Out: §90.635, §2.1046 Test Results; Downlink; Input power



### 5.3.1.1 Band # 1

#### 5.3.1.1.1 Analog

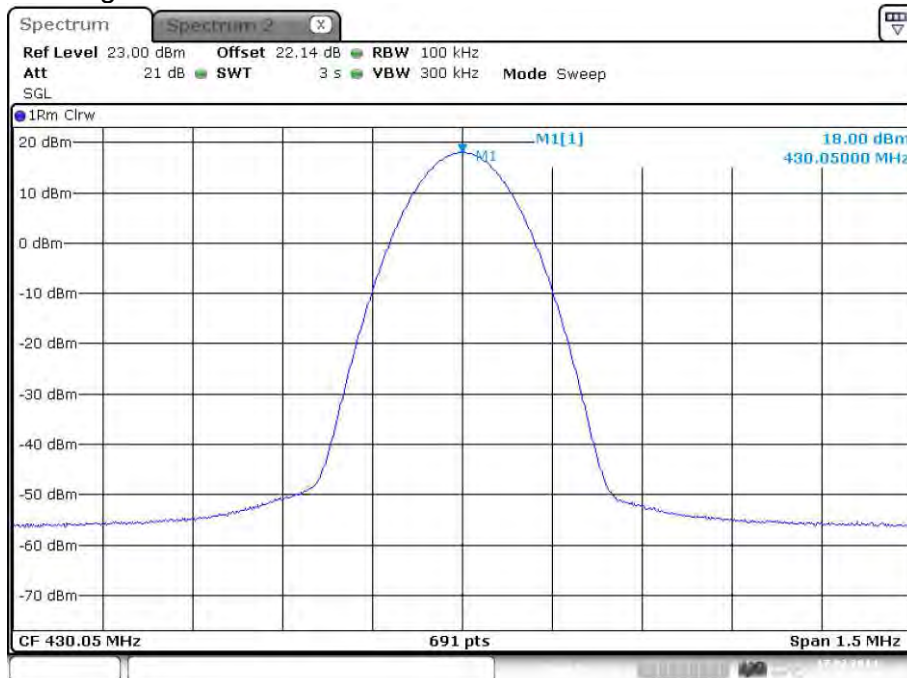

Date: 17.FEB.2014 13:28:15

plot 5.3.1.1-#1 RF Power Out: §90.635, §2.1046; Test Results; Downlink; Band # 1; Analog

#### 5.3.1.1.2 APCO Phase1 C4FM

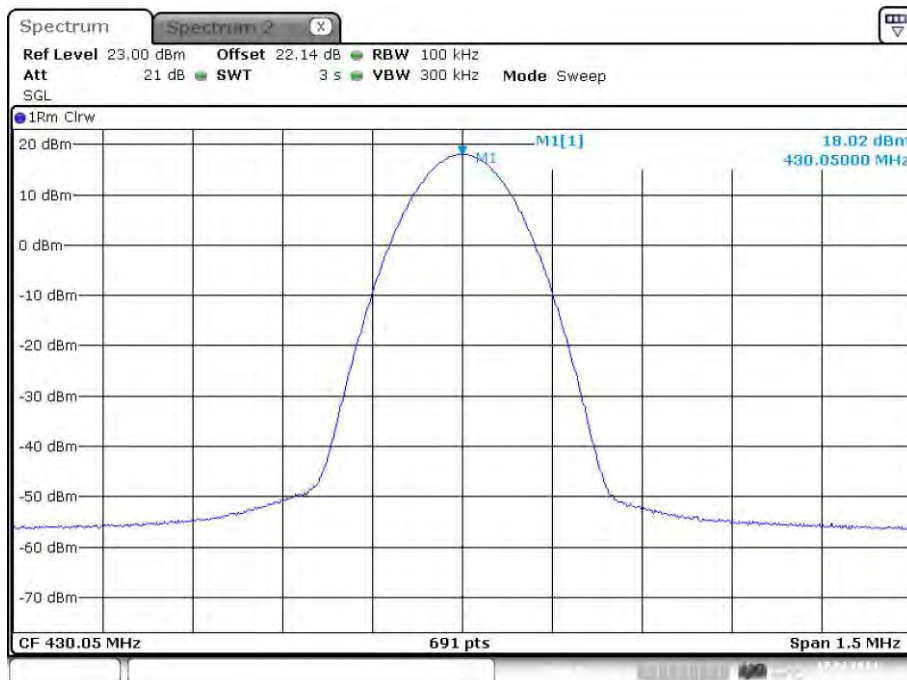

Date: 17.FEB.2014 13:34:35

plot 5.3.1.1-#1 RF Power Out: §90.635, §2.1046; Test Results; Downlink; Band # 1; APCO Phase1 C4FM



5.3.1.1.3 APCO Phase2 H-DQPSK

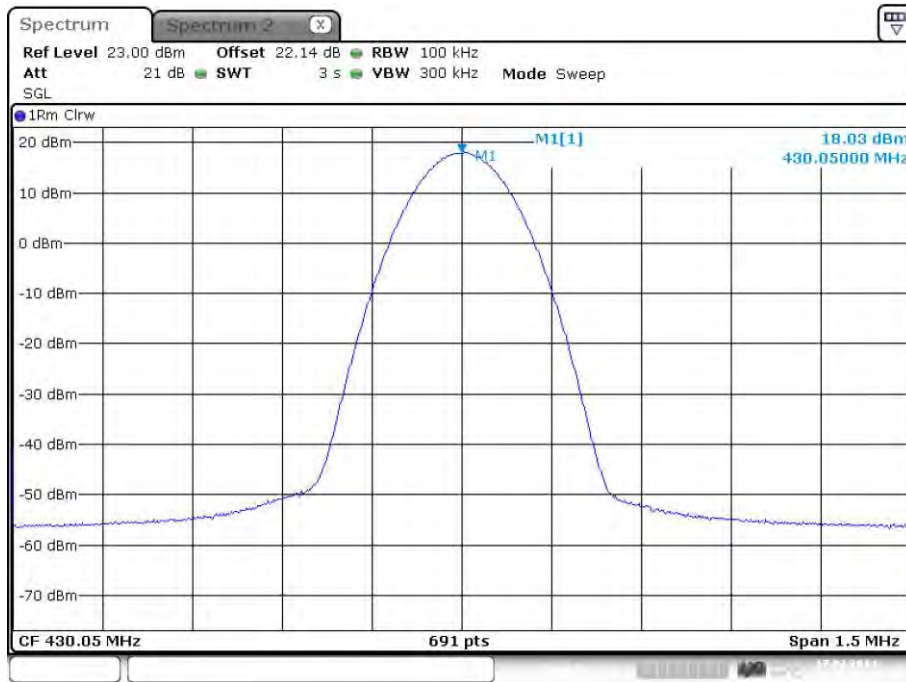

Date: 17.FEB.2014 13:32:39

plot 5.3.1.1-#1 RF Power Out: §90.635, §2.1046; Test Results; Downlink; Band # 1; APCO Phase2 H-DQPSK

5.3.1.2 Band # 2

5.3.1.2.1 Analog

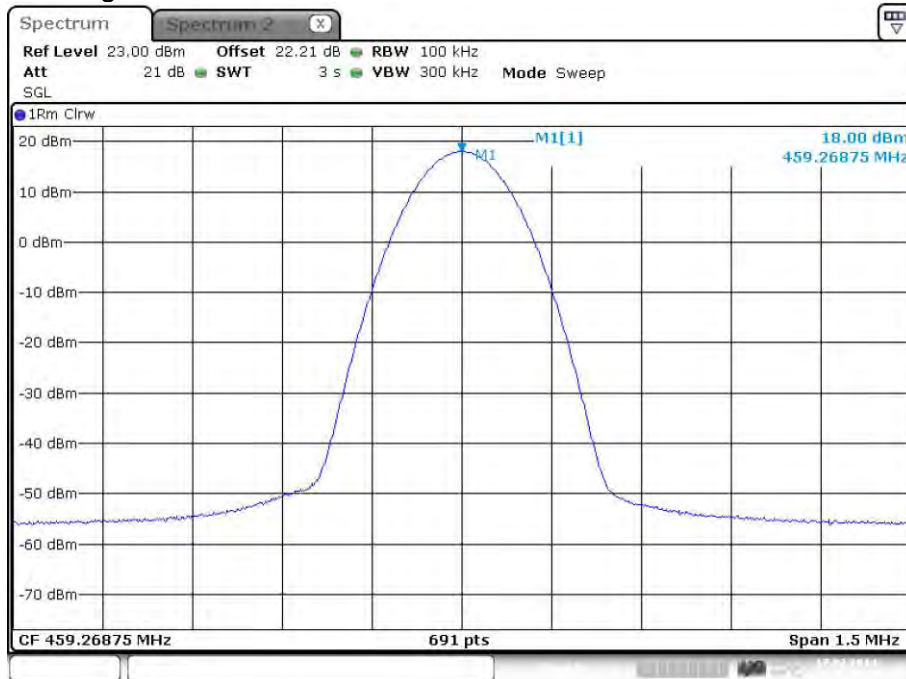

Date: 17.FEB.2014 13:40:21

plot 5.3.1.2-#1 RF Power Out: §90.635, §2.1046; Test Results; Downlink; Band # 2; Analog



5.3.1.2.2 APCO Phase1 C4FM

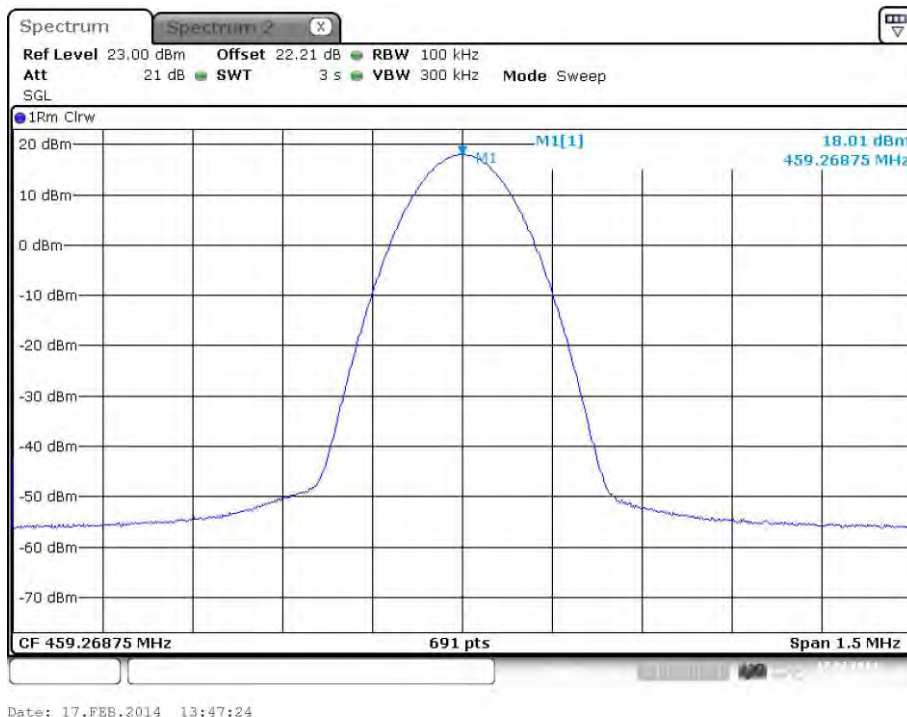

plot 5.3.1.2-#1 RF Power Out: §90.635, §2.1046; Test Results; Downlink; Band # 2; APCO Phase1 C4FM

5.3.1.2.3 APCO Phase2 H-DQPSK

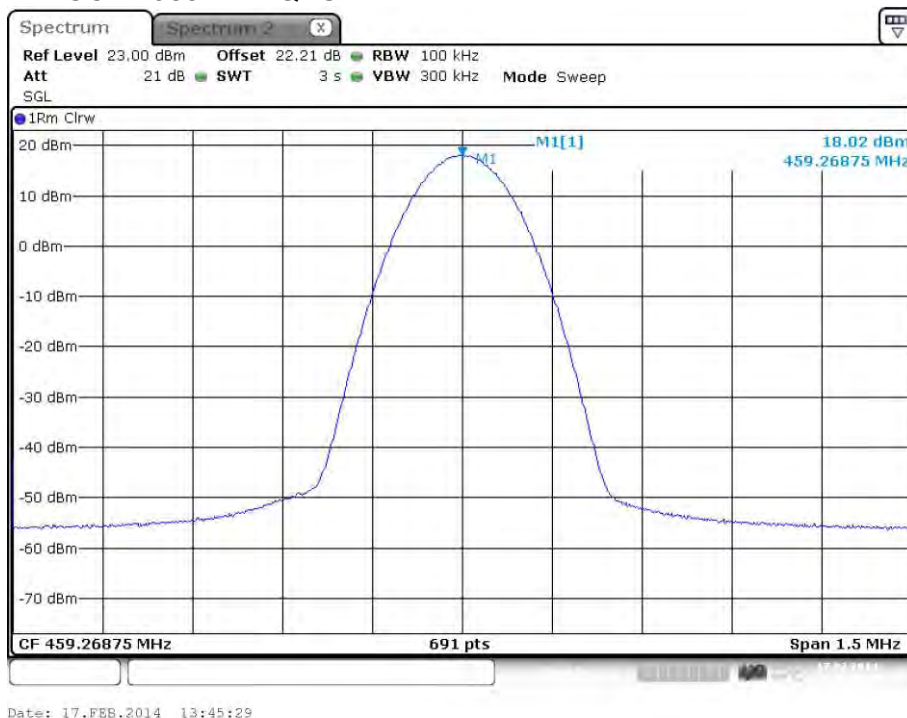

plot 5.3.1.2-#1 RF Power Out: §90.635, §2.1046; Test Results; Downlink; Band # 2; APCO Phase2 H-DQPSK





5.3.1.3 Band # 3

5.3.1.3.1 Analog

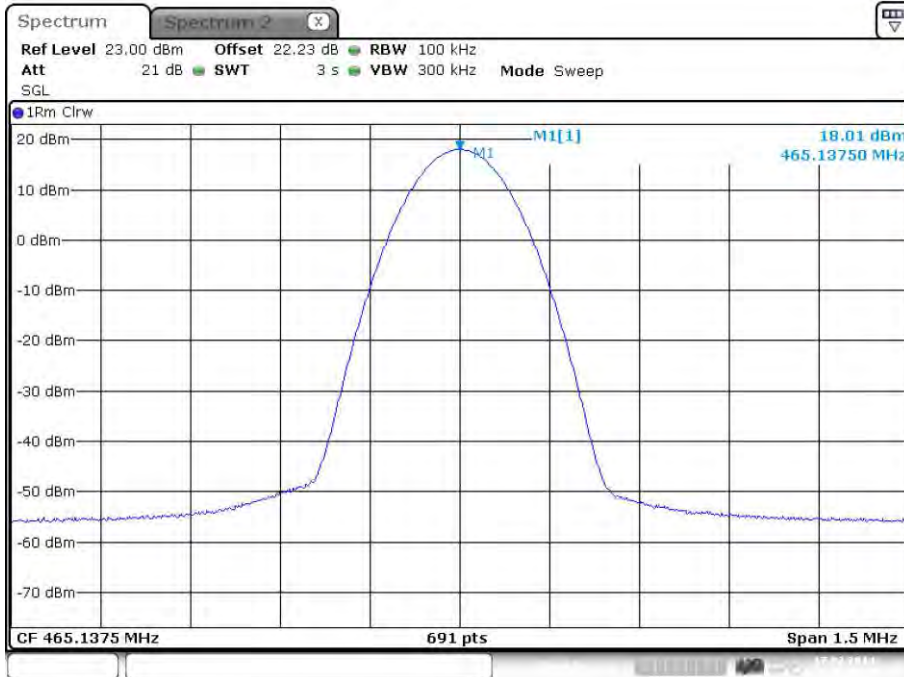

Date: 17.FEB.2014 13:49:13

plot 5.3.1.3-#1 RF Power Out: §90.635, §2.1046; Test Results; Downlink; Band # 3; Analog

5.3.1.3.2 APCO Phase1 C4FM

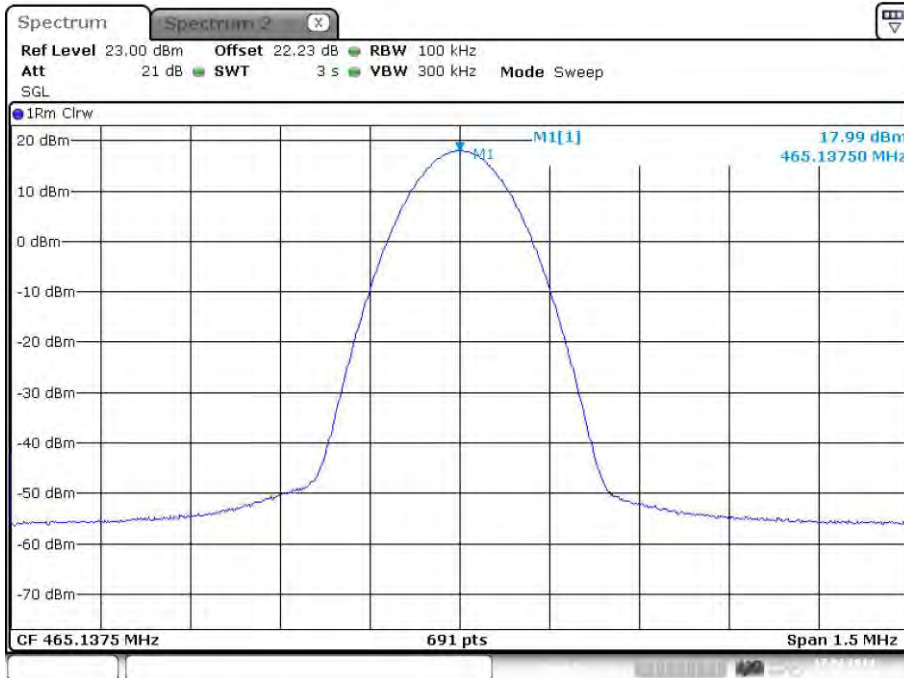

Date: 17.FEB.2014 13:56:40

plot 5.3.1.3-#1 RF Power Out: §90.635, §2.1046; Test Results; Downlink; Band # 3; APCO Phase1 C4FM



5.3.1.3.3 APCO Phase2 H-DQPSK

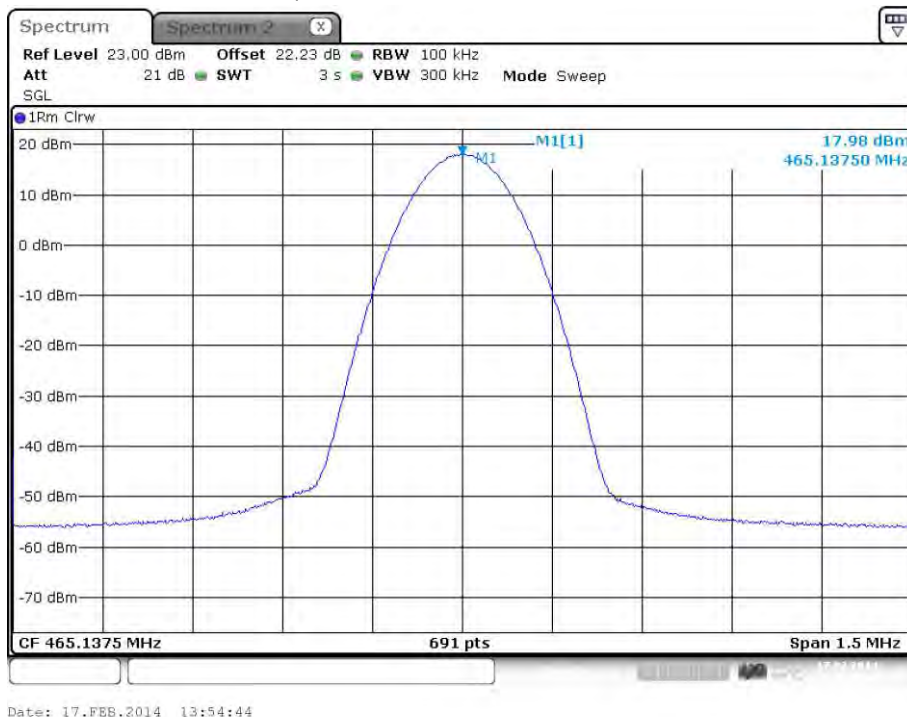

plot 5.3.1.3-#1 RF Power Out: §90.635, §2.1046; Test Results; Downlink; Band # 3; APCO Phase2 H-DQPSK

5.3.1.4 **Band # 4**  
 5.3.1.4.1 Analog



plot 5.3.1.4-#1 RF Power Out: §90.635, §2.1046; Test Results; Downlink; Band # 4; Analog



5.3.1.4.2 APCO Phase1 C4FM

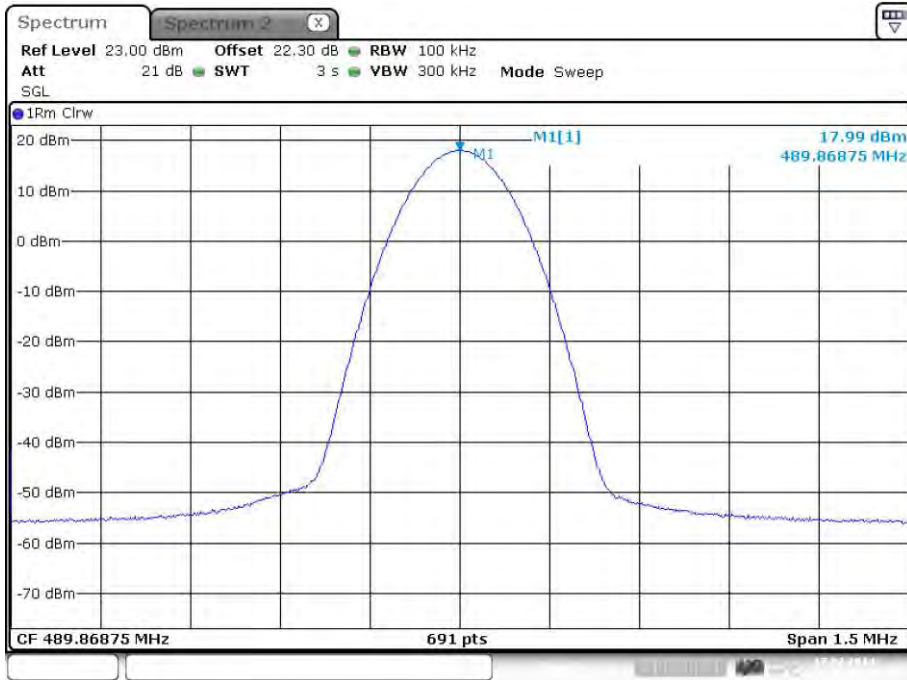

plot 5.3.1.4-#1 RF Power Out: §90.635, §2.1046; Test Results; Downlink; Band # 4; APCO Phase1 C4FM

5.3.1.4.3 APCO Phase2 H-DQPSK

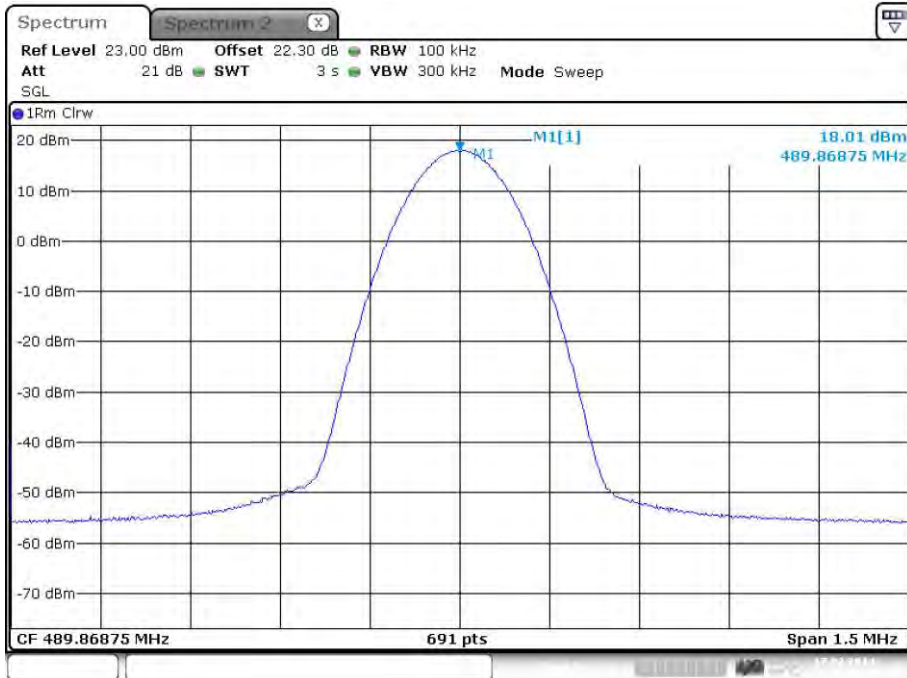

plot 5.3.1.4-#1 RF Power Out: §90.635, §2.1046; Test Results; Downlink; Band # 4; APCO Phase2 H-DQPSK



---

### 5.3.2 Uplink

n.a.

Note: The EUT does not transmit over the air in the uplink direction.

### 5.4 Summary test result

Test result	complies, according the plots above
Tested by:	M. Leinfelder
Date:	17.02.2014



## 6 Occupied Bandwidth: §90.210, §2.1049

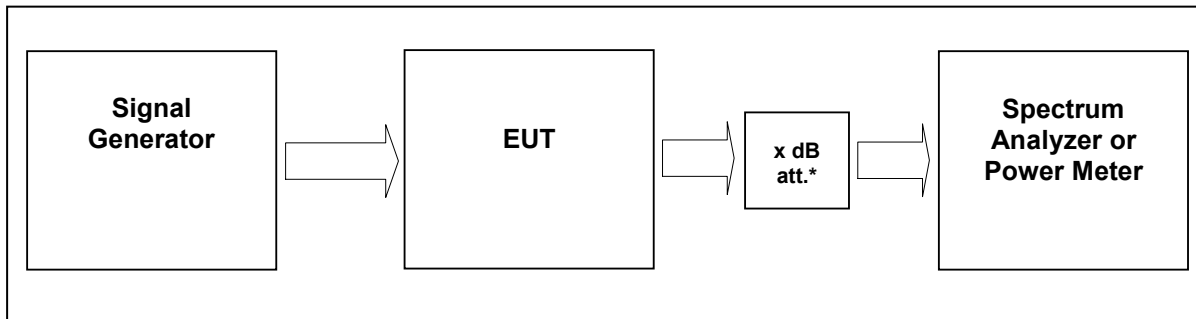

External Attenuator DL      x dB = 20 dB  
figure 6-#1 Test setup: Occupied Bandwidth: §90.210, §2.1049

Measurement uncertainty	± 0,38 dB
Test equipment used	9054, 9233, 7444; 7306; 7144; 7454;7453; 7341; 7449; 7368

### 6.1 Limit

The spectral shape of the output should look similar to input for all modulations.

### 6.2 Test method

Para. No.2.1049

The occupied bandwidth, that is the frequency bandwidth such that, below its lower and above its upper frequency limits, the mean powers radiated are each equal to 0.5 percent of the total mean power radiated by a given emission shall be measured under the following conditions as applicable:



### 6.3 Test results

#### 6.3.1 Downlink

Detector peak.

Band #	Modulation	Measured at		RBW VBW Span	Occupied Bandwidth RF Power [W]	Plot -
1	Analog	Middle	430.05 MHz	1 kHz 10 kHz 125 kHz	8.68 kHz	6.3.1.1.1 #1, #2
	APCO Phase1 C4FM	Middle	430.05 MHz	1 kHz 10 kHz 125 kHz	6.51 kHz	6.3.1.1.2 #1, #2
	APCO Phase2 H- DQPSK	Middle	430.05 MHz	1 kHz 10 kHz 125 kHz	7.96 kHz	6.3.1.1.3 #1, #2
2	Analog	Middle	459.26875 MHz	1 kHz 10 kHz 125 kHz	8.68 kHz	6.3.1.2.1 #1, #2
	APCO Phase1 C4FM	Middle	459.26875 MHz	1 kHz 10 kHz 125 kHz	6.51 kHz	6.3.1.2.2 #1, #2
	APCO Phase2 H- DQPSK	Middle	459.26875 MHz	1 kHz 10 kHz 125 kHz	7.96 kHz	6.3.1.2.3 #1, #2
3	Analog	Middle	465.1375 MHz	1 kHz 10 kHz 125 kHz	8.68 kHz	6.3.1.3.1 #1, #2
	APCO Phase1 C4FM	Middle	465.1375 MHz	1 kHz 10 kHz 125 kHz	6.51 kHz	6.3.1.3.2 #1, #2
	APCO Phase2 H- DQPSK	Middle	465.1375 MHz	1 kHz 10 kHz 125 kHz	7.96 kHz	6.3.1.3.3 #1, #2
4	Analog	Middle	489.86875 MHz	1 kHz 10 kHz 125 kHz	8.68 kHz	6.3.1.4.1 #1, #2
	APCO Phase1 C4FM	Middle	489.86875 MHz	1 kHz 10 kHz 125 kHz	6.51 kHz	6.3.1.4.2 #1, #2
	APCO Phase2 H- DQPSK	Middle	489.86875 MHz	1 kHz 10 kHz 125 kHz	7.96 kHz	6.3.1.4.3 #1, #2

table 6.3.1-#1 Occupied Bandwidth: §90.210, §2.1049 Test results Downlink



6.3.1.1 Band # 1  
6.3.1.1.1 Analog

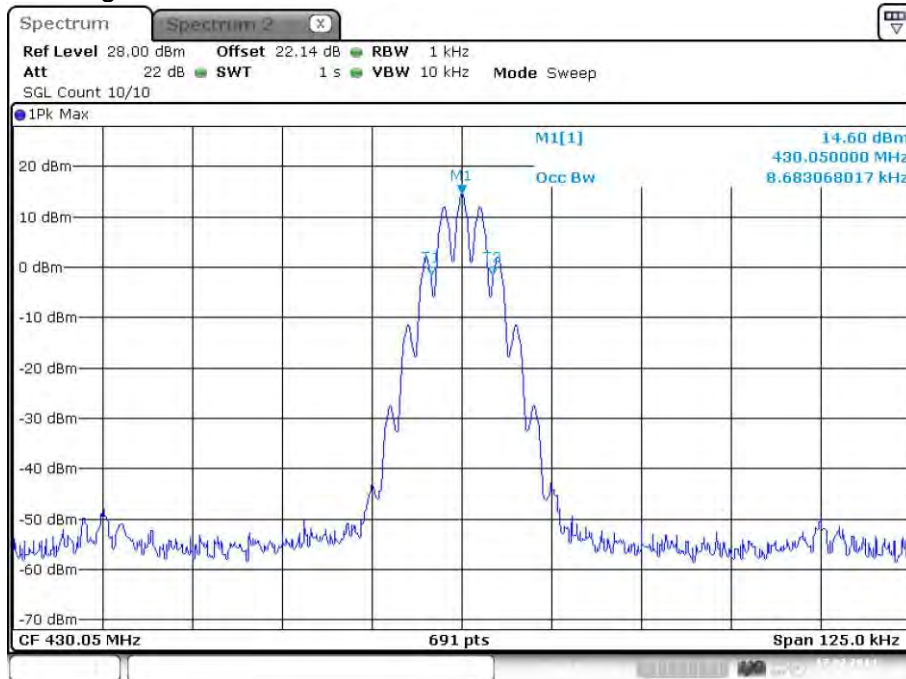

Date: 17.FEB.2014 13:28:33

plot 6.3.1.1-#1 Occupied Bandwidth: §90.210, §2.1049; Test results; Downlink; Band # 1; Analog; Output

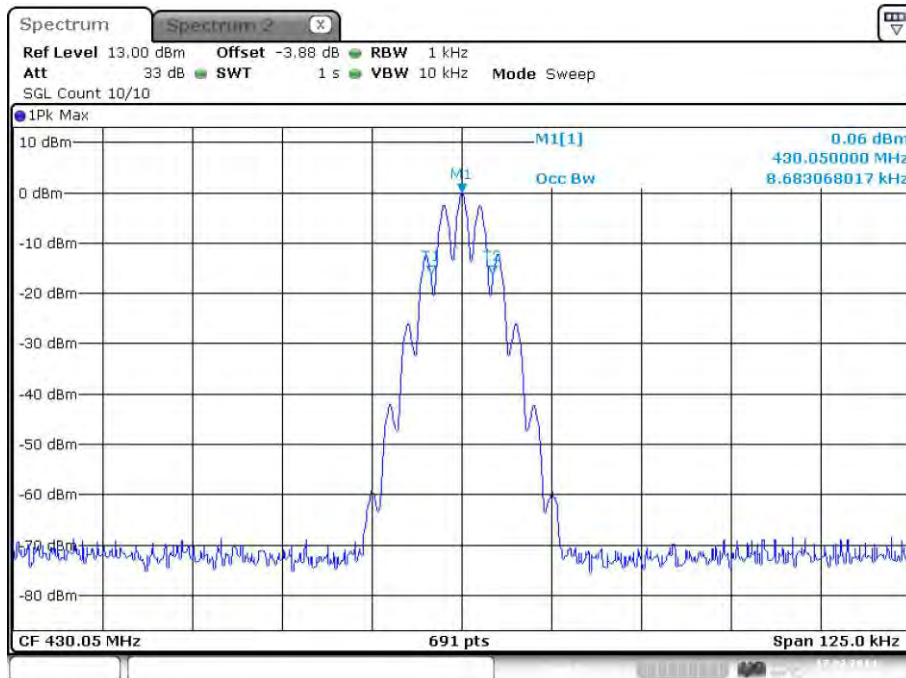

Date: 17.FEB.2014 13:28:46

plot 6.3.1.1-#2 Occupied Bandwidth: §90.210, §2.1049; Test results; Downlink; Band # 1; Analog; Input



6.3.1.1.2 APCO Phase1 C4FM

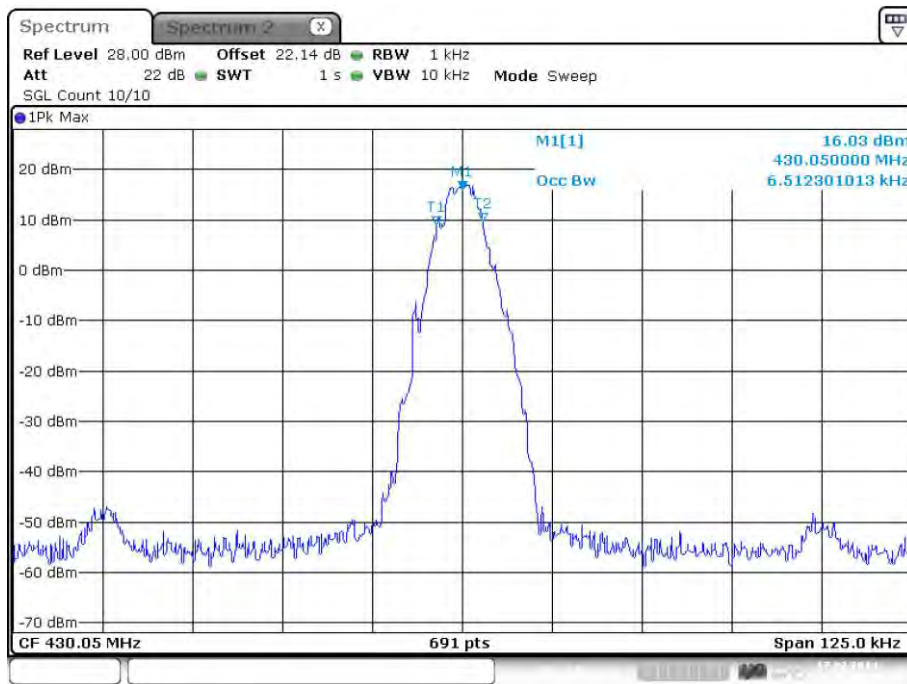

plot 6.3.1.1-#1 Occupied Bandwidth: §90.210, §2.1049; Test results; Downlink; Band # 1; APCO Phase1 C4FM; Output

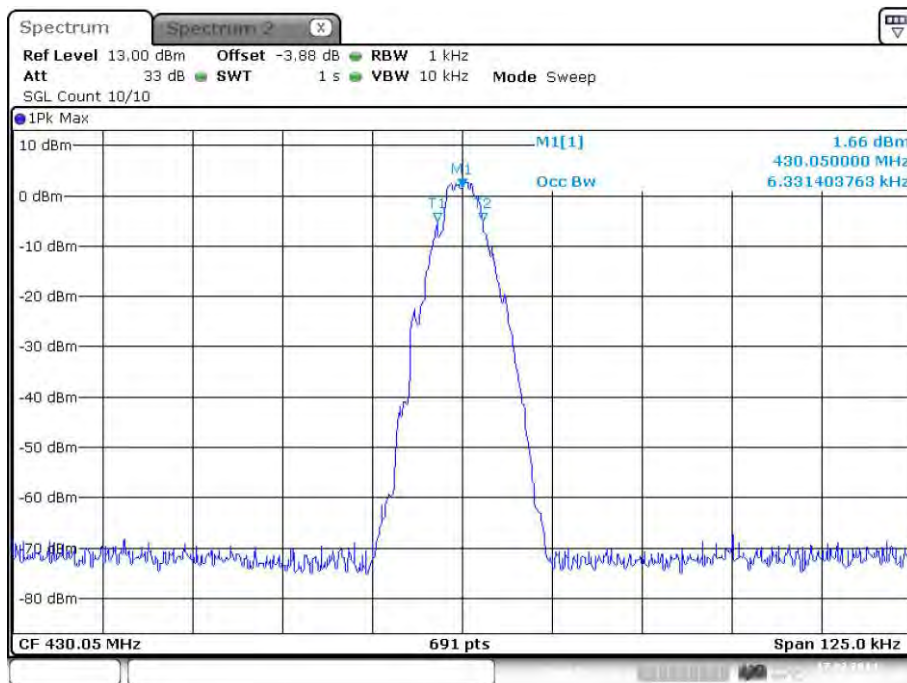

plot 6.3.1.1-#2 Occupied Bandwidth: §90.210, §2.1049; Test results; Downlink; Band # 1; APCO Phase1 C4FM; Input





6.3.1.1.3 APCO Phase2 H-DQPSK

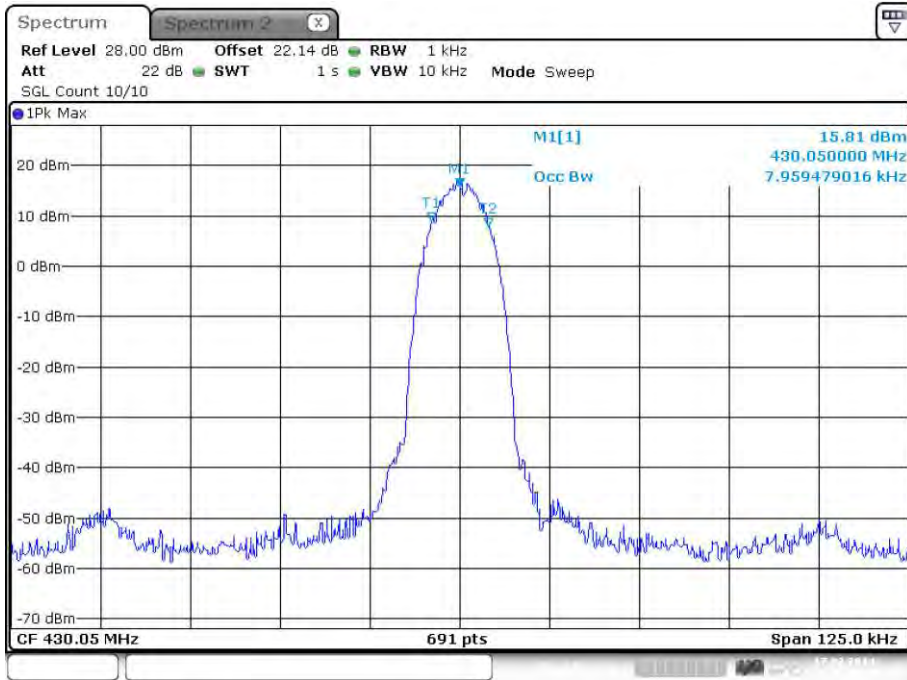

plot 6.3.1.1-#1 Occupied Bandwidth: §90.210, §2.1049; Test results; Downlink; Band # 1; APCO Phase2 H-DQPSK; Output

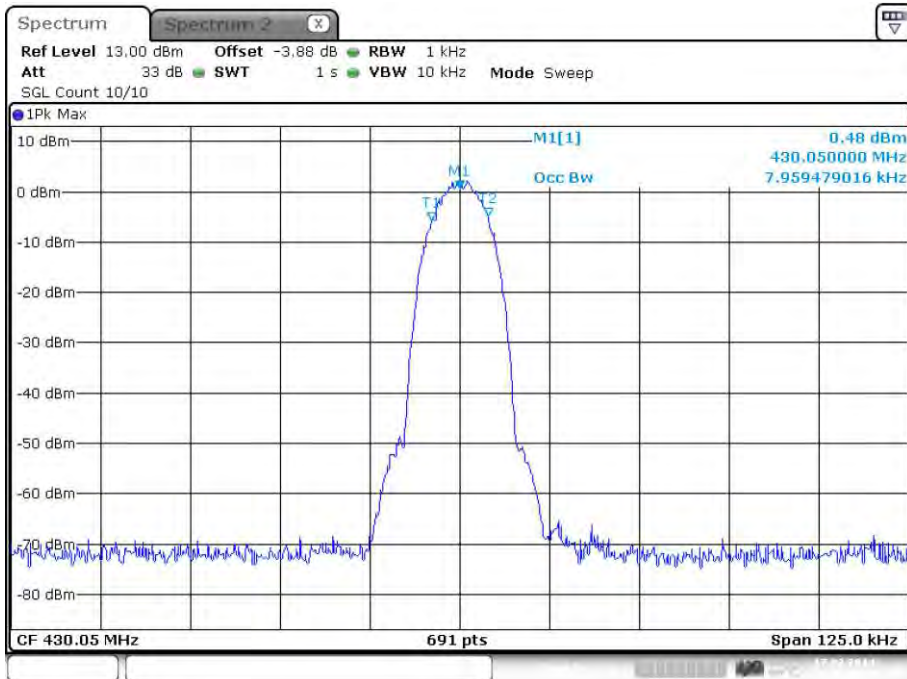

plot 6.3.1.1-#2 Occupied Bandwidth: §90.210, §2.1049; Test results; Downlink; Band # 1; APCO Phase2 H-DQPSK; Input



6.3.1.2 Band # 2  
 6.3.1.2.1 Analog

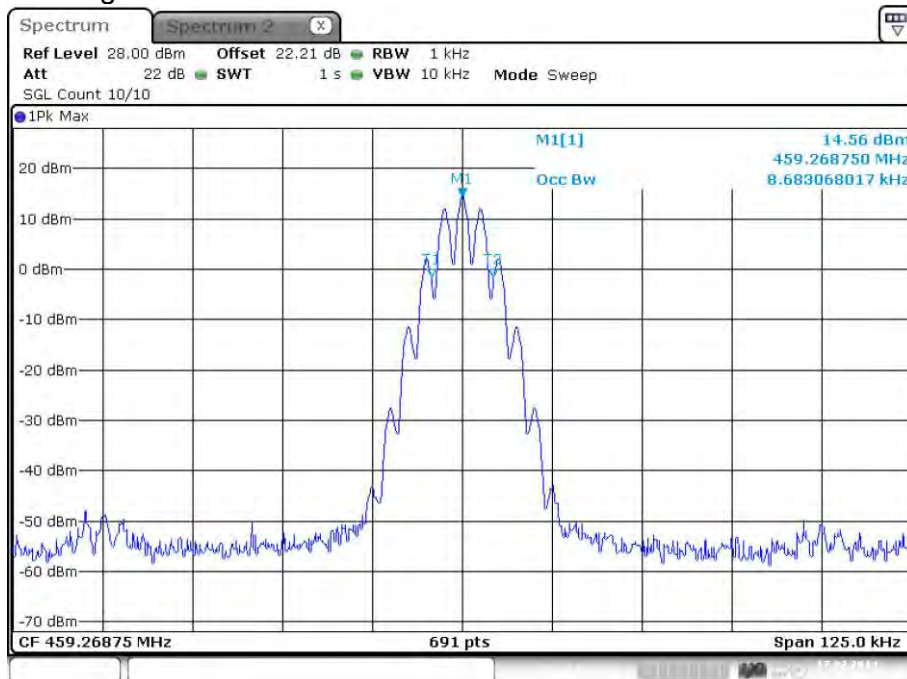

Date: 17.FEB.2014 13:40:39

plot 6.3.1.2-#1 Occupied Bandwidth: §90.210, §2.1049; Test results; Downlink; Band # 2; Analog; Output

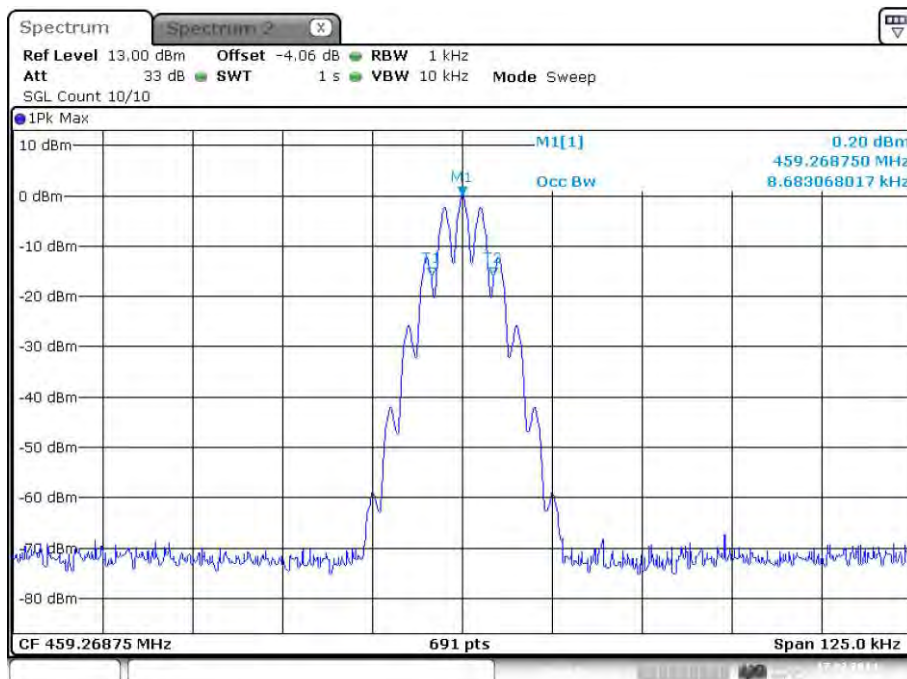

Date: 17.FEB.2014 13:40:52

plot 6.3.1.2-#2 Occupied Bandwidth: §90.210, §2.1049; Test results; Downlink; Band # 2; Analog; Input



6.3.1.2.2 APCO Phase1 C4FM

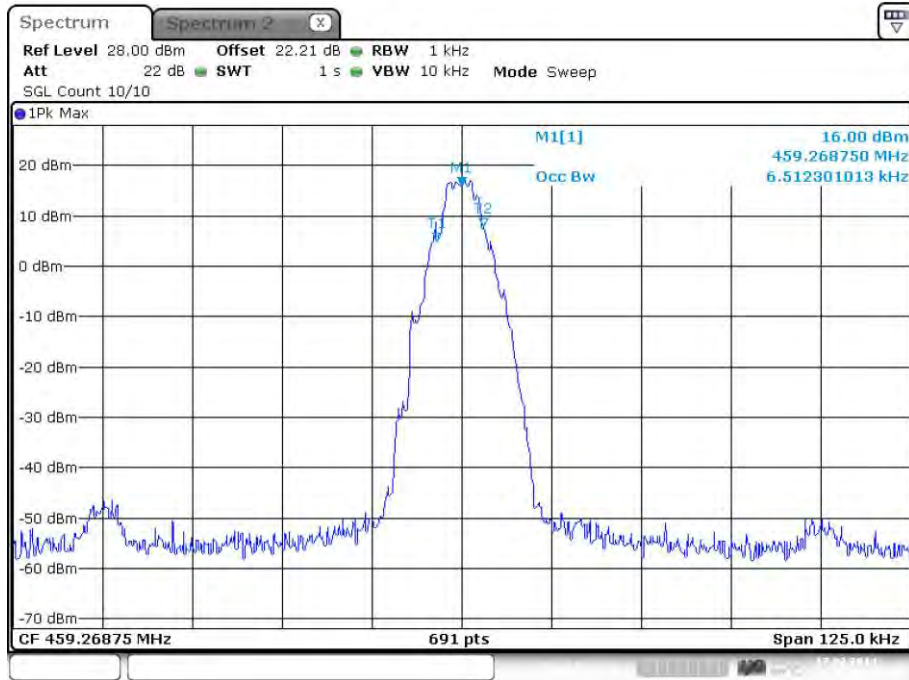

plot 6.3.1.2-#1 Occupied Bandwidth: §90.210, §2.1049; Test results; Downlink; Band # 2; APCO Phase1 C4FM; Output

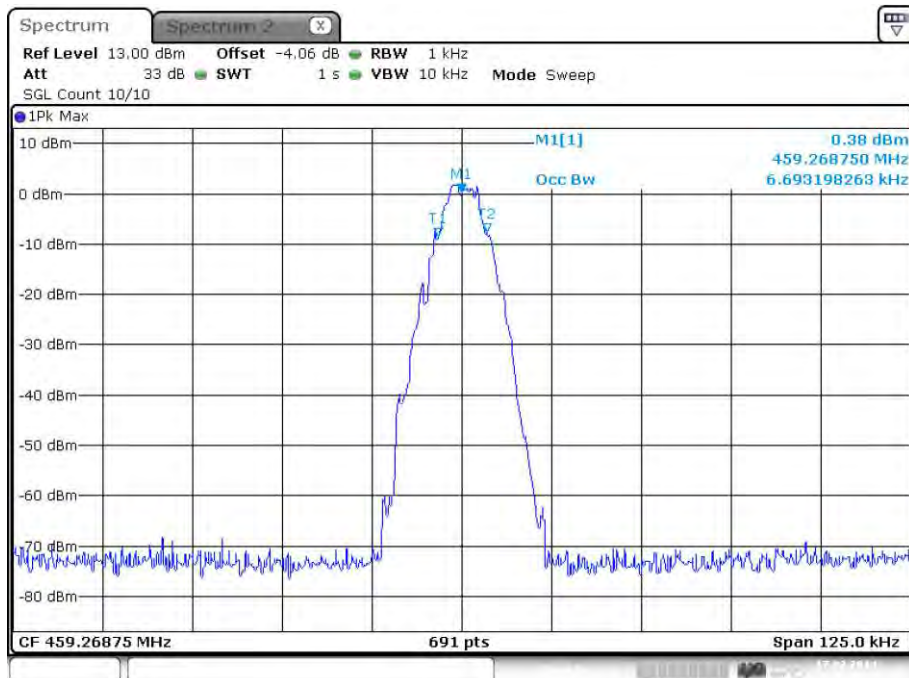

plot 6.3.1.2-#2 Occupied Bandwidth: §90.210, §2.1049; Test results; Downlink; Band # 2; APCO Phase1 C4FM; Input



6.3.1.2.3 APCO Phase2 H-DQPSK

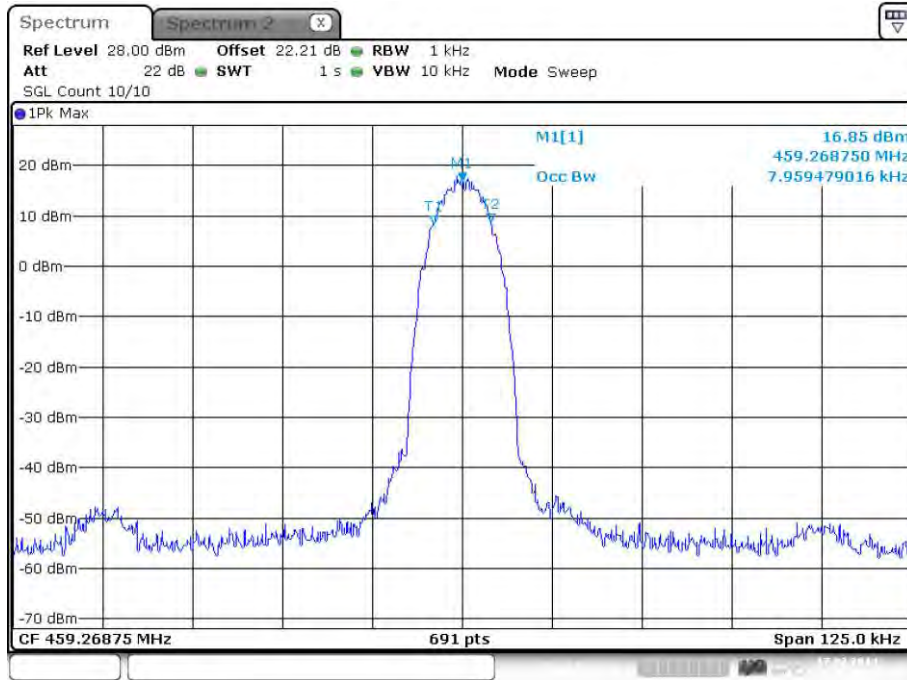

Date: 17.FEB.2014 13:45:46

plot 6.3.1.2-#1 Occupied Bandwidth: §90.210, §2.1049; Test results; Downlink; Band # 2; APCO Phase2 H-DQPSK; Output

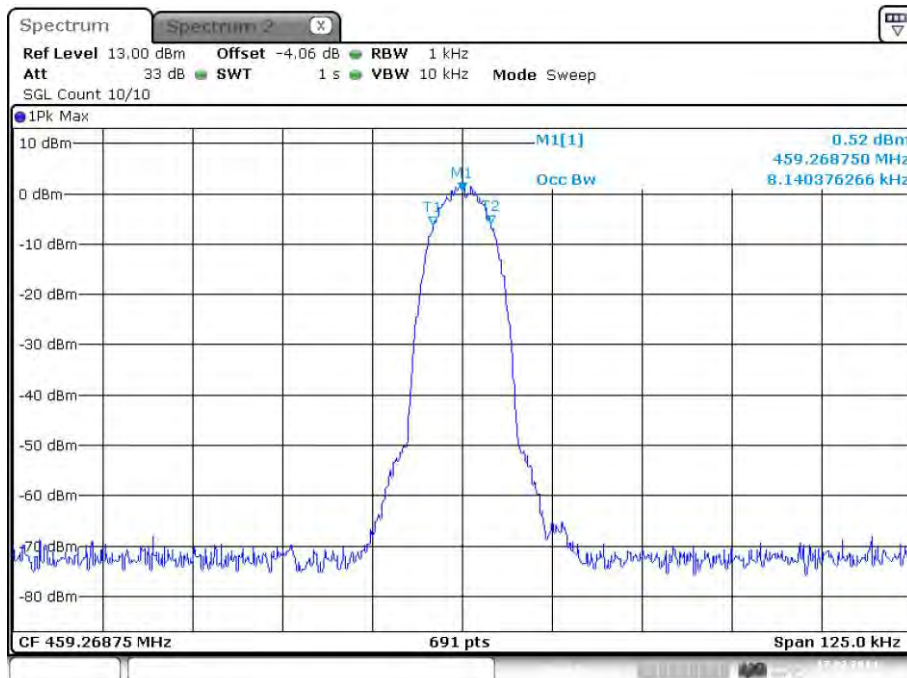

Date: 17.FEB.2014 13:45:59

plot 6.3.1.2-#2 Occupied Bandwidth: §90.210, §2.1049; Test results; Downlink; Band # 2; APCO Phase2 H-DQPSK; Input



6.3.1.3 Band # 3  
6.3.1.3.1 Analog

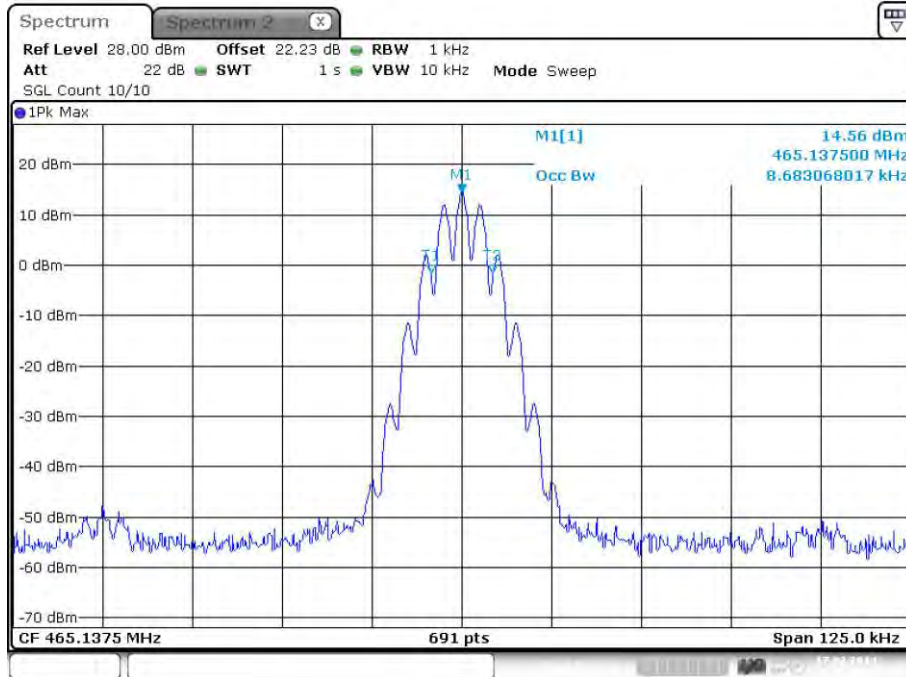

Date: 17.FEB.2014 13:49:31

plot 6.3.1.3-#1 Occupied Bandwidth: §90.210, §2.1049; Test results; Downlink; Band # 3; Analog; Output

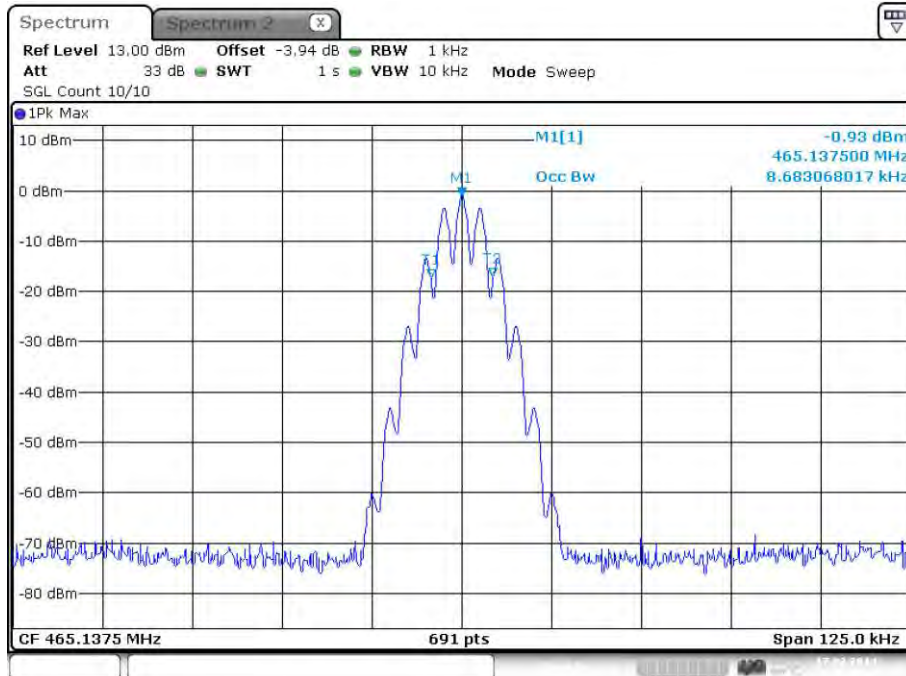

Date: 17.FEB.2014 13:49:44

plot 6.3.1.3-#2 Occupied Bandwidth: §90.210, §2.1049; Test results; Downlink; Band # 3; Analog; Input



6.3.1.3.2 APCO Phase1 C4FM

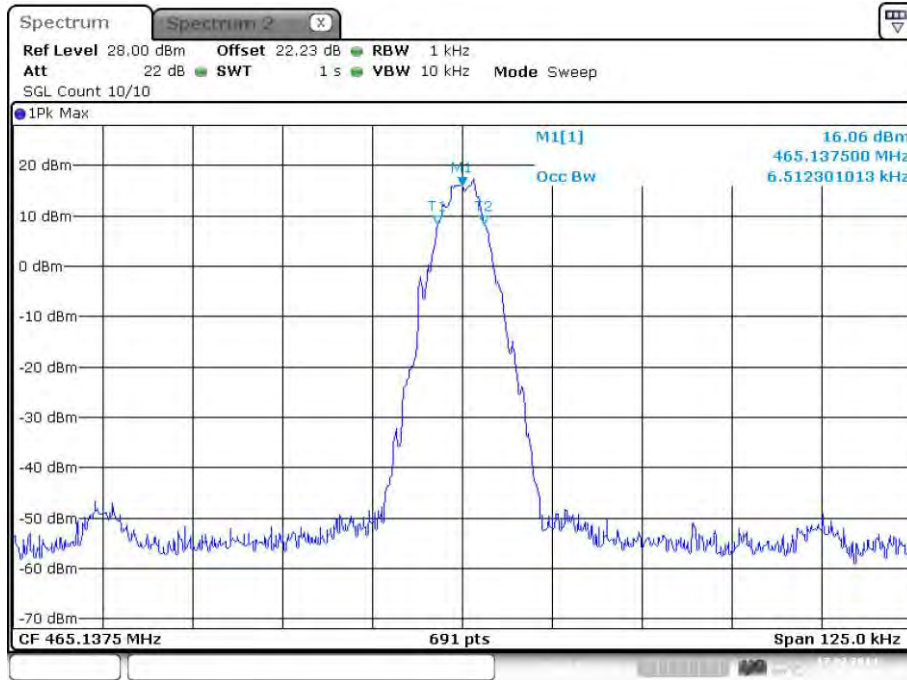

plot 6.3.1.3-#1 Occupied Bandwidth: §90.210, §2.1049; Test results; Downlink; Band # 3; APCO Phase1 C4FM; Output

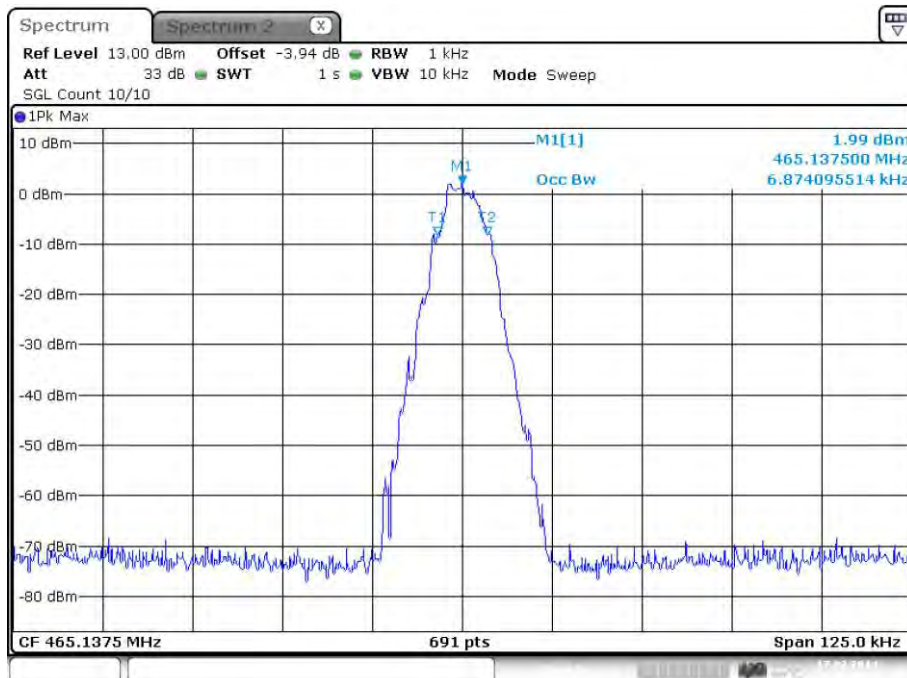

plot 6.3.1.3-#2 Occupied Bandwidth: §90.210, §2.1049; Test results; Downlink; Band # 3; APCO Phase1 C4FM; Input



6.3.1.3.3 APCO Phase2 H-DQPSK

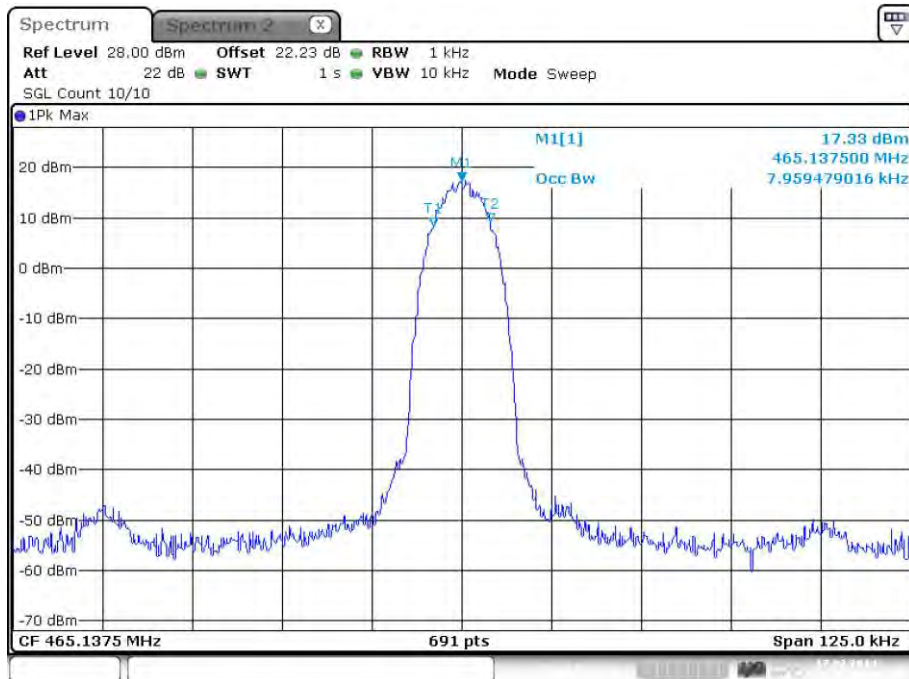

Date: 17.FEB.2014 13:55:02

plot 6.3.1.3-#1 Occupied Bandwidth: §90.210, §2.1049; Test results; Downlink; Band # 3; APCO Phase2 H-DQPSK; Output

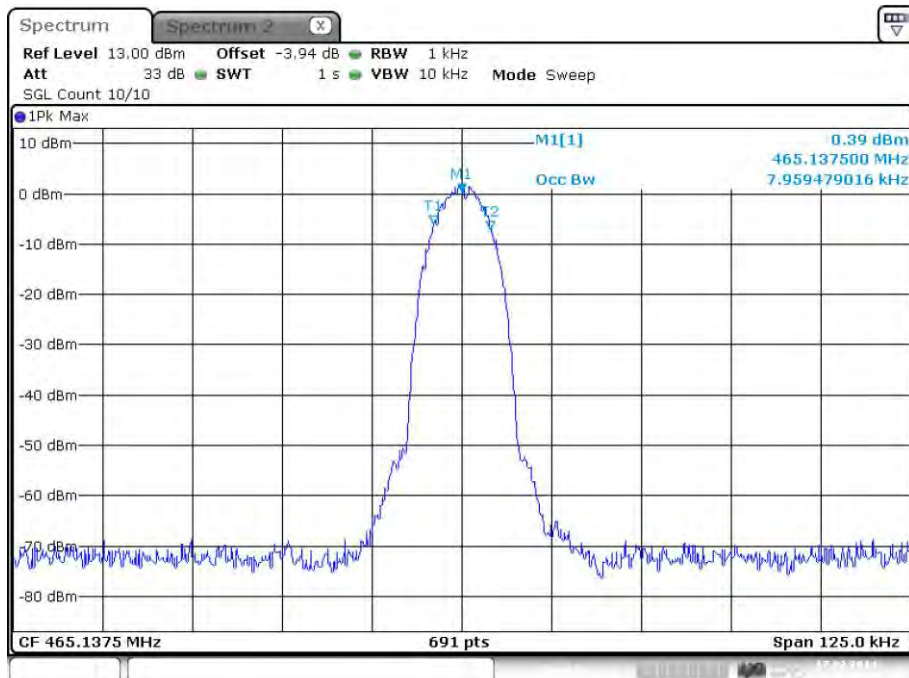

Date: 17.FEB.2014 13:55:15

plot 6.3.1.3-#2 Occupied Bandwidth: §90.210, §2.1049; Test results; Downlink; Band # 3; APCO Phase2 H-DQPSK; Input



6.3.1.4 Band # 4

6.3.1.4.1 Analog

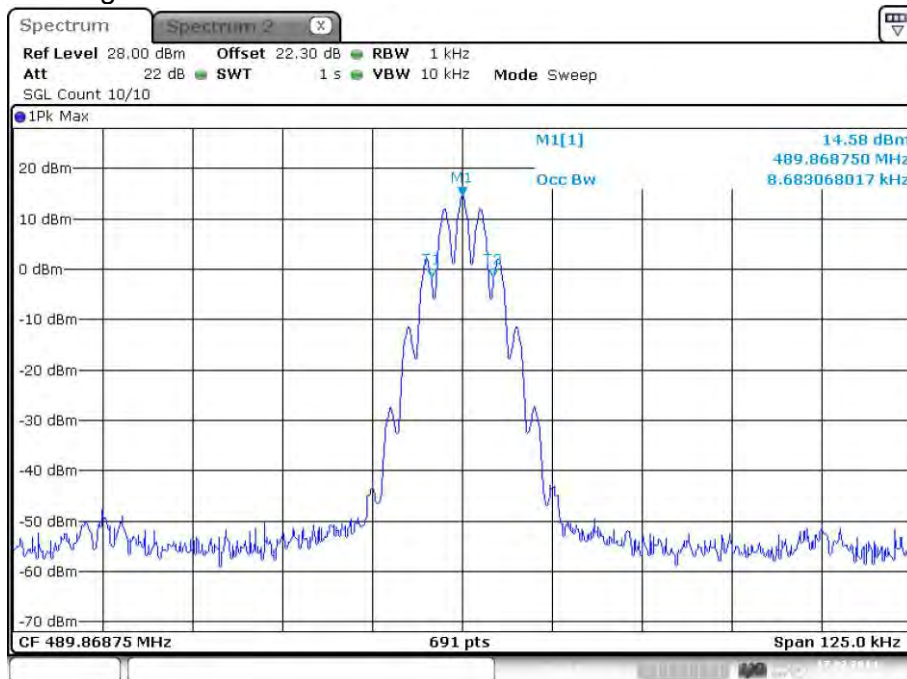

Date: 17.FEB.2014 13:58:53

plot 6.3.1.4-#1 Occupied Bandwidth: §90.210, §2.1049; Test results; Downlink; Band # 4; Analog; Output

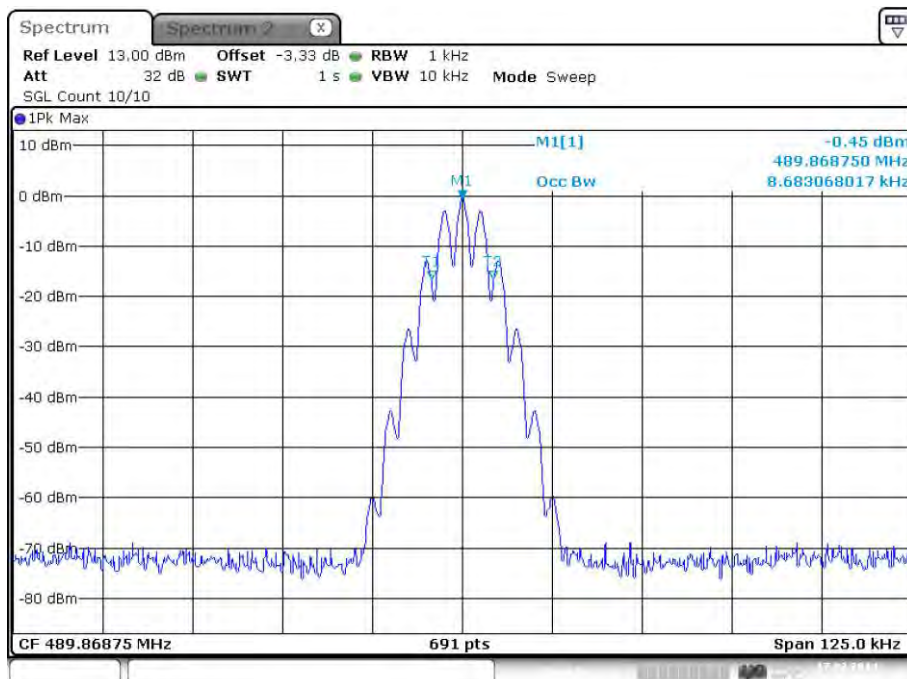

Date: 17.FEB.2014 13:59:07

plot 6.3.1.4-#2 Occupied Bandwidth: §90.210, §2.1049; Test results; Downlink; Band # 4; Analog; Input





6.3.1.4.2 APCO Phase1 C4FM

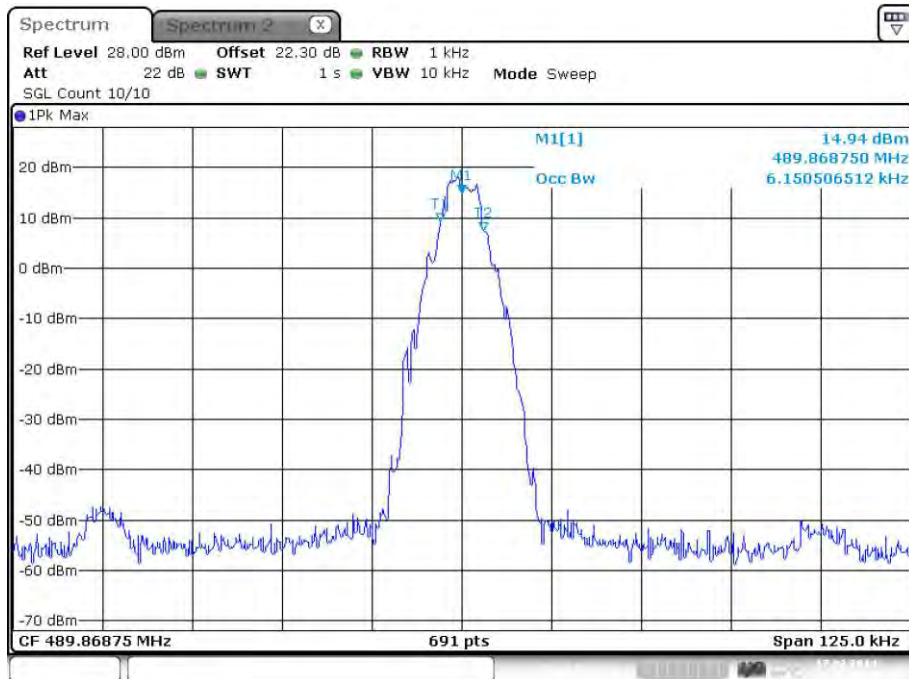

Date: 17.FEB.2014 14:05:32

plot 6.3.1.4-#1 Occupied Bandwidth: §90.210, §2.1049; Test results; Downlink; Band # 4; APCO Phase1 C4FM; Output

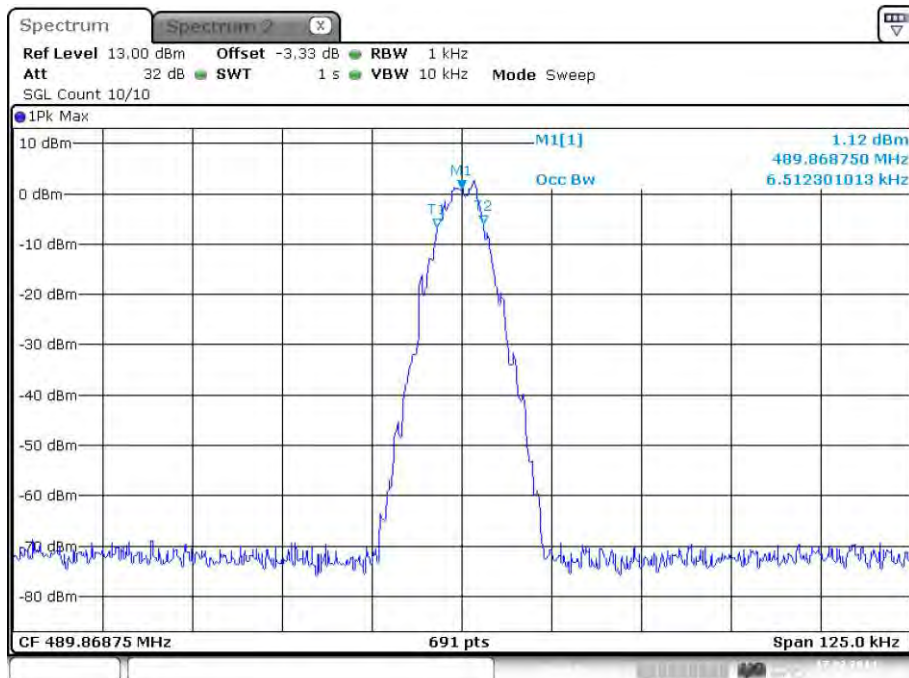

Date: 17.FEB.2014 14:05:45

plot 6.3.1.4-#2 Occupied Bandwidth: §90.210, §2.1049; Test results; Downlink; Band # 4; APCO Phase1 C4FM; Input



6.3.1.4.3 APCO Phase2 H-DQPSK

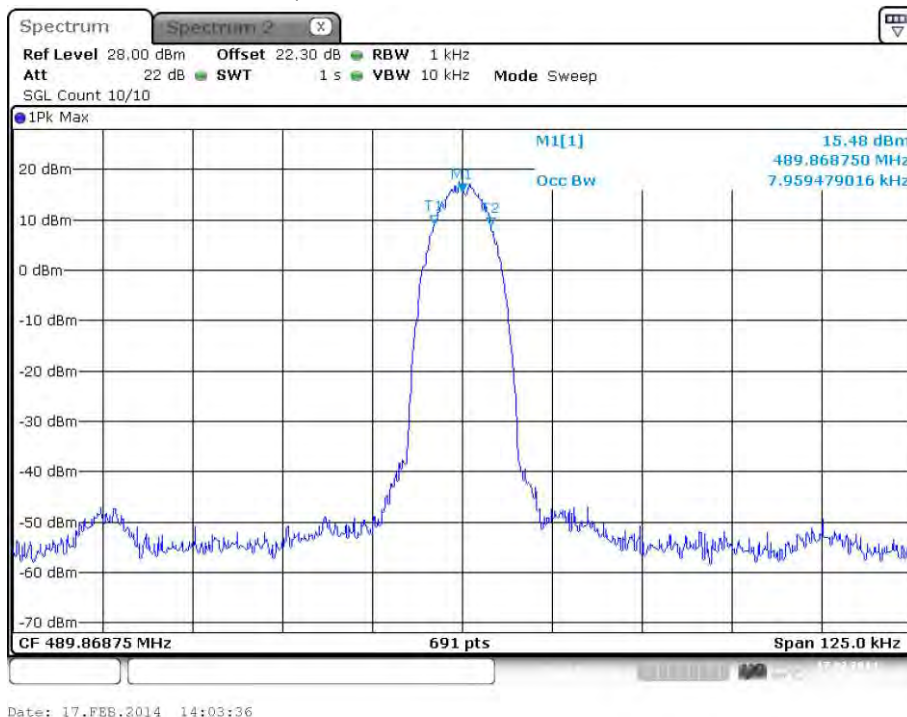

plot 6.3.1.4-#1 Occupied Bandwidth: §90.210, §2.1049; Test results; Downlink; Band # 4; APCO Phase2 H-DQPSK; Output

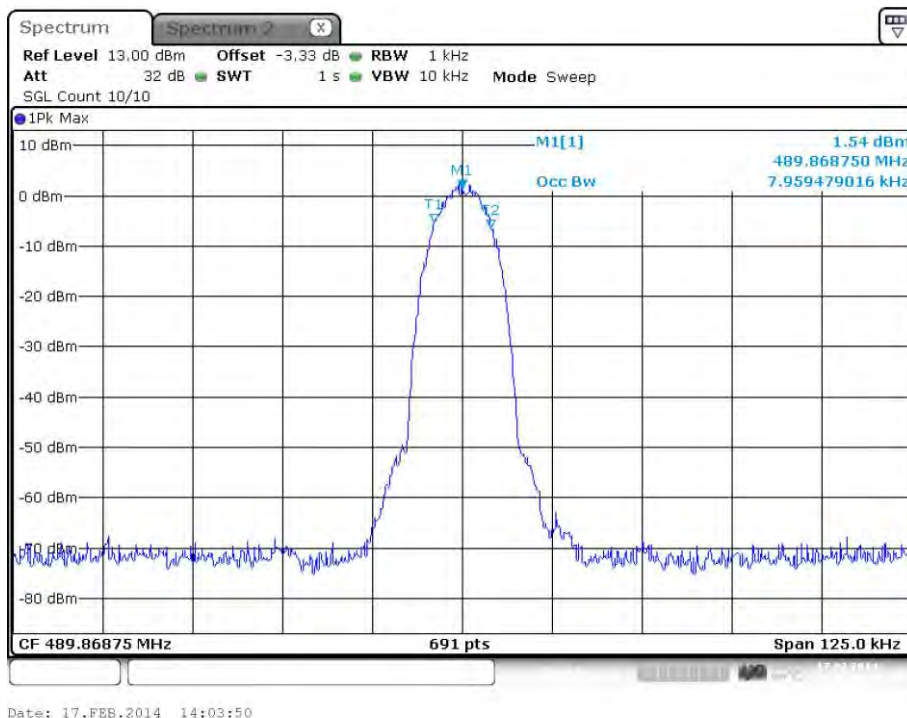

plot 6.3.1.4-#2 Occupied Bandwidth: §90.210, §2.1049; Test results; Downlink; Band # 4; APCO Phase2 H-DQPSK; Input

Test Report No.: 14-196

FCC ID: XS5-TFAHES7850



**BUREAU  
VERITAS**

---

### 6.3.2 Uplink

n.a.

Note: The EUT does not transmit over the air in the uplink direction.

### 6.4 Summary test result

Test result	complies, according the plots above
Tested by:	M. Leinfelder
Date:	17.02.2014



## 7 Spurious Emissions at Antenna Terminals: §90.210, §2.1051

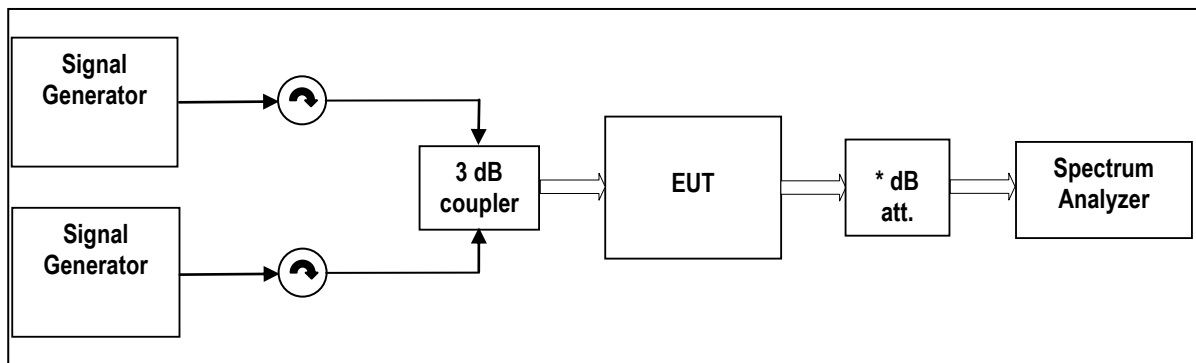

External Attenuator DL x dB = 20 dB

figure 7-#1 Test setup: Spurious Emissions at Antenna Terminals: §90.210, §2.1051

Measurement uncertainty	± 0,54 dB ± 1,2 dB ± 1,5 dB	9 kHz to 3 GHz 3 GHz to 7 GHz 7 GHz to 26 GHz
Test equipment used	9054, 9233, 8849; 7444; 7443; 7306; 7307; 7144; 7454; 7453; 7341; 7449; 7368	

### 7.1 Limit

Minimum standard: §90.210, Table "Application Emission Mask"

Frequency Band (MHz)	Mask for equipment with Audio Low pass filter	Mask for Equipment without audio low pass filter
421 - 512	B, D or E	C, D or E

MASK	Spurious Limit
E	-25 dBm

### 7.2 Test method

Para. No 2.1051 Measurements required: Spurious emissions at antenna terminals.

The radio frequency voltage or powers generated within the equipment and appearing on a spurious frequency shall be checked at the equipment output terminals when properly loaded with a suitable artificial antenna. Curves or equivalent data shall show the magnitude of each harmonic and other spurious emission that can be detected when the equipment is operated under the conditions specified in § 2.1049 as appropriate. The magnitude of spurious emissions which are attenuated more than 20 dB below the permissible value need not be specified.

[39 FR 5919, Feb. 15, 1974. Redesignated and amended at 63 FR 36599, July 7, 1998]



**7.3 Test results**

**7.3.1 Downlink**

**<1MHz from Band Edge**

Detector: RMS

Band #	Modulation	Measured at Band Edge	Carriers	RBW VBW Span Sweep points	Max. level (dBm)	Plot
1	Analog	Lower Edge	406.1125 MHz 406.1375 MHz	300 Hz 3 kHz 1.1 MHz 10001 points	-51.4	7.3.1.1.1 #1
		Upper Edge	453.9625 MHz 453.9875 MHz			7.3.1.1.2 #2
	APCO Phase1 C4FM	Lower Edge	406.1125 MHz 406.1375 MHz	300 Hz 3 kHz 1.1 MHz 10001 points	-40.5	7.3.1.1.2 #1
		Upper Edge	453.9625 MHz 453.9875 MHz			7.3.1.1.2 #2
	APCO Phase2 H-DQPSK	Lower Edge	406.1125 MHz 406.1375 MHz	300 Hz 3 kHz 1.1 MHz 10001 points	-51.3	7.3.1.1.3 #1
		Upper Edge	453.9625 MHz 453.9875 MHz			7.3.1.1.3 #2
2	Analog	Lower Edge	456.0125 MHz 456.0375 MHz	300 Hz 3 kHz 1.1 MHz 10001 points	-44.5	7.3.1.2.1 #1
		Upper Edge	462.5125 MHz 462.525 MHz			7.3.1.2.1 #2
	APCO Phase1 C4FM	Lower Edge	456.0125 MHz 456.0375 MHz	300 Hz 3 kHz 1.1 MHz 10001 points	-52.1	7.3.1.2.2 #1
		Upper Edge	462.5125 MHz 462.525 MHz			7.3.1.2.2 #2
	APCO Phase2 H-DQPSK	Lower Edge	456.0125 MHz 456.0375 MHz	300 Hz 3 kHz 1.1 MHz 10001 points	-47.8	7.3.1.2.3 #1
		Upper Edge	462.5125 MHz 462.525 MHz			7.3.1.2.3 #2
3	Analog	Lower Edge	462.75 MHz 462.7625 MHz	300 Hz 3 kHz 1.1 MHz 10001 points	-49.1	7.3.1.3.1 #1
		Upper Edge	467.5125 MHz 467.525 MHz			7.3.1.3.1 #2
	APCO Phase1 C4FM	Lower Edge	462.75 MHz 462.7625 MHz	300 Hz 3 kHz 1.1 MHz 10001 points	-52.2	7.3.1.3.2 #1
		Upper Edge	467.5125 MHz 467.525 MHz			7.3.1.3.2 #2
	APCO Phase2 H-DQPSK	Lower Edge	462.75 MHz 462.7625 MHz	300 Hz 3 kHz 1.1 MHz 10001 points	-48.0	7.3.1.3.3 #1
		Upper Edge	467.5125 MHz 467.525 MHz			7.3.1.3.3 #2



Band #	Modulation	Measured at Band Edge	Carriers	RBW VBW Span Sweep points	Max. level (dBm)	Plot
4	Analog	Lower Edge	467.75 MHz 467.7625 MHz	300 Hz 3 kHz 1.1 MHz 10001 points	-52.5	7.3.1.4.1 #1
		Upper Edge	511.9625 MHz 511.9875 MHz			7.3.1.4.2 #2
	APCO Phase1 C4FM	Lower Edge	467.75 MHz 467.7625 MHz	300 Hz 3 kHz 1.1 MHz 10001 points	-51.8	7.3.1.4.2 #1
		Upper Edge	511.9625 MHz 511.9875 MHz			7.3.1.4.2 #2
	APCO Phase2 H-DQPSK	Lower Edge	467.75 MHz 467.7625 MHz	300 Hz 3 kHz 1.1 MHz 10001 points	-51.3	7.3.1.4.3 #1
		Upper Edge	511.9625 MHz 511.9875 MHz			7.3.1.4.3 #2

table 7.3-#1 Spurious Emissions at Antenna Terminals: §90.210, §2.1051 Test results <1MHz from Band Edge

**>1MHz from Band Edge**

Detector: RMS

Band #	Modulation	Carriers	RBW VBW Span	Max. level (dBm)	Plot
1	Analog	430.05 MHz	1MHz 3MHz 30MHz – 10GHz	-36.1	7.3.1.5.1 #1
	APCO Phase1 C4FM	430.05 MHz	1MHz 3MHz 30MHz – 10GHz	-36.1	7.3.1.5.2 #1
	APCO Phase2 H-DQPSK	430.05 MHz	1MHz 3MHz 30MHz – 10GHz	-35.7	7.3.1.5.3 #1
2	Analog	459.26875 MHz	1MHz 3MHz 30MHz – 10GHz	-35.8	7.3.1.6.1 #1
	APCO Phase1 C4FM	459.26875 MHz	1MHz 3MHz 30MHz – 10GHz	-35.8	7.3.1.6.2 #1
	APCO Phase2 H-DQPSK	459.26875 MHz	1MHz 3MHz 30MHz – 10GHz	-36.0	7.3.1.6.3 #1



Band #	Modulation	Carriers	RBW VBW Span	Max. level (dBm)	Plot
3	Analog	465.1375 MHz	1MHz 3MHz 30MHz – 10GHz	-36.0	7.3.1.7.1 #1
	APCO Phase1 C4FM	465.1375 MHz	1MHz 3MHz 30MHz – 10GHz	-36.0	7.3.1.7.2 #1
	APCO Phase2 H- DQPSK	465.1375 MHz	1MHz 3MHz 30MHz – 10GHz	-35.7	7.3.1.7.3 #1
4	Analog	489.86875 MHz	1MHz 3MHz 30MHz – 10GHz	-35.9	7.3.1.8.1 #1
	APCO Phase1 C4FM	489.86875 MHz	1MHz 3MHz 30MHz – 10GHz	-35.9	7.3.1.8.2 #1
	APCO Phase2 H- DQPSK	489.86875 MHz	1MHz 3MHz 30MHz – 10GHz	-36.0	7.3.1.8.3 #1

table 7.3-#2 Spurious Emissions at Antenna Terminals: §90.210, §2.1051 Test results >1MHz from Band Edge



7.3.1.1 Band # 1

7.3.1.1.1 Analog < 1MHz to band edge

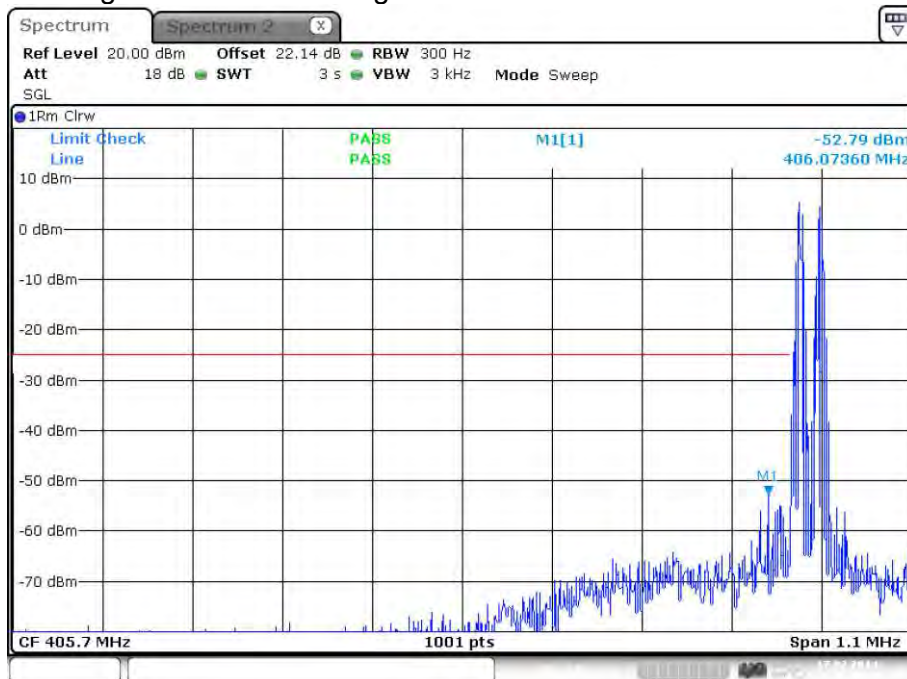

Date: 17.FEB.2014 13:29:18

plot 7.3.1.1-#1 Spurious Emissions at Antenna Terminals: §90.210, §2.1051; Test results; Downlink; Band # 1; Analog < 1MHz to band edge; Lower Band Edge

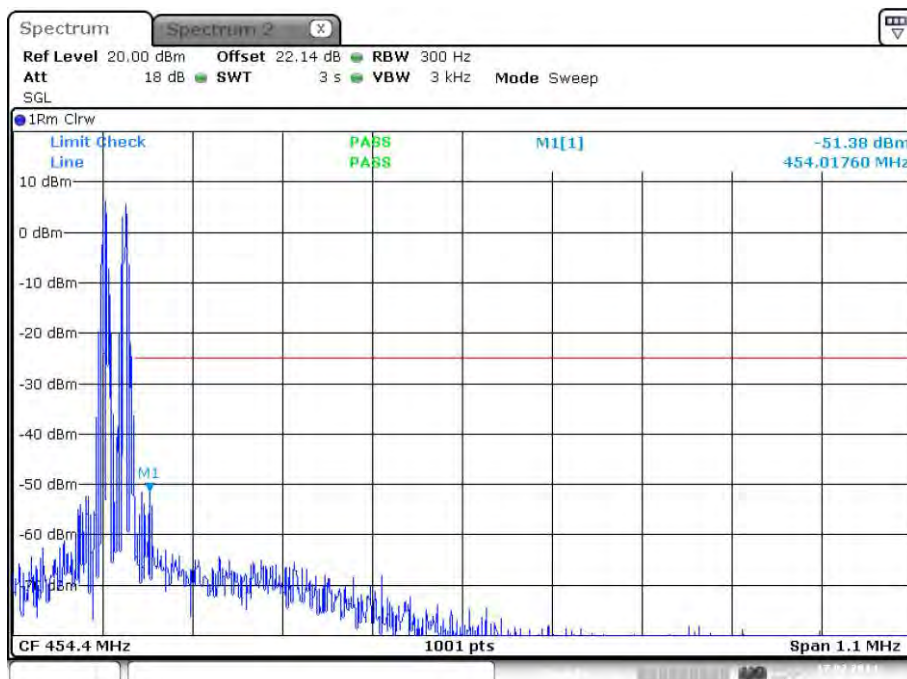

Date: 17.FEB.2014 13:29:35

plot 7.3.1.1-#2 Spurious Emissions at Antenna Terminals: §90.210, §2.1051; Test results; Downlink; Band # 1; Analog < 1MHz to band edge; Upper Band Edge





7.3.1.1.2 APCO Phase1 C4FM < 1MHz to band edge

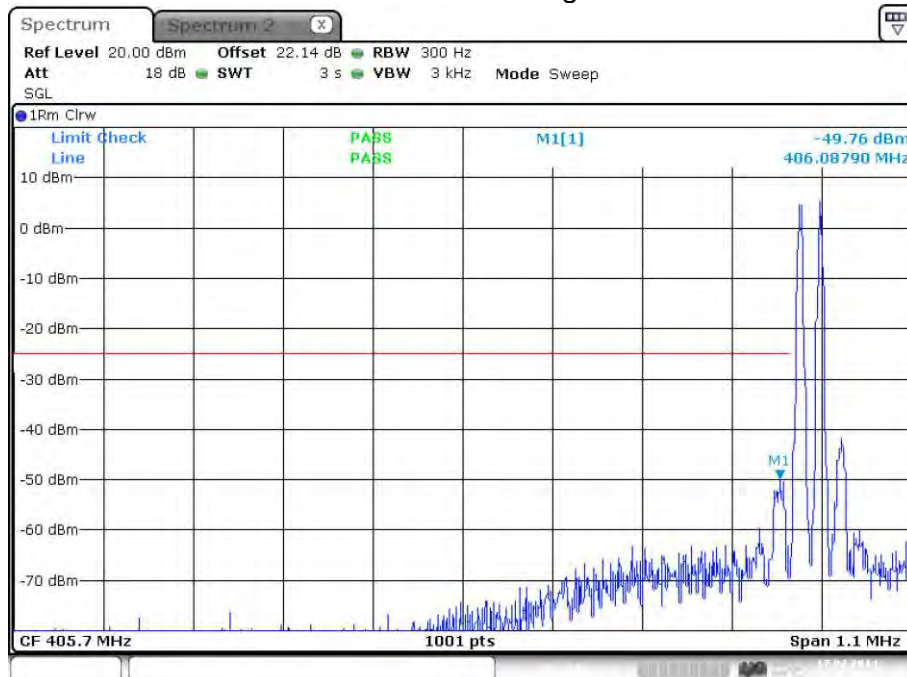

Date: 17.FEB.2014 13:36:11

plot 7.3.1.1-#1 Spurious Emissions at Antenna Terminals: §90.210, §2.1051; Test results; Downlink; Band # 1; APCO Phase1 C4FM < 1MHz to band edge; Lower Band Edge

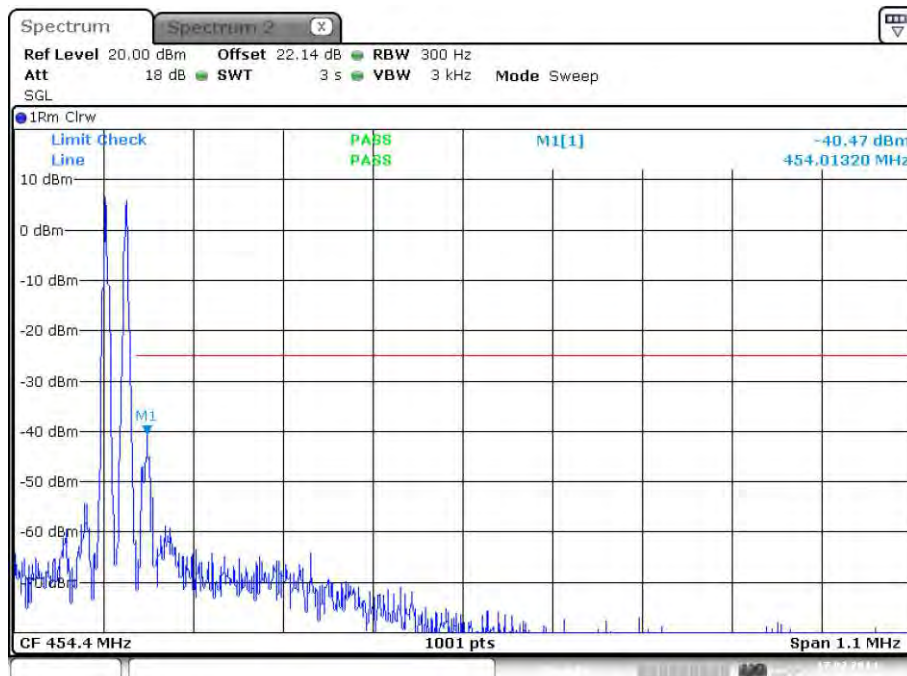

Date: 17.FEB.2014 13:36:47

plot 7.3.1.1-#2 Spurious Emissions at Antenna Terminals: §90.210, §2.1051; Test results; Downlink; Band # 1; APCO Phase1 C4FM < 1MHz to band edge; Upper Band Edge



7.3.1.1.3 APCO Phase2 H-DQPSK < 1MHz to band edge

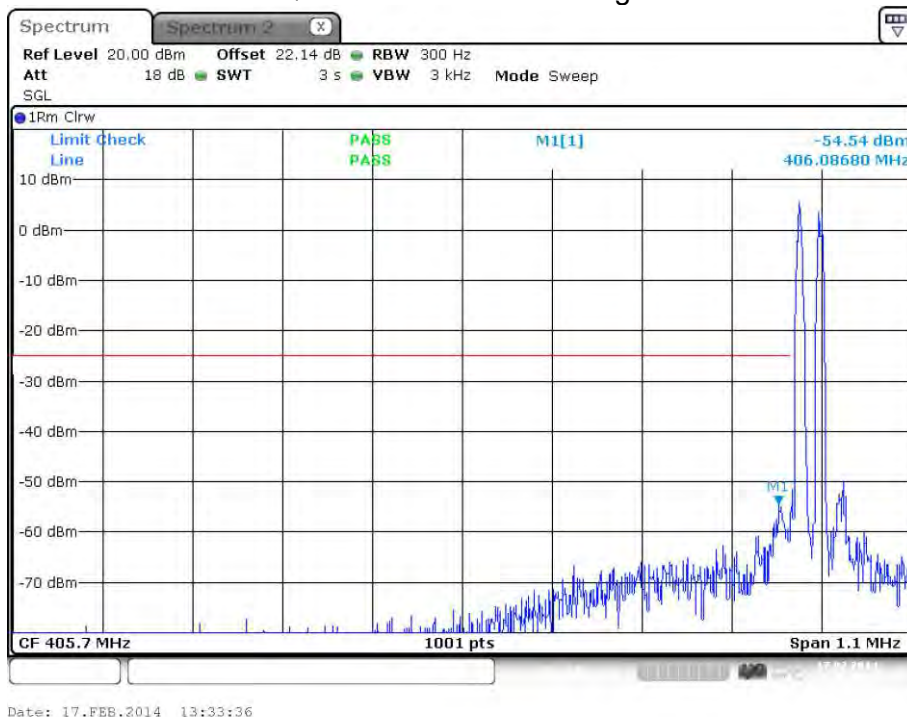

plot 7.3.1.1-#1 Spurious Emissions at Antenna Terminals: §90.210, §2.1051; Test results; Downlink; Band # 1; APCO Phase2 H-DQPSK < 1MHz to band edge; Lower Band Edge

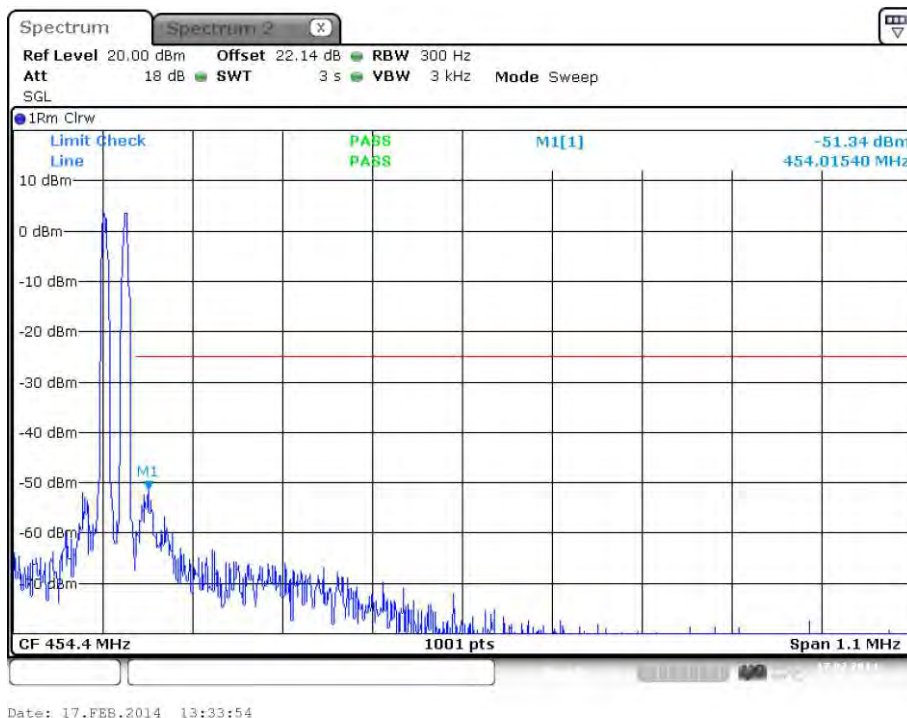

plot 7.3.1.1-#2 Spurious Emissions at Antenna Terminals: §90.210, §2.1051; Test results; Downlink; Band # 1; APCO Phase2 H-DQPSK < 1MHz to band edge; Upper Band Edge



7.3.1.2 Band # 2

7.3.1.2.1 Analog < 1MHz to band edge

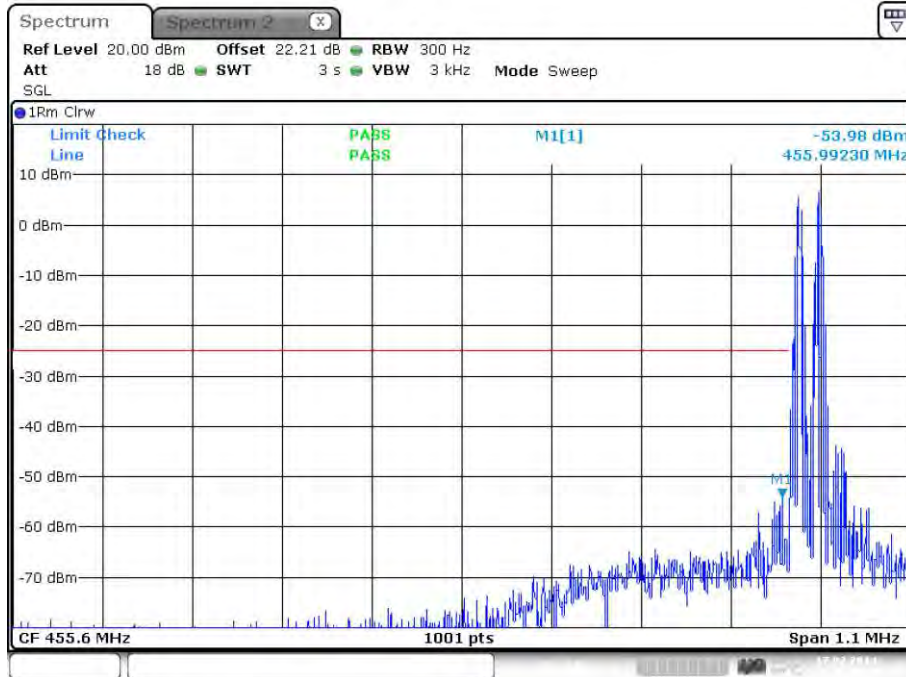

Date: 17.FEB.2014 13:41:23

plot 7.3.1.2-#1 Spurious Emissions at Antenna Terminals: §90.210, §2.1051; Test results; Downlink; Band # 2; Analog < 1MHz to band edge; Lower Band Edge

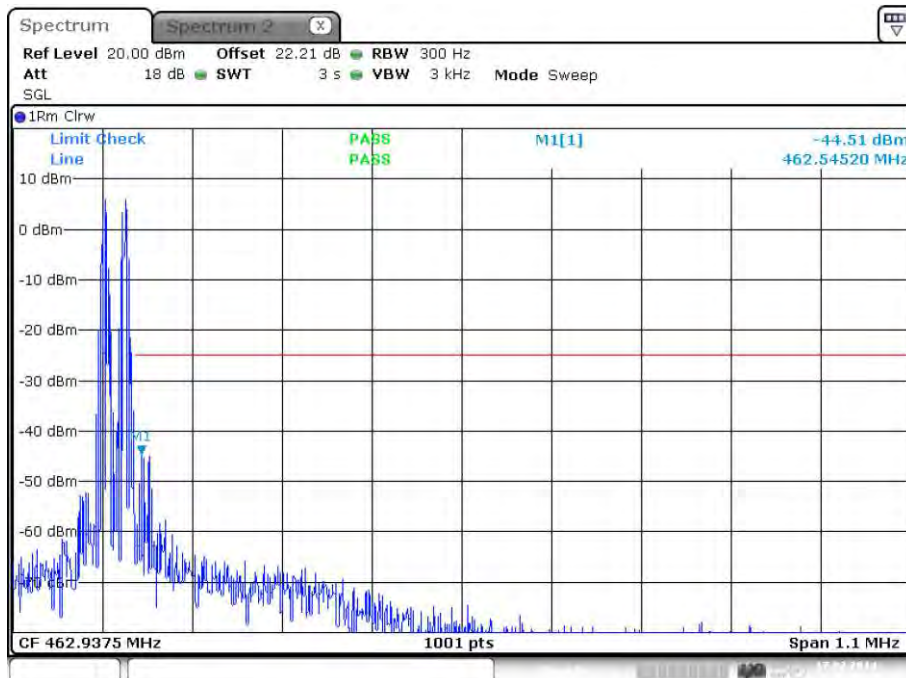

Date: 17.FEB.2014 13:41:41

plot 7.3.1.2-#2 Spurious Emissions at Antenna Terminals: §90.210, §2.1051; Test results; Downlink; Band # 2; Analog < 1MHz to band edge; Upper Band Edge



7.3.1.2.2 APCO Phase1 C4FM < 1MHz to band edge

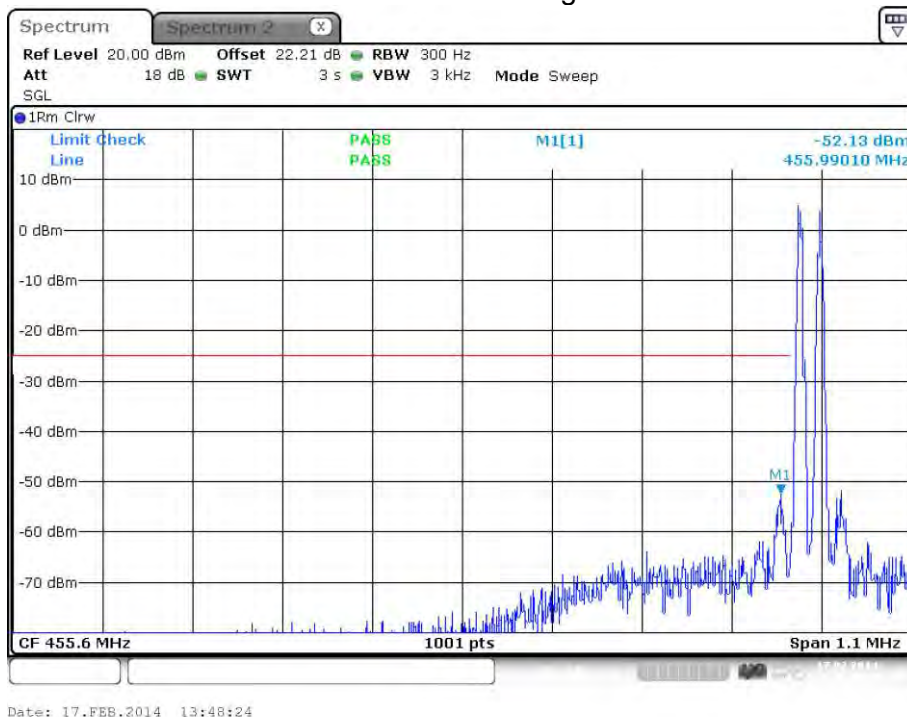

plot 7.3.1.2-#1 Spurious Emissions at Antenna Terminals: §90.210, §2.1051; Test results; Downlink; Band # 2; APCO Phase1 C4FM < 1MHz to band edge; Lower Band Edge

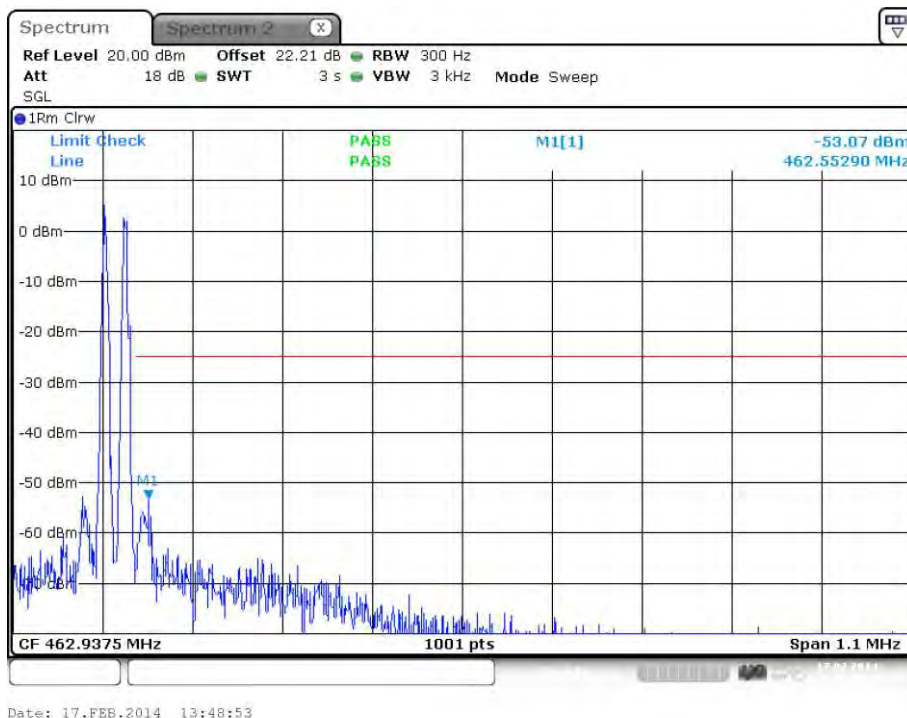

plot 7.3.1.2-#2 Spurious Emissions at Antenna Terminals: §90.210, §2.1051; Test results; Downlink; Band # 2; APCO Phase1 C4FM < 1MHz to band edge; Upper Band Edge



7.3.1.2.3 APCO Phase2 H-DQPSK < 1MHz to band edge

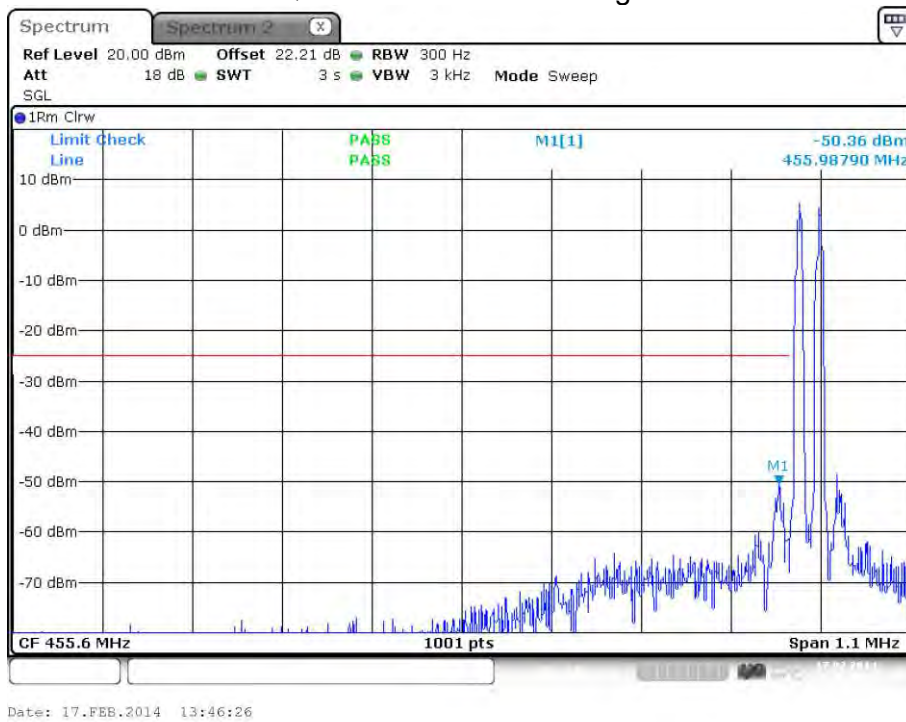

plot 7.3.1.2-#1 Spurious Emissions at Antenna Terminals: §90.210, §2.1051; Test results; Downlink; Band # 2; APCO Phase2 H-DQPSK < 1MHz to band edge; Lower Band Edge

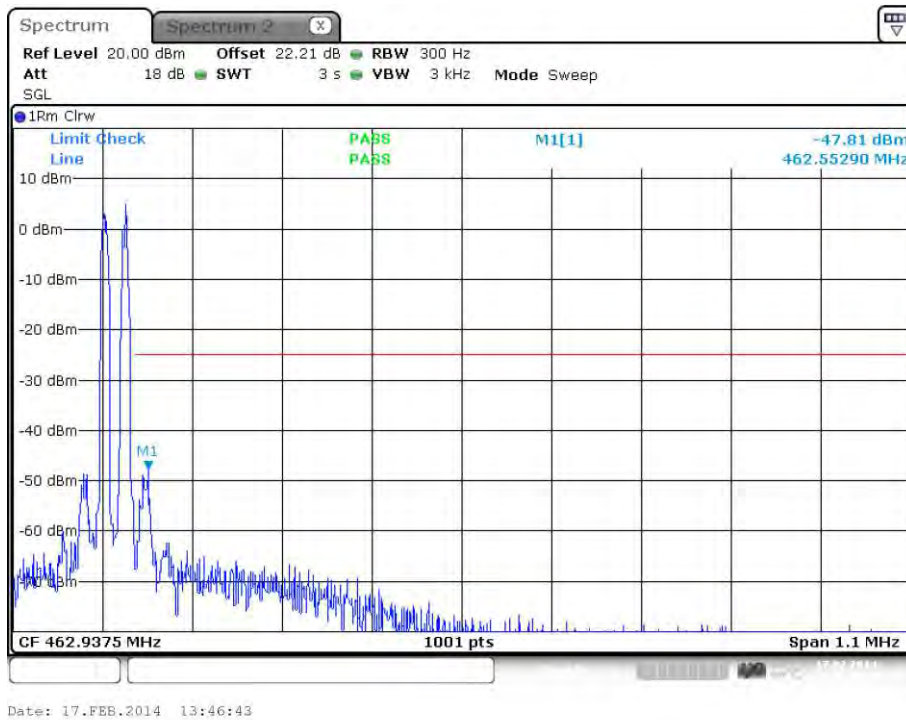

plot 7.3.1.2-#2 Spurious Emissions at Antenna Terminals: §90.210, §2.1051; Test results; Downlink; Band # 2; APCO Phase2 H-DQPSK < 1MHz to band edge; Upper Band Edge



7.3.1.3 Band # 3

7.3.1.3.1 Analog < 1MHz to band edge

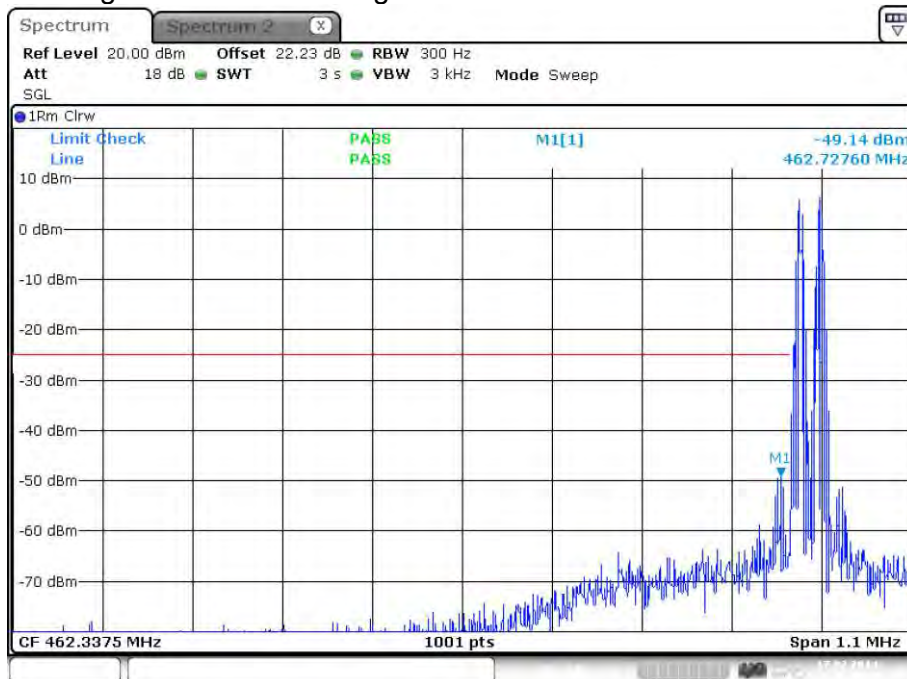

Date: 17.FEB.2014 13:50:15

plot 7.3.1.3-#1 Spurious Emissions at Antenna Terminals: §90.210, §2.1051; Test results; Downlink; Band # 3; Analog < 1MHz to band edge; Lower Band Edge

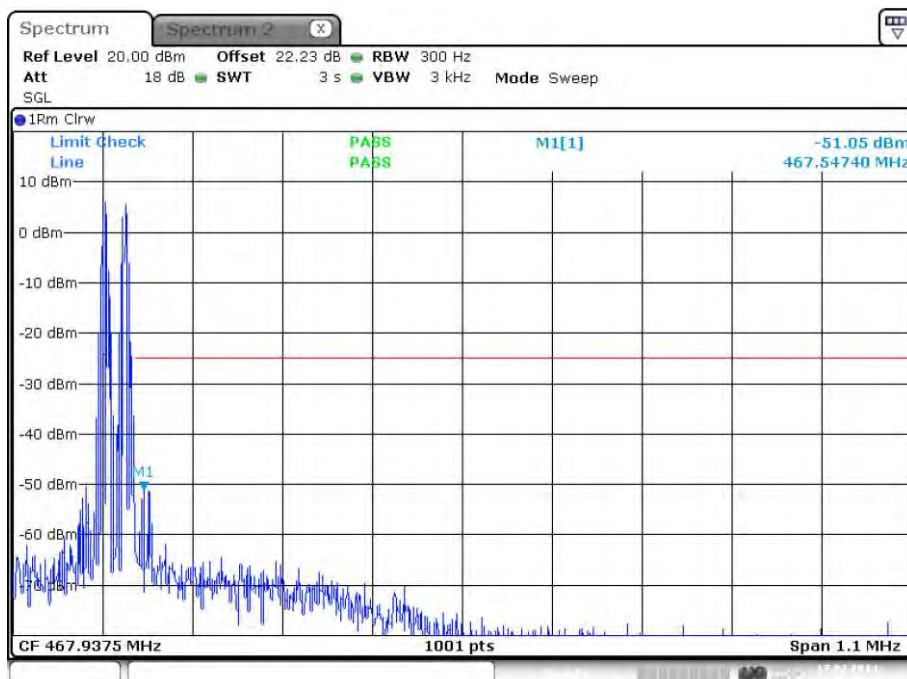

Date: 17.FEB.2014 13:50:33

plot 7.3.1.3-#2 Spurious Emissions at Antenna Terminals: §90.210, §2.1051; Test results; Downlink; Band # 3; Analog < 1MHz to band edge; Upper Band Edge



7.3.1.3.2 APCO Phase1 C4FM < 1MHz to band edge

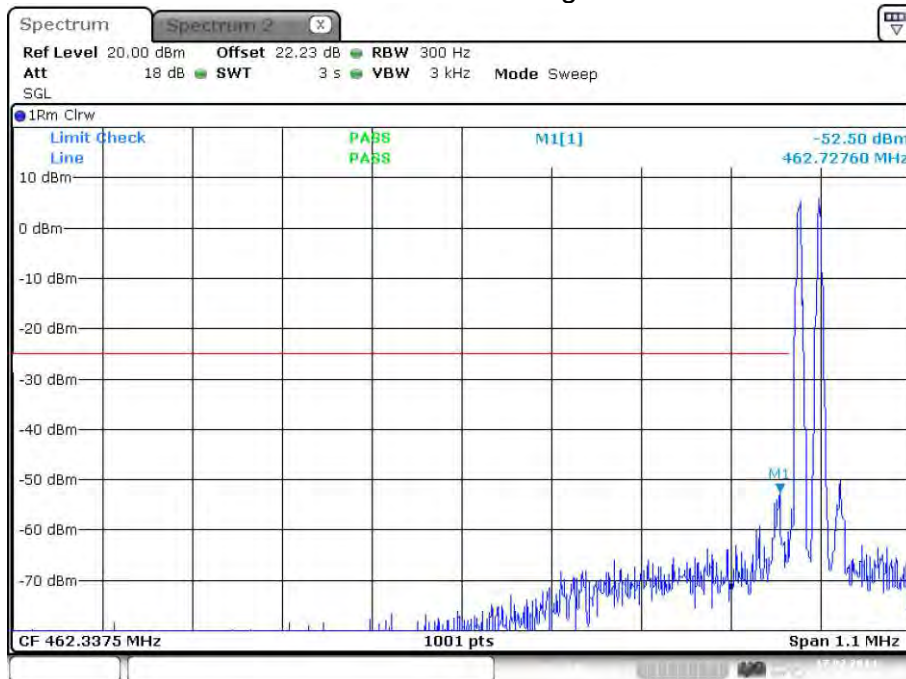

Date: 17.FEB.2014 13:57:40

plot 7.3.1.3-#1 Spurious Emissions at Antenna Terminals: §90.210, §2.1051; Test results; Downlink; Band # 3; APCO Phase1 C4FM < 1MHz to band edge; Lower Band Edge

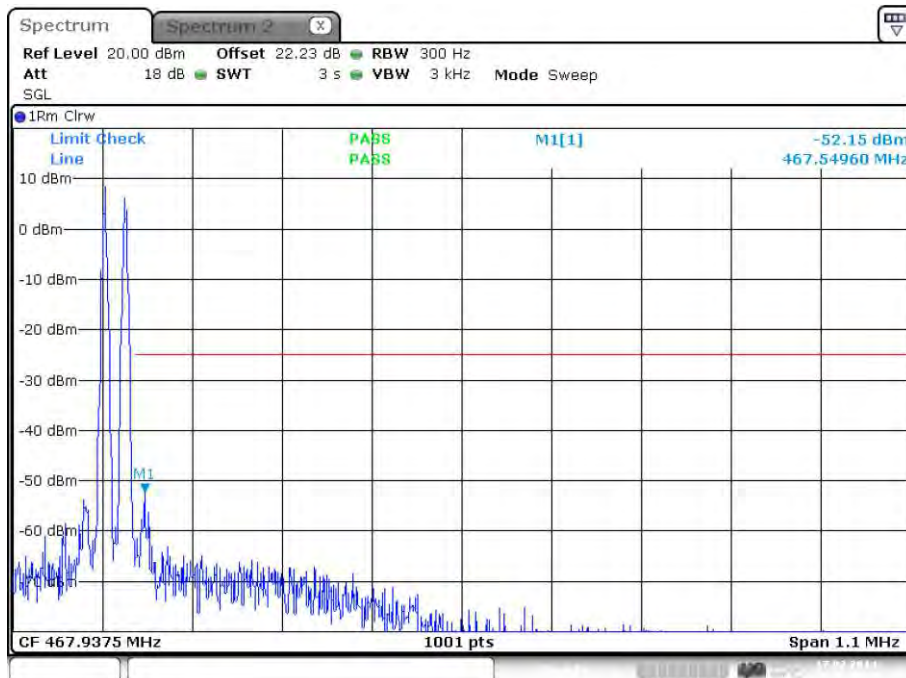

Date: 17.FEB.2014 13:58:15

plot 7.3.1.3-#2 Spurious Emissions at Antenna Terminals: §90.210, §2.1051; Test results; Downlink; Band # 3; APCO Phase1 C4FM < 1MHz to band edge; Upper Band Edge



7.3.1.3.3 APCO Phase2 H-DQPSK < 1MHz to band edge

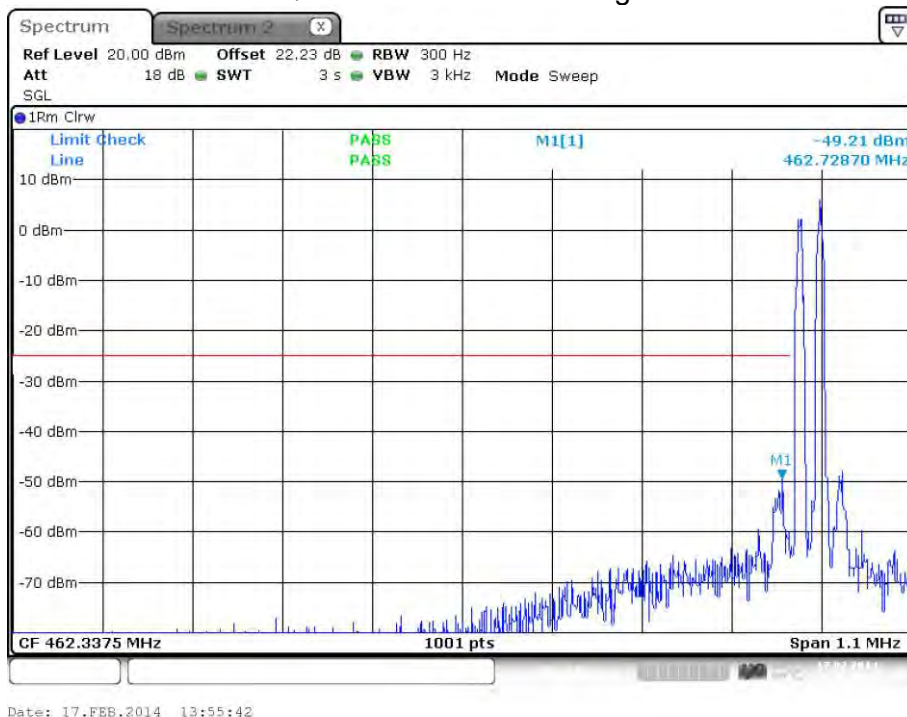

plot 7.3.1.3-#1 Spurious Emissions at Antenna Terminals: §90.210, §2.1051; Test results; Downlink; Band # 3; APCO Phase2 H-DQPSK < 1MHz to band edge; Lower Band Edge

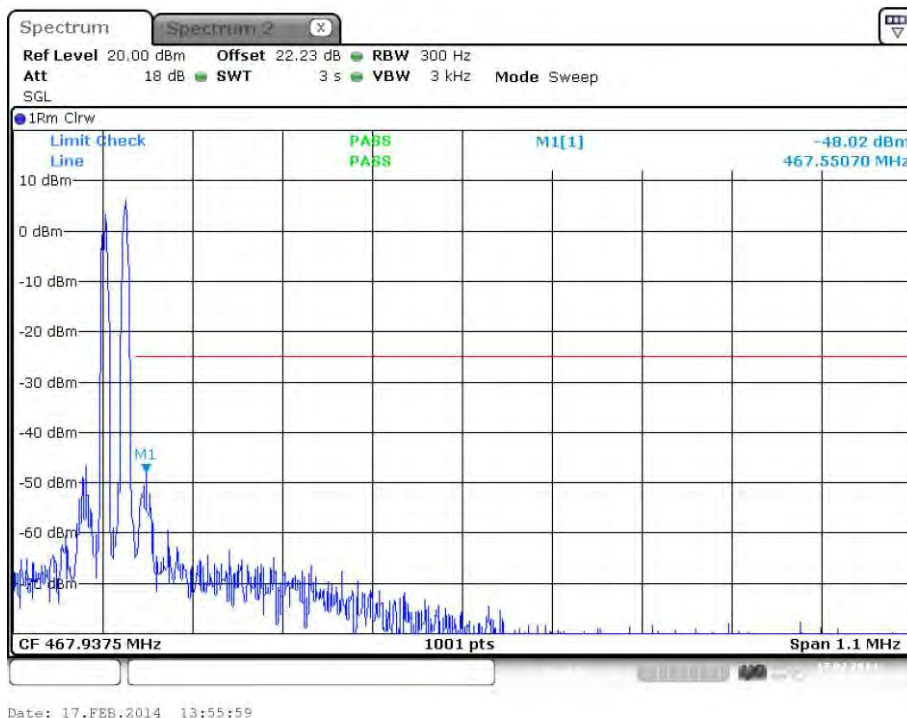

plot 7.3.1.3-#2 Spurious Emissions at Antenna Terminals: §90.210, §2.1051; Test results; Downlink; Band # 3; APCO Phase2 H-DQPSK < 1MHz to band edge; Upper Band Edge





7.3.1.4 Band # 4

7.3.1.4.1 Analog < 1MHz to band edge

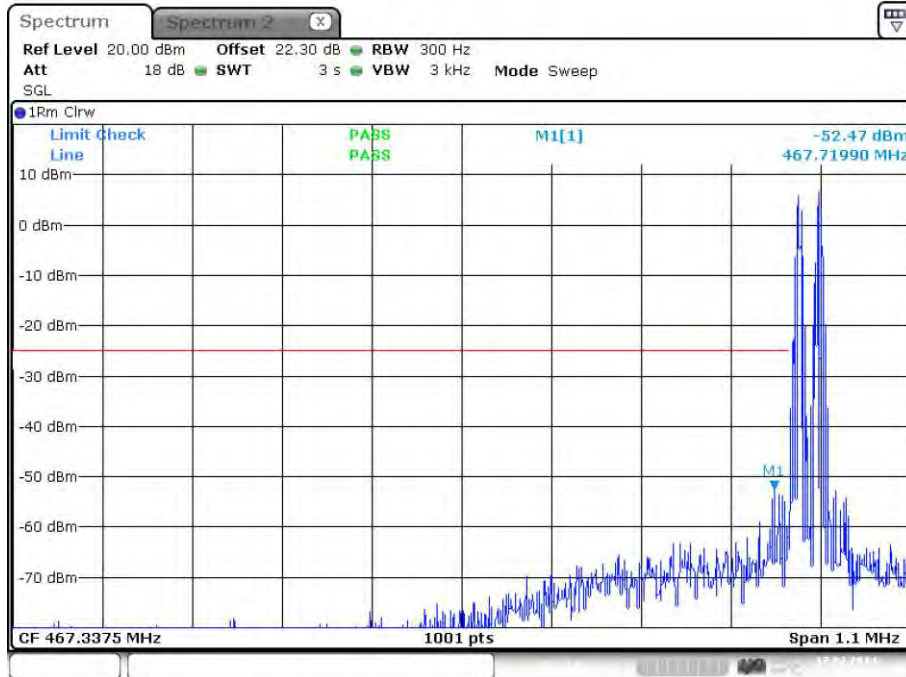

Date: 17.FEB.2014 13:59:38

plot 7.3.1.4-#1 Spurious Emissions at Antenna Terminals: §90.210, §2.1051; Test results; Downlink; Band # 4; Analog < 1MHz to band edge; Lower Band Edge

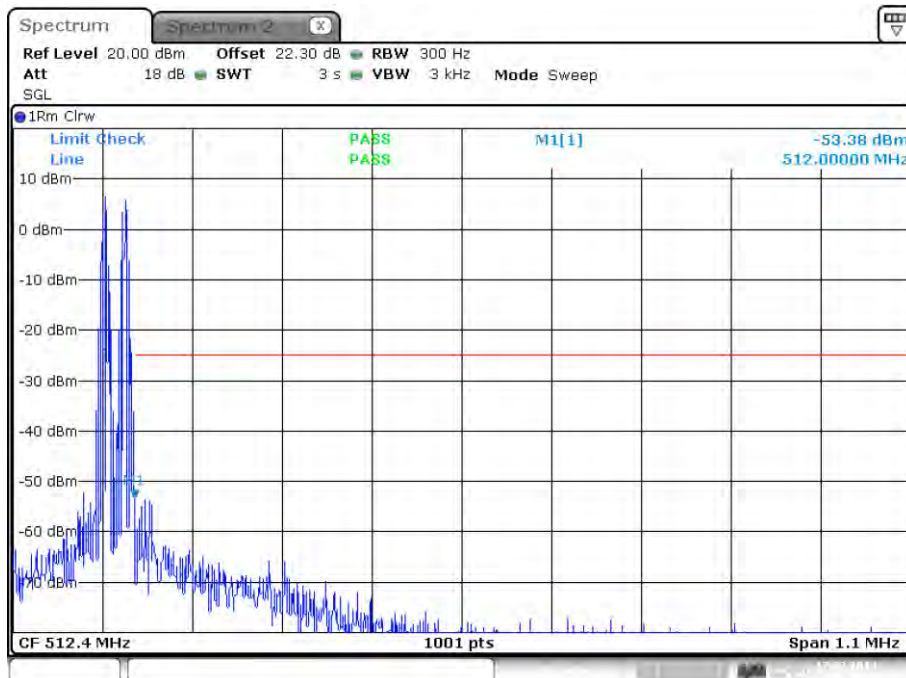

Date: 17.FEB.2014 13:59:55

plot 7.3.1.4-#2 Spurious Emissions at Antenna Terminals: §90.210, §2.1051; Test results; Downlink; Band # 4; Analog < 1MHz to band edge; Upper Band Edge



7.3.1.4.2 APCO Phase1 C4FM < 1MHz to band edge

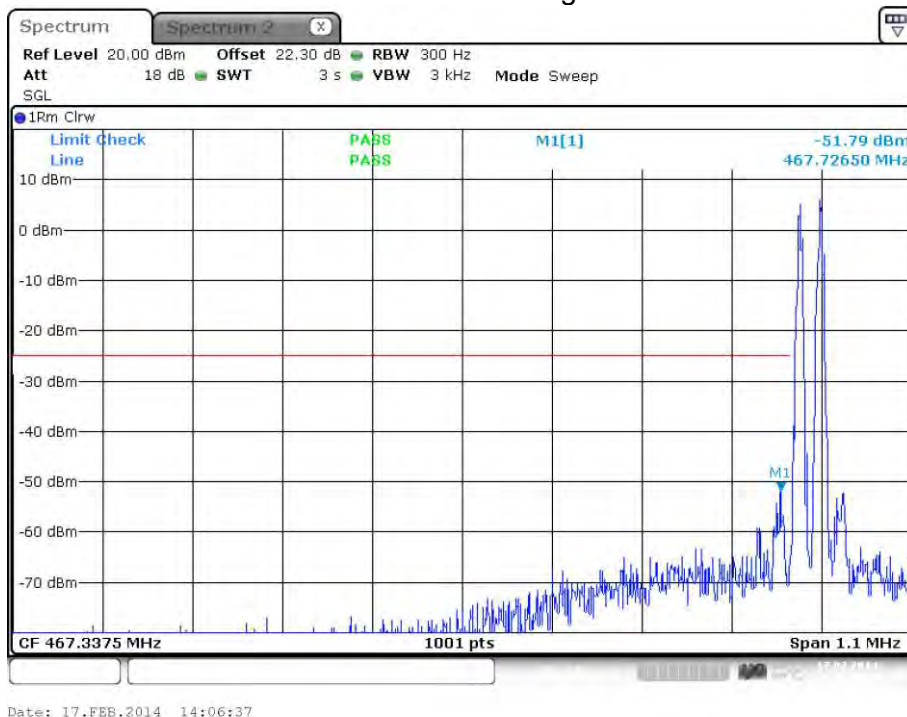

plot 7.3.1.4-#1 Spurious Emissions at Antenna Terminals: §90.210, §2.1051; Test results; Downlink; Band # 4; APCO Phase1 C4FM < 1MHz to band edge; Lower Band Edge

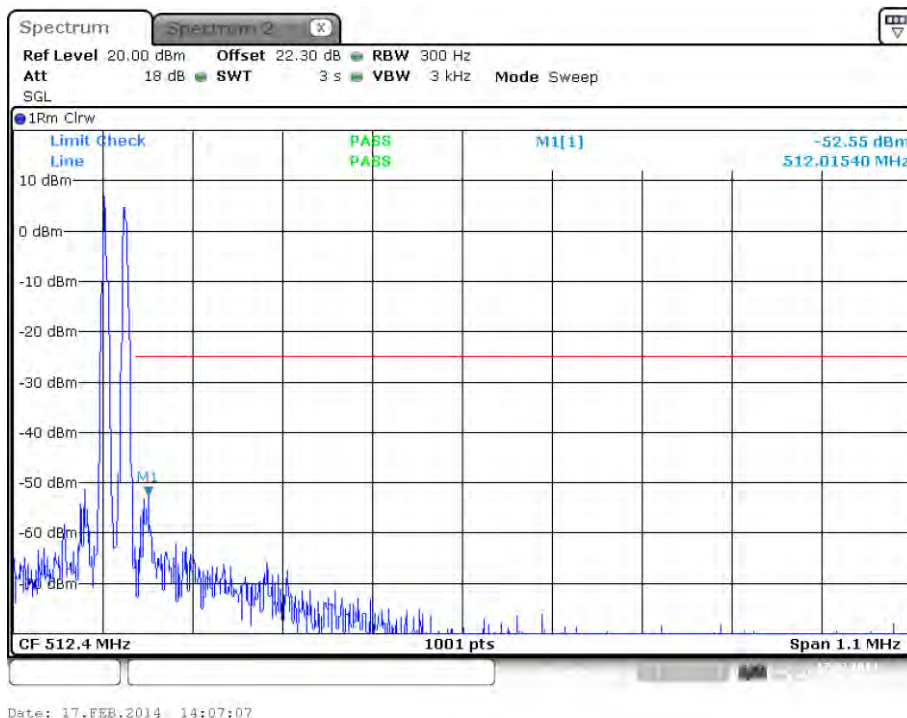

plot 7.3.1.4-#2 Spurious Emissions at Antenna Terminals: §90.210, §2.1051; Test results; Downlink; Band # 4; APCO Phase1 C4FM < 1MHz to band edge; Upper Band Edge



7.3.1.4.3 APCO Phase2 H-DQPSK < 1MHz to band edge

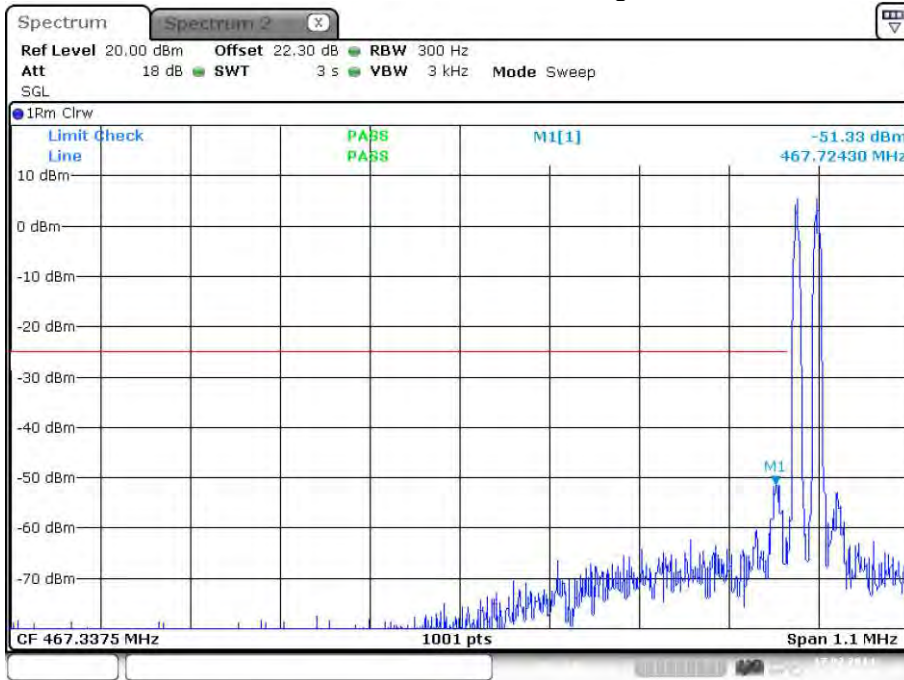

plot 7.3.1.4-#1 Spurious Emissions at Antenna Terminals: §90.210, §2.1051; Test results; Downlink; Band # 4; APCO Phase2 H-DQPSK < 1MHz to band edge; Lower Band Edge

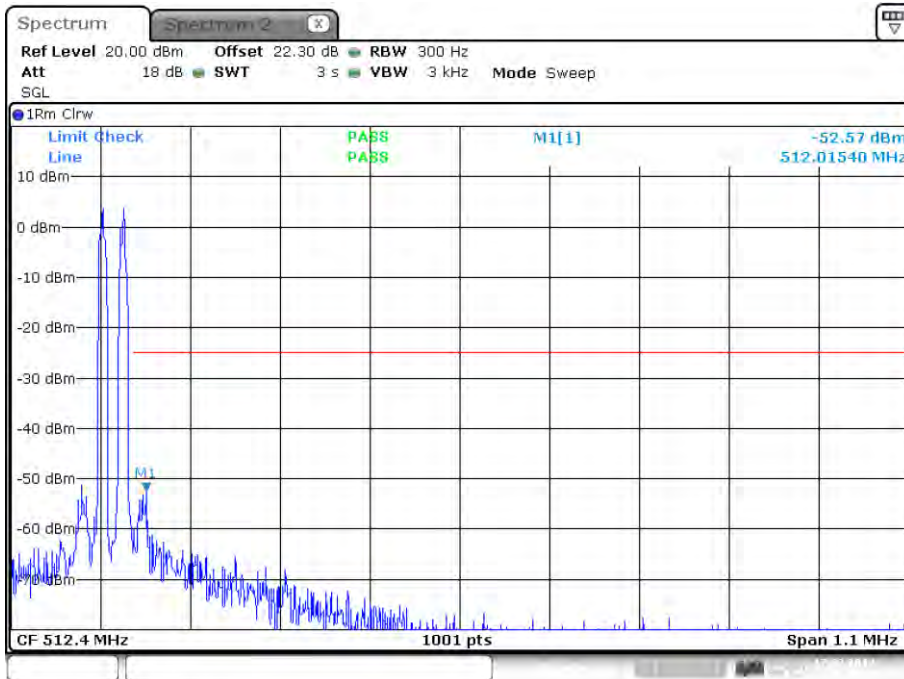

plot 7.3.1.4-#2 Spurious Emissions at Antenna Terminals: §90.210, §2.1051; Test results; Downlink; Band # 4; APCO Phase2 H-DQPSK < 1MHz to band edge; Upper Band Edge



7.3.1.5 Band # 1

7.3.1.5.1 Analog > 1MHz to band edge

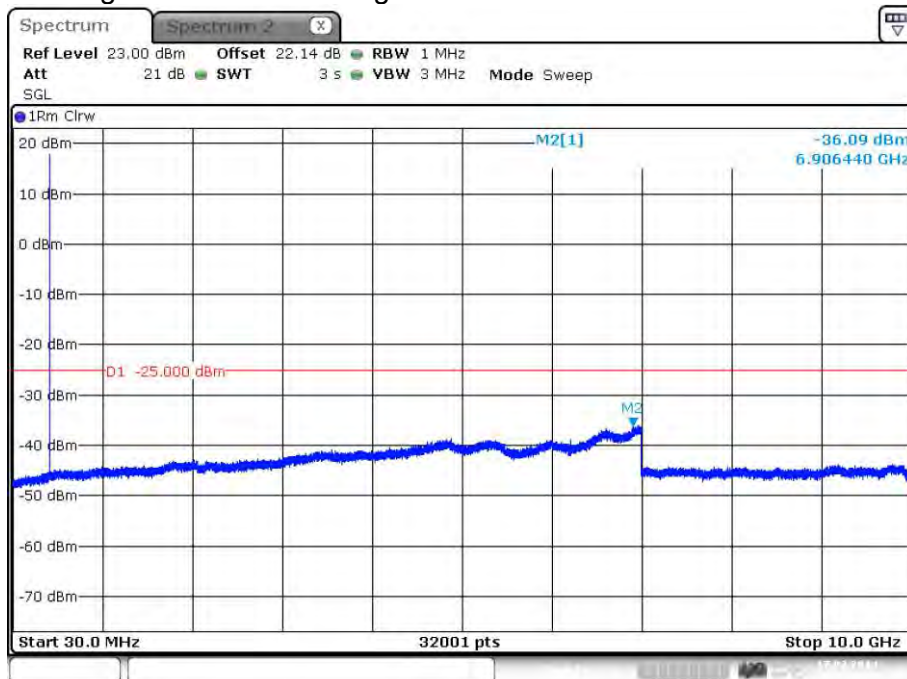

Date: 17.FEB.2014 13:28:53

plot 7.3.1.5-#1 Spurious Emissions at Antenna Terminals: §90.210, §2.1051; Test results; Downlink; Band # 1; Analog > 1MHz to band edge;

7.3.1.5.2 APCO Phase1 C4FM > 1MHz to band edge

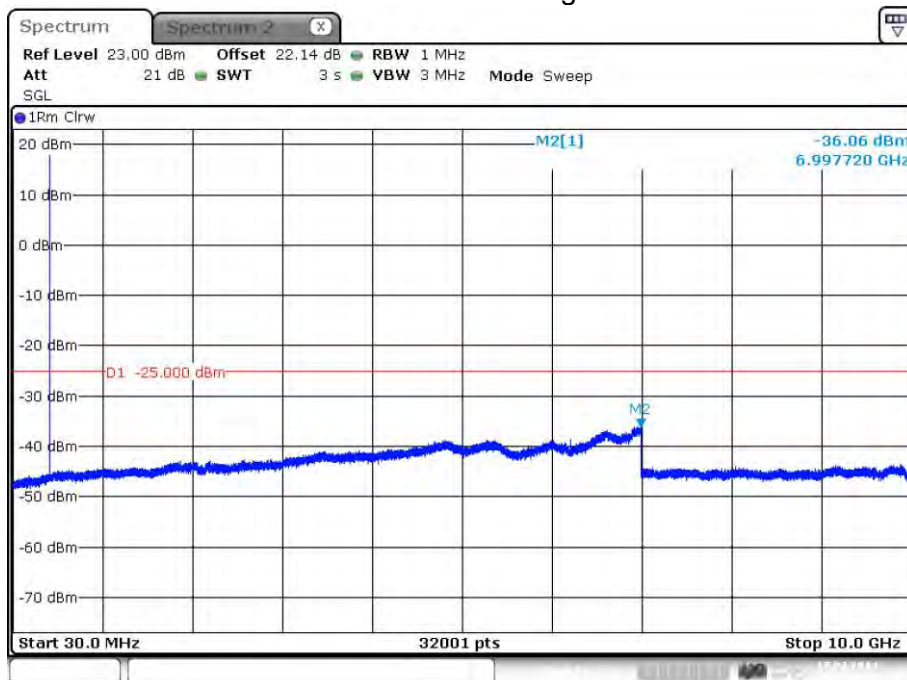

Date: 17.FEB.2014 13:35:13

plot 7.3.1.5-#1 Spurious Emissions at Antenna Terminals: §90.210, §2.1051; Test results; Downlink; Band # 1; APCO Phase1 C4FM > 1MHz to band edge;



7.3.1.5.3 APCO Phase2 H-DQPSK > 1MHz to band edge

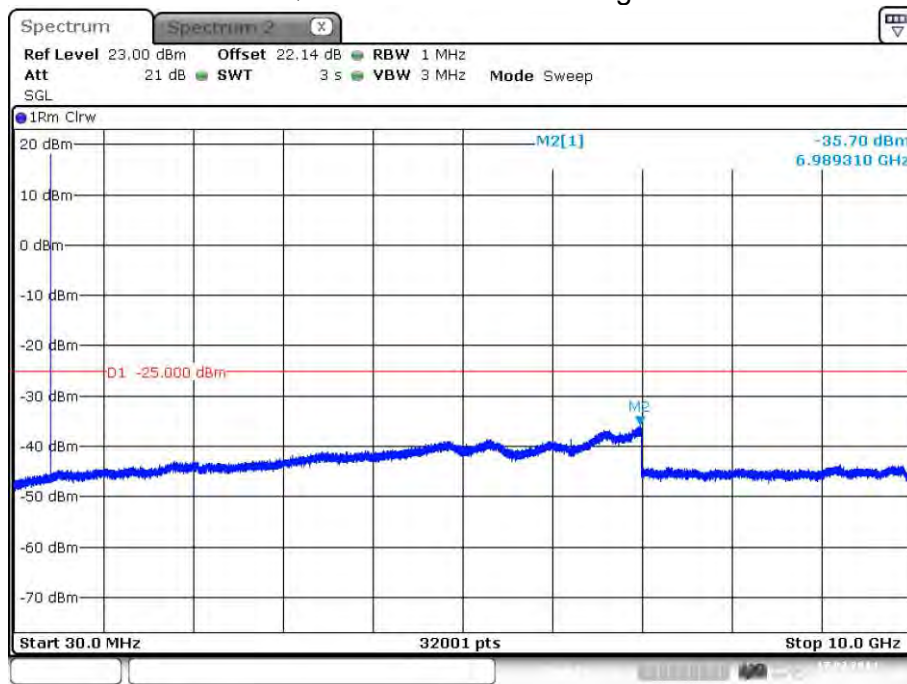

Date: 17.FEB.2014 13:33:17

plot 7.3.1.5-#1 Spurious Emissions at Antenna Terminals: §90.210, §2.1051; Test results; Downlink; Band # 1; APCO Phase2 H-DQPSK > 1MHz to band edge;

7.3.1.6 Band # 2

7.3.1.6.1 Analog > 1MHz to band edge

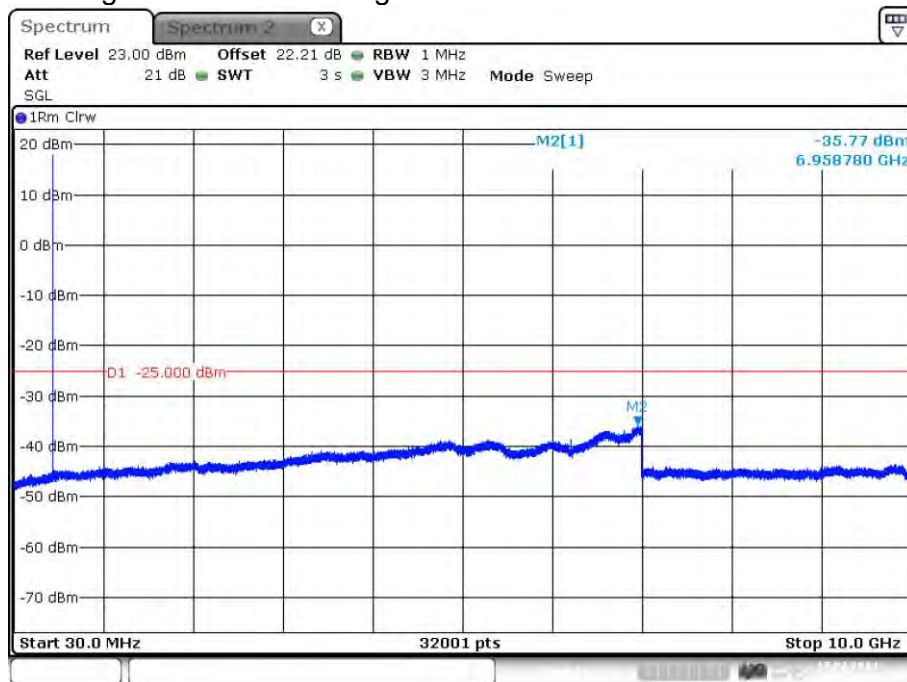

Date: 17.FEB.2014 13:40:59

plot 7.3.1.6-#1 Spurious Emissions at Antenna Terminals: §90.210, §2.1051; Test results; Downlink; Band # 2; Analog > 1MHz to band edge;



7.3.1.6.2 APCO Phase1 C4FM > 1MHz to band edge

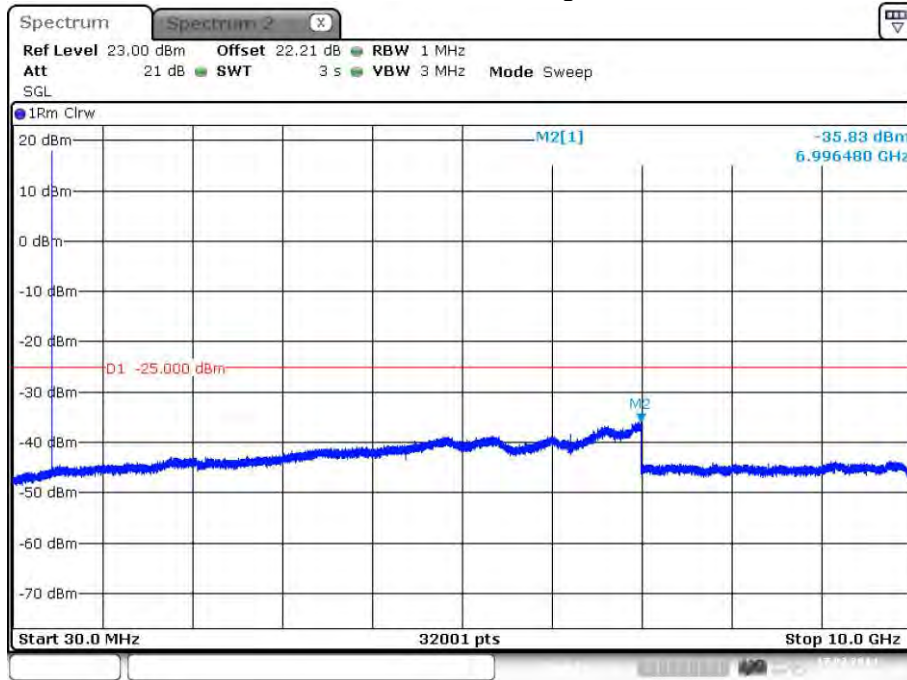

Date: 17.FEB.2014 13:48:02

plot 7.3.1.6-#1 Spurious Emissions at Antenna Terminals: §90.210, §2.1051; Test results; Downlink; Band # 2; APCO Phase1 C4FM > 1MHz to band edge;

7.3.1.6.3 APCO Phase2 H-DQPSK > 1MHz to band edge

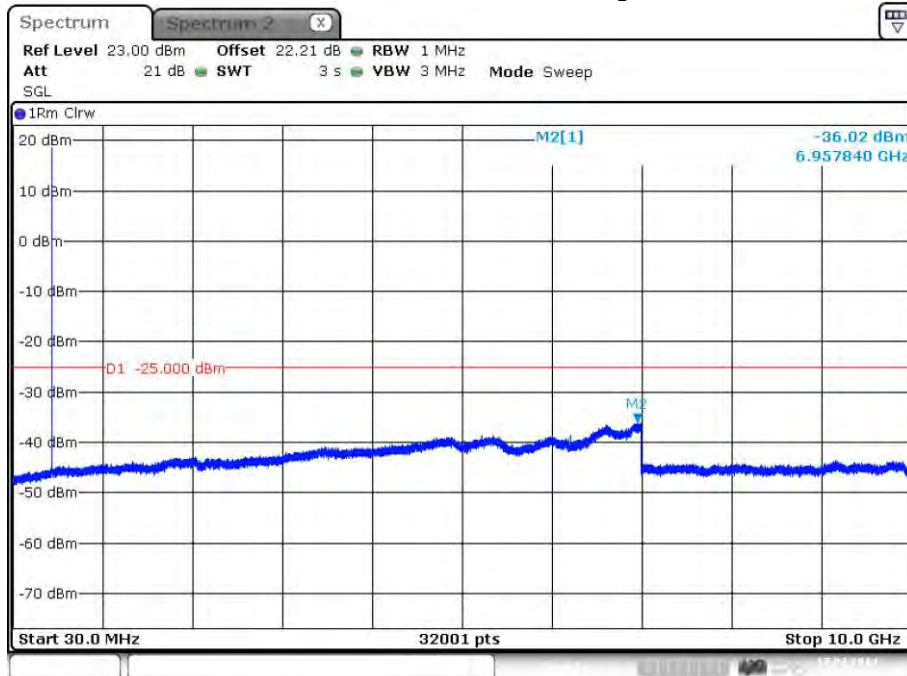

Date: 17.FEB.2014 13:46:06

plot 7.3.1.6-#1 Spurious Emissions at Antenna Terminals: §90.210, §2.1051; Test results; Downlink; Band # 2; APCO Phase2 H-DQPSK > 1MHz to band edge;



7.3.1.7 Band # 3

7.3.1.7.1 Analog > 1MHz to band edge

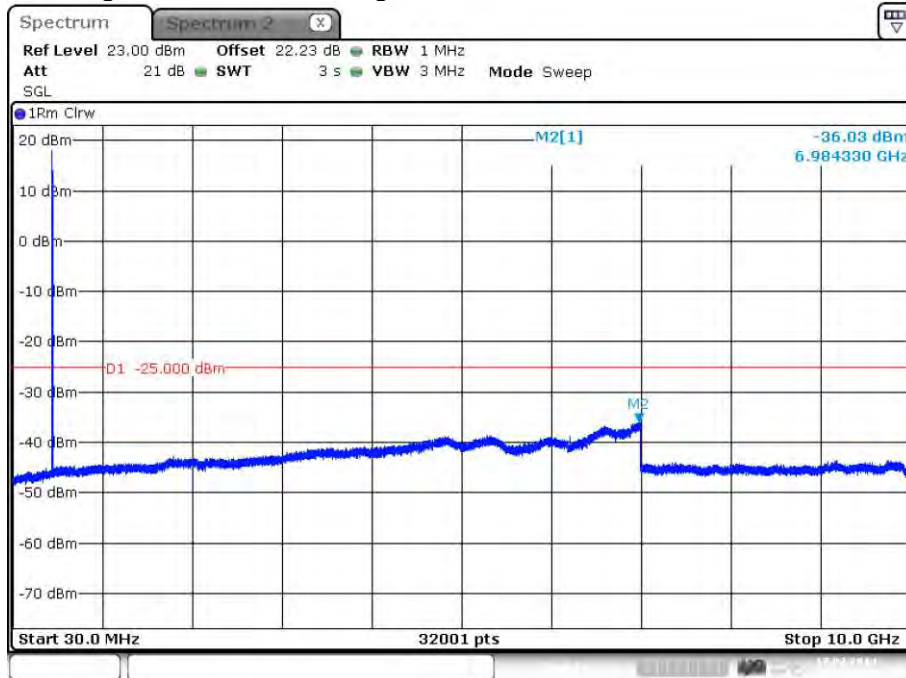

Date: 17.FEB.2014 13:49:51

plot 7.3.1.7-#1 Spurious Emissions at Antenna Terminals: §90.210, §2.1051; Test results; Downlink; Band # 3; Analog > 1MHz to band edge;

7.3.1.7.2 APCO Phase1 C4FM > 1MHz to band edge

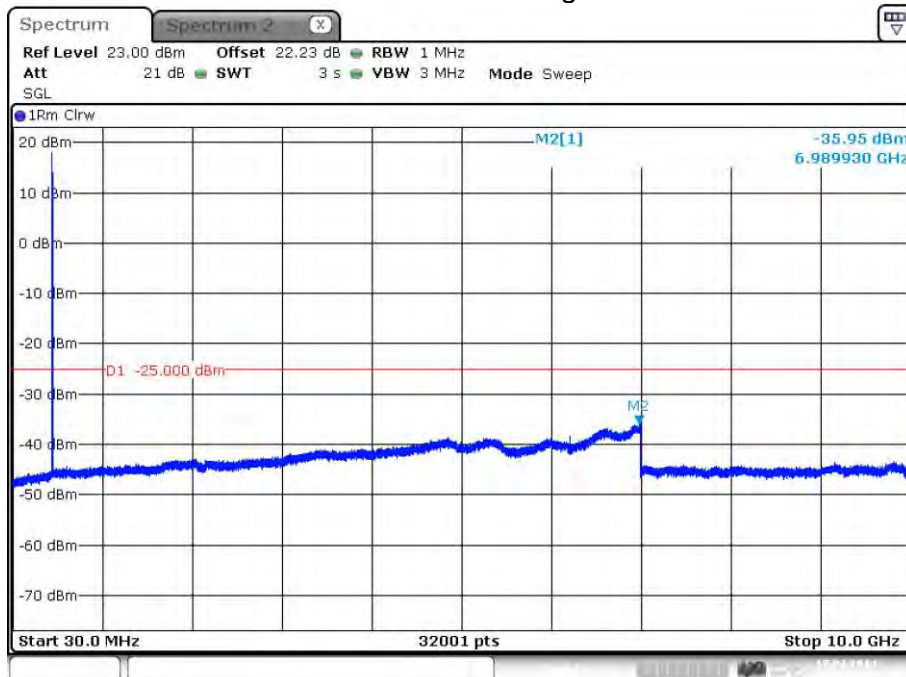

Date: 17.FEB.2014 13:57:18

plot 7.3.1.7-#1 Spurious Emissions at Antenna Terminals: §90.210, §2.1051; Test results; Downlink; Band # 3; APCO Phase1 C4FM > 1MHz to band edge;



7.3.1.7.3 APCO Phase2 H-DQPSK > 1MHz to band edge

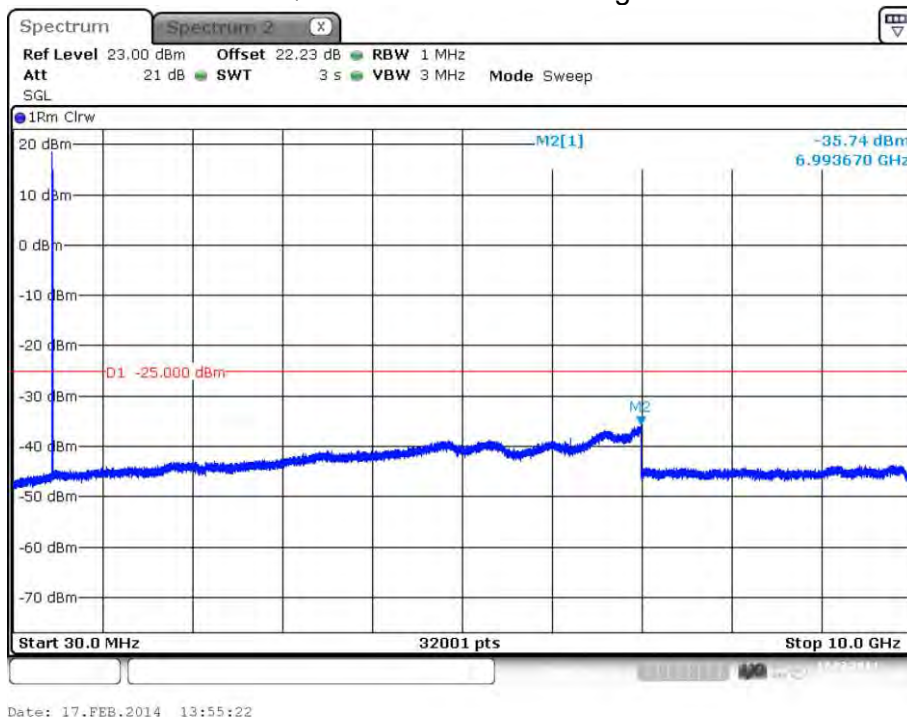

plot 7.3.1.7-#1 Spurious Emissions at Antenna Terminals: §90.210, §2.1051; Test results; Downlink; Band # 3; APCO Phase2 H-DQPSK > 1MHz to band edge;

7.3.1.8 Band # 4

7.3.1.8.1 Analog > 1MHz to band edge

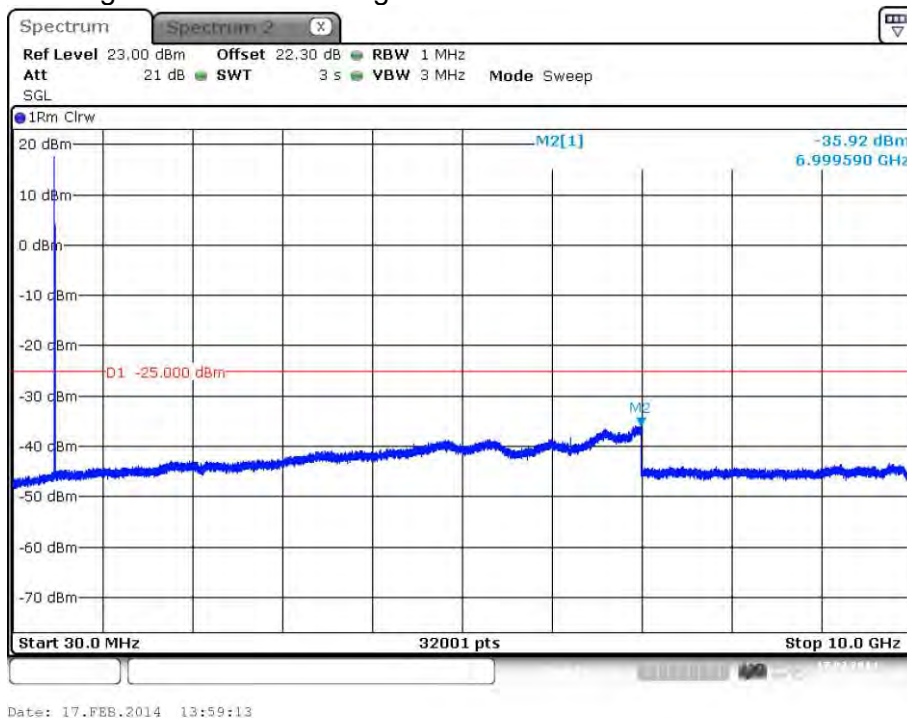

plot 7.3.1.8-#1 Spurious Emissions at Antenna Terminals: §90.210, §2.1051; Test results; Downlink; Band # 4; Analog > 1MHz to band edge;





7.3.1.8.2 APCO Phase1 C4FM > 1MHz to band edge

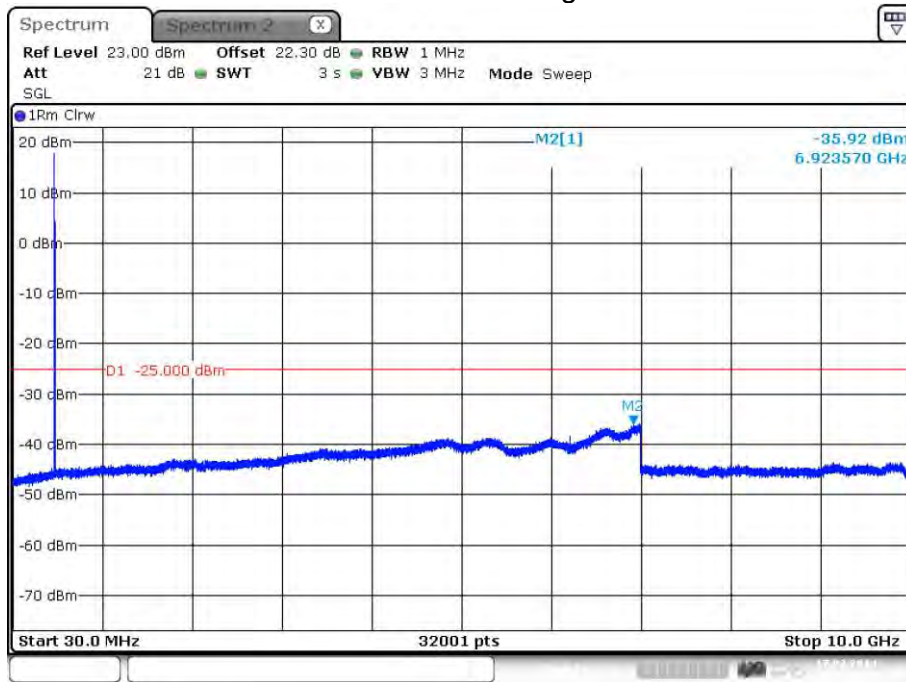

Date: 17.FEB.2014 14:05:51

plot 7.3.1.8-#1 Spurious Emissions at Antenna Terminals: §90.210, §2.1051; Test results; Downlink; Band # 4; APCO Phase1 C4FM > 1MHz to band edge;

7.3.1.8.3 APCO Phase2 H-DQPSK > 1MHz to band edge

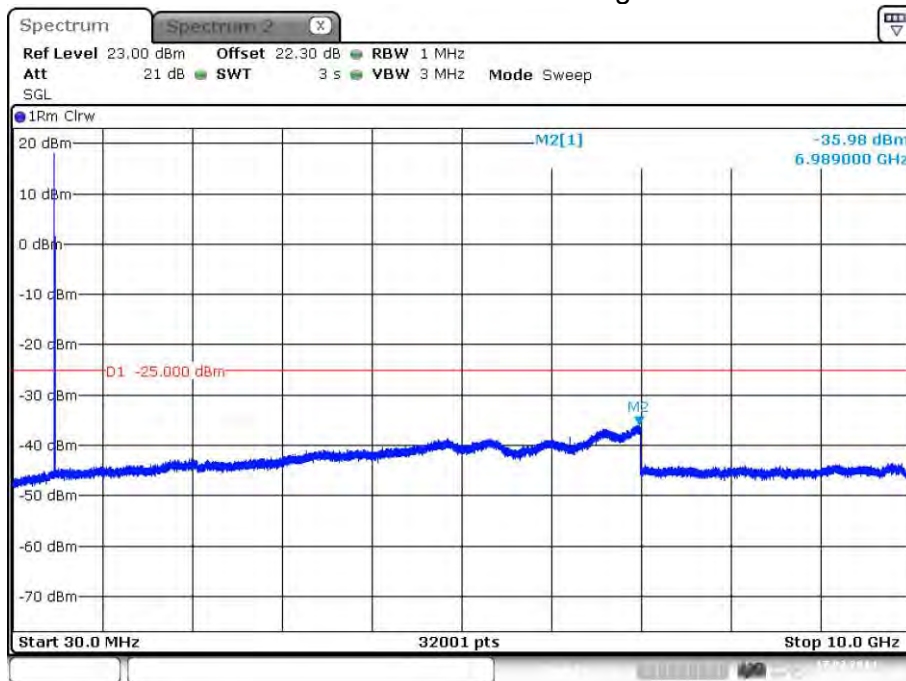

Date: 17.FEB.2014 14:03:56

plot 7.3.1.8-#1 Spurious Emissions at Antenna Terminals: §90.210, §2.1051; Test results; Downlink; Band # 4; APCO Phase2 H-DQPSK > 1MHz to band edge;



### 7.3.2 Uplink

n.a.

Note: The EUT does not transmit over the air in the uplink direction.

### 7.4 Summary test result

Test result	complies, according the plots above
Tested by:	M. Leinfelder
Date:	17.02.2014

## 8 Out of Band Rejection

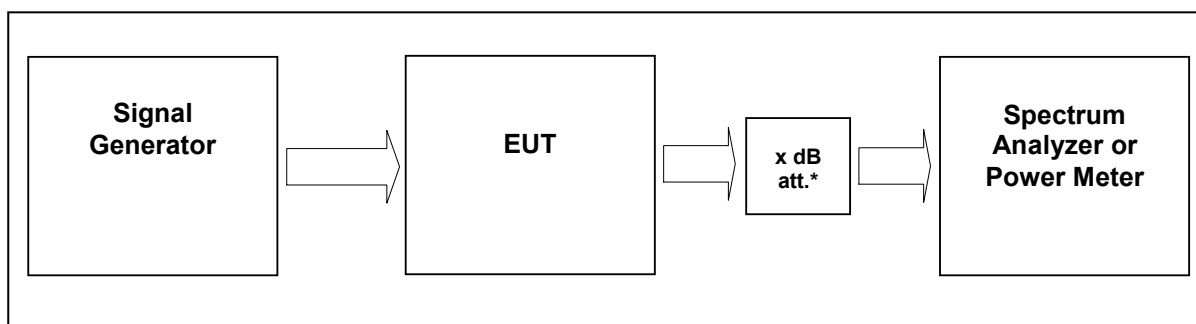

External Attenuator DL      x dB = 20 dB  
figure 8-#1 Test setup: Out of Band Rejection

Measurement uncertainty	± 0,38 dB
Test equipment used	9054, 9233, 7444; 7306; 7144; 7454; 7453; 7341; 7449

### 8.1 Limit

KDB 935210 D02 v02

Clause: D.3 POLICIES AND PROCEDURES;

Subclause:

(I) Out of Band Rejection – Test for rejection of out of band signals. Filter frequency response plots are acceptable.

### 8.2 Test method

KDB 935210 D02 v02

Clause: D.3 POLICIES AND PROCEDURES;

Subclause:

(I) Out of Band Rejection – Test for rejection of out of band signals. Filter frequency response plots are acceptable.

### 8.3 Test results

Detector Peak max hold



### 8.3.1 Downlink

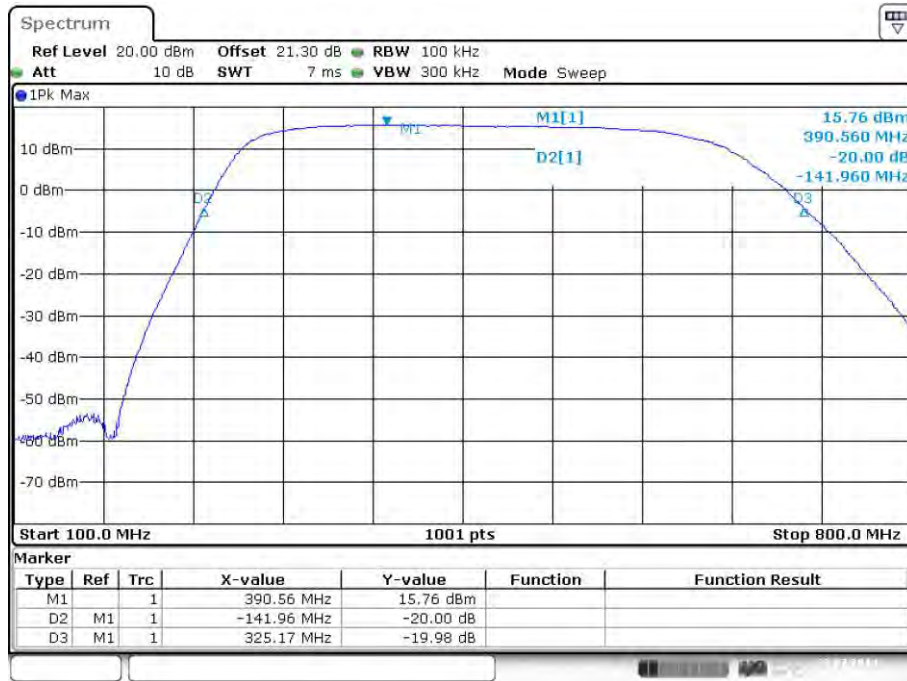

Date: 22.JUL.2014 15:59:03

plot 8.3.1-#1 Out of Band Rejection; Test results; Downlink;

### 8.3.2 Uplink

n.a.

Note: The EUT does not transmit over the air in the uplink direction.

### 8.4 Summary test result

Test result	complies, according the plots above
Tested by:	M. Leinfelder
Date:	22.07.2014



## 9 Noise floor

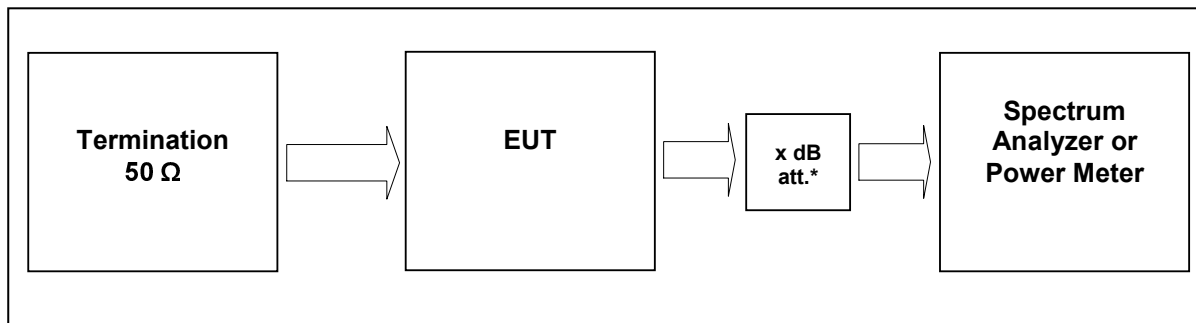

External Attenuator DL      x dB = 0 dB  
 figure 9-#1 Test setup: Noise floor

Measurement uncertainty	± 0,38 dB
Test equipment used	9054, 7144; 7454; 7453; 7449;

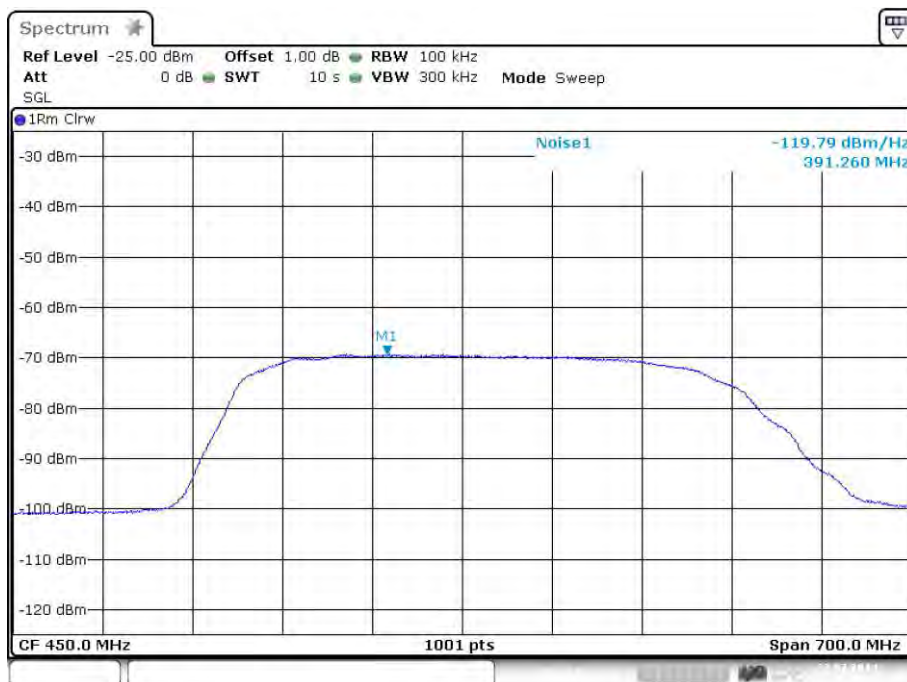

Date: 22.JUL.2014 15:52:37

plot 8.3.1-#1 Noise floor;

## 10 Radiated Spurious Emissions at the ECL (Bureau Veritas): §90.210, §2.1053, RSS-Gen, RSS-131



picture 10.1: name plate

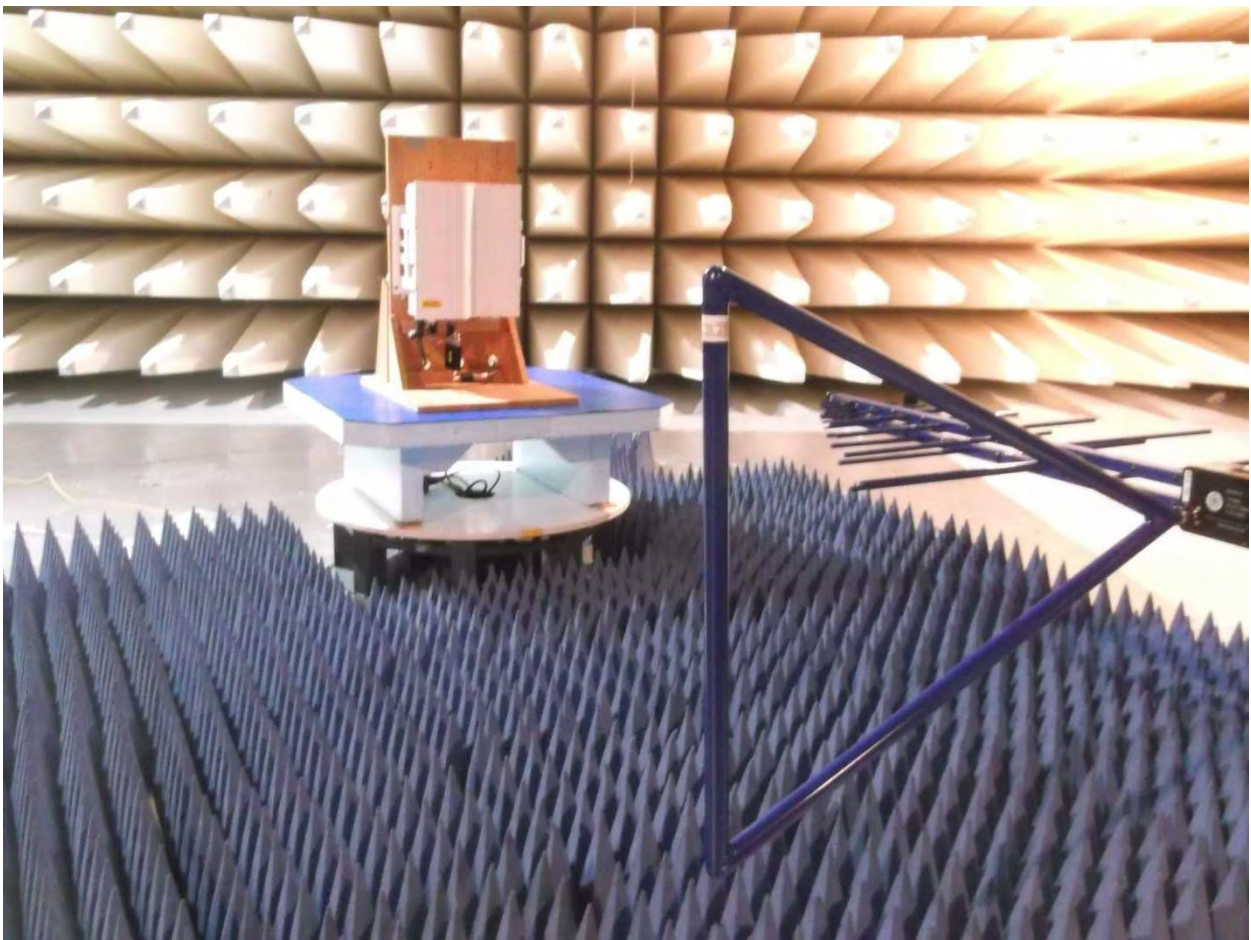

picture 10.2: Test setup: Field Strength Emission <1 GHz @3m in the SAC

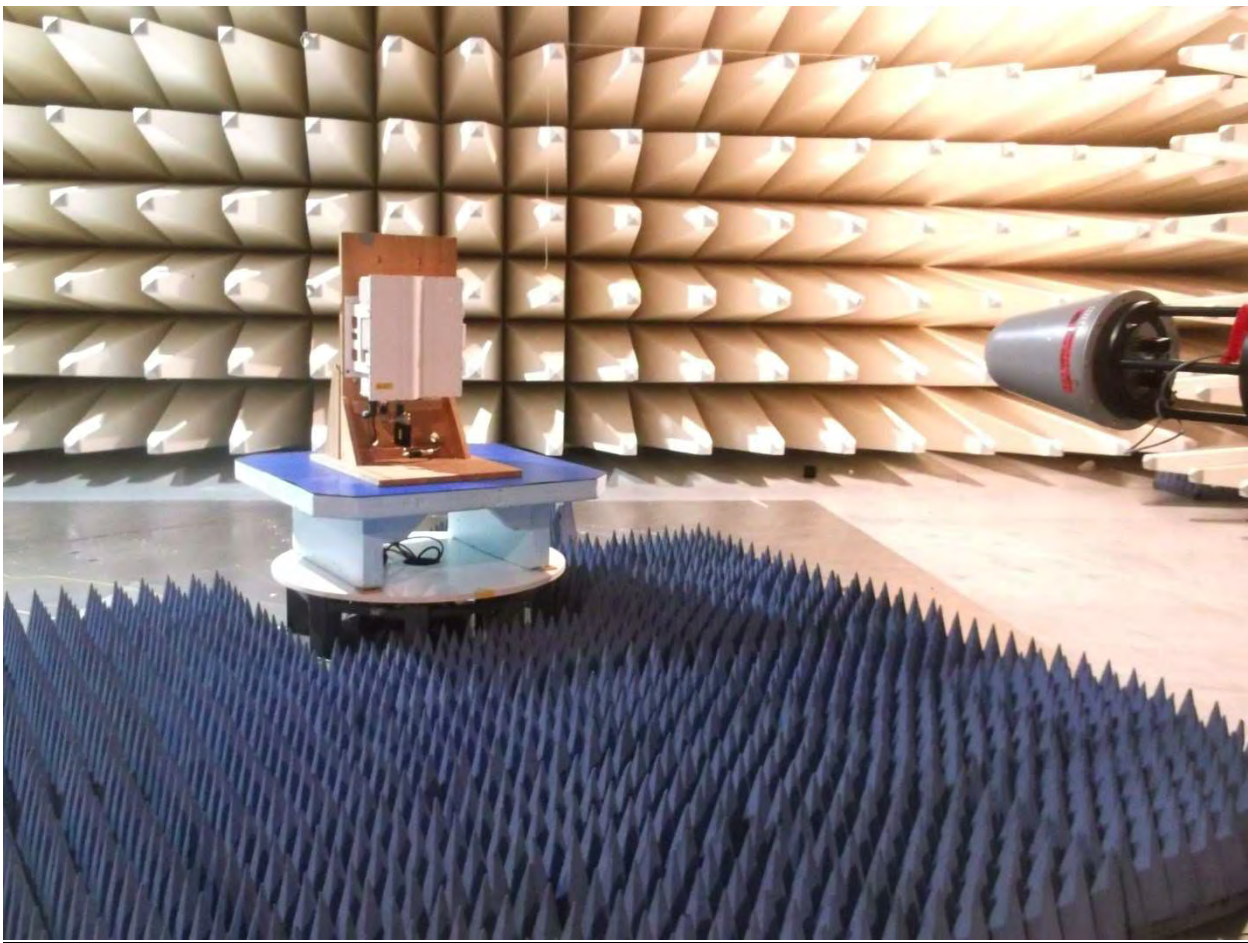

**picture 7.3:** Test setup: Field Strength Emission >1 GHz @3m in the SAC



This clause specifies requirements for the measurement of radiated emission.

Frequency range	Distance: EUT <-> antenna / location	Limit	Test method
30 MHz - 1 GHz	3 metres / SAC	FCC 47 CFR Part 90.210	TIA/EIA-603-C:2004
1 GHz – 21 GHz	3 metres / SAC		

**Test equipment used:**

Designation	Type	Manufacturer	Invent.-no.	Cal.-date	due Cal.- date	used
EMI test receiver	ESI40	Rohde & Schwarz	E1687	28.11.2013	28.11.2014	X
Antenna	CBL 6111	Chase	K1026	27.06.2014	27.06.2015	X
Pre amplifier	AM1431	Miteq	K1721	16.04.2014	16.04.2015	X
Antenna	HL 025	R&S	K1114	03.03.2014	03.03.2015	X
Preamplifier	AFS4-00102000	Miteq	K817	12.03.2014	12.03.2015	X
RF Cable	Sucoflex 100	Suhner	K1760	03.07.2014	03.07.2015	X

The REMI version 2.135 has been used for max search.

**Test set-up:**

Test location: SAC  
 Both, the Fully Anechoic Chamber (FAC) and the Semi Anechoic Chamber (SAC) fulfil the requirements of ANSI C63.4 and CISPR 16-1-4 with regards to NSA and SVSWR.

Test Voltage: 115V / 60 Hz  
 Type of EUT: Wall mounted

**Measurement uncertainty:**

Measurement uncertainty expanded (95% or K=2)	± 4,7 dB for ANSI C63.4 measurement ± 0,5 dB for TIA-603 measurement
--	---

### 10.1 Method of Measurement

**Measurement procedure. TIA-603-C**

The antenna substitution method is used to determine the equivalent radiated power at spurious frequencies. The spurious emissions are measured at a distance of 3 meters. The EUT is then replaced with a reference substitution antenna with a known gain referenced to a dipole. This antenna is fed with a signal at the spurious frequency. The level of the signal is adjusted to repeat the previously measured level. The resulting eirp is the signal level fed to the reference antenna corrected for gain referenced to an isotropic dipole (see Figure 7.2).

From KDB (AMPLIFIER, BOOSTER, AND REPEATER REMINDER SHEET):  
Radiated spurs (enclosure) – Use of CW signal (low, mid. and high freq.) is acceptable rather than all modulations.

The maximum RFI field strength was determined during the measurement by rotating the turntable ( $\pm 180$  degrees) and varying the height of the receive antenna ( $h = 1 \dots 4$  m) as like defined in ANSI C63.4. A measurement receiver has been used with a RBW 120 kHz up to 1 GHz and 1 MHz above 1 GHz. Steps with during pre measurement was half the RBW.

Both, the Fully Anechoic Chamber (FAC) and the Semi Anechoic Chamber (SAC) fulfil the requirements of ANSI C63.4 and CISPR 16-1-4 with regards to NSA and SVSWR.

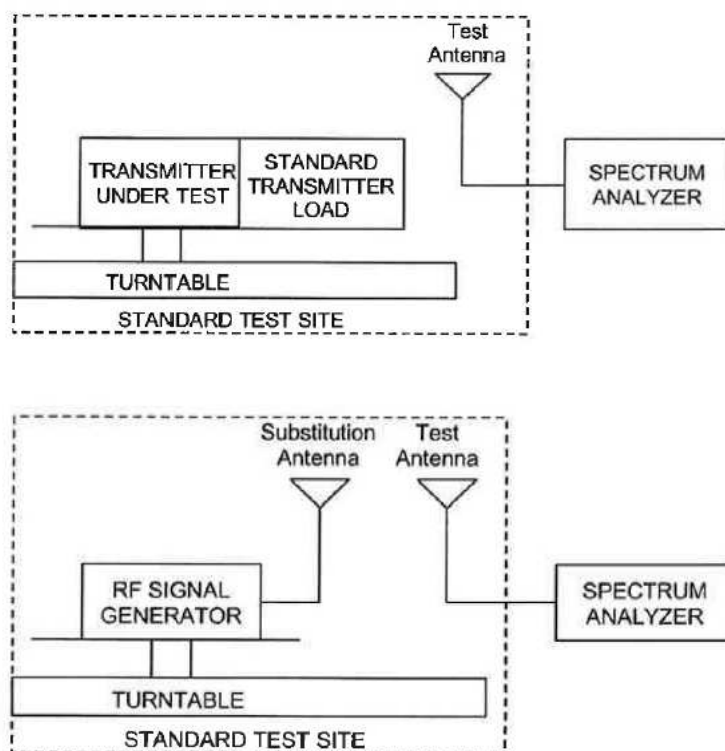

Figure #7.2 Substitution methods TIA/EIA-603-C





### 10.2 Limit

Minimum standard: §90.210, Table "Application Emission Mask"

Frequency Band (MHz)	Mask for equipment with Audio Low pass filter	Mask for Equipment without audio low pass filter
421 - 512	B, D or E	C, D or E

MASK	Spurious Limit
E	-25 dBm

### 10.3 Climatic values in the lab

Temperature: 21°  
Relative Humidity: 47%  
Air-pressure: 998 hPa

### 10.4 Test results

#### 10.4.1.1 30 MHz to 1 GHz Downlink (Bottom – Middle – Top)

Vertikal / Horizontal RBW = 120kHz

Band #1: 406.1/430.5/454 MHz

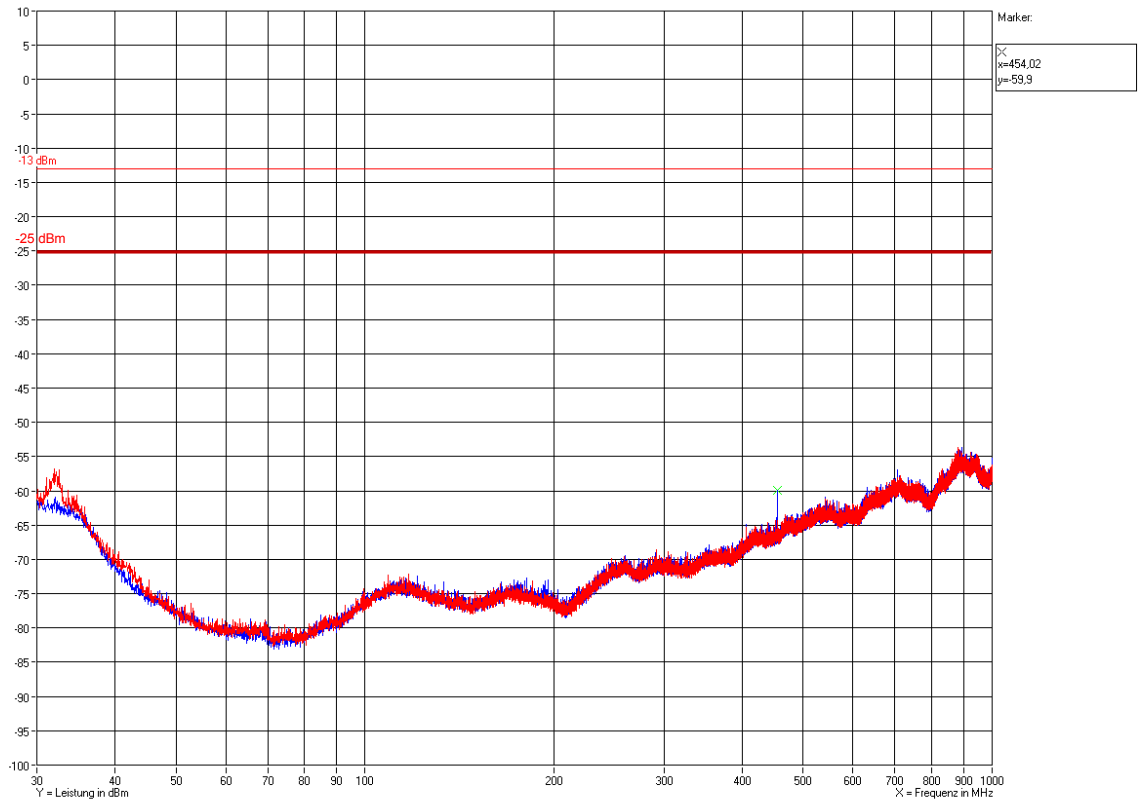



**BUREAU  
VERITAS**

Band #2: 456,1/459,26875/462,5375 MHz

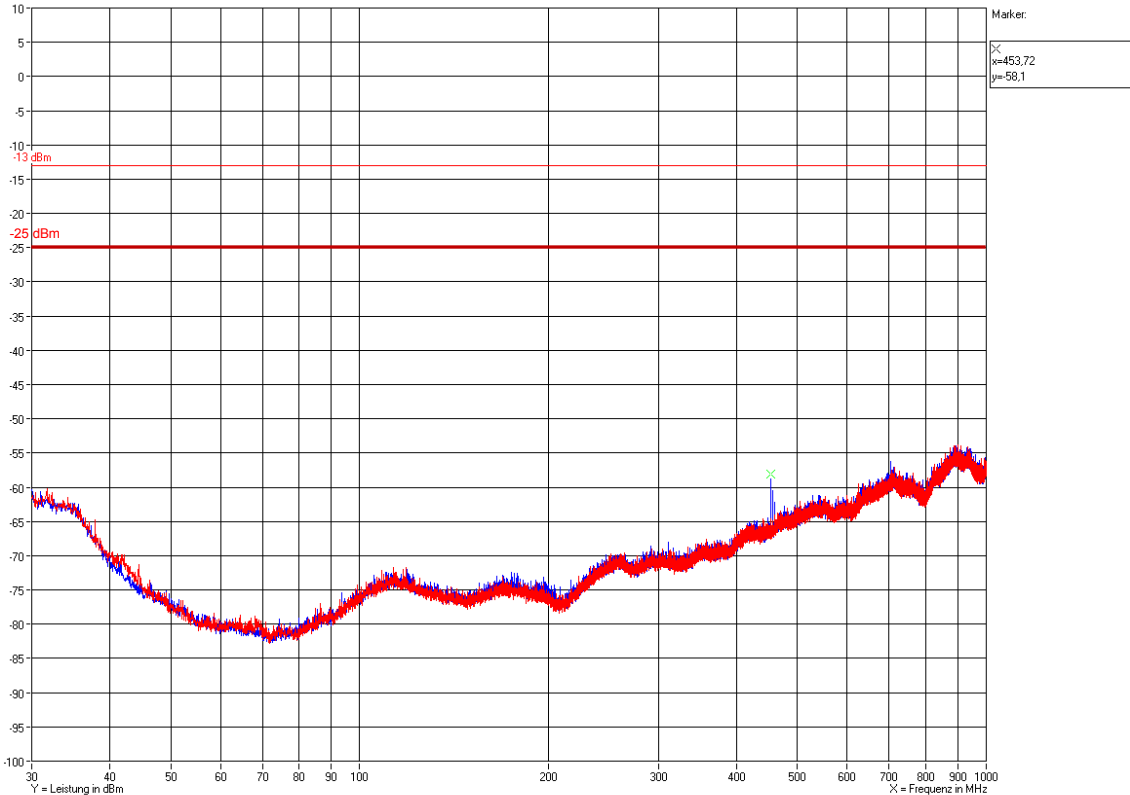



Band #3: 462.7375/465.1375/467.5375 MHz

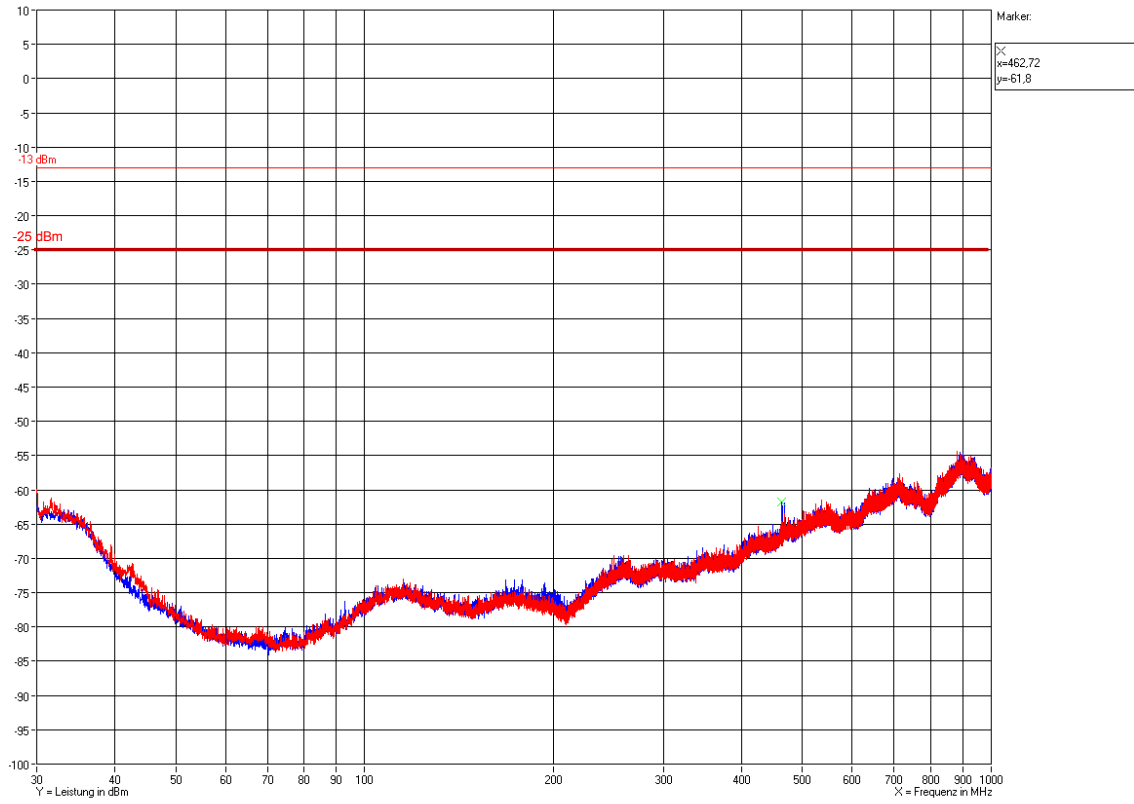



Band #4: 467.7375/489.86875/512 MHz





10.4.1.2 30 MHz to 1 GHz Downlink (Middle of all bands)

430,05/ 459,26875/ 465,1375/ 489,86875 MHz

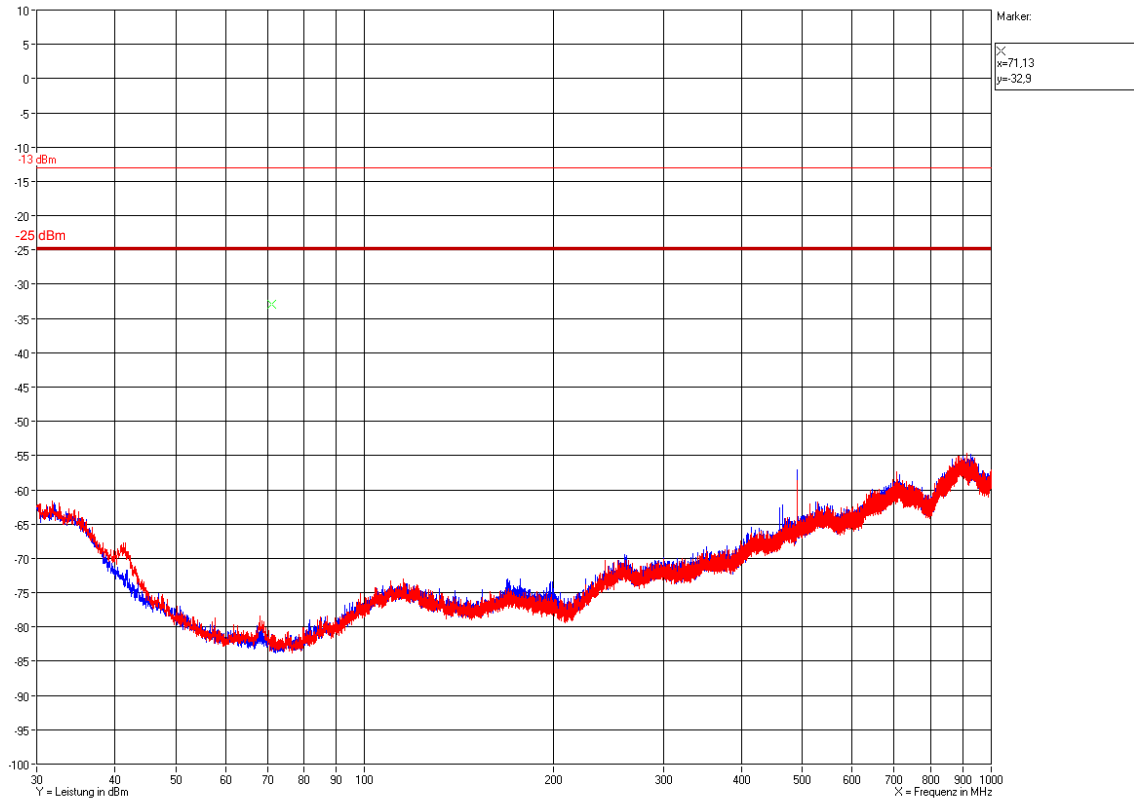

Test Report No.: 14-196

FCC ID: XS5-TFAHES7850



**BUREAU  
VERITAS**

### 10.4.1.3 1 GHz to 21 GHz Downlink (Bottom – Middle – Top)

**Vertikal / Horizontal** RBW = 120kHz

**Band #1:** 406.1/430.5/454 MHz

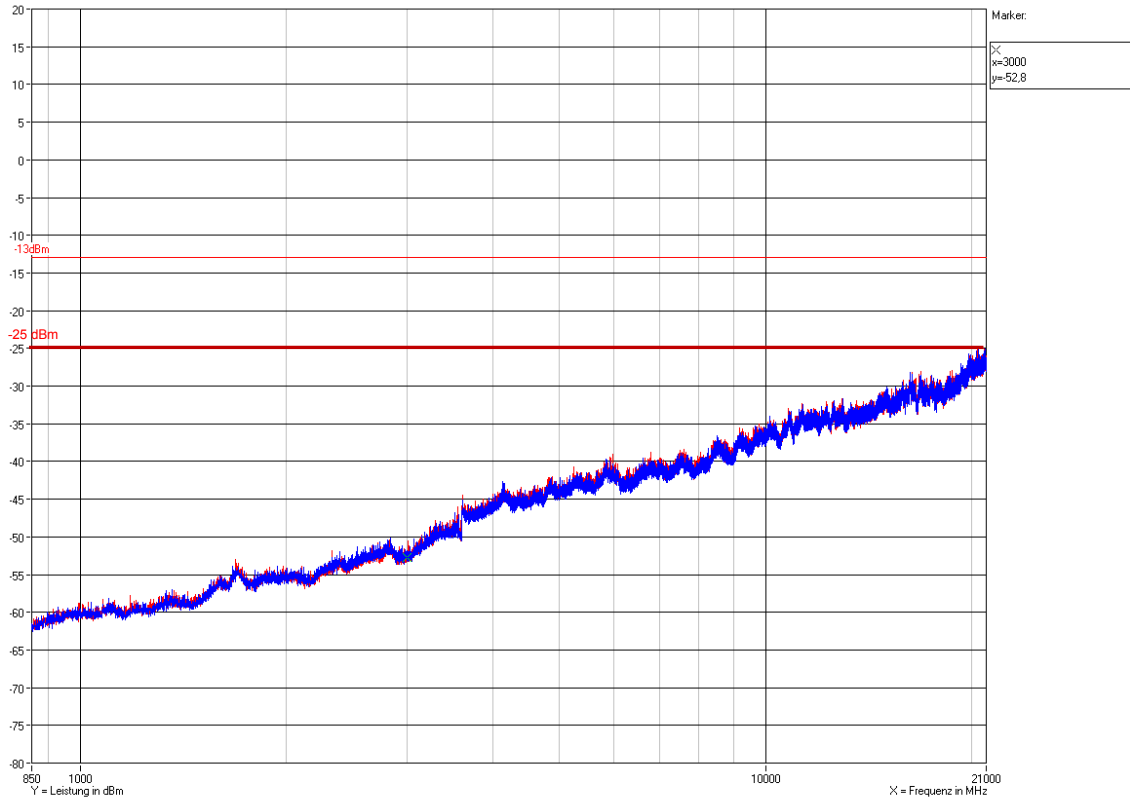



Band #2: 456,1/459,26875/462,5375 MHz

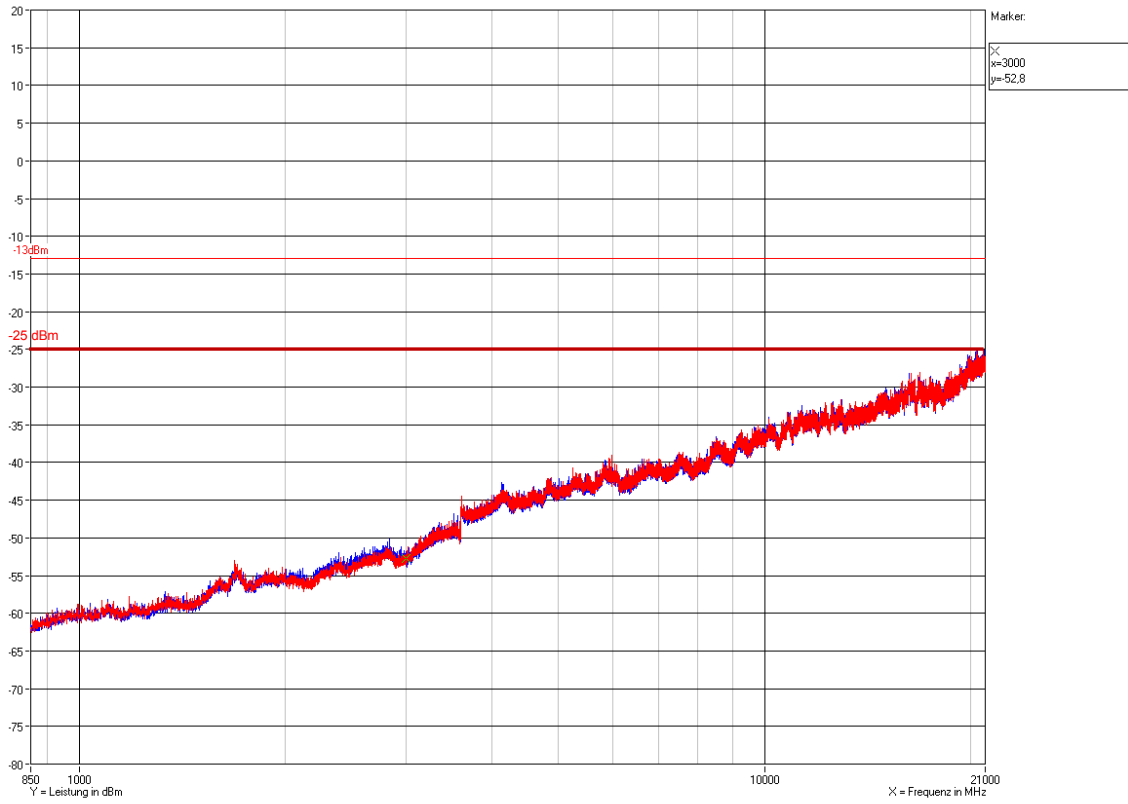





Band #3: 462,7375/465,1375/467,5375 MHz

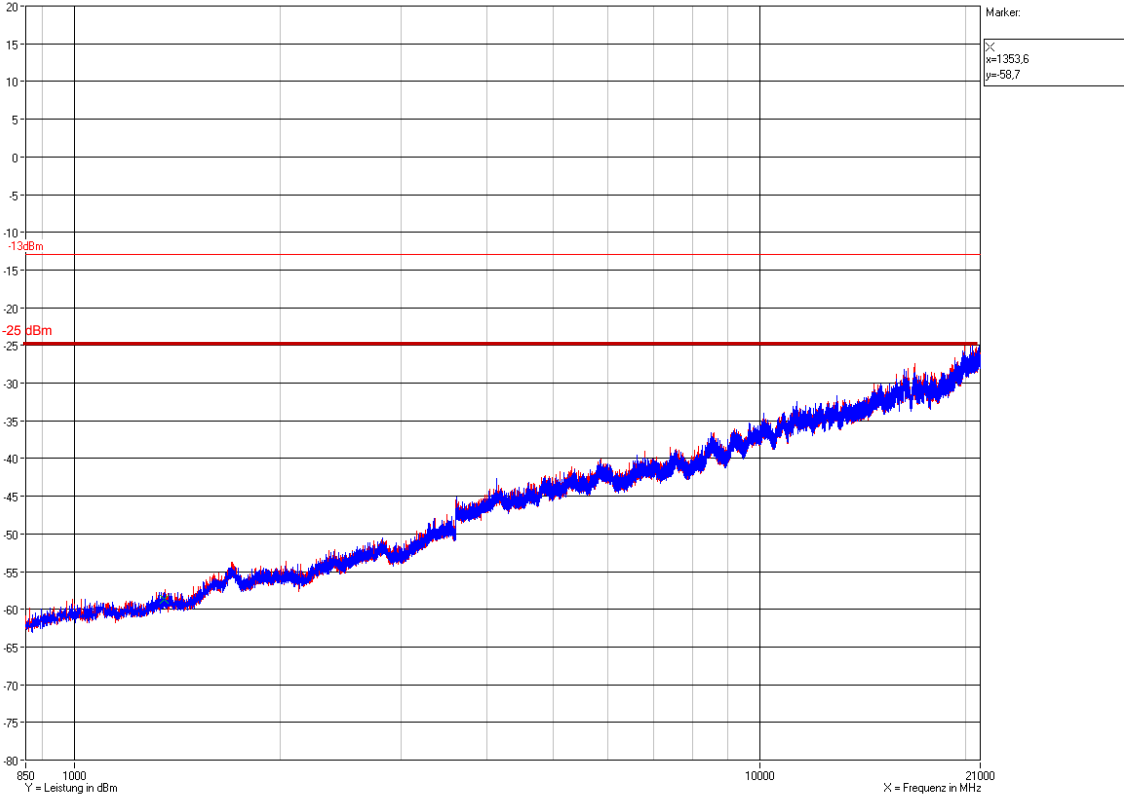

Test Report No.: 14-196

FCC ID: XS5-TFAHES7850



BUREAU  
VERITAS

Band #4: 467.7375/489.86875/512 MHz

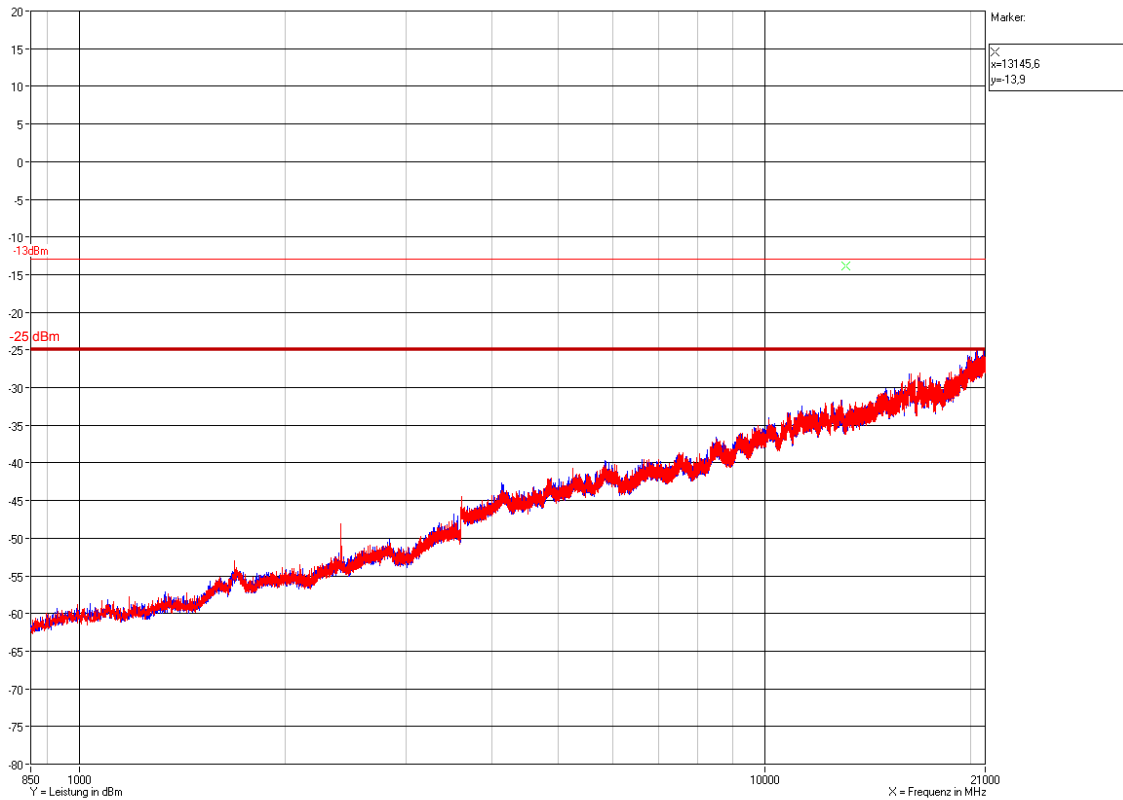



10.4.1.4 30 MHz to 1 GHz Downlink (Middle of all bands)

430,05/ 459,26875/ 465,1375/ 489,86875 MHz

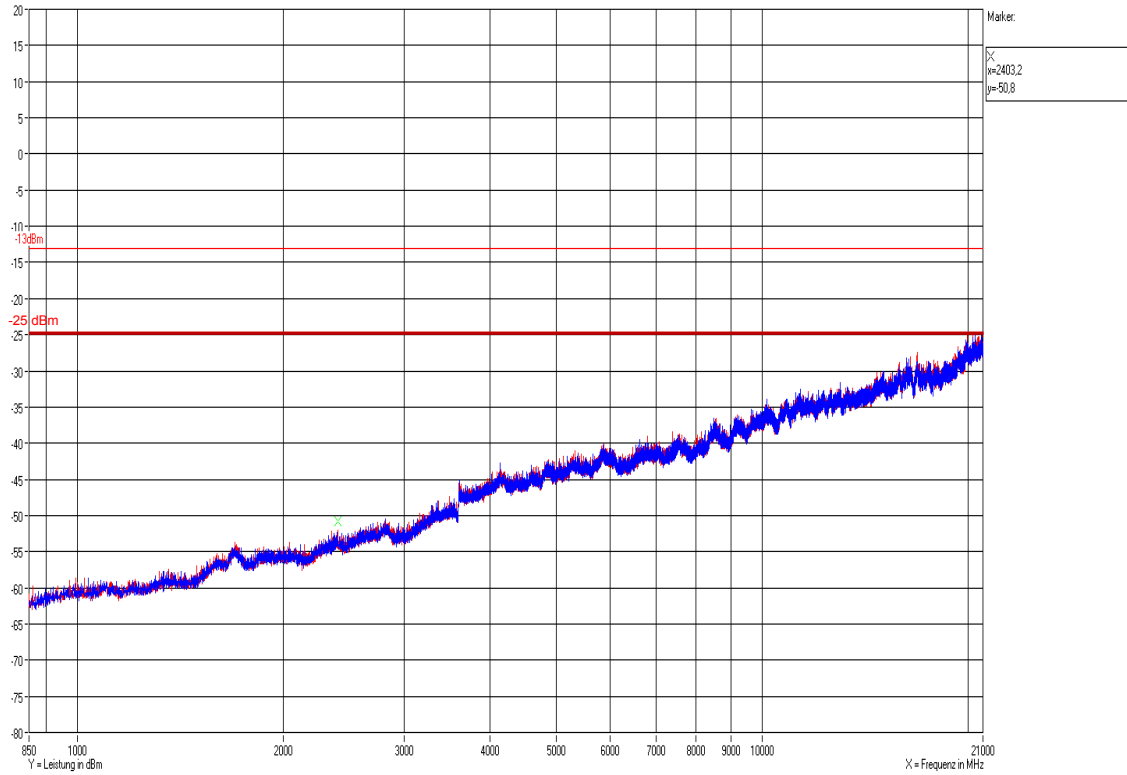

**The radiated spurious emission measurements have been passed!**



## 11 History

Revision	Modification	Date	Name
01.00	Initial report	11.09.2014	Zahlmann

**\*\*\*\*\* End of test report \*\*\*\*\***