

CommScope ERA[®] CAP L2 with Fiber Interface

2nd Generation Low Power Carrier Access Point

Installation Guide • M0203A9B_uc • August 2022



DISCLAIMER

This document has been developed by CommScope, and is intended for the use of its customers and customer support personnel. The information in this document is subject to change without notice. While every effort has been made to eliminate errors, CommScope disclaims liability for any difficulties arising from the interpretation of the information contained herein. The information contained herein does not claim to cover all details or variations in equipment, nor to provide for every possible incident to be met in connection with installation, operation, or maintenance. This document describes the performance of the product under the defined operational conditions and does not cover the performance under adverse or disturbed conditions. Should further information be desired, or should particular problems arise which are not covered sufficiently for the purchaser's purposes, contact CommScope.

CommScope reserves the right to change all hardware and software characteristics without notice.

ERA[®] and ION-E[®]

ERA is an extension of the hardware and software architecture that CommScope originally introduced as ION-E. Going forward, all new systems are ERA. Since ION-E and ERA share the same hardware modules, system software and management systems, existing ION-E systems can be updated and expanded using ERA components.

COPYRIGHT

© 2022 CommScope, Inc. All Rights Reserved.

This document is protected by copyright. No part of this document may be reproduced, stored in a retrieval system, or transmitted, in any form or by any means, electronic, mechanical photocopying, recording, or otherwise without the prior written permission of CommScope.

For patents see www.cs-pat.com.

TRADEMARKS

All trademarks identified by ® or ™ are registered trademarks or trademarks, respectively, of CommScope, Inc. Names of other products mentioned herein are used for identification purposes only and may be trademarks and/or registered trademarks of their respective companies.

Andrew Wireless Systems GmbH, August 2022

TABLE OF CONTENTS

Document Overview	1
Document Revision History	1
Document Cautions and Notes	1
Abbreviations Used in this Guide	3
Safely Working with ERA Hardware	3
Health and Safety Precautions	3
Property Damage Warnings	4
General Installation Safety Requirements	4
Guard Against Damage from Electro-Static Discharge	4
Compliance	5
Equipment Symbols Used / Compliance	7
Maximum Output Power Levels	8
Required Antenna Distances	8
Fiber CAP L2 Overview	9
Connectors and LED for the Fiber CAP L2	9
CAP L2 Accessories and Options	11
Mounting and Power Kits	11
SFP+ Module Kits	11
OCTIS™ Universal Lever Assembly Kits	13
OCTIS Universal Lever Assembly Instructions	13
Plan and Prepare for a Fiber CAP L2 Installation	15
Maximum Number of Fiber CAP L2s Supported in an ERA System	15
Determine the Power Consumption of the CAP L2	16
Determine the CAP L2 Installation Site	16
CAP L2 Dimensions	17
CAP L2 Weights	17
Recommended Tools and Material	18
Unpack and Inspect the CAP L2 and Optional Accessories	18
Obtain the Required Materials	18
Mount the Fiber CAP L2	19
General Mounting Cautions	19
Wall Mount a CAP L2	20
Mounting Orientation for Wall Mounts	20
Mounting CAP L2 with a Wall Mounting Kit	21
Mounting a CAP L2 with an AC/DC Power Supply Kit	24
Wiring the AC/DC Power Supply Kit	25
Mounting a CAP L2 with a Hybrid Fiber Splice Box Kit (optional)	28
Prepare for CAP L2 Hybrid Fiber Splice Box Kit Installation	28
Assembling and Wiring the Hybrid Fiber Splice Box	29
Wire the Hybrid Fiber Splice Box	29
Wire a Hybrid Fiber Splice Box for 4-Wire Power with Limited Power Source	33
Wire a Hybrid Fiber Splice Box for 2-Wire Power without Limited Power Source	34
Wall Mount a CAP L2 Using a CAP L2 Hybrid Fiber Splice Box Kit (optional)	35
Connect the Cables to the Fiber CAP L2	36
Ground the Fiber CAP L2 (Optional)	36
Connect the Fiber CAP L2 to a Passive RF Antenna	37
Clean the RF Cable Connectors	38
Connect the Passive RF Antenna	40
Connect the Optical Fiber	41
Installing SFP+ Modules in the CAP L2 (optional)	42
Connect the Fiber CAP L2 to a Classic CAN or TEN	44
Connect to Vdc Power	45
Powering on a Fiber CAP L2	45
Contacting CommScope	46
CMS Global Technical Support	46
Telephone Helplines	46
Online Support	46
Waste Electrical and Electronic Equipment Recycling	46
Hardware to Software Mapping Information	47
Mobility Solutions Technical Training	47

Accessing ERA Series User Documentation 47

DOCUMENT OVERVIEW

CAP L2 variants are available with either a copper entry module or fiber entry module. The "C" in the variant name (after the band numbers) indicates a copper entry module and an "F" indicates a fiber entry module. The copper entry module supports up to two 10GBase-T (CAT6A) interfaces and the fiber entry module supports up to two 10G/25G SFP+ optical fiber interfaces. This guide provides a product overview and installation instructions for the fiber CAP L2 APs.

Table 1 lists the supported CAP L2 variants.

Table 1. Supported CAP L2 Fiber Models

Part Number	Model Name
7845390-1001	CAP L2 18/21/23T/26 F-DC
7845390-1003	CAP L2 35LT/35HT F-DC
7845390-1006	CAP L2 7-8/18/21/26 F-DC
7845390-1007	CAP L2 17E/19/23/25T F-DC
7845390-1008	CAP L2 6/7E/80-85 F-DC
7845390-1009	CAP L2 9/18/21/26 F-DC
7845390-1013	CAP L2 7-8/9/18/21 F-DC
7845390-1018	CAP L2 C-Band F-DC
7845390-1019	CAP L 2 9/21/35HT F-DC
F in name (after the bands) stands for Fiber	



For information on how to find the minimum software requirements for ERA hardware, refer to ["Hardware to Software Mapping Information" on page 47](#).

Document Revision History

This is the second release of the *CommScope ERA™ CAP L2 Second Generation Fiber Low Power Carrier Access Point Installation Guide*. This release:

- adds the CAP L2 35LT/35HT and CAP L2 C-band models to [Table 1 on page 1](#) and [Table 3 on page 8](#)
- adds representative information to [Step 4 on page 5](#)
- adds Radio Module information to [Table 3 on page 8](#)
- adds ["Required Antenna Distances" on page 8](#)
- adds 4 antenna information in [Figure 2 on page 10](#) and [Figure 6 on page 10](#)
- adds Fiber/Cable Protective Kit row to [Table 9 on page 13](#)

Document Cautions and Notes

This document may contain any of the following notes, cautions, and warning icons.



The icon to the left is used to indicate a caution or warning. Cautions and warnings indicate operations or steps that could cause personal injury, induce a safety problem in a managed device, destroy or corrupt information, or interrupt or stop services.



The icon to the left indicates a caution or warning that pertains to laser equipment.



The icon to the left indicates a caution or warning that pertains to Radio Frequency (RF).



The icon to the left indicates that the hardware is susceptible to Electro-Static Discharge (ESD) damage.



The icon to the left indicates a caution or warning that pertains to an electrical hazard.



The icon to the left indicates a Note. Notes provide information about special circumstances.

Abbreviations Used in this Guide

AP	Access Point	EFTA	European Free Trade Association
AUX	Auxiliary	ISDE	Innovation, Sciences et Développement économique Canada
C	Celsius	ISED	Innovation, Science and Economic Development Canada
CAN	Central Area Node	kg	Kilogram
CAP L	Low Power Carrier Access Point	LED	Light Emitting Diode
CAP L2	Low Power Carrier Access Point, Second Generation	LPS	Limited Power Source
CAP M	Medium Power Carrier Access Point	MHz	Megahertz
Cat	Category	mm	Millimeter
CAT	Copper Transport	MMF	Multi-Mode Fiber
dB	Decibel	N/A	Not Applicable
dBm	Decibel-milliwatts	OPT	Optical Transport
DC	Direct Current	PN	Part Number
DCCS	Distributed Coverage and Capacity Solutions	RAN	Regional-Area Network
RF	Radio Frequency	ION	Intelligent Optical Network
EMC	Electromagnetic Compatibility	RU	Rack Unit
EMEA	Europe, Middle East, Africa	SFP	Small Form-Factor Pluggable
EU	European Union	SMF	Single-Mode Fiber
F	Fahrenheit	TEN	Transport Expansion Node
FCC	Federal Communications Commission	UAP	Universal Access Point
Gb	Gigabyte	Vdc	Volts, direct current
GHz	Gigahertz	W	Watts

Safely Working with ERA Hardware

The following sections provide important information that you should read and know before working with any ERA hardware. Observe all cautions and warnings listed in this section.

Health and Safety Precautions



A high leakage current ground (earth) connection to the Power Supply Unit (PSU) is essential before making any other connections to the PSU.



Laser radiation. Risk of eye injury in operation. Do not stare into the laser beam; do not view the laser beam directly or with optical instruments.



High frequency radiation in operation. Risk of health hazards associated with radiation from the antenna(s) connected to the unit. Implement prevention measures to avoid the possibility of close proximity to the antenna(s) while in operation.



If the CAP L2 power connector is not easily accessible, a disconnect device in the mains power circuit must be provided within easy reach.

Property Damage Warnings



Keep operating instructions within easy reach and make them available to all users.



Only license holders for the respective frequency range are allowed to operate this unit.



Read and obey all the warning labels attached to the unit. Make sure that all warning labels are kept in a legible condition. Replace any missing or damaged labels.



Make sure the unit's settings are correct for the intended use (refer to the manufacturer product information) and regulatory requirements are met. Do not carry out any modifications or fit any spare parts, which are not sold or recommended by the manufacturer.

General Installation Safety Requirements



Wet conditions increase the potential for receiving an electrical shock when installing or using electrically powered equipment. To prevent electrical shock, never install or use electrical equipment in a wet location or during a lightning storm.



This system is a RF Transmitter and continuously emits RF energy. Maintain a minimum clearance from the antenna while the system is operating. Whenever possible, power down the CAP L2 before servicing the antenna.



Do not remove caps from any of the connectors until instructed to do so.



The CAP L2 is to be used only with CommScope (NEC Class 2) or Limited Power Source ERA Subrack, or equivalent.

Guard Against Damage from Electro-Static Discharge



Electro-Static Discharge (ESD) can damage electronic components. To prevent ESD damage, always wear an ESD wrist strap when working with ERA hardware components. Not all ERA hardware requires grounding. For those ERA hardware components for which grounding is required, connect the ground wire on the ESD wrist strap to an earth ground source before touching the ERA component. Wear the wrist strap the entire time that you work with the ERA hardware.

Compliance

- 1 Notice:** For installations, which have to comply with FCC RF exposure requirements, the antenna selection and installation must be completed in a way to ensure compliance with those FCC requirements. Depending on the RF frequency, rated output power, antenna gain, and the loss between the repeater and antenna, the minimum distance D to be maintained between the antenna location and human beings is calculated according to this formula:

$$D_{[cm]} = \sqrt{\frac{P_{[mW]}}{4 * \pi * PD_{[mW/cm^2]}}}$$

where

- P (mW) is the radiated power at the antenna, i.e. the max. rated repeater output power in addition to the antenna gain minus the loss between the repeater and the antenna.
- PD (mW/cm²) is the allowed Power Density limit acc. to 47 CFR 1.1310 (B) for general population / uncontrolled exposures which is
 - f (MHz) / 1500 for frequencies from 300MHz to 1500MHz
 - 1 for frequencies from 1500MHz to 100,000MHz

RF exposure compliance may need to be addressed at the time of licensing, as required by the responsible FCC Bureau(s), including antenna co-location requirements of 1.1307(b)(3).

- 2 Notice:** For installations which have to comply with European EN50385 exposure compliance requirements, the following Power Density limits/guidelines (mW/cm²) according to ICNIRP are valid:
 - 0.2 for frequencies from 10 MHz to 400 MHz
 - F (MHz) / 2000 for frequencies from 400 MHz to 2 GHz
 - 1 for frequencies from 2 GHz to 300 GHz
- 3 Notice:** Installation of this equipment is in full responsibility of the installer, who has also the responsibility, that cables and couplers are calculated into the maximum gain of the antennas, so that this value, which is filed in the FCC Grant and can be requested from the FCC data base, is not exceeded. The industrial boosters are shipped only as a naked booster without any installation devices or antennas as it needs for professional installation.
- 4 Notice:** For installations which have to comply with FCC/ISED requirements:

English:

This device complies with FCC Part 15. Operation is subject to the following two conditions: (1) this device may not cause interference, and (2) this device must accept any interference, including interference that may cause undesired operation of the device.

This device complies with Health Canada's Safety Code. The installer of this device should ensure that RF radiation is not emitted in excess of the Health Canada's requirement. Information can be obtained at http://www.hc-sc.gc.ca/ewh-semt/pubs/radiation/radio_guide-lignes_direct-eng.php.

Changes or modifications not expressly approved by the party responsible for compliance could void the user's authority to operate the equipment.

Antenna Stmt for ISED:

This device has been designated to operate with the antennas having a maximum gain of 9 dBi. Antennas having a gain greater than 9 dBi are prohibited for use with this device without consent by ISED regulators. The required antenna impedance is 50 ohms.

The antenna(s) used for this transmitter must be installed to provide a minimum separation distance from all persons and must not be co-located or operating in conjunction with any other antenna or

transmitter. Users and installers must be provided with antenna installation instructions and transmitter operating conditions for satisfying RF exposure compliance.

French:

Cet appareil est conforme avec Santé Canada Code de sécurité 6. Le programme d'installation de cet appareil doit s'assurer que les rayonnements RF n'est pas émis au-delà de l'exigence de Santé Canada. Les informations peuvent être obtenues:

http://www.hc-sc.gc.ca/ewh-semtpubs/radiation/radio_guide-lignes_direct-eng.php

Les changements ou modifications non expressément approuvés par la partie responsable de la conformité pourraient annuler l'autorité de l'utilisateur à utiliser cet équipement.

Antenne Stmt pour ISDE:

Ce dispositif a été désigné pour fonctionner avec les antennes ayant un gain maximal de 9 dBi. Antennes ayant un gain plus grand que 9 dBi sont interdites pour une utilisation avec cet appareil sans le consentement des organismes de réglementation d'ISDE. L'impédance d'antenne requise est 50 ohms.

L'antenne (s) utilisé pour cet émetteur doit être installé pour fournir une distance de séparation minimale par rapport à toute personnes et ne doit pas être co-localisées ou opérant en conjonction avec une autre antenne ou émetteur. Les utilisateurs et les installateurs doivent être fournis avec des instructions d'installation de l'antenne et des conditions de fonctionnement de l'émetteur pour satisfaire la conformité aux expositions RF.

Canadian Representative

ISED Company No : 3874A

Company Name: Celltech Labs Inc.

Address: 21-364 Loughheed Road
Kelowna, BC V1X 7R8

Contact Name: Ben Hewson

Telephone No: (250) 765-7650 x201

Email: IC-Rep@celltechlabs.com

- 5 **Notice:** The unit complies with Overvoltage Category II. It also complies with the surge requirement according to EN 61000-4-5 (fine protection); however, installation of an additional medium (via local supply connection) and/or coarse protection (external surge protection) is recommended depending on the individual application in order to avoid damage caused by overcurrent.

For Canada and US, components used to reduce the Overvoltage Category shall comply with the requirements of IEC 61643-series. As an alternative, components used to reduce the Overvoltage Category may comply with ANSI/IEEE C62.11, CSA Certification Notice No. 516, CSA C22.2 No. 1, or UL 1449. Suitability of the component for the application shall be determined for the intended installation.

- 6 **Notice:** Corresponding local particularities and regulations must be observed. For national deviations, please refer to the respective documents, which are available from CommScope.

- 7 **Note:** For a Class B digital device or peripheral:

This equipment has been tested and found to comply with the limits for a Class B digital device, pursuant to part 15 of the FCC Rules. These limits are designed to provide reasonable protection against harmful interference in a residential installation. This equipment generates, uses and can radiate radio frequency energy and, if not installed and used in accordance with the instructions, may cause harmful interference to radio communications. However, there is no guarantee that interference will not occur in a particular installation. If this equipment does cause harmful interference to radio or television reception, which can be determined by turning the equipment off and on, the user is encouraged to try to correct the interference by one or more of the following measures:

- Reorient or relocate the receiving antenna.
- Increase the separation between the equipment and receiver.
- Connect the equipment into an outlet on a circuit different from that to which the receiver is connected.
- Consult the dealer or an experienced RF technician for help.

8 Notice: For a Class A digital device or peripheral.

This equipment has been tested and found to comply with the limits for a Class A digital device, pursuant to Part 15 of the FCC Rules. These limits are designed to provide reasonable protection against harmful interference when the equipment is operated in a commercial environment. This equipment generates, uses, and can radiate radio frequency energy and, if not installed and used in accordance with the instruction manual, may cause harmful interference to radio communications. Operation of this equipment in a residential area is likely to cause harmful interference in which case the user will be required to correct the interference at his own expense.

9 Note: This unit complies with European standard EN62368-1.

Equipment Symbols Used / Compliance

Please observe the meanings of the following symbols used in our equipment and the compliance warnings listed in [Table 2](#).

Table 2. Compliance Labels

Symbol	Compliance	Meaning
—	FCC	For industrial (Part 20) signal booster: WARNING: This is NOT a CONSUMER device. It is designed for installation by FCC LICENSEES and QUALIFIED INSTALLERS. You MUST have an FCC LICENSE or express consent of an FCC Licensee to operate this device. Unauthorized use may result in significant forfeiture penalties, including penalties in excess of \$100,000 for each continuing violation.
		For (Part 90) signal booster: WARNING: This is NOT a CONSUMER device. It is designed for installation by FCC LICENSEES and QUALIFIED INSTALLERS. You MUST have an FCC LICENSE or express consent of an FCC Licensee to operate this device. You MUST register Class B signal boosters (as defined in 47 CFR 90.219) online at www.fcc.gov/signal-boosters/registration . Unauthorized use may result in significant forfeiture penalties, including penalties in excess of \$100,000 for each continuing violation.
—	ISED	WARNING: This is NOT a CONSUMER device. It is designed for installation by an installer approved by an ISED licensee. You MUST have an ISED LICENCE or the express consent of an ISED licensee to operate this device. AVERTISSEMENT: Ce produit N'EST PAS un appareil de CONSOMMATION. Il est conçu pour être installé par un installateur approuvé par un titulaire de licence d'ISDE. Pour utiliser cet appareil, vous DEVEZ détenir une LICENCE d'ISDE ou avoir obtenu le consentement exprès d'un titulaire de licence autorisé par ISDE.
CE	CE	To be sold exclusively to mobile operators or authorized installers - no harmonized frequency bands, operation requires license. Intended use: EU and EFTA countries.
		Indicates conformity with the RED directive 2014/53/EU and/or RoHS directive 2011/65/EU.

Maximum Output Power Levels

Table 3 lists the frequencies and maximum power output for bands supported in the CAP L2 variants.

Table 3. Maximum Power Output by Frequency

Band	Radio Module Number	DL Frequency Range	Power Output [dBm]
6	Radio Module L2 B71	619.5 - 649.5 MHz	19
7E	Radio Module L2 B12 +13+14	731.5 - 753.5	19
		748.5 - 753.5 MHz	
		760.5 - 765.5 MHz	
7-8	N/A	758 – 791 MHz 791 – 821 MHz	19
9	N/A	925 - 960 MHz	19
17E	Radio Module L2 B66	2112.5 – 2172.5 MHz	21
18	N/A	1805 - 1880 MHz	21
19	Radio Module L2 B25	1932.5 - 1992.5 MHz	21
21	N/A	2110 - 2170 MHz	21
23	Radio Module L2 B30	2352.5 - 2357.5 MHz	19
23T	N/A	2350 - 2390 MHz	21
25T	Radio Module L2 B41	2498.5 - 2687.5 MHz	21
26	N/A	2620 - 2690 MHz	21
80-85	Radio Module L2 B5+27	864.5 - 866.5 MHz	19
		871.5 - 891.5 MHz	
35LT	N/A	3410 – 3640 MHz	23
35HT	N/A	3570 – 3800 MHz	23
C-Band	N/A	3700 – 3980 MHz	23
NOTE: The output power of the internal Radio Module is 3 dB higher than the ANT Port due to combiner.			

Required Antenna Distances

Table 4. Required Antenna Distances

CAP L2 Model	Antenna Gain without Cable Loss [dBi]	Minimum Distance Between Antennas and All Persons (DL)			
		FCC		ISED	
		Meters	Inches	Meters	Inches
CAP L2 6E/7E/80-85	9	0.20	7.88	0.24	9.45
CAP L2 17E/19/23/25T	9	0.20	7.88	0.20	7.88
CAP L2 C-Band	9	0.22	8.84	0.26	10.43
NOTE: The Maximum Antenna Gain calculation considers the Radio Module in CAP L2 system is without loss, except for the internal combiner.					

FIBER CAP L2 OVERVIEW

This installation guide describes the Fiber CAP L2, which interfaces with a Classic CAN or TEN via an optical link. This allows the Fiber CAP L2 to provide data over Single-Mode Fiber (SMF) or Multi-Mode Fiber (MMF). Power for Fiber CAP L2s is provided over External AC/DC or remotely through hybrid fiber.

On the downlink, the Fiber CAP L2 converts data arriving at the CAP L2 to analog signals and sends them to the Antenna ports. On the uplink, received signals are digitized and serialized into data streams, which are sent back to the Classic CAN or TEN.

The Fiber CAP L2 is designed for indoor and outdoor use. It is passively cooled with a temperature range of: -33°C to +50°C (-27.4°F to +122°F); see also "[Recommended Tools and Material](#)" on page 18. The CAP L2 has a typical power consumption that, depending on the model, ranges from 80W to 150W.

Connectors and LED for the Fiber CAP L2

Figure 1 and Table 5 identify the Fiber CAP L2 connectors and its LED; corresponding connectors are shown.

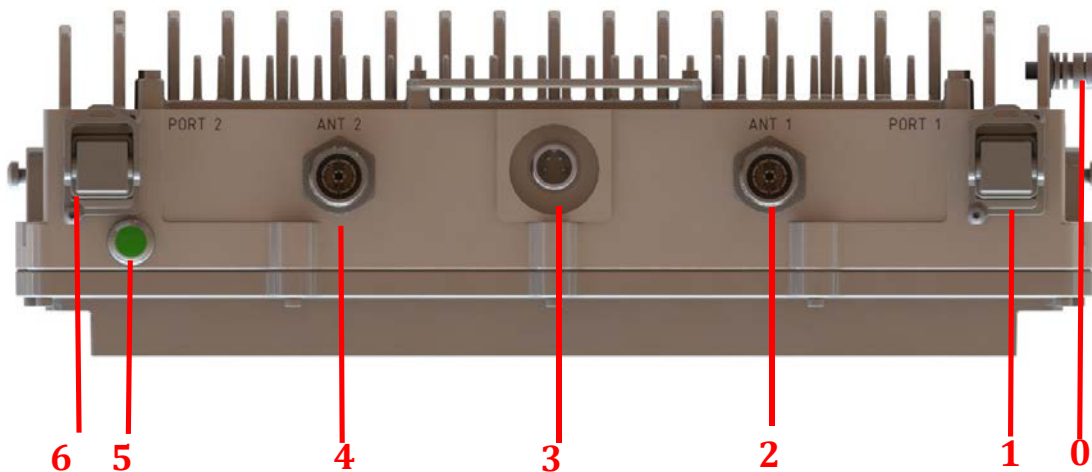

Figure 1. CAP L2 Connectors and LED (2 antennas)

Table 5. Function of the CAP L2 Connectors and LED (2 antennas)

Ref #	Label	Description	Function
0	None	Grounding Bolt	Connects the CAP MX to an approved earth-ground source.
1	Port 1	Port 2 OCTIS Connector	Port to pass fiber cable to the SFP+ module. The port seal is the OCTIS Universal connector PN 7847069. Connecting the fiber cable to the CAP L2 requires removing the service lid.
2	ANT 1	4.3-10 RF connector	Connect to external antennas or to one of the ports on a multiple input cross-polarized antenna via 50Ω coaxial cable. The antenna ports ship with dust caps that can be discarded upon unit installation.

Table 5. Function of the CAP L2 Connectors and LED (2 antennas) (Continued)

Ref #	Label	Description	Function
3	None	Proprietary 4-pin DC power connector	Connects to a local or remote DC power supply. The CAP L2 does not ship with any power cables preinstalled; you need to order the power cable assembly that is appropriate for this installation. <ul style="list-style-type: none"> • 7774061: Cable Assembly, CAP L Local Power Jumper, 0.5 m • 7816237-xx: Cable Assembly, CAP L Local Power Jumper, 3.0 m
4	ANT 2	4.3-10 RF connector	Connect to external antennas or to one of the ports on a multiple input cross-polarized antenna via 50Ω coaxial cable. The antenna ports ship with dust caps that can be discarded upon unit installation.
5	None	Power and Status LED	See "Connectors and LED for the Fiber CAP L2" on page 9
6	Port 2	Port 2 OCTIS Connector	Port to pass fiber cable to the SFP+ module. The port seal is the OCTIS Universal connector PN 7847069. Connecting the fiber cable to the CAP L2 requires removing the service lid.

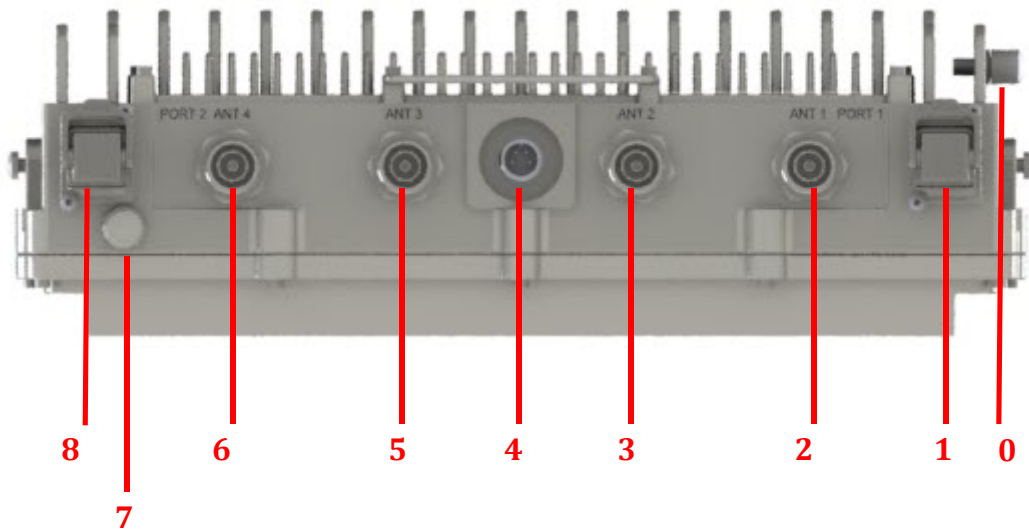

Figure 2. CAP L2 Connectors and LED (4 antennas)

Table 6. Function of the CAP L2 Connectors and LED (4 antennas)

Ref #	Label	Description	Function
0	None	Grounding Bolt	Connects the CAP MX to an approved earth-ground source.
1	Port 1	Port 2 OCTIS Connector	Port to pass fiber cable to the SFP+ module. The port seal is the OCTIS Universal connector PN 7847069. Connecting the fiber cable to the CAP L2 requires removing the service lid.
2	ANT 1	4.3-10 RF connector	Connect to external antennas or to one of the ports on a multiple input cross-polarized antenna via 50Ω coaxial cable. The antenna ports ship with dust caps that can be discarded upon unit installation.
3	ANT 2	4.3-10 RF connector	Connect to external antennas or to one of the ports on a multiple input cross-polarized antenna via 50Ω coaxial cable. The antenna ports ship with dust caps that can be discarded upon unit installation.

Table 6. Function of the CAP L2 Connectors and LED (4 antennas) (Continued)

Ref #	Label	Description	Function
4	None	Proprietary 4-pin DC power connector	Connects to a local or remote DC power supply. The CAP L2 does not ship with any power cables preinstalled; you need to order the power cable assembly that is appropriate for this installation. <ul style="list-style-type: none"> 7774061: Cable Assembly, CAP L Local Power Jumper, 0.5 m 7816237-xx: Cable Assembly, CAP L Local Power Jumper, 3.0 m
5	ANT 3	4.3-10 RF connector	Connect to external antennas or to one of the ports on a multiple input cross-polarized antenna via 50Ω coaxial cable. The antenna ports ship with dust caps that can be discarded upon unit installation.
6	ANT 4	4.3-10 RF connector	Connect to external antennas or to one of the ports on a multiple input cross-polarized antenna via 50Ω coaxial cable. The antenna ports ship with dust caps that can be discarded upon unit installation.
7	None	Power and Status LED	See "Connectors and LED for the Fiber CAP L2" on page 9
8	Port 2	Port 2 OCTIS Connector	Port to pass fiber cable to the SFP+ module. The port seal is the OCTIS Universal connector PN 7847069. Connecting the fiber cable to the CAP L2 requires removing the service lid.

CAP L2 Accessories and Options

The Fiber CAP L2 accessories and options are described in the following sections:

- ["Mounting and Power Kits" on page 11](#)
- ["SFP+ Module Kits" on page 11](#)
- ["OCTIS™ Universal Lever Assembly Kits" on page 13](#)

Mounting and Power Kits

CAP L2 Mounting and Power Kits are described in the applicable installation process

Table 7. Mounting and Power Kits

Mounting/Power Kit	CommScope PN	See
Wall Mounting Bracket Kit	7848842 (NAR) 7846281-01 (EMEA)	"Mounting CAP L2 with a Wall Mounting Kit" on page 21 NOTE: 7846281-01 is included with the CAP L2. 7848842 must be ordered separately.
Power Supply/Hybrid Fiber Mounting Kit	7774354-xx	"Mounting a CAP L2 with an AC/DC Power Supply Kit" on page 24
240W Local AC Power Supply Kit		
no AC Input Cord	7775087-xx	"Mounting a CAP L2 with an AC/DC Power Supply Kit" on page 24
with AC Input Cord	7809798-xx	
for Plenum Space	7809823-xx	

SFP+ Module Kits

Contact your local CommScope sales representative to obtain the following components, as required, for this installation.

- Per the installation plan, obtain either Single Mode Fiber (SMF) or Multi Mode Fiber (MMF) that is of sufficient length to reach from the CAP L2 to a Classic CAN or TEN.
- All CAP L2s ship with the required Optical OCTIS Kit (PN 7770612).

- Obtain SFP+ Module pairs (one placed in the TEN and paired with another in the Classic CAN) that are appropriate for this installation. [Table 8](#) identifies the available SFP+ Modules and the maximum range for each.

Table 8. Supported SFP+ Modules

CommScope PN	Description	Maximum Range
7660511	SFP+, 10GBase-SRR, Multi Mode	OM3 300m OM4 400m
7680813	SFP+, 10GBase-LR, Single Mode	10km
7803247	SFP+, 10GBase CWDM-270	40km
7803249	SFP+, 10GBase CWDM-290	40km
7803291	SFP+, 10GBase CWDM-310	40km
7803293	SFP+, 10GBase CWDM-330	40km
7803295	SFP+, 10GBase CWDM-350	40km
7803298	SFP+, 10GBase CWDM-370	40km
7803900	SFP+, 10GBase CWDM-390	40km
7803902	SFP+, 10GBase CWDM-410	40km
7803904	SFP+, 10GBase CWDM-430	40km
7803906	SFP+, 10GBase CWDM-450	40km
7801330	SFP+, 10GBase CWDM-470	40km
7801340	SFP+, 10GBase CWDM-490	40km
7801342	SFP+, 10GBase CWDM-510	40km
7801344	SFP+, 10GBase CWDM-530	40km
7801360	SFP+, 10GBase CWDM-550	40km
7801363	SFP+, 10GBase CWDM-570	40km
7801365	SFP+, 10GBase CWDM-590	40km
7801367	SFP+, 10GBase CWDM-610	40km
7832204	SFP+, 10G BIDI TX1270/RX1330	40km
7832206	SFP+, 10G BIDI TX1330/RX1270	40km

OCTIS™ Universal Lever Assembly Kits



OCTIS™ is a trademark of Radiall. The following connector drawings and instructions were provided by Radiall.



Scan the QR code to the right to watch the OCTIS SFP+ connector assembly video.

All CAP L2s include two OCTIS Universal Connector Kits (CommScope PN 7847069) for the interface to the Classic CAN or TEN that plugs into Port 1 and Port 2 on the CAP L2. CommScope provides the two OCTIS Kits for each CAP L2.

Table 9. CAP L2 OCTIS Kits

Kit Name	CommScope PN	Description
OCTIS Universal Connector Kit	7847069	This is the connector that you use to seal the fiber cable port. The OCTIS Universal Kit is provided with the CAP L2.
Fiber/Cable Protective Kit	7823597	Use to protect fibers or cables; is 2m (78.7") long. NOTE: An Optical or Ethernet OCTIS Kit is required and must be ordered separately.

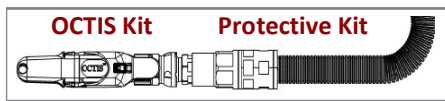

Figure 3 and Figure 4 show the LC Duplex connector. The single fiber assembly instructions are the same.

OCTIS Universal Lever Assembly Instructions



Octis™ is a trademark of Radiall. The following connector drawings and instructions were provided by Radiall.

The following instructions are for the OCTIS Universal Lever kit (CommScope PN: 7847069). For additional information, please contact Radiall.



Figure 3 and Figure 4 show the LC Duplex connector at the cable termination. The BiDi (single fiber) cable termination follows the same OCTIS assembly instructions.

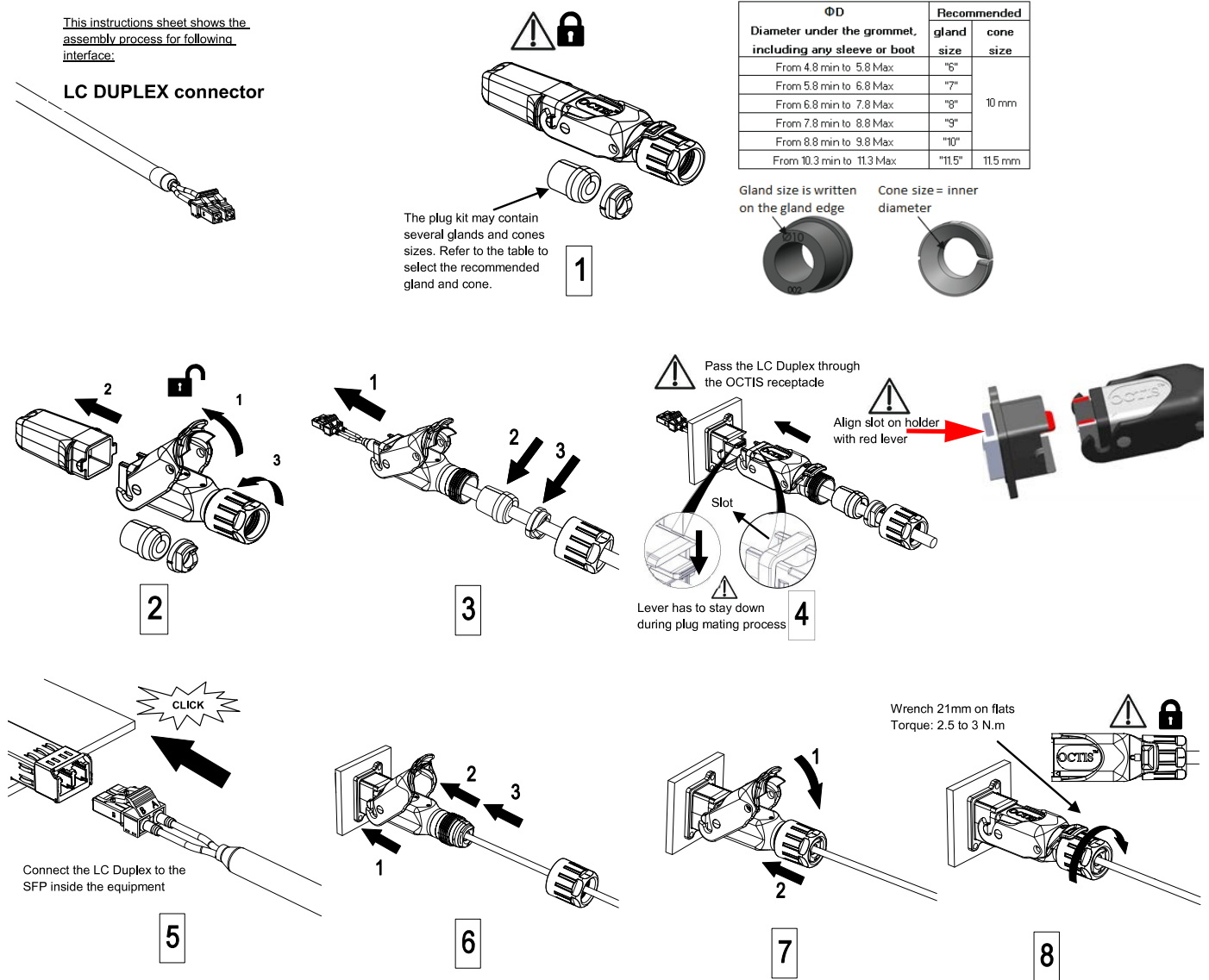

Figure 3. OCTIS Universal Lever Assembly Instructions

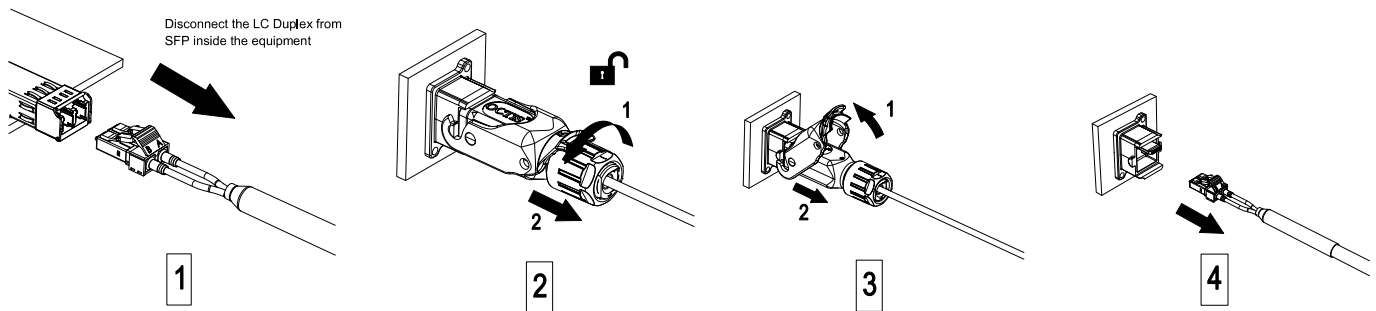

Figure 4. OCTIS Universal Lever Unmating Instructions

PLAN AND PREPARE FOR A FIBER CAP L2 INSTALLATION

Do the following before beginning installation.

- 1 Review and know the information in ["Maximum Number of Fiber CAP L2s Supported in an ERA System" on page 15.](#)
- 2 Review and know the information in ["Safely Working with ERA Hardware" on page 3.](#)
- 3 ["Determine the CAP L2 Installation Site" on page 16,](#) which includes understanding and meeting requirements for:
 - ["Recommended Tools and Material" on page 18](#)
 - ["CAP L2 Weights" on page 17](#)
 - ["Recommended Tools and Material" on page 18](#)
 - ["CAP L2 Dimensions" on page 17.](#)
- 4 Map out all cable runs.
- 5 Identify and obtain all tools and materials required to complete the installation as described in ["Recommended Tools and Material" on page 18.](#)
- 6 Obtain any accessories required for this installation; see ["CAP L2 Accessories and Options" on page 11.](#)
- 7 ["Unpack and Inspect the CAP L2 and Optional Accessories" on page 18.](#)

Maximum Number of Fiber CAP L2s Supported in an ERA System

When installing a Fiber CAP L2, you must observe the following rules.

- SMF or MMF connects the Fiber CAP L2 via its Optical Port to the OPT Card.

If the total used signal bandwidth is more than 320MHz a second fiber link is needed. It is connected to Optical Port 2.

- You connect CAP L2s to an OPT Card installed in Slots L1, L2, L3, or L4 in the TEN or Classic CAN.
 - Each OPT Card has four 10 Gbps ports (labeled 1 - 4) for fiber connections.

- Depending on the transmit bandwidth requirements, you can connect up to four CAP L2s to each OPT Card.



Fiber CAP L2s must be connected to OPT Cards installed in Slots L1, L2, L3, or L4 in a TEN or Classic CAN. OPT Cards installed in WCS Slots L5 - L8 cannot be used to connect APs.

Determine the Power Consumption of the CAP L2

Use the power consumption matrix in [Table 10](#) to calculate power consumption for a Fiber CAP L2, where

- the consumption numbers are at the CAP L2 power inputs and do not account for feed losses
- the maximum consumption numbers in [Table 10](#) do not include the power consumed by any attached auxiliary devices. Both CAP L2 power consumption and auxiliary device power must be included when calculating feed losses.

Table 10. CAP L2 Fiber Power Consumption

Configuration	Voltage Range (V)	Typical Power (W)	Maximum Power (W)
Fiber CAP L2 ¹	36 Vdc to 60 Vdc	125	150
1 Does not include consumption of optional local DC supply.			

Determine the CAP L2 Installation Site

When deciding on a suitable mounting site, observe the following rules; refer also to "[Mounting Orientation for Wall Mounts](#)" on page 20. The Fiber CAP L2 is suitable for indoor installation.

The following sections provides weight and dimension requirements needed to determine the best installation site for the Fiber CAP L2.

CAP L2 Dimensions

Use the dimensions shown in the section applicable to this installation to determine the space required at the mounting site.

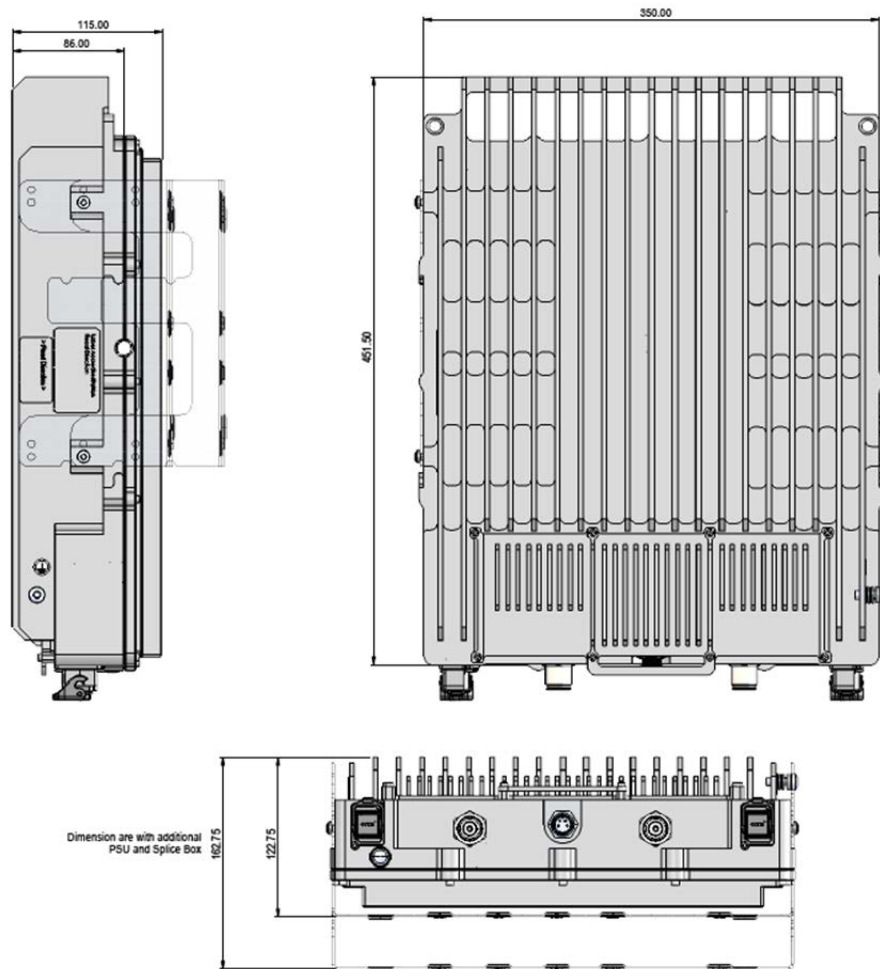

Figure 5. CAP L2 Mounting Dimensions

CAP L2 Weights

Use the weights listed in [Table 11](#) to determine a site that can bear the weight of the Fiber CAP L that is being installed, where:

- The “Maximum Lift Weight” is the highest weight that must be lifted during installation. (An installer only needs to lift CAP L2 components at one time, not the wholly configured CAP L2.)
- The “Total Hanging Weight” is the weight of the CAP L2, including the weight of the Mounting Bracket and Power Supply, minus the weight of the external cables and connectors, that the mounting site must be able to support.

Table 11. Maximum CAP L2 Installation Weights*

CAP L2 configured with this kit ...	Maximum Lift Weight		Total Hanging Weight	
	kg	lbs.	kg	lbs.
Single Mounting Bracket	15	33	16.8	37
AC/DC Power Supply Kit	TBD	TBD	TBD	TBD

Recommended Tools and Material

- Electrostatic Discharge (ESD) wrist strap
- Drill and bits to mount the CAP L2 bracket to a wall
- Fiber cleaning equipment

Unpack and Inspect the CAP L2 and Optional Accessories

- 1 Inspect the exterior of the shipping container(s) for evidence of rough handling that may have damaged the components in the container.
- 2 Unpack each container while carefully checking the contents for damage and verify with the packing slip.
- 3 If damage is found or parts are missing, file a claim with the commercial carrier and notify CommScope Technical Support (see ["CMS Global Technical Support" on page 46](#)). Save the damaged cartons for inspection by the carrier.
- 4 Save all shipping containers for use if the equipment requires shipment at a future date.

Obtain the Required Materials

Contact your local CommScope sales representative to obtain the following components, as required, for this installation.

- Obtain the cable required for this installation.
 - Per the installation plan, obtain either Single Mode Fiber (SMF) or Multi Mode Fiber (MMF) that is of sufficient length to reach from the CAP L2 to the Classic CAN or TEN.
 - Per the installation plan, obtain 50Ω coaxial cables that are of sufficient length to reach from the CAP L2 to the passive RF antenna. The end of the 50Ω coaxial cable that will connect to the ANT connector can be either a push-pull connector or a threaded connector.
- Obtain the Optical OCTIS Kits required for this installation; see ["OCTIS™ Universal Lever Assembly Kits" on page 13](#).
- Obtain SFP+ Module pairs that are appropriate for this installation; see [Table 8](#).
- Obtain the Mounting Kits for the installation. Mounting Kits are not included with the CAP L2 and must be ordered separately.

MOUNT THE FIBER CAP L2

A Fiber CAP L2 is suitable for indoor and outdoor installations.

Mounting instructions are divided into the sections listed below. Follow the mounting instructions that are applicable to this installation:

- "Wall Mount a CAP L2" on page 20
 - "Mounting Orientation for Wall Mounts" on page 20
 - "Mounting CAP L2 with a Wall Mounting Kit" on page 21
 - "Mounting a CAP L2 with an AC/DC Power Supply Kit" on page 24
 - "Mounting a CAP L2 with a Hybrid Fiber Splice Box Kit (optional)" on page 28

General Mounting Cautions

The following cautions apply to all Fiber CAP L2 installations; there may be other mounting cautions applicable to a specific mounting option, which will be defined in the applicable mounting procedure.



Attach all CAP L2 securely to a stationary object as described in this installation guide.



To maintain proper ventilation, keep at least 76 mm (3-inch) clearance around the CAP L2.



The installation site must be able to bear the weight of the CAP L2; see [Table 11 on page 18](#).

Wall Mount a CAP L2

The following sections provide the installation methodology and steps required to mount a Fiber CAP L2 to a wall.

Mounting Orientation for Wall Mounts

When wall mounting a Fiber CAP L2, the recommendations should be observed.

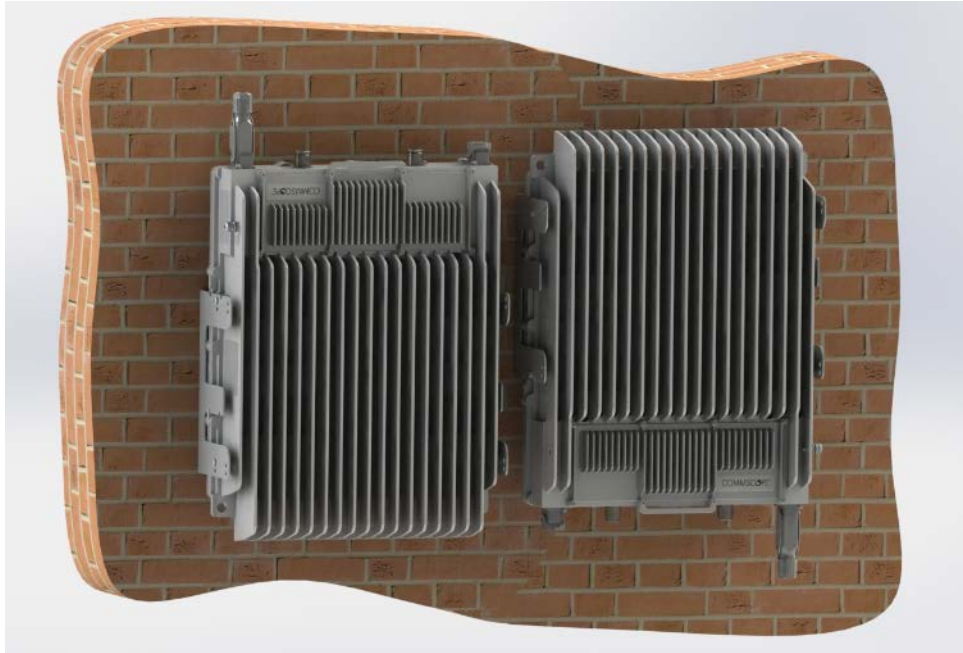

Figure 6. Wall Mounting Orientations for a CAP L2

Mounting CAP L2 with a Wall Mounting Kit

The following sections provide the installation methodology and steps required to mount a CAP L2 to a wall. When wall mounting a CAP L2, the recommendations should be observed.

Table 12. Wall Mount Kit (784842) components

Part Number	Region	Quantity	Component
7846281-01	EMEA	1	Wall Mounting Bracket, single (included in CAP L2 kit)
7848842	NAR		Wall Mounting Bracket, single (not included in CAP L2 kit)

- 1 Use "[Plan and Prepare for a Fiber CAP L2 Installation](#)" on page 15 to identify the installation site and installation requirements, and to prepare for the installation.
- 2 Refer to and observe all cautions listed in "[General Mounting Cautions](#)" on page 19.
- 3 Refer to "[Mounting Orientation for Wall Mounts](#)" on page 20 to determine the mounting orientation of the CAP L2.

- 4 Use the wall bracket as a template to mark the holes at the location where you will mount the UAP 2.

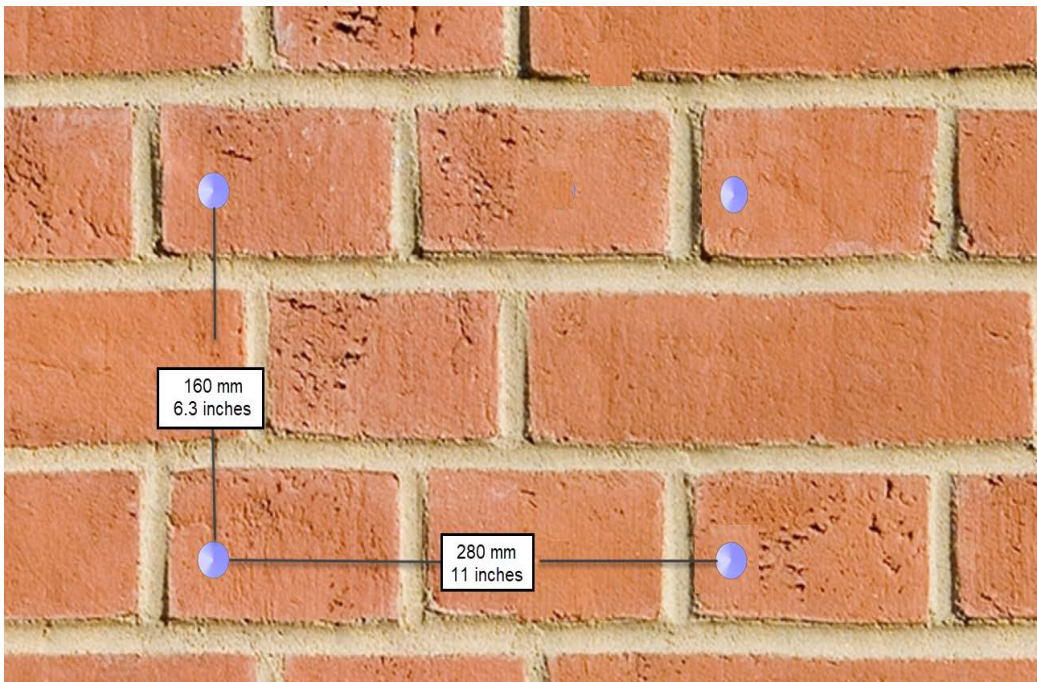
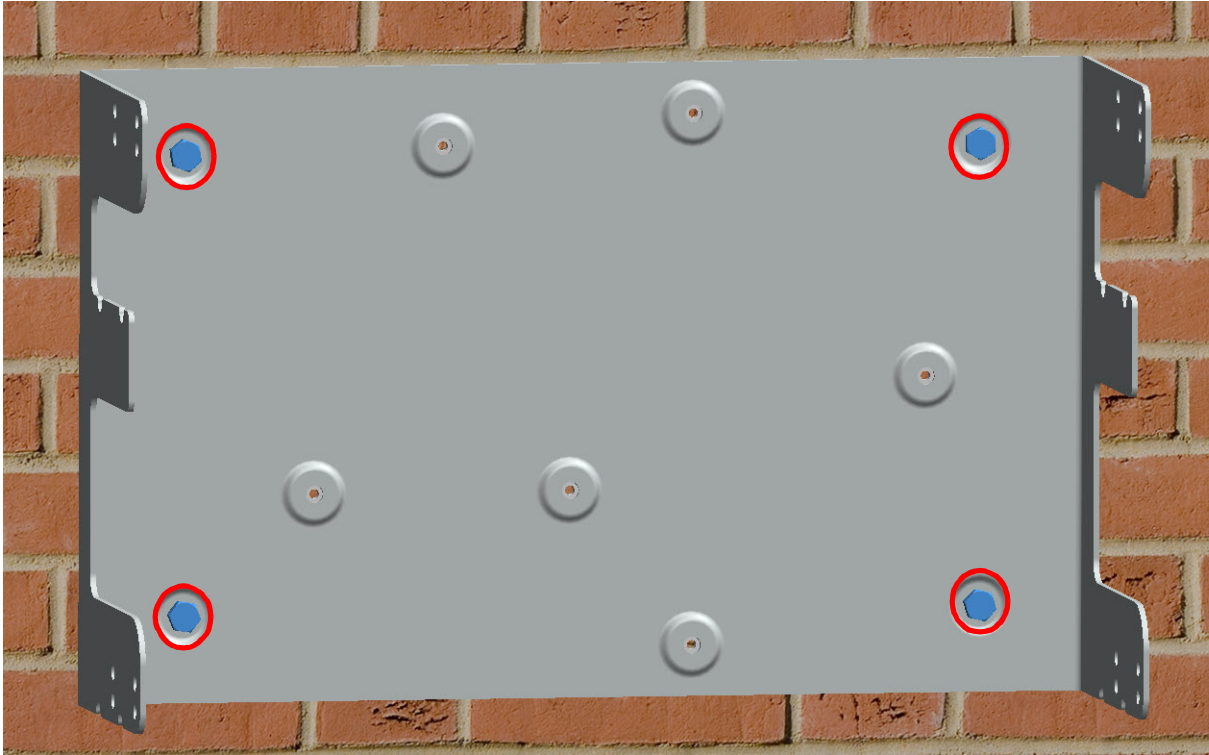

- 5 Secure the wall mount bracket to the wall, using four anchor screws.



The anchor screws do not ship with the CAP L2 as the anchor type is dependent on the on-site conditions (wall structure and materials). Use screw anchors that are rated for the mounting surface.

The hole for the screws in the bracket is 7.5 mm in diameter and will accommodate screws between 5.8 mm and 7.5 mm.

- 6 Confirm that the Wall Mount Bracket is securely fastened to the wall.

- Lift the CAP L2 onto the bracket and align the holes on the CAP L2 with the rear holes of the bracket, closest to the mounting surface. Ensure that the hanger tab is secure on the bracket.

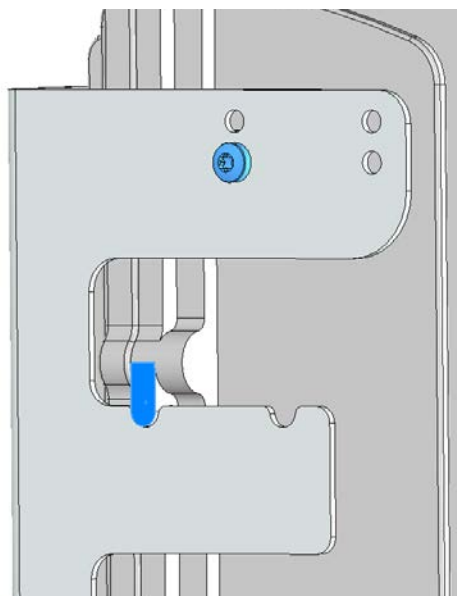

- Tighten the CAP L2 M5 screws, provided with the CAP L2, on both sides on the top and bottom at a Torq of 6.5 Nm.

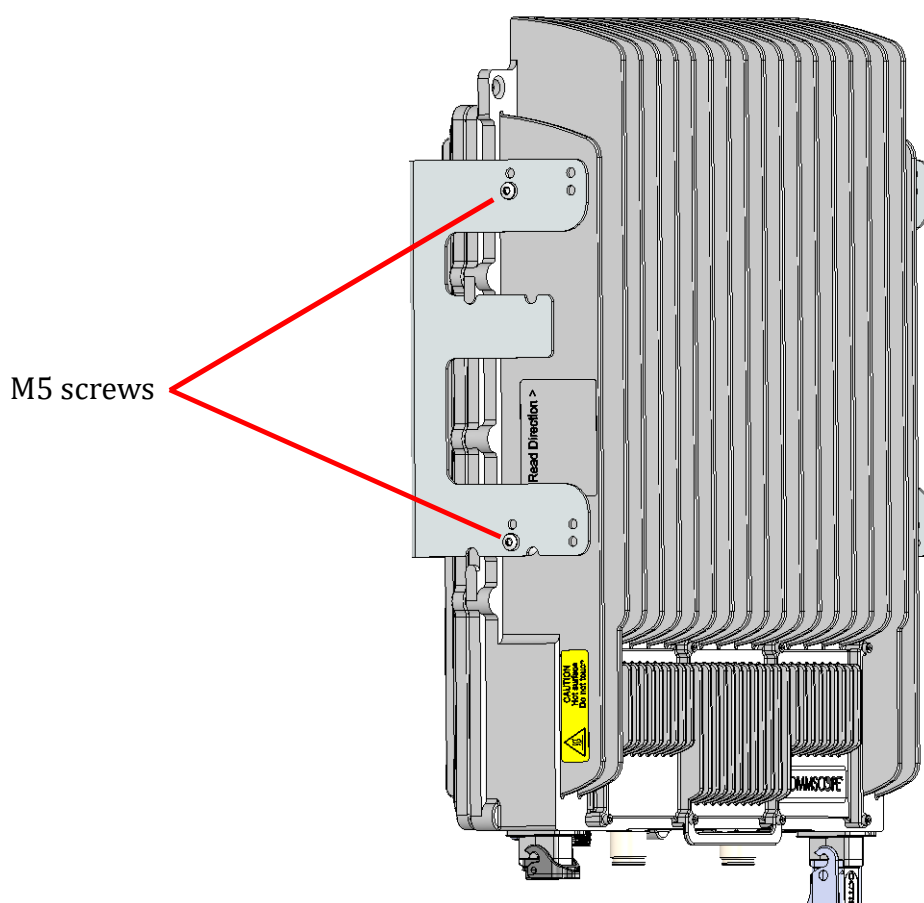

- Confirm that the CAP L2 is securely attached to the Wall Mount Bracket.

10 After you mount the CAP L2 on a wall, follow the steps in

- ["Ground the Fiber CAP L2 \(Optional\)" on page 36](#) (if grounding is required)
- ["Connect the Fiber CAP L2 to a Passive RF Antenna" on page 37](#)

Mounting a CAP L2 with an AC/DC Power Supply Kit

An AC/DC Power Supply Kit provides a 48V External Power Supply that converts local AC power to DC power for the CAP L2. The AC/DC Power Supply Kit (PN 7850197) can be used for a CAP L2 Interface when an AC power source is located near the CAP L2.



The AC/DC Power Supply Kit (PN 7850197) must be ordered separately.

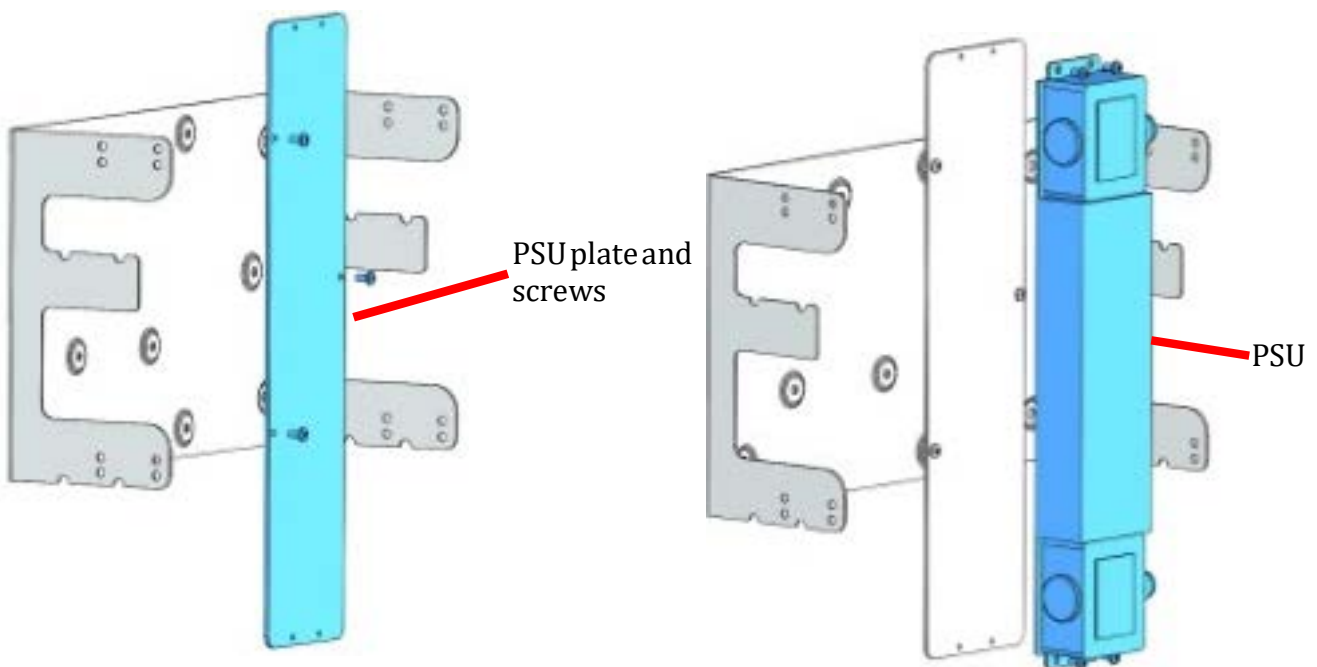

Figure 7. AC/DC Power Supply Kit

Do the following to mount a CAP L2 using an AC/DC Power Supply Kit.

- 1 Obtain the AC/DC Power Supply Kit that is appropriate for this installation. [Figure 8 on page 25](#) lists the three AC/DC Power Supply Kit part numbers; see also ["Fiber CAP L2 Overview" on page 9](#).
- 2 Refer to and observe all cautions listed in ["General Mounting Cautions" on page 19](#).
- 3 Refer to ["Determine the CAP L2 Installation Site" on page 16](#) to determine the mounting location, which must be able to support the weight and dimensions of the CAP L2.
- 4 Refer to ["Mounting Orientation for Wall Mounts" on page 20](#) to determine the mounting orientation of the CAP L2.

- 5 Follow the steps in "Unpack and Inspect the CAP L2 and Optional Accessories" on page 18.

Wiring the AC/DC Power Supply Kit

The CommScope Local AC Power Supply Kits are available in three configurations as shown in "CommScope Local AC/DC Power Supply Kits" on page 25. The installer must supply and install the AC input power cord for kit number 7775087-xx and kit number 7809823-xx. The AC input power cord for kit number 7809798-xx is connected internally but is unterminated at the customer end.

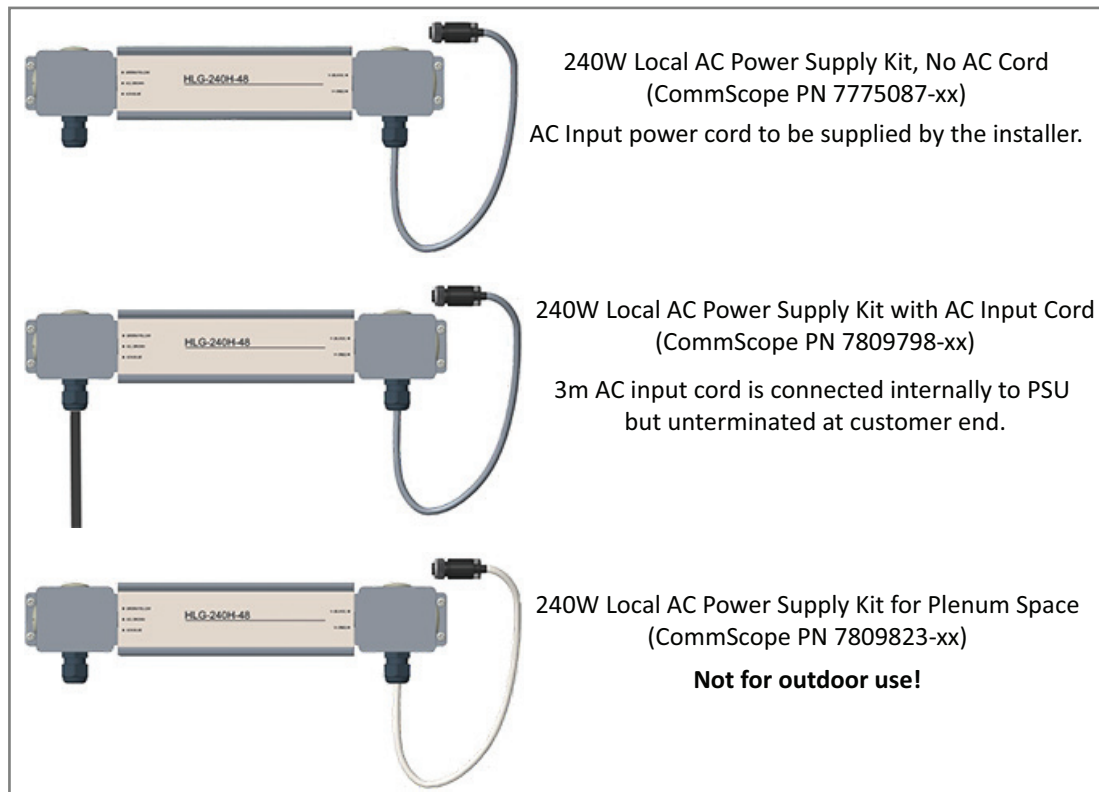

Figure 8. CommScope Local AC/DC Power Supply Kits

To insert and connect the AC input cord for kit number 7775087-xx and kit number 7809823-xx, do the following:

- 1 Remove the four Phillips head screws from the left junction box cover of the kit and then remove the junction box cover.

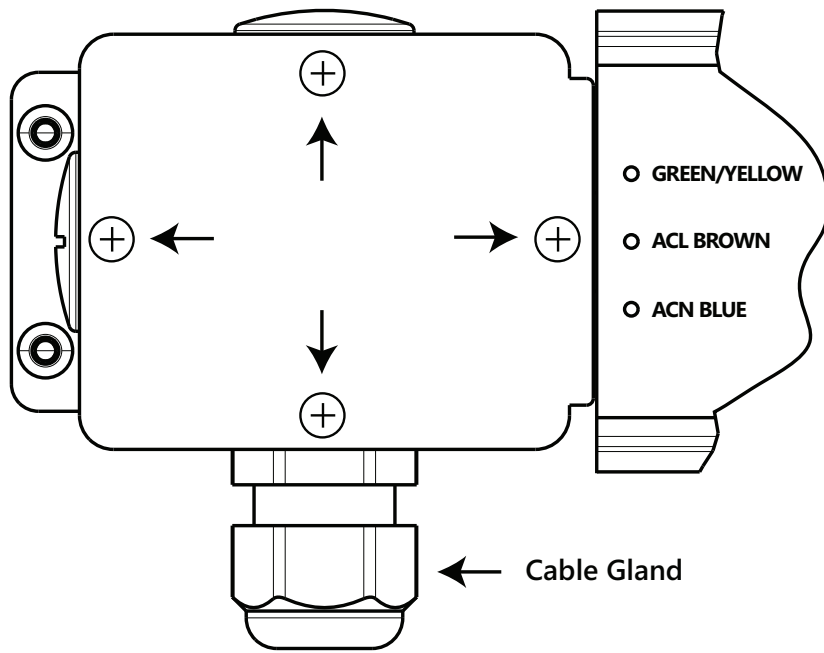

Figure 9. AC/DC Supply Junction Box Cover Screws

- 2 Insert a 16 AWG (1.31 mm²) 3-conductor AC input cable through the cable gland in the junction box.



A plenum rated AC input cable is required when using the Plenum AC Power Supply kit or else the cable must be routed to the junction box in conduit.

- 3 Terminate the cables using WAGO 221 Series Lever-Nuts or equivalent connectors as shown in Figure 10.

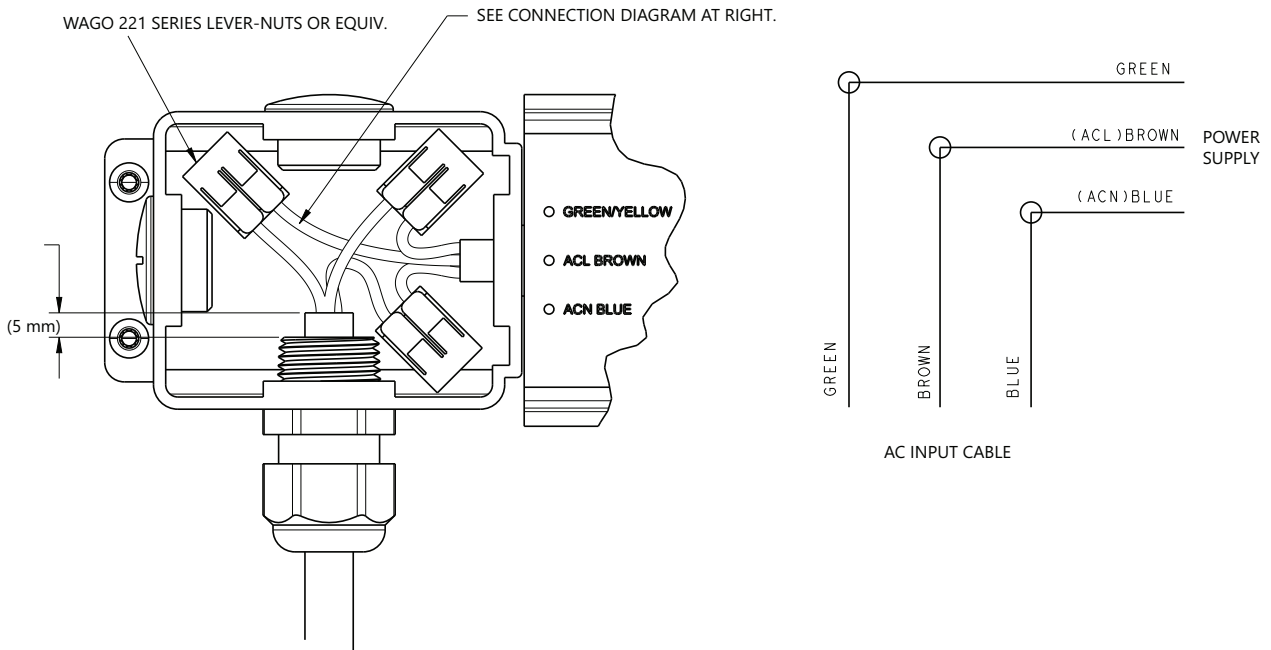

Figure 10. AC/DC Supply Cable Terminations

- 4 Torque the cable gland nut to 3.0 Nm (26.5 in-lb) to secure the cable.

- 5 Replace the junction box cover and tighten the four Phillips head screws to secure it.
- 6 Mount the AC/DC Power Supply Kit to the CAP L2 mounting bracket.



Due to derating requirements, each CAP L2 must have its own PSU – no sharing is permitted.

- 7 Assemble and mount the AC/DC Power Supply Kit and the CAP L2, as described below and as shown in [Figure 11 on page 27](#). The Local Power Jumper Cable Assembly will be connected to the AC/DC Power Supply Junction Box at the factory.
 - a Use the three screws to attach the AC/DC Power Supply Unit (PSU) plate to the Wall Mounting Bracket.
 - b Attach the PSU to the PSU plate.
 - c Attach the assembled AC/DC Power Supply Kit and Wall Mounting Bracket to the selected mounting location.
 - d Mount the CAP L2 starting with [Step 7 on page 23](#).

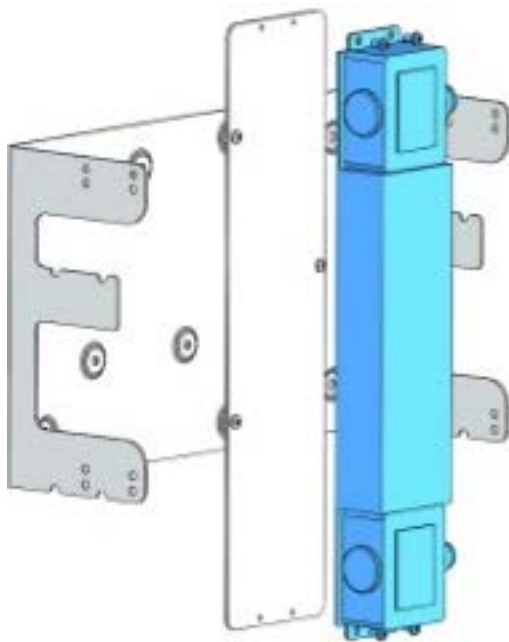

Bracket, PSU Plate, PSU

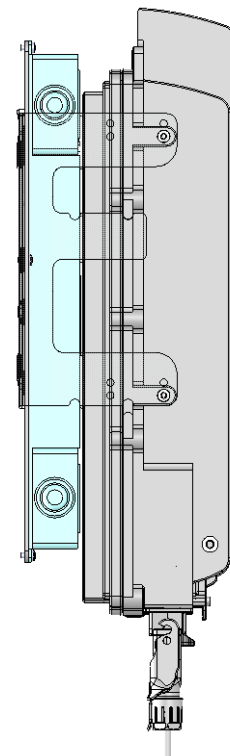

Wall-mounted CAP L2 with PSU

Figure 11. CAP L2 with AC/DC Power Supply Kit

The Power Supply/Hybrid Fiber Mounting Kit is not included with the CAP L2 and must be ordered separately.

- 8 Connect the Local Power Jumper Cable (shown below) to the CAP L2 36 to 60 Vdc Power connector (see [Figure 1 on page 9](#)).

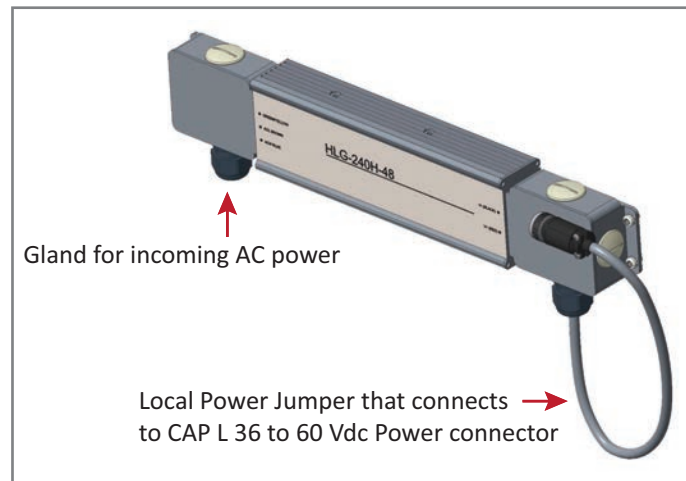

- 9 Follow the steps in "[Ground the Fiber CAP L2 \(Optional\)](#)" on page 36 if grounding is required or preferred.
- 10 Follow the steps in "[Connect the Passive RF Antenna](#)" on page 40.

Mounting a CAP L2 with a Hybrid Fiber Splice Box Kit (optional)

The CAP L2 Hybrid Fiber Splice Box Kit (CommScope PN 7781091-xx) provides a connection solution for both power and optical signals to a CAP L2. For Fiber CAP L2s, you have the option to use composite cable to transport signals from a TEN or Classic CAN via fiber and power from a remote DC supply, and then use the CAP L2 Hybrid Fiber Splice Box Kit to terminate the power and fiber at the CAP L2.



The CAP L2 is designed to be supplied by two LPS (Limited Power Source, <100VA) circuits. By using LPS circuits, some electrical code requirements for installing the power cables are relaxed. The CAP L2 supports a combined/parallel circuit approach. That is, two LPS circuits can be combined in parallel and the CAP L2 supplied by a single, higher power source. In either configuration, all electrical and safety code requirements must be followed.



It is the responsibility of the customer/installer to observe the local regulations of the DC service provider and to comply with Limited Power Source (LPS) requirements where applicable.

Prepare for CAP L2 Hybrid Fiber Splice Box Kit Installation

- 1 Follow the steps in "[Unpack and Inspect the CAP L2 and Optional Accessories](#)" on page 18.
- 2 Refer to "[Determine the CAP L2 Installation Site](#)" on page 16 to determine the mounting location, which must be able to support the weight and dimensions of the CAP L.
- 3 Refer to "[Mounting Orientation for Wall Mounts](#)" on page 20 to determine the mounting orientation of the CAP L2.

Assembling and Wiring the Hybrid Fiber Splice Box

The following subsections describe how to assemble the Hybrid Fiber Splice Box and then how to wire it to provide power to the CAP L2:

- ["Assembling and Wiring the Hybrid Fiber Splice Box" on page 29](#) tells you how to place the wires into the Hybrid Fiber Splice Box.
- You then need to follow one of the following procedures that meets the powering requirements of this installation.
 - ["Wire a Hybrid Fiber Splice Box for 4-Wire Power with Limited Power Source" on page 33](#)
 - ["Wire a Hybrid Fiber Splice Box for 2-Wire Power without Limited Power Source" on page 34](#)

Wire the Hybrid Fiber Splice Box

Do the following to assemble and wire the Hybrid Fiber Splice Box.

- 1 Open the Hybrid Fiber Splice Box and remove the installation kit that is inside.
- 2 Using the parts from the Hybrid Fiber Splice Box, insert the Splice Holder and fasten it using a PTK 30x6 screw and one M4 washer.
- 3 From the CAP L2 Hybrid Fiber Splice Box Kit, insert Fiber Patch Cord in one of the cable glands indicated in the graphic to the right.

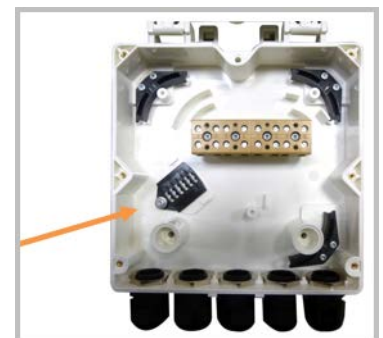

- Strip the insulation of the composite cable for 100 cm and the fibers for 90 cm, and then shorten the copper cables to 25 cm.

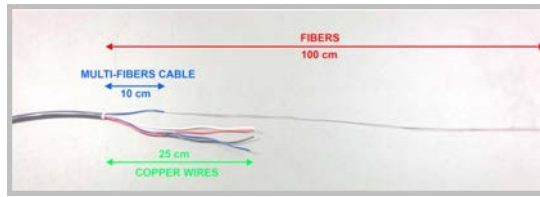

- Insert the composite cable in the first cable gland and separate the multi-fibers cable from the copper wires. It is necessary to remove the nut to perform this action. The cable must be fed through the nut and it must be retightened once finished.



- Bend the spliced fibers using the corner guides and fix the splices to the splice holder.

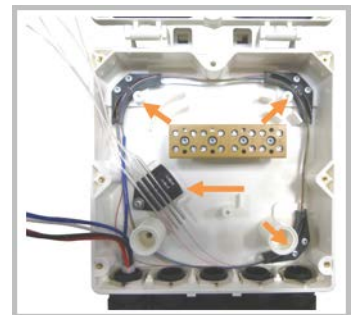

- Bend the optical cables as shown in the picture to the right.

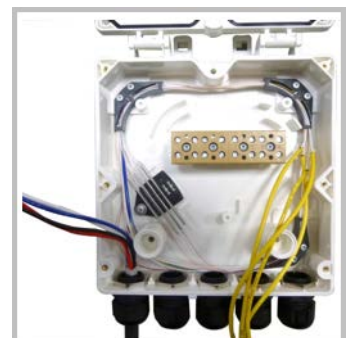

- If a second splice holder is needed, it can be assembled using the M4 insulating washer and two M4 plain washers, as shown to the right. The required screw is a PTK30 x 12.



- 9 Remove the sealing nut and rubber of the cable gland and insert the optical cables.



- 10 Place each cable into one of the grooves of the seal insert.



- 11 Press the seal insert into the clamp ring opening.



- 12 Fix the optical cables inside the box using one cable tie and tighten the sealing nut.

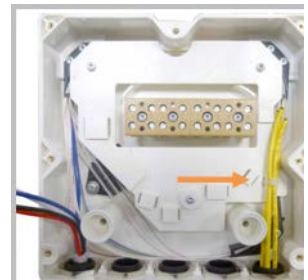

- 13 It is possible to separate the optical cables and use two different cable glands. Remove the sealing nut and rubber on each cable gland.

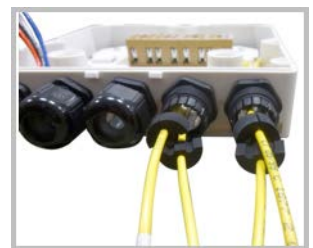

- 14 Close all unused grooves with the plastic cylinders, no matter if one or two cable glands are used.



- 15** Insert the copper wires in the first multiple terminal connectors. See markings on the internal support. Then fasten the copper cables inside the box using one cable tie.

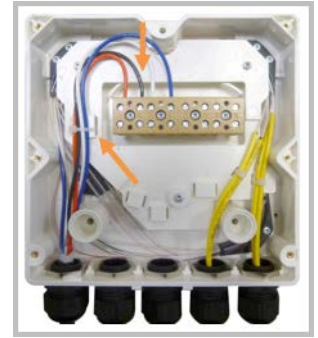

- 16** Remove the sealing nut and insert the CAP L2 supply cable and tighten the sealing nut.



- 17** Connect the supply cable to the terminal strip and fix it inside the box using one cable tie.

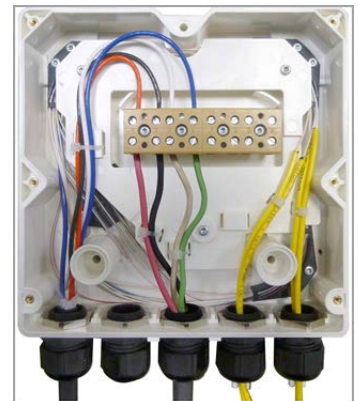

It is possible to connect a second supply cable to cascade two CAP L2s, as shown in the graphic to the right.

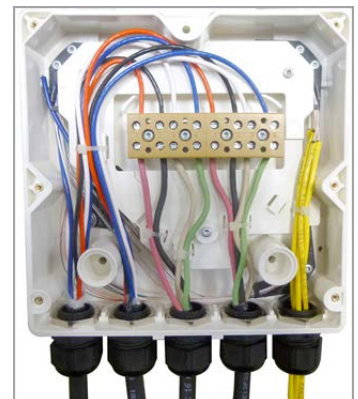

- 18** Complete the steps in "[Wall Mount a CAP L2 Using a CAP L2 Hybrid Fiber Splice Box Kit \(optional\)](#)" on page 35.

Wire a Hybrid Fiber Splice Box for 4-Wire Power with Limited Power Source

Use the 4-wire power setup when Limited Power Source (LPS) is required by local electrical/safety codes. Each CAP L2 can accept two Limited Power Sources from the DC PSU where local regulations require it.

In the following wiring procedure, you will connect the power wires from the Hybrid Fiber Splice Box to a DC Power Supply Unit (PSU).



The color code of the hybrid fiber cable in the following tables and diagrams is for example purposes only. The color of the wires may be different than the examples depending on the type and manufacturer of the composite hybrid cable.

- 1 Refer to [Table 13](#) and [Figure 12](#) to wire a Hybrid Fiber Splice Box for 4-Wire power with Limited Power Source (LPS).



All four pins of the proprietary CAP L2 4-pin 36 to 60 Vdc Power connector must be terminated.

Table 13. 4-Wire Power Wiring with LPS

Hybrid Cable Two Circuits	CAP L2 Power Cable		
	Wire	Pin	Function
Circuit 1 (0V)	Red	1	V1+
Circuit 1 (-36 to -60V)	Black	2	V1-
Circuit 2 (0V)	White	3	V2+
Circuit 2 (-36 to -60V)	Green	4	V2-

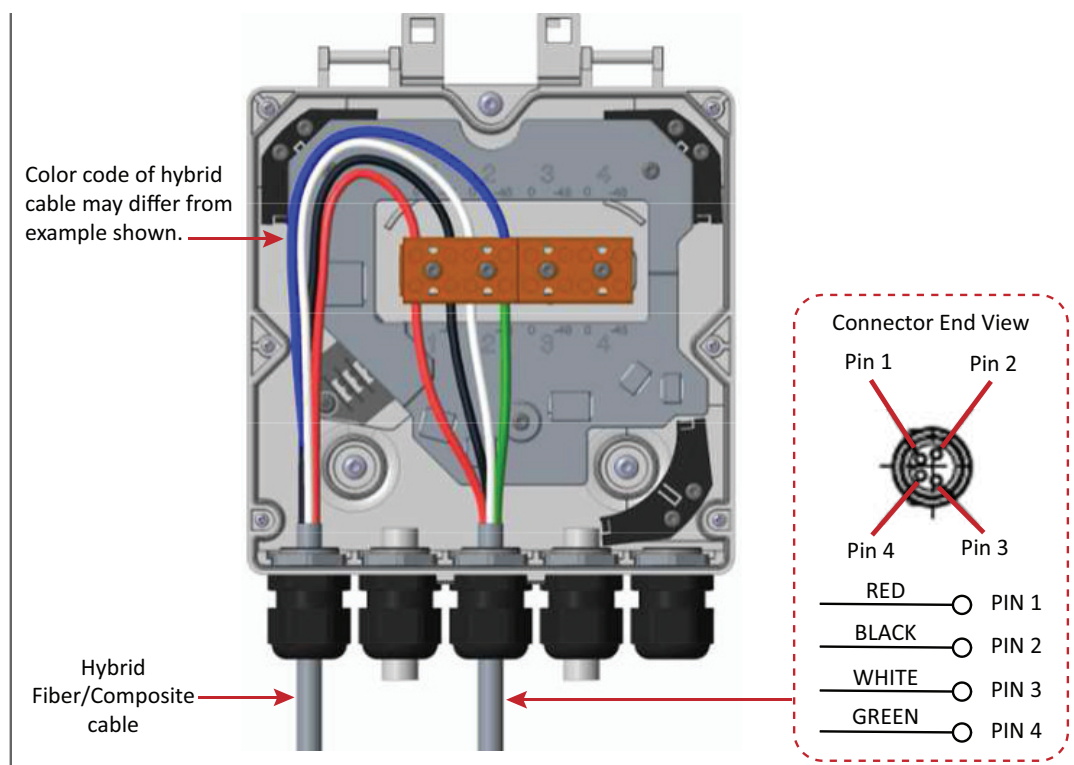

Figure 12. Wiring a Hybrid Fiber Splice Box for 4-Wire Power with LPS

- After you have wired the Hybrid Fiber Splice box, complete the steps in "Wall Mount a CAP L2 Using a CAP L2 Hybrid Fiber Splice Box Kit (optional)" on page 35.

Wire a Hybrid Fiber Splice Box for 2-Wire Power without Limited Power Source

Each CAP L2 can be powered by 2 wires if LPS from the DC PSU are not required by local regulations..



All four pins of the proprietary CAP L2 4-pin 36 to 60 Vdc Power connector must be terminated.

- Refer to Table 14 and Figure 13 to wire a Hybrid Fiber Splice Box for 2-Wire power without an Limited Power Source (LPS).

In this power variation you must tie the following power cables together:

- V1+ (PIN 1)** and **V2+ (PIN 3)** (CAP L2 DC Jumper Power Cable Red and White wires)
- V1- (PIN 2)** and **V2- (PIN 4)** (CAP L2 DC Jumper Power Cable Black and Green wires)

Table 14. Wiring Single Circuit Source to a CAP L2

Source Cable	CAP L Power Cable		
	Wire	Pin	Function
Circuit 1 (0V)	Red	1	V1+
	White	3	V2+
Circuit 1 (-36 to -60V)	Black	2	V1-
	Green	4	V2-

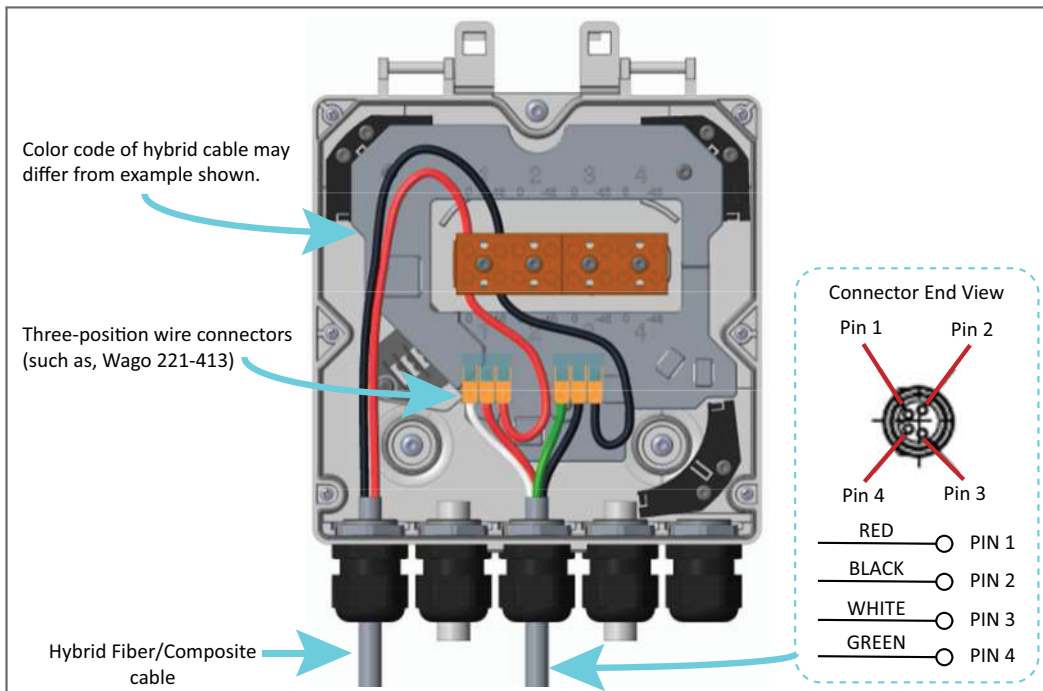

Figure 13. Wiring a Hybrid Fiber Splice Box for 2-Wire Power without LPS

- 2 After you have wired the Hybrid Fiber Splice box, complete the steps in ["Wall Mount a CAP L2 Using a CAP L2 Hybrid Fiber Splice Box Kit \(optional\)"](#) on page 35.

Wall Mount a CAP L2 Using a CAP L2 Hybrid Fiber Splice Box Kit (optional)



The steps in this section pertain only to those installations that require the use of the optional Hybrid Fiber Splice Box to provide fiber and power to the CAP L2.

- 1 Remove the Hybrid Fiber Box cover.
- 2 Attach the Hybrid Fiber Splice Box to the Wall Bracket with the three captive screws already installed in the Splice Box.
- 3 Replace the cover.

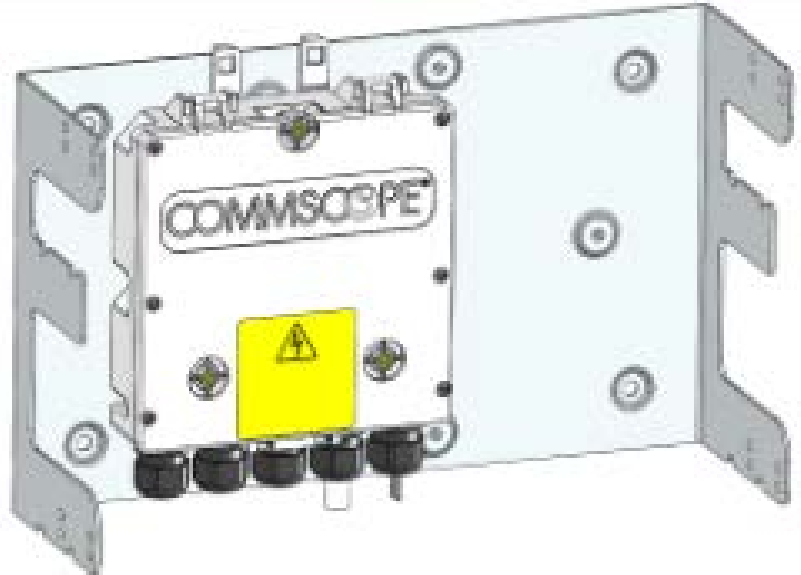
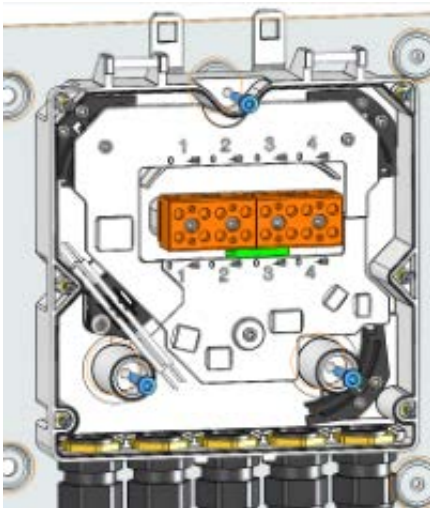

- 4 Attach the assembled Wall Mounting Bracket and Hybrid Splice Box to the selected mounting location.
- 5 If required, install an SFP+ module and follow the instructions in ["Installing SFP+ Modules in the CAP L2 \(optional\)"](#) on page 42.
- 6 Follow procedure in ["Mounting CAP L2 with a Wall Mounting Kit"](#) on page 21.

CONNECT THE CABLES TO THE FIBER CAP L2

Complete the following procedures in the order in which they are presented.

- "Ground the Fiber CAP L2 (Optional)" on page 36
- "Connect the Passive RF Antenna" on page 40
- "Connect the Fiber CAP L2 to a Classic CAN or TEN" on page 44
- "Connect to Vdc Power" on page 45
- "Connect to Vdc Power" on page 45.



Do not remove protective caps from any of the connectors until instructed to do so.

Ground the Fiber CAP L2 (Optional)

Follow the steps below to ground the OPA only if grounding is required in your locality or if the installation plans require the CAP L2 be grounded. The different CAP L2 installation procedures will tell you when to ground the CAP L2.



The CAP L2 is equipped with an M6 grounding stud located on the back of the unit; however, grounding is not necessary. CAP L2s are classified as low-voltage devices and do not have internal power supplies. CommScope recommends checking your local and national electrical codes to determine if grounding is a requirement.

Do the following to ground a Fiber CAP L2.

- 1 Obtain a length of #18 AWG (1.00 mm) insulated stranded copper wire for use as a chassis-grounding wire.
- 2 Terminate one end of the wire with a ring terminal.
- 3 Locate the chassis-ground stud at the rear of the enclosure.
- 4 Remove the Keps nut from the chassis-ground stud.

- 5 Attach the ring end of the wire to the chassis ground stud on the bottom, right side of the CAP L2, as shown in the graphic below.

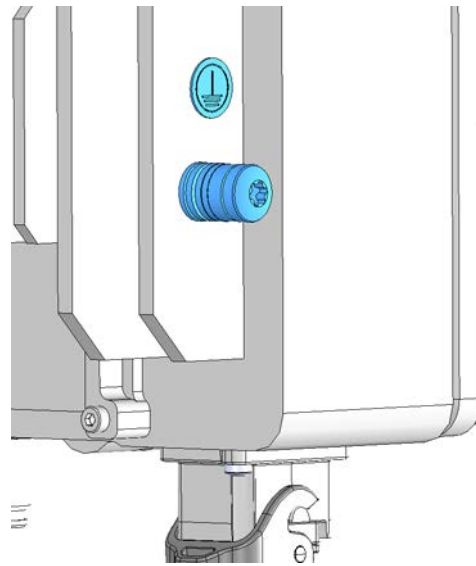

- 6 Use the Keps nut removed in [Step 4](#) to secure the ground wire to the chassis-ground stud.
- 7 Route the free end of the chassis grounding wire to an approved (per local code or practice) earth ground source.

Connect the Fiber CAP L2 to a Passive RF Antenna

The following sections guide you through connecting the CAP L2; complete these procedures in the order in which they are presented.

- ["Clean the RF Cable Connectors"](#) on page 38
- ["Connect the Passive RF Antenna"](#) on page 40

Clean the RF Cable Connectors

This section tells you how to clean RF cable connectors. The graphics in this section illustrate the cleaning procedure and do not show the CAP L2.



This procedure requires the use of compressed air. Wear protective clothing—especially protective glasses—to protect against injury from flying particles.



This procedure requires the use of flammable material. There is a risk of fire. Keep away from sources of ignition.



This procedure requires the use of eye irritant product. There is a risk of eye irritation. Avoid contact with eyes and skin. Wear protective clothing—especially protective glasses.

Do the following to clean the RF cable connectors.

1 Gather the following cleaning tools:

- Isopropyl alcohol
- Compressed air
- Lint-free wipe
- Cotton buds.



2 Remove the protective cap from the RF connector.

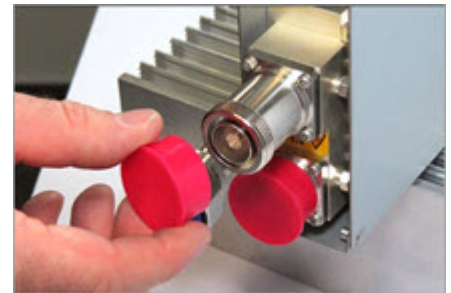

3 Use compressed air to remove metal chips and small particles from the mating and inner surfaces of the connector.



- 4 Use a lint-free wipe drenched with isopropyl alcohol to clean the connector winding.



- 5 Use a cotton bud drenched with isopropyl alcohol to clean the lip of the inner ring.



- 6 Use a cotton bud drenched with isopropyl alcohol to clean the inside surface of the inner ring.

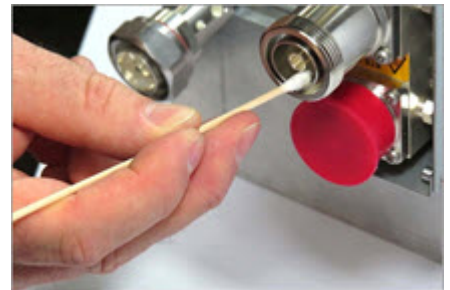

- 7 Use a cotton bud drenched with isopropyl alcohol to clean the inside of the center conductor spring tines.

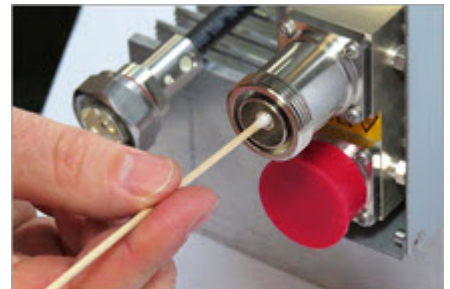

- 8 Remove the protective caps from the unit connector, and then clean it the same way that you cleaned the cable connector.

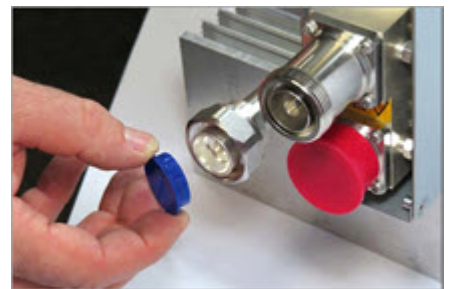

- 9 Use compressed air to remove metal chips and small particles from the mating and inner surfaces of the connector.



- 10 Use a lint-free wipe drenched with isopropyl alcohol to clean the winding area.



- 11 Use a cotton bud drenched with isopropyl alcohol to clean the inside mating surface of the inner ring.



- 12 Use a cotton bud drenched with isopropyl alcohol to clean the outside surface of the center pin.



Connect the Passive RF Antenna

Do the following to connect a Fiber CAP L2 to a passive RF antenna.

- 1 Connect the CAP L2 ANT 1 or ANT 2 connector to a passive RF antenna.
 - a Locate the 50 Ω coaxial cables obtained for this installation; see ["Obtain the Required Materials" on page 18](#).
 - b Install the passive antennas per the manufacturer's installation instructions.
 - c Remove the plastic-protective cap from the 4.3-10 connectors.
 - d Remove the IP67/EMI blank plug from the ANT 1/2 connector.
 - e Connect the passive antenna to the ANT 1 or ANT 2 connector using coaxial cable with the least amount of loss possible.

- If the 50 Ω coaxial cable has a push-pull connector, make sure the cable is seated firmly in the ANT 1 or ANT 2 connector.
 - If the 50 Ω coaxial cable has a threaded connector, torque the connector 5 N-m (3.69 ft-lb). Do not over-tighten the connector.
- f Connect the other end of the 50 Ω coaxial cable to the passive antenna installed in [Step b](#).
- 2 If necessary, repeat [Step 1 on page 40](#) to connect a 50 Ω coaxial cable to the other ANT connector.

Connect the Optical Fiber

Connecting the optical fiber cable from the hybrid splice box requires removing the CAP L2 cover on the bottom of the AP.

The optical fiber cable may be connected with or without the optional SFP+ module pair.

- 1 Install the hybrid splice box on the CAP L2 bracket. See "[Mounting a CAP L2 with a Hybrid Fiber Splice Box Kit \(optional\)](#)" on page 28.
- 2 Loosen the eight torque screws on the cover located at the bottom of the CAP L2.



- 3 Feed the cable from the hybrid splice box through the CAP L2 port, as shown below, and assemble the OCTIS LC Universal lever and insert it into the CAP L2 port as shown in [Figure 3](#). For OCTIS Universal connector assembly instructions, see "[OCTIS Universal Lever Assembly Instructions](#)" on page 13.

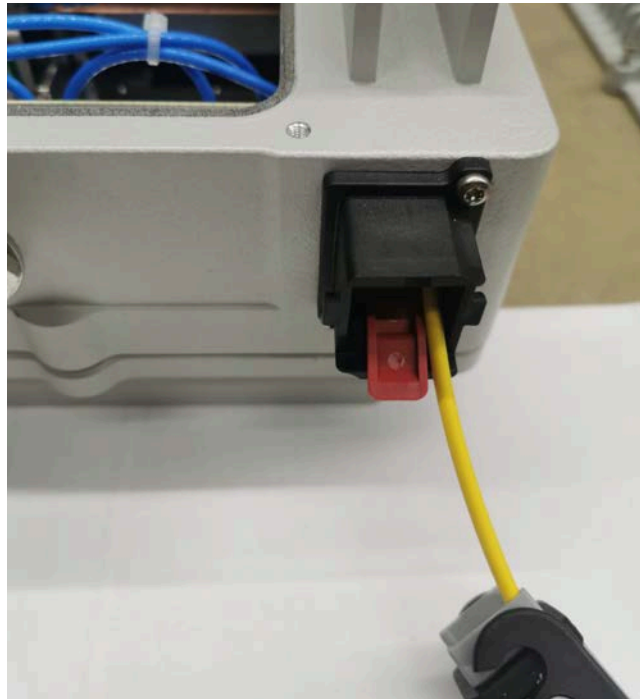

- 4 Insert the cable in the fiber optic port.

Fiber optic cable
inserted into CAP L2
port

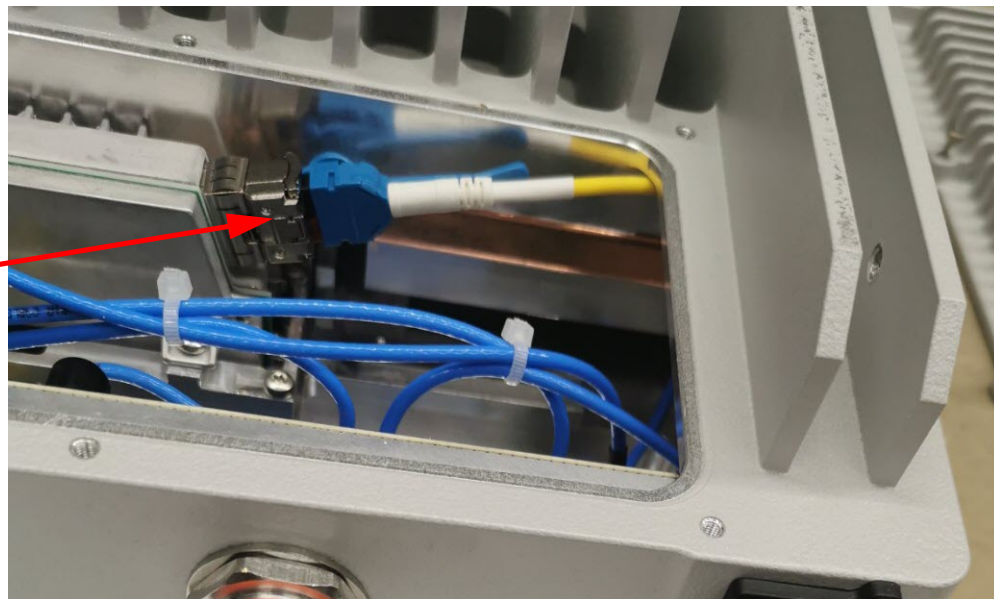

- 5 Replace the cover on the CAP L2.

Installing SFP+ Modules in the CAP L2 (optional)

See "[SFP+ Module Kits](#)" on page 11 for more information.

- 1 Install the hybrid splice box on the CAP L2 bracket. See "[Mounting a CAP L2 with a Hybrid Fiber Splice Box Kit \(optional\)](#)" on page 28.
- 2 Loosen the eight torque screws on the cover located at the bottom of the CAP L2.



3 Insert the SFP+ module into the port as shown below.

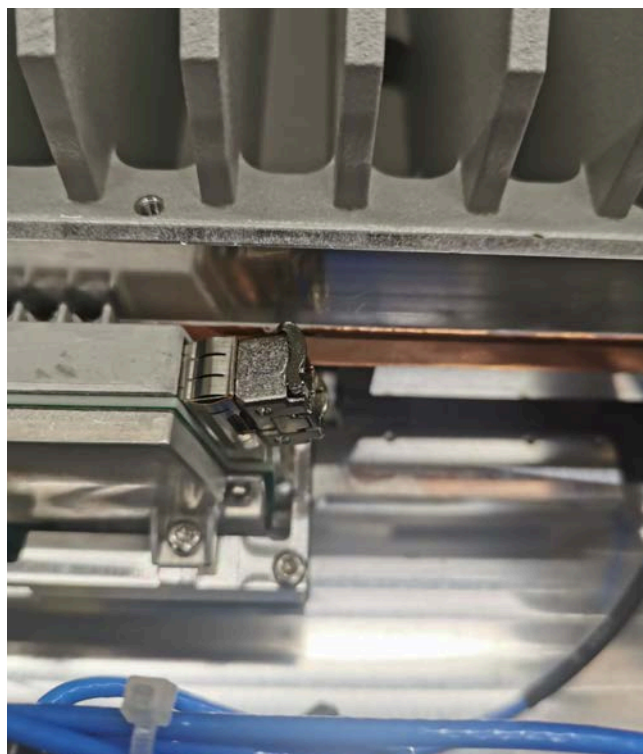
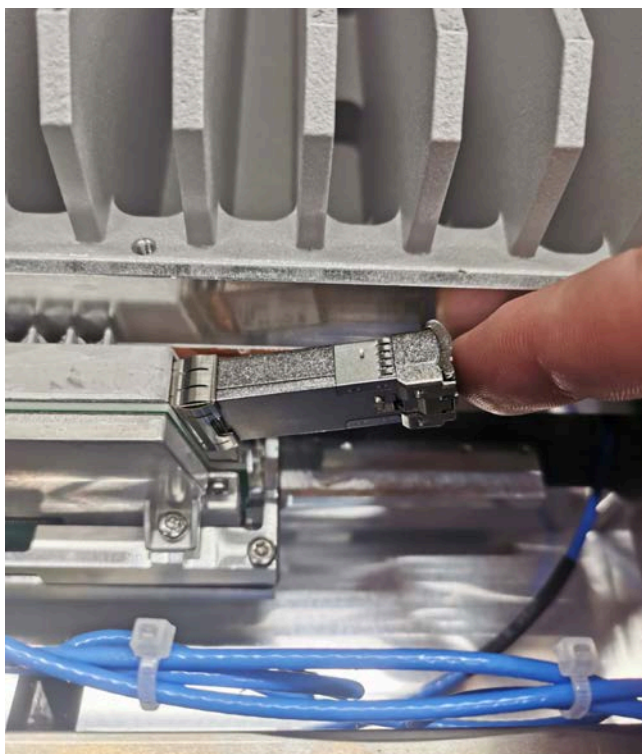

4 Feed the cable from the hybrid splice box through the CAP L2 port, as shown below, and assemble the OCTIS LC Universal connector and insert it into the CAP L2 port as shown in [Figure 3](#).

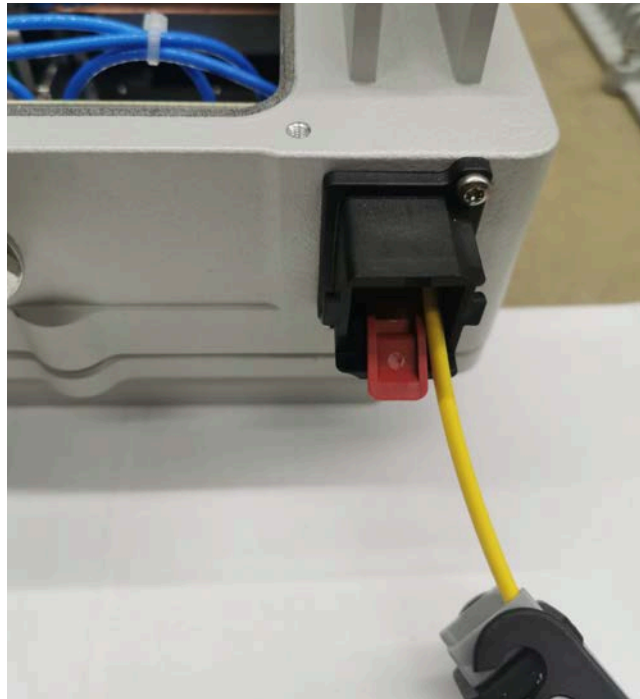

- 5 Connect the LC connector to the SFP+ module inside the CAP L2.

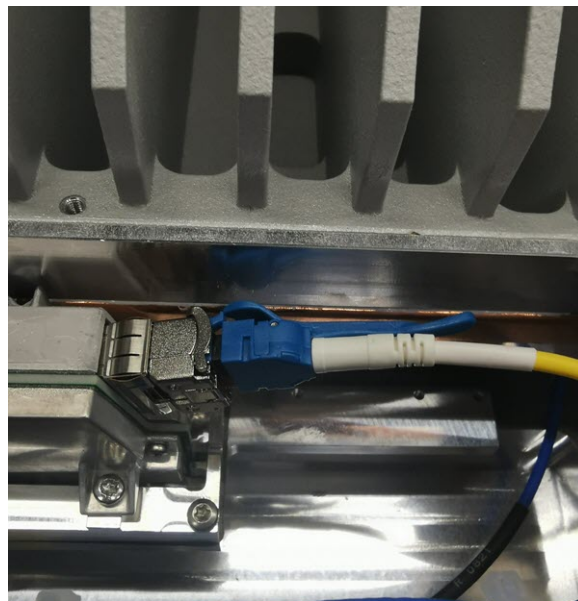

- 6 Replace the cover on the CAP L2.

Connect the Fiber CAP L2 to a Classic CAN or TEN

- 1 Connect the CAP L2 Optical Port 1 as appropriate for this installation.
 - a Remove the dust cap from the CAP L2 Optical Port 1 connector and the connectors on the SMF or MMF.
 - b Follow the local cleaning technique to clean Optical Port 1.
 - c Clean the connectors on the SMF or MMF following the fiber supplier's recommendations.
 - d Install the SFP+ connector and Optical OCTIS Kit on the end of the SMF or MMF that will connect to the CAP L2.

- i Follow the limitations per the maximum range described in "[OCTIS Universal Lever Assembly Instructions](#)" on page 13.
 - ii Connect that end of the SMF or MMF to the CAP L2 Optical Port 1 connector.
- e Connect the other end of the SMF or MMF to an open port on an OPT Card installed in Slots L1-L4 in the TEN or Classic CAN. WCS Slots L5-L8 cannot be used to connect APs.



If installing a CAP L2 with the CAP L2 Hybrid Fiber Splice Box Kit (PN 7781091-xx), the optical fiber will be hanging from the Hybrid Fiber Splice Box.

- 2 Go to "[Connect to Vdc Power](#)" on page 45.

Connect to Vdc Power

Connect the Vdc Power connector as appropriate for this installation. The CAP L2 is powered on as soon as you connect the CAP L2 to a power source; see "[Powering on a Fiber CAP L2](#)" on page 45.

- If powering the CAP L2s with local AC/DC power adapters, please see "[Wiring the AC/DC Power Supply Kit](#)" on page 25.
- If powering the CAP L2s with the Hybrid Fiber Splice Box kits, please see "[Mounting a CAP L2 with a Hybrid Fiber Splice Box Kit \(optional\)](#)" on page 28.

POWERING ON A FIBER CAP L2

The CAP L2 is powered on as soon as power is connected to it. Under normal operating conditions, the Power LED turns on briefly when the unit is first detected. It will then go out briefly, followed by an initialization period during which the Power LED flashes slowly while the CAP L2 is configured. The Power LED remains a steady green (not flashing) once the unit reaches a fully operational state, which typically occurs within 45 seconds.

The Power LED behavior for a Fiber CAP L2 is as follows:

- Steady Green – CAP/UAP is on and operational
- Slow Flashing Green – The CAP/UAP has been powered on and is initializing or if it is updating software.
- Fast Flashing green – The CAP unit identifier is active via the Flash LED function in the Era GUI.
- Slow-Flashing Red – The Era GUI is reporting a critical alarm for the unit. The CAP can be recovered without replacing hardware.
- Steady Red – The Era GUI is reporting a critical alarm for the unit. The CAP or CAP component (e.g SFP+ module) must be replaced.

CONTACTING COMMSCOPE

The following sections tell you how to contact CommScope for additional information or for assistance.

CMS Global Technical Support

The following sections tell you how to contact the CommScope Mobility Solutions (CMS) Technical Support team. Support is available 7 days a week, 24 hours a day.

Telephone Helplines

Use the following Helpline telephone numbers to get live support, 24 hours a day:

- | | |
|---------------------------------|-----------------------------------------------------------------------------------------------------|
| 24x7 | +1 888-297-6433 (Toll free for U.S. and Canada) |
| EMEA 8:00-17:00 (UTC +1) | + 800 73732837 (Toll free for parts of EMEA and Australia)
+ 49 909969333 (Toll charge incurred) |

Calls to an EMEA Helpline outside of the 8:00 to 17:00 time frame will be forwarded to the 24x7 Helpline.

Online Support

To go to the CommScope **Wireless Support Request** web site from which you can initiate a Technical Support ticket, do one of the following:

- Scan the QR Code to the right.
- If viewing this document online as a PDF, click on the following URL link:
<http://www.commscope.com/wisupport>
- Enter the preceding URL into your web browser, and then press **ENTER** on your keyboard.



Waste Electrical and Electronic Equipment Recycling

Country specific information about collection and recycling arrangements per the Waste Electrical and Electronic Equipment (WEEE) Directive and implementing regulations is available on CommScope's website.

To access information on the CommScope recycling program, do any of the following:

- Scan the QR Code to the right.
- If viewing this document online as a PDF, click on the following URL link:
<http://www.commscope.com/corporate-responsibility-and-sustainability/environment/weee-customer-recycling/>
- Enter the preceding URL into your web browser, and then press **ENTER** on your keyboard.



Hardware to Software Mapping Information

- 1 Scan the QR Code to the right to view or download the minimum software requirements for each of the DCCS hardware modules. Alternatively, you can go to the following web address to access the portal:

<https://www.commscope.com/resources/in-building-wireless/era>



- 2 Click on a document link to open it, or right click on the link and select the **Save target as...** option from the contextual menu.

Mobility Solutions Technical Training

- 1 To access training on the online CommScope Mobility Solutions site, please use the following web address or scan the QR code to the right:

<https://commscopeuniversity.com>



- 2 Once you have logged in, you can search for training by typing search words in the **Search** bar or by going to the Catalog page to view the available courses.
- 3 Instructor-led courses are conducted in North America and Europe. Before choosing a course, please verify the region.
- 4 For training related questions, please contact us:

Americas: DASTrainingUS@CommScope.com

EMEA: DASTrainingEMEA@CommScope.com

Accessing ERA Series User Documentation

- 1 Access to the Customer Portal requires a user account. If you don't have an account:
 - Visit My CommScope at <https://www.mycommscope.com>.
 - Click New user registration and follow the prompts.
 - After you've registered in My CommScope, click the Request Additional Access button and select the DAS and Small Cell Customer Portal from the list of applications.

- 2 Scan the QR Code to the right to go directly to the CommScope DAS and Small Cell Customer Portal, where you can access the DAS and Small Cell user documentation.

Alternatively, you can go to the following web address to access the portal:

<https://www.commscope.com/membership>



- 3 In Tools and Documentation, search by product, document category, or title.
- 4 Click on the title of any document to open it.

