

Test Site:
FCC Test Site No.: 96997
IC OATS No.: IC3475A-1



ECL-TAL Test Report No.: 10-031

Equipment under test: Node C 843 / Node M 843
FCC ID: XS5-NCM843
IC ID: 2237E-NCM843

Type of test: FCC 47 CFR Part 22 Subpart H:2009
 RSS-Gen:2007 , RSS-132:2005

Measurement Procedures: 47 CFR Parts 2:2009, Part 22:2009,
 ANSI/TIA-603-C-2004,
 RSS-Gen:2007, RSS132:2005

Test result: Passed

Date of issue:	22.03.2010			Signature:
Issue-No.:	01	Author:	M. Lehmann Test engineer	
Date of delivery:	15.02.10	Checked:	M. Grytz Operational manager	
Test dates:	15.02. – 16.02.10			
Pages:	62			

Test Site:
FCC Test Site No.: 96997
IC OATS No.: IC3475A-1



Manufacturer: ANDREW Wireless Systems GmbH
Industriering 10

D-86675 Buchdorf

Tel.: +49 (0)9099 69 0
Fax: +49 (0)9099 69 140

Test Location: TEMPTON Service Plus GmbH
European Compliance Laboratory (ECL)

Thurn-und Taxis-Straße 18
D-90411 Nürnberg
Tel.: +49 0911 59835 -0
Fax: +49 0911 59835 90

General:

The purpose of this report is to show compliance to the FCC regulations for unlicensed devices operating under section **22H** of the Code of Federal Regulations title 47 and RSS-Gen with RSS-132. This report informs about the results of the EMC tests, it only refers to the equipment under test. No part of this report may be reproduced in any form, without written permission.



Test Site:
FCC Test Site No.: 96997
IC OATS No.: IC3475A-1

Table of contents

1	TEST RESULTS SUMMARY	5
2	EQUIPMENT UNDER TEST (E.U.T.)	6
2.1	DESCRIPTION	6
2.1.1	DOWNLINK	6
2.1.2	UPLINK	6
2.1.3	DESCRIPTION OF EUT	6
2.1.4	SYSTEM DIAGRAM OF EUT	7
3	TEST SITE	9
3.1	TEST ENVIRONMENT	9
3.2	TEST EQUIPMENT	9
3.3	INPUT AND OUTPUT LOSSES	9
4	RF POWER OUT: §22.913, §2.1046	10
4.1	LIMIT.....	10
4.2	TEST METHOD	10
4.3	TEST RESULTS	11
4.3.1	DOWNLINK	11
4.3.2	UPLINK	12
4.3.3	DOWNLINK	13
4.3.3.1	CDMA	13
4.3.3.2	W-CDMA.....	14
4.3.4	UPLINK	16
4.3.4.1	CDMA	16
4.3.4.2	W-CDMA.....	17
4.4	SUMMARY TEST RESULT.....	19
5	OCCUPIED BANDWIDTH: §2.1049	20
5.1	LIMIT.....	20
5.2	TEST METHOD	20
5.3	TEST RESULTS	21
5.3.1	DOWNLINK	22
5.3.1.1	CDMA	22
5.3.1.2	W-CDMA.....	23
5.3.2	UPLINK	24
5.3.2.1	CDMA	24
5.3.2.2	W-CDMA.....	25
5.4	SUMMARY TEST RESULT.....	26
6	SPURIOUS EMISSIONS AT ANTENNA TERMINALS: §22.917, §2.1051.....	27
6.1	LIMIT.....	27
6.2	TEST METHOD	27



Test Site:
 FCC Test Site No.: 96997
 IC OATS No.: IC3475A-1

6.3	TEST RESULTS	28
6.3.1	DOWNLINK	28
6.3.2	UPLINK	29
6.3.3	DOWNLINK	30
6.3.3.1	CDMA < 1MHz to band edge.....	30
6.3.3.2	W-CDMA < 1MHz to band edge	31
6.3.3.3	CDMA > 1MHz to band edge.....	32
6.3.3.4	W-CDMA > 1MHz to band edge	35
6.3.4	UPLINK	38
6.3.4.1	CDMA < 1MHz to band edge.....	38
6.3.4.2	W-CDMA < 1MHz to band edge	39
6.3.4.3	CDMA > 1MHz to band edge.....	40
6.3.4.4	W-CDMA > 1MHz to band edge	43
6.4	SUMMARY TEST RESULT	46
7	FIELD STRENGTH OF SPURIOUS EMISSIONS: §2.1053 FOR FCC AND RSS-GEN FOR IC.....	47
7.1	LIMIT.....	48
7.2	TEST METHOD	49
7.3	TEST RESULTS	50
7.3.1	PREMEASUREMENTS	50
7.3.1.1	30 MHz to 1 GHz Downlink (<u>B</u> ottom – <u>M</u> iddle – <u>T</u> op).....	50
7.3.1.2	30 MHz to 1 GHz Uplink (<u>B</u> ottom – <u>M</u> iddle – <u>T</u> op)	54
7.3.1.3	1 GHz to 9 GHz Downlink (<u>B</u> ottom – <u>M</u> iddle – <u>T</u> op).....	57
7.3.1.4	1 GHz to 9 GHz Uplink (<u>B</u> ottom – <u>M</u> iddle – <u>T</u> op)	59
7.3.2	FINAL MEASUREMENTS (SUBSTITUTION METHOD)	61
7.3.2.1	30 MHz to 1 GHz Downlink.....	61
7.3.2.2	30 MHz to 1 GHz Uplink	61
7.3.2.3	1 GHz to 9 GHz Downlink.....	61
7.3.2.4	1 GHz to 9 GHz Uplink	61

Test Site:
 FCC Test Site No.: 96997
 IC OATS No.: IC3475A-1

1 Test Results Summary

Name of Test	FCC Para. No.	IC Para. No.	FCC Method	FCC Spec.	Result
RF Power Output	2.1046	RSS-Gen/ ANSI C63.4:2009	22.913	500 Watts	Complies
Occupied Bandwidth	2.1049	RSS-Gen/ ANSI C63.4		Input/Output	Complies
Spurious Emissions at Antenna Terminals	2.1051	RSS 132	22.917	-13dBm E.R.P	Complies
Field Strength of Spurious Emissions	2.1053	RSS 132 section 4.5	22.917	-13dBm E.R.P	Complies
Frequency Stability	2.1055	RSS 132	n.a.	Must stay in band	NA

Frequency stability is not applicable because the device uses a common oscillator to up convert and down convert the RF signal. The EUT does not contain modulation circuitry, or frequency generation, therefore the test was not performed.

2 Equipment under test (E.U.T.)

2.1 Description

Kind of equipment	Node C 843 Node M 843
Andrew Ident. Number	Id.No. 7597047 Id.No. 7599014
Serial no.(SN)	11
Revision	00
Software version and ID	V 1.2.5 Id.No. 7517922-03
Type of modulation and Designator	CDMA (F9W) <input checked="" type="checkbox"/> W-CDMA (F9W) <input checked="" type="checkbox"/>
Frequency Translation	F1-F1 <input checked="" type="checkbox"/> F1-F2 <input type="checkbox"/> N/A <input type="checkbox"/>
Band Selection	Software <input checked="" type="checkbox"/> Duplexer <input type="checkbox"/> Full band <input type="checkbox"/>

2.1.1 Downlink

Pass band	869 MHz – 894 MHz
Maximum rated output power	43,0 dBm (± 2) = 20 W
Gain	103 dB

2.1.2 Uplink

Pass band	824 MHz – 849 MHz
Maximum rated output power	26,2 dBm (± 2) = 0,42 W
Gain	103 dB

2.1.3 Description of EUT

The Andrew Node C 843 is an RF enhancer for CDMA systems with up to 20 MHz of adjacent spectrum. The Andrew Node M 843 is an RF enhancer for UMTS systems with up to 4 adjacent carriers. Features and functions may be locally or remotely monitored and changed via a web browser.

Test Site:
 FCC Test Site No.: 96997
 IC OATS No.: IC3475A-1

2.1.4 System diagram of EUT

Scenario 1: 3 Sector Coverage for suburban and urban wide area coverage

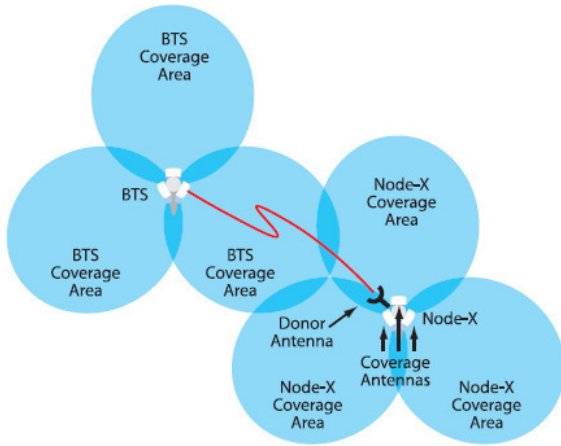

Scenario 2: Road and Rail Coverage

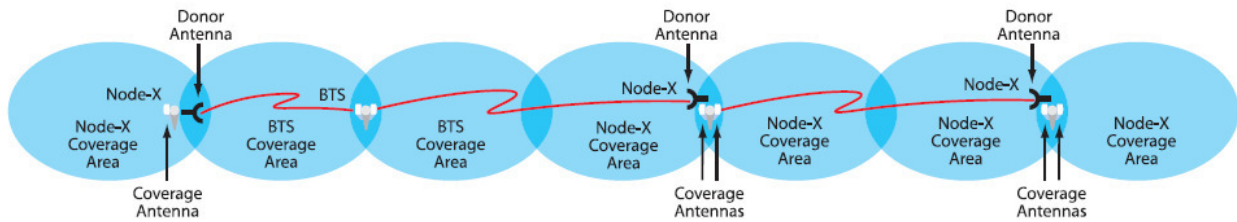

Scenario 3: Urban hole filling and speed enhancement

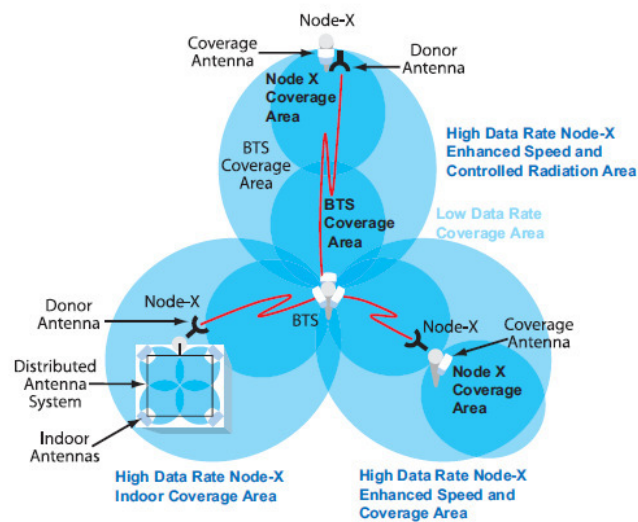

figure 2.1.4-#1 System diagram of EUT: Node X = Node C 843 / Node M 843

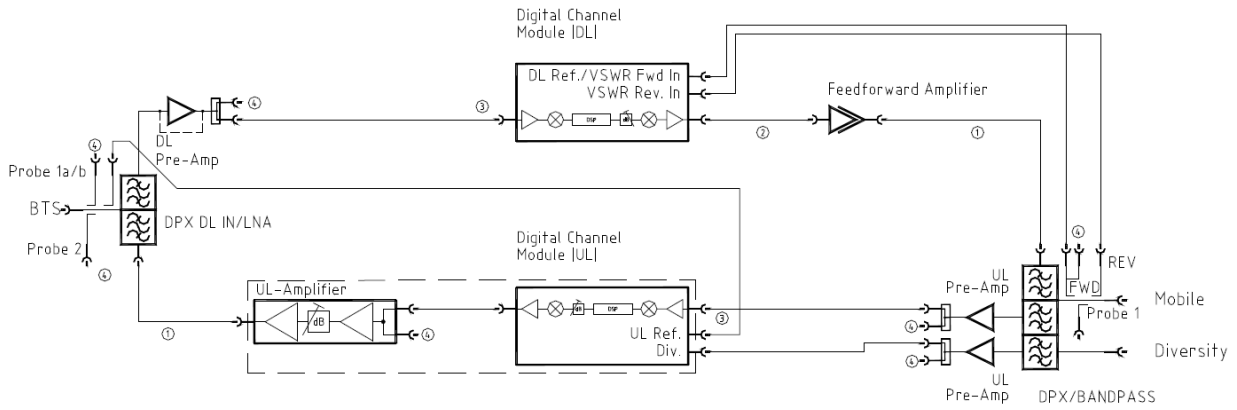

figure 2.1.4-#2 System diagram of EUT: Remote details

Test Site:
 FCC Test Site No.: 96997
 IC OATS No.: IC3475A-1

3 Test site

3.1 Test environment

All tests were performed under the following environmental conditions:

Condition	Minimum value	Maximum value
Barometric pressure	86 kPa	106 kPa
Temperature	15 °C	30 °C
Relative Humidity	20 %	75 %
Power supply range	±5% of rated voltages	

3.2 Test equipment

ANDREW Inv. No.	Test equipment	Type	Manufacturer	Serial No.	Calibration
8917	Network Analyzer	ZVCE8	R&S	827712/009	01/10
8845	Spectrum Analyzer	FSP13	R&S	100387	04/10
8736	Spectrum Analyzer	FSIQ26	R&S	100290	04/10
8848	Signal Generator	E4438C	Agilent	MY45092504	04/10
8775	Signal Generator	SMIQ03B	R&S	102040	03/10
8671	Power Meter	E4418B	Agilent	GB39513094	06/10
8672	Power Sensor	E9300H	Agilent	US41090179	06/10
7280	Power Attenuator	769-30	Narda	9395	CIU
7130	Power Amplifier	3-Band Amp	Andrew	---	CIU
7119	Divider	2way	Mikom	3512	CIU
7323	Circulator	E10-1FFF	AEROTEK	25357	CIU
7315	Circulator	E10-1FFF	AEROTEK	25344	CIU
7363	RF-Cable	2,0m; N-N	Huber & Suhner	28439/4PEA	CIU
7295	RF-Cable	2,5m; N-N	Huber & Suhner	28964/4PEA	CIU
7299	RF-Cable	2,5m; N-N	Huber & Suhner	28964/4PEA	CIU
7364	RF-Cable	1,0m; SMA	Huber & Suhner	36309/4P	CIU
7365	RF-Cable	1,0m; SMA	Huber & Suhner	36292/4P	CIU
7366	RF-Cable	2,0m; SMA	Huber & Suhner	36183/4P	CIU
7367	RF-Cable	2,0m; SMA	Huber & Suhner	36158/4P	CIU
7373	RF-Cable	Multiflex141 0,6m	Andrew	---	CIU
7374	RF-Cable	Multiflex141 0,6m	Andrew	---	CIU

CIU = Calibrate in use

3.3 Input and output losses

All recorded power levels should be referenced to the input and output connectors of the repeater, unless explicitly stated otherwise.

The test equipment used in this test has to be calibrated, so that the functionality is also checked.

All cables, attenuators, splitter, isolator, circulator and combiner etc. must be measured before testing and used for compensation during testing.



Test Site:
 FCC Test Site No.: 96997
 IC OATS No.: IC3475A-1

4 RF Power Out: §22.913, §2.1046

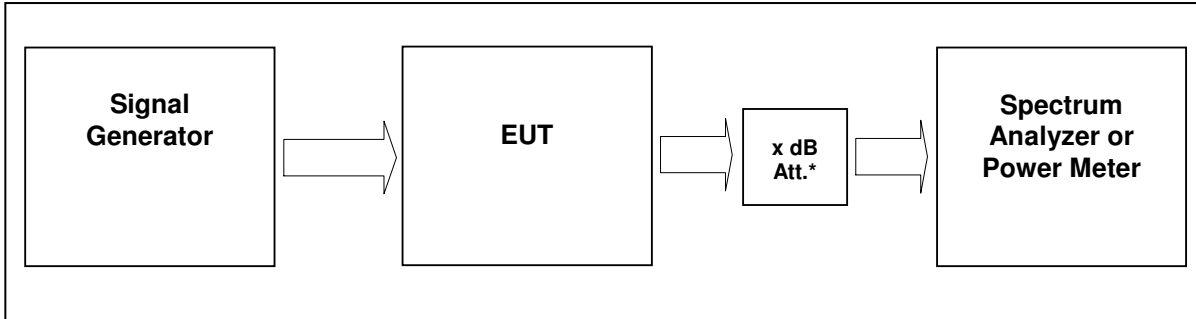

External Attenuator DL x dB = 30 dB
 External Attenuator UL x dB = 30 dB
 figure 3.3-#1 Test setup: RF Power Out: §22.913, §2.1046

Measurement uncertainty	± 0,38 dB
Test equipment used	8848, 7323, 7366, 7130, 7367, 7299, 7280, 7363, 8845

4.1 Limit

Minimum standard:
 Para. No.22.913

The effective radiated power (ERP) of transmitters in the Cellular Radiotelephone Service must not exceed the limits in this section.

(a) *Maximum ERP.* In general, the effective radiated power (ERP) of base transmitters and cellular repeaters must not exceed 500 Watts. However, for those systems operating in areas more than 72 km (45 miles) from international borders that:

- (1) Are located in counties with population densities of 100 persons or fewer per square mile, based upon the most recently available population statistics from the Bureau of the Census; or,
- (2) Extend coverage on a secondary basis into cellular unserved areas, as those areas are defined in § 22.949, the ERP of base transmitters and cellular repeaters of such systems must not exceed 1000 Watts. The ERP of mobile transmitters and auxiliary test transmitters must not exceed 7 Watts.

4.2 Test method

§ 2.1046 Measurements required: RF power output.

(a) For transmitters other than single sideband, independent sideband and controlled carrier radiotelephone, power output shall be measured at the RF output terminals when the transmitter is adjusted in accordance with the tune-up procedure to give the values of current and voltage on the circuit elements specified in § 2.1033(c)(8). The electrical characteristics of the radio frequency load attached to the output terminals when this test is made shall be stated.

(c) For measurements conducted pursuant to paragraphs (a) and (b) of this section, all calculations and methods used by the applicant for determining carrier power or peak envelope power, as appropriate, on the basis of measured power in the radio frequency load attached to the transmitter output terminals shall be shown. Under the test conditions specified, no components of the emission spectrum shall exceed the limits specified in the applicable rule parts as necessary for meeting occupied bandwidth or emission limitations



Test Site:
 FCC Test Site No.: 96997
 IC OATS No.: IC3475A-1

4.3 Test results

Test signal CDMA2000:
 Signal waveform according to table 6.2-1 of standard specification 3GPP2 C.p0051-0 v1.0
 16.February 2006 pilot, sync, paging, 37 traffics, which is equal to the table 6.5.2.1 of 3GPP2 C.S0010-C
 v2.0 24.February 2006.

Test signal WCDMA:
 Signal waveform according to Test Model 1 clause 6.1.1.1 of standard specification 3GPP TS25.141
 v8.8.0 (2009-09). Signal modulated with a combination of PCCPCH, SCCPCH and Dedicated Physical
 Channels specified as test model 1 64 DPCH.

According to ANSI C63.4 section 13.1 Table 5 for operating frequencies more then 10MHz: The test shall
 be performed at Bottom, Middle, Top frequencies.

4.3.1 Downlink

Modu- lation	RBW VBW Span	Measured at			Power (dBm)	RF Power (W)	Plot -
CDMA	3 MHz 10 MHz 15 MHz		(MHz)	Channel #			4.3.3.1
		Bottom	869,7	1013	42,9	19,5	#1
		Middle	881,52	384	43,0	19,95	#2
		Top	893,31	777	42,7	18,6	#3
WCDMA	10 MHz 10 MHz 50 MHz						4.3.3.2
		Bottom	871,4	4357	43,0	19,95	#1
		Middle	881,4	4407	43,0	19,95	#2
		Top	891,6	4458	43,0	19,95	#3
Maximum output power = 43,0 dBm = 19,95 W							
Limit Maximum output power = 57 dBm = 500 W							

table 4.3.1-#1 RF Power Out: §22.913, §2.1046; Test results; Downlink

Modu- lation	Pin / dBm (Ref. point B)
CDMA	-60,0
WCDMA	-60,0

table 4.3.1-#2 RF Power Out: §22.913, §2.1046; Test results; Downlink; Input power



4.3.2 Uplink

Modulation	RBW VBW Span	Measured at			Power (dBm)	RF Power (W)	Plot -
CDMA	3 MHz 10 MHz 15 MHz		(MHz)	Channel #			4.3.4.1
		Bottom	824,7	1013	23,2	0,21	#1
		Middle	836,52	384	23,1	0,20	#2
		Top	848,31	777	22,4	0,17	#3
WCDMA	10 MHz 10 MHz 50 MHz						4.3.4.2
		Bottom	826,4	4357	23,0	0,2	#1
		Middle	836,4	4407	23,0	0,2	#2
		Top	846,4	4458	23,0	0,2	#3
Maximum output power = 23,2 dBm = 0,21 W							
Limit Maximum output power = 57 dBm = 500 W							

table 4.3.2-#3 RF Power Out: §22.913, §2.1046; Test results; Uplink

Modulation	Pin / dBm (Ref. point B)
CDMA	-80,0
WCDMA	-80,0

table 4.3.2-#4 RF Power Out: §22.913, §2.1046; Test results; Uplink; Input power

Test Site:
FCC Test Site No.: 96997
IC OATS No.: IC3475A-1

4.3.3 Downlink 4.3.3.1 CDMA

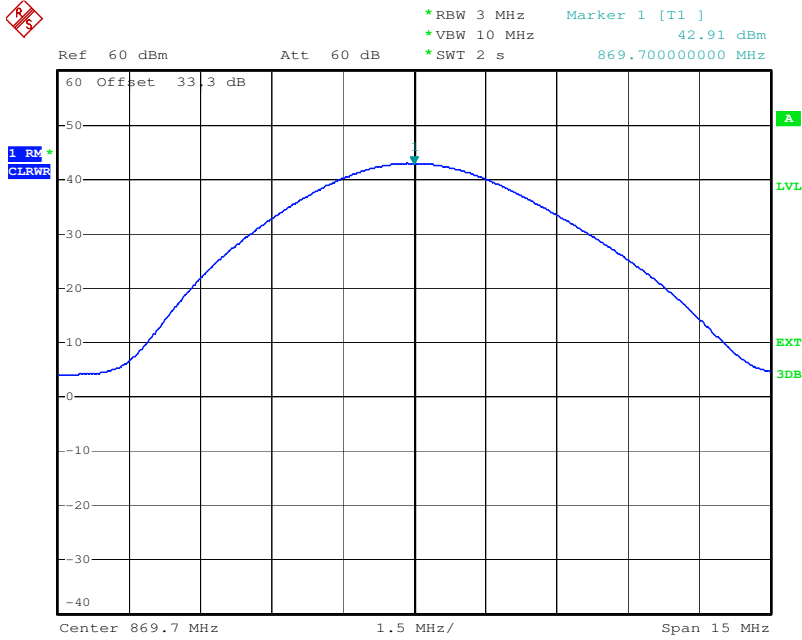

Date: 20.JAN.2010 16:00:56

plot 4.3.3.1-#1 RF Power Out: §22.913, §2.1046; Test results; Downlink; CDMA Bottom

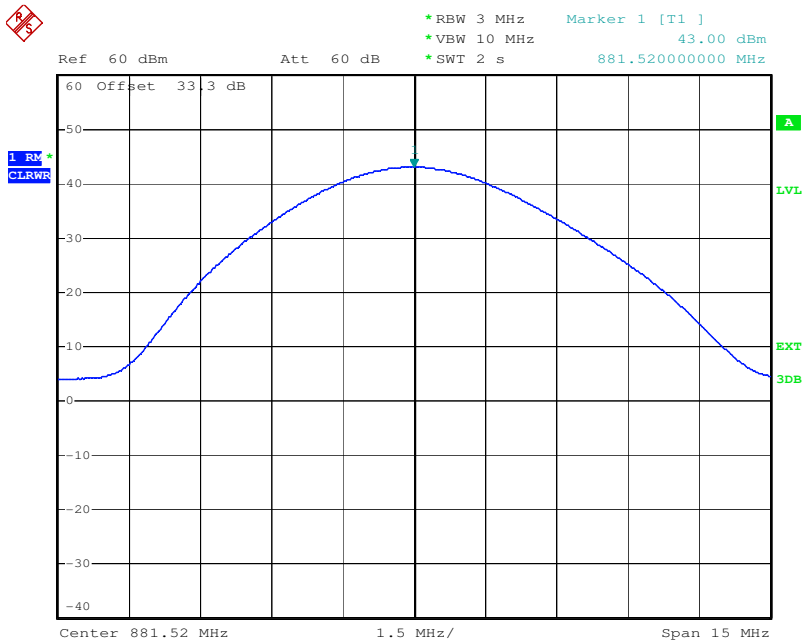

Date: 20.JAN.2010 15:49:10

plot 4.3.3.1-#2 RF Power Out: §22.913, §2.1046; Test results; Downlink; CDMA Middle

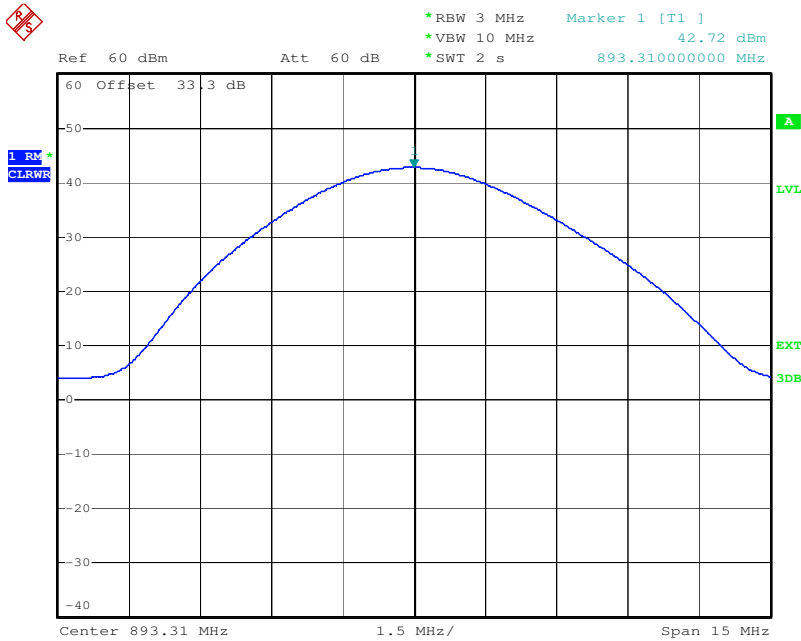

Date: 20.JAN.2010 15:52:53

plot 4.3.3.1-#3 RF Power Out: §22.913, §2.1046; Test results; Downlink; CDMA Top

4.3.3.2 W-CDMA

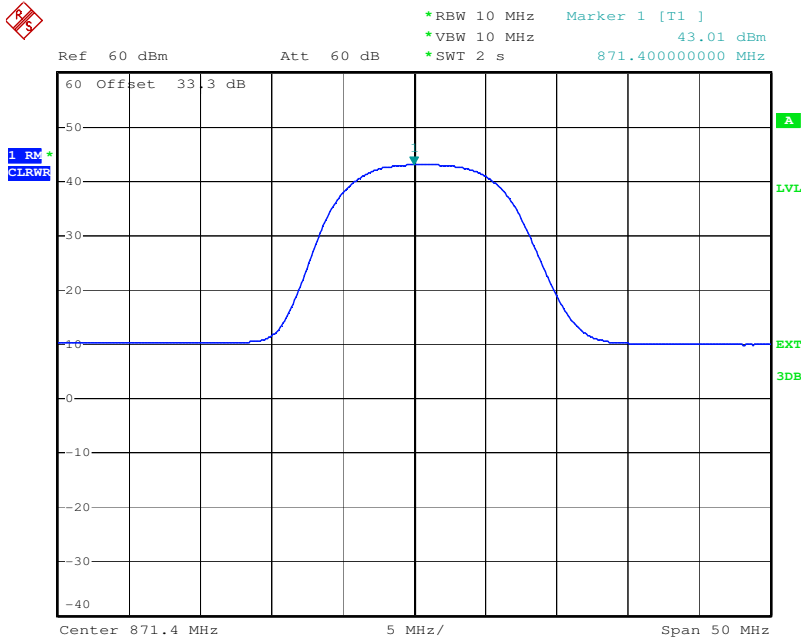

Date: 27.JAN.2010 10:40:28

plot 4.3.3.2-#1 RF Power Out: §22.913, §2.1046; Test results; Downlink; W-CDMA Bottom

EMC Test Report No.: 10-031



Test Site:
FCC Test Site No.:
IC OATS No.:

96997
IC3475A-1

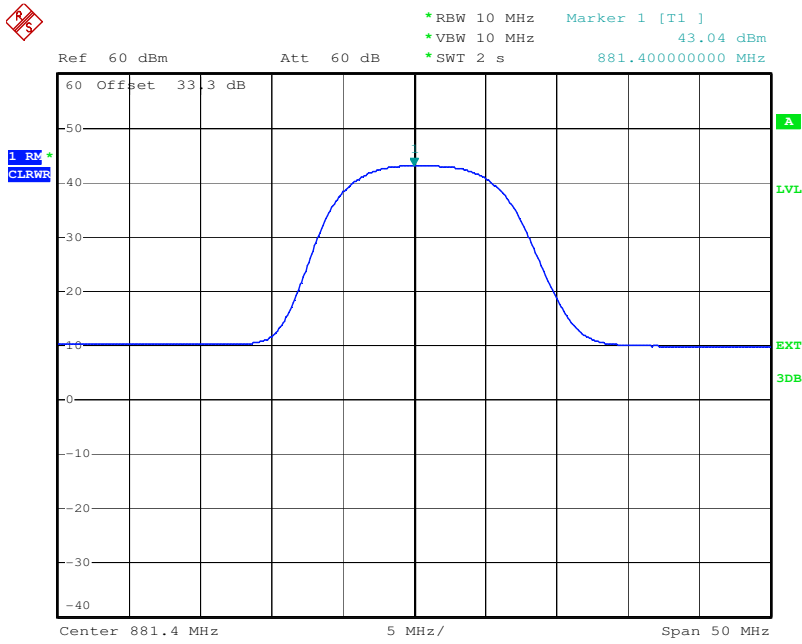

Date: 27.JAN.2010 10:42:44

plot 4.3.3.2-#2 RF Power Out: \$22.913, \$2.1046; Test results; Downlink; W-CDMA Middle

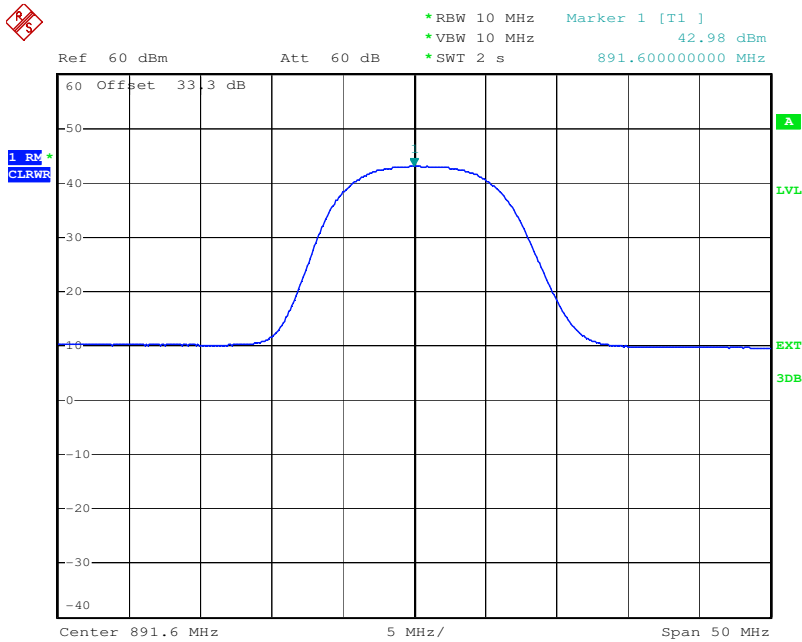

Date: 27.JAN.2010 10:38:28

plot 4.3.3.2-#3 RF Power Out: \$22.913, \$2.1046; Test results; Downlink; W-CDMA Top



Test Site:
FCC Test Site No.: 96997
IC OATS No.: IC3475A-1

4.3.4 Uplink 4.3.4.1 CDMA

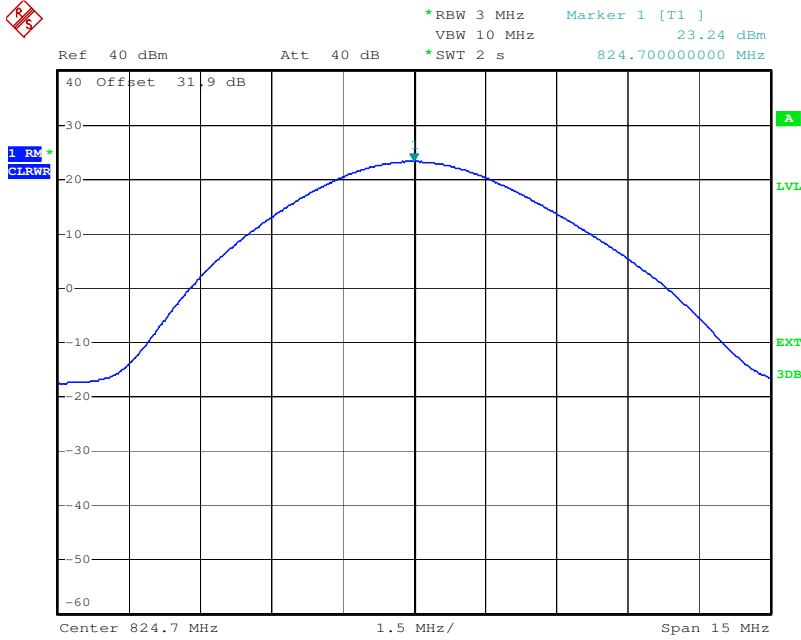

Date: 22.JAN.2010 13:19:37

plot 4.3.4.1-#1 RF Power Out: §22.913, §2.1046; Test results; Uplink; CDMA Bottom

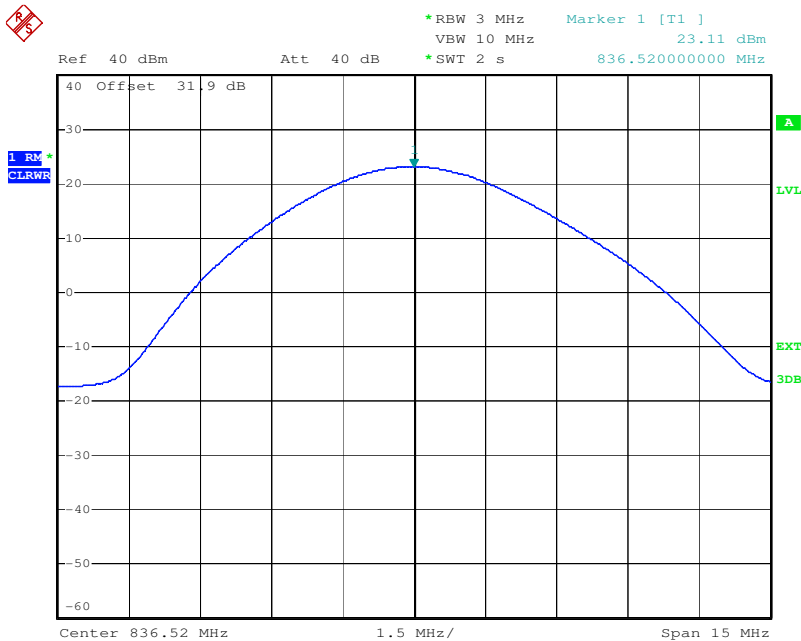

Date: 22.JAN.2010 13:21:15

plot 4.3.4.1-#2 RF Power Out: §22.913, §2.1046; Test results; Uplink; CDMA Middle



Test Site:
FCC Test Site No.: 96997
IC OATS No.: IC3475A-1

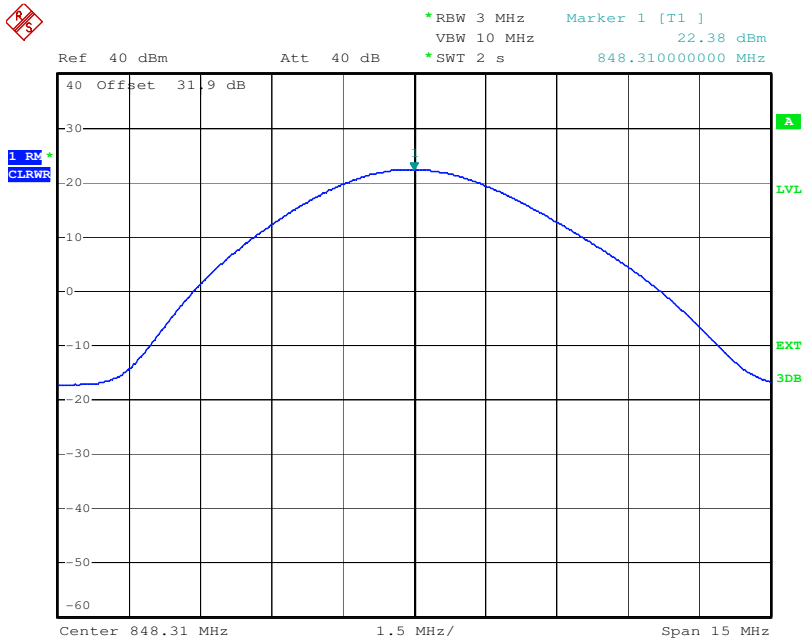

Date: 22.JAN.2010 13:32:35

plot 4.3.4.1-#3 RF Power Out: §22.913, §2.1046; Test results; Uplink; CDMA Top

4.3.4.2 W-CDMA

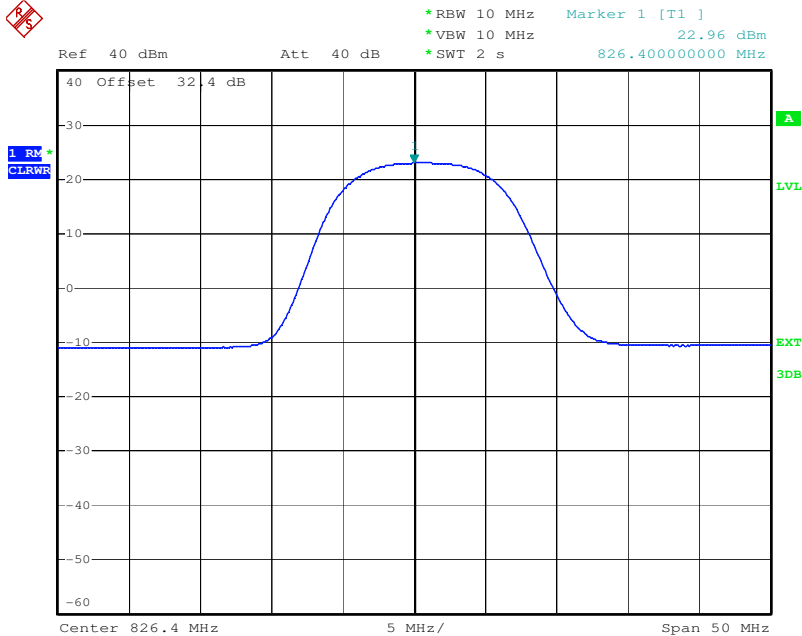

Date: 27.JAN.2010 10:48:21

plot 4.3.4.2-#1 RF Power Out: §22.913, §2.1046; Test results; Uplink; W-CDMA Bottom

EMC Test Report No.: 10-031

Test Site:
FCC Test Site No.: 96997
IC OATS No.: IC3475A-1

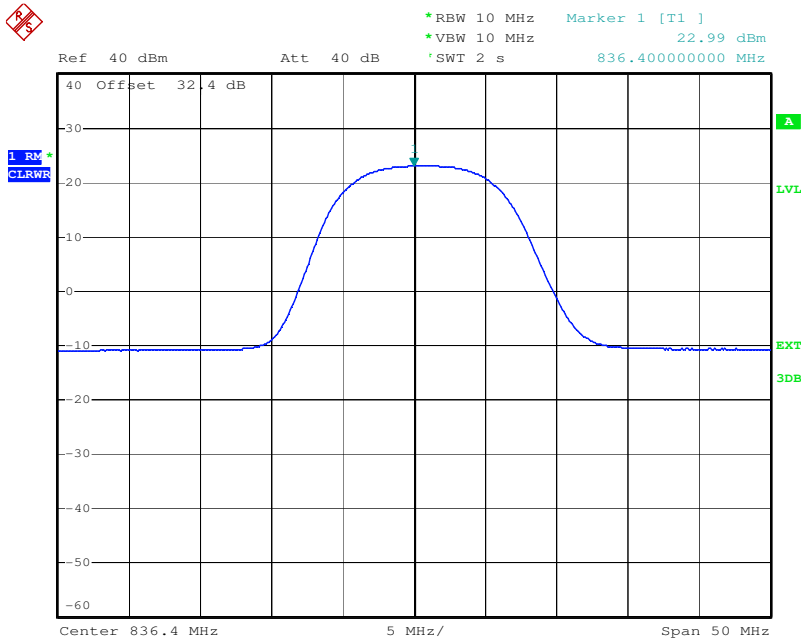

Date: 27.JAN.2010 10:47:19

plot 4.3.4.2-#2 RF Power Out: §22.913, §2.1046; Test results; Uplink; W-CDMA Middle

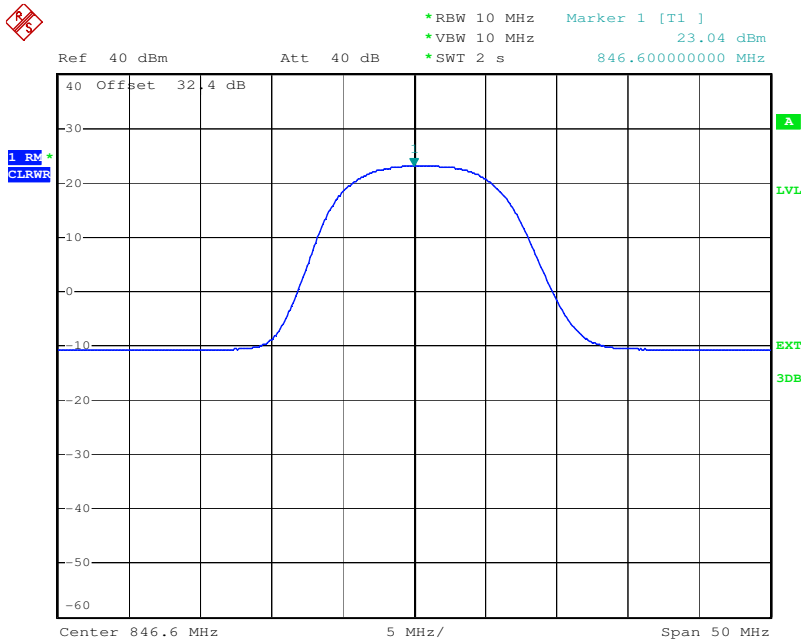

Date: 27.JAN.2010 10:49:29

plot 4.3.4.2-#3 RF Power Out: §22.913, §2.1046; Test results; Uplink; W-CDMA Top

EMC Test Report No.: 10-031



Test Site:
FCC Test Site No.: 96997
IC OATS No.: IC3475A-1

4.4 Summary test result

Test result	complies, according the plots above
Tested by:	Michael Leinfelder
Date:	27.01.2010

Test Site:
 FCC Test Site No.: 96997
 IC OATS No.: IC3475A-1

5 Occupied Bandwidth: §2.1049

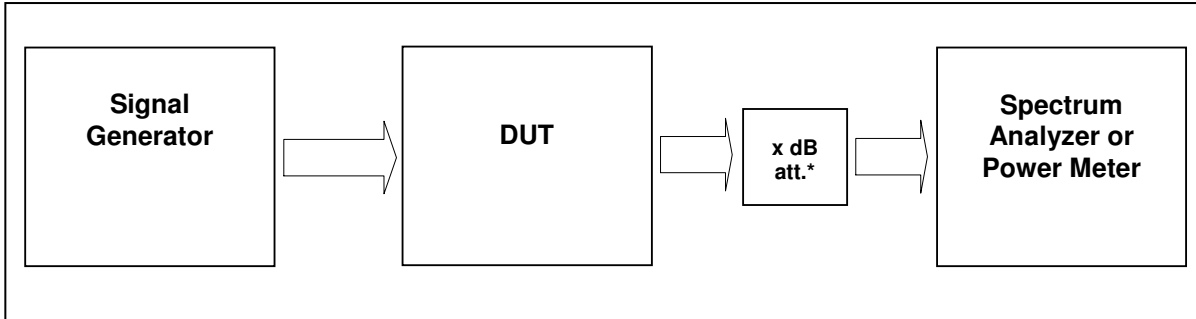

External Attenuator DL x dB = 30 dB
 External Attenuator UL x dB = 30 dB
 figure 4.4-#1 Test setup: Occupied Bandwidth: §2.1049

Measurement uncertainty	± 0,38 dB
Test equipment used	8848, 7323, 7366, 7130, 7367, 7299, 7280, 7363, 8845

5.1 Limit

The spectral shape of the output should look similar to input for all modulations.

5.2 Test method

Para. No.2.1049

The occupied bandwidth, that is the frequency bandwidth such that, below its lower and above its upper frequency limits, the mean powers radiated are each equal to 0.5 percent of the total mean power radiated by a given emission shall be measured under the following conditions as applicable:

Test Site:
 FCC Test Site No.: 96997
 IC OATS No.: IC3475A-1

5.3 Test results

For composite power measurements: Detector RMS.

Modulation	Link	Measured at			RBW VBW Span	Occupied Bandwidth / MHz	Plot #
			/ MHz	Channel Number			
CDMA	Downlink						5.3.1.1
		Middle	881,52	384	10kHz 300kHz min. 3 MHz	1,24	#1, #2
WCDMA	Downlink						5.3.1.2
		Middle	881,4	4407	30kHz 300kHz 10 MHz	4,0	#1, #2
CDMA	Uplink						5.3.2.1
		Middle	836,52	384	10kHz 300kHz min. 3 MHz	1,23	#1, #2
WCDMA	Uplink						5.3.2.2
		Middle	836,4	4407	30kHz 300kHz 10 MHz	4,0	#1, #2

table 5.3-#1 Occupied Bandwidth: §2.1049 Test results

CDMA
 RBW=VBW=30 kHz Span: 5 MHz Sweep: Auto
GSM / EDGE
 RBW=VBW= 3 kHz Span: 1 MHz Sweep: Auto
TDMA
 RBW=VBW= 1 kHz Span: 1 MHz Sweep: Auto
W-CDMA
 RBW=VBW= 100 kHz Span: 10 MHz Sweep: Auto



5.3.1 Downlink
 5.3.1.1 CDMA

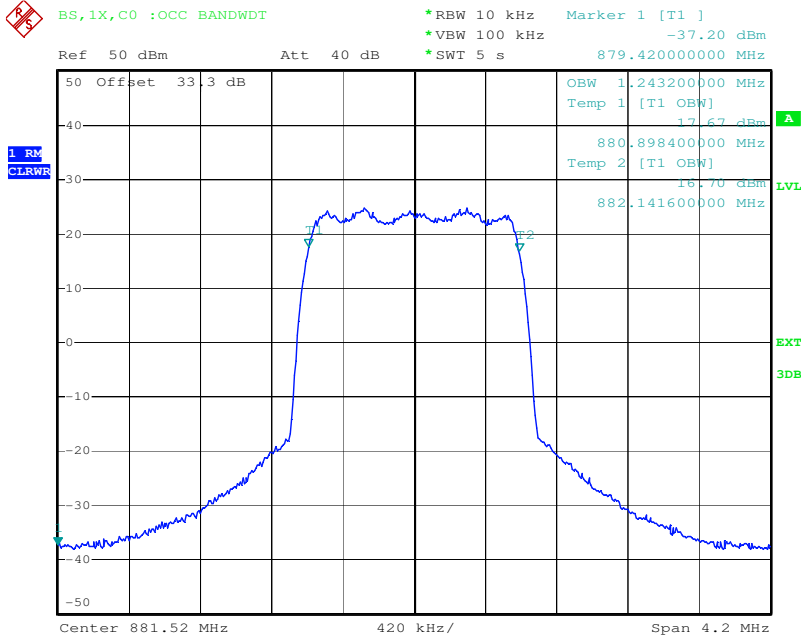

Date: 25.JAN.2010 13:15:42

plot 5.3.1.1-#1 Occupied Bandwidth: §2.1049; Test results; Downlink; CDMA Output; Middle

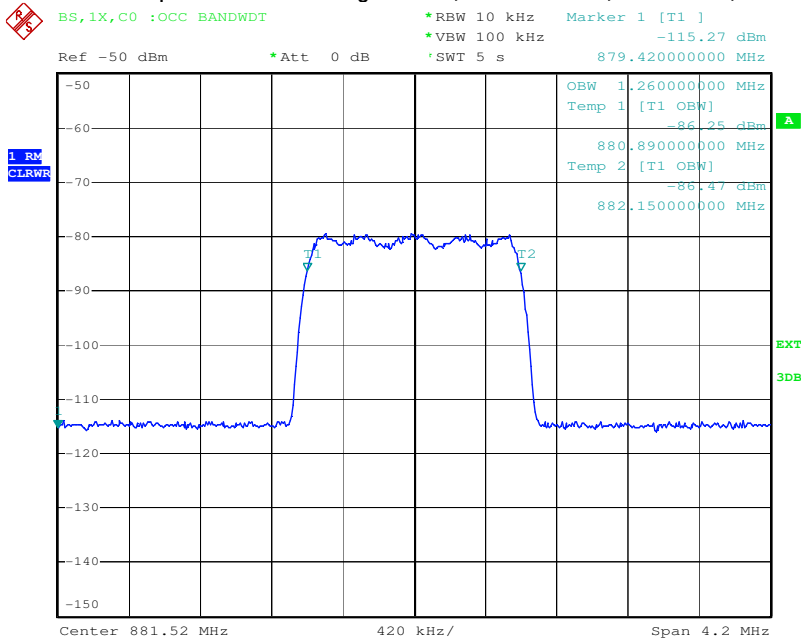

Date: 25.JAN.2010 13:26:23

plot 5.3.1.1-#2 Occupied Bandwidth: §2.1049; Test results; Downlink; CDMA Input; Middle



5.3.1.2 W-CDMA

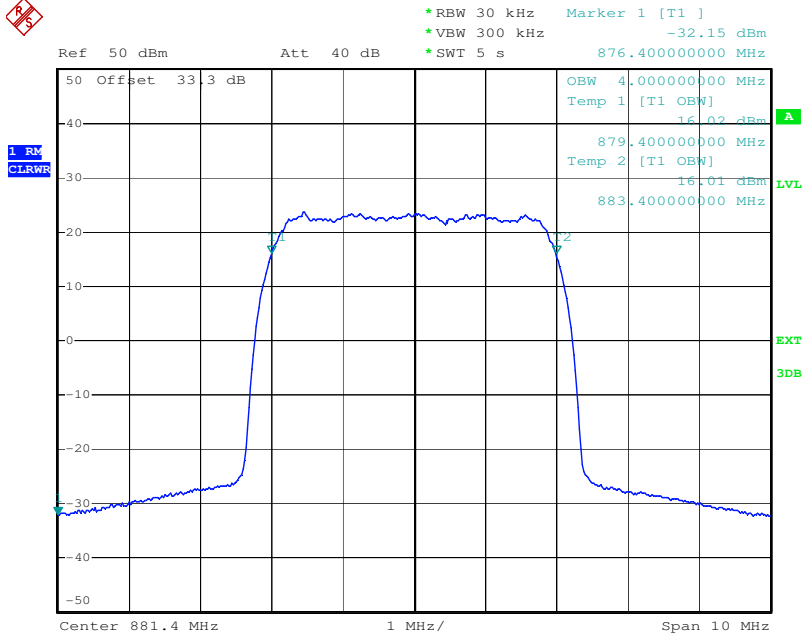

Date: 27.JAN.2010 11:35:08

plot 5.3.1.2-#1 Occupied Bandwidth: §2.1049; Test results; Downlink; W-CDMA Output; Middle

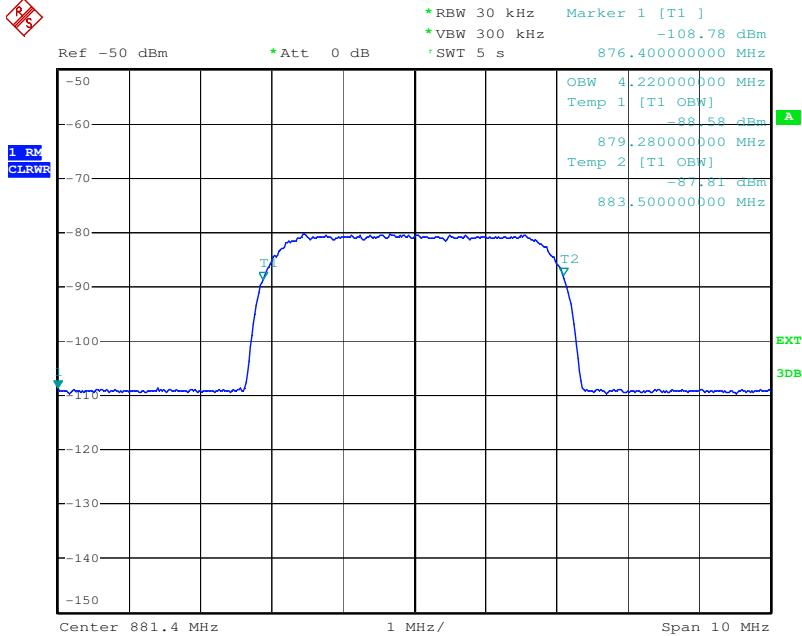

Date: 27.JAN.2010 11:37:58

plot 5.3.1.2-#2 Occupied Bandwidth: §2.1049; Test results; Downlink; W-CDMA Input; Middle



5.3.2 Uplink
 5.3.2.1 CDMA

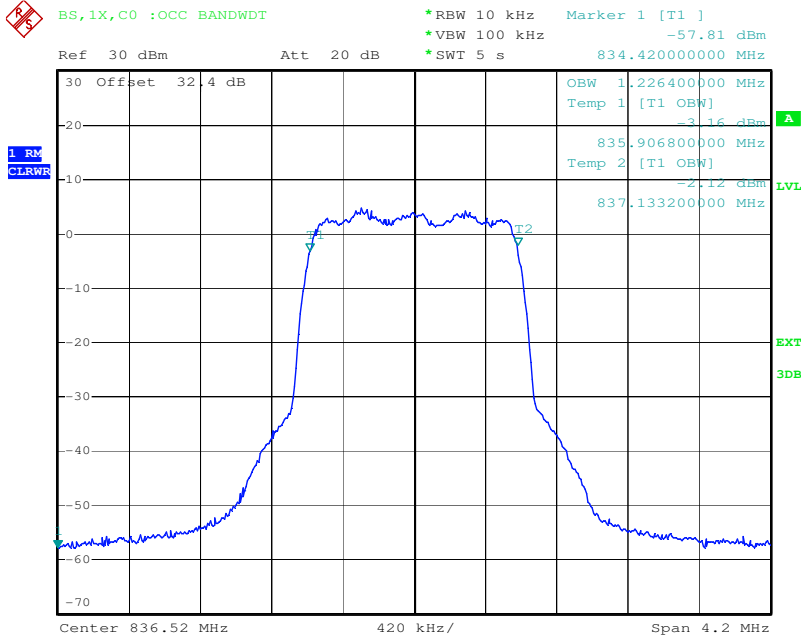

Date: 25.JAN.2010 11:17:40

plot 5.3.2.1-#1 Occupied Bandwidth: §2.1049; Test results; Uplink; CDMA Output; Middle

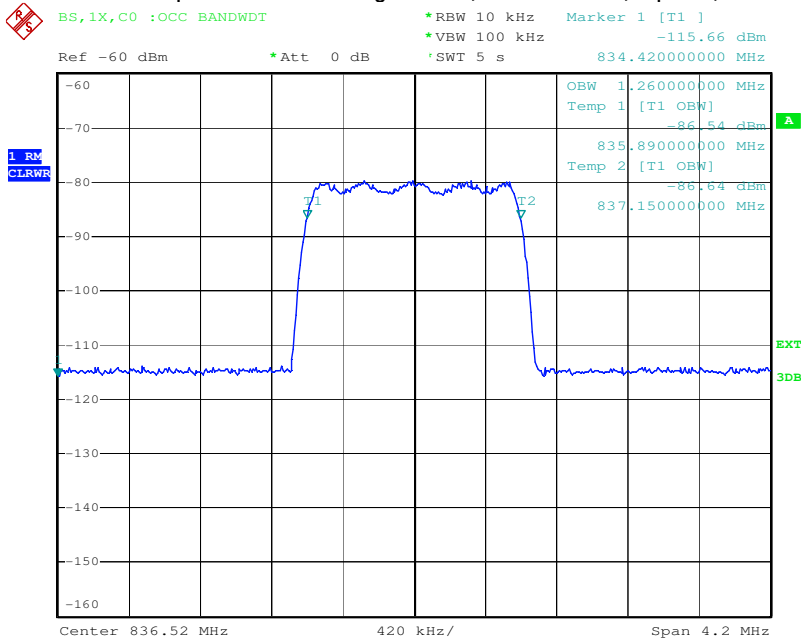

Date: 25.JAN.2010 11:18:53

plot 5.3.2.1-#2 Occupied Bandwidth: §2.1049; Test results; Uplink; CDMA Input (input level +20dBm); Middle



5.3.2.2 W-CDMA

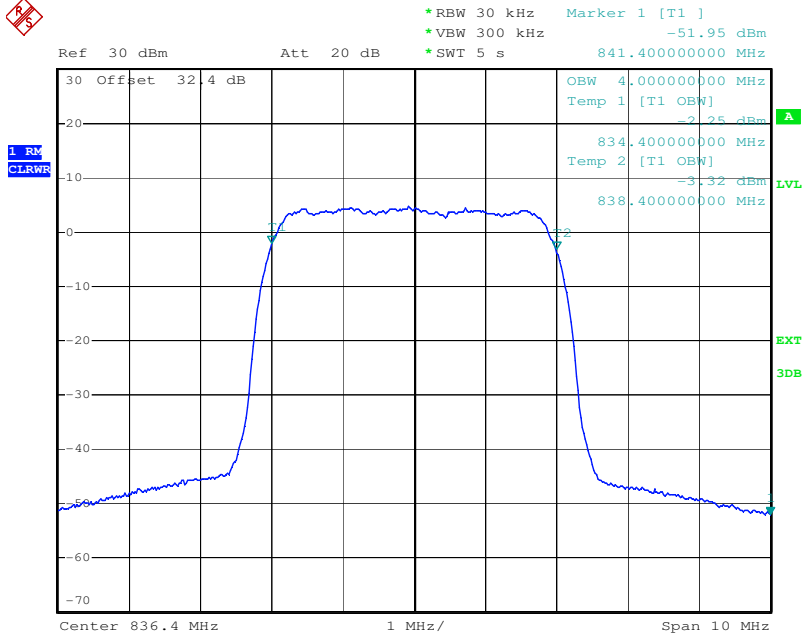

Date: 27.JAN.2010 11:30:53

plot 5.3.2.2-#1 Occupied Bandwidth: §2.1049; Test results; Uplink; W-CDMA Output; Middle

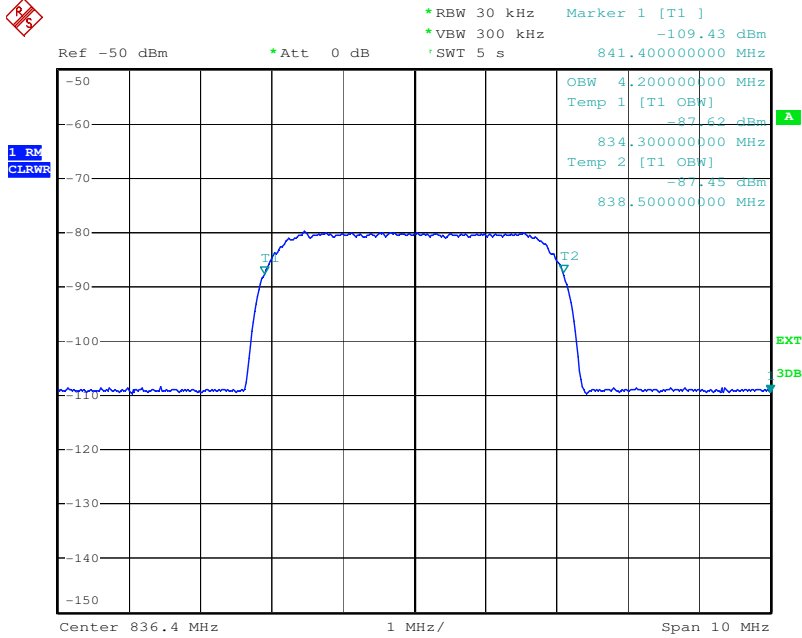

Date: 27.JAN.2010 11:32:48

plot 5.3.2.2-#2 Occupied Bandwidth: §2.1049; Test results; Uplink; W-CDMA Input (input level +20dBm); Middle

Test Site:
FCC Test Site No.: 96997
IC OATS No.: IC3475A-1



5.4 Summary test result

Test result	complies, according the plots above
Tested by:	Michael Leinfelder
Date:	27.01.2010

Test Site:
 FCC Test Site No.: 96997
 IC OATS No.: IC3475A-1

6 Spurious Emissions at Antenna Terminals: §22.917, §2.1051

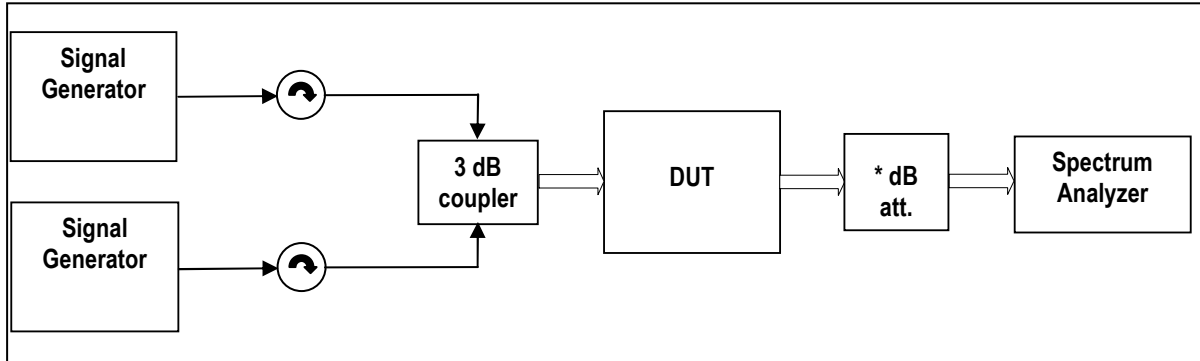

External Attenuator DL x dB = 30 dB
 External Attenuator UL x dB = 30 dB

figure 5.4-#1 Test setup: Spurious Emissions at Antenna Terminals: §22.917, §2.1051

Measurement uncertainty	± 0,54 dB ± 1,2 dB ± 1,5 dB	9 kHz to 3 GHz 3 GHz to 7 GHz 7 GHz to 26 GHz
Test equipment used	8848, 8775, 7323, 7315, 7365, 7366, 7129, 7130, 7119, 7367, 7299, 7280, 7363, 8845, 8736	

6.1 Limit

Minimum standard:
 Para. No.22.917

(a) *Out of band emissions.* The power of any emission outside of the authorized operating frequency ranges must be attenuated below the transmitting power (P) by a factor of at least $43 + 10 \log(P)$ dB.

(b) *Measurement procedure.* Compliance with these rules is based on the use of measurement instrumentation employing a resolution bandwidth of 100 kHz or greater. In the 1 MHz bands immediately outside and adjacent to the frequency block a resolution bandwidth of at least one percent of the emission bandwidth of the fundamental emission of the transmitter may be employed. A narrower resolution bandwidth is permitted in all cases to improve measurement accuracy provided the measured power is integrated over the full required measurement bandwidth (*i.e.* 100 kHz or 1 percent of emission bandwidth, as specified). The emission bandwidth is defined as the width of the signal between two points, one below the carrier center frequency and one above the carrier center frequency, outside of which all emissions are attenuated at least 26 dB below the transmitter power.

6.2 Test method

Para. No 2.1051 Measurements required: Spurious emissions at antenna terminals.

The radio frequency voltage or powers generated within the equipment and appearing on a spurious frequency shall be checked at the equipment output terminals when properly loaded with a suitable artificial antenna. Curves or equivalent data shall show the magnitude of each harmonic and other spurious emission that can be detected when the equipment is operated under the conditions specified in § 2.1049 as appropriate. The magnitude of spurious emissions which are attenuated more than 20 dB below the permissible value need not be specified.

[39 FR 5919, Feb. 15, 1974. Redesignated and amended at 63 FR 36599, July 7, 1998]



Test Site:
 FCC Test Site No.: 96997
 IC OATS No.: IC3475A-1

6.3 Test results

6.3.1 Downlink

<1MHz from Band Edge

Detector: RMS.

Modulation	RBW VBW Span	Measured at			Max. level (dBm)	Plot -
CDMA	30 kHz 300 kHz 6 MHz		(MHz)	Channel #		6.3.3.1
		Bottom	869,73 870,96	1014 32	-16,9	#1
		Top	892,02 893,25	734 775	-20,9	#2
WCDMA	30 kHz 300 kHz 15 MHz		(MHz)	Channel #		6.3.3.2
		Bottom	871,4 876,4	4357 4382	-28,9	#1
		Top	886,6 891,6	4433 4458	-29,4	#2

table 6.3-#1 Spurious Emissions at Antenna Terminals: §22.917, §2.1051 Test results; Downlink; <1MHz from Band Edge

>1MHz from Band Edge

Detector: RMS.

Modulation	Measured at			Frequency range	Max. level (dBm)	Plot -
CDMA		(MHz)	Channel #			6.3.3.3
	Bottom	869,73 870,96	1013 32	30MHz – 1GHz 1GHz – 13,6GHz	-34,2 -24,4	#1 #2
		Middle	881,52 882,75	384 425	30MHz – 1GHz 1GHz – 13,6GHz	-34,9 -24,7
	Top		892,02 893,25	734 775	30MHz – 1GHz 1GHz – 13,6GHz	-33,7 -24,7
WCDMA						6.3.3.4
	Bottom	871,4 876,4	4357 4382	30MHz – 1GHz 1GHz – 13,6GHz	-29,2 -24,7	#1 #2
		Middle	881,4 886,4	4407 4432	30MHz – 1GHz 1GHz – 13,6GHz	-28,7 -24,5
	Top		886,6 891,6	4433 4458	30MHz – 1GHz 1GHz – 13,6GHz	-29,4 -24,6

table 6.3-#2 Spurious Emissions at Antenna Terminals: §22.917, §2.1051 Test results; Downlink;

Start	Stop	RBW	VBW
30MHz	1GHz	100kHz	300kHz
1GHz	22GHz	1MHz	3MHz

table 6.3-#3 Spurious Emissions at Antenna Terminals: §22.917, §2.1051 Test results; Downlink; RBW, VBW Table



Test Site:
 FCC Test Site No.: 96997
 IC OATS No.: IC3475A-1

6.3.2 Uplink

<1MHz from Band Edge

Detector: RMS.

Modulation	RBW VBW Span	Measured at			Max. level (dBm)	Plot -
			(MHz)	Channel #		
CDMA	30 kHz					6.3.3.1
	300 kHz	Bottom	824,73 825,96	1014 32	-29,7	#1
	6 MHz	Top	847,02 848,25	734 775	-33,8	#2
WCDMA	30 kHz		(MHz)	Channel #		6.3.3.2
	300 kHz	Bottom	826,4 831,4	4357 4382	-37,7	#1
	15 MHz	Top	841,6 846,6	4433 4458	-38,9	#2

table 6.3-#4 Spurious Emissions at Antenna Terminals: §22.917, §2.1051 Test results; Uplink; <1MHz from Band Edge

>1MHz from Band Edge

Detector: RMS.

Modulation	Measured at			Frequency range	Max. level (dBm)	Plot -
		(MHz)	Channel #			
CDMA						6.3.3.3
	Bottom	824,73 825,96	1013 32	30MHz – 1GHz 1GHz – 13,6GHz	-52,7 -45,7	#1 #2
	Middle	836,52 837,75	384 425	30MHz – 1GHz 1GHz – 13,6GHz	-53,7 -45,6	#3 #4
	Top	847,02 848,25	734 775	30MHz – 1GHz 1GHz – 13,6GHz	-53,7 -45,5	#5 #6
WCDMA						6.3.3.4
	Bottom	826,4 831,4	4357 4382	30MHz – 1GHz 1GHz – 13,6GHz	-53,2 -45,5	#1 #2
	Middle	836,4 841,4	4407 4432	30MHz – 1GHz 1GHz – 13,6GHz	-52,5 -45,7	#3 #4
	Top	841,6 846,6	4433 4458	30MHz – 1GHz 1GHz – 13,6GHz	-52,3 -45,6	#5 #6

table 6.3-#5 Spurious Emissions at Antenna Terminals: §22.917, §2.1051 Test results; Uplink;

Start	Stop	RBW	VBW
30MHz	1GHz	100kHz	300kHz
1GHz	22GHz	1MHz	3MHz

table 6.3-#6 Spurious Emissions at Antenna Terminals: §22.917, §2.1051 Test results; Uplink; RBW, VBW Table



6.3.3 Downlink
 6.3.3.1 CDMA < 1MHz to band edge

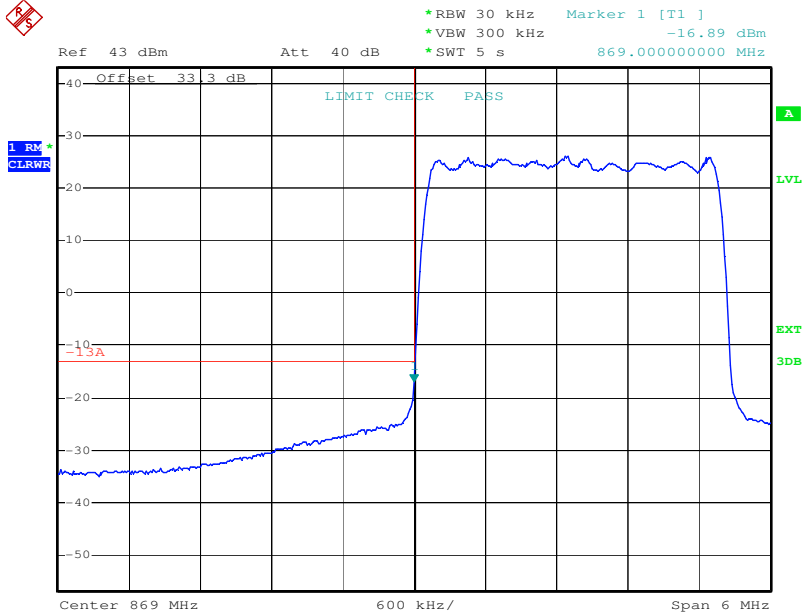

Date: 25.JAN.2010 17:30:54

plot 6.3.3.1-#1 Spurious Emissions at Antenna Terminals: §22.917, §2.1051; Test results; Downlink; CDMA < 1MHz to band edge Lower Band Edge

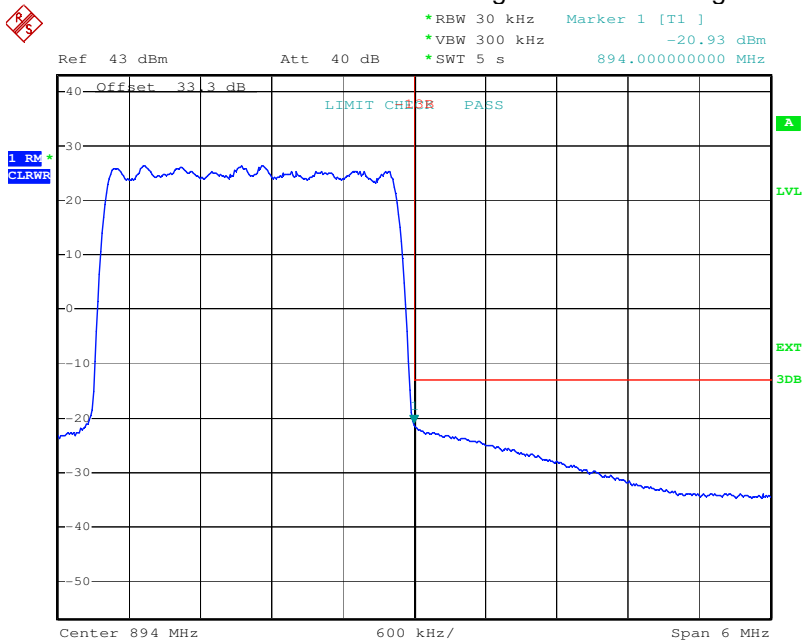

Date: 26.JAN.2010 10:03:09

plot 6.3.3.1-#2 Spurious Emissions at Antenna Terminals: §22.917, §2.1051; Test results; Downlink; CDMA < 1MHz to band edge Upper Band Edge

Test Site:
 FCC Test Site No.: 96997
 IC OATS No.: IC3475A-1

6.3.3.2 W-CDMA < 1MHz to band edge

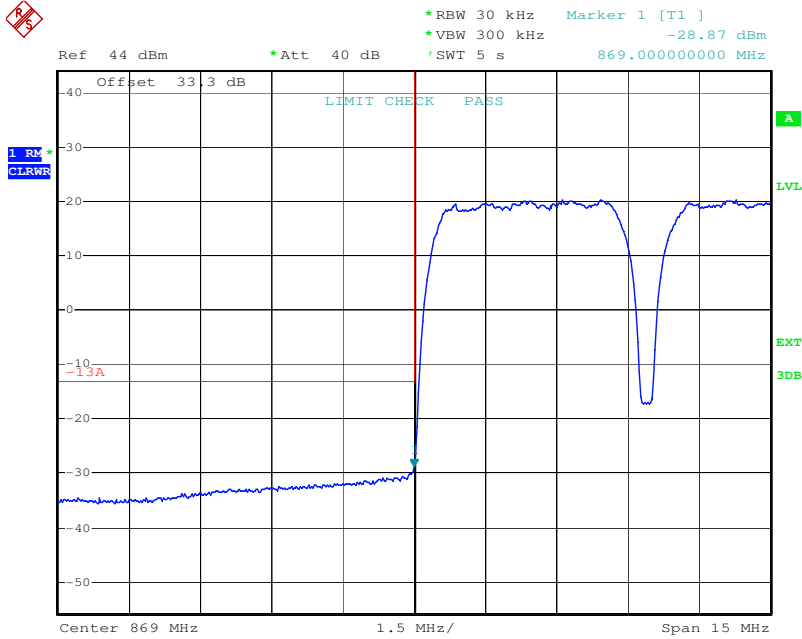

Date: 27.JAN.2010 16:24:46

plot 6.3.3.2-#1 Spurious Emissions at Antenna Terminals: §22.917, §2.1051; Test results; Downlink; W-CDMA < 1MHz to band edge Lower Band Edge

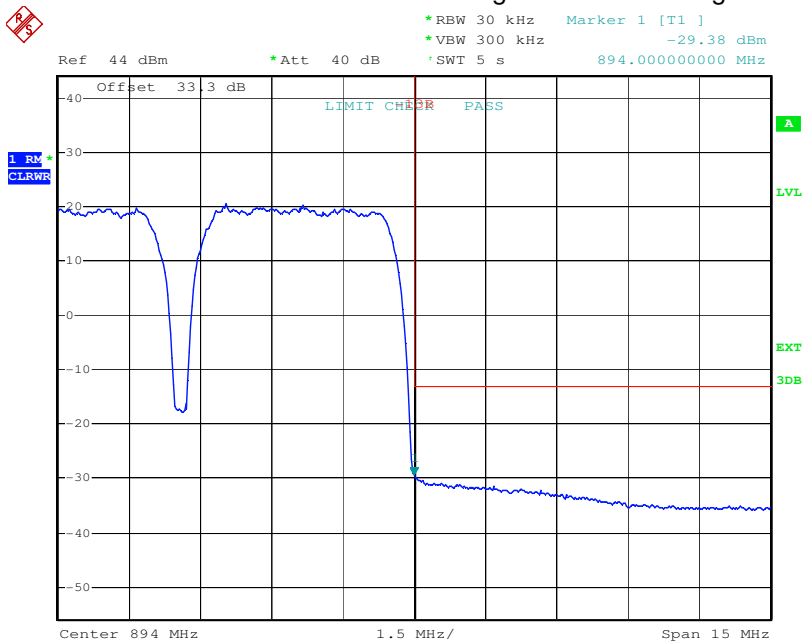

Date: 27.JAN.2010 16:34:55

plot 6.3.3.2-#2 Spurious Emissions at Antenna Terminals: §22.917, §2.1051; Test results; Downlink; W-CDMA < 1MHz to band edge Upper Band Edge



6.3.3.3 CDMA > 1MHz to band edge

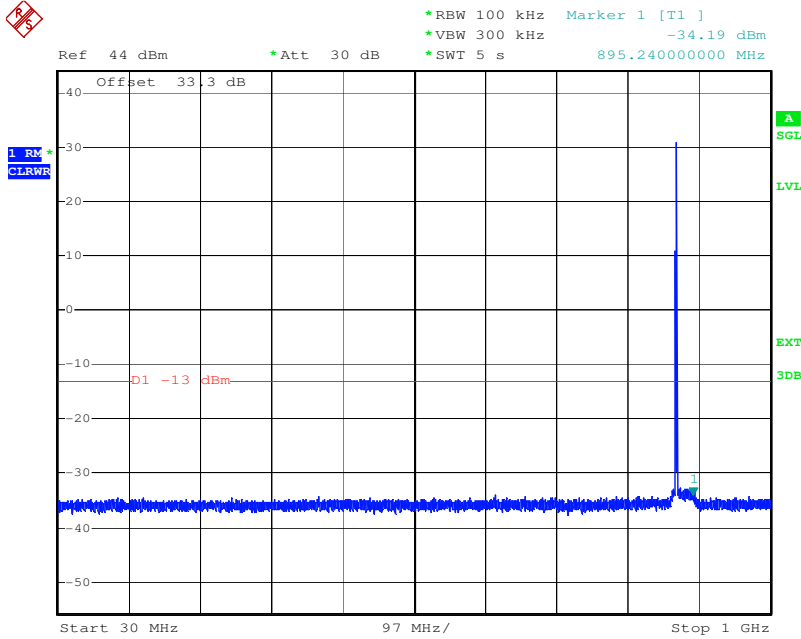

Date: 26.JAN.2010 10:11:44

plot 6.3.3.3-#1 Spurious Emissions at Antenna Terminals: §22.917, §2.1051; Test results; Downlink; CDMA > 1MHz to band edge; Bottom; < 1 GHz

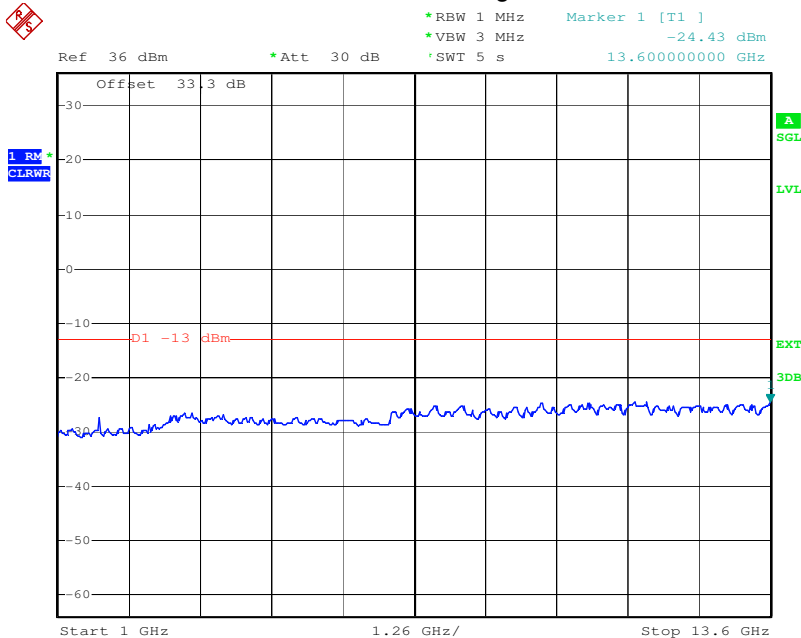

Date: 26.JAN.2010 09:04:11

plot 6.3.3.3-#2 Spurious Emissions at Antenna Terminals: §22.917, §2.1051; Test results; Downlink; CDMA > 1MHz to band edge; Bottom; > 1 GHz

EMC Test Report No.: 10-031

Test Site:
 FCC Test Site No.:
 IC OATS No.:

96997
 IC3475A-1

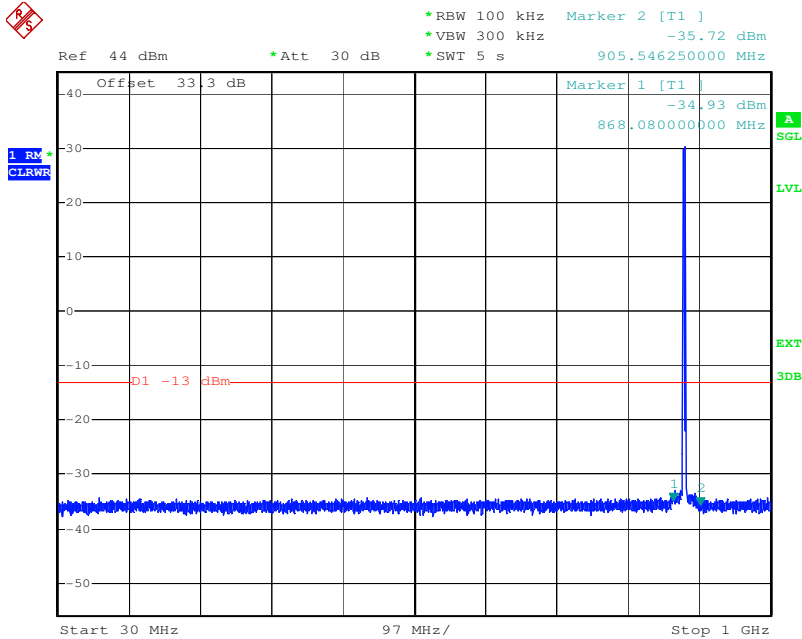

Date: 26.JAN.2010 11:19:44

plot 6.3.3.3-#3 Spurious Emissions at Antenna Terminals: §22.917, §2.1051; Test results; Downlink; CDMA > 1MHz to band edge; Middle; < 1GHz

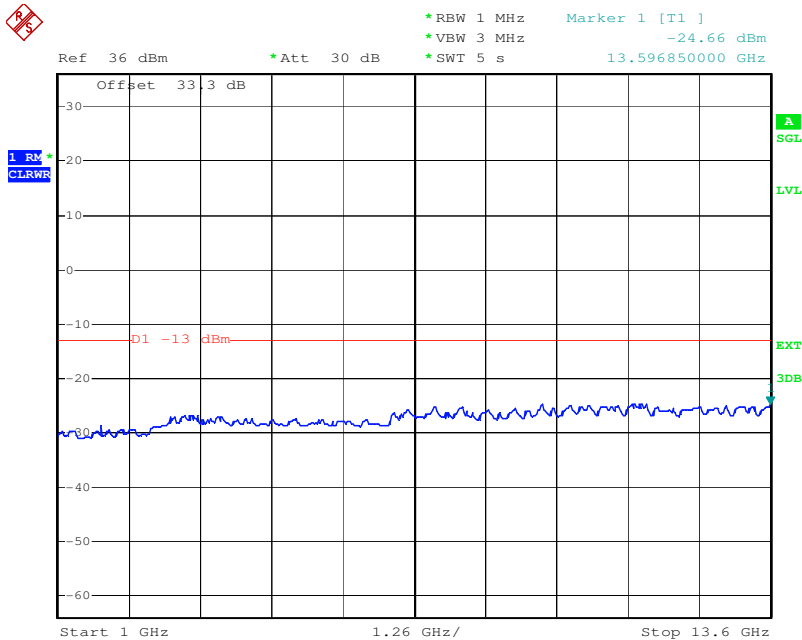

Date: 26.JAN.2010 11:21:13

plot 6.3.3.3-#4 Spurious Emissions at Antenna Terminals: §22.917, §2.1051; Test results; Downlink; CDMA > 1MHz to band edge; Middle; > 1 GHz

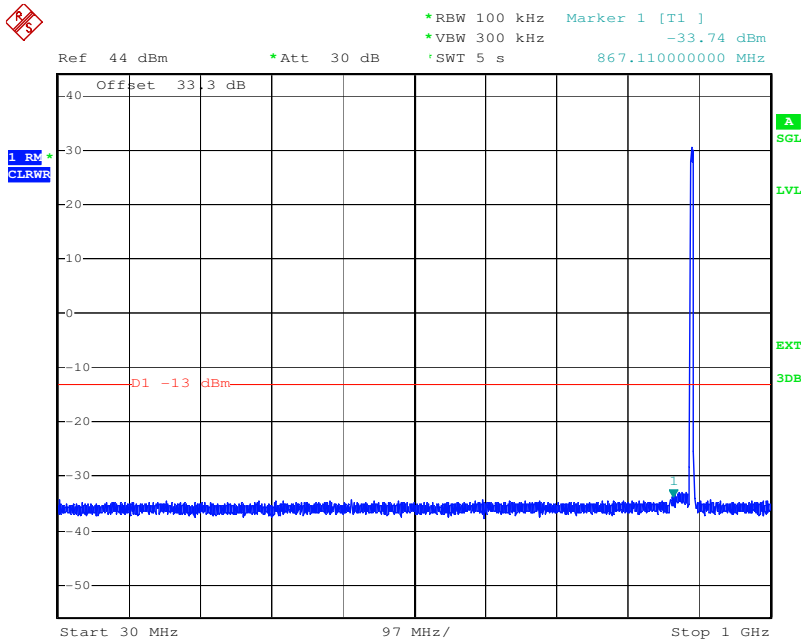

Date: 26.JAN.2010 10:07:38

plot 6.3.3.3-#5 Spurious Emissions at Antenna Terminals: §22.917, §2.1051; Test results; Downlink;
 CDMA > 1MHz to band edge; Top; < 1 GHz

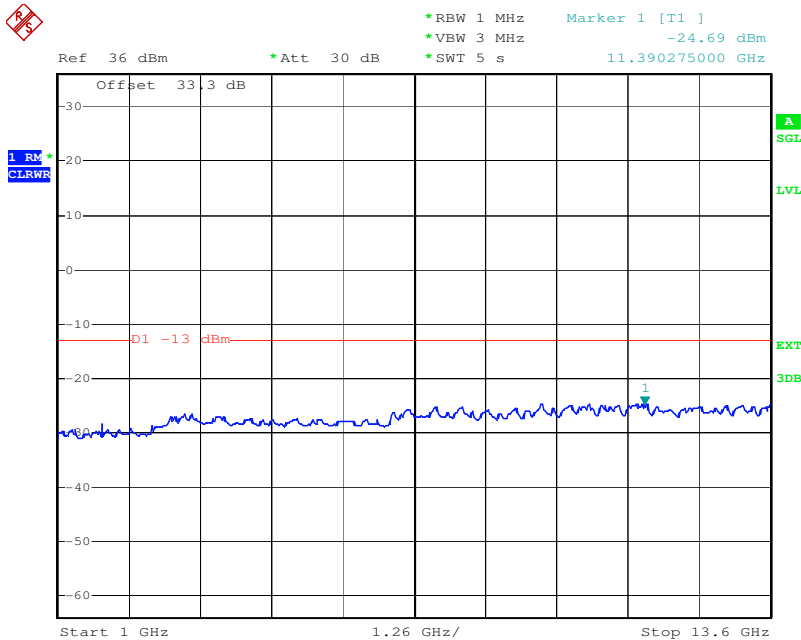

Date: 26.JAN.2010 10:08:40

plot 6.3.3.3-#6 Spurious Emissions at Antenna Terminals: §22.917, §2.1051; Test results; Downlink;
 CDMA > 1MHz to band edge; Top; > 1 GHz



6.3.3.4 W-CDMA > 1MHz to band edge

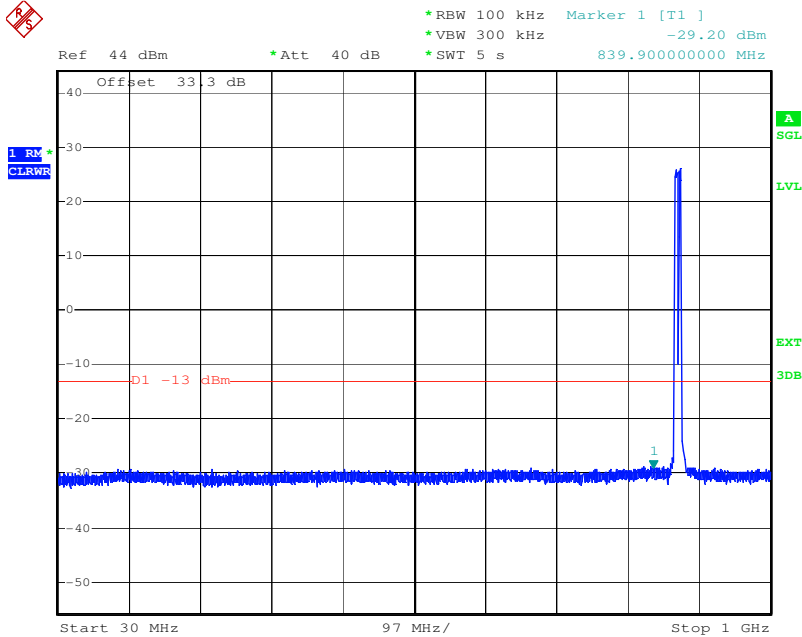

Date: 27.JAN.2010 16:31:39

plot 6.3.3.4-#1 Spurious Emissions at Antenna Terminals: §22.917, §2.1051; Test results; Downlink; W-CDMA > 1MHz to band edge; Bottom; < 1 GHz

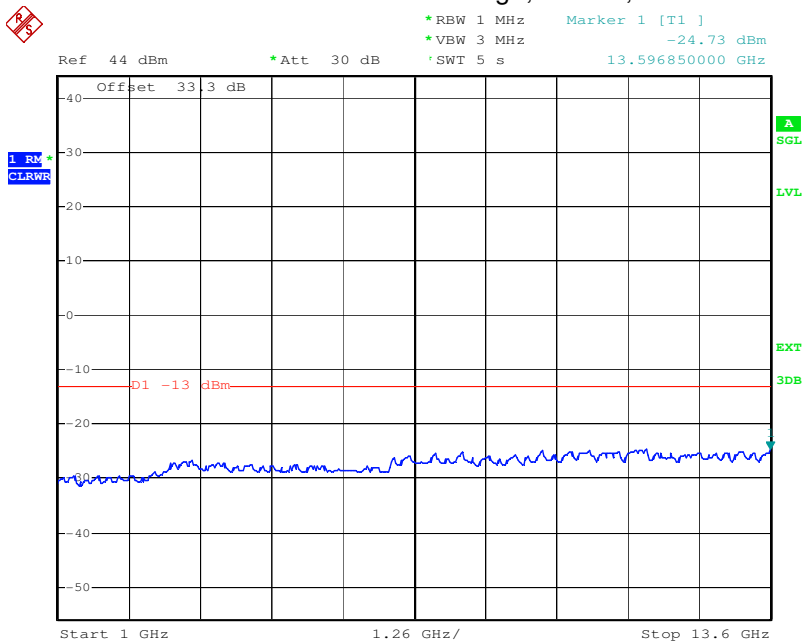

Date: 27.JAN.2010 16:30:10

plot 6.3.3.4-#2 Spurious Emissions at Antenna Terminals: §22.917, §2.1051; Test results; Downlink; W-CDMA > 1MHz to band edge; Bottom; > 1 GHz

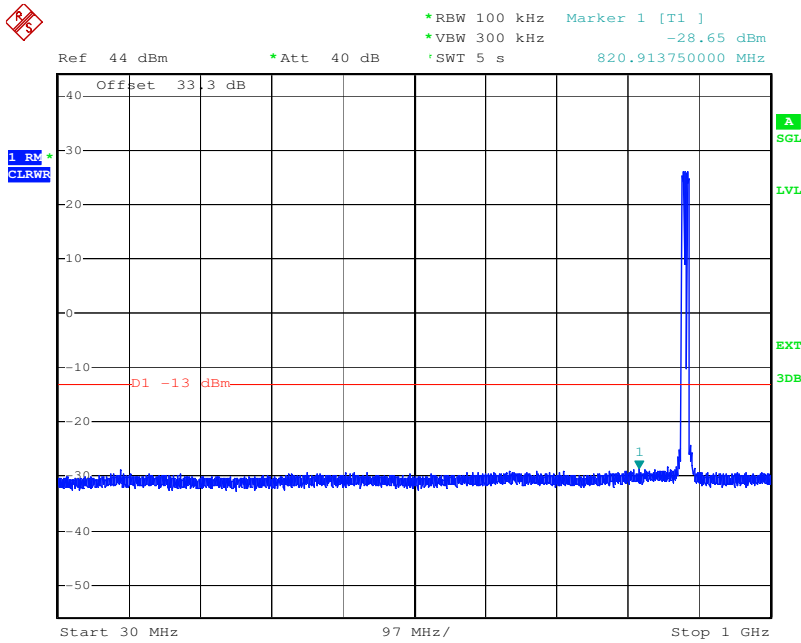

Date: 27.JAN.2010 16:43:13

plot 6.3.3.4-#3 Spurious Emissions at Antenna Terminals: §2.2.917, §2.1051; Test results; Downlink; W-CDMA > 1MHz to band edge; Middle; < 1 GHz

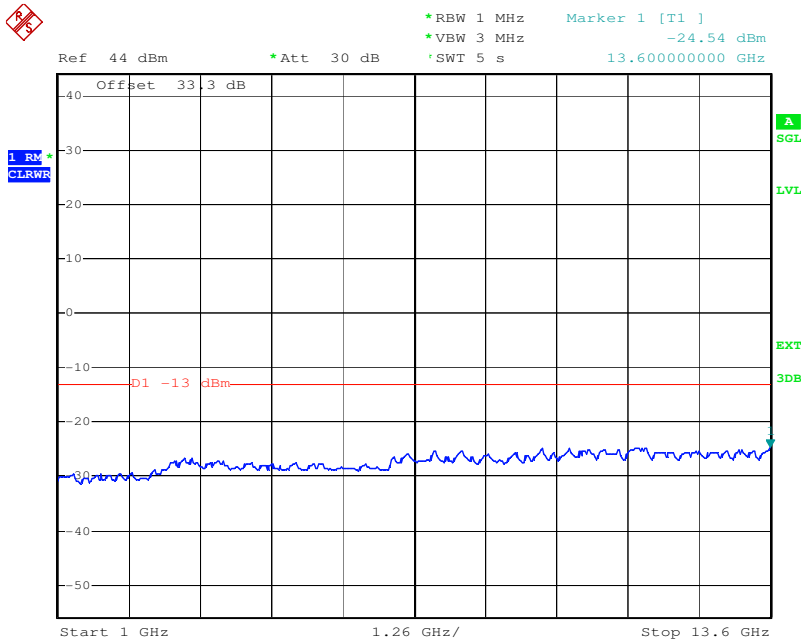

Date: 27.JAN.2010 16:40:21

plot 6.3.3.4-#4 Spurious Emissions at Antenna Terminals: §2.2.917, §2.1051; Test results; Downlink; W-CDMA > 1MHz to band edge; Middle; > 1 GHz

EMC Test Report No.: 10-031

Test Site:
 FCC Test Site No.: 96997
 IC OATS No.: IC3475A-1

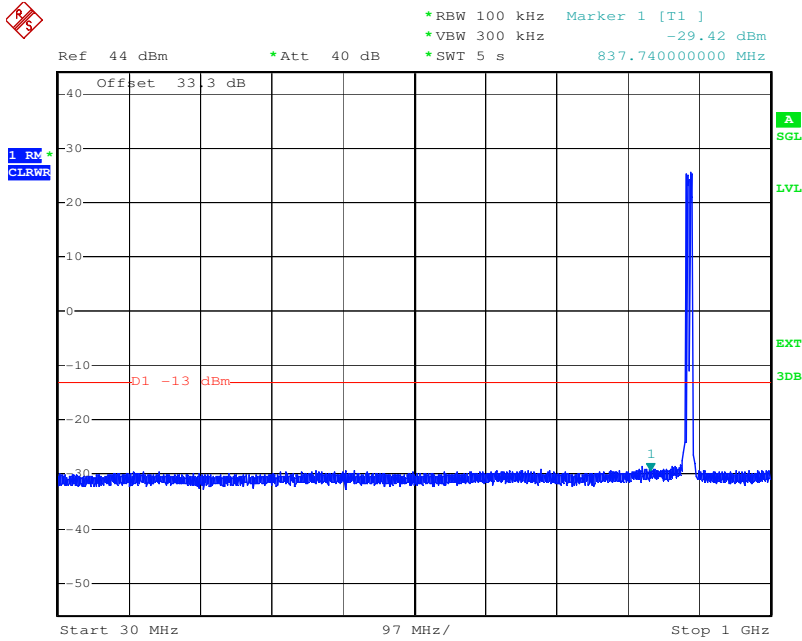

Date: 27.JAN.2010 16:36:31

plot 6.3.3.4-#5 Spurious Emissions at Antenna Terminals: §22.917, §2.1051; Test results; Downlink; W-CDMA > 1MHz to band edge; Top; < 1 GHz

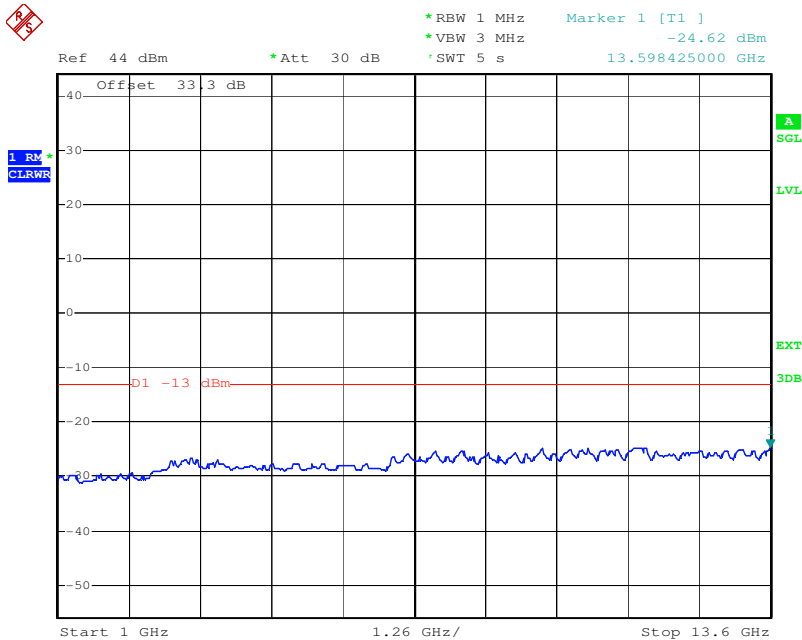

Date: 27.JAN.2010 16:37:07

plot 6.3.3.4-#6 Spurious Emissions at Antenna Terminals: §22.917, §2.1051; Test results; Downlink; W-CDMA > 1MHz to band edge; Top; > 1 GHz



6.3.4 Uplink
 6.3.4.1 CDMA < 1MHz to band edge

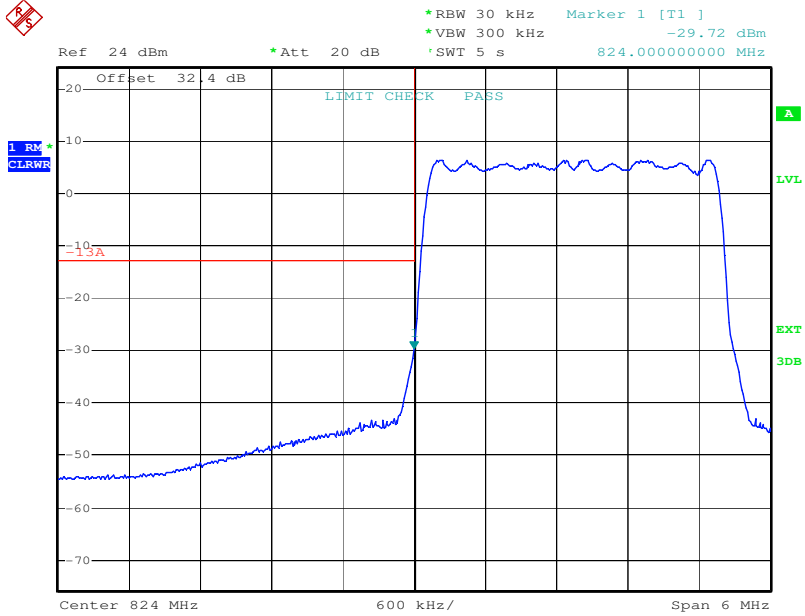

Date: 26.JAN.2010 11:57:09

plot 6.3.4.1-#1 Spurious Emissions at Antenna Terminals: §22.917, §2.1051; Test results; Uplink; CDMA < 1MHz to band edge Lower Band Edge

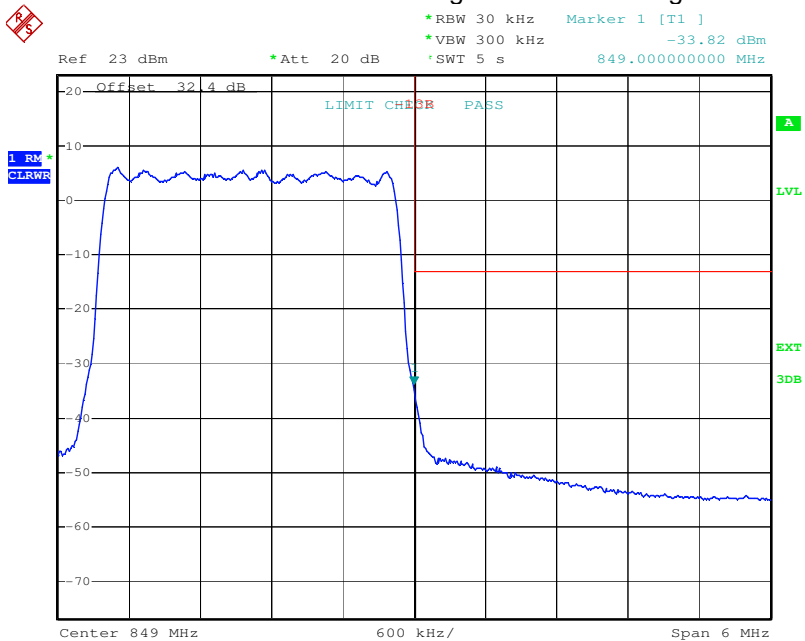

Date: 26.JAN.2010 11:48:39

plot 6.3.4.1-#2 Spurious Emissions at Antenna Terminals: §22.917, §2.1051; Test results; Uplink; CDMA < 1MHz to band edge Upper Band Edge

Test Site:
 FCC Test Site No.: 96997
 IC OATS No.: IC3475A-1

6.3.4.2 W-CDMA < 1MHz to band edge

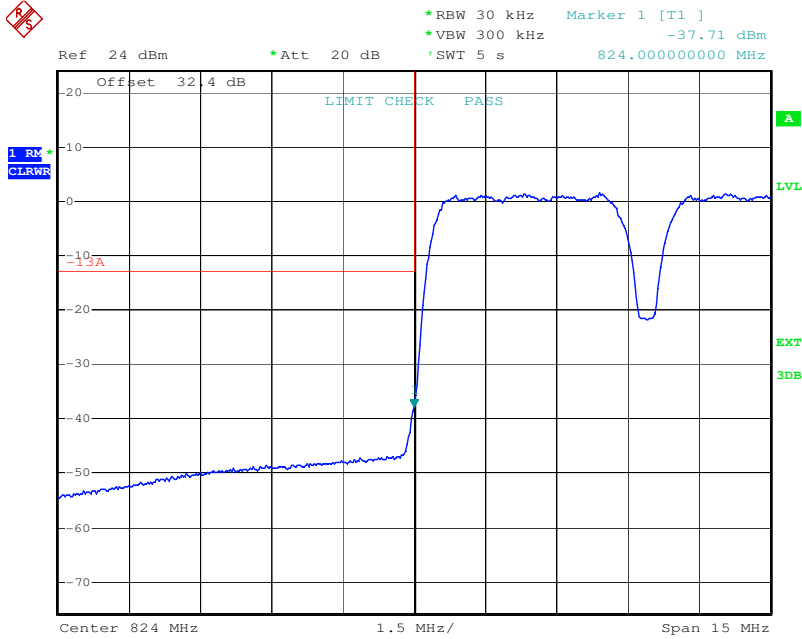

Date: 27.JAN.2010 17:11:40

plot 6.3.4.2-#1 Spurious Emissions at Antenna Terminals: §22.917, §2.1051; Test results; Uplink; W-CDMA < 1MHz to band edge Lower Band Edge

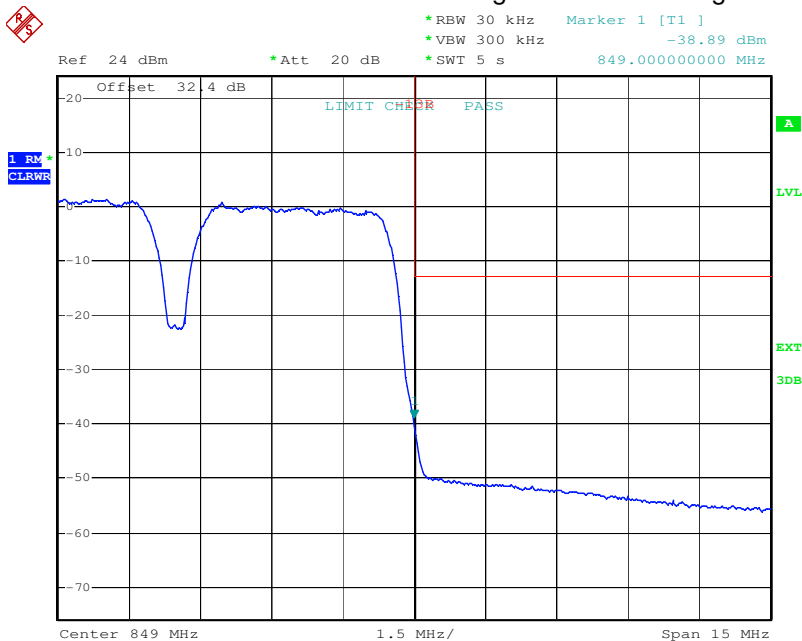

Date: 27.JAN.2010 17:24:22

plot 6.3.4.2-#2 Spurious Emissions at Antenna Terminals: §22.917, §2.1051; Test results; Uplink; W-CDMA < 1MHz to band edge Upper Band Edge



6.3.4.3 CDMA > 1MHz to band edge

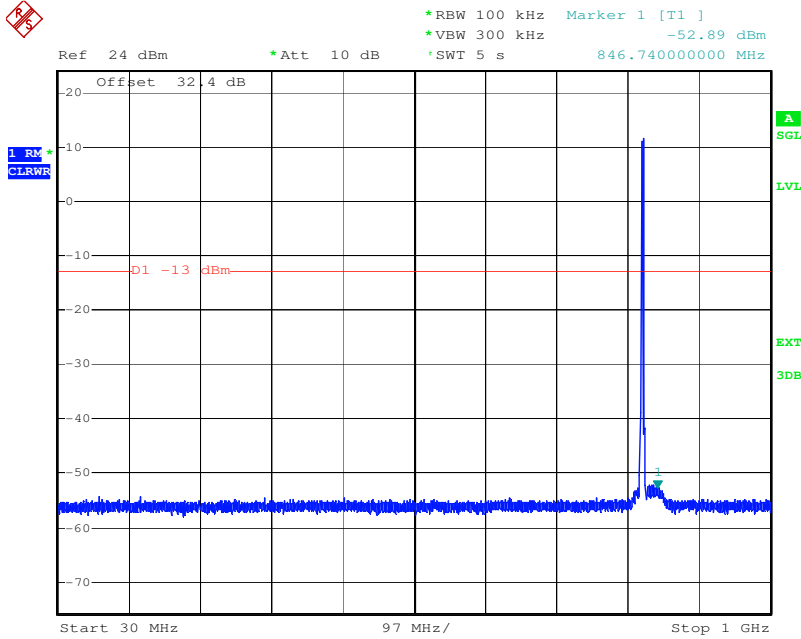

Date: 26.JAN.2010 11:55:10

plot 6.3.4.3-#1 Spurious Emissions at Antenna Terminals: §22.917, §2.1051; Test results; Uplink; CDMA > 1MHz to band edge; Bottom; < 1 GHz

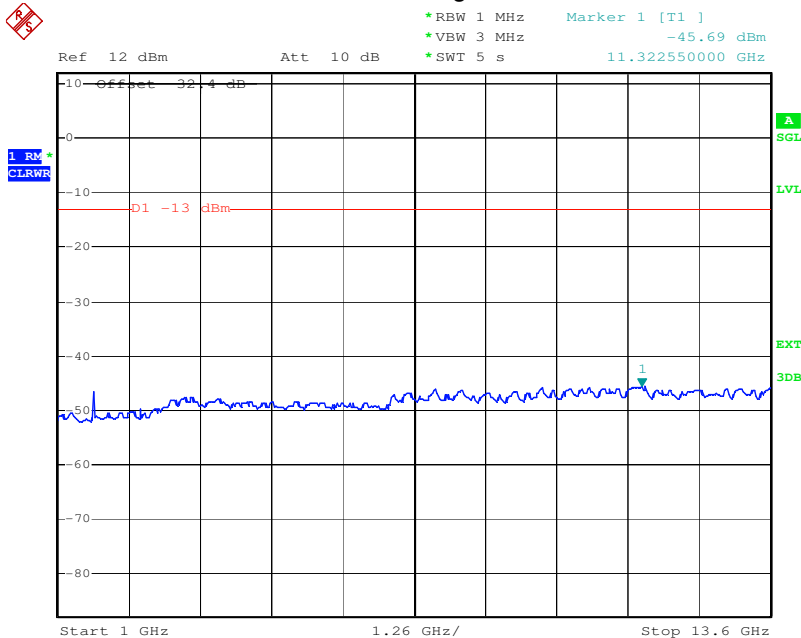

Date: 26.JAN.2010 11:54:08

plot 6.3.4.3-#2 Spurious Emissions at Antenna Terminals: §22.917, §2.1051; Test results; Uplink; CDMA > 1MHz to band edge; Bottom; > 1 GHz

EMC Test Report No.: 10-031



Test Site:
FCC Test Site No.:
IC OATS No.:

96997
IC3475A-1

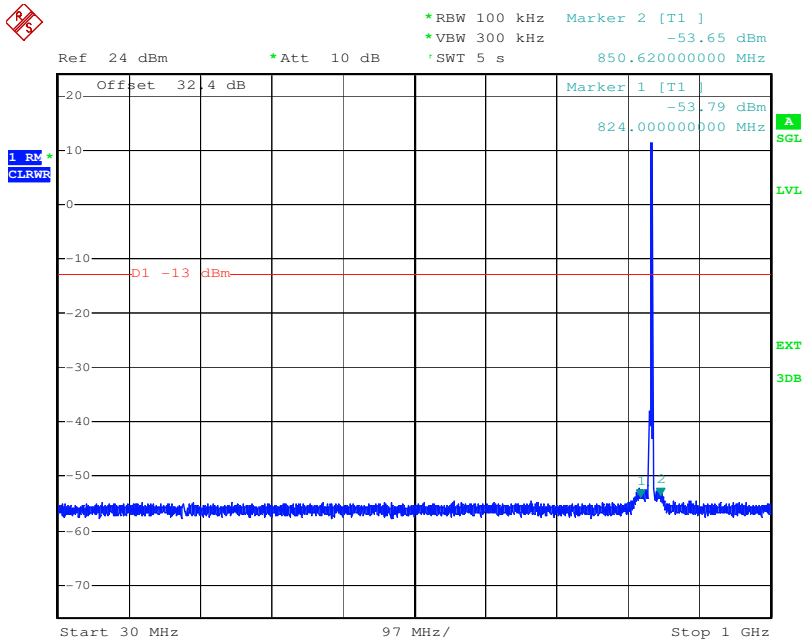

Date: 26.JAN.2010 12:49:54

plot 6.3.4.3-#3 Spurious Emissions at Antenna Terminals: §22.917, §2.1051; Test results; Uplink; CDMA > 1MHz to band edge; Middle; < 1GHz

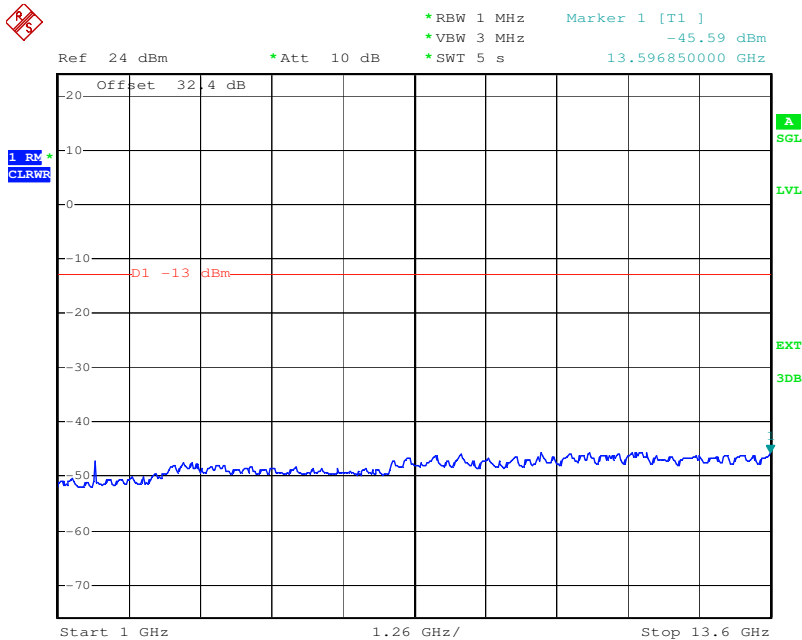

Date: 26.JAN.2010 12:50:29

plot 6.3.4.3-#4 Spurious Emissions at Antenna Terminals: §22.917, §2.1051; Test results; Uplink; CDMA > 1MHz to band edge; Middle; > 1 GHz

EMC Test Report No.: 10-031



Test Site:
FCC Test Site No.: 96997
IC OATS No.: IC3475A-1

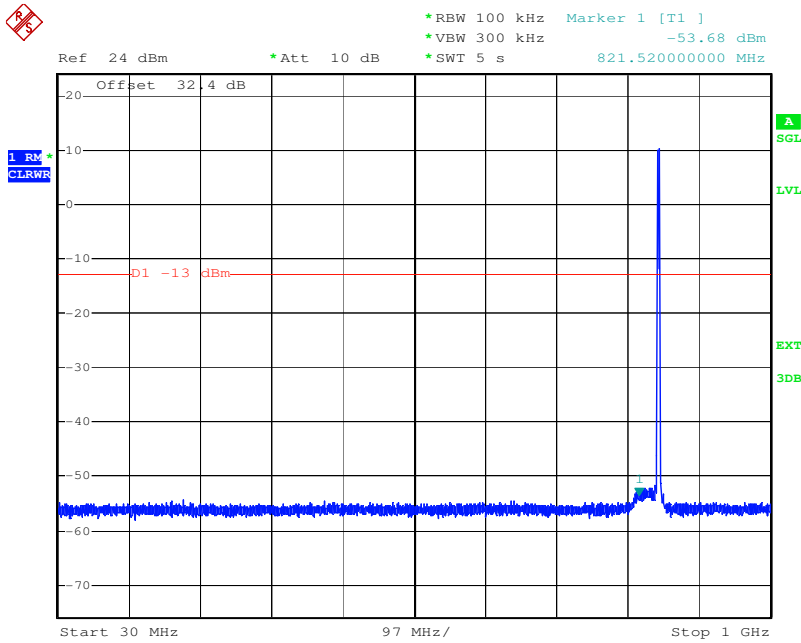

Date: 26.JAN.2010 12:52:37

plot 6.3.4.3-#5 Spurious Emissions at Antenna Terminals: §22.917, §2.1051; Test results; Uplink; CDMA > 1MHz to band edge; Top; < 1 GHz

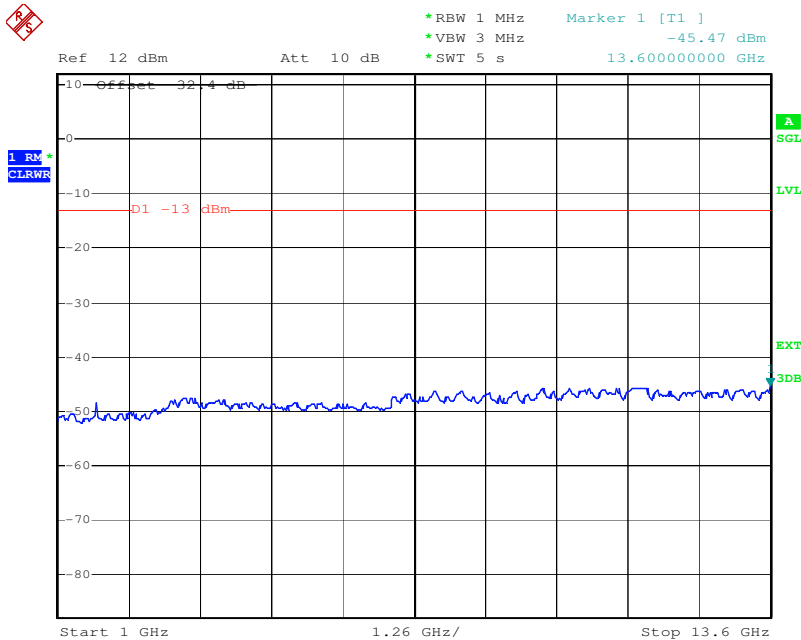

Date: 26.JAN.2010 11:52:36

plot 6.3.4.3-#6 Spurious Emissions at Antenna Terminals: §22.917, §2.1051; Test results; Uplink; CDMA > 1MHz to band edge; Top; > 1 GHz



6.3.4.4 W-CDMA > 1MHz to band edge

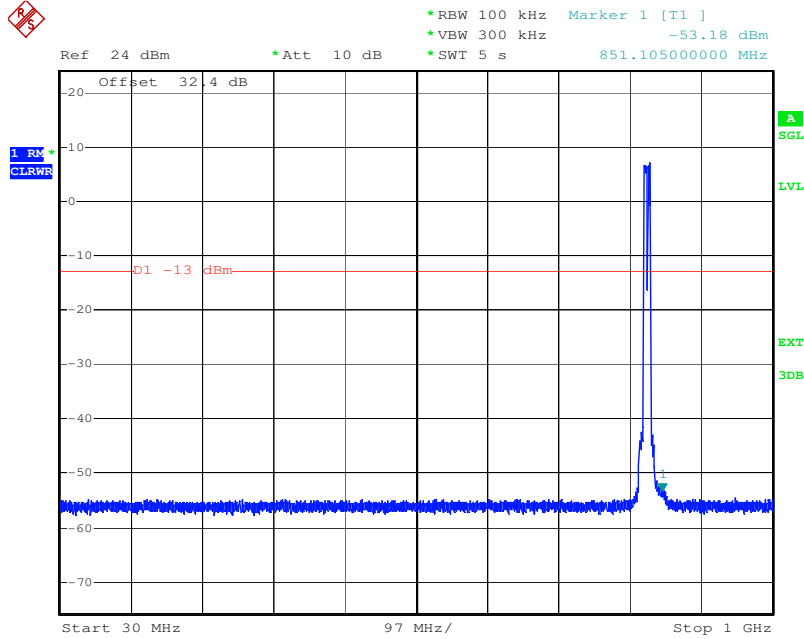

Date: 27.JAN.2010 17:27:05

plot 6.3.4.4-#1 Spurious Emissions at Antenna Terminals: §22.917, §2.1051; Test results; Uplink; W-CDMA > 1MHz to band edge; Bottom; < 1 GHz

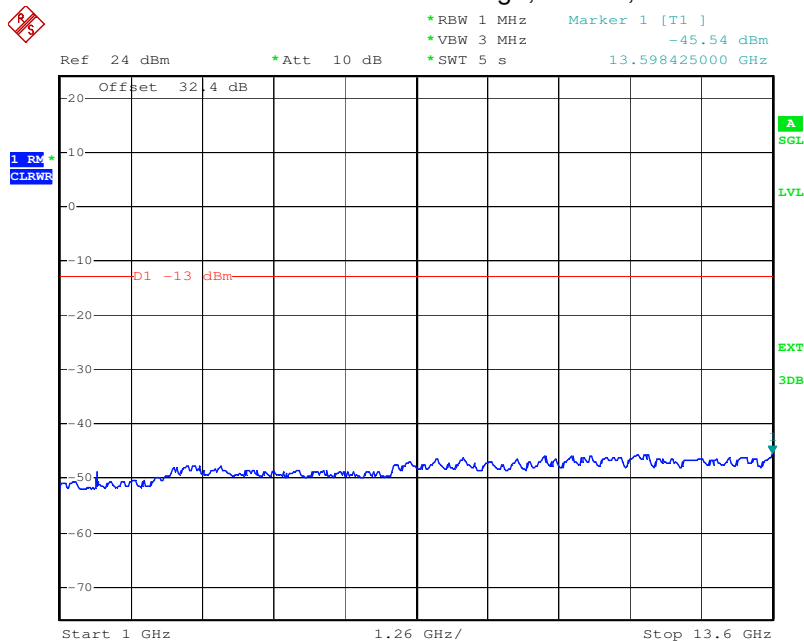

Date: 27.JAN.2010 17:27:42

plot 6.3.4.4-#2 Spurious Emissions at Antenna Terminals: §22.917, §2.1051; Test results; Uplink; W-CDMA > 1MHz to band edge; Bottom; > 1 GHz

EMC Test Report No.: 10-031

Test Site:
FCC Test Site No.: 96997
IC OATS No.: IC3475A-1

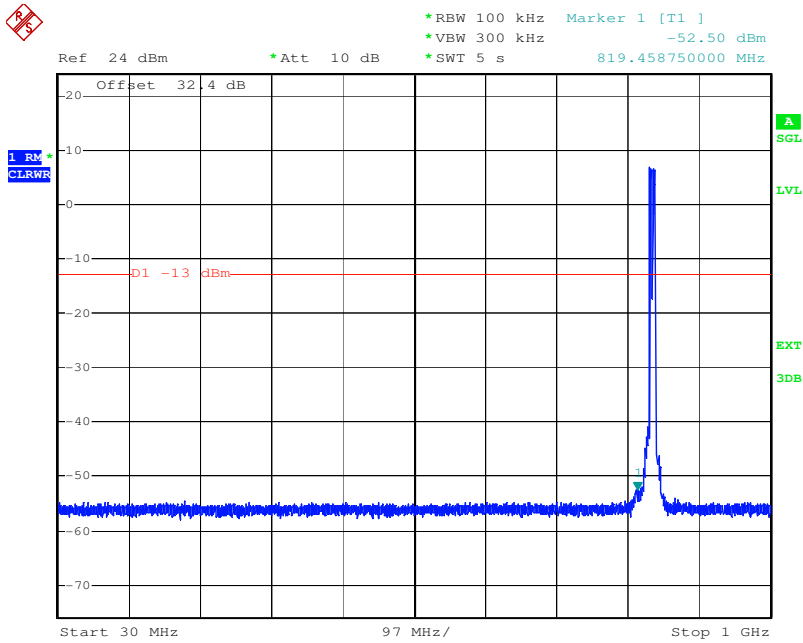

Date: 27.JAN.2010 17:31:50

plot 6.3.4.4-#3 Spurious Emissions at Antenna Terminals: §22.917, §2.1051; Test results; Uplink; W-CDMA > 1MHz to band edge; Middle; < 1 GHz

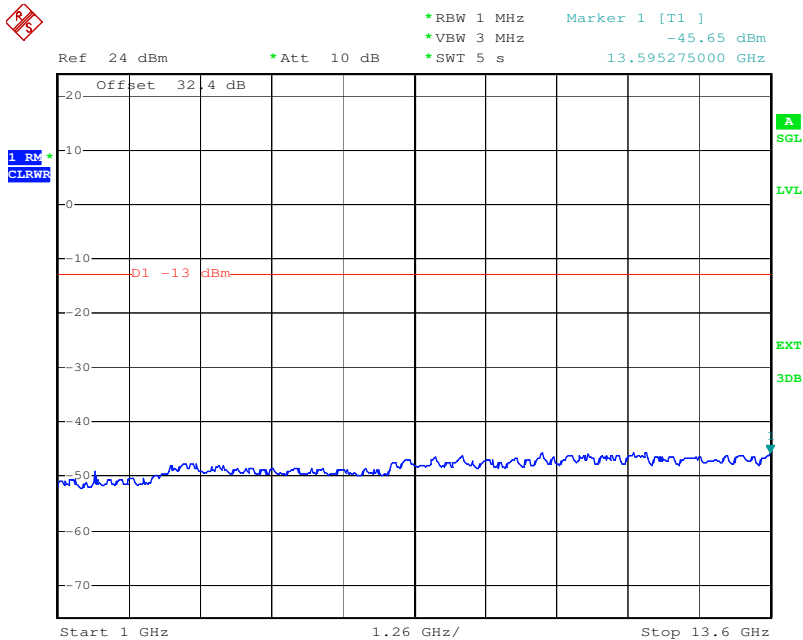

Date: 27.JAN.2010 17:30:38

plot 6.3.4.4-#4 Spurious Emissions at Antenna Terminals: §22.917, §2.1051; Test results; Uplink; W-CDMA > 1MHz to band edge; Middle; > 1 GHz

EMC Test Report No.: 10-031



Test Site:
FCC Test Site No.:
IC OATS No.:

96997
IC3475A-1

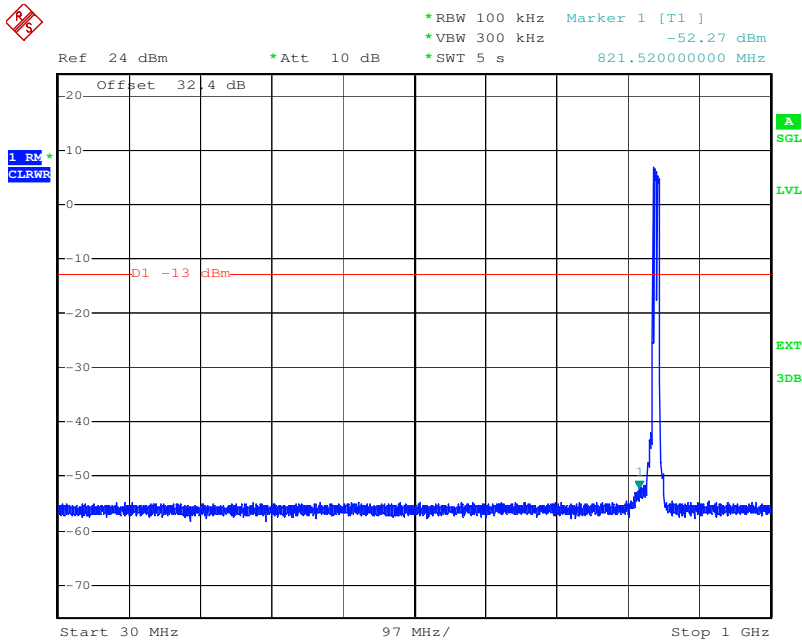

Date: 27.JAN.2010 17:22:25

plot 6.3.4.4-#5 Spurious Emissions at Antenna Terminals: §22.917, §2.1051; Test results; Uplink; W-CDMA > 1MHz to band edge; Top; < 1 GHz

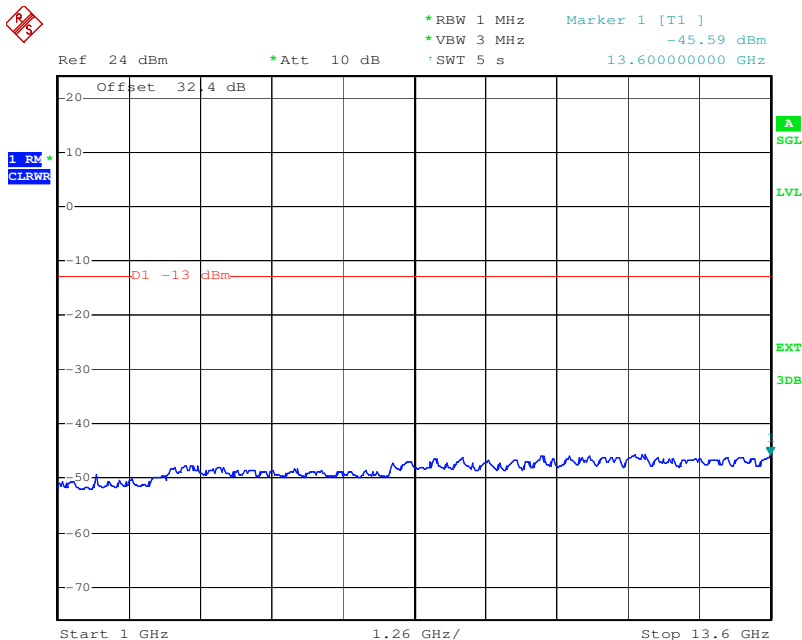

Date: 27.JAN.2010 17:21:33

plot 6.3.4.4-#6 Spurious Emissions at Antenna Terminals: §22.917, §2.1051; Test results; Uplink; W-CDMA > 1MHz to band edge; Top; > 1 GHz

EMC Test Report No.: 10-031



Test Site:
FCC Test Site No.: 96997
IC OATS No.: IC3475A-1

6.4 Summary test result

Test result	complies, according the plots above
Tested by:	Michael Leinfelder
Date:	27.01.2010

7 Field Strength of Spurious Emissions: §2.1053 for FCC and RSS-Gen for IC

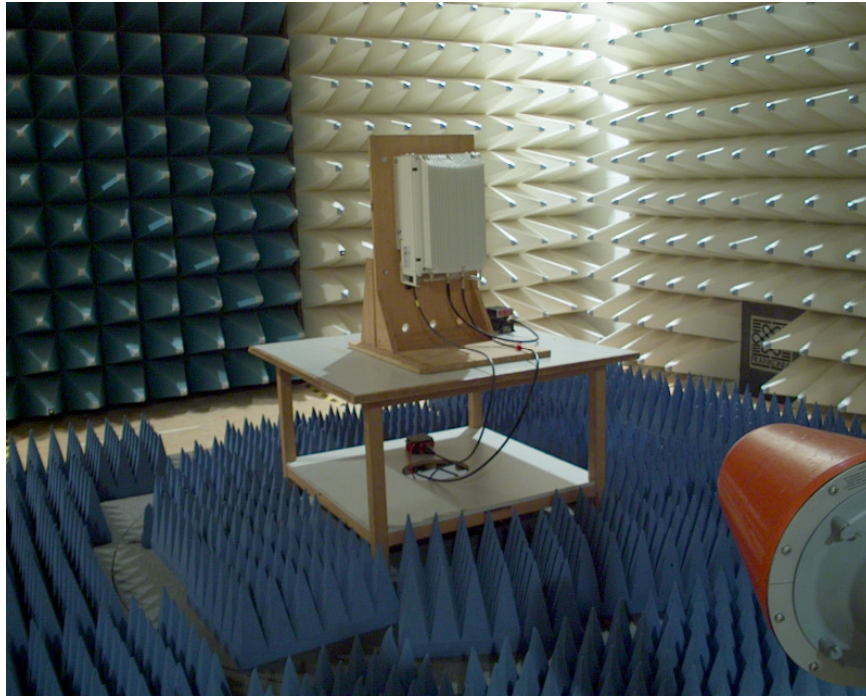

picture 7.1: Test setup: Field Strength Emission >1 GHz @3m in the FAC

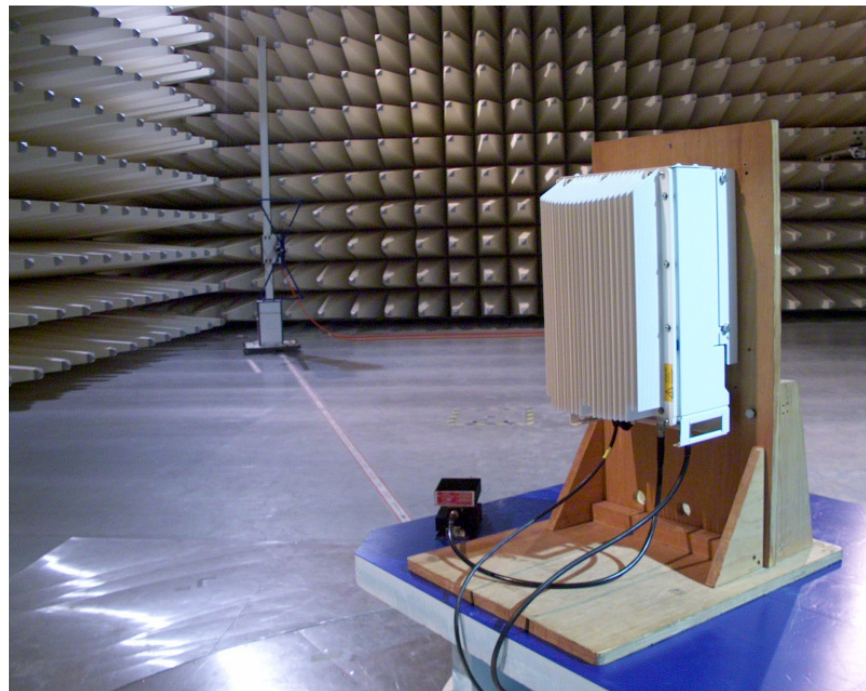

picture 7.2: Test setup: Field Strength Emission <1 GHz @10m in the SAC



Test Site:
 FCC Test Site No.: 96997
 IC OATS No.: IC3475A-1

This clause specifies requirements for the measurement of radiated emission.

Frequency range	Distance: EUT <-> antenna / location	Limit	Test method
30 MHz - 1 GHz	10 metres / SAC	FCC 47 CFR Part 22.917	TIA-603-C:2004
		IC RSS-132 sec. 4.5	
1 GHz – 9 GHz	3 metres / FAC	FCC 47 CFR Part 22.917	
		IC RSS-132 sec. 4.5	

Test equipment used:

Designation	Type	Manufacturer	Invent.-no.	Cal.-date	due Cal.-date	used
EMI test receiver	ESI40	Rohde & Schwarz	E1687	20.10.2009	20.10.2010	X
EMI test receiver	ESI40	Rohde & Schwarz	E1607	04.03.2009	04.03.2010	
Antenna	CBL 6111	Chase	K1149	14.09.2009	14.09.2010	X
Antenna	CBL 6111	Chase	K1026	14.09.2009	14.09.2010	
RF Cable		Frankonia	K1121 SET	28.12.2009	28.12.2010	X
Pre amplifier	AM1431	Miteq	K1721	27.04.2009	27.04.2010	X
Antenna	HL 025	R&S	K809	06.05.2009	06.05.2010	X
Antenna	MWH-1826 / B	ARA Inc.	K1042	06.04.2009	06.04.2010	
Antenna	MWH-2640 / B	ARA Inc.	K1043	06.04.2009	06.04.2010	
Preamplifier	AFS4-00102000	Miteq	K817	11.11.2009	11.11.2010	X
Preamplifier	AFS4-00102000	Miteq	K838	06.10.2009	06.10.2010	
Preamplifier	JS43-1800-4000	Miteq	K1104	26.08.2009	26.08.2010	
RF Cable	Sucoflex 100	Suhner	K1742	09.04.2009	09.04.2010	X

The Tile-Software Version 4 has been used to maximize radiated emission from the EUT in the frequency area up to 1 GHz. Above 1 GHz the REMI version 2.135 has been used for max search.

Test set-up:

Test location: SAC/FAC
 Both, the Fully Anechoic Chamber (FAC) and the Semi Anechoic Chamber (SAC) fulfil the requirements of ANSI C63.4 and CISPR 16-1-4 with regards to NSA and SVSWR.

Type of EUT: Wall mounted

Measurement uncertainty:

Measurement uncertainty expanded (95% or K=2)	± 4,7 dB for ANSI C63.4 measurement ± 0,5 dB for TIA-603 measurement
--	---

7.1 Limit

§22.917 Emission limitations for cellular equipment / RSS-GEN sec. 4.9; RSS-132 sec. 4.5

(a) Out of band emissions.

The power of any emission outside of the authorized operating frequency ranges must be attenuated below the transmitting power (P) by a factor of at least 43 + 10 log(P) dB.

Test Site:
 FCC Test Site No.: 96997
 IC OATS No.: IC3475A-1

7.2 Test method

§22.917 Emission limitations for cellular equipment.

(b) Measurement procedure.

Compliance with these rules is based on the use of measurement instrumentation employing a resolution bandwidth of 100 kHz or greater. In the 1 MHz bands immediately outside and adjacent to the frequency block a resolution bandwidth of at least one percent of the emission bandwidth of the fundamental emission of the transmitter may be employed. A narrower resolution bandwidth is permitted in all cases to improve measurement accuracy provided the measured power is integrated over the full required measurement bandwidth (i.e. 100 kHz or 1 percent of emission bandwidth, as specified).

The emission bandwidth is defined as the width of the signal between two points, one below the carrier center frequency and one above the carrier center frequency, outside of which all emissions are attenuated at least 26 dB below the transmitter power.

The antenna substitution method is used to determine the equivalent radiated power at spurious frequencies. The spurious emissions are measured at a distance of 3 meters. The EUT is then replaced with a reference substitution antenna with a known gain referenced to a dipole. This antenna is fed with a signal at the spurious frequency. The level of the signal is adjusted to repeat the previously measured level. The resulting erp is the signal level fed to the reference antenna corrected for gain referenced to a dipole (see Figure 7.2).

From KDB (AMPLIFIER, BOOSTER, AND REPEATER REMINDER SHEET):

Radiated spurs (enclosure) – Use of CW signal (low, mid. and high freq.) is acceptable rather than all modulations.

The maximum RFI field strength was determined during the measurement by rotating the turntable (± 180 degrees) and varying the height of the receive antenna ($h = 1 \dots 4$ m) as like defined in ANSI C63.4.

Both, the Fully Anechoic Chamber (FAC) and the Semi Anechoic Chamber (SAC) fulfil the requirements of ANSI C63.4 and CISPR 16-1-4 with regards to NSA and SVSWR.

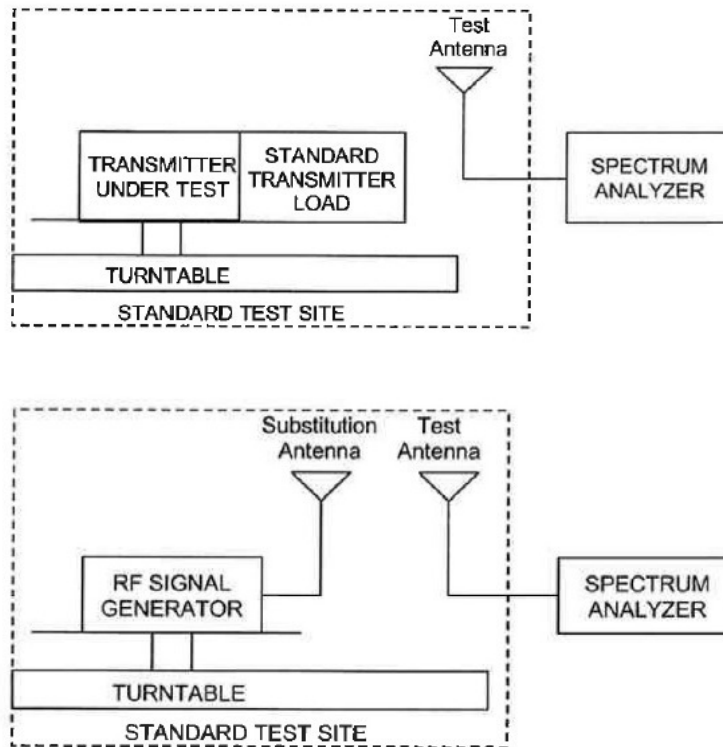

Figure #7.2 Substitution methods TIA-603-C



Test Site:
FCC Test Site No.: 96997
IC OATS No.: IC3475A-1

7.3 Test results

7.3.1 Premeasurements

7.3.1.1 30 MHz to 1 GHz Downlink (Bottom – Middle – Top)

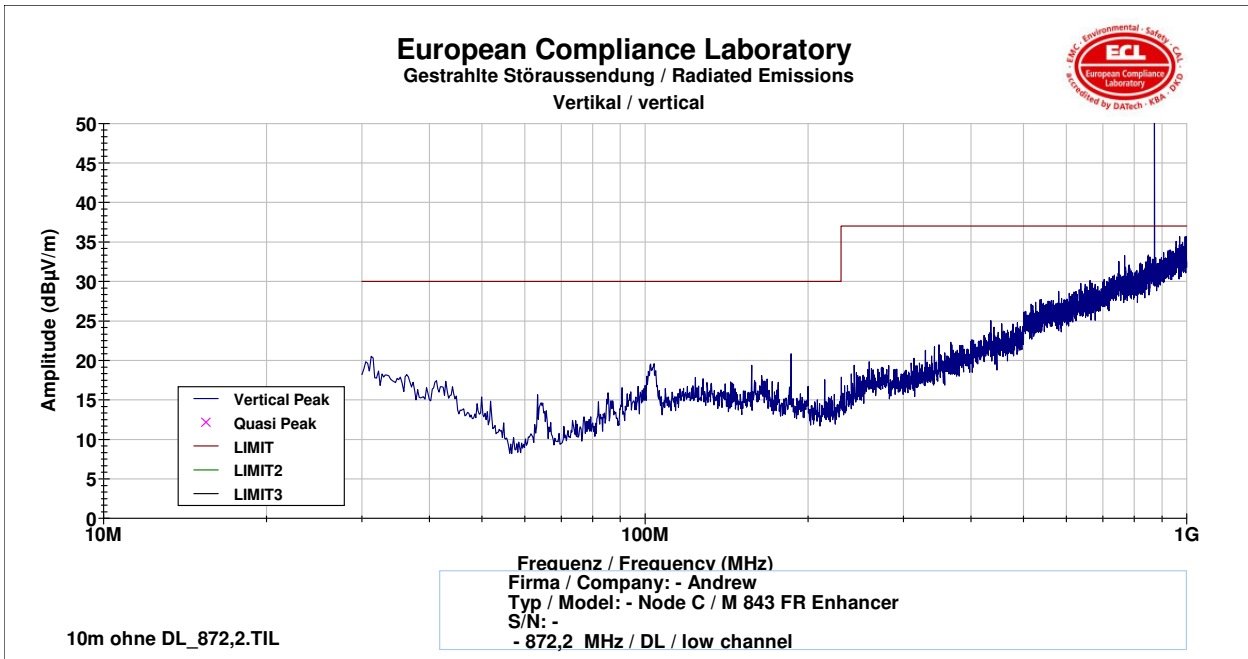
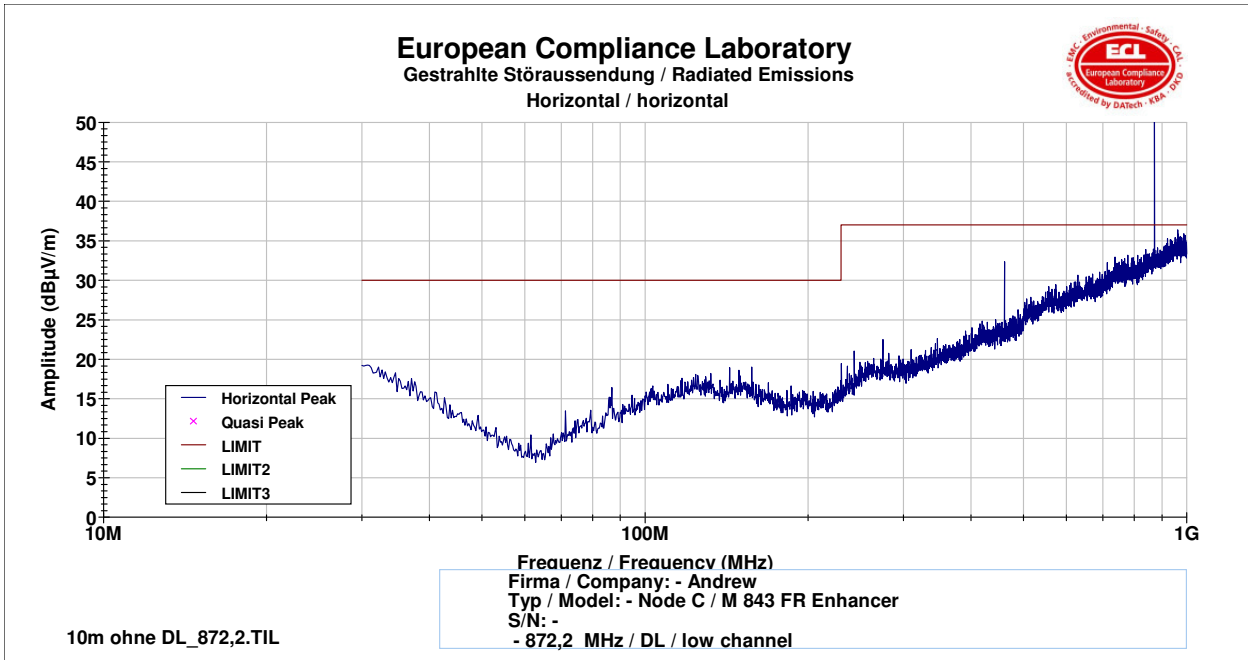

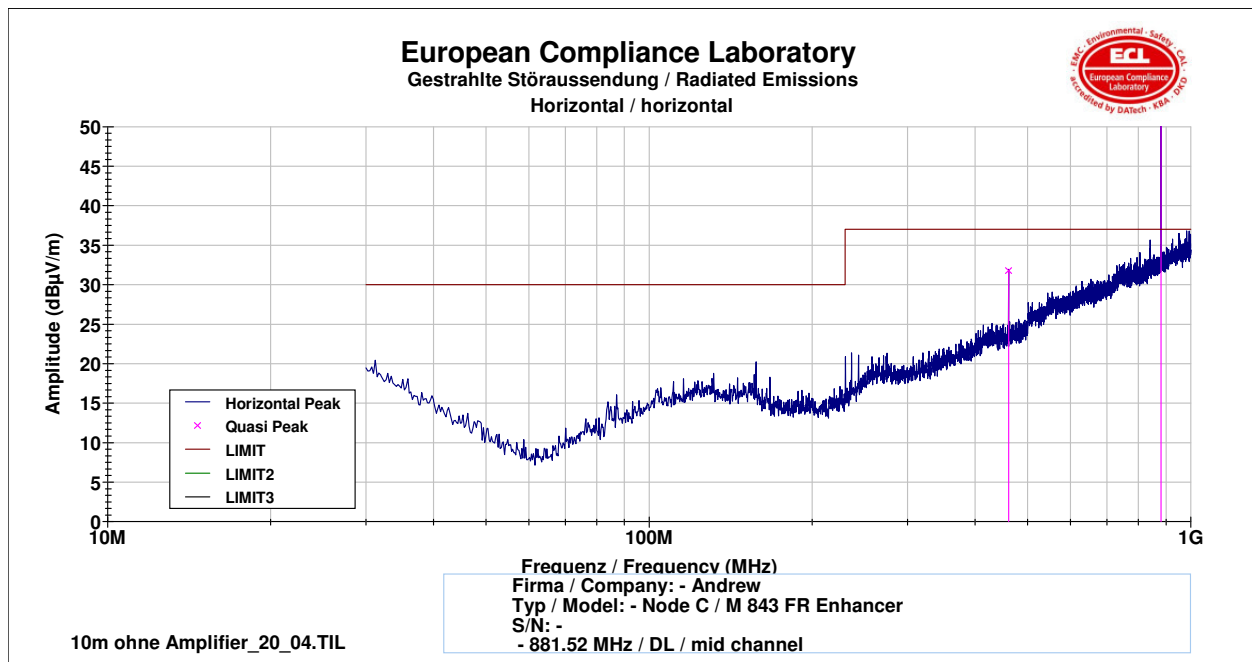

Frequency	Polarisation	Height	TT-Position	Cable Loss	Antenna Factor	Reading	Field Intensity	Limit	Margin
[MHz]	H/V	[cm]	[°]	[dB]	[dB]	[dB]	[dBµV/m]	[dBµV/m]	[dB]
460.814	H	101	-85	-5.0	17.1	9.6	31.8	37.0	5.2
881.543	H	397	-83	-6.9	22.7	28.5	58.2	37.0	-21.2

Test Site:
 FCC Test Site No.: 96997
 IC OATS No.: IC3475A-1

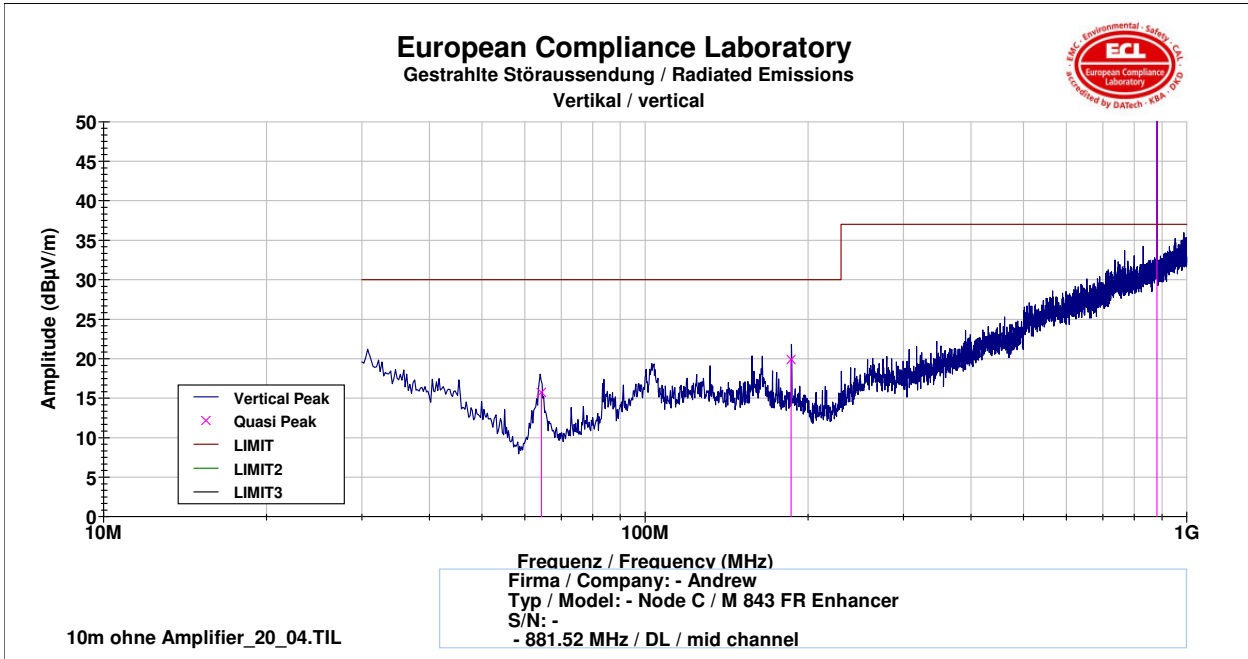

Frequency	Polarisation	Height	TT-Position	Cable Loss	Antenna Factor	Reading	Field Intensity	Limit	Margin
[MHz]	H/V	[cm]	[°]	[dB]	[dB]	[dB]	[dBµV/m]	[dBµV/m]	[dB]
64.318	V	268	172	-1.9	4.6	9.2	15.7	30.0	14.3
186.12	V	104	-21	-3.2	9.4	7.3	19.9	30.0	10.1
881.543	V	141	-21	-6.9	22.7	32.5	62.2	37.0	-25.2

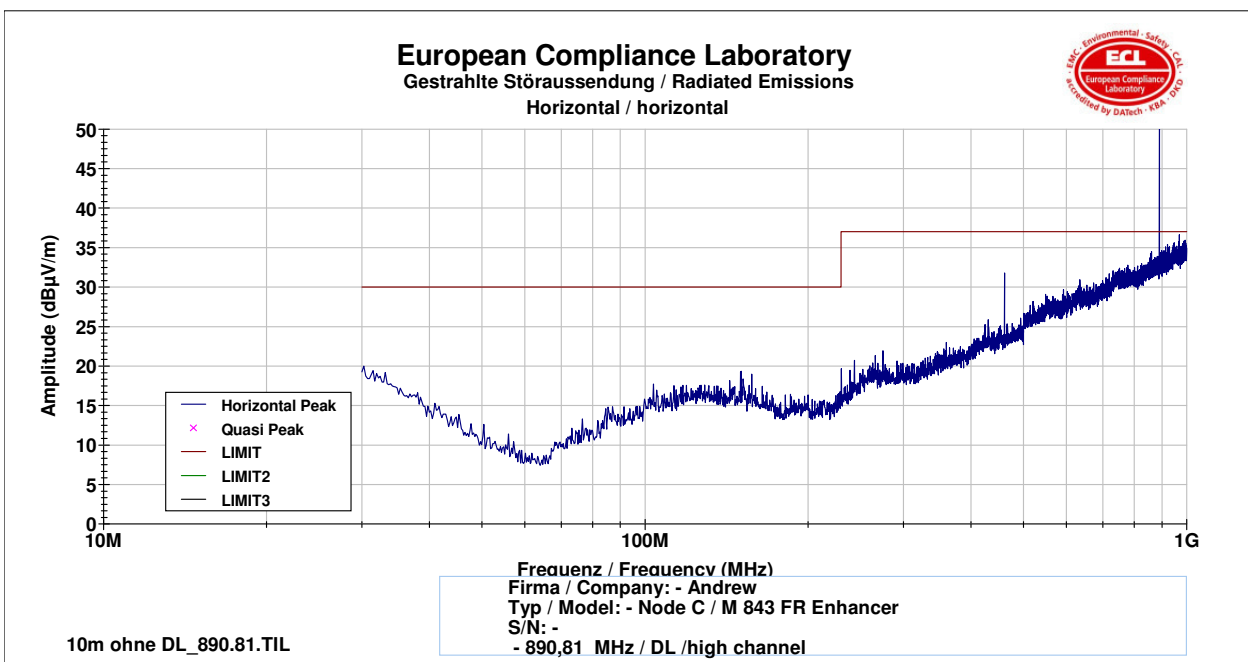

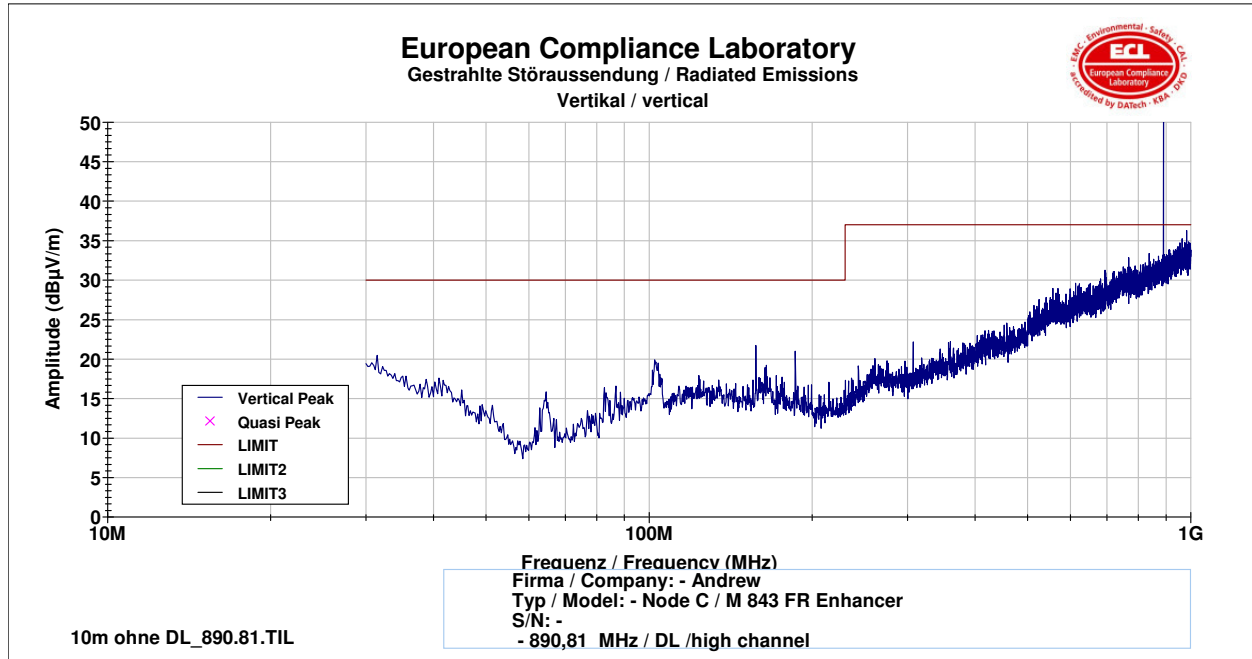



Test Site:
FCC Test Site No.: 96997
IC OATS No.: IC3475A-1

7.3.1.2 30 MHz to 1 GHz Uplink (Bottom – Middle – Top)

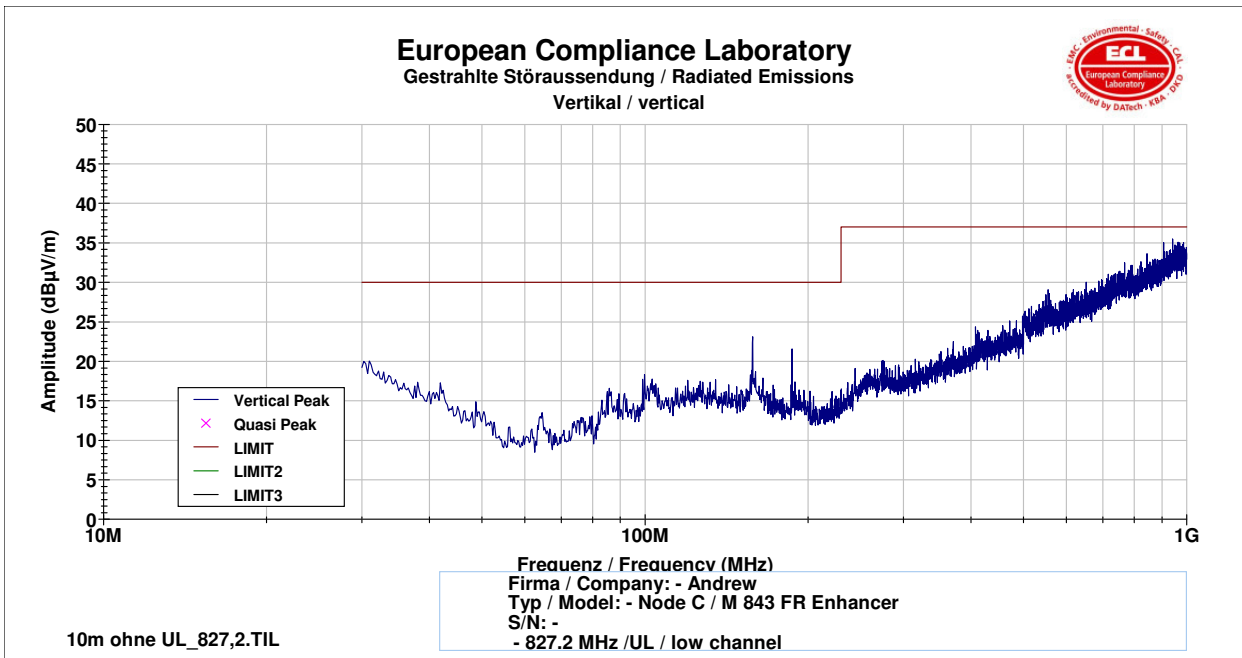
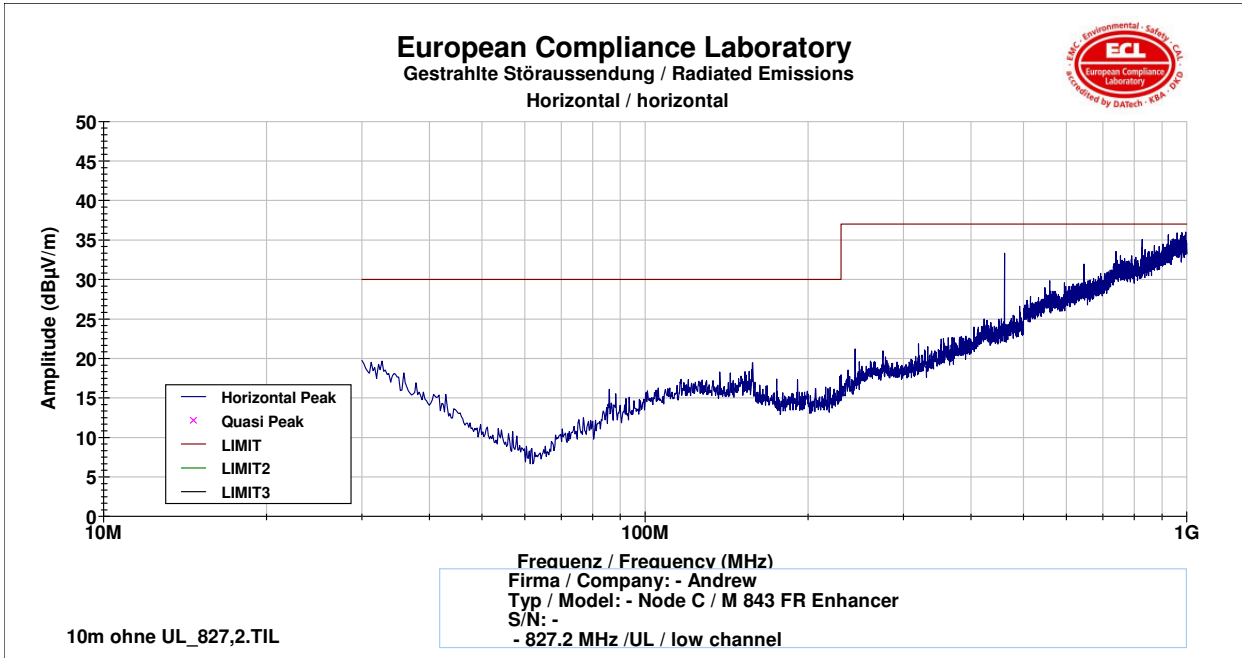

Test Site:
 FCC Test Site No.: 96997
 IC OATS No.: IC3475A-1

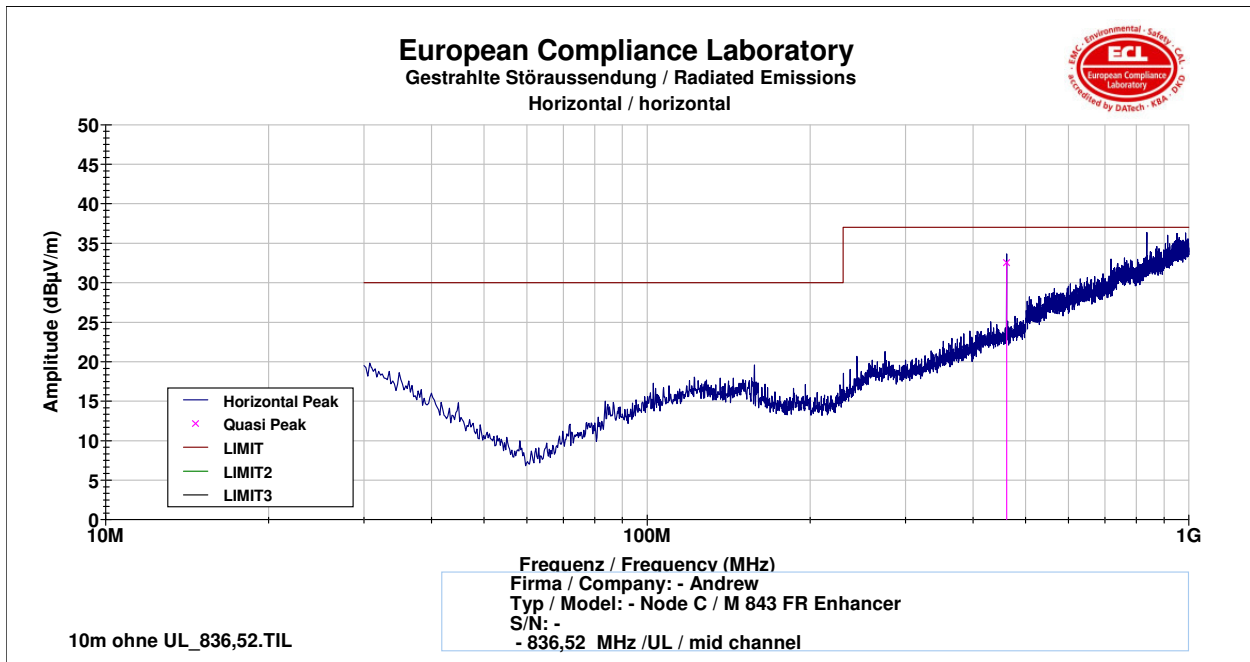

Frequency	Polarisation	Height	TT-Position	Cable Loss	Antenna Factor	Reading	Field Intensity	Limit	Margin
[MHz]	H/V	[cm]	[°]	[dB]	[dB]	[dB]	[dBµV/m]	[dBµV/m]	[dB]
460.814	H	363	-100	-5.0	17.1	10.4	32.5	37.0	4.5

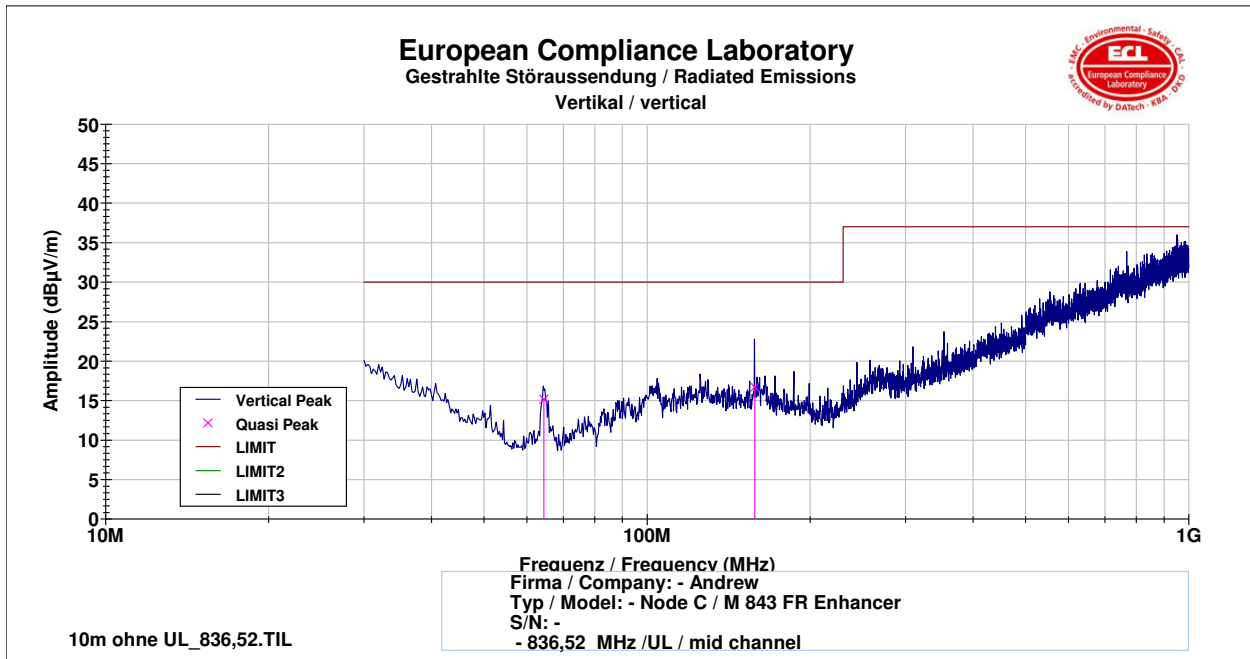

Test Site:
 FCC Test Site No.: 96997
 IC OATS No.: IC3475A-1



Frequency	Polarisation	Height	TT-Position	Cable Loss	Antenna Factor	Reading	Field Intensity	Limit	Margin
[MHz]	H/V	[cm]	[°]	[dB]	[dB]	[dB]	[dBµV/m]	[dBµV/m]	[dB]
64.441	V	211	175	-1.9	4.6	8.6	15.1	30.0	14.9
157.991	V	137	-94	-3.0	10.1	3.6	16.7	30.0	13.3

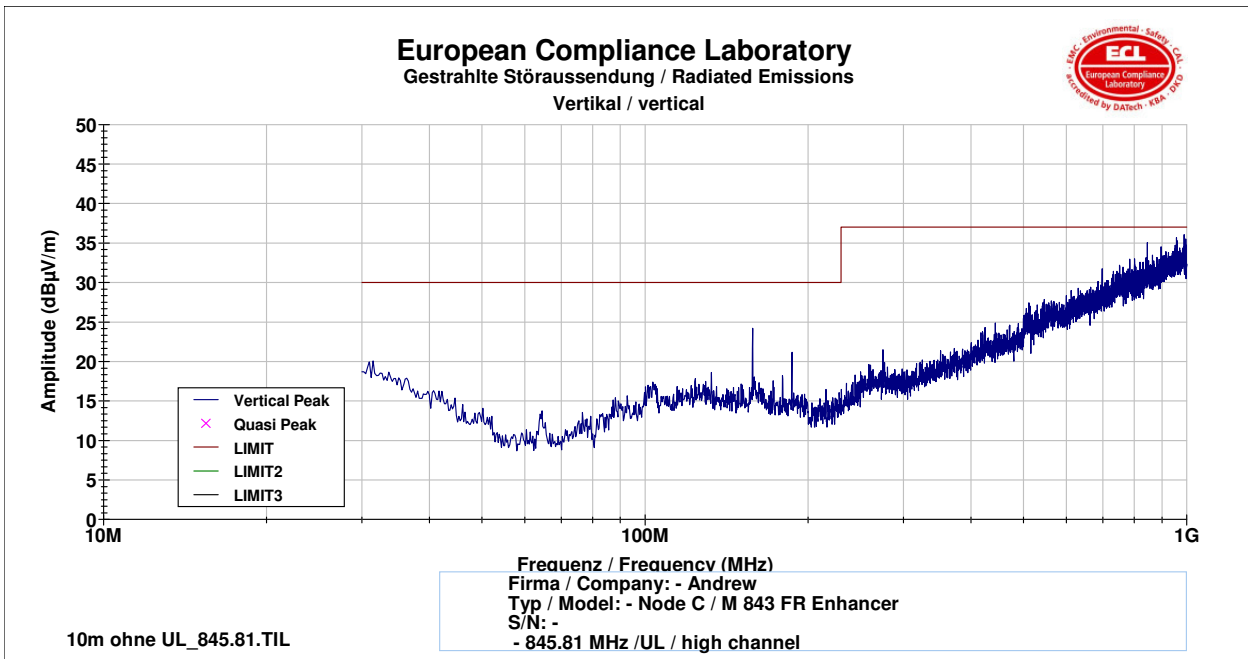
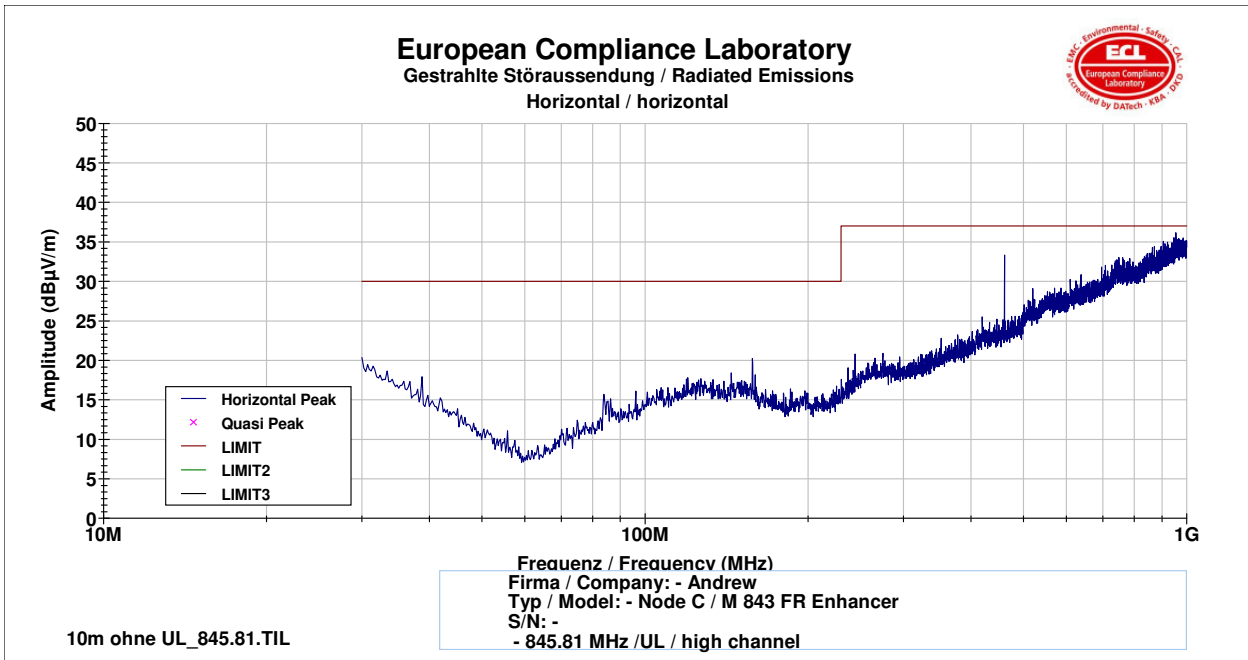

Test Site:
FCC Test Site No.: 96997
IC OATS No.: IC3475A-1

7.3.1.3 1 GHz to 9 GHz Downlink (Bottom – Middle – Top)
Vertikal / Horizontal

872,2 MHz Bottom:

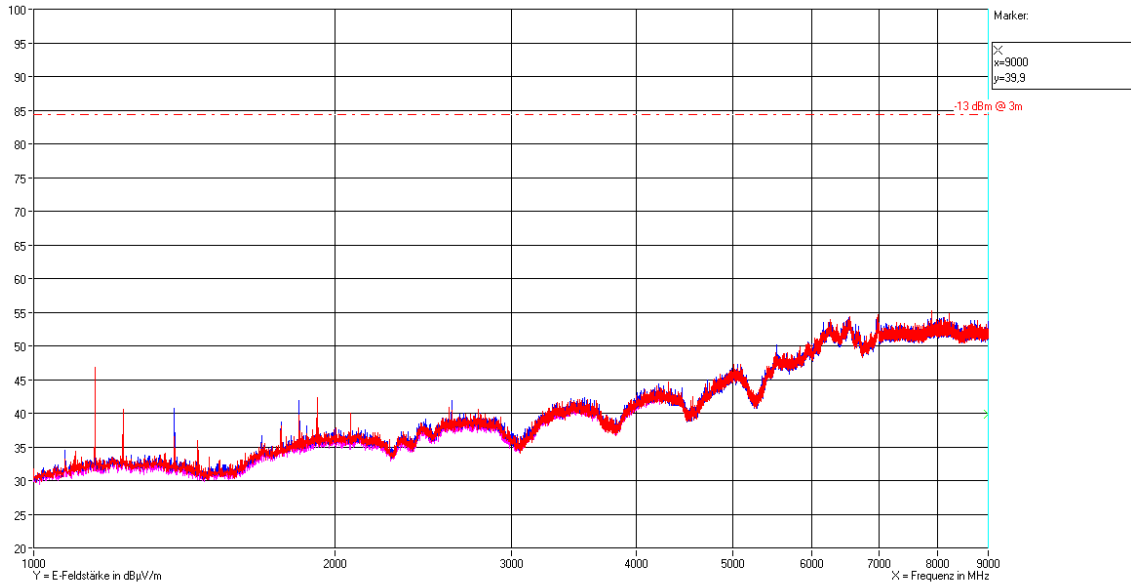

881,52 MHz Middle:

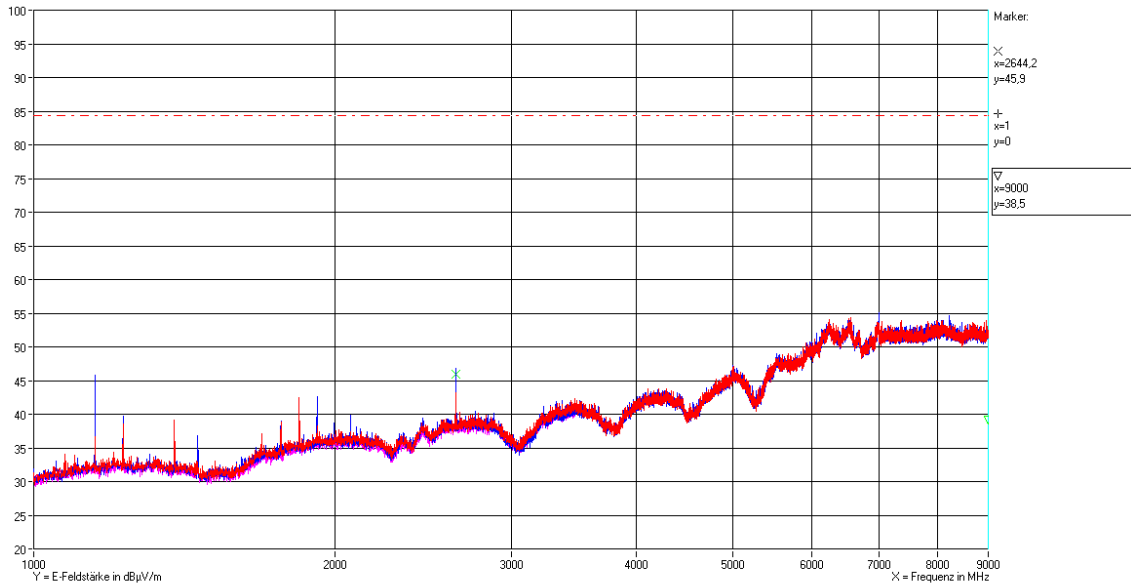

EMC Test Report No.: 10-031

Test Site:
FCC Test Site No.: 96997
IC OATS No.: IC3475A-1



890,81 MHz Top:

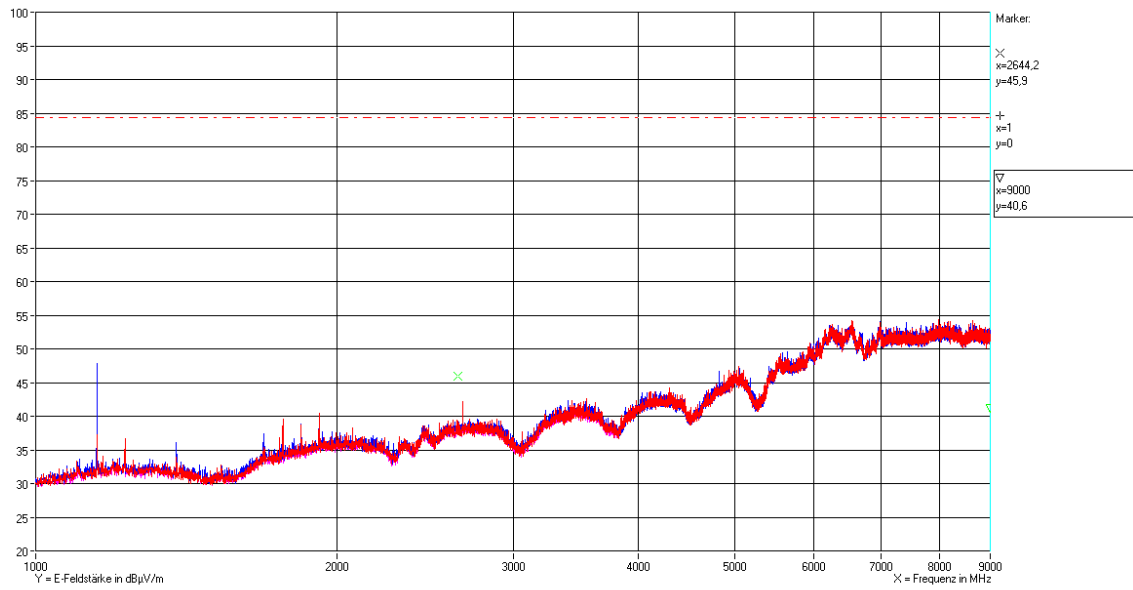

Test Site:
FCC Test Site No.: 96997
IC OATS No.: IC3475A-1

7.3.1.4 1 GHz to 9 GHz Uplink (Bottom – Middle – Top) Vertikal / Horizontal

827,2 MHz Bottom:

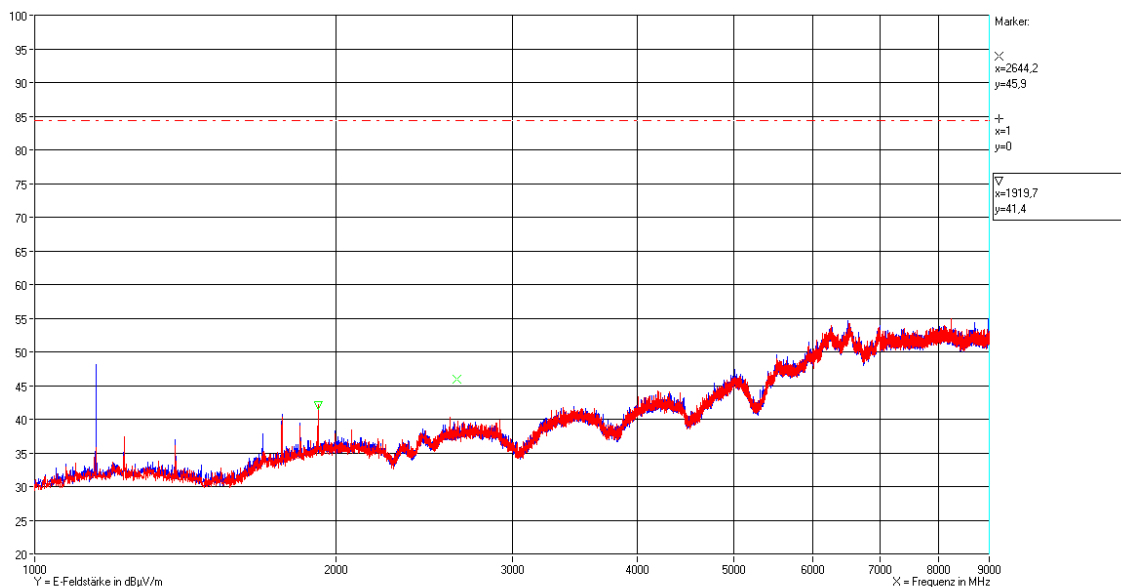

836,52 MHz Middle:

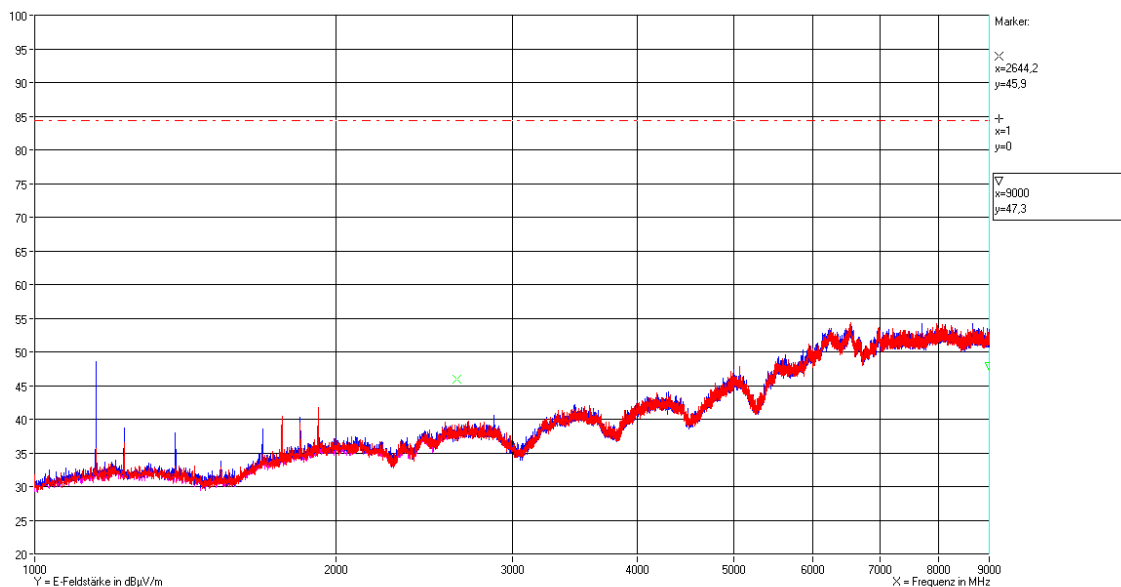

EMC Test Report No.: 10-031

Test Site:
FCC Test Site No.: 96997
IC OATS No.: IC3475A-1



845,81 MHz Top

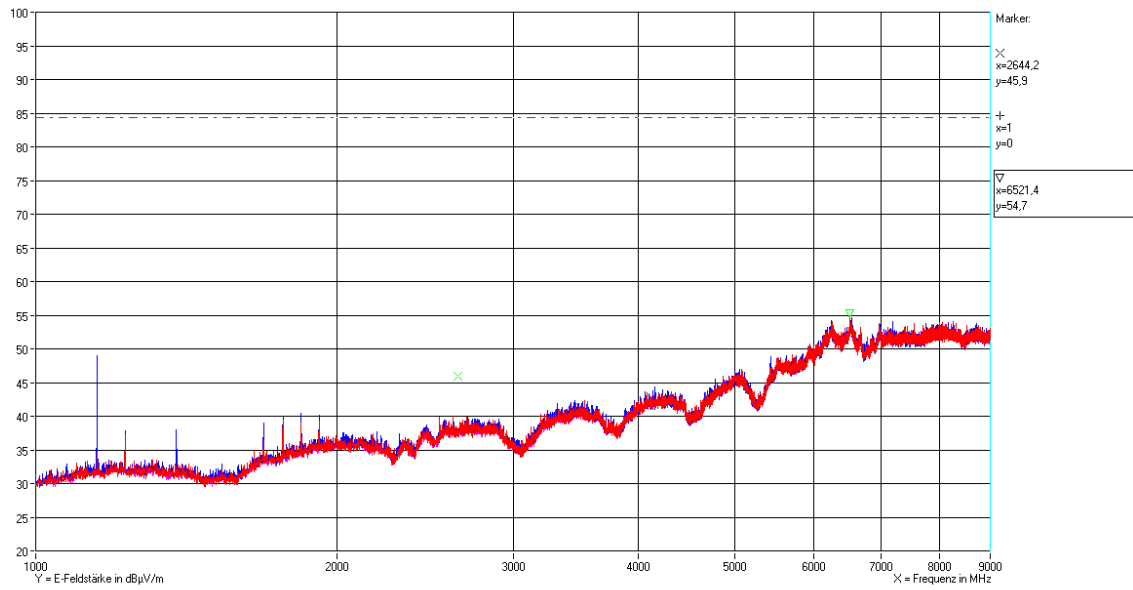

Test Site:
 FCC Test Site No.: 96997
 IC OATS No.: IC3475A-1

7.3.2 Final measurements (substitution method)

7.3.2.1 30 MHz to 1 GHz Downlink

B/M/T	requency	Polarisation	Height	TT-Position	e.r.p.	Limit	Margin
	[MHz]	H/V	[cm]	[°]	[dBm]	[dBm]	[dB]
M	64.318	V	268	172	-71,2	-13	58,2
T	102,51	V	253	45	-67	-13	53,8
M	186.12	V	104	-21	-67,0	-13	54,0
B	460.814	H	101	-85	-53,9	-13	40,9

7.3.2.2 30 MHz to 1 GHz Uplink

B/M/T	Frequency	Polarisation	Height	TT-Position	e.r.p.	Limit	Margin
	[MHz]	H/V	[cm]	[°]	[dBm]	[dBm]	[dB]
M	64.441	V	211	175	-71,8	-13	58,8
T	157.991	V	137	-94	-70,2	-13	57,2
M	460.814	H	363	-100	-53,4	-13	40,4

7.3.2.3 1 GHz to 9 GHz Downlink

B/M/T	Frequency	Polarisation	Height	TT-Position	e.r.p.	Limit	Margin
	[MHz]	H/V	[cm]	[°]	[dBm]	[dBm]	[dB]
T	1152	H	118	12	-49,5	-13	36,5
B	1229	V	107	11	-56,8	-13	43,8
B	1383	H	105	25	-56,7	-13	43,7
M	2644	H	125	23	-50,6	-13	37,6
B	6989	V	110	5	-42,8	-13	29,8

7.3.2.4 1 GHz to 9 GHz Uplink

B/M/T	Frequency	Polarisation	Height	TT-Position	e.r.p.	Limit	Margin
	[MHz]	H/V	[cm]	[°]	[dBm]	[dBm]	[dB]
B	1152,1	H	107	17	-48,5	-13	35,5
T	1919,8	V	104	14	-55,3	-13	42,3
T	6521,5	V	112	35	-42,4	-13	29,4

Lehmann / 16.02.2010

EMC Test Report No.: 10-031

Test Site:

FCC Test Site No.:

96997

IC OATS No.:

IC3475A-1



***** End of test report *****