

Test Site:
FCC Test Site No.: 96997



**BUREAU
VERITAS**

ECL-EMC Test Report No.: 16-171

Equipment under test: MR1718E
1700MHz Path
FCC ID: XS5-MR17E
Type of test: **FCC 47 CFR Part 27 Subpart C: 2016**
Miscellaneous Wireless Communication Services

Measurement Procedures: 47 CFR Parts 2 (*Frequency Allocations and Radio Treaty Matters; General Rules and Regulations*),
Part 27:2016 (*Miscellaneous Wireless Communication Services*),
ANSI/TIA-603-C (2004), *Land Mobile FM or PM Communications Equipment Measurement and Performance Standards*

Test result: **Passed**

| | | | |
|-------------------|------------------------|----------|------------|
| Date of issue: | 20.07.16 | | Signature: |
| Issue-No.: | 01 | Author: | |
| Date of delivery: | 05.07.16 | Checked: | |
| Test dates: | 24.06.16 – 06.07.16 | | |
| Pages: | 58 | | |

Test Report No.: 16-171

FCC ID: XS5-MR17E



BUREAU
VERITAS

Manufacturer: ANDREW Wireless Systems GmbH
Industriering 10

D-86675 Buchdorf

Tel.: +49 (0)9099 69 0

Fax: +49 (0)9099 69 140

Test Location: Bureau Veritas Consumer Products Services
Germany GmbH
European Compliance Laboratory (ECL)
Thurn-und-Taxis-Straße 18

D-90411 Nürnberg

Tel.: +49 40 74041 0

Fax: +49 40 74041-2755

General:

The purpose of this report is to show compliance to the FCC regulations for devices operating under Part N°27 of the Code of Federal Regulations title 47.

This report informs about the results of the EMC tests, it only refers to the equipment under test. No part of this report may be reproduced in any form, without written permission.



Table of contents

| | | |
|---------|---|----|
| 1 | TEST RESULTS SUMMARY | 5 |
| 2 | EQUIPMENT UNDER TEST (E.U.T.) | 6 |
| 2.1 | DESCRIPTION | 6 |
| 2.1.1 | DOWNLINK | 6 |
| 2.1.2 | UPLINK | 6 |
| 2.1.3 | DESCRIPTION OF EUT | 7 |
| 2.1.4 | BLOCK DIAGRAM OF MEASUREMENT REFERENCE POINTS | 8 |
| 2.1.5 | TEST SITE (ANDREW BUCHDORF) | 9 |
| 2.2 | TEST ENVIRONMENT | 9 |
| 2.3 | TEST | 9 |
| 2.4 | INPUT AND OUTPUT LOSSES | 10 |
| 2.5 | MEASUREMENT UNCERTAINTY | 10 |
| 3 | TEST SITE (BUREAU VERITAS CONSUMER PRODUCTS SERVICES) | 10 |
| 4 | RF POWER OUT: §27.50, §2.1046 | 11 |
| 4.1 | LIMIT | 11 |
| 4.2 | TEST METHOD | 11 |
| 4.3 | TEST RESULTS | 12 |
| 4.3.1 | DOWNLINK | 13 |
| 4.3.2 | UPLINK | 14 |
| 4.3.3 | DOWNLINK | 15 |
| 4.3.3.1 | CDMA | 15 |
| 4.3.3.2 | W-CDMA | 15 |
| 4.3.4 | UPLINK | 16 |
| 4.3.4.1 | CDMA | 16 |
| 4.3.4.2 | W-CDMA | 16 |
| 4.4 | SUMMARY TEST RESULT | 17 |
| 5 | OCCUPIED BANDWIDTH: §2.1049 | 18 |
| 5.1 | LIMIT | 18 |
| 5.2 | TEST METHOD | 18 |
| 5.3 | TEST RESULTS | 19 |
| 5.3.1 | DOWNLINK | 19 |
| 5.3.2 | UPLINK | 20 |
| 5.3.3 | DOWNLINK | 21 |
| 5.3.3.1 | CDMA | 21 |
| 5.3.3.2 | W-CDMA | 22 |
| 5.3.4 | 26dB BANDWIDTH | 23 |
| 5.3.4.1 | CDMA | 23 |
| 5.3.4.2 | W-CDMA | 24 |
| 5.3.5 | UPLINK | 25 |
| 5.3.5.1 | CDMA | 25 |
| 5.3.5.2 | W-CDMA | 26 |
| 5.3.6 | 26dB BANDWIDTH | 27 |
| 5.3.6.1 | CDMA | 27 |
| 5.3.6.2 | W-CDMA | 28 |



| | | |
|---------|--|----|
| 5.4 | SUMMARY TEST RESULT | 29 |
| 6 | SPURIOUS EMISSIONS AT ANTENNA TERMINALS: §27.53, §2.1051 | 30 |
| 6.1 | LIMIT | 30 |
| 6.2 | TEST METHOD | 30 |
| 6.3 | TEST RESULTS | 31 |
| 6.3.1 | DOWNLINK | 31 |
| 6.3.2 | UPLINK | 31 |
| 6.3.3 | DOWNLINK | 32 |
| 6.3.3.1 | CDMA | 32 |
| 6.3.3.2 | W-CDMA | 32 |
| 6.3.4 | UPLINK | 33 |
| 6.3.4.1 | CDMA | 33 |
| 6.3.4.2 | W-CDMA | 33 |
| 6.4 | SUMMARY TEST RESULT | 34 |
| 7 | INTERMODULATION: §27.53, §2.1051 | 35 |
| 7.1 | LIMIT | 35 |
| 7.2 | TEST METHOD | 35 |
| 7.3 | TEST RESULTS | 36 |
| 7.3.1 | DOWNLINK | 36 |
| 7.3.2 | UPLINK | 36 |
| 7.3.3 | DOWNLINK | 37 |
| 7.3.3.1 | CDMA | 37 |
| 7.3.3.2 | WCDMA | 38 |
| 7.3.4 | UPLINK | 39 |
| 7.3.4.1 | CDMA | 39 |
| 7.3.4.2 | WCDMA | 40 |
| 7.4 | SUMMARY TEST RESULT | 41 |
| 8 | OUT OF BAND REJECTION | 42 |
| 8.1 | LIMIT | 42 |
| 8.2 | TEST METHOD | 42 |
| 8.3 | TEST RESULTS | 42 |
| 8.3.1 | DOWNLINK | 43 |
| 8.3.2 | UPLINK | 43 |
| 9 | FIELD STRENGTH OF SPURIOUS EMISSIONS: §27.53, §2.1053 | 45 |
| 9.1 | METHOD OF MEASUREMENT | 50 |
| 9.2 | LIMIT §27.53 (H) | 51 |
| 9.3 | CLIMATIC VALUES IN THE LAB | 51 |
| 9.4 | TEST RESULTS | 52 |
| 9.4.1 | 30 MHZ TO 1 GHZ UPLINK | 52 |
| 9.4.2 | 30 MHZ TO 1 GHZ DOWNLINK | 53 |
| 9.4.3 | 1 GHZ – 18 GHZ UPLINK | 54 |
| 9.4.4 | 1 GHZ – 18 GHZ DOWNLINK | 55 |
| 9.4.5 | 18 GHZ – 26.5 GHZ UPLINK | 56 |
| 9.4.6 | 18 GHZ – 26.5 GHZ DOWNLINK | 57 |
| 10 | HISTORY | 58 |



1 Test Results Summary

| Name of Test | FCC Para. No. | FCC Method | FCC Spec. | Result |
|---|-----------------------|-----------------------|-----------------------|----------|
| RF Power Output | 27.50(d) | 2.1046 | 1640 Watts/MHz | Complies |
| Occupied Bandwidth | KDB 935210 D02 v03r02 | 2.1049 | Input/Output | Complies |
| Spurious Emissions at Antenna Terminals | 27.53(h) | 2.1051 | -13dBm | Complies |
| Field Strength of Spurious Emissions | 27.53(m) | 2.1053 TIA/EA-603 | -13dBm E.I.R.P | Complies |
| Intermodulation | KDB 935210 D02 v03r02 | KDB 935210 D02 v03r02 | KDB 935210 D02 v03r02 | Complies |
| Frequency Stability | 27.54 | 2.1055 | Must stay in band | NA |
| Out of Band Rejection | KDB 935210 D02 v03r02 | KDB 935210 D03 v04 | KDB 935210 D03 v04 | Complies |

Frequency stability is given by: The system gets an electrical analog signal from the BSS which is converted into an analog optical signal, transmitted by the optical links and then reconverted in the Remote Unit into an analog electrical signal. During this process happens no frequency change/modification, so input and output have same frequency what can be seen under clause "Occupied Bandwidth".



2 Equipment under test (E.U.T.)

2.1 Description

| | |
|-----------------------------------|---|
| Kind of equipment | MR1718E (Mini Repeater) |
| Andrew Ident. Number | 7721098 |
| Serial no.(SN) | 10 |
| Revision | 00 |
| Software version and ID | . |
| Type of modulation and Designator | CDMA (F9W) <input checked="" type="checkbox"/> W-CDMA (F9W) <input checked="" type="checkbox"/> |
| Frequency Translation | F1-F1 <input checked="" type="checkbox"/> F1-F2 <input type="checkbox"/> N/A <input type="checkbox"/> |
| Band Selection | Software <input checked="" type="checkbox"/> Duplexer <input type="checkbox"/> Full band <input type="checkbox"/> |

2.1.1 Downlink

| | |
|---|---|
| Pass band | 25 MHz variable band, in 2110 MHz – 2180 MHz |
| For CDMA max. composite output power based on one carrier per path (rated) | 22,0 dBm = 0,158 W |
| For UMTS max. composite output power based on one carrier per path (rated) | 18,0 dBm = 0,063 W |
| max Gain* | 78dB |

2.1.2 Uplink

| | |
|---|---|
| Pass band | 25 MHz variable band, in 1710 MHz – 1780 MHz |
| For CDMA max. composite output power based on one carrier per path (rated) | 22,0 dBm = 0,158 W |
| For UMTS max. composite output power based on one carrier per path (rated) | 18,0 dBm = 0,063 W |
| System Gain* | 78dB |

2.1.3 Description of EUT

Andrew MR1718 is a mini repeater for indoor coverage in small areas.

The MRx18 is a bi-directional amplifier used to enhance signals between a mobile and a base station in a mobile network. It has been designed to increase signal strength in small and medium sized areas such as offices, shops, and basements. By boosting the signal level the MRx18 increases indoor coverage and allows high data rate connectivity.

If weak signal transmissions occur within the coverage area due to indoor applications, topological conditions or distance from the transmitter, a repeater is used to extend transmission range. In the downlink path, the repeater picks up the signals from a donor antenna of a BTS / Node B, amplifies and re-transmits it into the required dark spot. In the uplink (UL) path the repeater picks up the signals from a mobile/UE and re-transmits it to the BTS/Node B.

CommScope's MRx18 gives designers a simple tool to solve their small area coverage and performance issues.

The MRx18 is easy to install. Also, a web-based browser simplifies to commission and configure the equipment. The RF link (donor) towards the base station is typically fed from an outdoor antenna while the coverage area is fed by an indoor antenna. The possibility to adjust the pass band of a repeater helps to cover any specific segment or frequency band.

2.1.4 Block diagram of measurement reference points

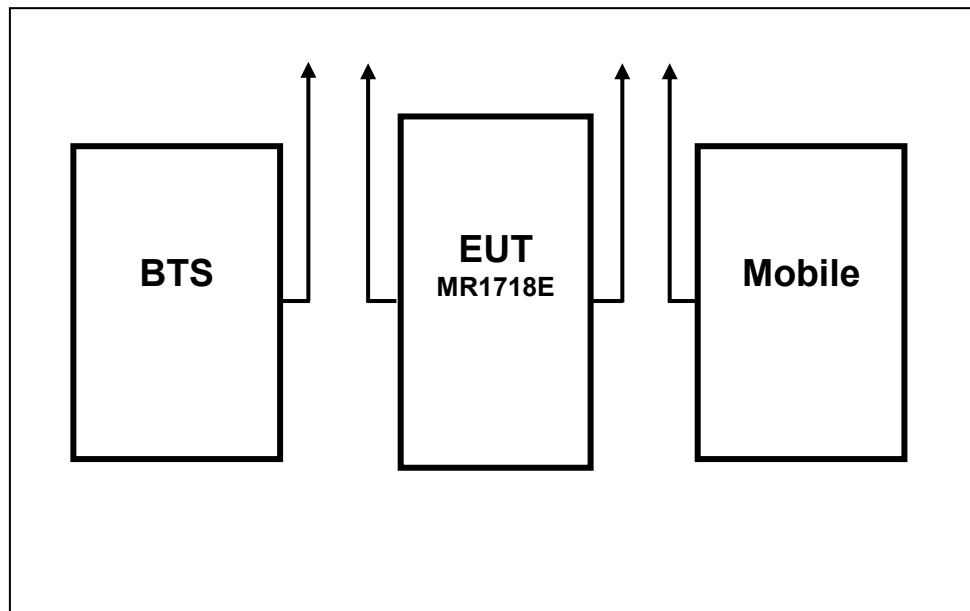

figure 2.1.4-#1 Block diagram of measurement reference points

Reference point A, Mobile: Repeater DL output, UL input
Reference point B, BTS: Repeater UL output, DL input



2.1.5 Test site (Andrew Buchdorf)

2.2 Test environment

All tests were performed under the following environmental conditions:

| Condition | Minimum value | Maximum value |
|---------------------|-----------------------|---------------|
| Barometric pressure | 86 kPa | 106 kPa |
| Temperature | 15°C | 30°C |
| Relative Humidity | 20 % | 75 % |
| Power supply range | ±5% of rated voltages | |

2.3 Test

| ANDREW Inv. No. | Test equipment | Type | Manufacturer | Serial No. | Calibration |
|-----------------|-------------------|----------------------|--------------|------------|-------------|
| 9300 | Network Analyzer | ZNB 20 | R&S | 101490 | 6/2017 |
| 9236 | Spectrum Analyzer | FSV 30 | R&S | 101345 | 8/2016 |
| 8990 | Generator | SMJ 100A | R&S | 101288 | 06/2017 |
| 9123 | Generator | SMBV100A | R&S | 257408 | 11/2016 |
| 8667 | Power Meter | E4418B | Agilent | GB40204380 | 04/2017 |
| 8668 | Power Sensor | E9300B | Agilent | US40010210 | 04/2017 |
| 7538 | RF-Cable N/N | Testpro 4.2 DC-18GHz | Radial | 1502739 | CIU |
| 7158 | RF-Cable N/N | Testpro 4.2 DC-18GHz | Radial | 1502924 | CIU |
| ----- | RF-Cable N/SMA | Testpro 4.2 DC-18GHz | Radial | 1508195 | CIU |
| ----- | RF-Cable N/SMA | Testpro 4.2 DC-18GHz | Radial | 1508194 | CIU |
| | | | | | |
| | | | | | |
| | | | | | |
| 7531 | Notch Filter | 2110 - 2180 MHz | Wainwright | 1 | CIU |
| 7406 | Switch-Matrix | | Andrew | | CIU |

CIU = Calibrate in use



2.4 Input and output losses

All recorded power levels should be referenced to the input and output connectors of the repeater, unless explicitly stated otherwise.

The test equipment used in this test has to be calibrated, so that the functionality is also checked.

All cables, attenuators, splitter, isolator, circulator and combiner etc. must be measured before testing and used for compensation during testing.

2.5 Measurement uncertainty

The extended measurement uncertainty corresponds to the measurement results from the standard measurement uncertainty multiplied by the coverage factor $k=2$. The true value is located in the corresponding interval with a probability of 95 %.

3 Test site (Bureau Veritas Consumer Products Services)

FCC Test site: 96997

See relevant dates under section 9 of this test report.



4 RF Power Out: §27.50, §2.1046

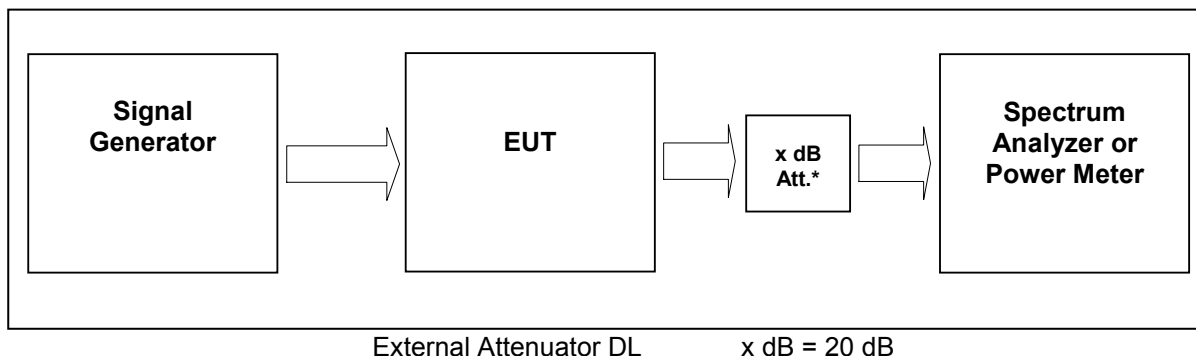

figure 4-#1 Test setup: RF Power Out: §27.50, §2.1046

| | |
|-------------------------|--|
| Measurement uncertainty | ± 0,38 dB |
| Test equipment used | 9236, 9123, 9300, 8990, 8668, 8667, 7406 |

4.1 Limit

Minimum standard:

Para. No.27.50(d)

(d) The following power and antenna height requirements apply to stations transmitting in the 1695-1710 MHz, 1710-1755 MHz, 1755-1780 MHz, 1915-1920 MHz, 1995-2000 MHz, 2000-2020 MHz, 2110-2155 MHz, 2155-2180 MHz and 2180-2200 MHz bands:

(2) The power of each fixed or base station transmitting in the 1995-2000 MHz, the 2110-2155 MHz 2155-2180 MHz band, or 2180-2200 MHz band and situated in any geographic location other than that described in paragraph (d)(1) of this section is limited to:

- (i) An equivalent isotropically radiated power (EIRP) of 1640 watts when transmitting with an emission bandwidth of 1 MHz or less;
- (ii) An EIRP of 1640 watts/MHz when transmitting with an emission bandwidth greater than 1 MHz.

4.2 Test method

§ 2.1046 Measurements required: RF power output.

(a) For transmitters other than single sideband, independent sideband and controlled carrier radiotelephone, power output shall be measured at the RF output terminals when the transmitter is adjusted in accordance with the tune-up procedure to give the values of current and voltage on the circuit elements specified in § 2.1033(c)(8). The electrical characteristics of the radio frequency load attached to the output terminals when this test is made shall be stated.

(c) For measurements conducted pursuant to paragraphs (a) and (b) of this section, all calculations and methods used by the applicant for determining carrier power or peak envelope power, as appropriate, on the basis of measured power in the radio frequency load attached to the transmitter output terminals shall be shown. Under the test conditions specified, no components of the emission spectrum shall exceed the limits specified in the applicable rule parts as necessary for meeting occupied bandwidth or emission limitations

Test Report No.: 16-171

FCC ID: XS5-MR17E



4.3 Test results

Detector RMS.

Test signal CDMA

Signal waveform according to table 6.2-1 of standard specification 3GPP2 C.p0051-0 v1.0 16.February 2006 pilot, sync, paging, 37 traffics, which is equal to the table 6.5.2.1 of 3GPP2 C.S0010-C v2.0 24.February 2006.

Test signal WCDMA

Signal waveform according to Test Model 1 of standard specification 3GPP TS25.141. Signal modulated with a combination of PCCPCH, SCCPCH and Dedicated Physical Channels specified as test model 1 64 DPCH.



4.3.1 Downlink

| Modulation | Measured at | Path | RBW VBW Span | RF Power (dBm) | RF Power (W) | Plot - |
|--|-------------|----------|-------------------------|----------------|--------------|------------|
| CDMA | Middle | 2145 MHz | 3MHz 10MHz 15MHz | 22,0 | 0.158 | 4.3.3.1 #1 |
| WCDMA | Middle | 2145 MHz | 10MHz 10MHz 50MHz | 18,0 | 0.063 | 4.3.3.2 #1 |
| Maximum output power UMTS = 18.0 dBm = 0.063 W | | | | | | |
| Maximum output power CDMA = 22.0 dBm = 0.158 W | | | | | | |
| Limit Maximum output power (erp) = 1000 W | | | | | | |

table 4.3.1-#1 RF Power Out: §27.50, §2.1046 Test results Downlink

The max RF Power out is 22.0 dBm, so the maximum antenna gain (x) can be calculated as follow:

Limit = 1000W (erp) = 60 dBm

Info: 1000W (erp) = 1640W (eirp)

$$60 \text{ dBm} > 22.0 \text{ dBm} + x \quad \text{-----} > \quad x = 60 \text{ dBm} - 22.0 \text{ dBm} = \underline{38 \text{ dBd}}$$

$$x \text{ dBi} = 38 \text{ dBd} + 2.15 = \underline{40.15 \text{ dBi}}$$

=> The antenna that will be used for the complete system have to have a gain lower than 40.15 dBi, relative to a dipol.

| Modulation | Pin / dBm (Ref. point A) |
|------------|-----------------------------|
| CDMA | -57.6 |
| WCDMA | -53.4 |

table 4.3.1-#2 RF Power Out: §27.50, §2.1046 Test results Downlink Input power



4.3.2 Uplink

| Modulation | Measured at | Path | RBW VBW Span | RF Power (dBm) | RF Power (W) | Plot - |
|---|-------------|----------|-------------------------|----------------|--------------|------------|
| CDMA | Middle | 1745 MHz | 3MHz 10MHz 15MHz | 22,0 | 0.158 | 4.3.4.1 #1 |
| WCDMA | Middle | 1745 MHz | 10MHz 10MHz 50MHz | 18,0 | 0.063 | 4.3.4.2 #1 |
| Maximum output power UMTS = 18.0 dBm = W | | | | | | |
| Maximum output power CDMA, LTE = 22.0 dBm = W | | | | | | |
| Limit Maximum output power (erp) = 1000 W | | | | | | |

table 4.3.2-#3 RF Power Out: §27.50, §2.1046 Test results Uplink

The max RF Power out is 22.0 dBm, so the maximum antenna gain (x) can be calculated as follow:

Limit = 1000W (erp) = 60 dBm

Info: 1000W (erp) = 1640W (eirp)

$60 \text{ dBm} > 22.0 \text{ dBm} + x \quad \text{-----} > \quad x = 60 \text{ dBm} - 22.0 \text{ dBm} = \underline{38 \text{ dBd}}$

$x \text{ dBi} = 38 \text{ dBd} + 2.15 = \underline{40.15 \text{ dBi}}$

=> The antenna that will be used for the complete system have to have a gain lower than 40.15 dBi, relative to a dipol.

| Modulation | Pin / dBm (Ref. point A) |
|------------|-----------------------------|
| CDMA | -56,0 |
| WCDMA | -59,8 |

table 4.3.2-#4 RF Power Out: §27.50, §2.1046 Test results Uplink Input power



4.3.3 Downlink

4.3.3.1 CDMA

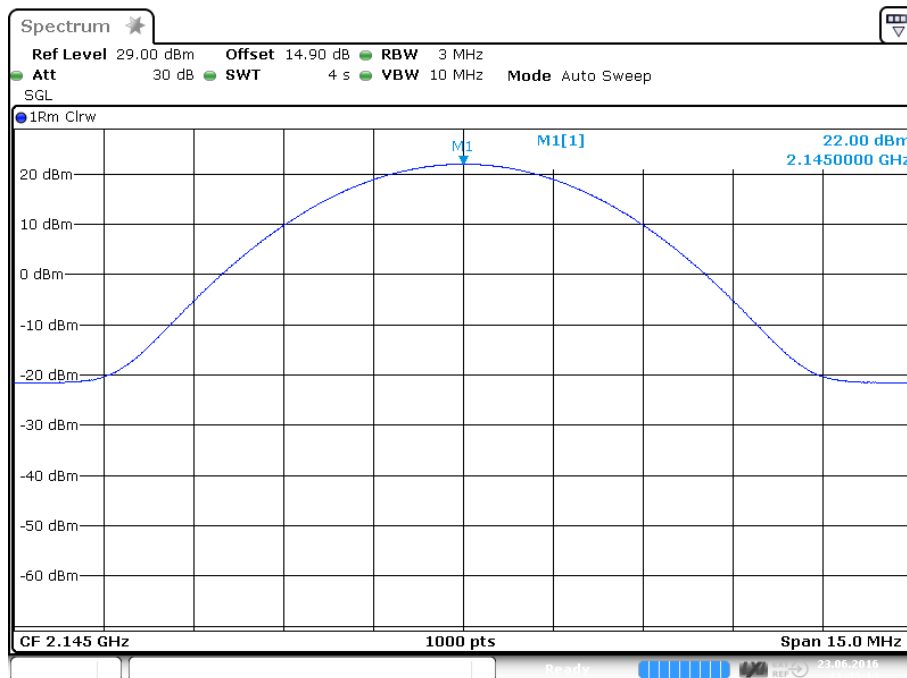

Date: 23 JUN 2016 11:43:13

plot 4.3.3.1-#1 RF Power Out: §27.50, §2.1046; Test results; Downlink; CDMA Middle

4.3.3.2 W-CDMA

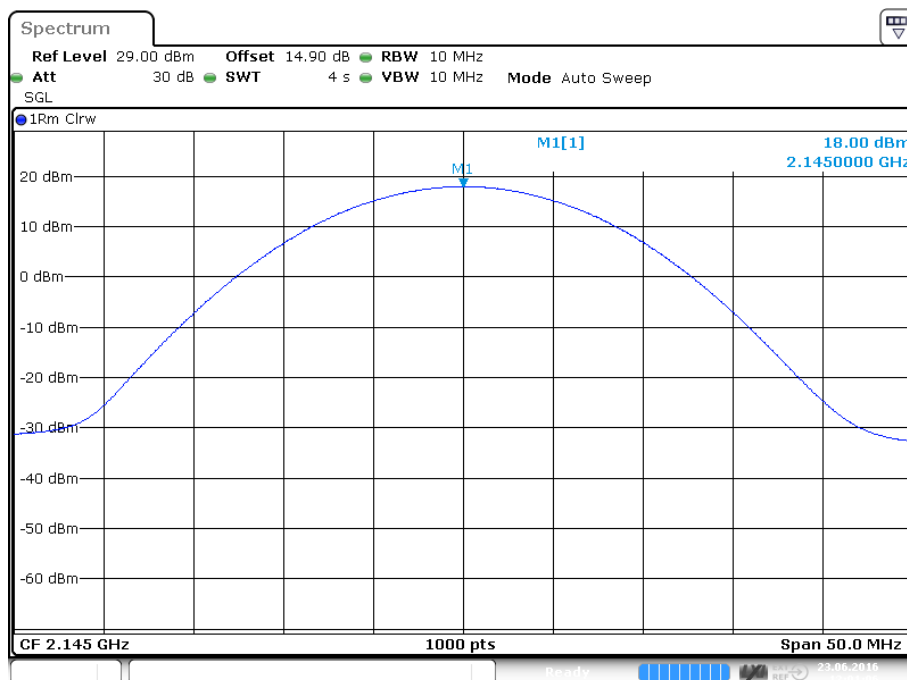

Date: 23 JUN 2016 12:01:06

plot 4.3.3.2-#1 RF Power Out: §27.50, §2.1046; Test results; Downlink; W-CDMA Middle



4.3.4 Uplink

4.3.4.1 CDMA

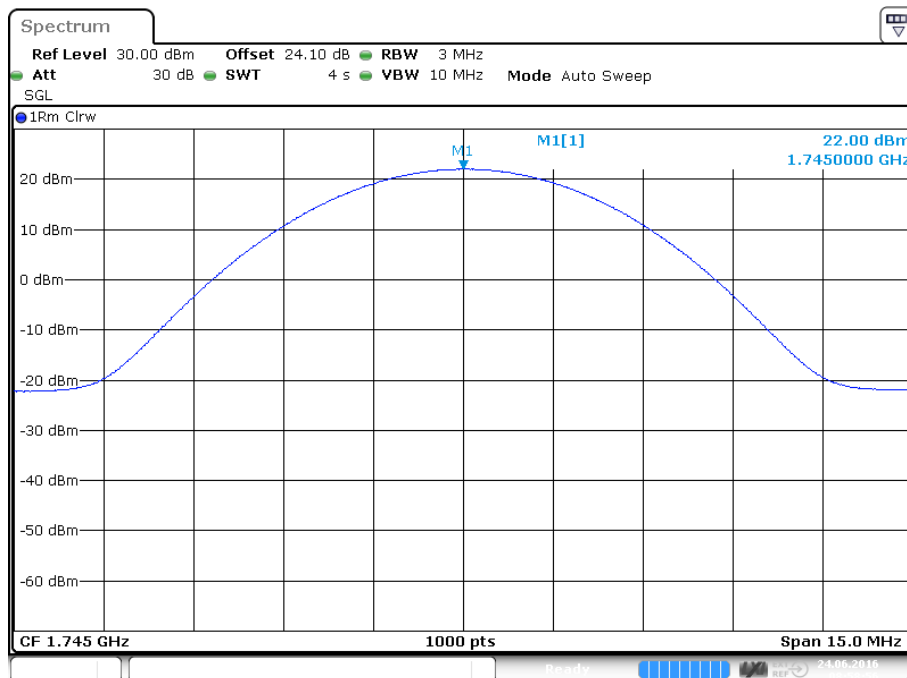

Date: 24 JUN 2016 08:58:55

plot 4.3.4.1-#1 RF Power Out: §27.50, §2.1046; Test results; Uplink; CDMA Middle

4.3.4.2 W-CDMA

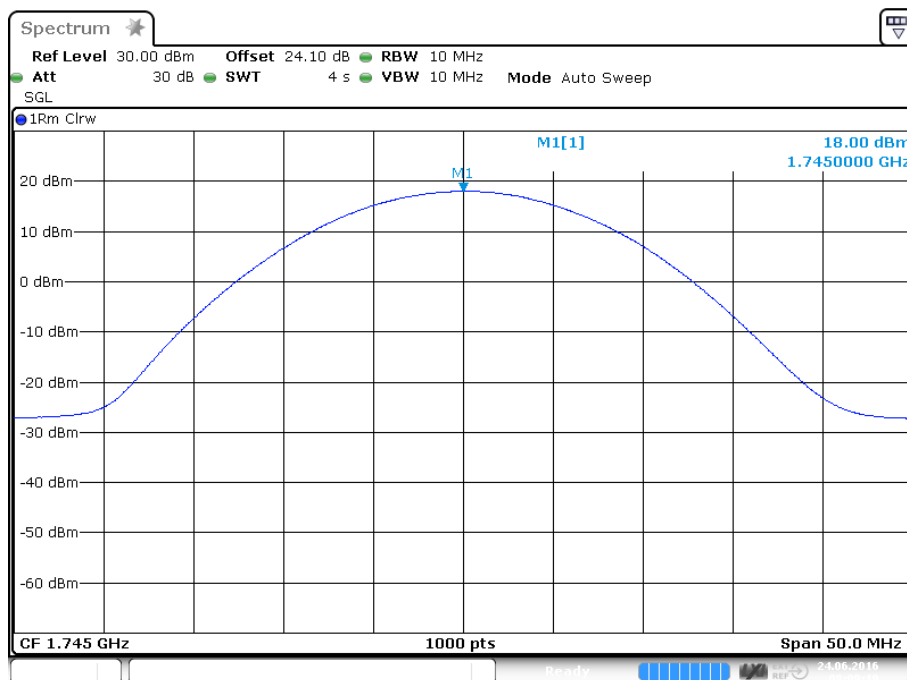

Date: 24 JUN 2016 08:09:20

plot 4.3.4.2-#1 RF Power Out: §27.50, §2.1046; Test results; Uplink; W-CDMA Middle

Test Report No.: 16-171

FCC ID: XS5-MR17E



BUREAU
VERITAS

4.4 Summary test result

| | |
|-------------|-------------------------------------|
| Test result | complies, according the plots above |
| Tested by: | W. Meir |
| Date: | 24.06.2016 |



5 Occupied Bandwidth: §2.1049

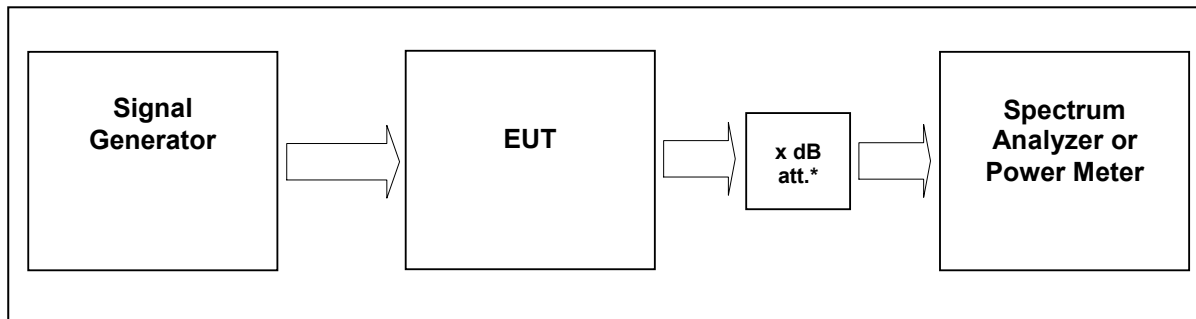

External Attenuator DL x dB = 20 dB
figure 5-#1 Test setup: Occupied Bandwidth: §2.1049

| | |
|-------------------------|--|
| Measurement uncertainty | ± 0,38 dB |
| Test equipment used | 9236, 9123, 9300, 8990, 8668, 8667, 7406 |

5.1 Limit

The spectral shape of the output should look similar to input for all modulations.

5.2 Test method

Para. No.2.1049

The occupied bandwidth, that is the frequency bandwidth such that, below its lower and above its upper frequency limits, the mean powers radiated are each equal to 0.5 percent of the total mean power radiated by a given emission shall be measured under the following conditions as applicable:

(h) Transmitters employing digital modulation techniques—when modulated by an input signal such that its amplitude and symbol rate represent the maximum rated conditions under which the equipment will be operated. The signal shall be applied through any filter networks, pseudo-random generators or other devices required in normal service. Additionally, the occupied bandwidth shall be shown for operation with any devices used for modifying the spectrum when such devices are optional at the discretion of the user.



5.3 Test results

5.3.1 Downlink

Detector PK.

| Modulation | Measured at | F center / MHz | RBW VBW Span | Occupied Bandwidth / MHz | Plot # |
|------------|-------------|----------------|-------------------------|--------------------------------|-------------------|
| CDMA | Middle | 2145 | 30kHz 300kHz 5MHz | 1,24 | 5.3.3.1 #1, #2 |
| WCDMA | Middle | 2145 | 100kHz 1MHz 10MHz | 4,18 | 5.3.3.2 #1, #2 |

| Modulation | Measured at | F center / MHz | RBW VBW Span | 26dB Bandwidth / MHz | Plot # |
|------------|-------------|----------------|-------------------------|----------------------------|-------------------|
| CDMA | Middle | 2145 | 30kHz 300kHz 5MHz | 1,39 | 5.3.4.1 #1, #2 |
| WCDMA | Middle | 2145 | 100kHz 1MHz 10MHz | 4,73 | 5.3.4.2 #1, #2 |

table 5.3-#1 Occupied Bandwidth: §2.1049 Test results Downlink



5.3.2 Uplink

Detector PK.

| Modulation | Measured at | F center / MHz | RBW VBW Span | Occupied Bandwidth / MHz | Plot # |
|------------|-------------|----------------|-------------------------|--------------------------------|-------------------|
| CDMA | Middle | 1745 MHz | 30kHz 300kHz 5MHz | 1,24 | 5.3.5.1 #1, #2 |
| WCDMA | Middle | 1745 MHz | 100kHz 1MHz 10MHz | 4,18 | 5.3.5.2 #1, #2 |

26 dB Bandwidth

| Modulation | Measured at | F center / MHz | RBW VBW Span | 26dB Bandwidth / MHz | Plot # |
|------------|-------------|----------------|-------------------------|----------------------------|-------------------|
| CDMA | Middle | 1745 MHz | 30kHz 300kHz 5MHz | 1,39 | 5.3.6.1 #1, #2 |
| WCDMA | Middle | 1745 MHz | 100kHz 1MHz 10MHz | 4,73 | 5.3.6.2 #1, #2 |

table 5.3-#2 Occupied Bandwidth: §2.1049 Test results Uplink



5.3.3 Downlink

5.3.3.1 CDMA

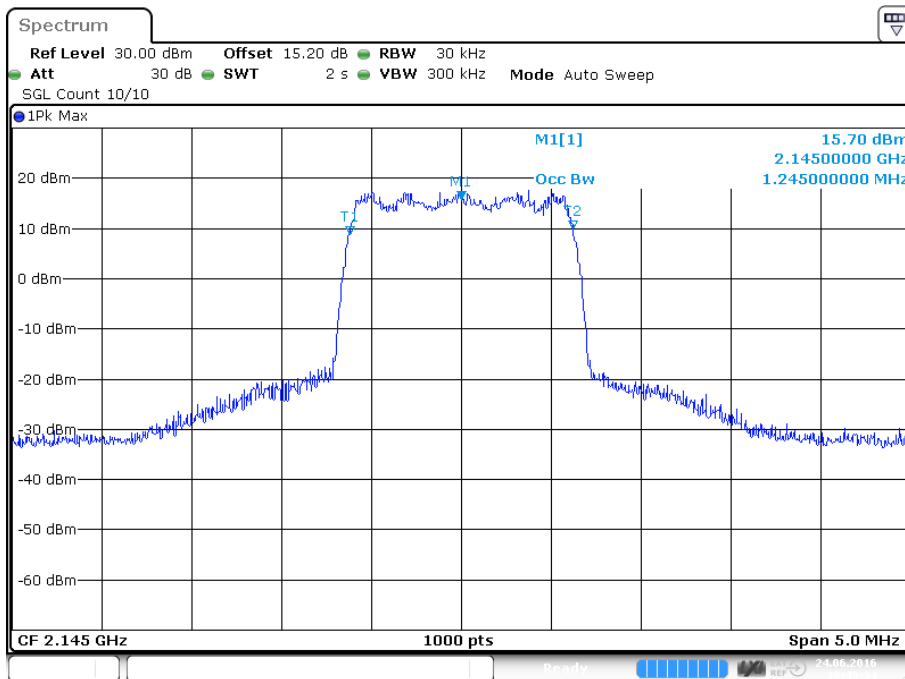

Date: 24 JUN 2016 10:43:35

plot 5.3.3.1-#1 Occupied Bandwidth: §2.1049; Test results; Downlink; CDMA Output

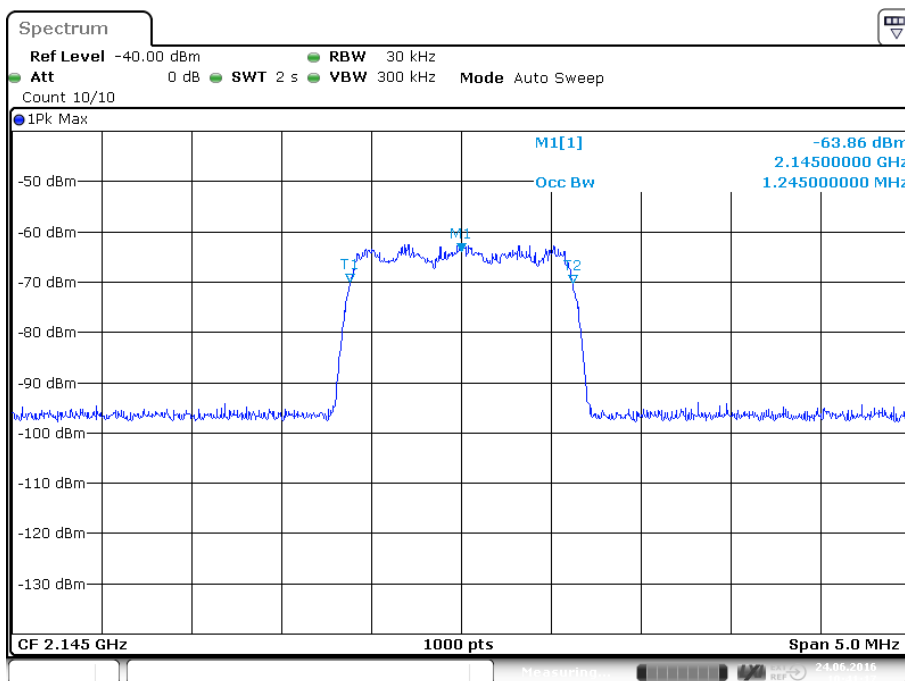

Date: 24 JUN 2016 10:41:18

plot 5.3.3.1-#2 Occupied Bandwidth: §2.1049; Test results; Downlink; CDMA Input



5.3.3.2 W-CDMA

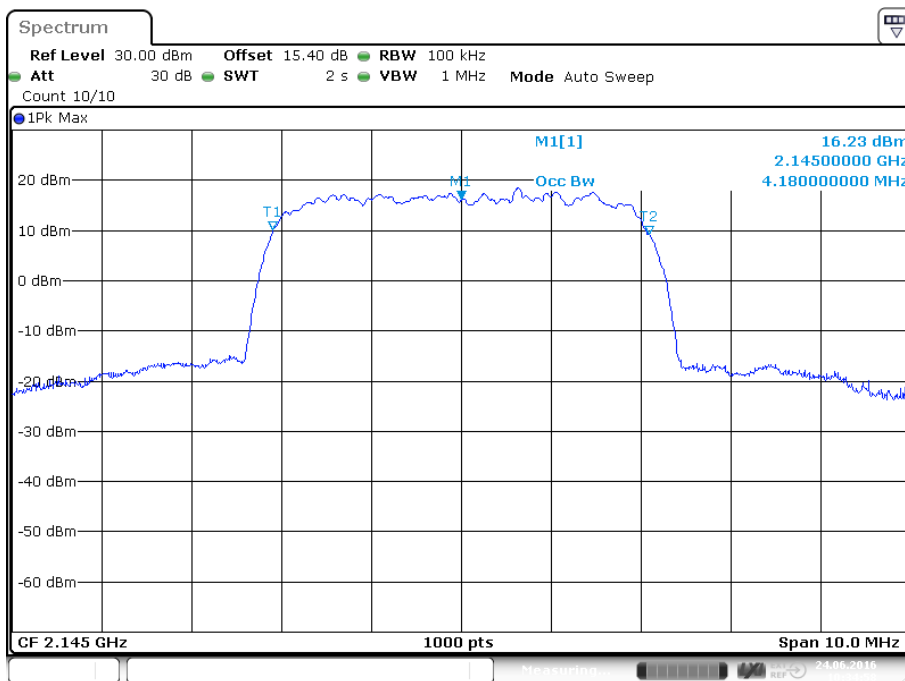

plot 5.3.3.2-#1 Occupied Bandwidth: §2.1049; Test results; Downlink; W-CDMA Output

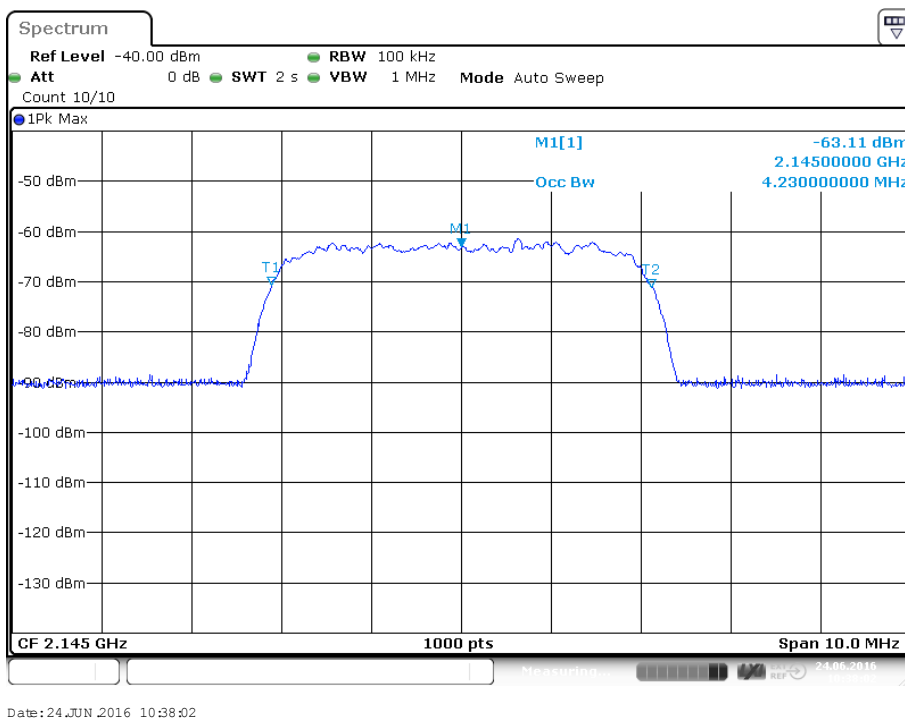

plot 5.3.3.2-#2 Occupied Bandwidth: §2.1049; Test results; Downlink; W-CDMA Input



5.3.4 26dB Bandwidth

5.3.4.1 CDMA

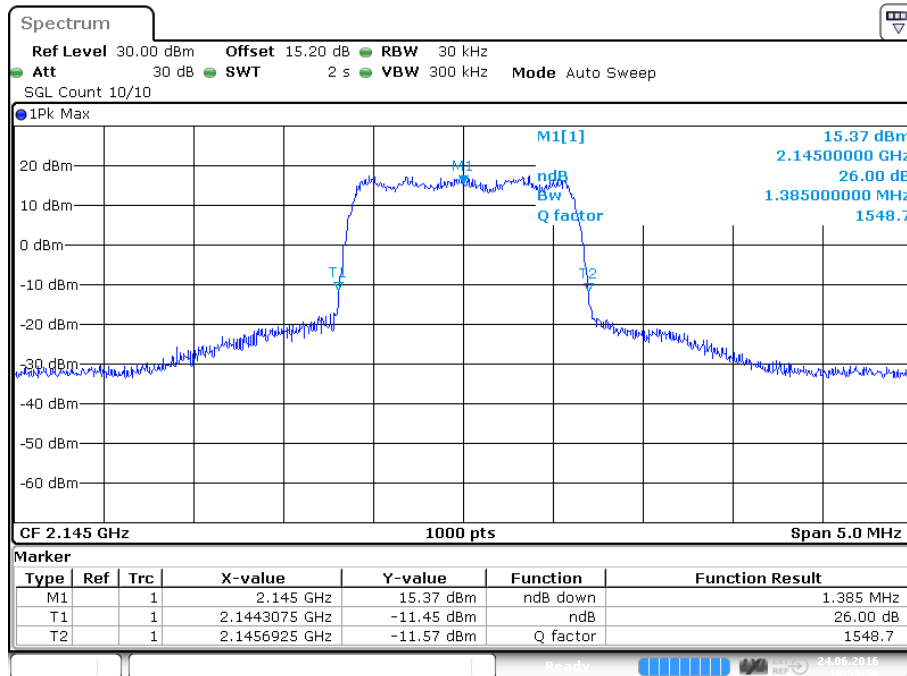

Date: 24 JUN 2016 10:59:58

plot 5.3.4.1-#1 Occupied Bandwidth: \$2.1049; Test results; 26dB Bandwidth; CDMA Output

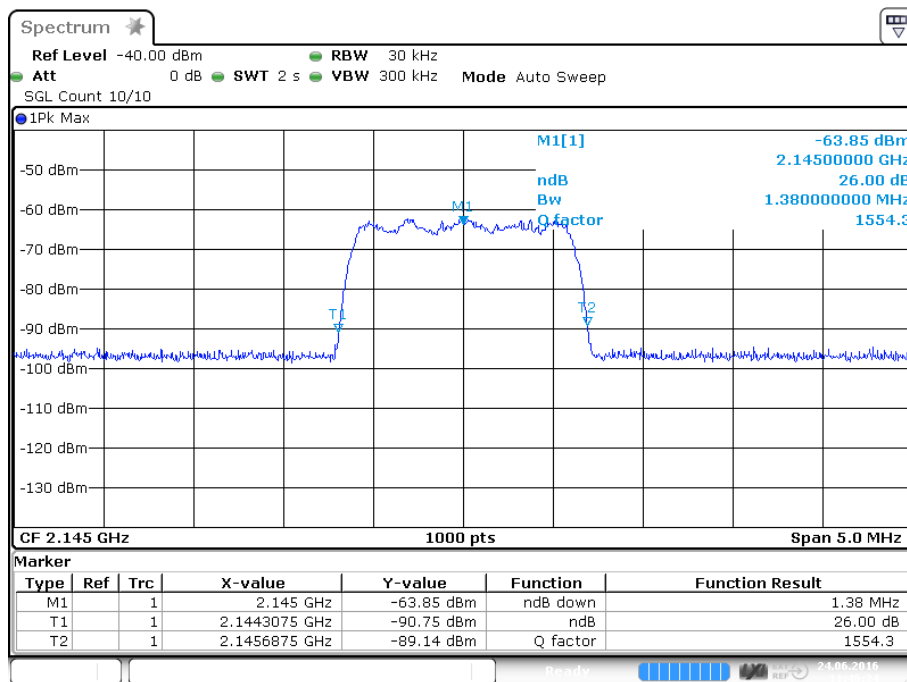

Date: 24 JUN 2016 11:46:34

plot 5.3.4.1-#2 Occupied Bandwidth: \$2.1049; Test results; 26dB Bandwidth; CDMA Input



5.3.4.2 W-CDMA

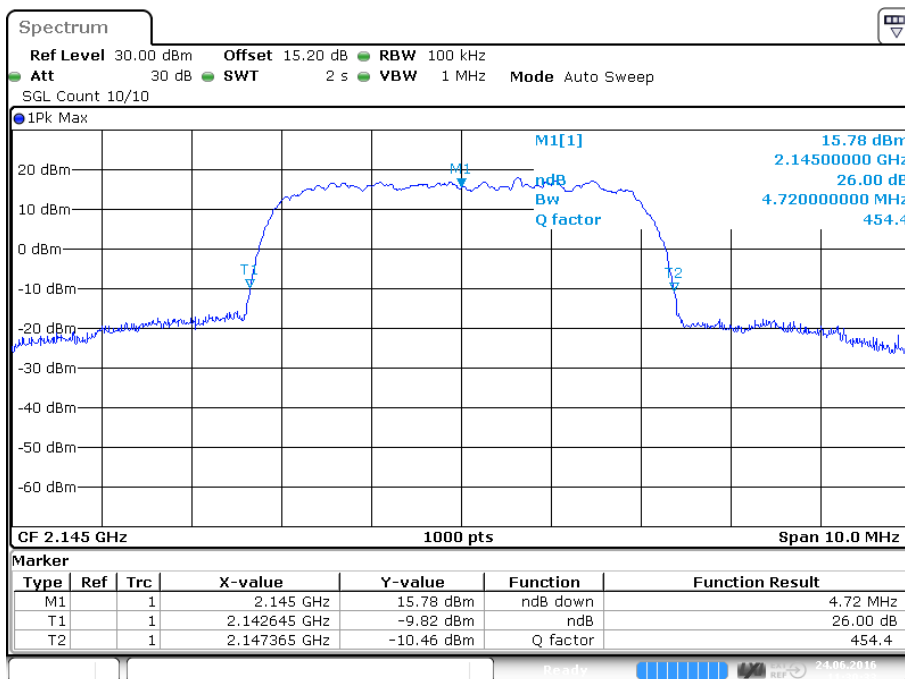

plot 5.3.4.2-#1 Occupied Bandwidth: §2.1049; Test results; 26dB Bandwidth; W-CDMA Output

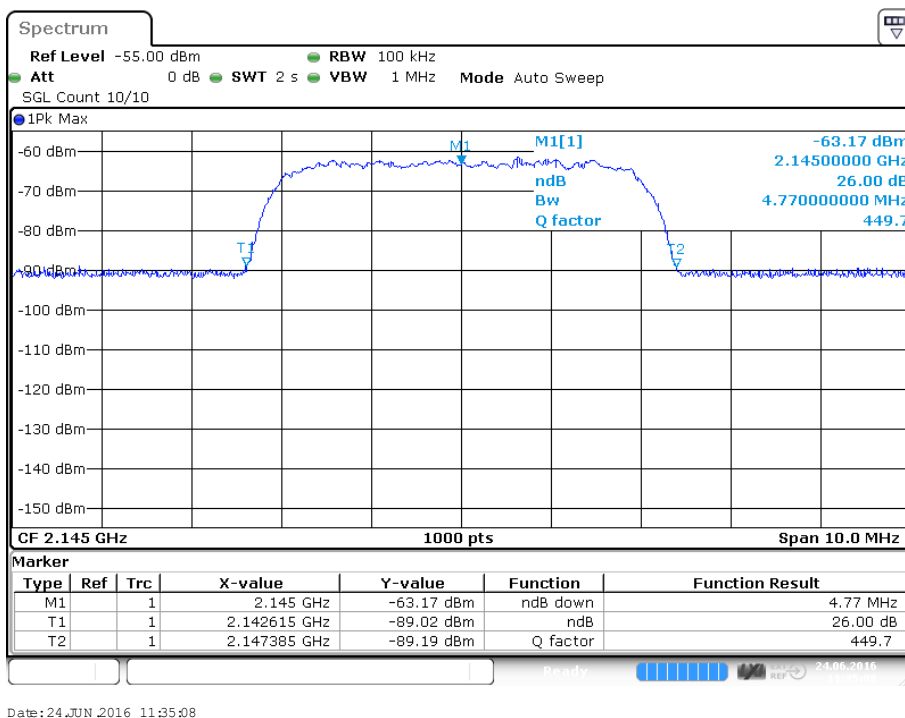

plot 5.3.4.2-#2 Occupied Bandwidth: §2.1049; Test results; 26dB Bandwidth; W-CDMA Input



5.3.5 Uplink

5.3.5.1 CDMA

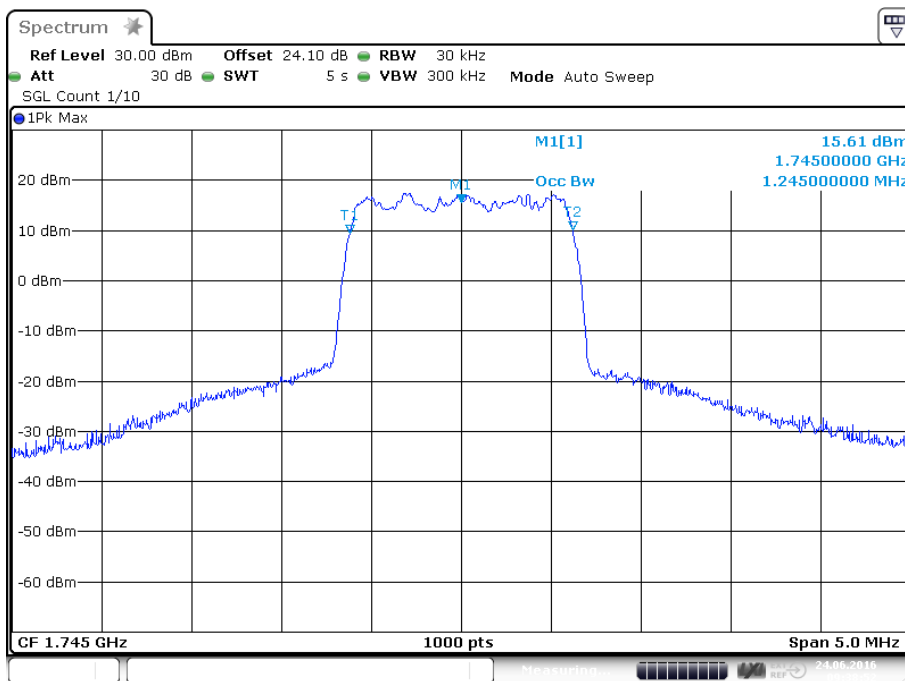

plot 5.3.5.1-#1 Occupied Bandwidth: §2.1049; Test results; Uplink; CDMA Output

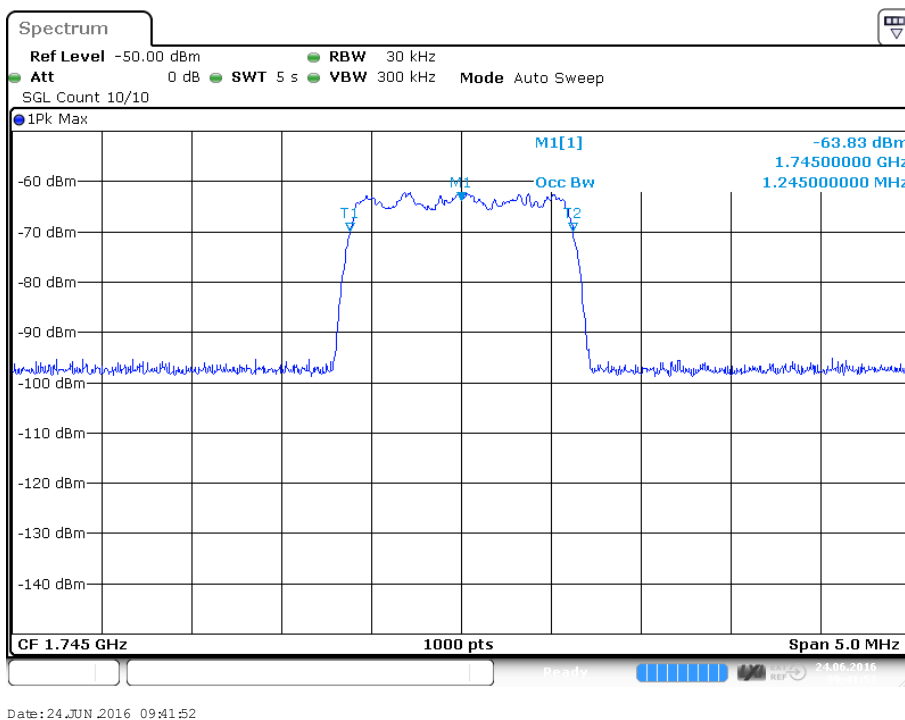

plot 5.3.5.1-#2 Occupied Bandwidth: §2.1049; Test results; Uplink; CDMA Input



5.3.5.2 W-CDMA

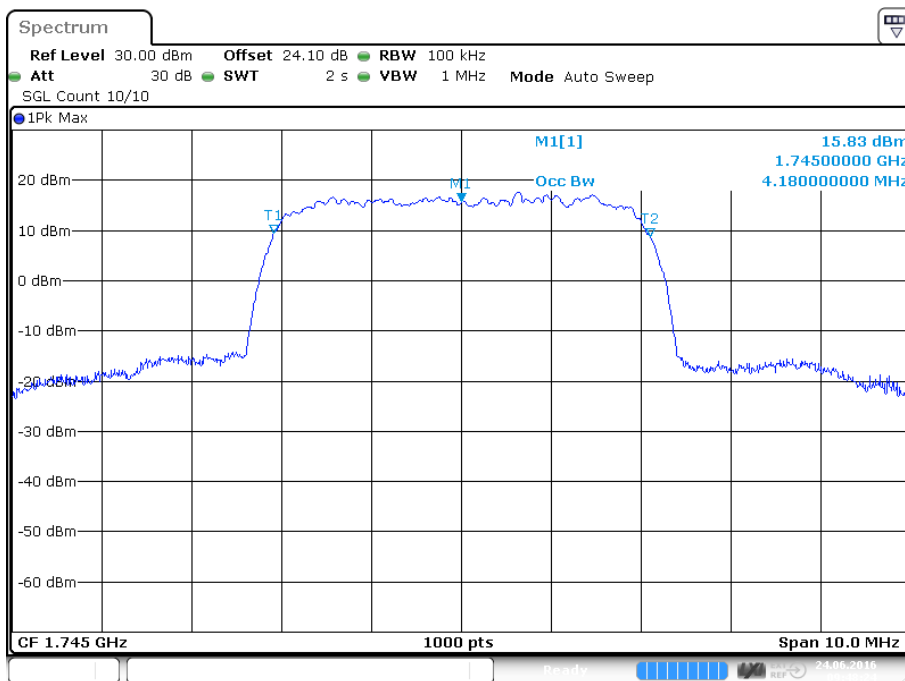

plot 5.3.5.2-#1 Occupied Bandwidth: 4.18000000 MHz; Test results; Uplink; W-CDMA Output

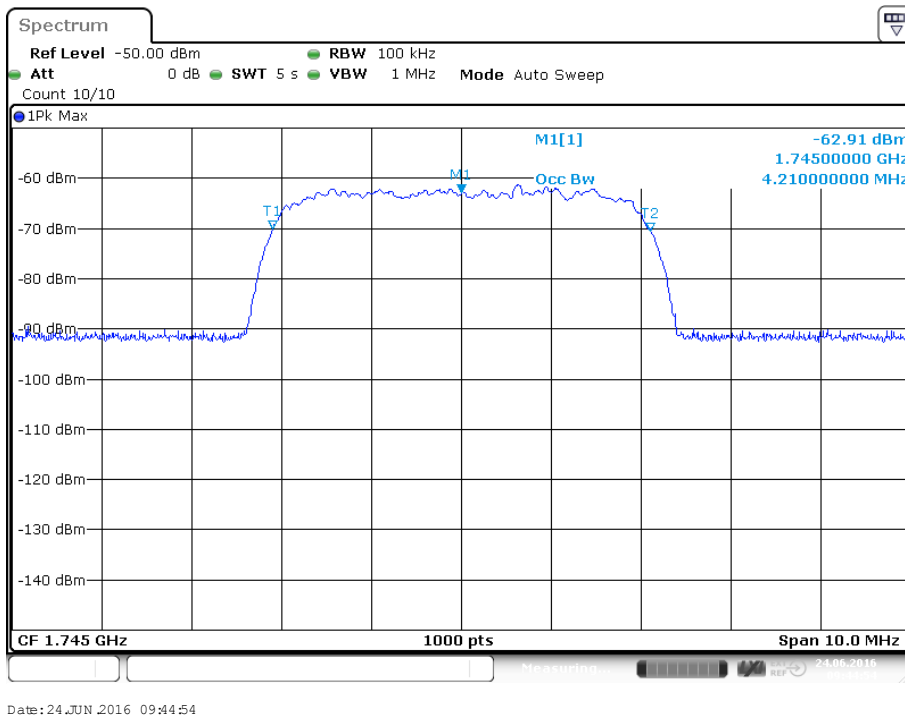

plot 5.3.5.2-#2 Occupied Bandwidth: 4.21000000 MHz; Test results; Uplink; W-CDMA Input



5.3.6 26dB Bandwidth

5.3.6.1 CDMA

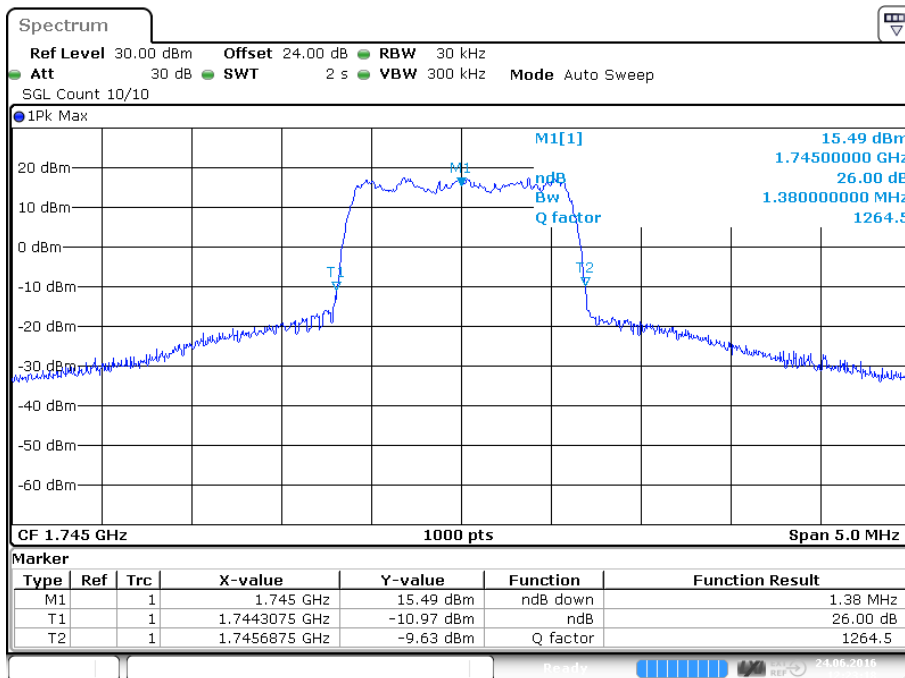

Date: 24 JUN 2016 12:23:19

plot 5.3.6.1-#1 Occupied Bandwidth: \$2.1049; Test results; 26dB Bandwidth; CDMA Output

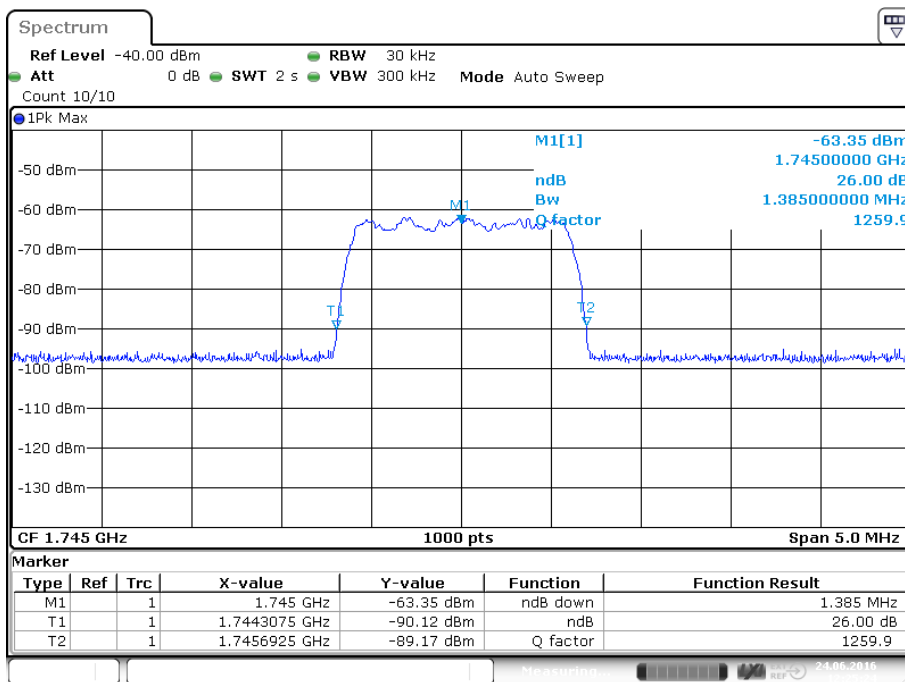

Date: 24 JUN 2016 12:25:24

plot 5.3.6.1-#2 Occupied Bandwidth: \$2.1049; Test results; 26dB Bandwidth; CDMA Input



5.3.6.2 W-CDMA

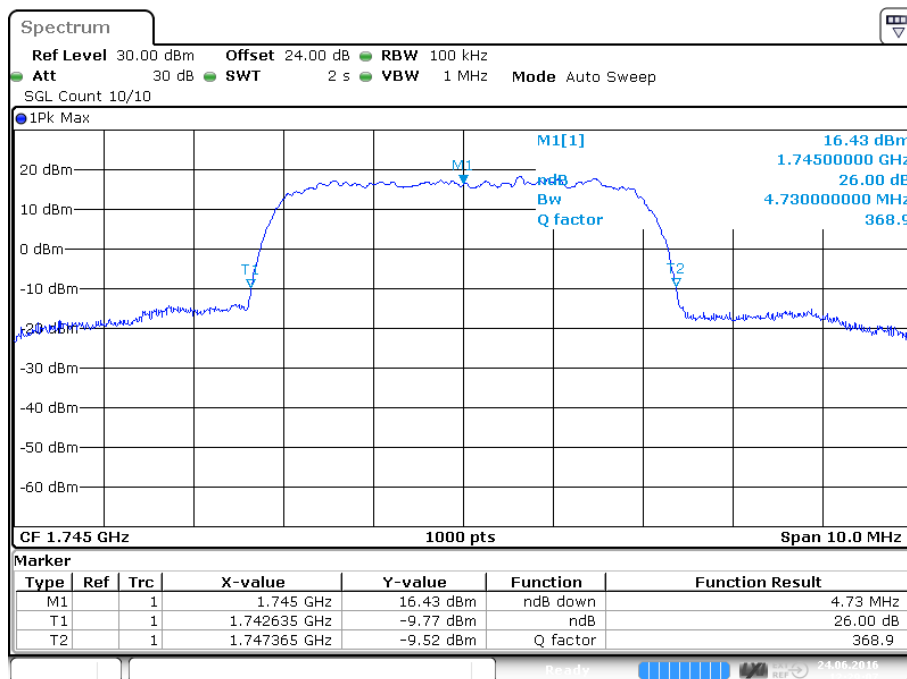

Date: 24 JUN 2016 12:29:07

plot 5.3.6.2-#1 Occupied Bandwidth: §2.1049; Test results; 26dB Bandwidth; W-CDMA Output

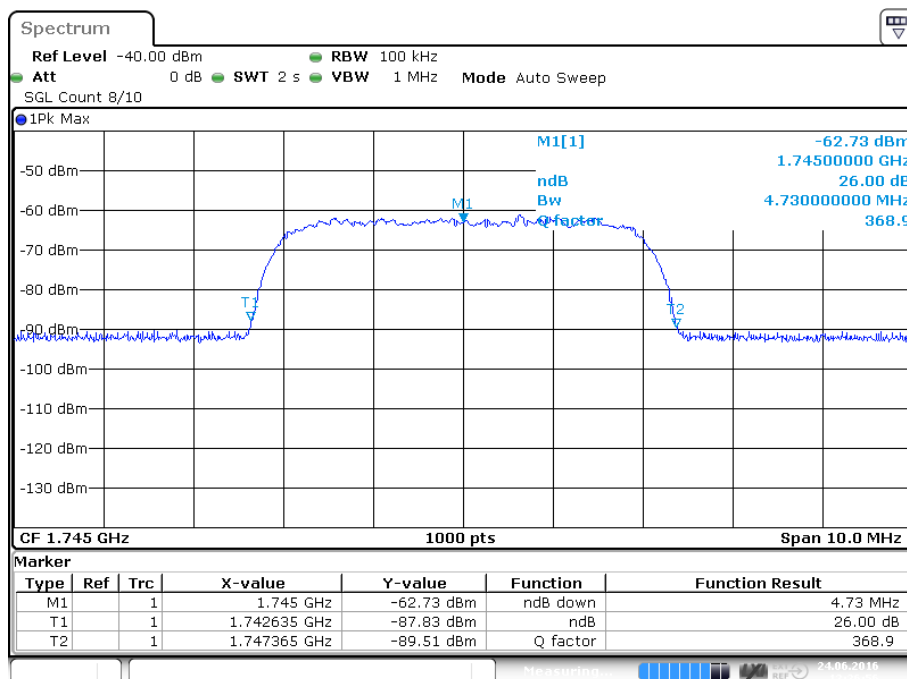

Date: 24 JUN 2016 12:26:56

plot 5.3.6.2-#2 Occupied Bandwidth: §2.1049; Test results; 26dB Bandwidth; W-CDMA Input

Test Report No.: 16-171

FCC ID: XS5-MR17E



BUREAU
VERITAS

5.4 Summary test result

| | |
|-------------|-------------------------------------|
| Test result | complies, according the plots above |
| Tested by: | W. Meir |
| Date: | 24.06.2016 |



6 Spurious Emissions at Antenna Terminals: §27.53, §2.1051

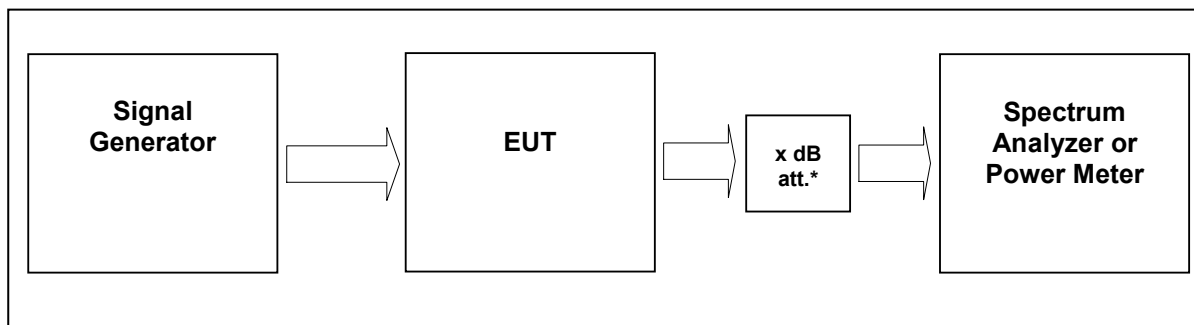

External Attenuator DL x dB = 20 dB

figure 6-#1 Test setup: Spurious Emissions at Antenna Terminals: §27.53, §2.1051

| | | |
|-------------------------|--|---|
| Measurement uncertainty | ± 0,54 dB ± 1,2 dB ± 1,5 dB | 9 kHz to 3 GHz 3 GHz to 7 GHz 7 GHz to 26 GHz |
| Test equipment used | 9236, 9123, 9300, 8990, 8668, 8667, 7406 | |

6.1 Limit

Minimum standard:

Para. No.27.53(h)

(h) *AWS emission limits*

(1) *General protection levels.* Except as otherwise specified below, for operations in the 1695-1710 MHz, 1710-1755 MHz, 1755-1780 MHz, 1915-1920 MHz, 1995-2000 MHz, 2000-2020 MHz, 2110-2155 MHz, 2155-2180 MHz, and 2180-2200 bands, the power of any emission outside a licensee's frequency block shall be attenuated below the transmitter power (P) in watts by at least $43 + 10 \log_{10} (P)$ dB.

(3) *Measurement procedure.* (i) Compliance with this provision is based on the use of measurement instrumentation employing a resolution bandwidth of 1 megahertz or greater. However, in the 1 megahertz bands immediately outside and adjacent to the licensee's frequency block, a resolution bandwidth of at least one percent of the emission bandwidth of the fundamental emission of the transmitter may be employed. The emission bandwidth is defined as the width of the signal between two points, one below the carrier center frequency and one above the carrier center frequency, outside of which all emissions are attenuated at least 26 dB below the transmitter power.

(ii) When measuring the emission limits, the nominal carrier frequency shall be adjusted as close to the licensee's frequency block edges, both upper and lower, as the design permits.

(iii) The measurements of emission power can be expressed in peak or average values, provided they are expressed in the same parameters as the transmitter power.

6.2 Test method

Para. No 2.1051 Measurements required: Spurious emissions at antenna terminals.

The radio frequency voltage or powers generated within the equipment and appearing on a spurious frequency shall be checked at the equipment output terminals when properly loaded with a suitable artificial antenna. Curves or equivalent data shall show the magnitude of each harmonic and other spurious emission that can be detected when the equipment is operated under the conditions specified in § 2.1049 as appropriate. The magnitude of spurious emissions which are attenuated more than 20 dB below the permissible value need not be specified.

[39 FR 5919, Feb. 15, 1974. Redesignated and amended at 63 FR 36599, July 7, 1998]



6.3 Test results

6.3.1 Downlink

Detector: RMS.

| Modulation | Carrier | RBW VBW Span | Max. level (dBm) | Plot - |
|------------|----------|-------------------------------|------------------------|---------------|
| CDMA | 2145 MHz | 1MHz 3MHz 30MHz – 23GHz | -33,7 | 6.3.3.1 #1 |
| WCDMA | 2145 MHz | 1MHz 3MHz 30MHz – 23GHz | -33,3 | 6.3.3.2 #1 |

table 6.3-#1 Spurious Emissions at Antenna Terminals: §27.53, §2.1051 Test results

6.3.2 Uplink

Detector: RMS.

| Modulation | Carrier | RBW VBW Span | Max. level (dBm) | Plot - |
|------------|----------|-------------------------------|------------------------|---------------|
| CDMA | 1745 MHz | 1MHz 3MHz 30MHz – 23GHz | -41,6 | 6.3.4.1 #1 |
| WCDMA | 1745 MHz | 1MHz 3MHz 30MHz – 23GHz | -41,8 | 6.3.4.2 #1 |

table 6.3-#2 Spurious Emissions at Antenna Terminals: §27.53, §2.1051 Test results



6.3.3 Downlink 6.3.3.1 CDMA

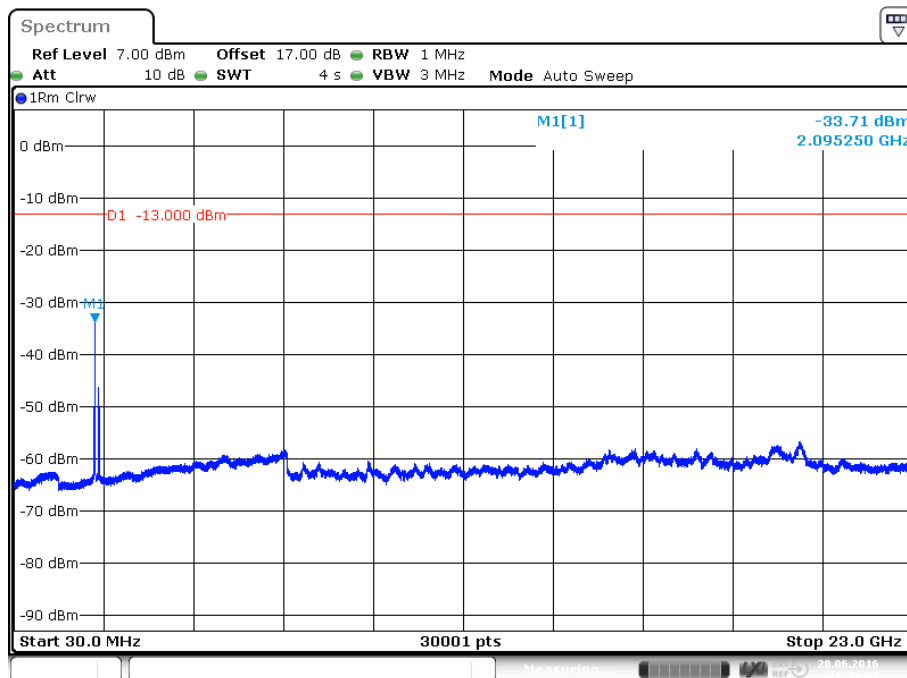

Date: 28 JUN 2016 16:40:00

plot 6.3.3.1-#1 Spurious Emissions at Antenna Terminals: §27.53, §2.1051; Test results; Downlink; CDMA; carrier (2145MHz) notched

6.3.3.2 W-CDMA

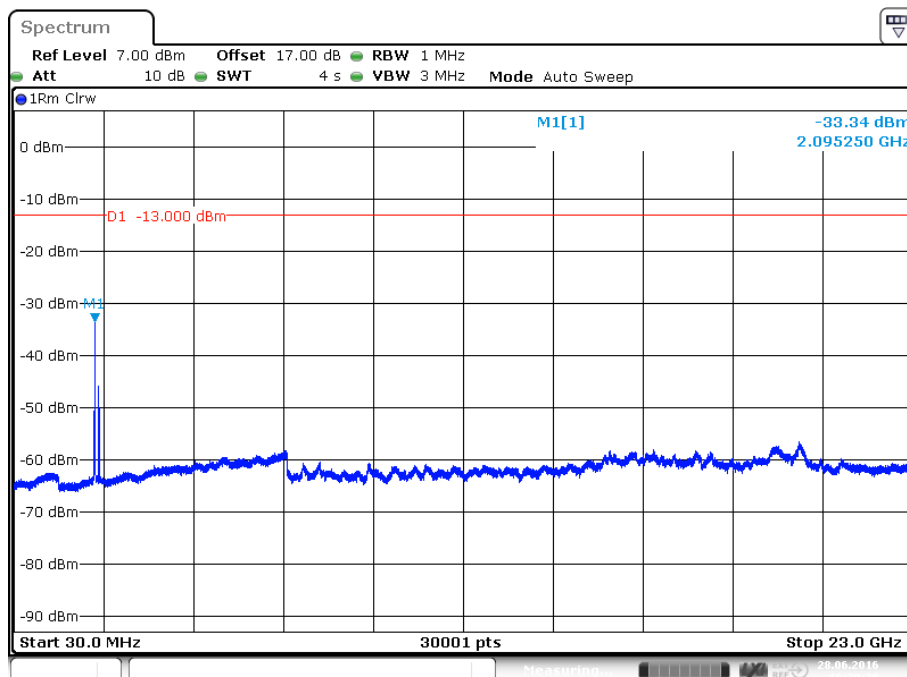

Date: 28 JUN 2016 16:39:31

plot 6.3.3.2-#1 Spurious Emissions at Antenna Terminals: §27.53, §2.1051; Test results; Downlink; W-CDMA; carrier (2145MHz) notched



6.3.4 Uplink

6.3.4.1 CDMA

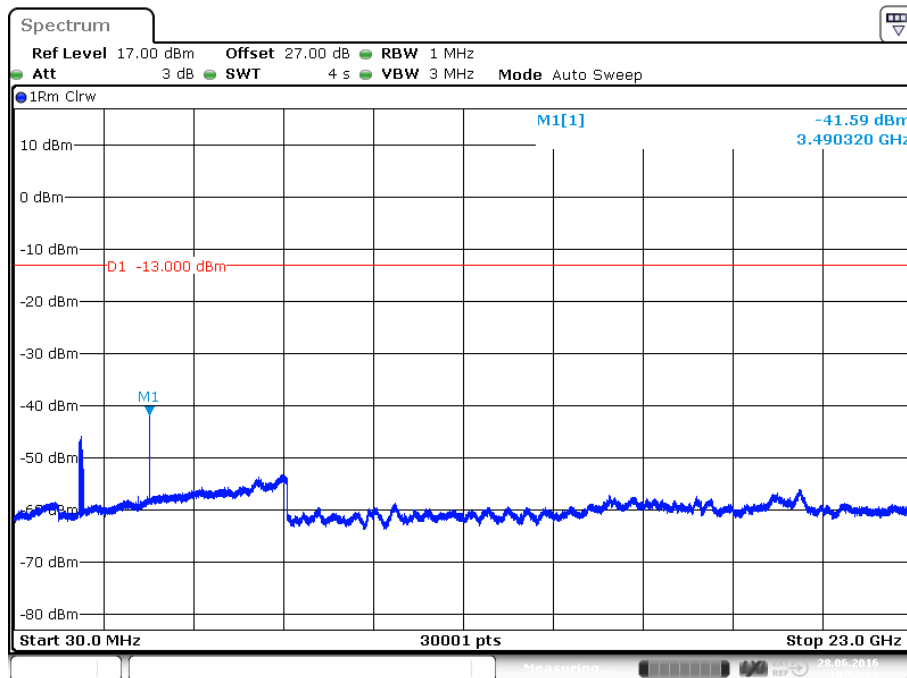

Date: 28 JUN 2016 10:52:08

plot 6.3.4.1-#1 Spurious Emissions at Antenna Terminals: §27.53, §2.1051; Test results; Uplink; CDMA; carrier (2145MHz) notched

6.3.4.2 W-CDMA

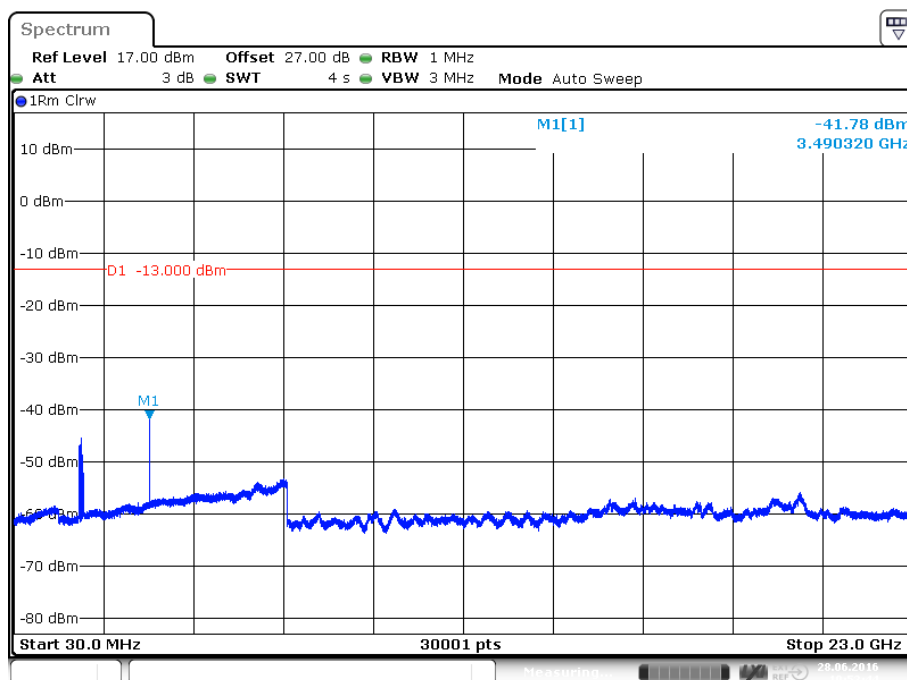

Date: 28 JUN 2016 10:52:45

plot 6.3.4.2-#1 Spurious Emissions at Antenna Terminals: §27.53, §2.1051; Test results; Uplink; W-CDMA; carrier (2145MHz) notched

Test Report No.: 16-171

FCC ID: XS5-MR17E



BUREAU
VERITAS

6.4 Summary test result

| | |
|-------------|-------------------------------------|
| Test result | complies, according the plots above |
| Tested by: | W. Meir |
| Date: | 28.06.06.2016 |



7 Intermodulation: §27.53, §2.1051

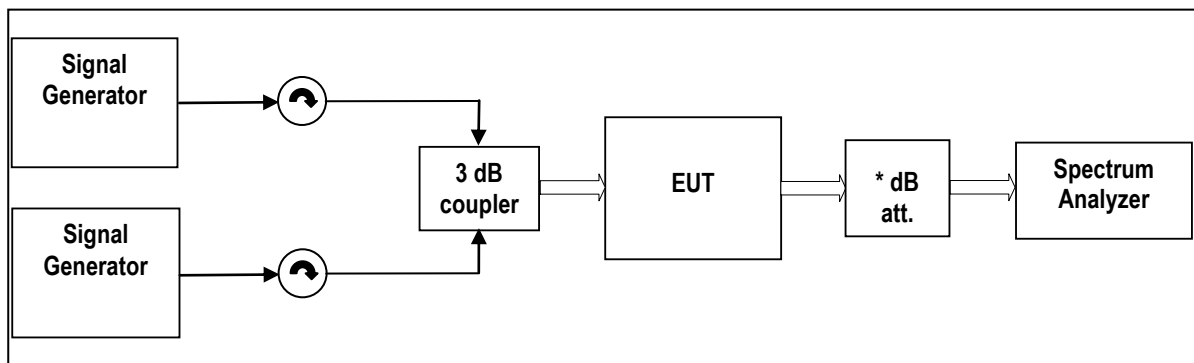

External Attenuator DL x dB = 20 dB
figure 7-#1 Test setup: Intermodulation: §27.53, §2.1051

| | | |
|-------------------------|--|---|
| Measurement uncertainty | ± 0,54 dB ± 1,2 dB ± 1,5 dB | 9 kHz to 3 GHz 3 GHz to 7 GHz 7 GHz to 26 GHz |
| Test equipment used | 9236, 9123, 9300, 8990, 8668, 8667, 7406 | |

7.1 Limit

Minimum standard:

Minimum standard:

Para. No.27.53(h)

(h) *AWS emission limits*

(1) *General protection levels.* Except as otherwise specified below, for operations in the 1695-1710 MHz, 1710-1755 MHz, 1755-1780 MHz, 1915-1920 MHz, 1995-2000 MHz, 2000-2020 MHz, 2110-2155 MHz, 2155-2180 MHz, and 2180-2200 bands, the power of any emission outside a licensee's frequency block shall be attenuated below the transmitter power (P) in watts by at least $43 + 10 \log_{10}(P)$ dB.

(3) *Measurement procedure.* (i) Compliance with this provision is based on the use of measurement instrumentation employing a resolution bandwidth of 1 megahertz or greater. However, in the 1 megahertz bands immediately outside and adjacent to the licensee's frequency block, a resolution bandwidth of at least one percent of the emission bandwidth of the fundamental emission of the transmitter may be employed. The emission bandwidth is defined as the width of the signal between two points, one below the carrier center frequency and one above the carrier center frequency, outside of which all emissions are attenuated at least 26 dB below the transmitter power.

(ii) When measuring the emission limits, the nominal carrier frequency shall be adjusted as close to the licensee's frequency block edges, both upper and lower, as the design permits.

(iii) The measurements of emission power can be expressed in peak or average values, provided they are expressed in the same parameters as the transmitter power.

7.2 Test method

Para. No 2.1051 Measurements required: Spurious emissions at antenna terminals.

The radio frequency voltage or powers generated within the equipment and appearing on a spurious frequency shall be checked at the equipment output terminals when properly loaded with a suitable artificial antenna. Curves or equivalent data shall show the magnitude of each harmonic and other spurious emission that can be detected when the equipment is operated under the conditions specified in § 2.1049 as appropriate. The magnitude of spurious emissions which are attenuated more than 20 dB below the permissible value need not be specified.

[39 FR 5919, Feb. 15, 1974. Redesignated and amended at 63 FR 36599, July 7, 1998]



7.3 Test results

7.3.1 Downlink

Detector: RMS.

| Modulation | Measured at Band Edge | Carriers | RBW VBW Span | Max. level (dBm) | Plot - |
|------------|-----------------------|------------------------------|-------------------------|------------------|---------------|
| CDMA | Lower Edge | 2110.775 MHz 2112.025 MHz | 30kHz 300kHz 6MHz | -34,1 | 7.3.3.1 #1 |
| | Upper Edge | 2177.975 MHz 2179.225 MHz | | | #2 |
| WCDMA | Lower Edge | 2112.6 MHz 2117.6 MHz | 100kHz 1MHz 15MHz | -38,0 | 7.3.3.2 #1 |
| | Upper Edge | 2172.4 MHz 2177.4 MHz | | | #2 |

table 7.3-#1 Intermodulation: §27.53, §2.1051 Test results

7.3.2 Uplink

Detector: RMS.

| Modulation | Measured at Band Edge | Carriers | RBW VBW Span | Max. level (dBm) | Plot - |
|------------|-----------------------|------------------------------|-------------------------|------------------|---------------|
| CDMA | Lower Edge | 1710.775 MHz 1712.025 MHz | 30kHz 300kHz 6MHz | -37,1 | 7.3.4.1 #1 |
| | Upper Edge | 1777.975 MHz 1779.225 MHz | | | #2 |
| WCDMA | Lower Edge | 1712.6 MHz 1717.6 MHz | 100kHz 1MHz 15MHz | -40,4 | 7.3.4.2 #1 |
| | Upper Edge | 1772.4 MHz 1777.4 MHz | | | #2 |

table 7.3-#2 Intermodulation: §27.53, §2.1051 Test results



7.3.3 Downlink

7.3.3.1 CDMA

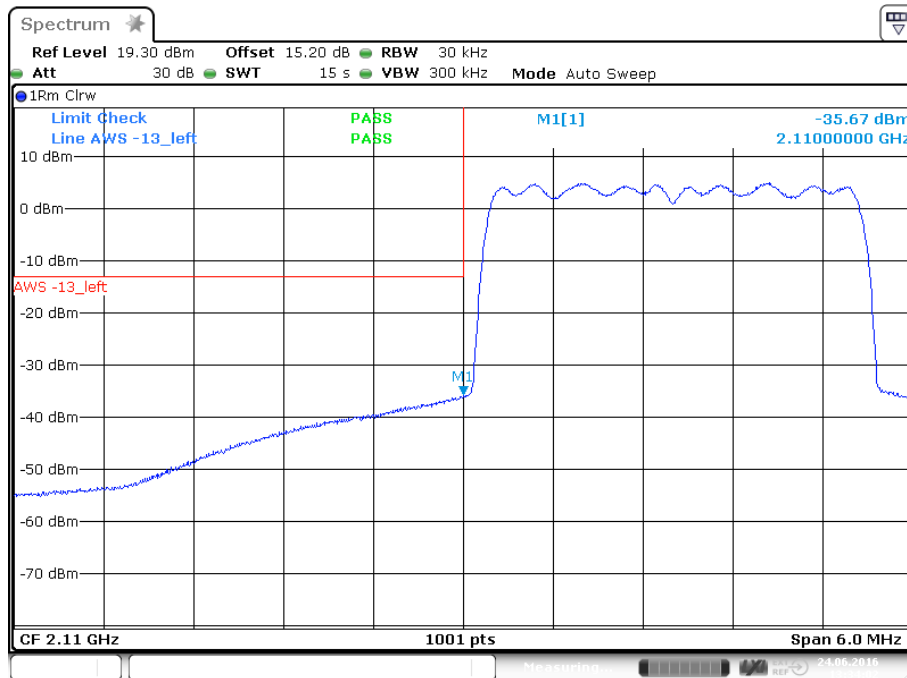

Date: 24 JUN 2016 13:34:02

plot 7.3.3.1-#1 Intermodulation: §27.53, §2.1051; Test results; Downlink; CDMA Lower Band Edge

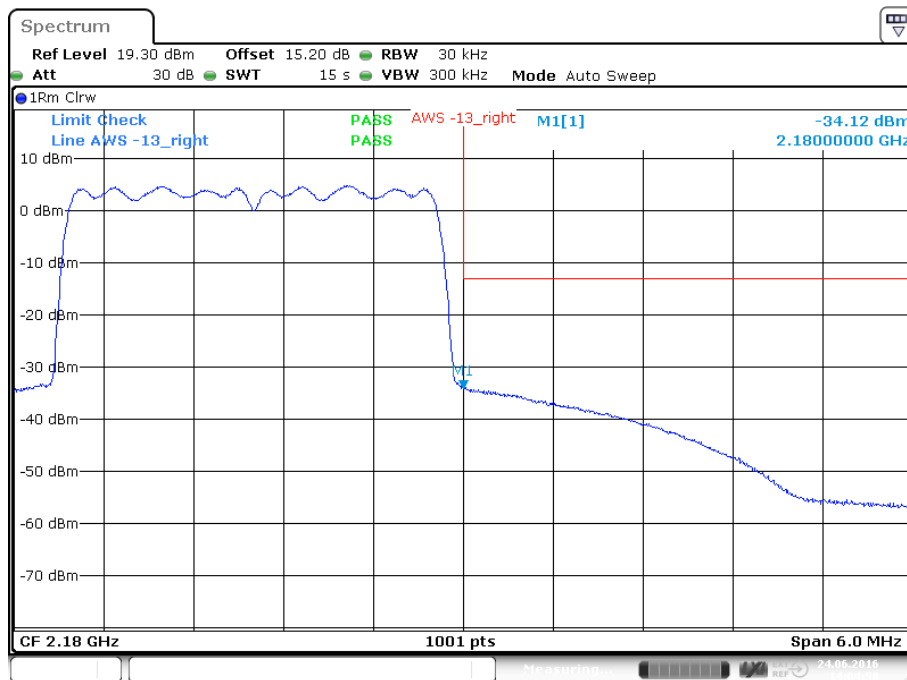

Date: 24 JUN 2016 14:04:58

plot 7.3.3.1-#2 Intermodulation: §27.53, §2.1051; Test results; Downlink; CDMA Upper Band Edge



7.3.3.2 WCDMA

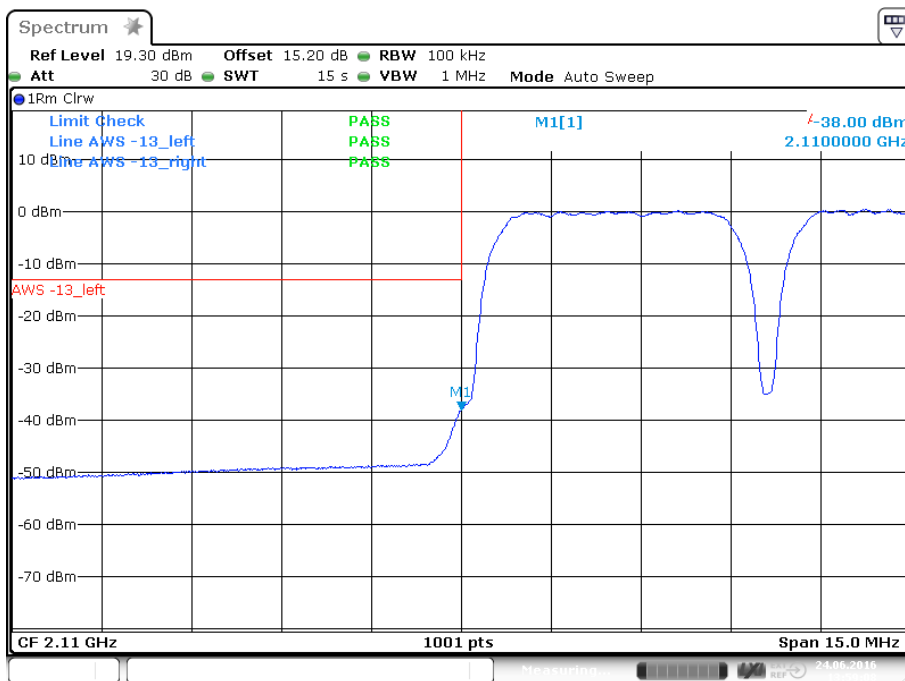

Date: 24 JUN 2016 13:59:08

plot 7.3.3.2-#1 Intermodulation: §27.53, §2.1051; Test results; Downlink; WCDMA Lower Band Edge

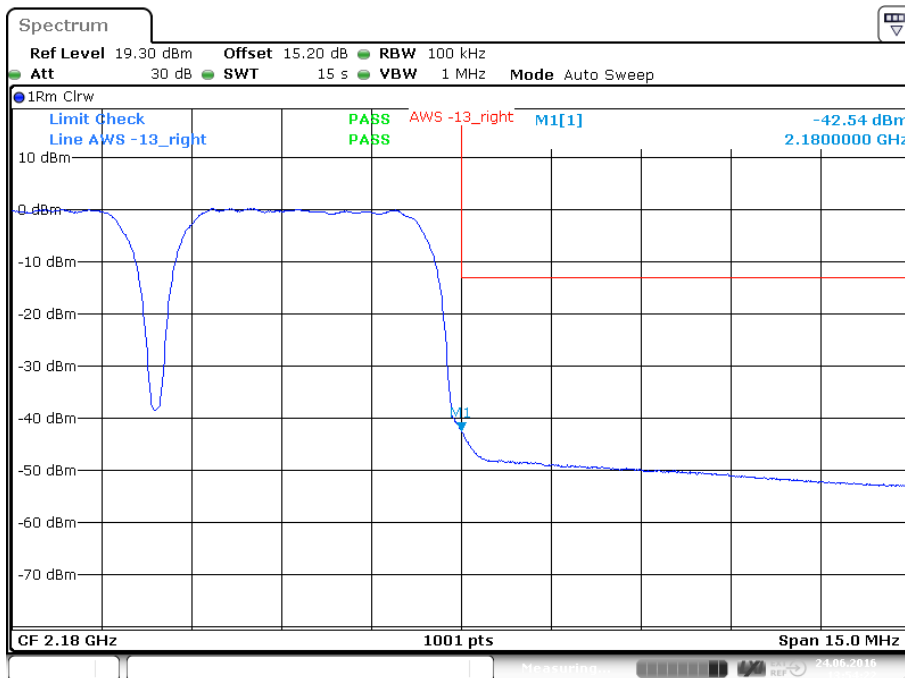

Date: 24 JUN 2016 13:54:22

plot 7.3.3.2-#2 Intermodulation: §27.53, §2.1051; Test results; Downlink; WCDMA Upper Band Edge



7.3.4 Uplink

7.3.4.1 CDMA

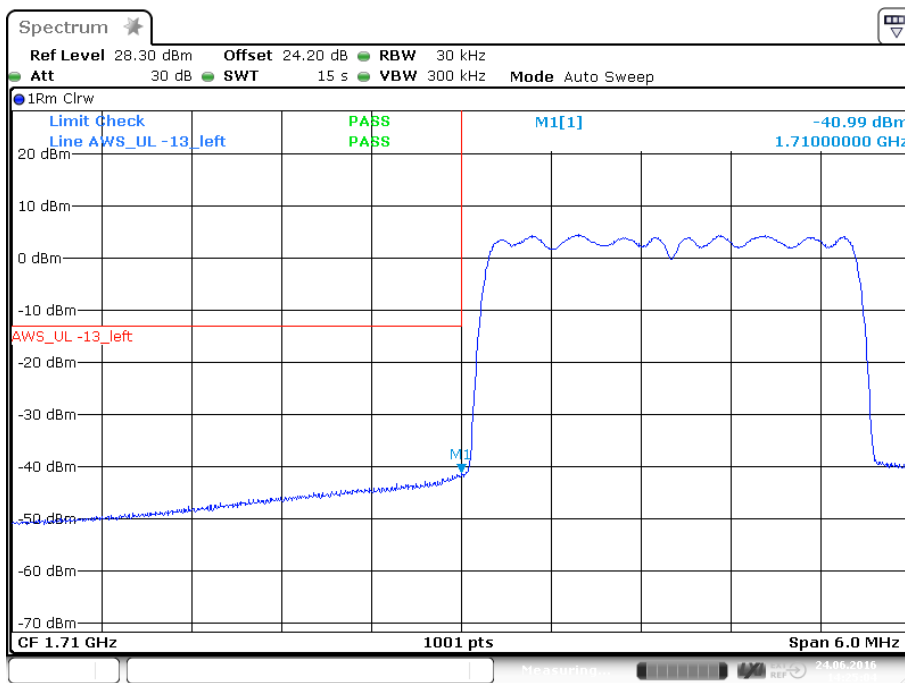

Date: 24 JUN 2016 14:25:04

plot 7.3.4.1-#1 Intermodulation: §27.53, §2.1051; Test results; Uplink; CDMA Lower Band Edge

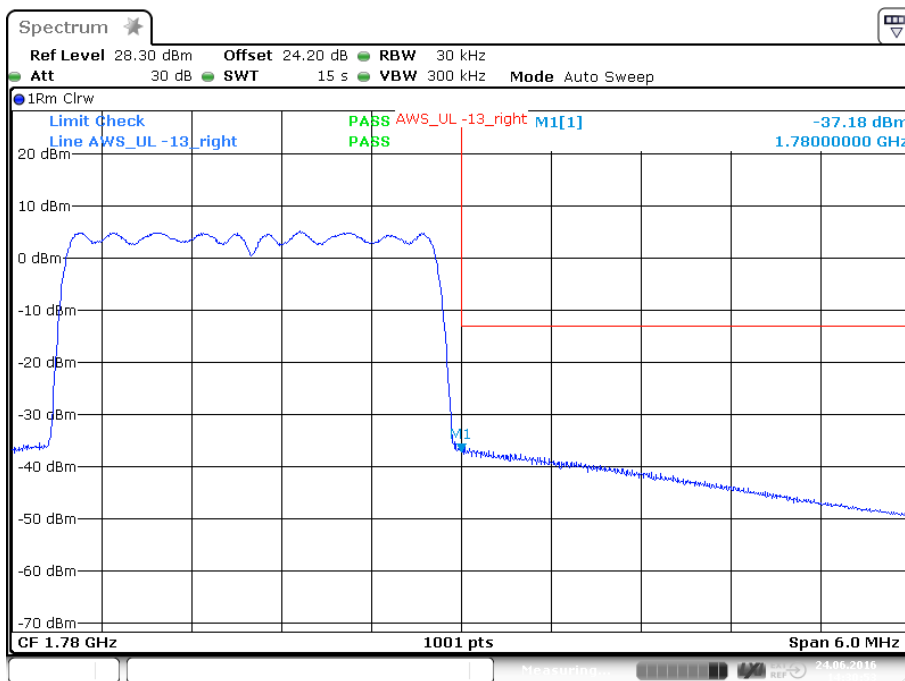

Date: 24 JUN 2016 14:30:53

plot 7.3.4.1-#2 Intermodulation: §27.53, §2.1051; Test results; Uplink; CDMA Upper Band Edge



7.3.4.2 WCDMA

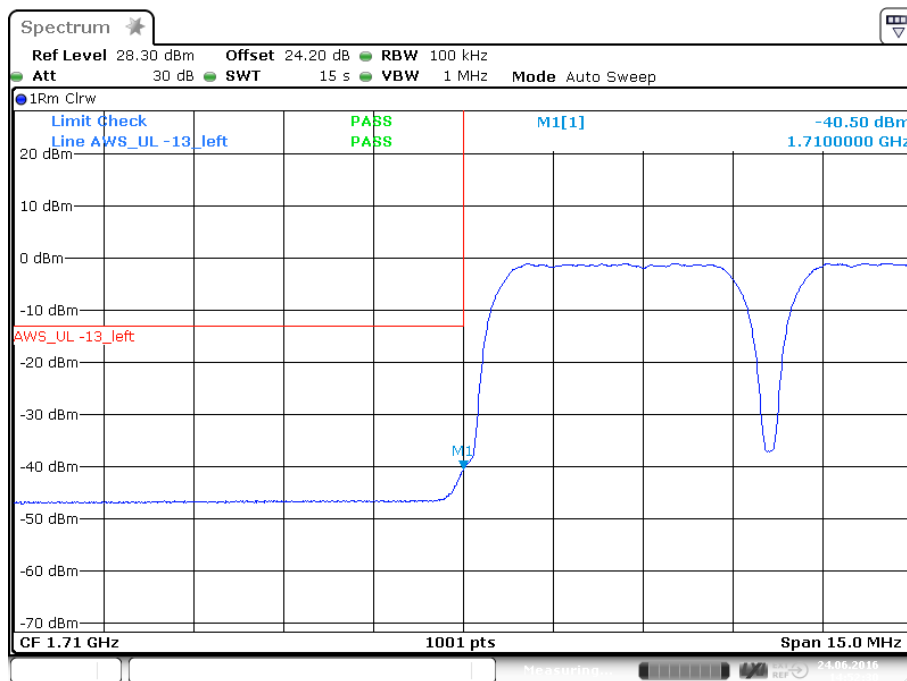

Date: 24 JUN 2016 14:52:30

plot 7.3.4.2-#1 Intermodulation: §27.53, §2.1051; Test results; Uplink; WCDMA Lower Band Edge

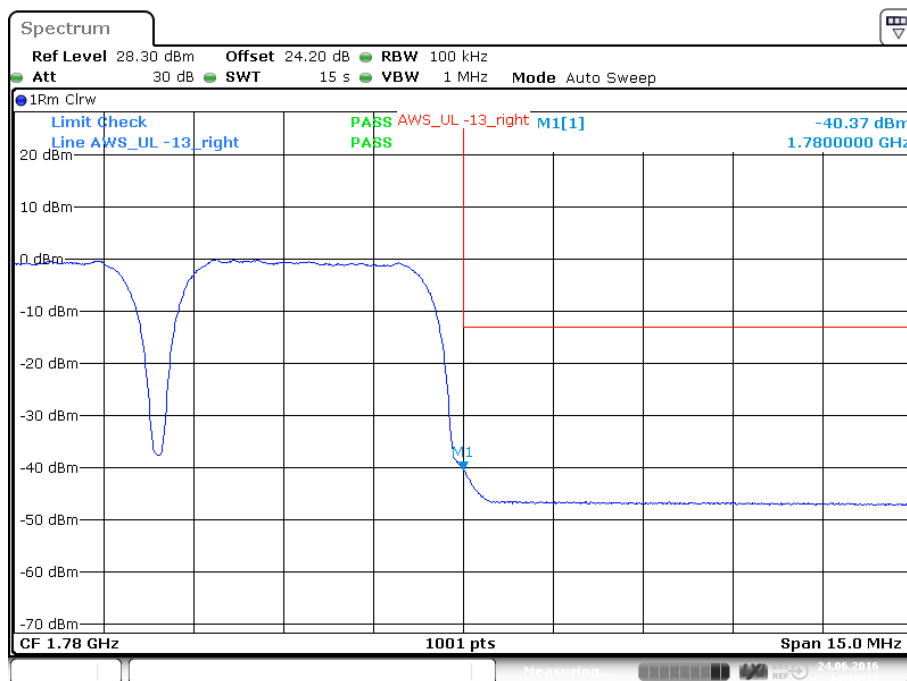

Date: 24 JUN 2016 14:39:31

plot 7.3.4.2-#2 Intermodulation: §27.53, §2.1051; Test results; Uplink; WCDMA Upper Band Edge

Test Report No.: 16-171

FCC ID: XS5-MR17E



BUREAU
VERITAS

7.4 Summary test result

| | |
|-------------|-------------------------------------|
| Test result | complies, according the plots above |
| Tested by: | W. Meir |
| Date: | 24.06.2016 |



8 Out of Band Rejection

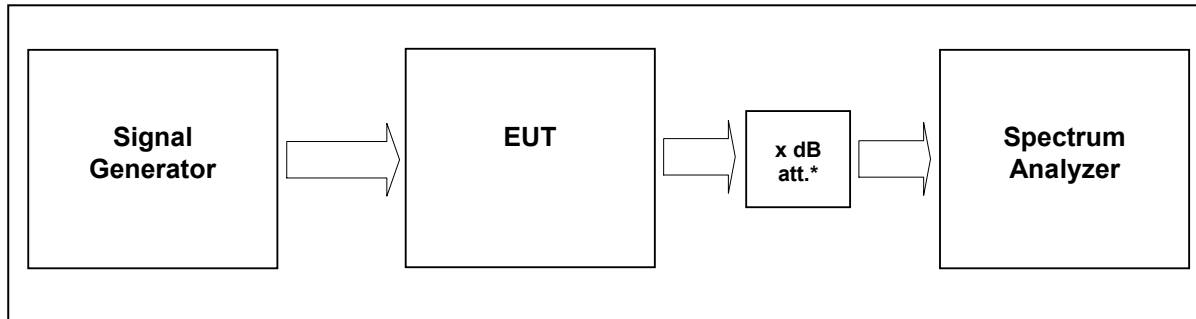

External Attenuator DL x dB = 20 dB
figure 8-#1 Test setup: Out of Band Rejection

| | |
|-------------------------|--|
| Measurement uncertainty | ± 0,38 dB |
| Test equipment used | 9236, 9123, 9300, 8990, 8668, 8667, 7406 |

8.1 Limit

KDB 935210 D02 v03r02

Test for rejection of out of band signals. Filter frequency response plots are acceptable.

8.2 Test method

935210 D03 v04

7.1 Authorized frequency band verification test

8.3 Test results

Detector Peak max hold



8.3.1 Downlink

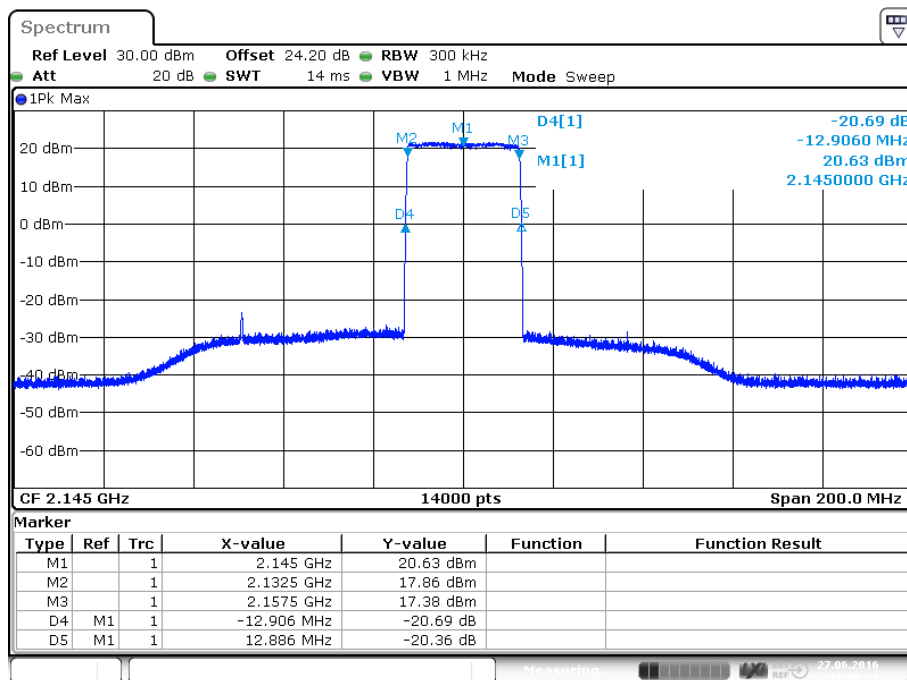

Date: 27 JUN 2016 11:57:22

plot 8.3.1-#1 Out of Band Rejection; Test results; Downlink;

8.3.2 Uplink

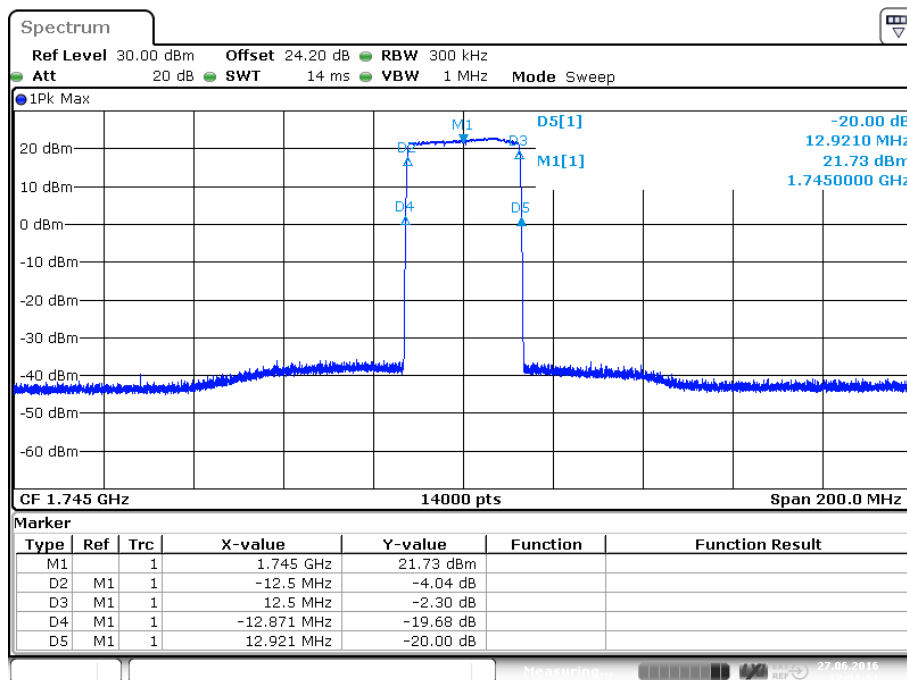

Date: 27 JUN 2016 12:01:51

plot 8.3.2-#1 Out of Band Rejection; Test results; Uplink;

Test Report No.: 16-171

FCC ID: XS5-MR17E



BUREAU
VERITAS

Summary test result

| | |
|-------------|-------------------------------------|
| Test result | complies, according the plots above |
| Tested by: | W. Meir |
| Date: | 27.06.2016 |

9 Field Strength of Spurious Emissions: §27.53, §2.1053



picture 8.1: label (EUT)

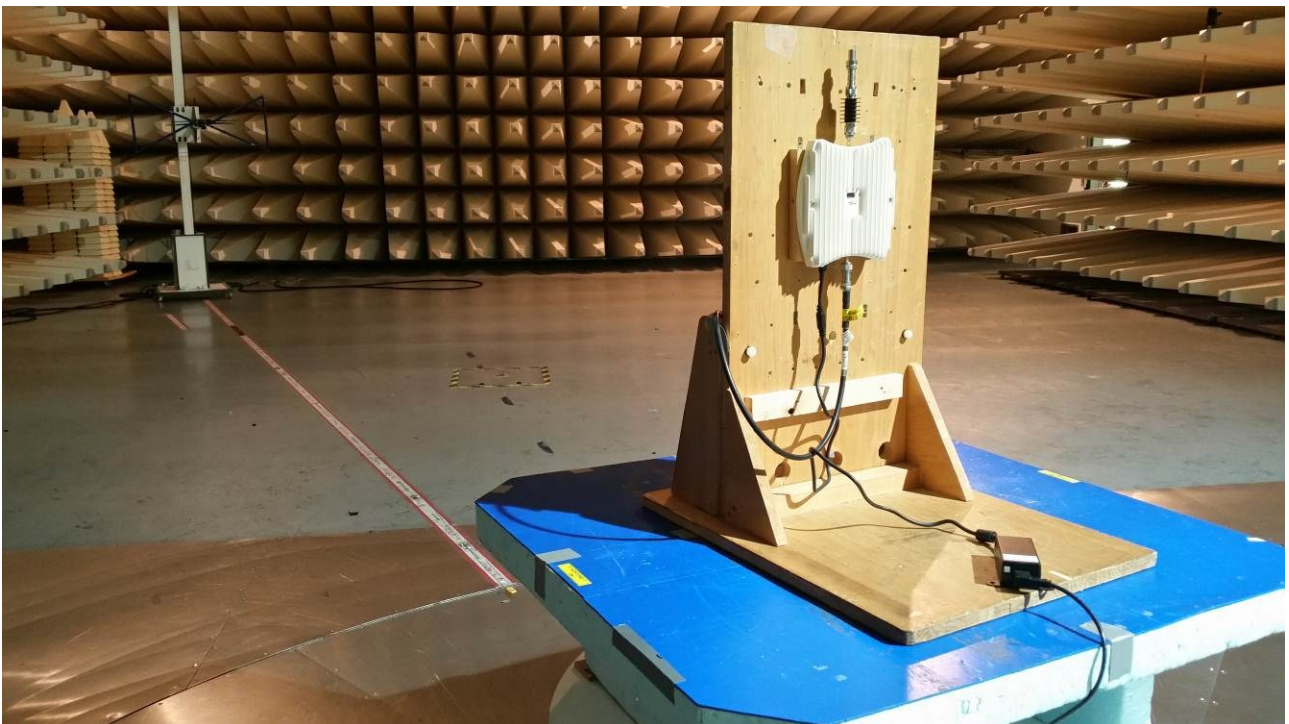
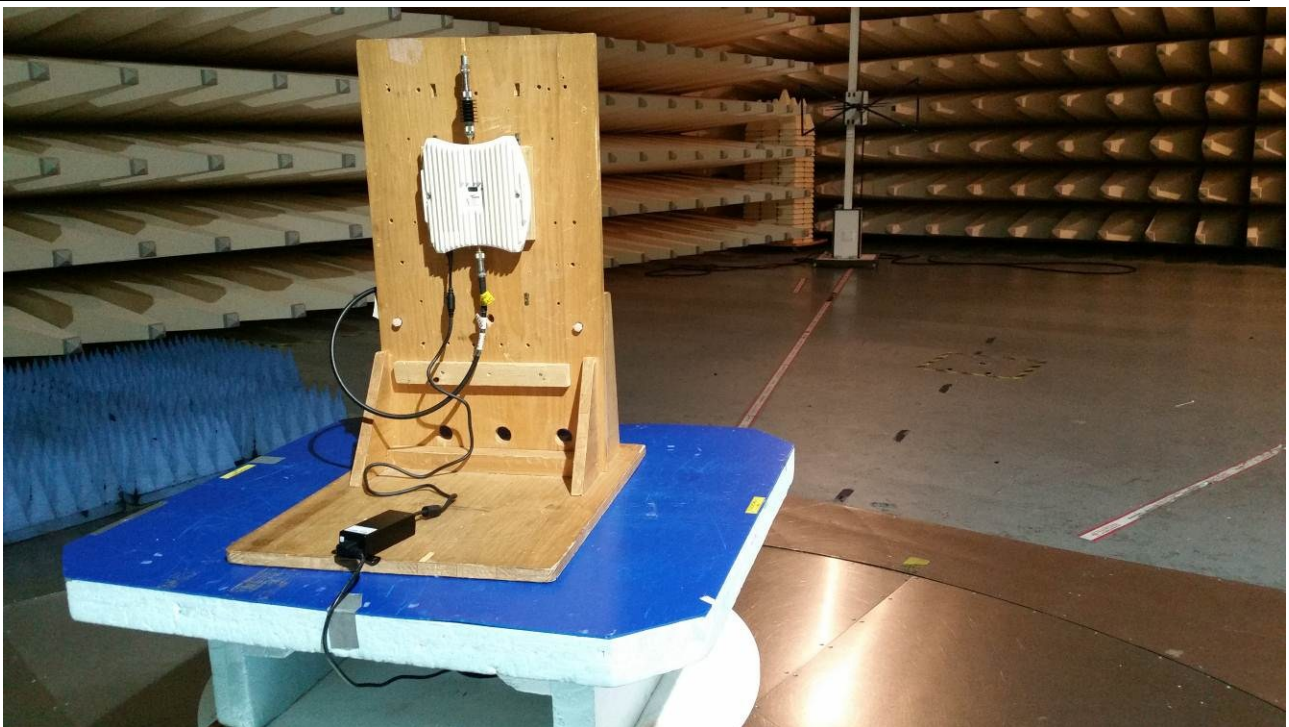

picture 8.2: Test setup: Field Strength Emission 30 M – 1 GHz @10m in the SAC

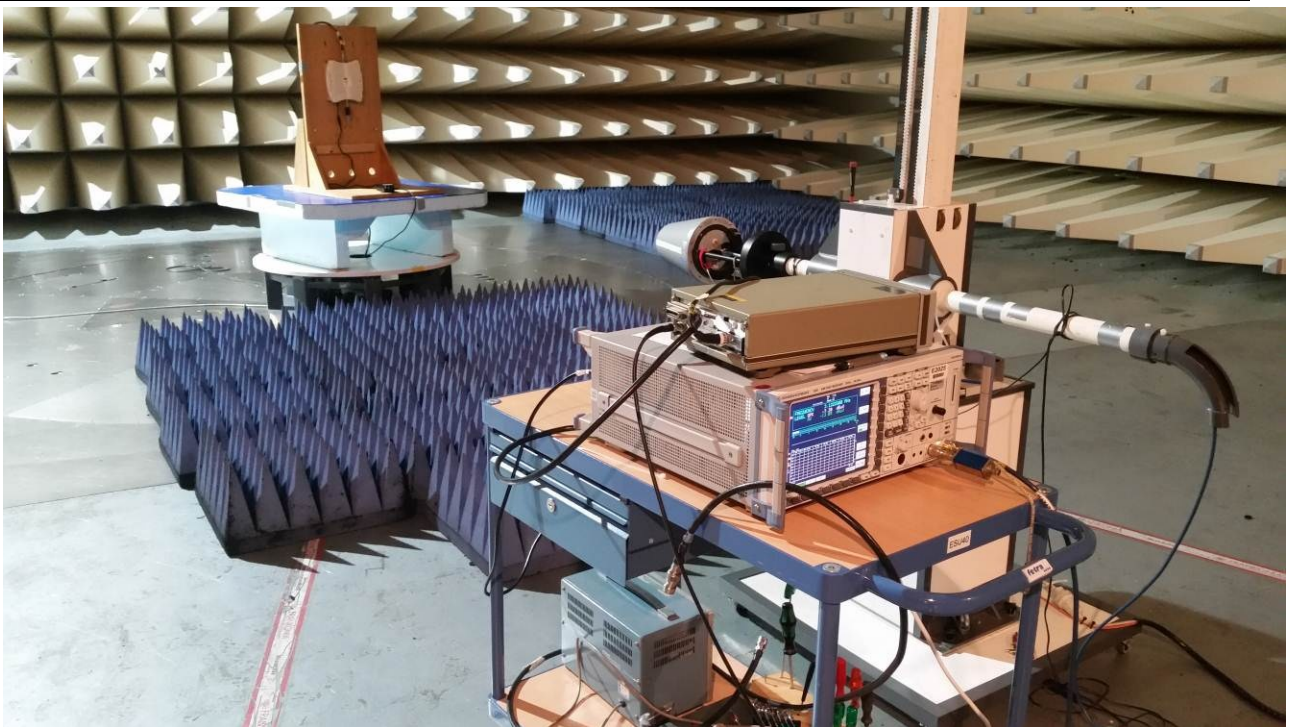

picture 8.4: Test setup: Field Strength Emission 1 – 18 GHz @3m in the SAC

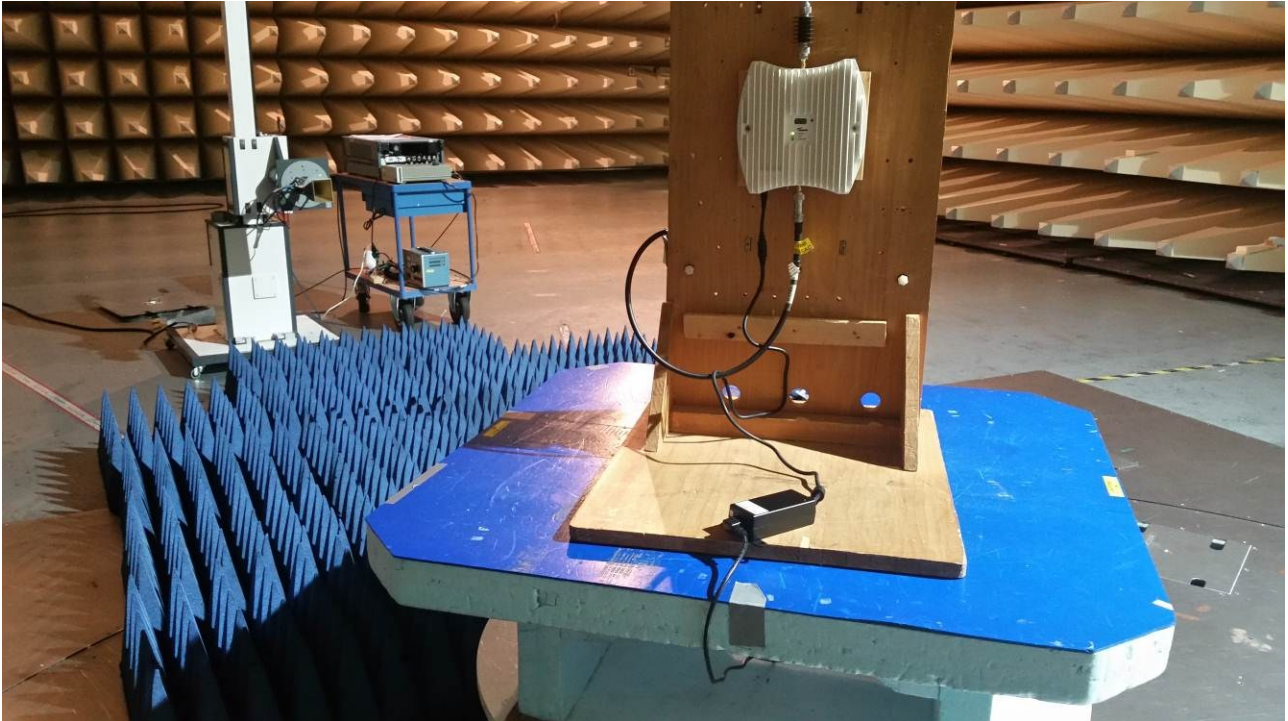

picture 8.4: Test setup: Field Strength Emission 18 – 26.5 GHz @3m in the SAC



This clause specifies requirements for the measurement of radiated emission.

| Frequency range | Distance: EUT <-> antenna / location | Limit | Test method |
|-------------------|--|-----------------------|--------------------|
| 30 MHz – 1 GHz | 10 metres / SAC | FCC 47 CFR Part 27.53 | TIA/EIA-603-C:2004 |
| 1 GHz – 18 GHz | 3 metres / SAC | | |
| 18 GHz – 26.5 GHz | 3 metres / SAC | | |

Test equipment used:

| Designation | Type | Manufacturer | Invent.-no. | Cal.-date | due Cal.- date | used |
|-------------------|-----------------------|-----------------|-------------|------------|-------------------|------|
| EMI test receiver | ESU40 | Rohde & Schwarz | E2025 | 25.02.2016 | 25.02.2017 | X |
| Antenna | CBL 6111 | Chase | K1026 | 12.02.2016 | 12.02.2017 | X |
| RF Cable | RG214 | Frankonia | K1121 | 16.04.2015 | 16.04.2017 | X |
| Antenna | HL 025 | R&S | K1114 | 09.02.2016 | 09.02.2017 | X |
| Preamplifier | AFS4-00102000 | Miteq | K817 | 03.05.2016 | 03.05.2017 | X |
| RF Cable | Sucoflex 100 | Suhner | K1760 | 04.08.2015 | 04.08.2016 | X |
| Antenna | JXTXLB-42-25- C-KF | A-Info | K1175 | 09.03.2015 | 09.03.2017 | X |

The REMI version 2.135 has been used to maximize radiated emission from the EUT with regards to ANSI C63.4:2009.

Test set-up:

Test location: SAC
Both, the Fully Anechoic Chamber (FAC) and the Semi Anechoic Chamber (SAC) fulfil the requirements of ANSI C63.4 and CISPR 16-1-4 with regards to NSA and SVSWR.

Test Voltage: 110V / 60 Hz
Type of EUT: Wall mounted

Measurement uncertainty:

| | |
|--|---|
| Measurement uncertainty expanded (95% or K=2) | ± 4,7 dB for ANSI C63.4 measurement ± 0,5 dB for TIA-603 measurement |
|--|---|

9.1 Method of Measurement

Measurement procedure. TIA-603-C

The antenna substitution method is used to determine the equivalent radiated power at spurious frequencies. The spurious emissions are measured at a distance of 3 meters. The EUT is then replaced with a reference substitution antenna with a known gain referenced to a dipole. This antenna is fed with a signal at the spurious frequency. The level of the signal is adjusted to repeat the previously measured level. The resulting eirp is the signal level fed to the reference antenna corrected for gain referenced to an isotropic dipole (see Figure 7.2).

From KDB (AMPLIFIER, BOOSTER, AND REPEATER REMINDER SHEET):

Radiated spurs (enclosure) – Use of CW signal (low, mid. and high freq.) is acceptable rather than all modulations.

The maximum RFI field strength was determined during the measurement by rotating the turntable (± 180 degrees) and varying the height of the receive antenna ($h = 1 \dots 4$ m) as like defined in ANSI C63.4. A measurement receiver has been used with a RBW 120 kHz up to 1 GHz and 1 MHz above 1 GHz. Steps with during pre measurement was half the RBW.

Both, the Fully Anechoic Chamber (FAC) and the Semi Anechoic Chamber (SAC) fulfil the requirements of ANSI C63.4 and CISPR 16-1-4 with regards to NSA and SVSWR.

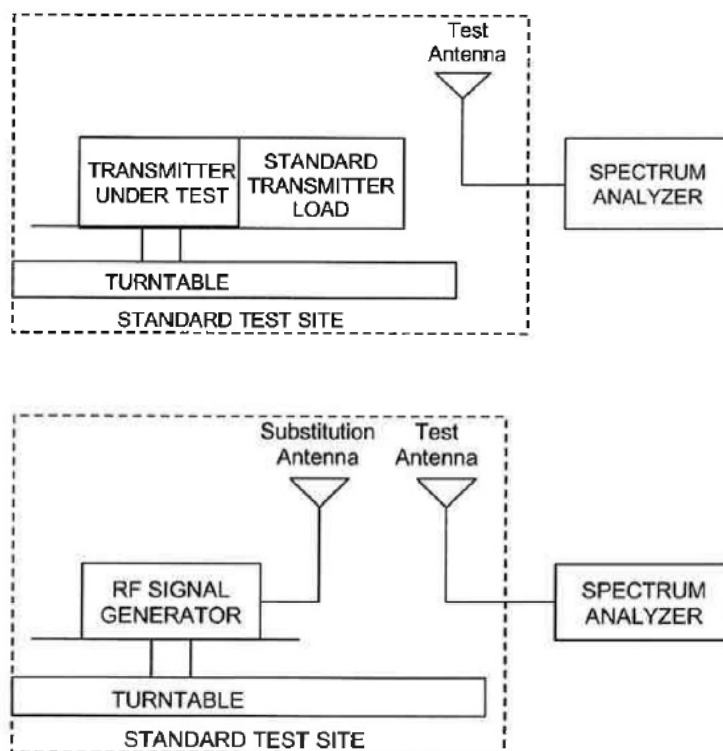

Figure #7.2 Substitution methods TIA/EIA-603-C

9.2 Limit §27.53 (h)

Minimum standard:

Para. No.27.53(h)

(h) *AWS emission limits*

(1) *General protection levels.* Except as otherwise specified below, for operations in the 1695-1710 MHz, 1710-1755 MHz, 1755-1780 MHz, 1915-1920 MHz, 1995-2000 MHz, 2000-2020 MHz, 2110-2155 MHz, 2155-2180 MHz, and 2180-2200 bands, the power of any emission outside a licensee's frequency block shall be attenuated below the transmitter power (P) in watts by at least $43 + 10 \log_{10}(P)$ dB.

(3) *Measurement procedure.* (i) Compliance with this provision is based on the use of measurement instrumentation employing a resolution bandwidth of 1 megahertz or greater. However, in the 1 megahertz bands immediately outside and adjacent to the licensee's frequency block, a resolution bandwidth of at least one percent of the emission bandwidth of the fundamental emission of the transmitter may be employed. The emission bandwidth is defined as the width of the signal between two points, one below the carrier center frequency and one above the carrier center frequency, outside of which all emissions are attenuated at least 26 dB below the transmitter power.

(ii) When measuring the emission limits, the nominal carrier frequency shall be adjusted as close to the licensee's frequency block edges, both upper and lower, as the design permits.

(iii) The measurements of emission power can be expressed in peak or average values, provided they are expressed in the same parameters as the transmitter power.

The Emission limit is -13dBm.

9.3 Climatic values in the lab

Temperature: 21°
Relative Humidity: 45%
Air-pressure: 1004 hPa



9.4 Test results

9.4.1 30 MHz to 1 GHz Uplink

B/M/T: 1732.5 MHz / 1745 MHz / 1757.5 MHz (Operation with maximum composite power)

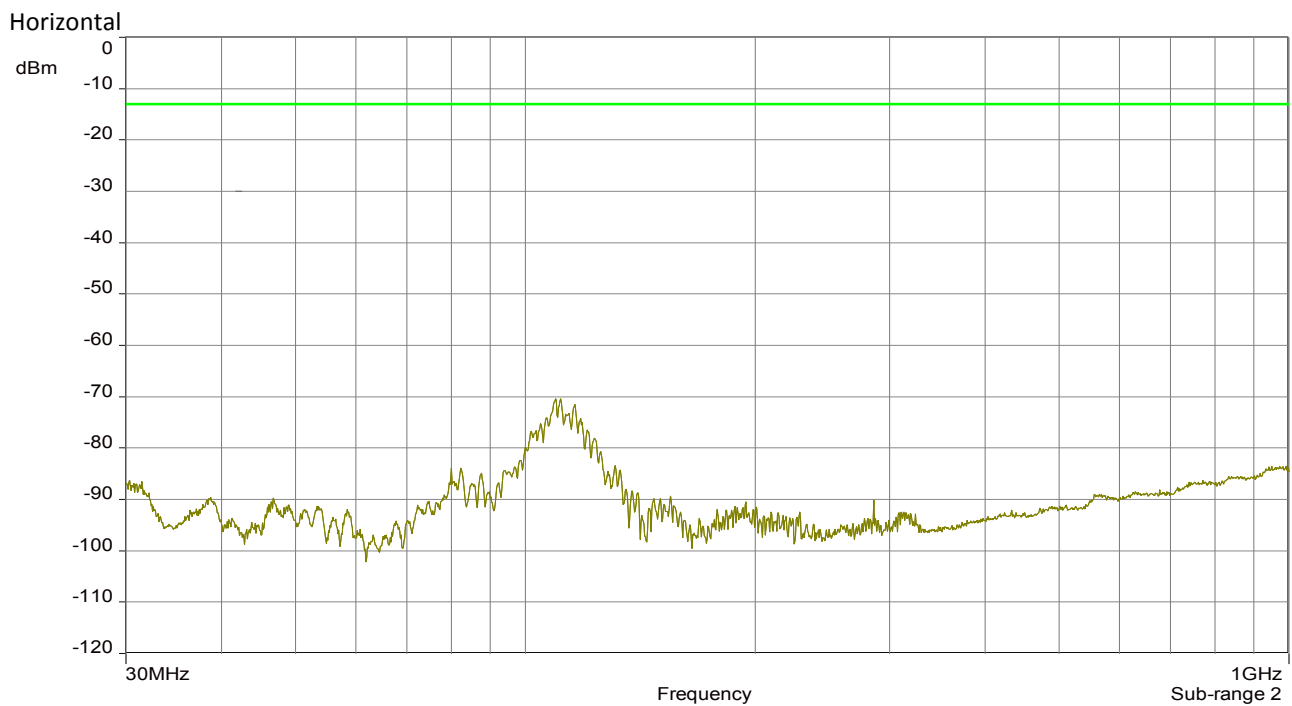
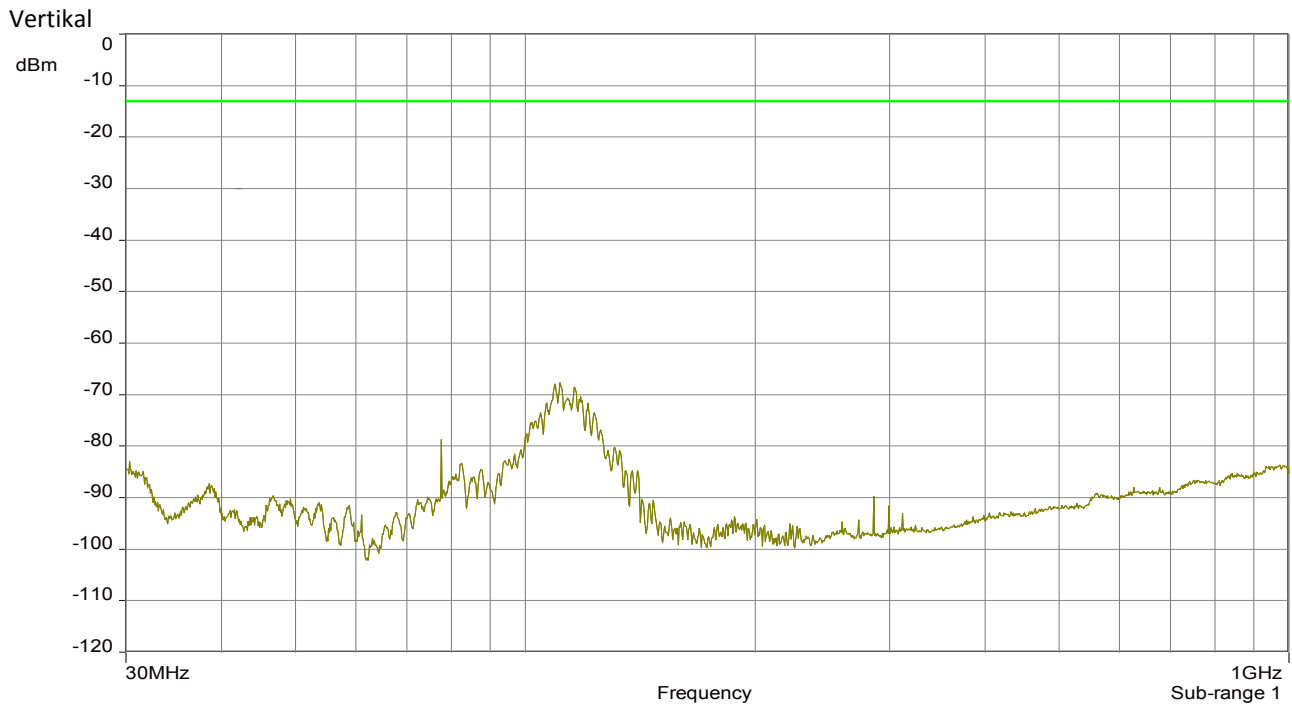

The RF output power is terminated.



9.4.2 30 MHz to 1 GHz Downlink

F1: 2132.5 MHz; F2: 2145 MHz; F3: 2157.5 MHz (Operation with maximum composite power)

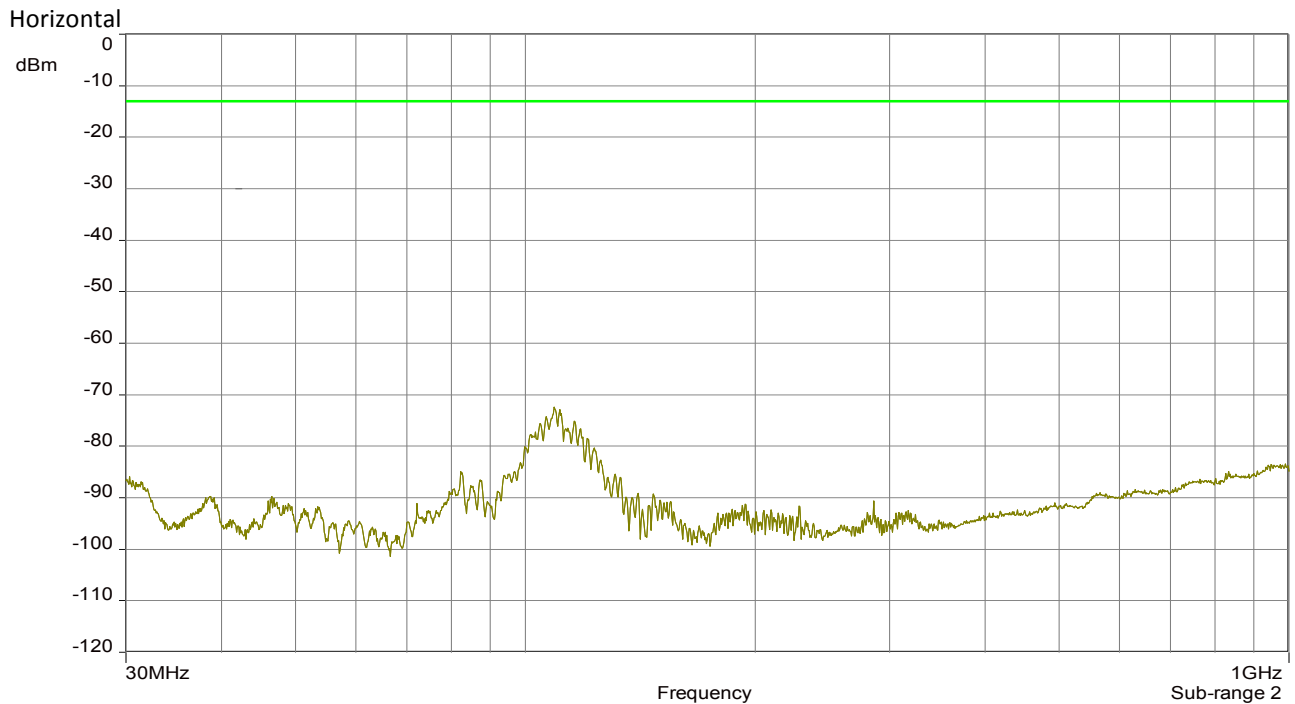
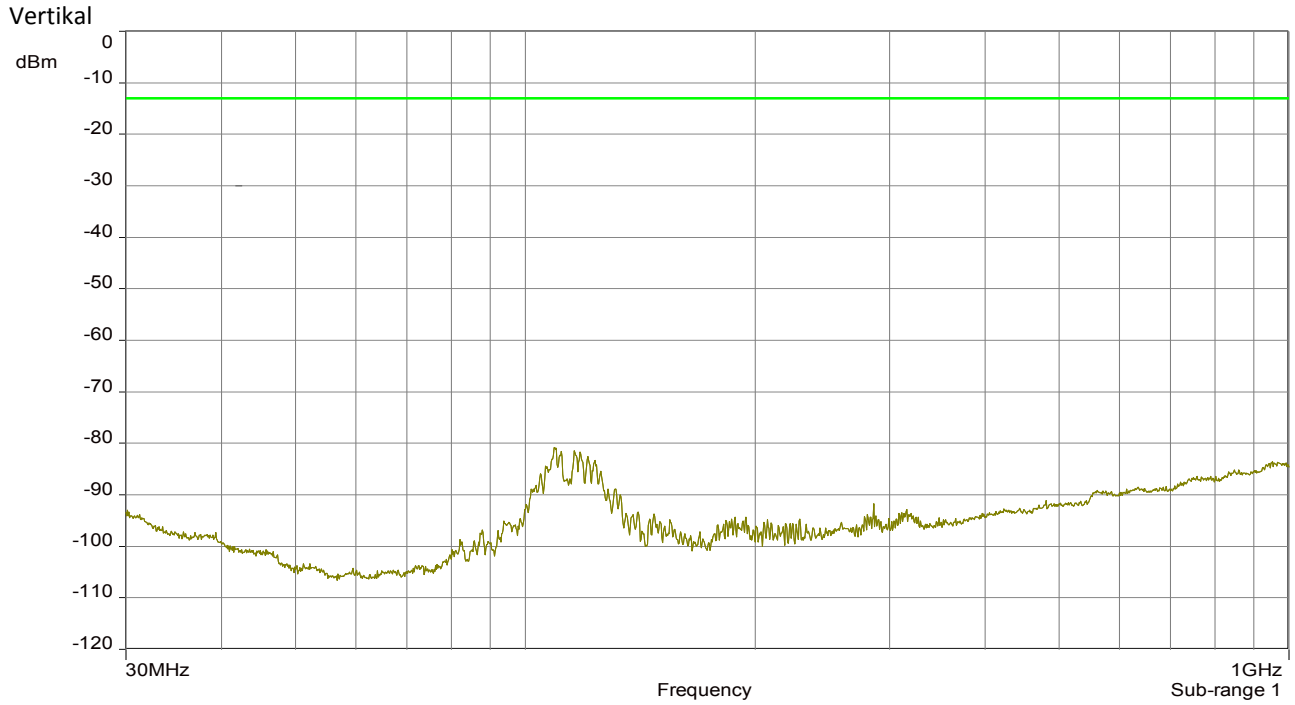

The RF output power is terminated.



9.4.3 1 GHz – 18 GHz Uplink

B/M/T: 1732.5 MHz / 1745 MHz / 1757.5 MHz (Operation with maximum composite power)

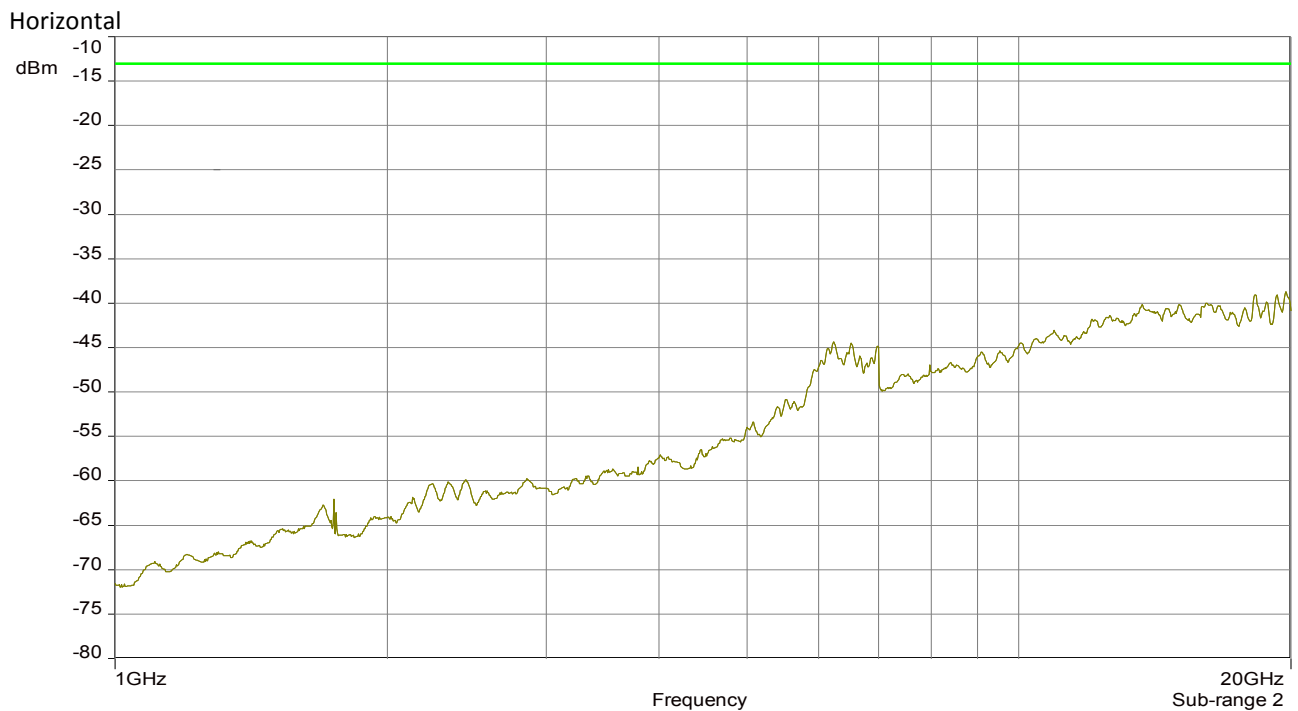
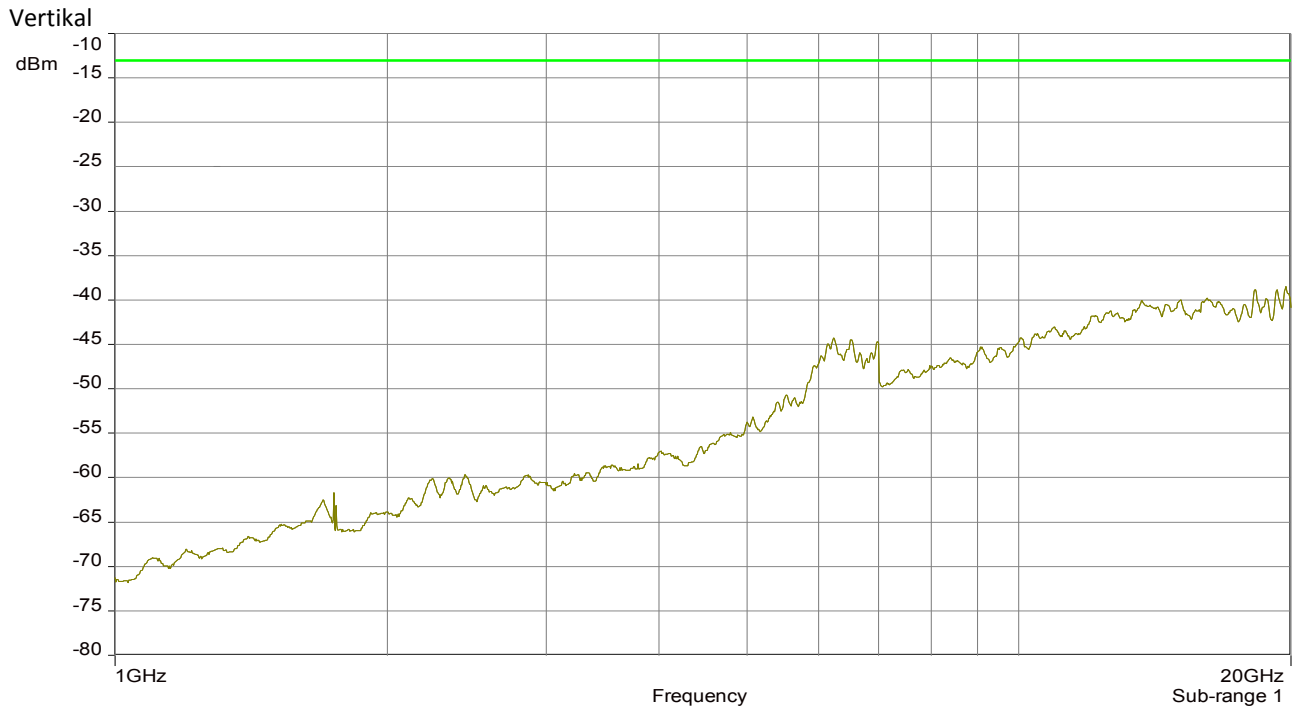

The RF output power is terminated.



9.4.4 1 GHz – 18 GHz Downlink

F1: 2132.5 MHz; F2: 2145 MHz; F3: 2157.5 MHz (Operation with maximum composite power)

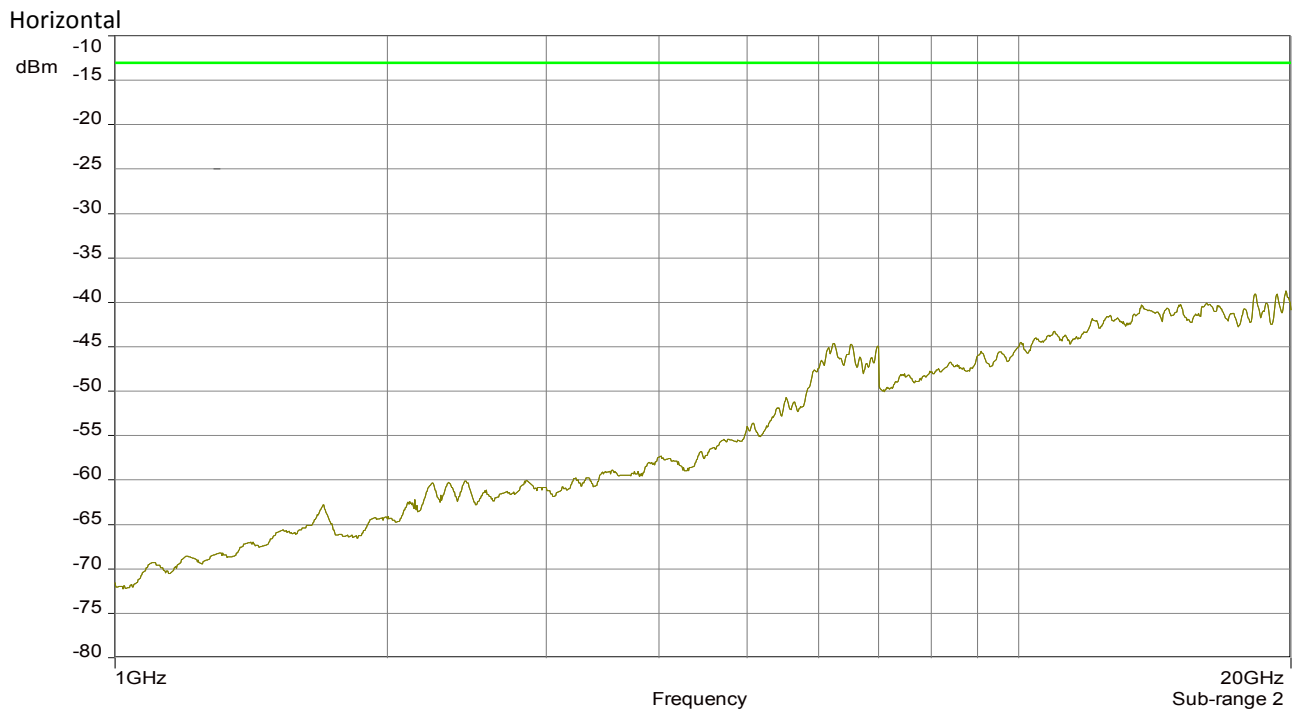
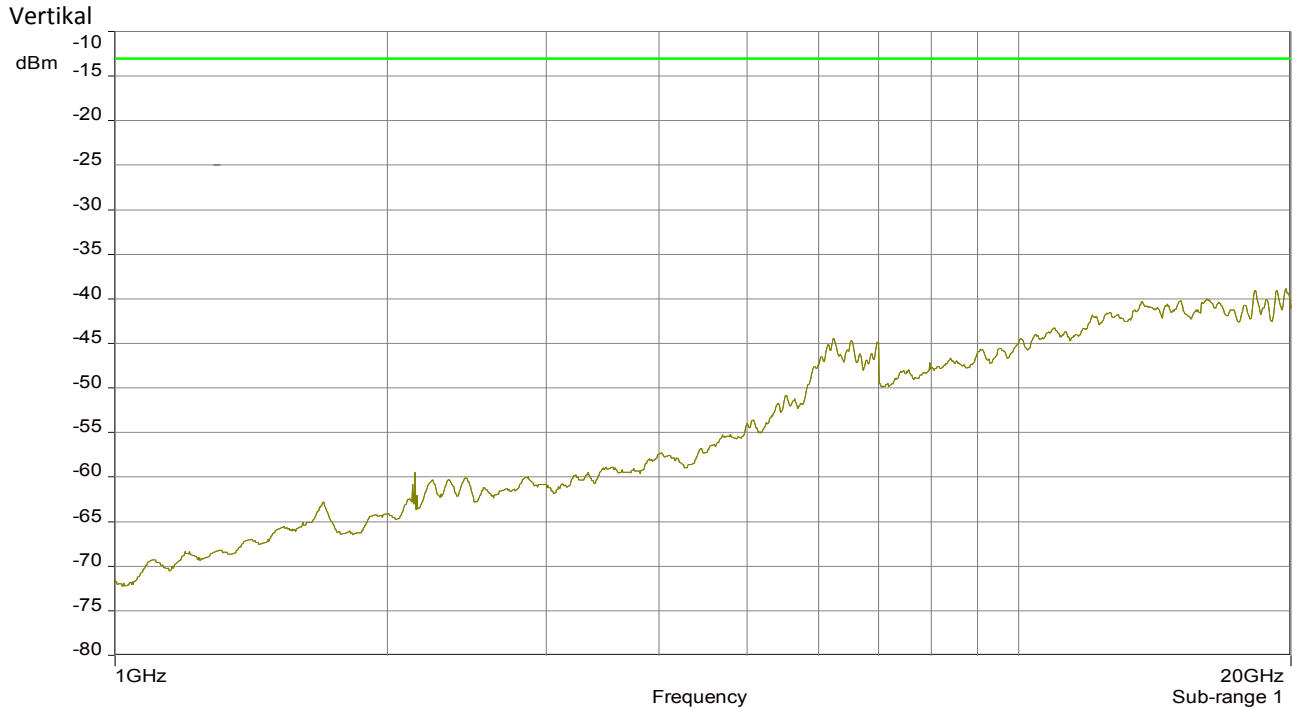

The RF output power is terminated.



9.4.5 18 GHz – 26.5 GHz Uplink

B/M/T: 1732.5 MHz / 1745 MHz / 1757.5 MHz (Operation with maximum composite power)

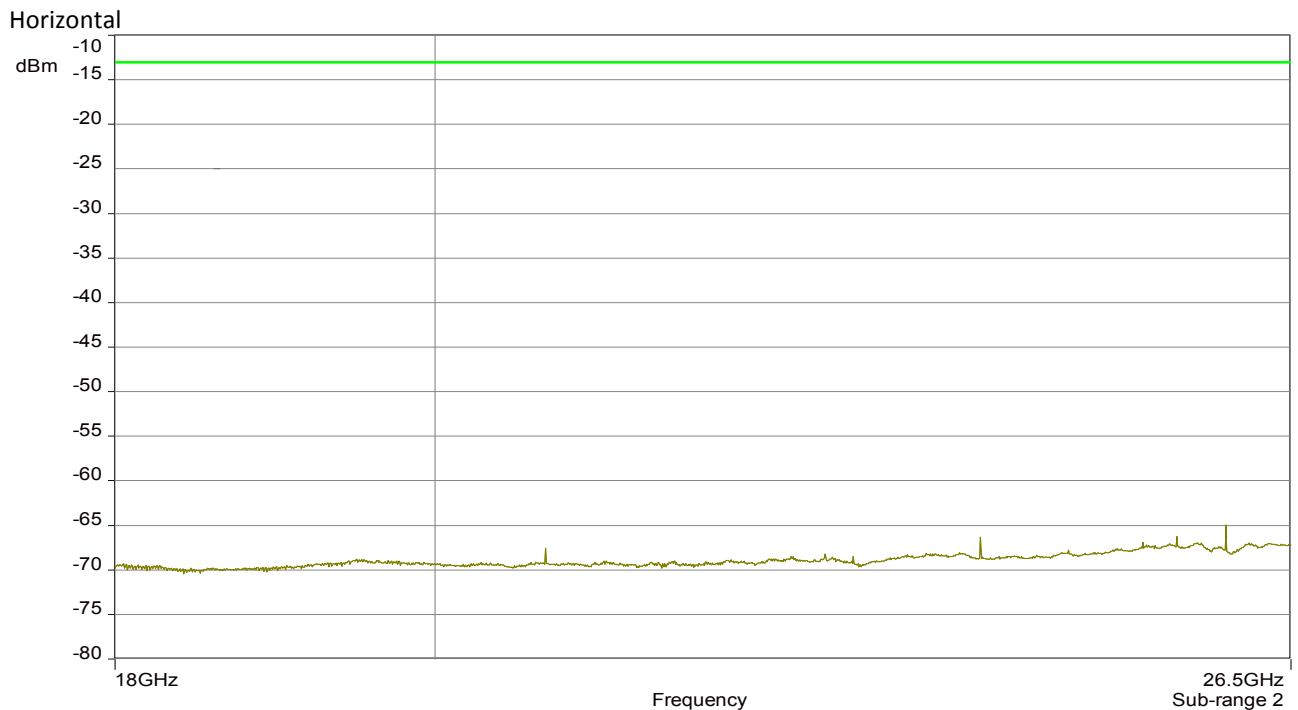
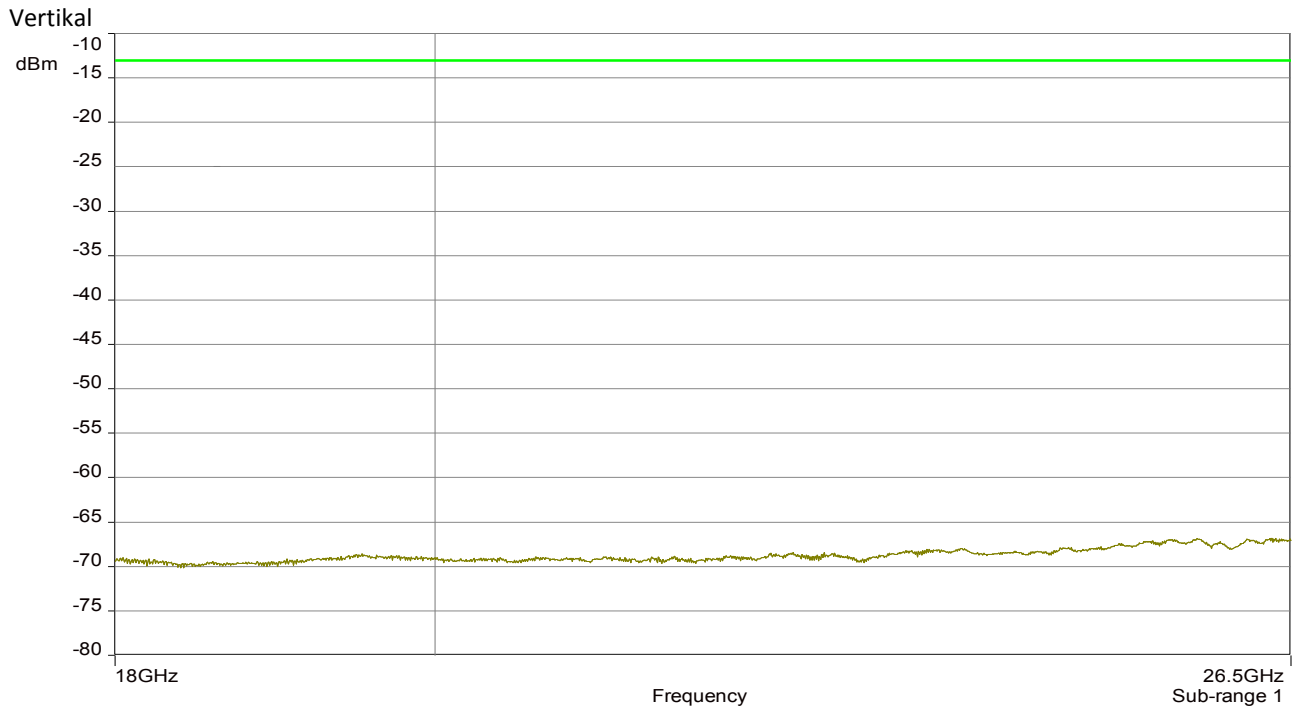

The RF output power is terminated.



9.4.6 18 GHz – 26.5 GHz Downlink

F1: 2132.5 MHz; F2: 2145 MHz; F3: 2157.5 MHz (Operation with maximum composite power)

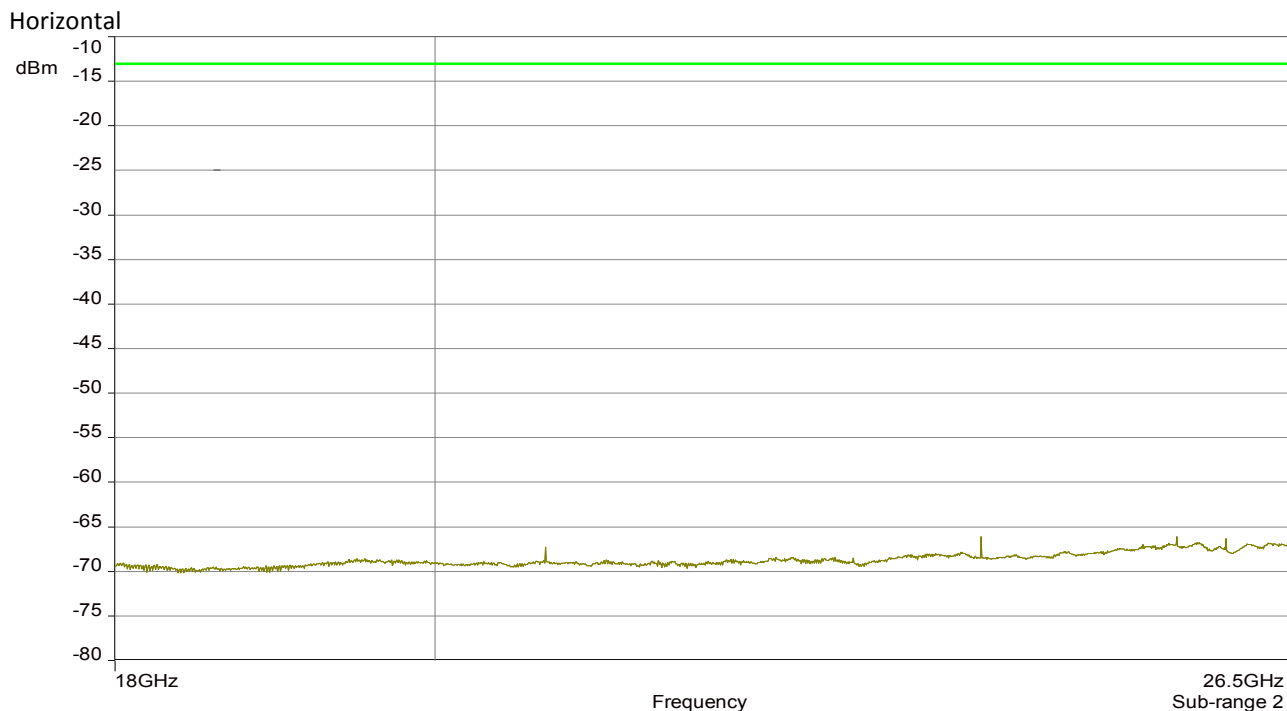
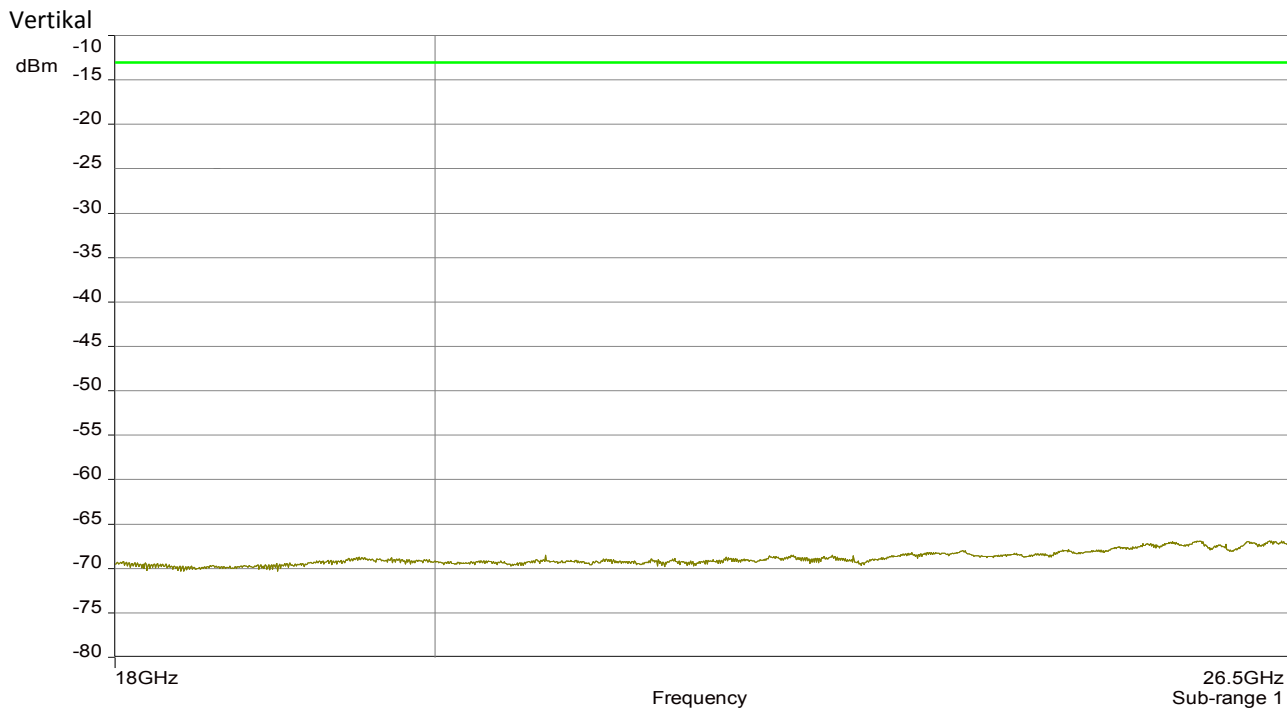

The RF output power is terminated.

Za / 06.07.2016

The radiated spurious emission measurements have been passed!

Test Report No.: 16-171

FCC ID: XS5-MR17E



BUREAU
VERITAS

10 History

| Revision | Modification | Date | Name |
|----------|---------------------|------------|--------------|
| 01.00 | Initial Test report | 20.07.2016 | Tom Zahlmann |

******* End of test report *******