

Test Site:
FCC Test Site No.:
IC OATS No.:

96997
IC3475A-1



ECL-EMC Test Report No.: 11-106

Equipment under test: ION-M7P/85P/19P 1900MHz Path
FCC ID: XS5-ML78519P
IC ID: 2237E-ML78519P
Type of test: **FCC 47 CFR Part 24 Subpart E: 2011**
Miscellaneous Wireless Communication Services
RSS-Gen:2007, RSS-131:2005
Zone Enhancers for the Land Mobile Service

Measurement Procedures: 47 CFR Parts 2: 2011(*Frequency Allocations and Radio Treaty Matters; General Rules and Regulations*),
24 (Broadband PCS),
ANSI/TIA-603-C (2004), *Land Mobile FM or PM Communications Equipment Measurement and Performance Standards*
IC-GEN General Requirements and Information for the Certification of Radiocommunication Equipment

Test result: **Passed**

Date of issue:	26.04.11			Signature:
Issue-No.:	01	Author:	T. Zahlmann Test engineer	
Date of delivery:		Checked:	M. Lehmann Head of the ECL	
Test dates:	01.04. – 05.04.09			
Pages:	43			

Test Report No.: 11-106

FCC ID: XS5-ML78519P

IC ID: 2237E-ML78519P



Manufacturer: ANDREW Wireless Systems GmbH
Industriering 10

D-86675 Buchdorf

Tel.: +49 (0)9099 69 0

Fax: +49 (0)9099 69 140

Test Location: HERBERG Service Plus GmbH
European Compliance Laboratory (ECL)

Thurn-und Taxis-Straße 18

D-90411 Nürnberg

Tel.: +49 0911 59835 23

Fax: +49 0911 59835 90

General:

The purpose of this report is to show compliance to the FCC regulations for unlicensed devices operating under section 15.249 of the Code of Federal Regulations title 47.

This report informs about the results of the EMC tests, it only refers to the equipment under test. No part of this report may be reproduced in any form, without written permission.



Table of contents

1	TEST RESULTS SUMMARY	5
2	EQUIPMENT UNDER TEST (E.U.T.)	6
2.1	DESCRIPTION	6
2.1.1	DOWNLINK	6
2.1.2	UPLINK	6
2.1.3	DESCRIPTION OF EUT	6
2.1.4	BLOCK DIAGRAM OF MEASUREMENT REFERENCE POINTS	7
3	TEST SITE (ANDREW BUCHDORF)	8
3.1	TEST ENVIRONMENT	8
3.2	TEST EQUIPMENT	8
3.3	INPUT AND OUTPUT LOSSES	8
3.4	MEASUREMENT UNCERTAINTY	8
4	TEST SITE (TEMPTON SERVICE PLUS GMBH)	9
5	RF POWER OUT: §24.232, §2.1046; RSS-133, RSS-GEN	10
5.1	LIMIT	10
5.2	TEST METHOD	10
5.3	TEST RESULTS	11
5.3.1	DOWNLINK	12
5.3.1.1	GSM	13
5.3.1.2	GSM-EDGE	13
5.3.1.3	CDMA	14
5.3.1.4	W-CDMA	14
5.3.1.5	LTE	15
5.3.2	UPLINK	16
5.4	SUMMARY TEST RESULT	16
6	OCCUPIED BANDWIDTH: §2.1049; RSS-GEN	17
6.1	LIMIT	17
6.2	TEST METHOD	17
6.3	TEST RESULTS	18
6.3.1	DOWNLINK	18
6.3.1.1	CDMA	19
6.3.1.2	W-CDMA	20
6.3.1.3	GSM	21
6.3.1.4	GSM-EDGE	22
6.3.1.5	LTE	23
6.3.2	UPLINK	24
6.4	SUMMARY TEST RESULT	24
7	SPURIOUS EMISSIONS AT ANTENNA TERMINALS: §24.238, §2.1051; RSS-132, RSS-GEN	25
7.1	LIMIT	25
7.2	TEST METHOD	25
7.3	TEST RESULTS	26



7.3.1	DOWNLINK	26
7.3.1.1	CDMA < 1MHz to band edge.....	28
7.3.1.2	W-CDMA < 1MHz to band edge.....	29
7.3.1.3	GSM < 1MHz to band edge.....	30
7.3.1.4	GSM-EDGE < 1MHz to band edge.....	31
7.3.1.5	LTE < 1MHz to band edge.....	32
7.3.1.6	CDMA > 1MHz to band edge.....	33
7.3.1.7	W-CDMA > 1MHz to band edge.....	33
7.3.1.8	GSM > 1MHz to band edge.....	34
7.3.1.9	GSM-EDGE > 1MHz to band edge.....	34
7.3.1.10	LTE > 1MHz to band edge.....	35
7.3.2	UPLINK	35
7.4	SUMMARY TEST RESULT.....	35
8	RADIATED SPURIOUS EMISSIONS: §24.238, §2.1053, RSS-133	36
8.1	LIMIT §24.238.....	39
8.2	TEST METHOD ANSI/TIA/EA-603-C	39
8.3	CLIMATIC VALUES IN THE LAB.....	40
8.4	TEST RESULTS	41
8.4.1	30 MHz TO 1 GHz DOWNLINK (B <u>OTTOM</u> – M <u>IDDLE</u> – T <u>OP</u>)	41
8.4.2	20 GHz -22 GHz DOWNLINK (B <u>OTTOM</u> – M <u>IDDLE</u> – T <u>OP</u>).....	42
8.4.3	HISTORY	43



1 Test Results Summary

Name of Test	FCC Para. No.	FCC Method	FCC Spec.	Result
RF Power Output	24.232(a)	2.1046(a)	160 Watts	Complies
Occupied Bandwidth		2.1049(h)	Input/Output	Complies
Spurious Emissions at Antenna Terminals	24.238(a)	2.1051	-13dBm	Complies
Field Strength of Spurious Emissions	24.238(a)	2.1053	-13dBm E.I.R.P	Complies
Frequency Stability		2.1055(a)(d)	Must stay in band	NA

Name of Test	IC Para. No.	IC Method	Result
RF Power Output	RSS-133 6.4	RSS-GEN 4.8	Complies
Occupied Bandwidth		RSS-GEN 4.6.1	Complies
Spurious Emissions at Antenna Terminals	RSS-133 6.5	RSS-GEN 4.9	Complies
Field Strength of Spurious Emissions			Complies
Frequency Stability	RSS-133 6.3	RSS-GEN 4.7	NA

Frequency stability is not applicable because the device uses a common oscillator to up convert and down convert the RF signal. The EUT does not contain modulation circuitry, or frequency generation, therefore the test was not performed.



2 Equipment under test (E.U.T.)

2.1 Description

Kind of equipment	ION-M7P/85P/19P	
Andrew Ident. Number	Id.No. 7629728-0002	
Serial no.(SN)	11	
Revision	00	
Software version and ID	n. a.	
Type of modulation and Designator	GSM (GXW)	<input checked="" type="checkbox"/>
	GSM-EDGE (G7W)	<input checked="" type="checkbox"/>
	CDMA (F9W)	<input checked="" type="checkbox"/>
	W-CDMA (F9W)	<input checked="" type="checkbox"/>
	LTE (G7D)	<input checked="" type="checkbox"/>
Frequency Translation	F1-F1	<input checked="" type="checkbox"/>
	F1-F2	<input type="checkbox"/>
	N/A	<input type="checkbox"/>
Band Selection	Software	<input type="checkbox"/>
	Duplexer	<input checked="" type="checkbox"/>
	Fullband	<input type="checkbox"/>

2.1.1 Downlink

Pass band	1930 MHz – 1995 MHz
Max. composite output power based on one carrier (rated)	43,34 dBm -> 21,58 W
Gain max.	10 dB @ Pout BTS of 33 dBm

2.1.2 Uplink

Pass band	1850 MHz – 1915 MHz
Gain max.	n.a.

Note: The EUT does not transmit over the air in the uplink direction.

2.1.3 Description of EUT

ION-M7P/85P/19P is a multi-band, multi-operator remote unit configuration used in conjunction with a master unit in the ION optical distribution system.

This system transports up to four frequency bands simultaneously (700 MHz, 850 MHz, 1900 MHz), providing a cost-effective solution for distributing capacity from one or more base stations.

The ION- M7P/85P/19P Repeater consists of one 700 MHz path, one 850 MHz path and one 1900 MHz, with the intended use of simultaneous transmission. This Test Report describes only the approval of the 1900 MHz path

2.1.4 Block diagram of measurement reference points

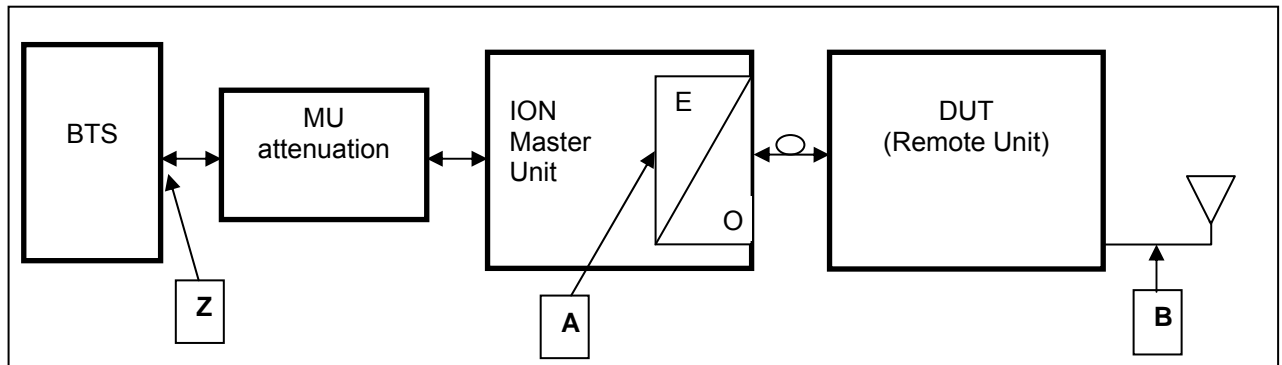

figure 2.1.4-#1 Block diagram of measurement reference points

Remote Unit is the DUT
O/E Optitcal/Electrical converter
SRMU SubRack Master Unit

Reference point A, SRMU UL output, DL input
Reference point B, Remote Unit DL output, UL input
Reference point Z, BTS DL output, BTS UL input

Since a signal generator does not supply a good output signal with +33 or +43dBm, for the downlink measurement the MU Attenuation is not used.
That means for downlink measurements the signal generator is connected to measurement point A at the master optical / electrical converter and the analyzer to the measurement point B at the RU.



3 Test site (Andrew Buchdorf)

3.1 Test environment

All tests were performed under the following environmental conditions:

Condition	Minimum value	Maximum value
Barometric pressure	86 kPa	106 kPa
Temperature	15°C	30°C
Relative Humidity	20 %	75 %
Power supply range	±5% of rated voltages	

3.2 Test equipment

ANDREW Inv. No.	Test equipment	Type	Manufacturer	Serial No.	Calibration
8372	Network Analyzer	8753D	HP	3410A08675	02/11
8961	Spectrum Analyzer	FSP-13	R&S	100147/013	10/11
8798	Spectrum Analyzer	FSQ-26	R&S	100340	03/2012
8849	Signal Generator	SMU200A	R&S	101732	04/11
8856	Signal Generator	SMIQ 03B	R&S	100435	12/11
7192	Power Attenuator	769-30	Narda	07448	CIU
7338	Power Attenuator	769-10	Narda	05773	CIU
7191	Power Attenuator	765-20	Narda	0012	CIU
7119	Divider	2way	Mikom	3512	CIU
7287	RF-Cable	2,0m; N-N	Huber & Suhner	28441/4PEA	CIU
7288	RF-Cable	2,0m; N-N	Huber & Suhner	28442/4PEA	CIU
7391	RF-Cable	1,0m; SMA	Huber & Suhner	40447/4P	CIU
7391	RF-Cable	0,5m; SMA	Huber & Suhner	40225/4P	CIU

CIU = Calibrate in use

3.3 Input and output losses

All recorded power levels should be referenced to the input and output connectors of the repeater, unless explicitly stated otherwise.

The test equipment used in this test has to be calibrated, so that the functionality is also checked.

All cables, attenuators, splitter, isolator, circulator and combiner etc. must be measured before testing and used for compensation during testing.

3.4 Measurement uncertainty

The extended measurement uncertainty corresponds to the measurement results from the standard measurement uncertainty multiplied by the coverage factor $k=2$. The true value is located in the corresponding interval with a probability of 95 %.

Test Report No.: 11-106

FCC ID: XS5-ML78519P

IC ID: 2237E-ML78519P



4 Test site (TEMPTON Service Plus GmbH)

FCC Test site:

IC OATS:

See relevant dates under section 8.



5 RF Power Out: §24.232, §2.1046; RSS-133, RSS-GEN

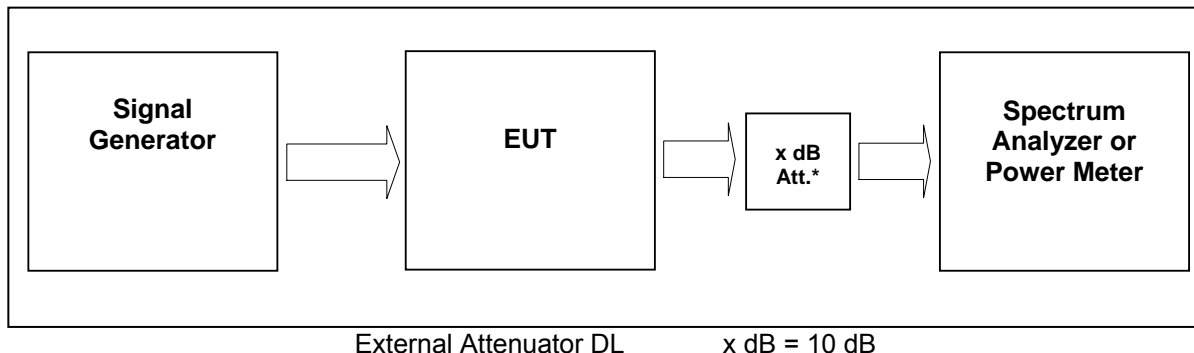

figure 3.4-#1 Test setup: RF Power Out: §24.232, §2.1046; RSS-133, RSS-GEN

Measurement uncertainty	± 0,38 dB
Test equipment used	8890; 8667; 8668; 8848; 7355;

5.1 Limit

Minimum standard:

Para. No.24.232

(a)(1) Base stations with an emission bandwidth of 1 MHz or less are limited to 1640 watts equivalent isotropically radiated power (EIRP) with an antenna height up to 300 meters HAAT, except as described in paragraph (b) below.

(2) Base stations with an emission bandwidth greater than 1 MHz are limited to 1640 watts/MHz equivalent isotropically radiated power (EIRP) with an antenna height up to 300 meters HAAT, except as described in paragraph (b) below.

Table 1—Reduced Power for Base Station Antenna Heights Over 300 Meters

HAAT in meters	Maximum EIRP watts
≤ 300	1640
≤ 500	1070
≤ 1000	490
≤ 1500	270
≤ 2000	160

5.2 Test method

§ 2.1046 Measurements required: RF power output.

(a) For transmitters other than single sideband, independent sideband and controlled carrier radiotelephone, power output shall be measured at the RF output terminals when the transmitter is adjusted in accordance with the tune-up procedure to give the values of current and voltage on the circuit elements specified in § 2.1033(c)(8). The electrical characteristics of the radio frequency load attached to the output terminals when this test is made shall be stated.

Test Report No.: 11-106

FCC ID: XS5-ML78519P

IC ID: 2237E-ML78519P



(c) For measurements conducted pursuant to paragraphs (a) and (b) of this section, all calculations and methods used by the applicant for determining carrier power or peak envelope power, as appropriate, on the basis of measured power in the radio frequency load attached to the transmitter output terminals shall be shown. Under the test conditions specified, no components of the emission spectrum shall exceed the limits specified in the applicable rule parts as necessary for meeting occupied bandwidth or emission limitations

5.3 Test results

Detector RMS.

Test signal GSM:

Signal waveform with GMSK modulation in all time slots according to 3GPP TS45.004

Test signal GSM EDGE:

Signal waveform with 8-PSK modulation in all time slots according to 3GPP TS45.004

Test signal CDMA

Signal waveform according to table 6.2-1 of standard specification 3GPP2 C.p0051-0 v1.0 16.February 2006 pilot, sync, paging, 37 traffics, which is equal to the table 6.5.2.1 of 3GPP2 C.S0010-C v2.0 24.February 2006.

Test signal WCDMA

Signal waveform according to Test Model 1 of standard specification 3GPP TS25.141. Signal modulated with a combination of PCCPCH, SCCPCH and Dedicated Physical Channels specified as test model 1 64 DPCH.

Test signal LTE:

Signal waveform according to Test Model 1.1, E-TM1.1, clause 6.1.1.1-1, table 6.1.1.1-1 of standard specification 3GPP TS 36.141 V9.3.0 (2010-03).



5.3.1 Downlink

Modulation	Measured at	RBW VBW Span	RF Power (dBm)	RF Power (W)	Plot -
GSM	1962,5MHz	1MHz 3MHz 10MHz	43,23	21,04	5.3.1.1 #1
GSM-EDGE	1962,5 MHz	1MHz 3MHz 10MHz	43,05	20,18	5.3.1.2 #1
CDMA	1962,5 MHz	3MHz 10MHz 15MHz	43,34	21,58	5.3.1.3 #1
WCDMA	1962,5 MHz	10MHz 10MHz 50MHz	43,31	21,43	5.3.1.4 #1
LTE	1962,5 MHz	3MHz 10MHz 50MHz	43,23	21,04	5.3.1.5 #1
Maximum output power = 43,34 dBm -> 21,58 W					
Limit Maximum output power = 160 W -> 52,04 dBm					

table 5.3.1-#1 RF Power Out: §24.232, §2.1046; RSS-133, RSS-GEN Test results Downlink

Modulation	Pin / dBm (Ref. point B)
GSM	3,8
EDGE	3,4
CDMA	3,6
WCDMA	3,7
LTE	3,5

table 5.3.1-#2 RF Power Out: §24.232, §2.1046; RSS-133, RSS-GEN Test results Downlink Input power



5.3.1.1 GSM

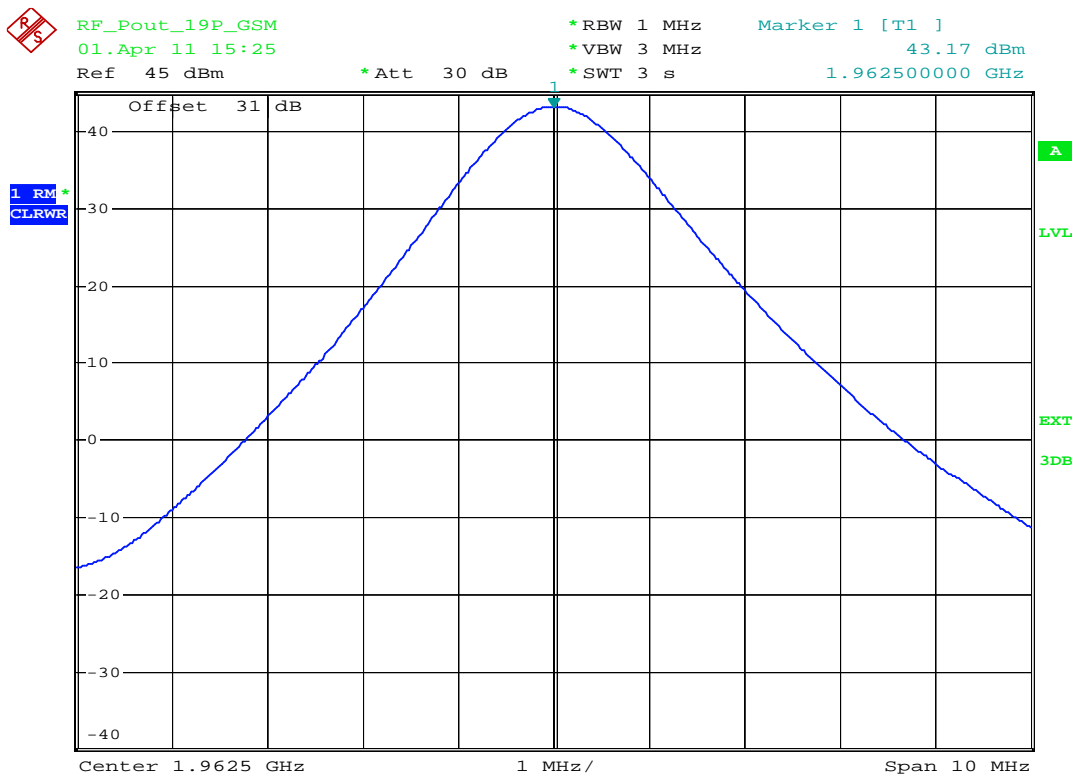

plot 5.3.1.1-#1 RF Power Out: §24.232, §2.1046; RSS-133, RSS-GEN; Test results; Downlink; GSM Middle

5.3.1.2 GSM-EDGE

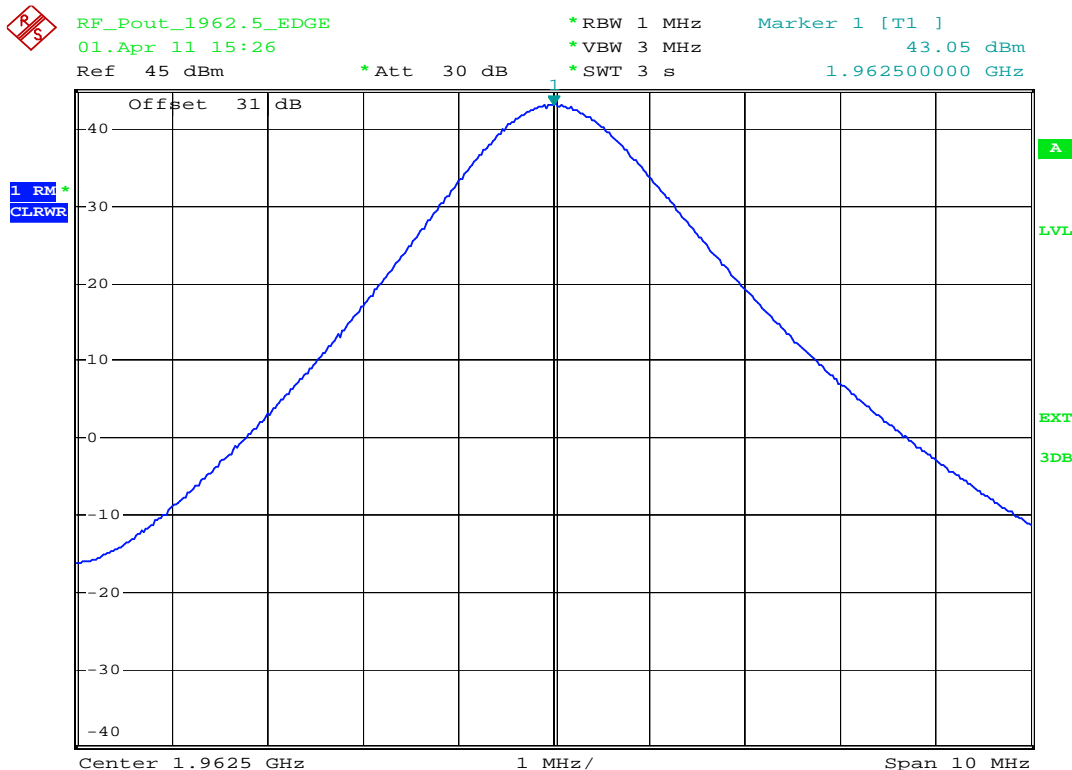

plot 5.3.1.2-#1 RF Power Out: §24.232, §2.1046; RSS-133, RSS-GEN; Test results; Downlink; GSM-EDGE Middle



5.3.1.3 CDMA

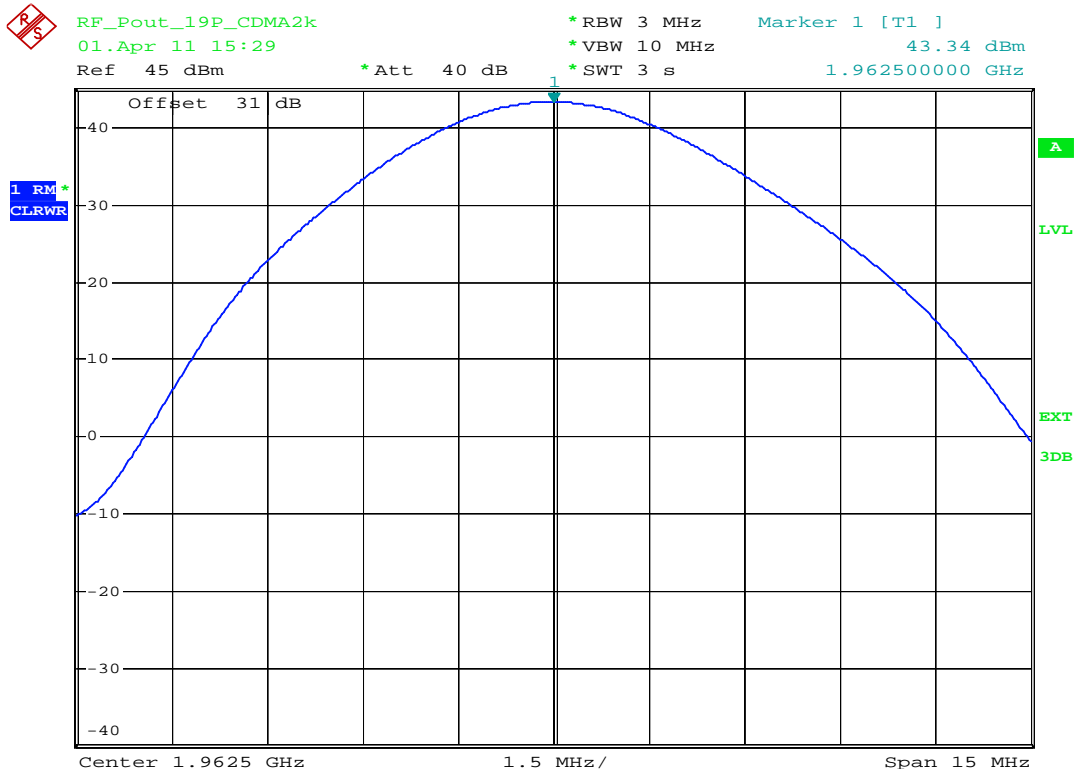

plot 5.3.1.3-#1 RF Power Out: §24.232, §2.1046; RSS-133, RSS-GEN; Test results; Downlink; CDMA Middle

5.3.1.4 W-CDMA

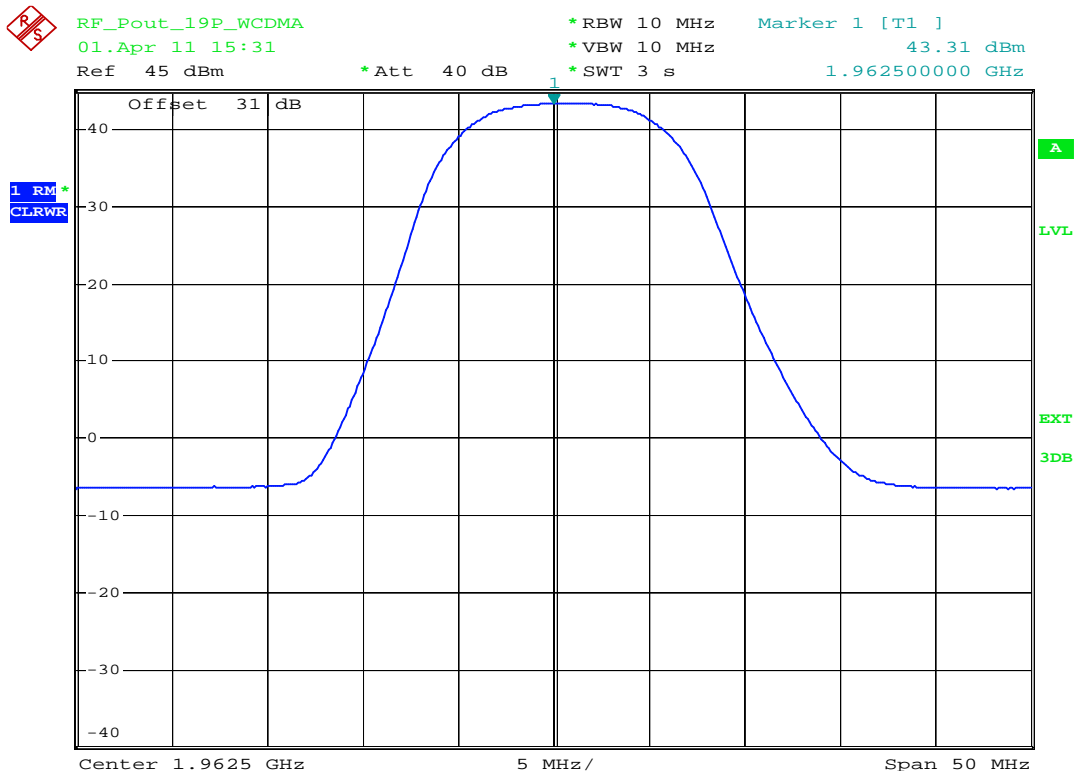

plot 5.3.1.4-#1 RF Power Out: §24.232, §2.1046; RSS-133, RSS-GEN; Test results; Downlink; W-CDMA Middle



5.3.1.5 LTE

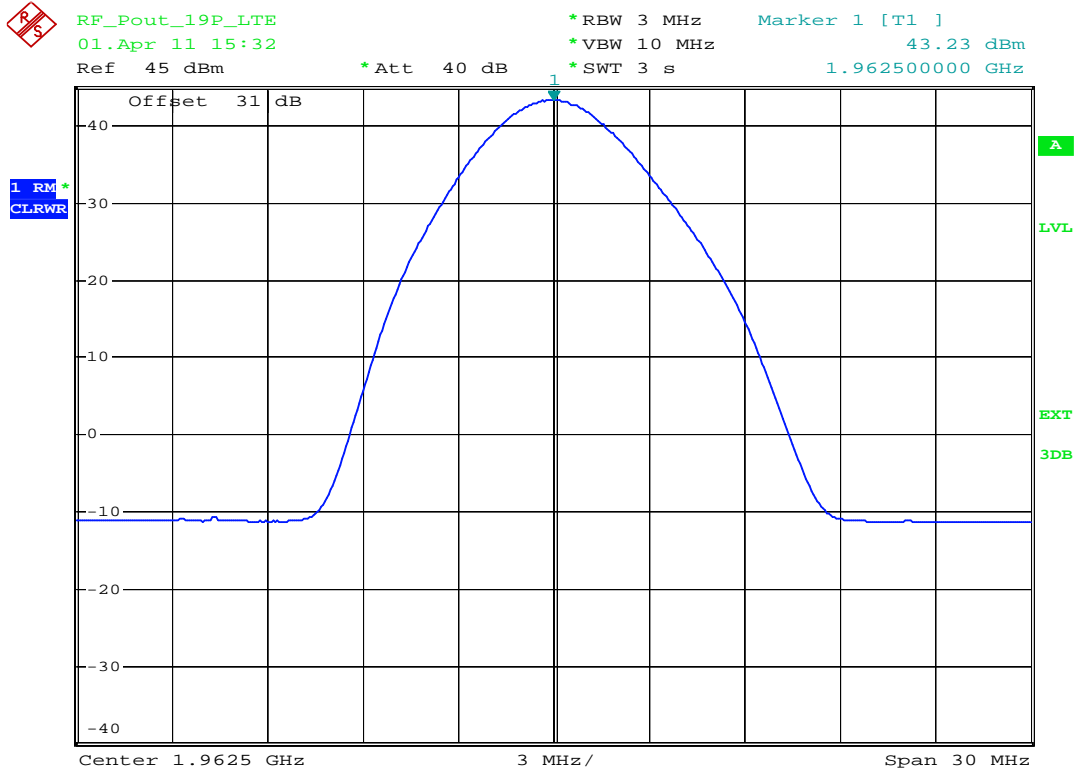

plot 5.3.1.5-#1 RF Power Out: §24.232, §2.1046; RSS-133, RSS-GEN; Test results; Downlink; LTE Middle

Test Report No.: 11-106

FCC ID: XS5-ML78519P

IC ID: 2237E-ML78519P



5.3.2 Uplink

n.a.

Note: The EUT does not transmit over the air in the uplink direction.

5.4 Summary test result

Test result	complies, according the plots above
Tested by:	L.Oskerko
Date:	01.04.2011

6 Occupied Bandwidth: §2.1049; RSS-GEN

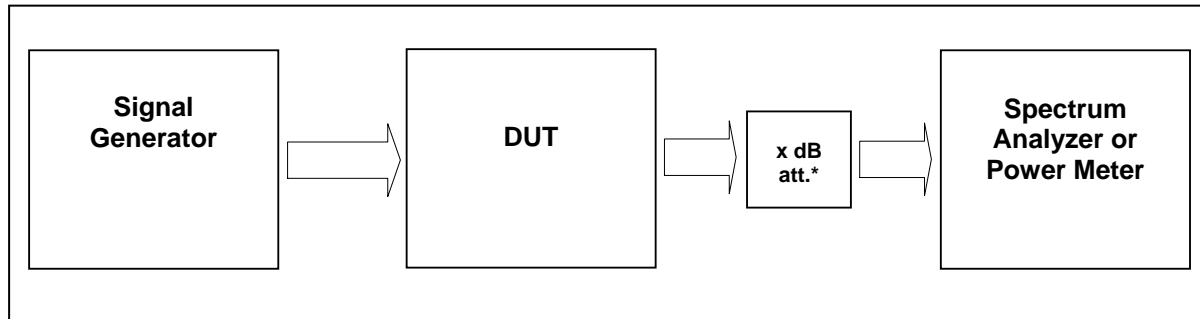

External Attenuator DL x dB = 10 dB
 figure 5.4-#1 Test setup: Occupied Bandwidth: §2.1049; RSS-GEN

Measurement uncertainty	± 0,38 dB
Test equipment used	8890; 8667; 8668; 8848; 7355;

6.1 Limit

The spectral shape of the output should look similar to input for all modulations.

6.2 Test method

Para. No.2.1049

The occupied bandwidth, that is the frequency bandwidth such that, below its lower and above its upper frequency limits, the mean powers radiated are each equal to 0.5 percent of the total mean power radiated by a given emission shall be measured under the following conditions as applicable:

(h) Transmitters employing digital modulation techniques—when modulated by an input signal such that its amplitude and symbol rate represent the maximum rated conditions under which the equipment will be operated. The signal shall be applied through any filter networks, pseudo-random generators or other devices required in normal service. Additionally, the occupied bandwidth shall be shown for operation with any devices used for modifying the spectrum when such devices are optional at the discretion of the user.



6.3 Test results

6.3.1 Downlink

Detector RMS.

Modulation	Measured at	Carrier /MHz	RBW VBW Span	Occupied Bandwidth / MHz	Plot #
CDMA	Middle	1962,5 MHz	30kHz 300kHz 5MHz	1.24	6.3.1.1 #1, #2
WCDMA	Middle	1962,5 MHz	100kHz 1MHz 10MHz	4.17	6.3.1.2 #1, #2
GSM	Middle	1962,5MHz	3kHz 30kHz 1MHz	0.248	6.3.1.3 #1, #2
GSM-EDGE	Middle	1962,5 MHz	3kHz 30kHz 1MHz	0.246	6.3.1.4 #1, #2
LTE	Middle	1962,5 MHz	30 kHz 300 kHz 5 MHz	1,10	6.3.1.5 #1,#2

table 6.3-#1 Occupied Bandwidth: §2.1049; RSS-GEN Test results Downlink



6.3.1.1 CDMA

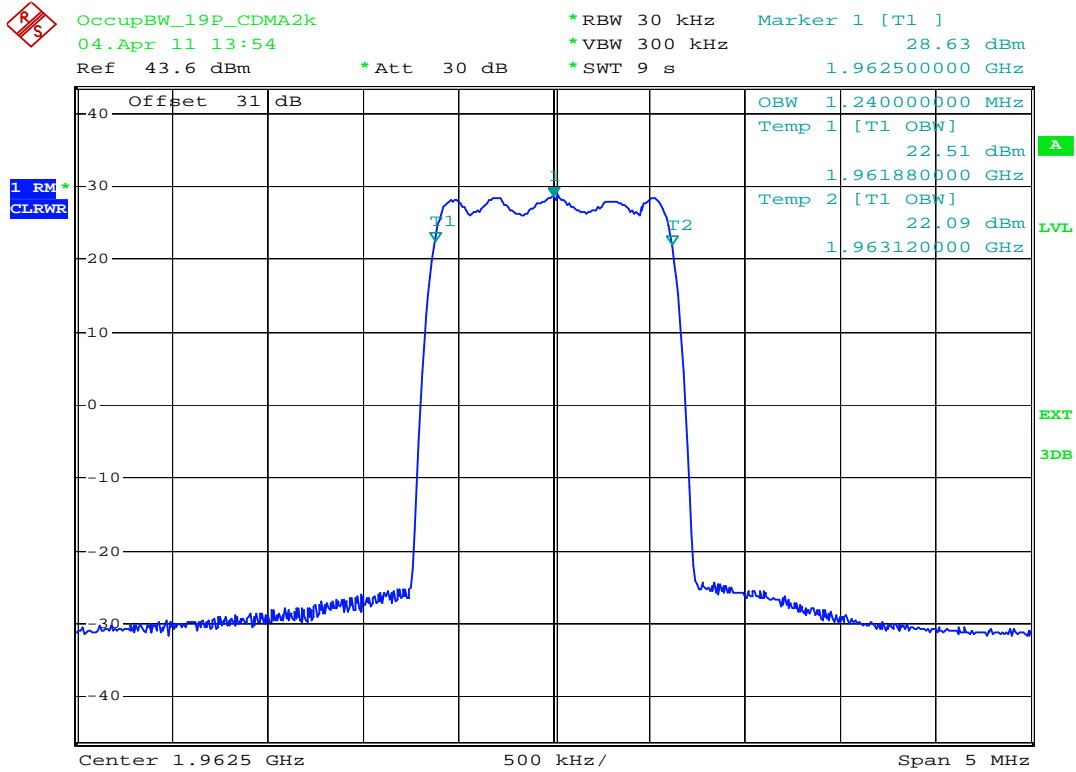

plot 6.3.1.1-#1 Occupied Bandwidth: §2.1049; RSS-GEN; Test results; Downlink; CDMA Output

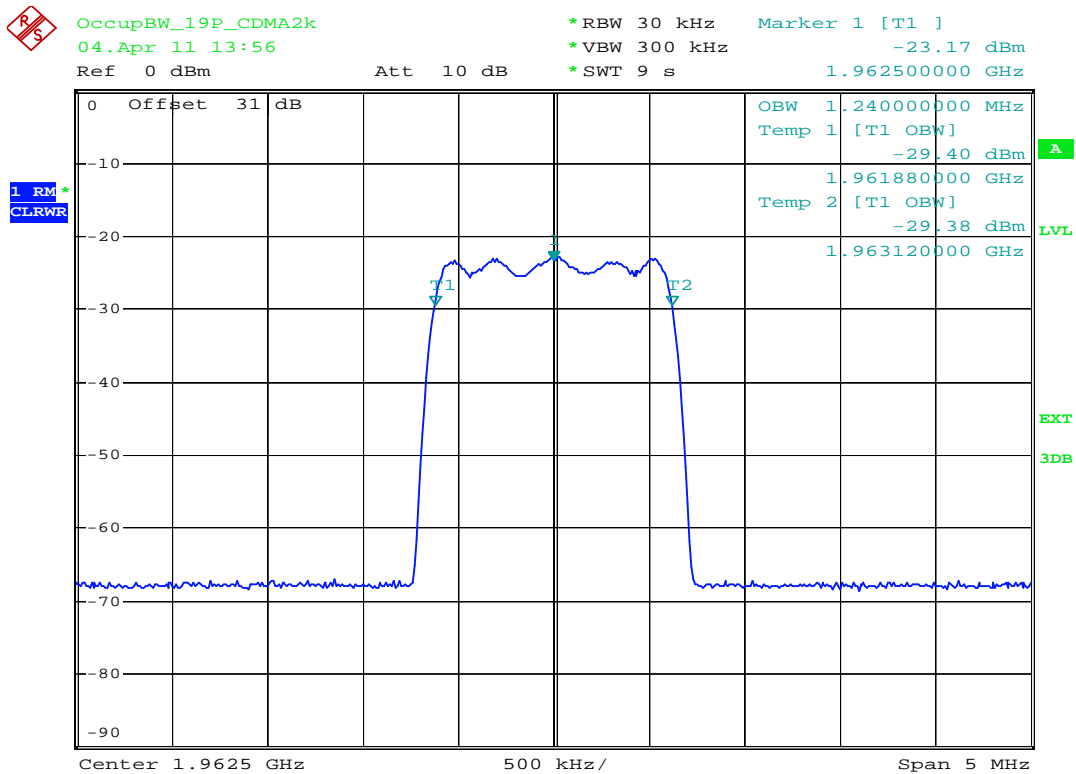

plot 6.3.1.1-#2 Occupied Bandwidth: §2.1049; RSS-GEN; Test results; Downlink; CDMA Input



6.3.1.2 W-CDMA



OccupBW_19P_WCDMA
04.Apr 11 14:02

*RBW 30 kHz Marker 1 [T1]
*VBW 300 kHz 22.49 dBm
*SWT 9 s 1.96250000 GHz

Ref 46.6 dBm

*Att 30 dB

1 RM*
CLRWR

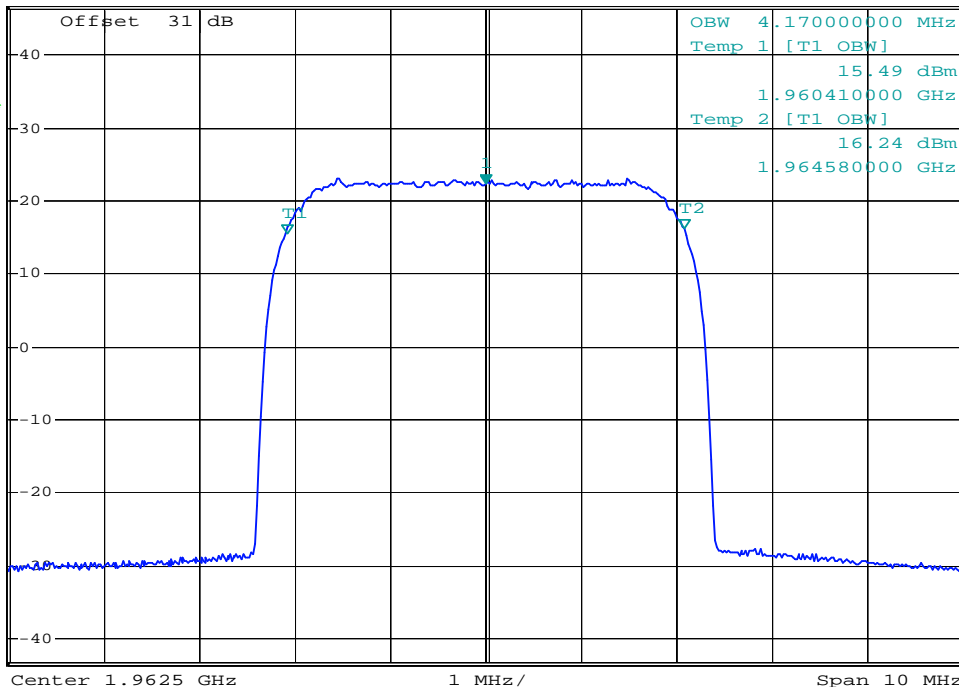

plot 6.3.1.2-#1 Occupied Bandwidth: §2.1049; RSS-GEN; Test results; Downlink; W-CDMA Output



OccupBW_19P_WCDMA
04.Apr 11 14:03

*RBW 30 kHz Marker 1 [T1]
*VBW 300 kHz -27.43 dBm
*SWT 9 s 1.96250000 GHz

Ref 0 dBm

Att 10 dB

1 RM*
CLRWR

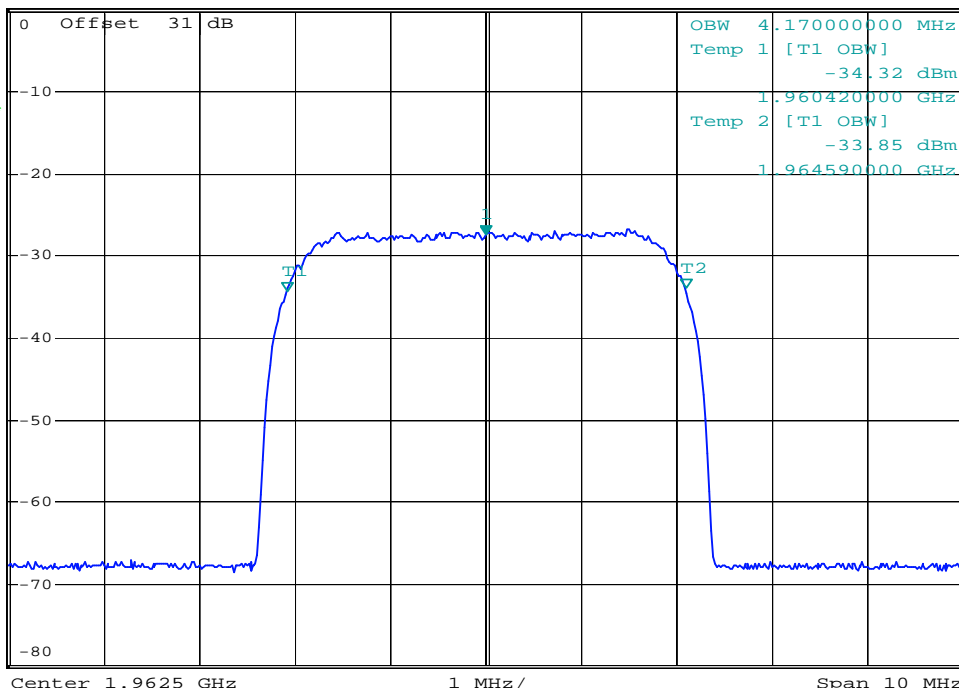

plot 6.3.1.2-#2 Occupied Bandwidth: §2.1049; RSS-GEN; Test results; Downlink; W-CDMA Input



6.3.1.3 GSM

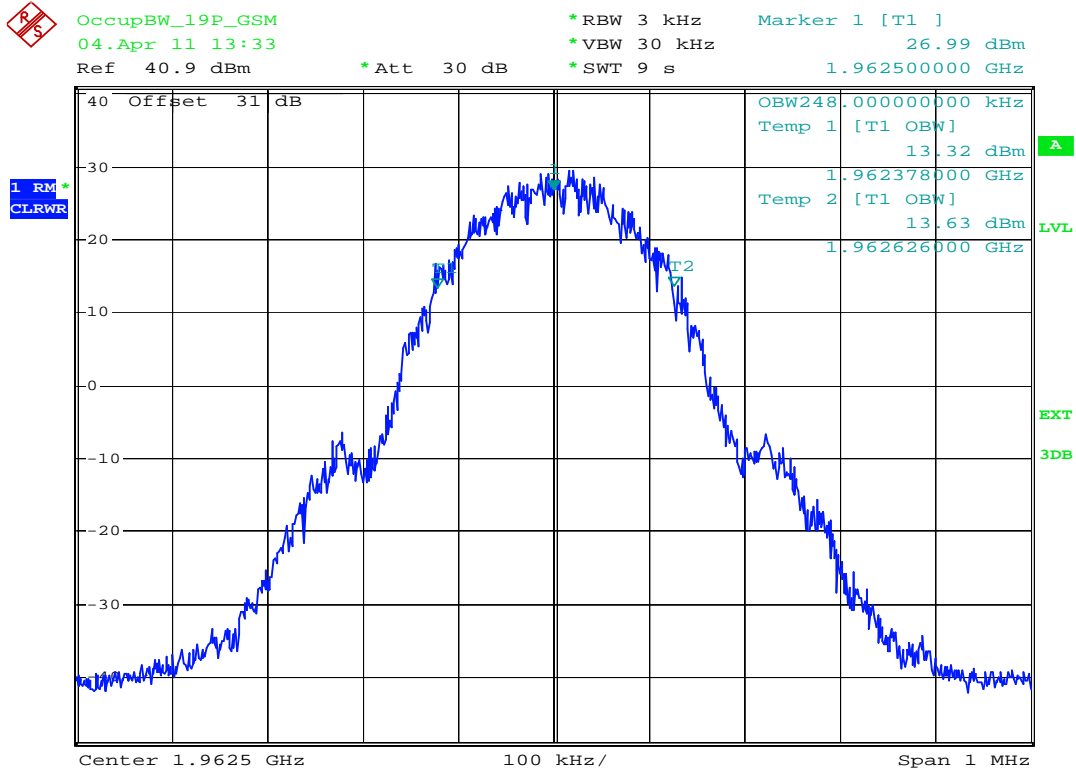

plot 6.3.1.3-#1 Occupied Bandwidth: §2.1049; RSS-GEN; Test results; Downlink; GSM Output

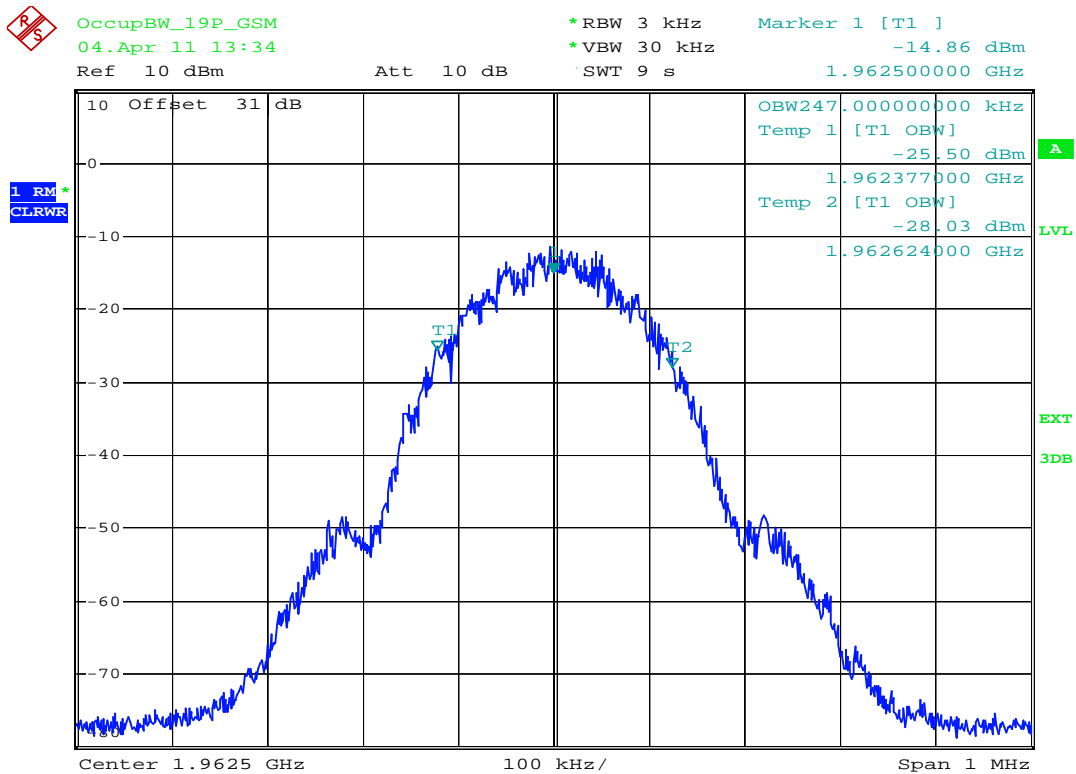

plot 6.3.1.3-#2 Occupied Bandwidth: §2.1049; RSS-GEN; Test results; Downlink; GSM Input



6.3.1.4 GSM-EDGE

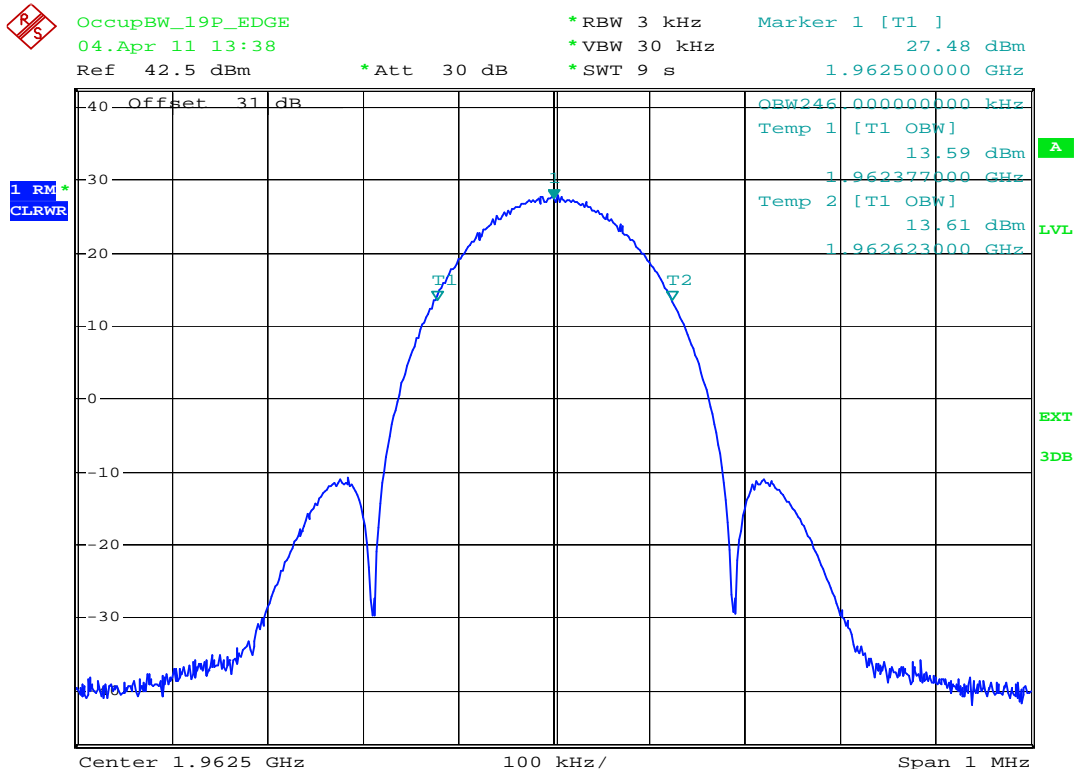

plot 6.3.1.4-#1 Occupied Bandwidth: §2.1049; RSS-GEN; Test results; Downlink; GSM-EDGE Output

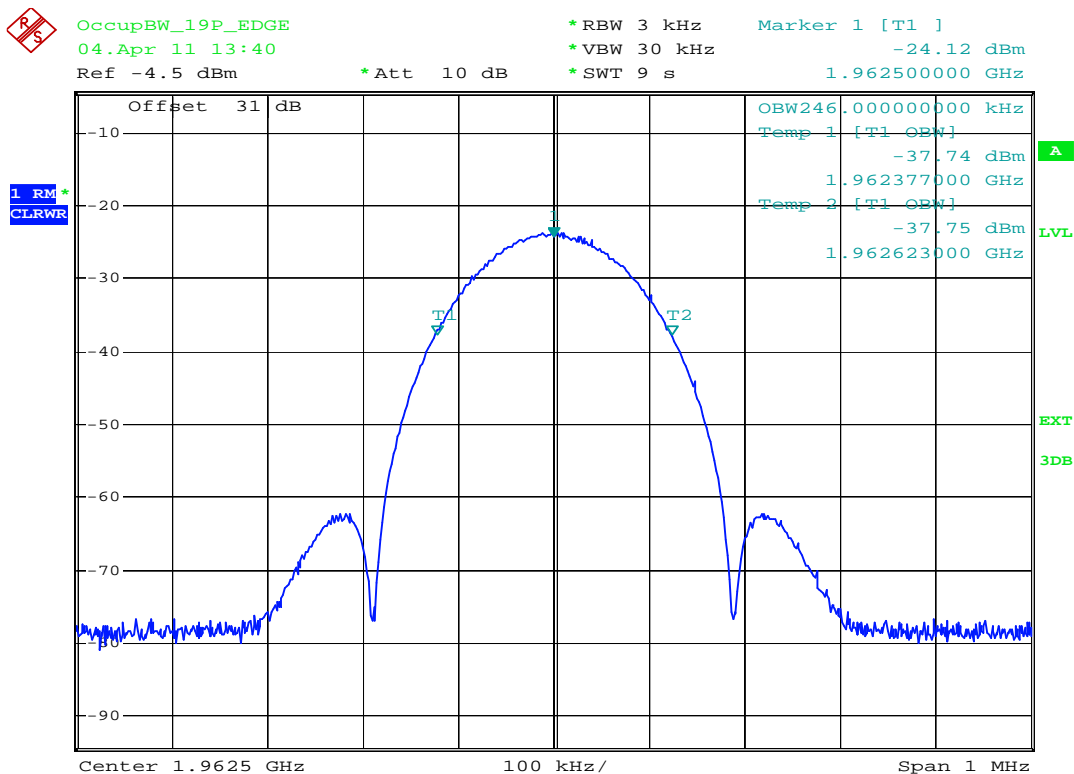

plot 6.3.1.4-#2 Occupied Bandwidth: §2.1049; RSS-GEN; Test results; Downlink; GSM-EDGE Input



6.3.1.5 LTE

 OccupBW_19P_LTE
04.Apr 11 14:06
Ref 43.2 dBm *Att 30 dB *RBW 30 kHz Marker 1 [T1]
*VBW 300 kHz 25.43 dBm
*SWT 9 s 1.962500000 GHz

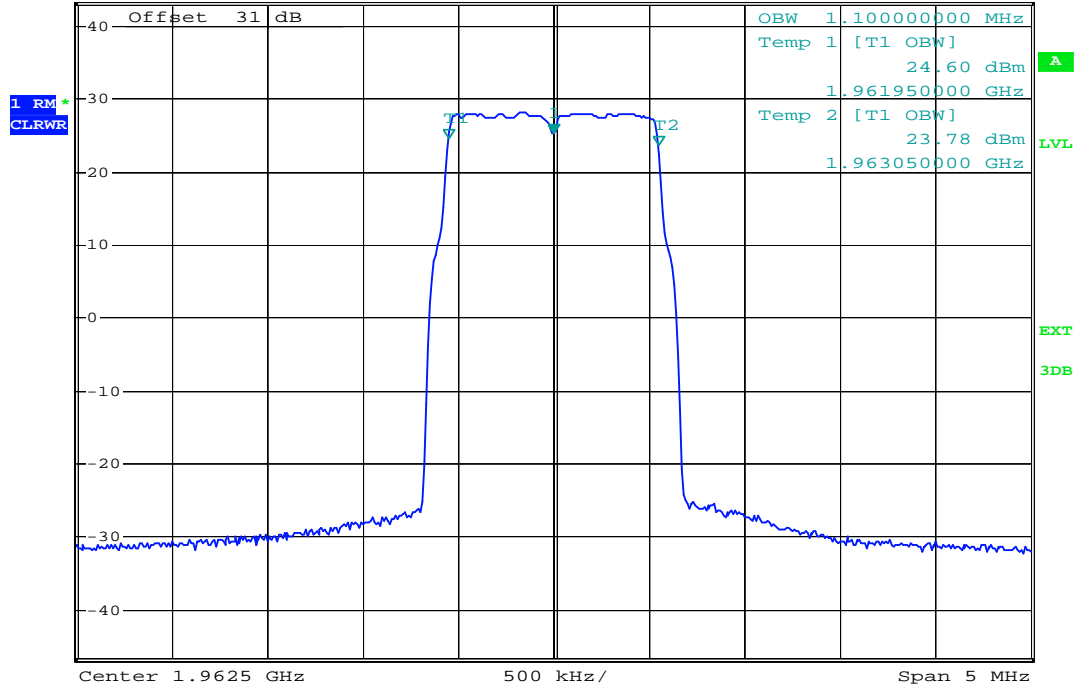

plot 6.3.1.5-#1 Occupied Bandwidth: §2.1049; RSS-GEN; Test results; Downlink; LTE Output

 OccupBW_19P_LTE
04.Apr 11 14:07
Ref 5 dBm Att 10 dB *RBW 30 kHz Marker 1 [T1]
*VBW 300 kHz -16.13 dBm
*SWT 9 s 1.962500000 GHz

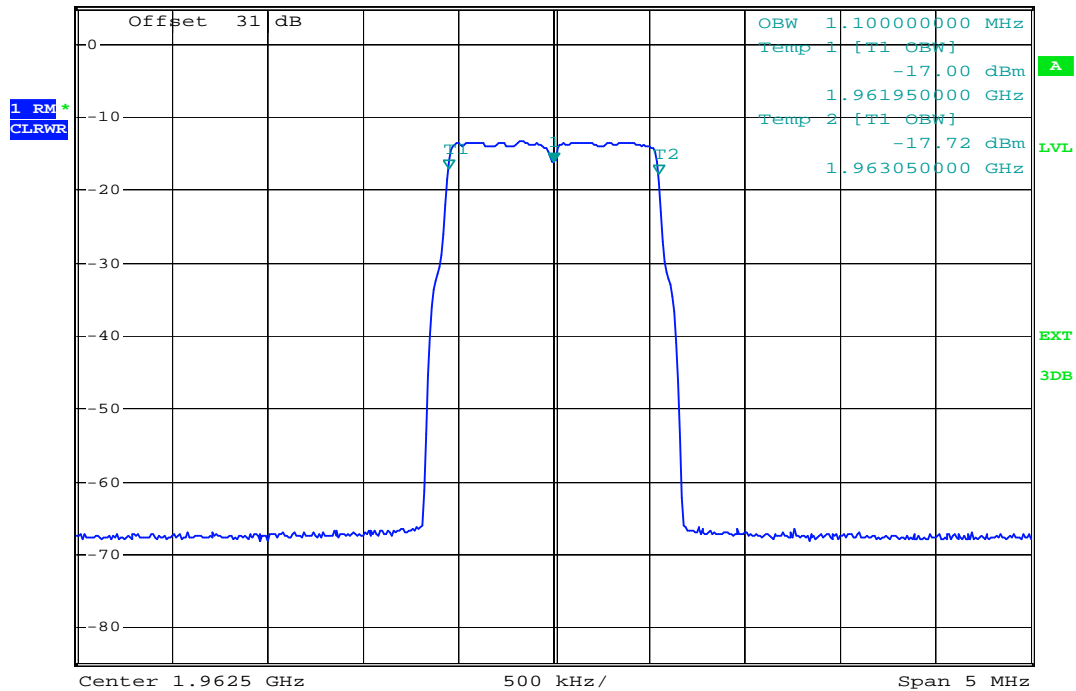

plot 6.3.1.5-#2 Occupied Bandwidth: §2.1049; RSS-GEN; Test results; Downlink; LTE Input

Test Report No.: 11-106

FCC ID: XS5-ML78519P

IC ID: 2237E-ML78519P



6.3.2 Uplink

n.a.

Note: The EUT does not transmit over the air in the uplink direction.

6.4 Summary test result

Test result	complies, according the plots above
Tested by:	L.Oskerko
Date:	04.01.2011

7 Spurious Emissions at Antenna Terminals: §24.238, §2.1051; RSS-132, RSS-GEN

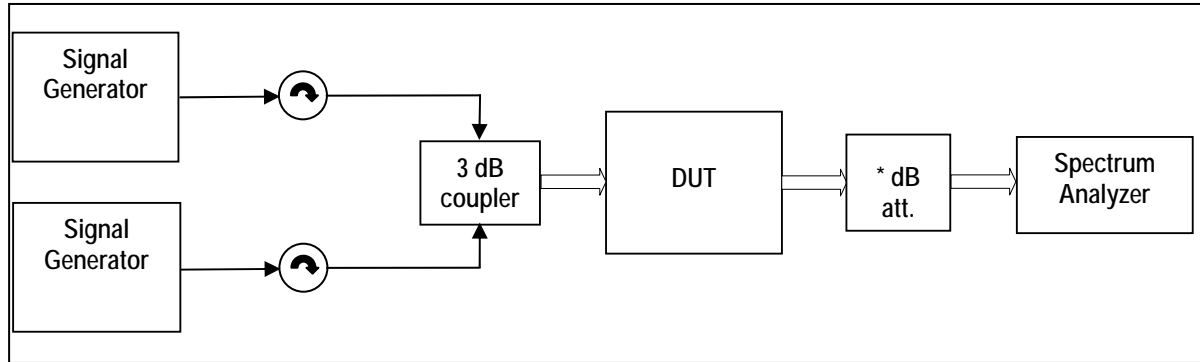

Multisignal-Generator used, External Attenuator DL x dB = 10 dB
 figure 7-#1 Test setup: Spurious Emissions at Antenna Terminals: §24.238, §2.1051; RSS-132, RSS-GEN

Measurement uncertainty	± 0,54 dB ± 1,2 dB ± 1,5 dB	9 kHz to 3 GHz 3 GHz to 7 GHz 7 GHz to 26 GHz
Test equipment used	8890; 8667; 8668; 8848; 7355;	

7.1 Limit

Minimum standard:

Para. No.24.238(a)

The rules in this section govern the spectral characteristics of emissions in the Broadband Personal Communications Service.

(a) Out of band emissions. The power of any emission outside of the authorized operating frequency ranges must be attenuated below the transmitting power (P) by a factor of at least $43 + 10 \log(P)$ dB.

7.2 Test method

Para. No 2.1051 Measurements required: Spurious emissions at antenna terminals.

The radio frequency voltage or powers generated within the equipment and appearing on a spurious frequency shall be checked at the equipment output terminals when properly loaded with a suitable artificial antenna. Curves or equivalent data shall show the magnitude of each harmonic and other spurious emission that can be detected when the equipment is operated under the conditions specified in § 2.1049 as appropriate. The magnitude of spurious emissions which are attenuated more than 20 dB below the permissible value need not be specified.

[39 FR 5919, Feb. 15, 1974. Redesignated and amended at 63 FR 36599, July 7, 1998]



7.3 Test results

7.3.1 Downlink

<1MHz from Band Edge

Detector: RMS.

Modulation	Measured at Band Edge	Carriers	RBW VBW Span	Max. level (dBm)	Plot -
CDMA	Lower Edge Upper Edge	1930,775 MHz	30kHz	-24,40	7.3.1.1 #1
		1932,025 MHz	300kHz	-28,69	#2
		1992,975 MHz	6MHz		
WCDMA	Lower Edge Upper Edge	1932,6 MHz	100kHz	-23,77	7.3.1.2 #1
		1937,6 MHz	1MHz	-25,13	#2
		1987,4 MHz	15MHz		
		1992,4 MHz			
GSM	Lower Edge Upper Edge	1930,4 MHz	3kHz	-36,86	7.3.1.3 #1
		1930,6 MHz	30kHz	-38,50	#2
		1994,4 MHz	2MHz		
		1994,6 MHz			
GSM-EDGE	Lower Edge Upper Edge	1930,4 MHz	3kHz	-36,37	7.3.1.4 #1
		1930,6 MHz	30kHz	-37,51	#2
		1994,4 MHz	2MHz		
		1994,6 MHz			
LTE	Lower Edge Upper Edge	1930,7 MHz	30kHz	-22,68	7.3.1.5 #1
		1932,1 MHz	300kHz	-20,00	#2
		1994,3 MHz	6MHz		
		1992,9 MHz			

table 7.3-#1 Spurious Emissions at Antenna Terminals: §24.238, §2.1051; RSS-132, RSS-GEN Test results Downlink <1MHz from Band Edge



>1MHz from Band Edge
 Detector: RMS.

Modulation	Carrier at	Carrier	Max. level (dBm)	RBW VBW Frequency range	Plot -
CDMA	Middle	1962,5 MHz	<-30	1MHz 3MHz 30MHz – 20GHz	7.3.1.6 #1
WCDMA	Middle	1962,5 MHz	<-30	1MHz 3MHz 30MHz – 20GHz	7.3.1.7 #1
GSM	Middle	1962,5 MHz	<-30	1MHz 3MHz 30MHz – 20GHz	7.3.1.8 #1
GSM-EDGE	Middle	1962,5 MHz	<-30	1MHz 3MHz 30MHz – 20GHz	7.3.1.9 #1
LTE	Middle	1962,5 MHz	<-30	1MHz 3MHz 30MHz – 20GHz	7.3.1.10 #1

table 7.3-#2 Spurious Emissions at Antenna Terminals: §24.238, §2.1051; RSS-132, RSS-GEN Test results Downlink >1MHz from Band Edge



7.3.1.1 CDMA < 1MHz to band edge

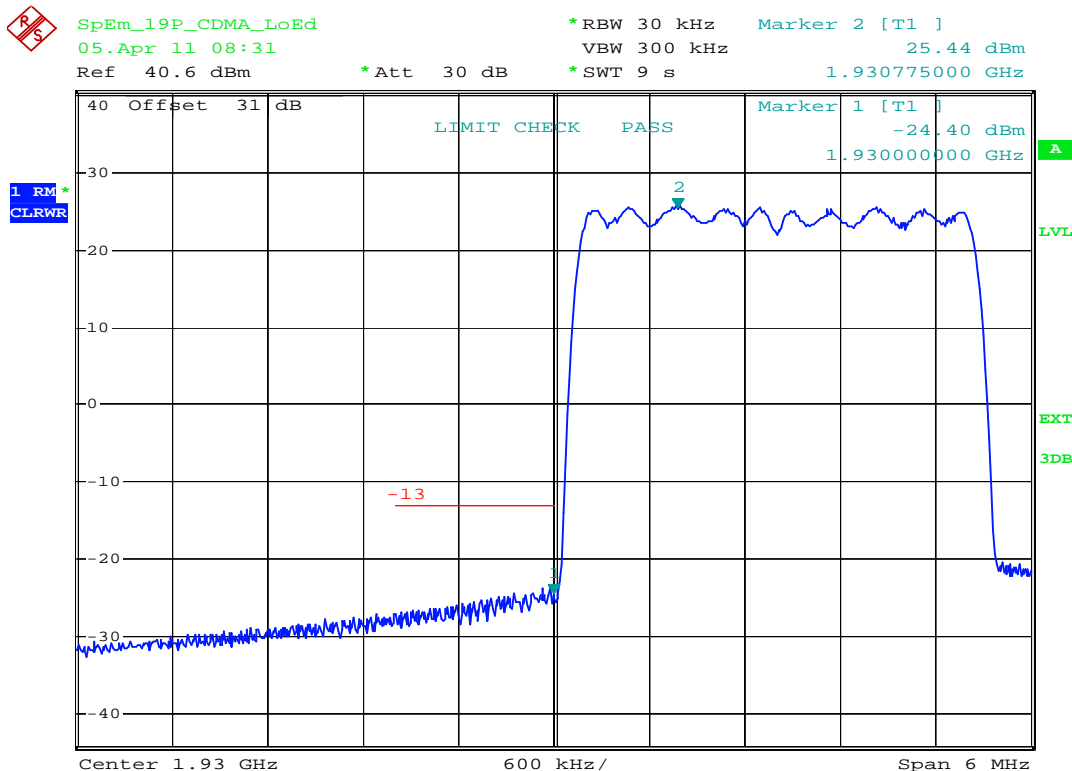

plot 7.3.1.1-#1 Spurious Emissions at Antenna Terminals: §24.238, §2.1051; RSS-132, RSS-GEN; Test results; Downlink; CDMA < 1MHz to band edge Lower Band Edge

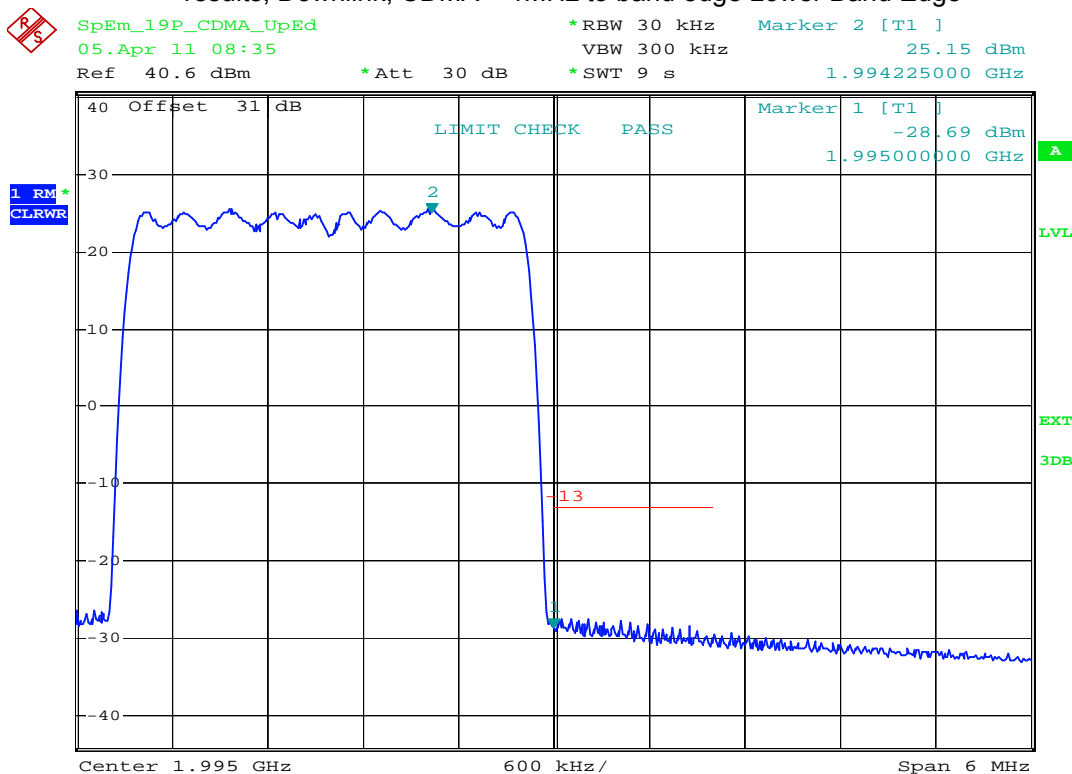

plot 7.3.1.1-#2 Spurious Emissions at Antenna Terminals: §24.238, §2.1051; RSS-132, RSS-GEN; Test results; Downlink; CDMA < 1MHz to band edge Upper Band Edge



7.3.1.2 W-CDMA < 1MHz to band edge

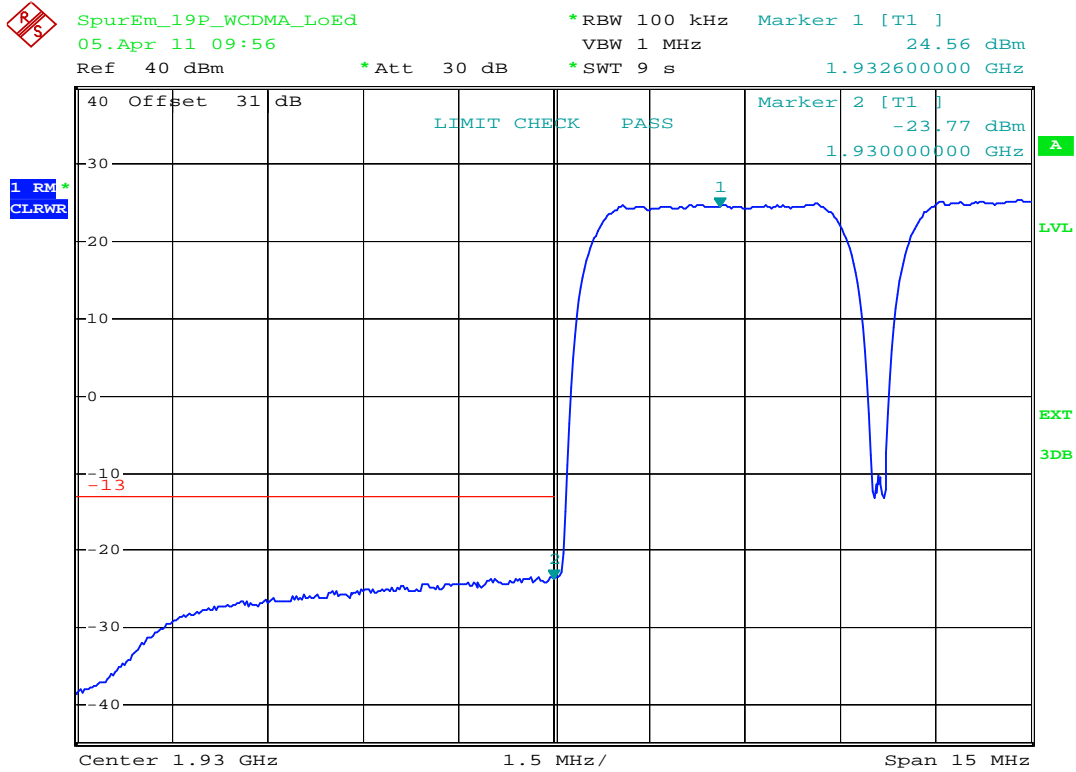

plot 7.3.1.2-#1 Spurious Emissions at Antenna Terminals: §24.238, §2.1051; RSS-132, RSS-GEN; Test results; Downlink; W-CDMA < 1MHz to band edge Lower Band Edge

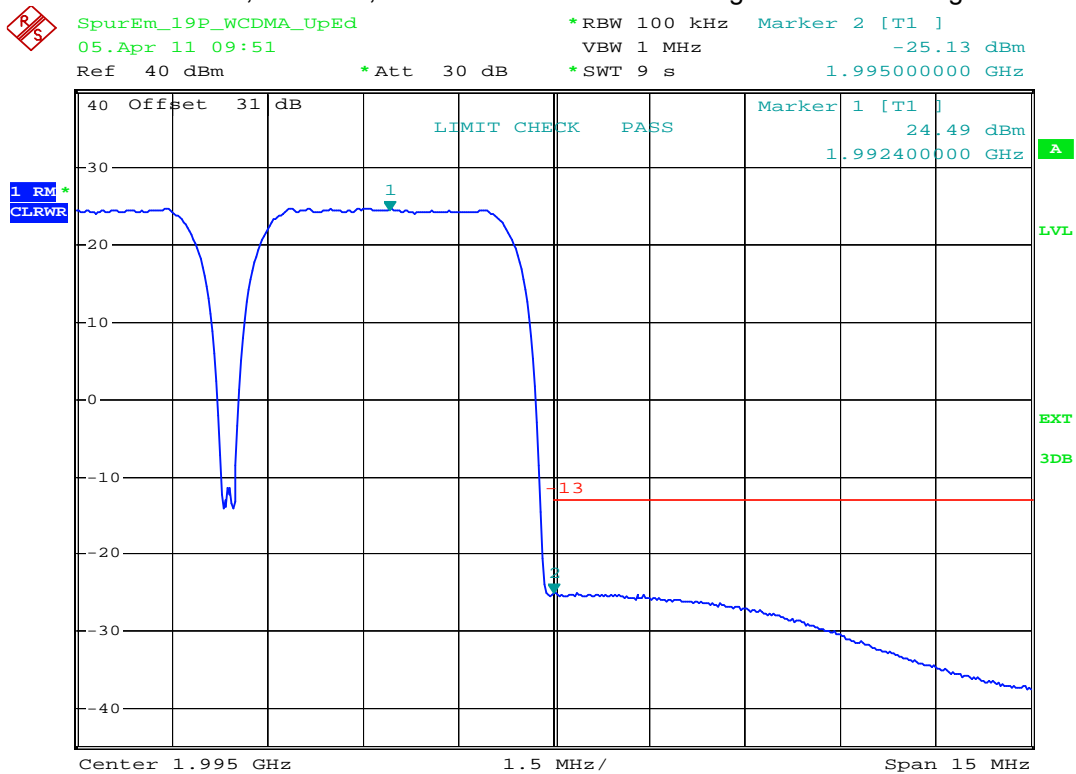

plot 7.3.1.2-#2 Spurious Emissions at Antenna Terminals: §24.238, §2.1051; RSS-132, RSS-GEN; Test results; Downlink; W-CDMA < 1MHz to band edge Upper Band Edge



7.3.1.3 GSM < 1MHz to band edge

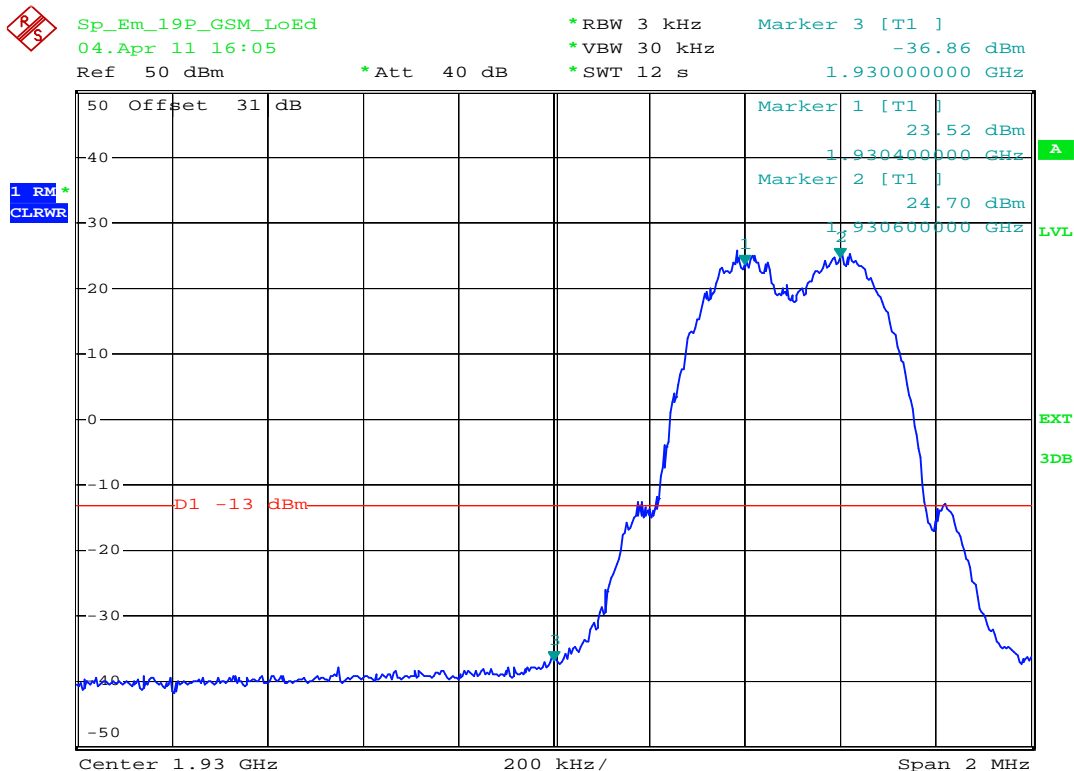

plot 7.3.1.3-#1 Spurious Emissions at Antenna Terminals: §24.238, §2.1051; RSS-132, RSS-GEN; Test results; Downlink; GSM < 1MHz to band edge Lower Band Edge

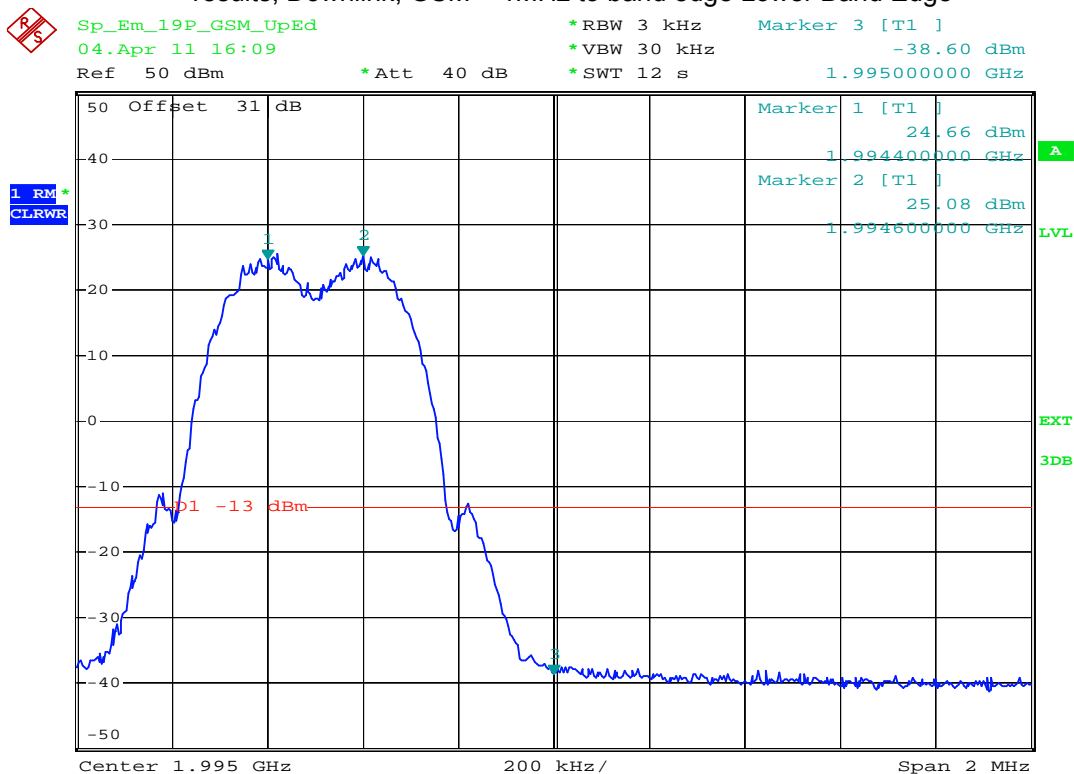

plot 7.3.1.3-#2 Spurious Emissions at Antenna Terminals: §24.238, §2.1051; RSS-132, RSS-GEN; Test results; Downlink; GSM < 1MHz to band edge Upper Band Edge



7.3.1.4 GSM-EDGE < 1MHz to band edge

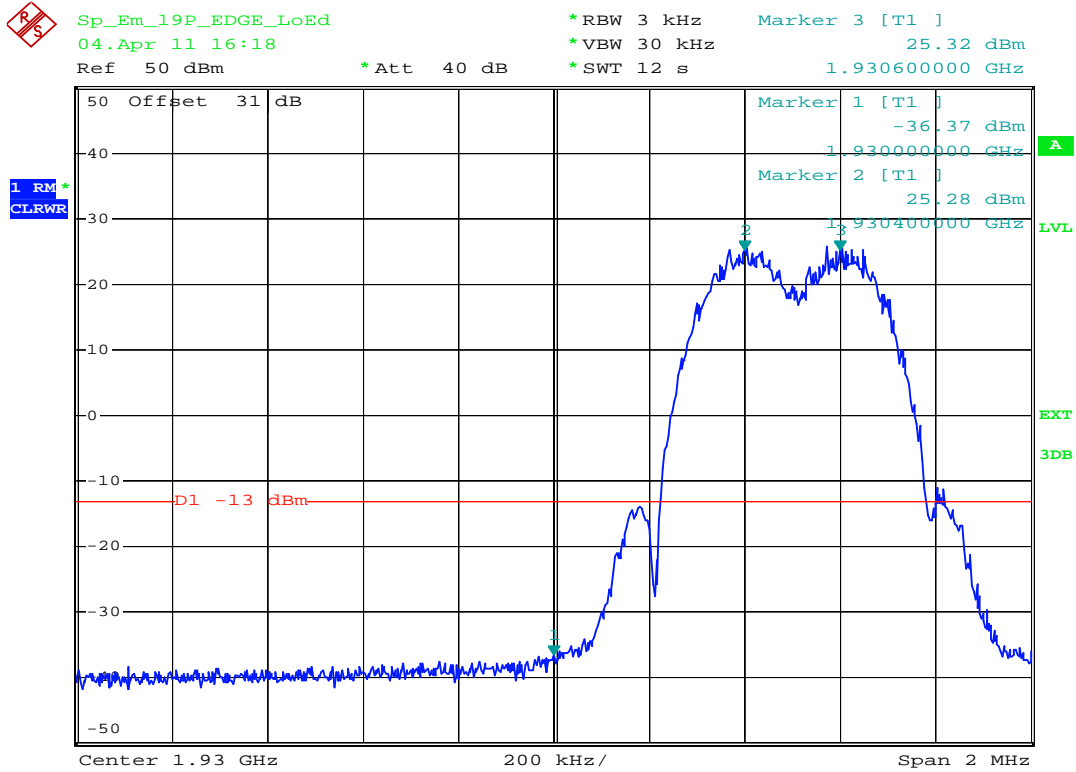

plot 7.3.1.4-#1 Spurious Emissions at Antenna Terminals: §24.238, §2.1051; RSS-132, RSS-GEN; Test results; Downlink; GSM-EDGE < 1MHz to band edge Lower Band Edge

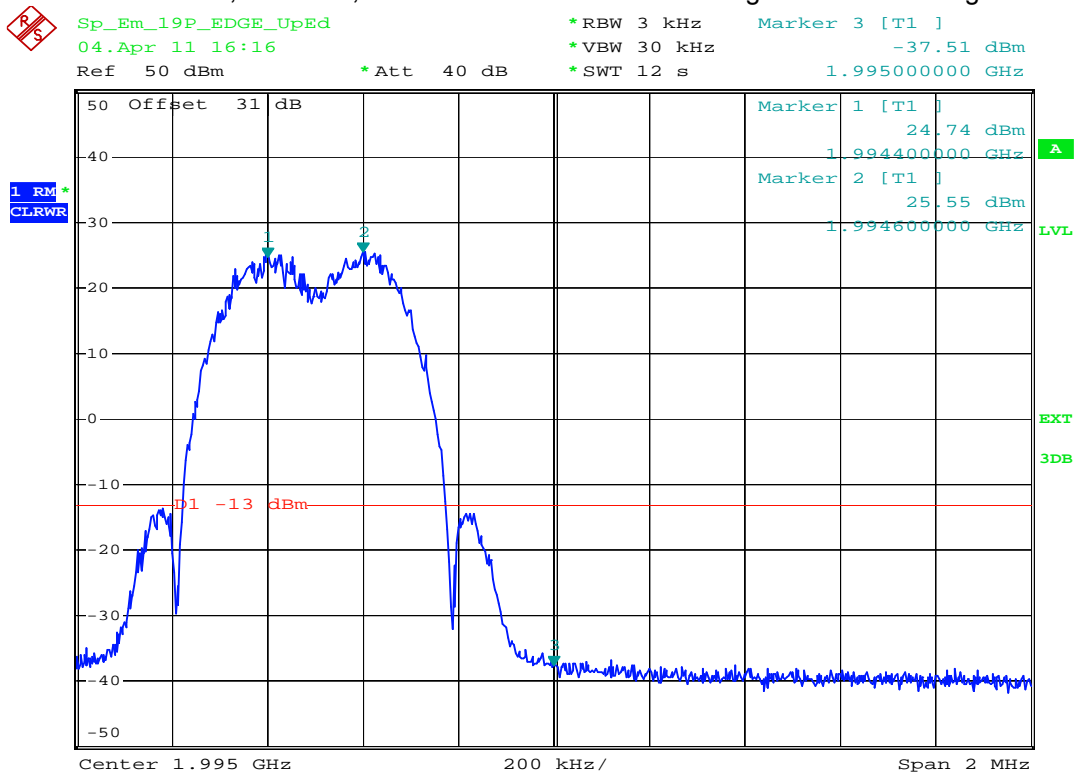

plot 7.3.1.4-#2 Spurious Emissions at Antenna Terminals: §24.238, §2.1051; RSS-132, RSS-GEN; Test results; Downlink; GSM-EDGE < 1MHz to band edge Upper Band Edge



7.3.1.5 LTE < 1MHz to band edge

R/S
Emission Measurement
*RBW 30 kHz Marker 2 [T1]
04.Apr 11 17:20
VBW 300 kHz 22.45 dBm
Ref 39.8 dBm
*Att 30 dB *SWT 6 s 1.930700000 GHz

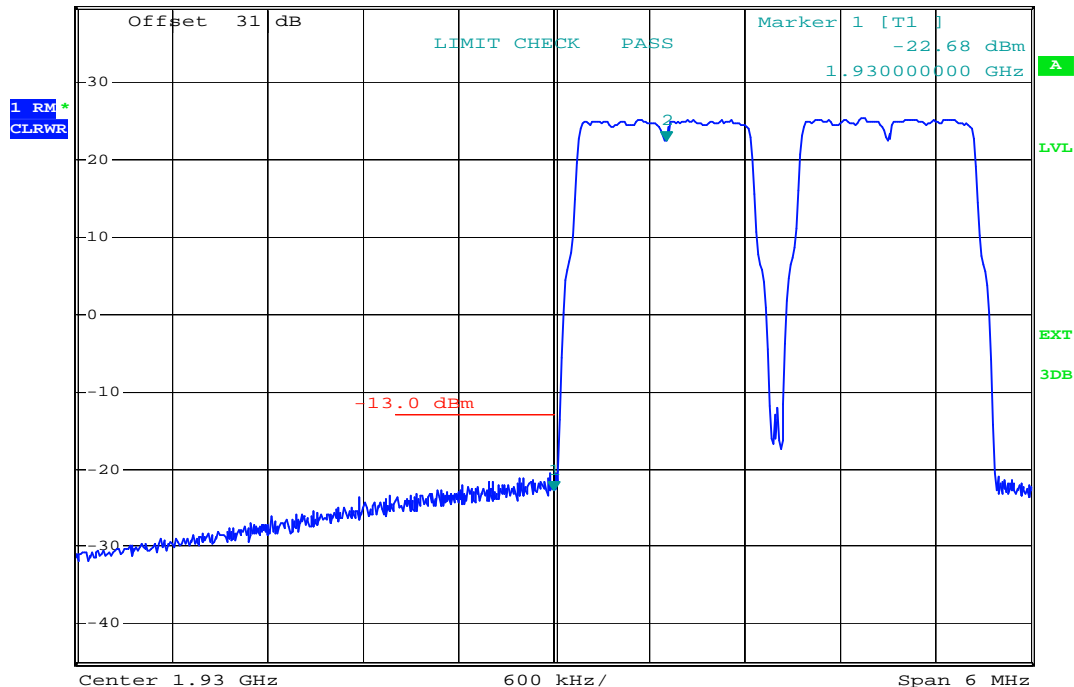

plot 7.3.1.5-#1 Spurious Emissions at Antenna Terminals: §24.238, §2.1051; RSS-132, RSS-GEN; Test results; Downlink; LTE < 1MHz to band edge Lower Band Edge

R/S
Emission Measurement
*RBW 30 kHz Marker 1 [T1]
04.Apr 11 17:21
VBW 300 kHz -20.00 dBm
Ref 40.6 dBm
*Att 30 dB *SWT 4 s 1.995000000 GHz

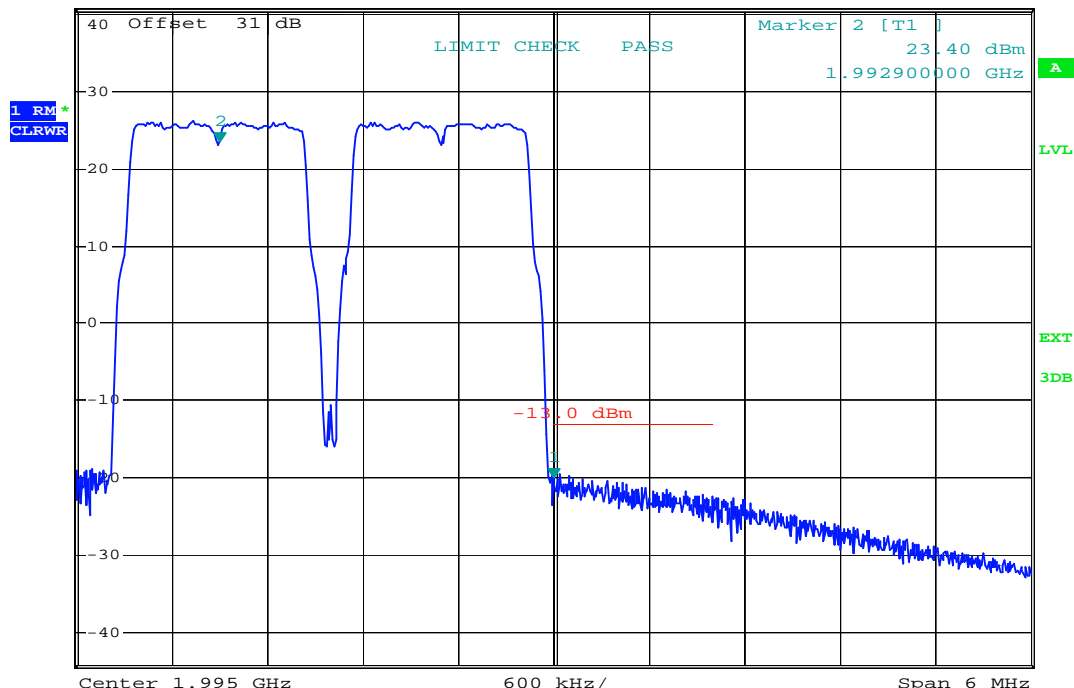

plot 7.3.1.5-#2 Spurious Emissions at Antenna Terminals: §24.238, §2.1051; RSS-132, RSS-GEN; Test results; Downlink; LTE < 1MHz to band edge Upper Band Edge



7.3.1.6 CDMA > 1MHz to band edge

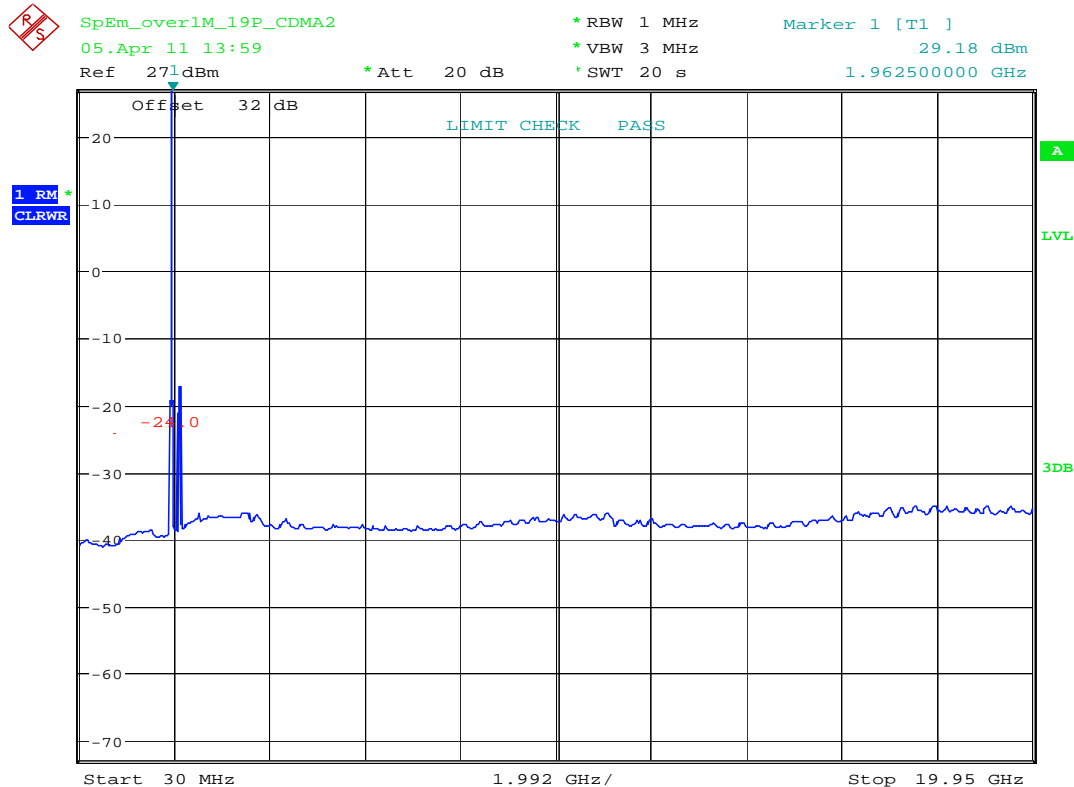

plot 7.3.1.6-#1 Spurious Emissions at Antenna Terminals: §24.238, §2.1051; RSS-132, RSS-GEN; Test results; Downlink; CDMA > 1MHz to band edge; carrier (1962,5MHz) notched

7.3.1.7 W-CDMA > 1MHz to band edge

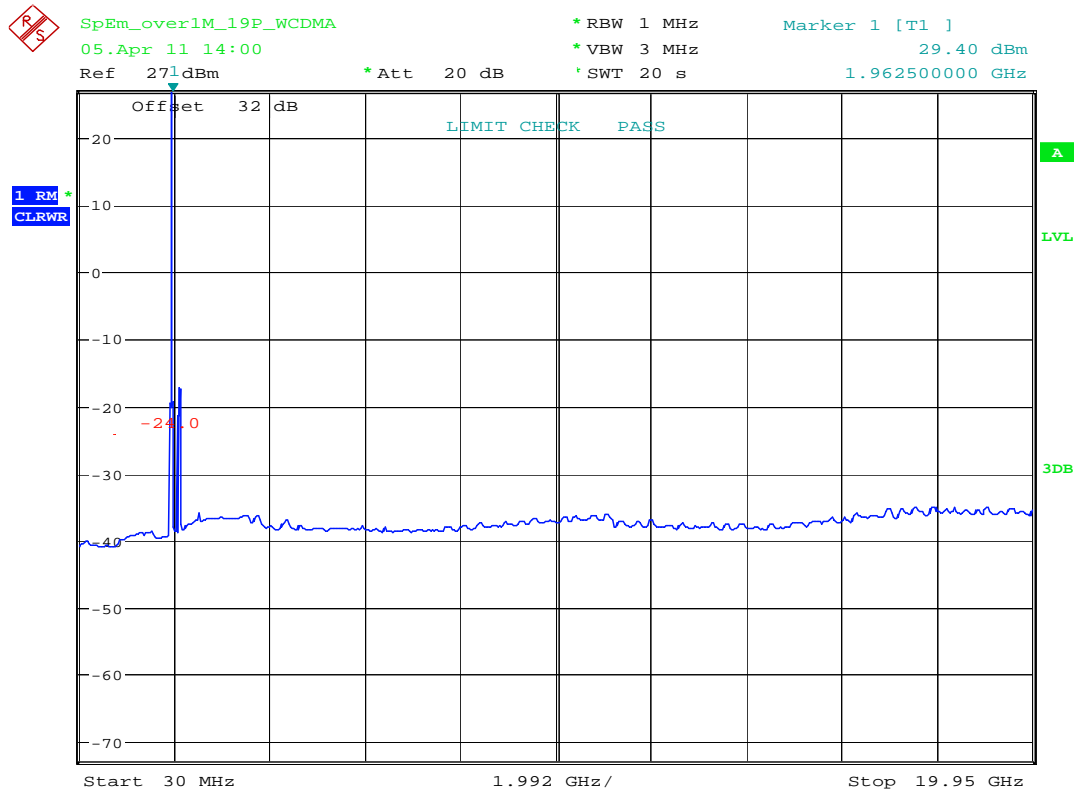

plot 7.3.1.7-#1 Spurious Emissions at Antenna Terminals: §24.238, §2.1051; RSS-132, RSS-GEN; Test results; Downlink; W-CDMA > 1MHz to band edge; carrier (1962,5MHz) notched



7.3.1.8 GSM > 1MHz to band edge

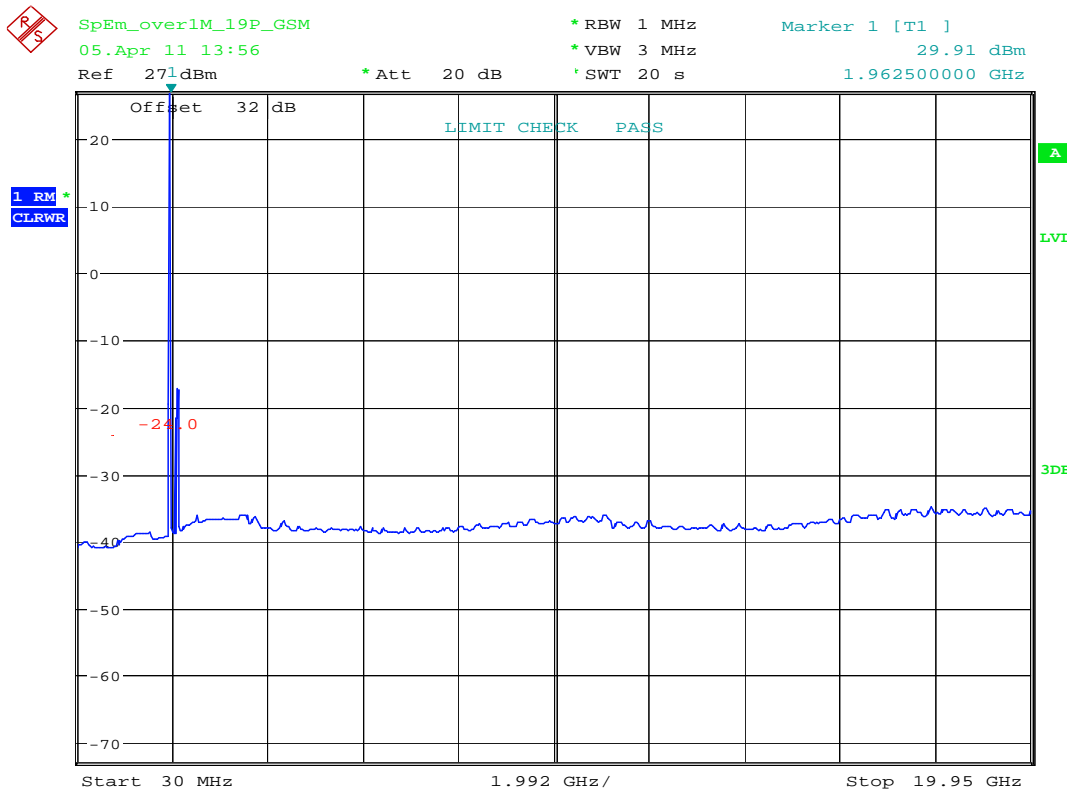

plot 7.3.1.8-#1 Spurious Emissions at Antenna Terminals: §24.238, §2.1051; RSS-132, RSS-GEN; Test results; Downlink; GSM > 1MHz to band edge; carrier (1962,5MHz) notched

7.3.1.9 GSM-EDGE > 1MHz to band edge

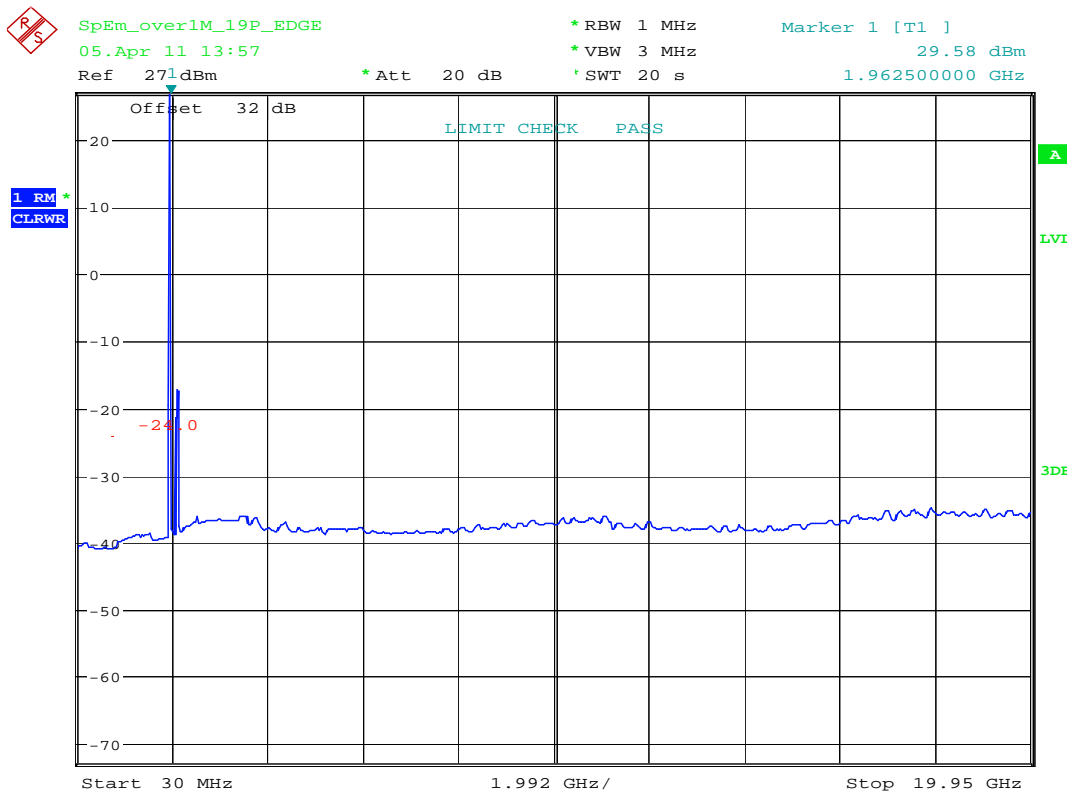

plot 7.3.1.9-#1 Spurious Emissions at Antenna Terminals: §24.238, §2.1051; RSS-132, RSS-GEN; Test results; Downlink; GSM-EDGE > 1MHz to band edge; carrier (1962,5MHz) notched

Test Report No.: 11-106

FCC ID: XS5-ML78519P

IC ID: 2237E-ML78519P



7.3.1.10 LTE > 1MHz to band edge

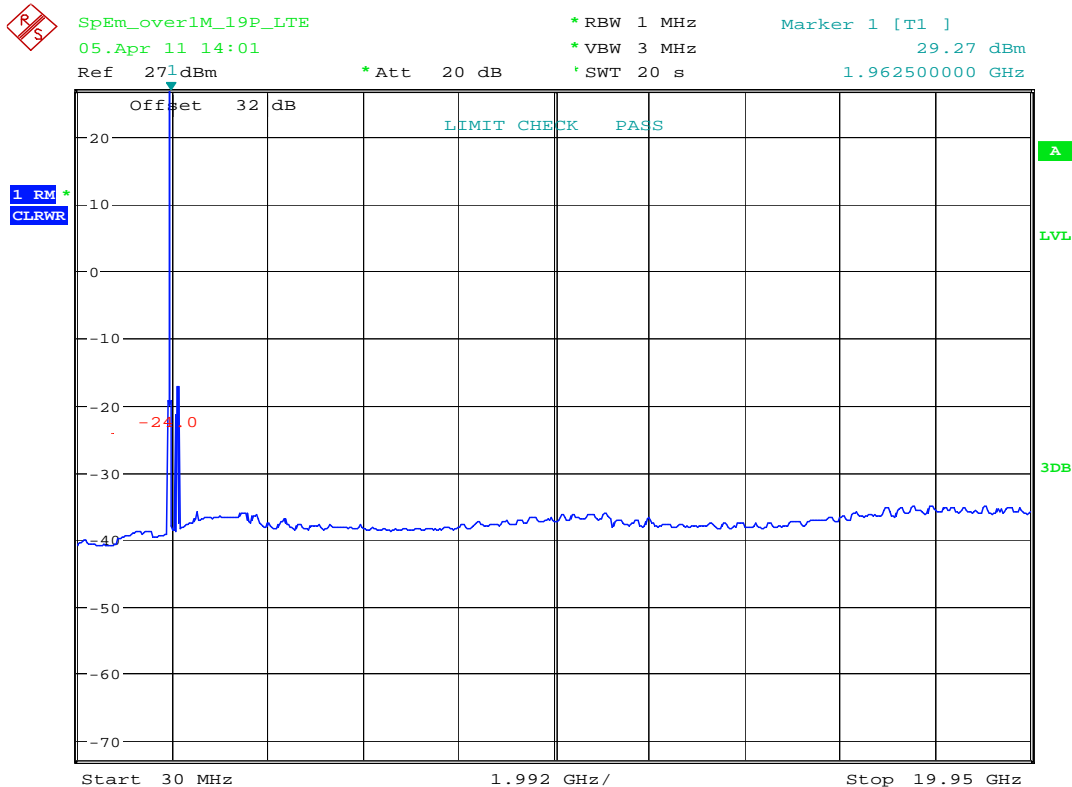

plot 7.3.1.10-#1 Spurious Emissions at Antenna Terminals: §24.238, §2.1051; RSS-132, RSS-GEN; Test results; Downlink; LTE > 1MHz to band edge; carrier (1962,5MHz) notched

7.3.2 Uplink

n.a.

Note: The EUT does not transmit over the air in the uplink direction.

7.4 Summary test result

Test result	complies, according the plots above
Tested by:	L.Oskerko
Date:	05.04.2011

8 Radiated Spurious Emissions: §24.238, §2.1053, RSS-133



picture 8.1: label

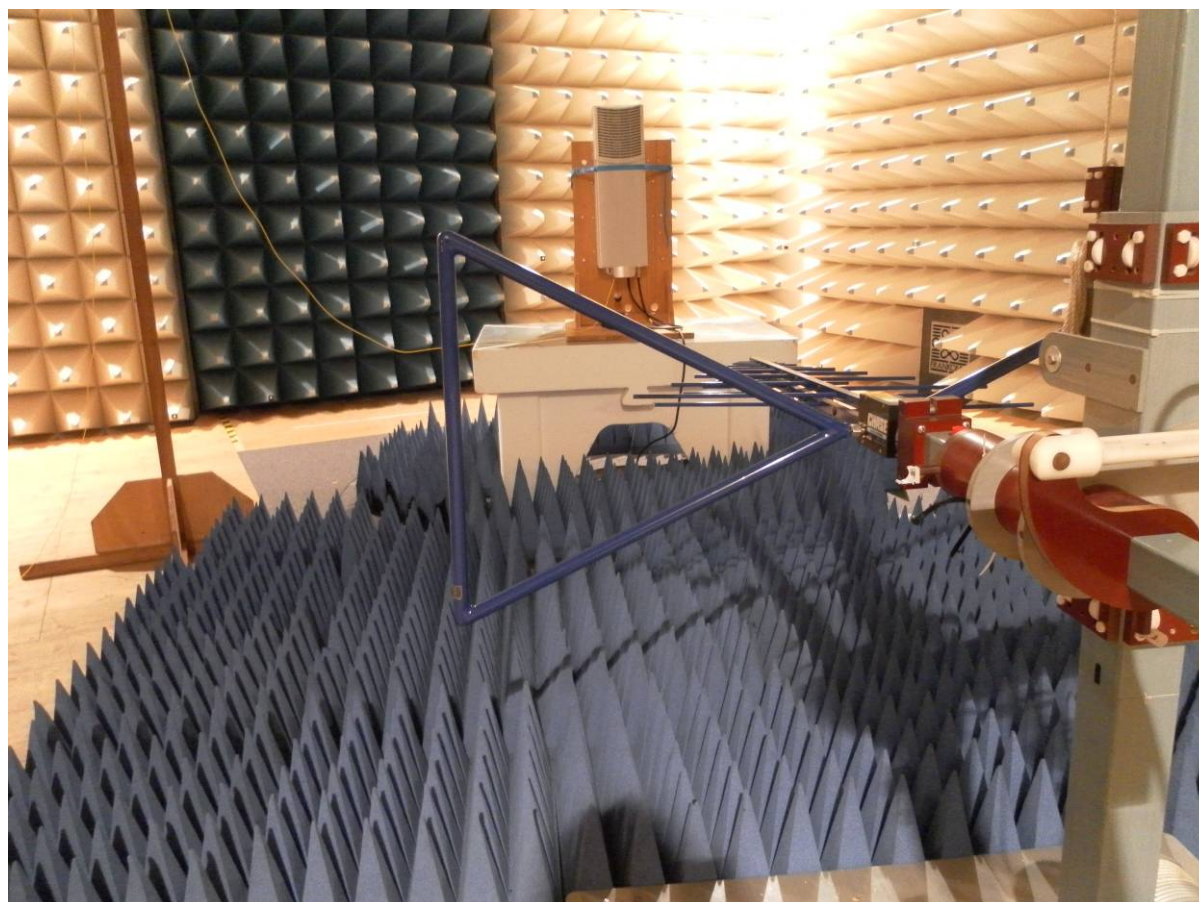

picture 8.2: Test setup: Field Strength Emission <1 GHz @3m in the FAC

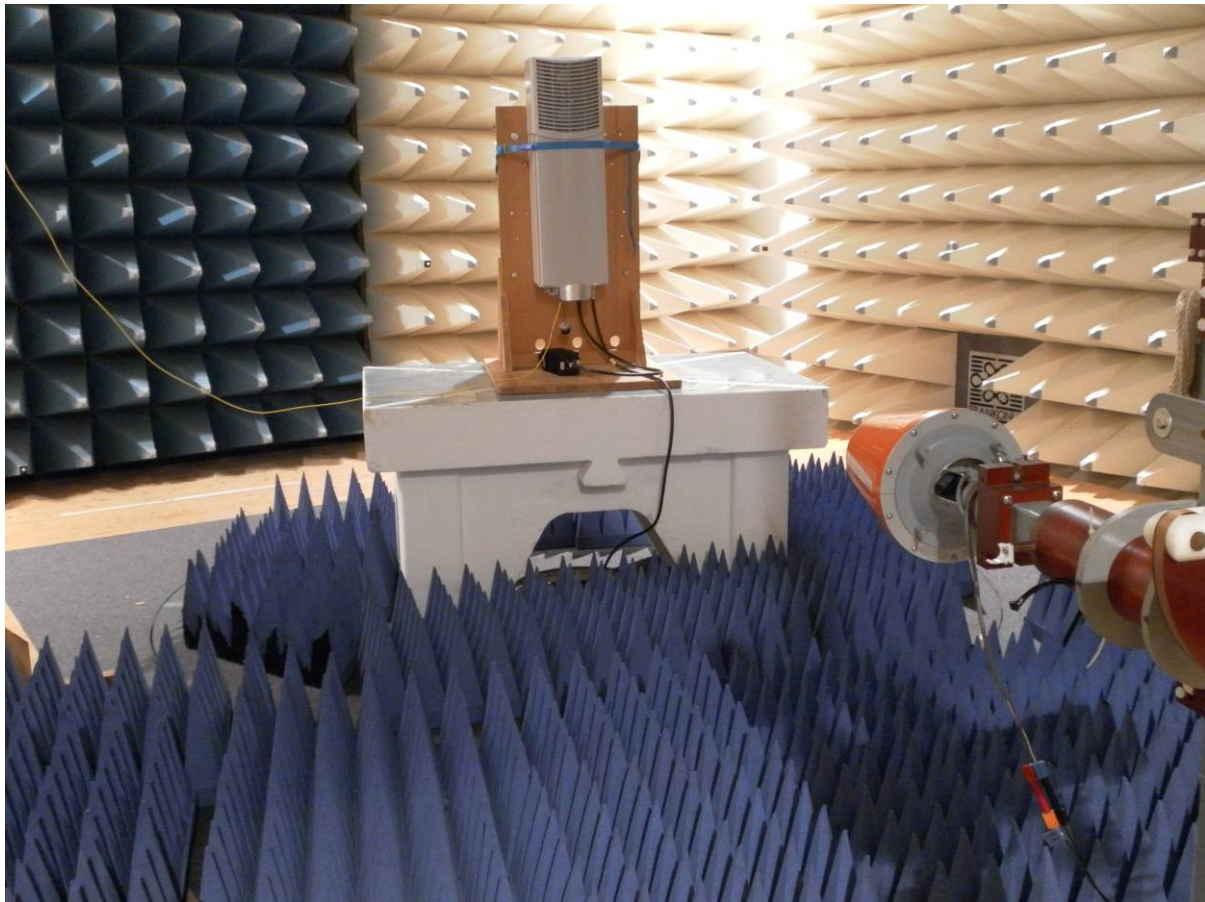

picture 8.3: Test setup: Field Strength Emission >1 GHz @3m in the FAC

Test Report No.: 11-106

FCC ID: XS5-ML78519P

IC ID: 2237E-ML78519P



This clause specifies requirements for the measurement of radiated emission.

Frequency range	Distance: EUT <-> antenna / location	Limit	Test method
30 MHz - 1 GHz	3 metres / FAC	FCC 47 CFR Part 24.238 IC RSS-133 sec. 6.5	TIA/EIA-603-C:2004
1 GHz – 22 GHz	3 metres / FAC	FCC 47 CFR Part 24.238 IC RSS-133 sec. 6.5	

Test equipment used:

Designation	Type	Manufacturer	Invent.-no.	Cal.-date	due Cal.-date	used
EMI test receiver	ESI40	Rohde & Schwarz	E1687	21.12.2010	21.12.2011	X
Antenna	CBL 6111	Chase	K1149	24.09.2010	24.09.2011	X
RF Cable		Frankonia	K1121 SET	01.07.2010	01.07.2011	X
Pre amplifier	AM1431	Miteq	K1721	02.07.2010	02.07.2011	X
Antenna	HL 025	R&S	K809	28.09.2010	28.09.2011	X
Preamplifier	AFS4-00102000	Miteq	K838	09.02.2011	09.02.2012	X
RF Cable	Sucoflex 100	Suhner	K1742	05.04.2011	05.04.2012	X

The REMI version 2.135 has been used for max search.

Test set-up:

Test location: SAC/FAC
Both, the Fully Anechoic Chamber (FAC) and the Semi Anechoic Chamber (SAC) fulfil the requirements of ANSI C63.4 and CISPR 16-1-4 with regards to NSA and SVSWR.

Test Voltage: 115V / 60 Hz

Type of EUT: Wall mounted

Measurement uncertainty:

Measurement uncertainty expanded (95% or K=2)	± 4,7 dB for ANSI C63.4 measurement ± 0,5 dB for TIA-603 measurement
--	---



8.1 Limit §24.238

The rules in this section govern the spectral characteristics of emissions in the Broadband Personal Communications Service.

(a) *Out of band emissions.* The power of any emission outside of the authorized operating frequency ranges must be attenuated below the transmitting power (P) by a factor of at least $43 + 10 \log(P)$ dB.

(b) *Measurement procedure.* Compliance with these rules is based on the use of measurement instrumentation employing a resolution bandwidth of 1 MHz or greater. However, in the 1 MHz bands immediately outside and adjacent to the frequency block a resolution bandwidth of at least one percent of the emission bandwidth of the fundamental emission of the transmitter may be employed. A narrower resolution bandwidth is permitted in all cases to improve measurement accuracy provided the measured power is integrated over the full required measurement bandwidth (i.e. 1 MHz or 1 percent of emission bandwidth, as specified). The emission bandwidth is defined as the width of the signal between two points, one below the carrier center frequency and one above the carrier center frequency, outside of which all emissions are attenuated at least 26 dB below the transmitter power.

The limit is **-13dBm** (e.i.r.p).

8.2 Test method ANSI/TIA/EA-603-C

Measurement procedure. TIA-603-C

The antenna substitution method is used to determine the equivalent radiated power at spurious frequencies. The spurious emissions are measured at a distance of 3 meters. The EUT is then replaced with a reference substitution antenna with a known gain referenced to a dipole. This antenna is fed with a signal at the spurious frequency. The level of the signal is adjusted to repeat the previously measured level. The resulting eirp is the signal level fed to the reference antenna corrected for gain referenced to an isotropic dipole (see Figure 7.2).

From KDB (AMPLIFIER, BOOSTER, AND REPEATER REMINDER SHEET):

Radiated spurs (enclosure) – Use of CW signal (low, mid. and high freq.) is acceptable rather than all modulations.

The maximum RFI field strength was determined during the measurement by rotating the turntable (± 180 degrees) and varying the height of the receive antenna ($h = 1 \dots 4$ m) as like defined in ANSI C63.4. A measurement receiver has been used with a RBW 120 kHz up to 1 GHz and 1 MHz above 1 GHz. Steps with during pre measurement was half the RBW.

Both, the Fully Anechoic Chamber (FAC) and the Semi Anechoic Chamber (SAC) fulfil the requirements of ANSI C63.4 and CISPR 16-1-4 with regards to NSA and SVSWR.

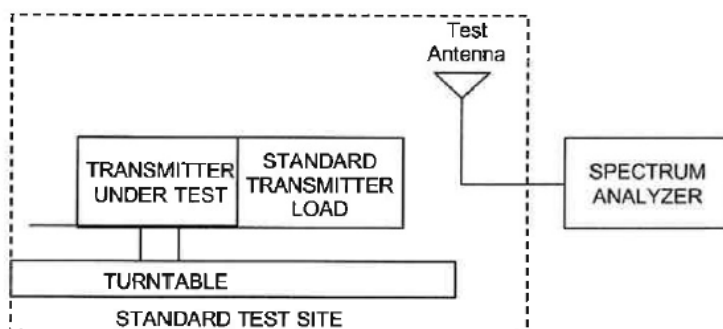

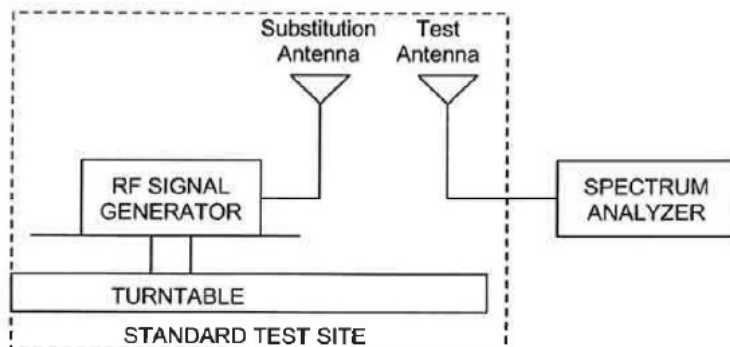

picture 8.3: Substitution method

8.3 Climatic values in the lab

Temperature: 20°
Relative Humidity: 45%
Air-pressure: 1009hPa

Test Report No.: 11-106

FCC ID: XS5-ML78519P

IC ID: 2237E-ML78519P



8.4 Test results

8.4.1 30 MHz to 1 GHz Downlink (Bottom – Middle – Top)

Bottom 1930 MHz; Middle 1962,5 MHz; Top 1995 MHz

Horizontal / Vertikal

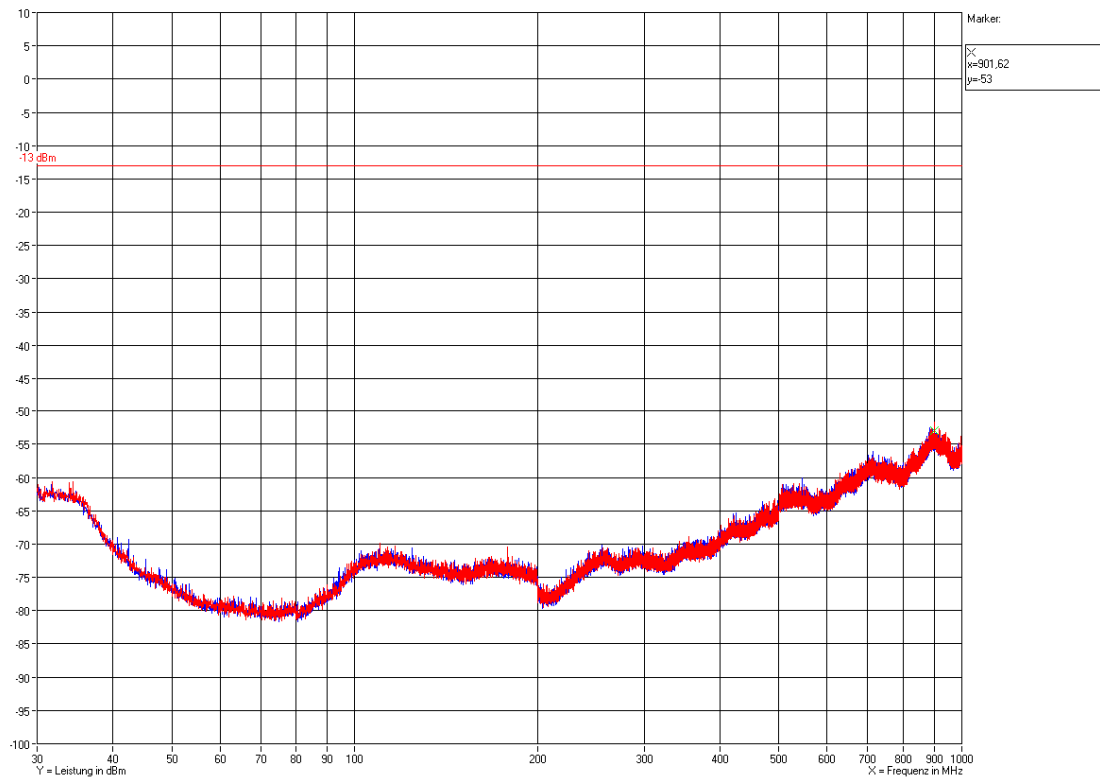



8.4.2 20 GHz -22 GHz Downlink (Bottom – Middle – Top)

Bottom 1930 MHz; Middle 1962,5 MHz; Top 1995 MHz

Horizontal / Vertikal

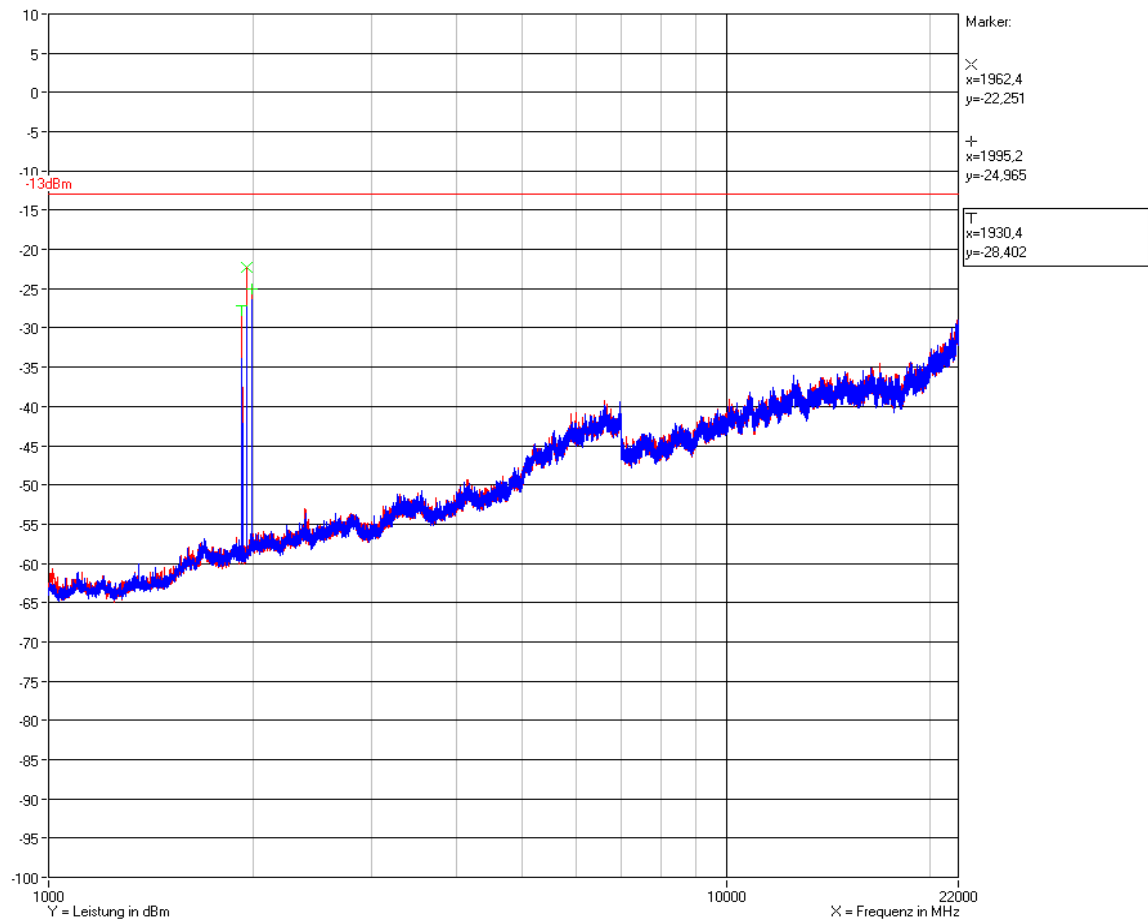

Frequenz MHz	Measurement dBuV	dBuV -> dBm	Peak dBm	Limt dBm	Marchin
1930,400	-49,2	20,8	-28,4	-13,0	15,4
1962,400	-43,2	20,9	-22,3	-13,0	9,3

There were no spurious emissions detected other than noise and the fundamental.

Test Report No.: 11-106

FCC ID: XS5-ML78519P

IC ID: 2237E-ML78519P



8.4.3 History

Revision	Modification	Date	Name
V01.00	Initial Report	26.04.2011	T. Zahlmann

******* End of test report *******