

Test Site:
FCC Test Site No.: 96997



BUREAU
VERITAS

ECL-EMC Test Report No.: 16-026

Equipment under test: ION-M7P/17EHP
700MHz path
FCC ID: XS5-M7P17EHP
Type of test: FCC 47 CFR Part 27 Subpart H, F: 2016
Miscellaneous Wireless Communication Services

Measurement Procedures: 47 CFR Parts 2: 2016 (*Frequency Allocations and Radio Treaty Matters; General Rules and Regulations*),
Part 27: 2016 (*Miscellaneous Wireless Communication Services*),
ANSI/TIA-603-C:2004, *Land Mobile FM or PM Communications Equipment Measurement and Performance Standards*

Test result: Passed

Date of issue:	09.03.16	Signature:	
Issue-No.:	01	Author:	
Date of delivery:	27.01.15	Checked:	
Test dates:	25.01.16 – 16.02.16		
Pages:	51		



Manufacturer: ANDREW Wireless Systems GmbH
Industriering 10

D-86675 Buchdorf

Tel.: +49 (0)9099 69 0

Fax: +49 (0)9099 69 140

Test Location: Bureau Veritas Consumer Products Services
Germany GmbH
European Compliance Laboratory (ECL)
Thurn-und-Taxis-Straße 18

D-90411 Nürnberg

Tel.: +49 40 74041 0

Fax: +49 40 74041-2755

General:

The purpose of this report is to show compliance to the FCC regulations for devices operating under Part 27 of the Code of Federal Regulations title 47.

This report informs about the results of the EMC tests, it only refers to the equipment under test. No part of this report may be reproduced in any form, without written permission.



Table of contents

1	TEST RESULTS SUMMARY	5
2	EQUIPMENT UNDER TEST (E.U.T.)	6
2.1	DESCRIPTION	6
2.1.1	DOWNLINK	6
2.1.2	UPLINK	6
2.1.3	DESCRIPTION OF EUT	7
2.1.4	BLOCK DIAGRAM OF MEASUREMENT REFERENCE POINTS	8
2.1.5	DOWNLINK SYSTEM GAIN AND OUTPUT POWER	8
3	TEST SITE (ANDREW BUCHDORF)	9
3.1	TEST ENVIRONMENT	9
3.2	TEST EQUIPMENT	9
3.3	INPUT AND OUTPUT LOSSES	10
3.4	MEASUREMENT UNCERTAINTY	10
4	TEST SITE (BUREAU VERITAS CONSUMER PRODUCTS SERVICES)	10
5	RF POWER OUT: §27.50, §2.1046	11
5.1	LIMIT	11
5.2	TEST METHOD	11
5.3	TEST RESULTS	12
5.3.1	DOWNLINK	12
5.3.1.1	LTE 728 – 746MHz	13
5.3.1.2	LTE 746 – 757MHz	13
5.3.2	UPLINK	14
5.4	SUMMARY TEST RESULT	14
6	OCCUPIED BANDWIDTH: §2.1049	15
6.1	LIMIT	15
6.2	TEST METHOD	15
6.3	TEST RESULTS	15
6.3.1	DOWNLINK	15
6.3.1.1	LTE 728 – 746MHz	16
6.3.1.2	LTE 746 – 757MHz	17
6.3.2	26DB BANDWIDTH	18
6.3.2.1	LTE 728 – 746MHz	18
6.3.2.2	LTE 746 – 757MHz	19
6.3.3	UPLINK	20
6.4	SUMMARY TEST RESULT	20
7	SPURIOUS EMISSIONS AT ANTENNA TERMINALS: §27.53, §2.1051	21
7.1	LIMIT	21
7.2	TEST METHOD	22
7.3	TEST RESULTS	22
7.3.1	DOWNLINK	22



7.3.1.1	LTE 728 – 746MHz.....	25
7.3.1.2	LTE 746 – 757MHz.....	26
7.3.1.3	Measurement in the band of 1559 MHz – 1610 MHz acc. to 27.53(f).....	28
7.3.2	UPLINK.....	29
7.4	SUMMARY TEST RESULT.....	29
8	INTERMODULATION: §27.53, §2.1051.....	30
8.1	LIMIT.....	30
8.2	TEST METHOD.....	31
8.3	TEST RESULTS.....	31
8.3.1	DOWNLINK.....	31
8.3.1.1	LTE 728 – 746MHz.....	32
8.3.1.2	LTE 746 – 757MHz.....	33
8.3.2	UPLINK.....	34
8.4	SUMMARY TEST RESULT.....	34
9	OUT OF BAND REJECTION.....	35
9.1	LIMIT.....	35
9.2	TEST METHOD.....	35
9.3	TEST RESULTS.....	35
9.3.1	DOWNLINK.....	36
9.3.2	UPLINK.....	36
9.4	SUMMARY TEST RESULT.....	36
10	RADIATED SPURIOUS EMISSIONS AT THE ECL (BV): §27.53, §2.1053.....	37
10.1	METHOD OF MEASUREMENT.....	40
10.2	LIMIT.....	41
10.3	RECEIVER SETTINGS.....	41
10.4	CLIMATIC VALUES IN THE LAB.....	41
10.5	TEST RESULTS.....	42
10.5.1	30 MHz TO 1 GHz DOWNLINK (BOTTOM – MIDDLE – TOP) SUBPART H.....	42
10.5.2	30 MHz TO 1 GHz DOWNLINK (BOTTOM – MIDDLE – TOP) SUBPART F.....	43
10.5.3	30 MHz TO 1 GHz DOWNLINK (MIDDLE OF ALL PATHS).....	44
10.5.4	1 GHz TO 18 GHz DOWNLINK (BOTTOM – MIDDLE – TOP) SUBPART H.....	45
10.5.5	1 GHz TO 18 GHz DOWNLINK (BOTTOM – MIDDLE – TOP) SUBPART F.....	46
10.5.6	1 GHz TO 18 GHz DOWNLINK (MIDDLE OF ALL PATHS).....	47
10.5.7	18 GHz – 26.5 GHz DOWNLINK (BOTTOM – MIDDLE – TOP).....	48
10.5.8	18 GHz – 26.5 GHz DOWNLINK (BOTTOM – MIDDLE – TOP).....	49
10.5.9	18 GHz – 26.5 GHz DOWNLINK (MIDDLE OF BOTH PATHS).....	50
11	HISTORY.....	51



1 Test Results Summary

Name of Test	FCC Para. No.	FCC Method	FCC Spec.	Result
RF Power Output	27.50(b)(c)	2.1046	1000 Watts ERP	Complies
Occupied Bandwidth	KDB 935210 D02 v03	2.1049	Input/Output	Complies
Spurious Emissions at Antenna Terminals	27.53(c)(d)(g)	2.1051	-13dBm	Complies
Radiated Spurious emission	27.53(m)	2.1053 TIA/EA-603	-13dBm E.I.R.P	Complies
Intermodulation	KDB 935210 D02 v03	KDB 935210 D03 v04	KDB 935210 D03 v04	Complies
Frequency Stability	27.54	2.1055	Must stay in band	NA
Out of Band Rejection	KDB 935210 D02 v03	KDB 935210 D03 v04	KDB 935210 D03 v04	Complies

Frequency stability is given by: The system gets an electrical analog signal from the BSS which is converted into an analog optical signal, transmitted by the optical links and then reconverted in the Remote Unit into an analog electrical signal. During this process happens no frequency change/modification, so input and output have same frequency what can be seen under clause "Occupied Bandwidth".



2 Equipment under test (E.U.T.)

2.1 Description

Kind of equipment	ION-M7P/17EHP
Andrew Ident. Number	7714392-0002
Serial no.(SN)	11
Revision	00
Software version and ID	n.a.
Type of modulation and Designator	LTE (G7D) <input checked="" type="checkbox"/>
Frequency Translation	F1-F1 <input checked="" type="checkbox"/>
	F1-F2 <input type="checkbox"/>
	N/A <input type="checkbox"/>
Band Selection	Software <input type="checkbox"/>
	Duplexer <input checked="" type="checkbox"/>
	Full band <input type="checkbox"/>

2.1.1 Downlink

Pass band	Path 728 MHz – 757 MHz
Pass band under test	Path 728 MHz – 746 MHz
	Path 746 MHz – 757 MHz
Max. composite output power based on one carrier per path (rated)	43.0 dBm = 20 W
System Gain*	10 dB @ Pout BTS of 33 dBm

*see 2.1.5

2.1.2 Uplink

Pass band	Path 698 MHz – 716 MHz, 776 MHz - 787MHz
Maximum rated output power	n. a.
System Gain*	n. a.

*see 2.1.5

Note: The EUT does not transmit over the air in the uplink direction.



2.1.3 Description of EUT

CommScope's ION-M7P/17EHP a multi-band, multi-operator Remote Unit. It is used in conjunction with a Master Unit in the ION optical distribution system. This system transports up to 2 frequency bands simultaneously, providing a cost-effective solution for distributing capacity from one or more base stations.

This Test Report describes only the approval of the 700 MHz Path.

The ION-M7P/17EHP Repeater system consists of one 1700/2100 MHz path and one 700 MHz path with the intended use of simultaneous transmission.

The antenna(s) used with device must be fixed-mounted on permanent structures.



2.1.4 Block diagram of measurement reference points

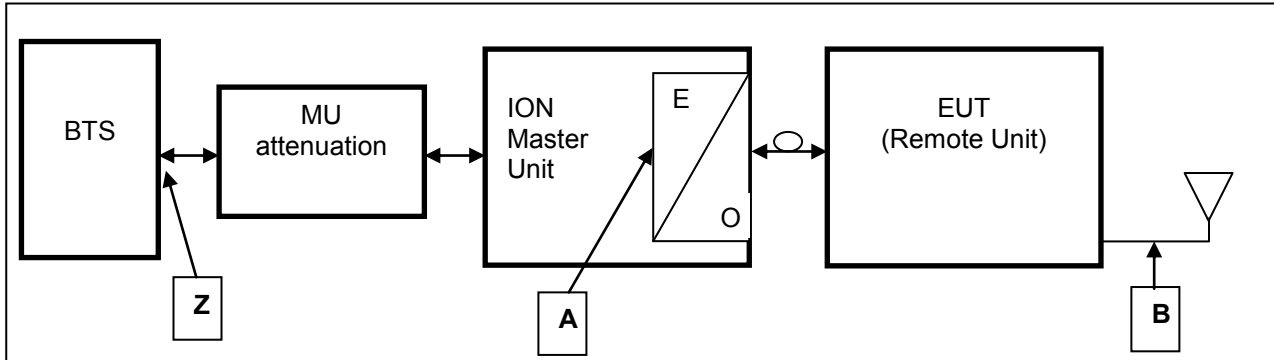

figure 2.1.4-#1 Block diagram of measurement reference points

Remote Unit (RU) is the EUT

O/E Optical/Electrical converter
 MU Master Unit

Reference point A MU UL output, DL input
 Reference point B Remote Unit DL output, UL input
 Reference point Z BTS DL output, UL input

Since a signal generator does not supply a good output signal with +33 or +43dBm, for the downlink measurement the MU Attenuation is not used. That means for downlink measurements the signal generator is connected to measurement point A at the master optical / electrical converter and the analyzer to the measurement point B at the RU.

2.1.5 Downlink System Gain and Output Power

System optimized for BTS power (fixed value) Z	MU Attenuation (manual leveling)	Maximum rated input power at the MU OTRX (fixed value) A	RU Gain (fixed value) A to B	Maximum rated output power at RU Antenna port (fixed value) B
+33 dBm	30 dB	3 dBm	+40 dB	+43.0 dBm @ 1 carrier
System Gain Z to B	+10 dB			
+43 dBm	40 dB	3 dBm	+40 dB	+43.0 dBm @ 1 carrier
System Gain Z to B	+0 dB			

table 2.1.5-#1 Equipment under test (E.U.T.) Description Downlink System Gain and Output Power



3 Test site (Andrew Buchdorf)

3.1 Test environment

All tests were performed under the following environmental conditions:

Condition	Minimum value	Maximum value
Barometric pressure	86 kPa	106 kPa
Temperature	15°C	30°C
Relative Humidity	20 %	75 %
Power supply range	±5% of rated voltages	

3.2 Test equipment

ANDREW Inv. No.	Test equipment	Type	Manufacturer	Serial No.	Calibration
9295	Network Analyzer	ZNB20	R&S	101540	11/16
9291	Spectrum Analyzer	FSV30	R&S	103090	06/16
9233	Signal Generator	SMBV100A	R&S	257777	06/16
8849	Signal Generator	SMU200A	R&S	101732	04/16
8671	Power Meter	E4418B	Agilent	GB39513094	06/16
8672	Power Sensor	E9300H	Agilent	US41090179	06/16
7321	Circulator	E10-1FFF	AEROTEK	25350	CIU
7326	Circulator	E10-1FFF	AEROTEK	25360	CIU
7408	RF-Cable	2,0m; N-N	Andrew	---	CIU
7409	RF-Cable	2,0m; N-N	Andrew	---	CIU
7410	RF-Cable	1,0m; N-N	Andrew	---	CIU
7411	RF-Cable	2,0m; N-N	Andrew	---	CIU
7373	RF-Cable	Multiflex141	Andrew	---	CIU
7374	RF-Cable	Multiflex141	Andrew	---	CIU
7437	RF-Cable	Multiflex141	Andrew	---	CIU
7438	RF-Cable	Multiflex141	Andrew	---	CIU
7439	RF-Cable	Multiflex141	Andrew	---	CIU
7443	RF-Cable	Multiflex141	Andrew	---	CIU
7444	RF-Cable	Multiflex141	Andrew	---	CIU
7445	RF-Cable	Multiflex141	Andrew	---	CIU
7446	RF-Cable	Multiflex141	Andrew	---	CIU
7447	RF-Cable	Multiflex141	Andrew	---	CIU
7448	RF-Cable	Multiflex141	Andrew	---	CIU
7449	RF-Cable	Multiflex141	Andrew	---	CIU
7450	RF-Cable	Multiflex141	Andrew	---	CIU
7440	RF-Cable	RG-223 0.8m	Andrew	---	CIU
7441	RF-Cable	RG-223 0.8m	Andrew	---	CIU
7453	RF-Cable	RG223 2m SMA.	Andrew	---	CIU
7454	RF-Cable	RG223 2m SMA.	Andrew	---	CIU
7455	RF-Cable	RG223 2m SMA.	Andrew	---	CIU
7144	Attenuator	2N-20dB	Inmet 64671	---	CIU
7341	Power Attenuator	768-20	Narda	---	CIU
7368	Matrix		COMMSCOPE	---	weekly

CIU = Calibrate in use



3.3 Input and output losses

All recorded power levels should be referenced to the input and output connectors of the repeater, unless explicitly stated otherwise.

The test equipment used in this test has to be calibrated, so that the functionality is also checked.

All cables, attenuators, splitter, isolator, circulator and combiner etc. must be measured before testing and used for compensation during testing.

3.4 Measurement uncertainty

The extended measurement uncertainty corresponds to the measurement results from the standard measurement uncertainty multiplied by the coverage factor $k=2$. The true value is located in the corresponding interval with a probability of 95 %.

4 Test site (Bureau Veritas Consumer Products Services)

FCC Test site: 96997

See relevant dates under section 10 of this test report.



5 RF Power Out: §27.50, §2.1046

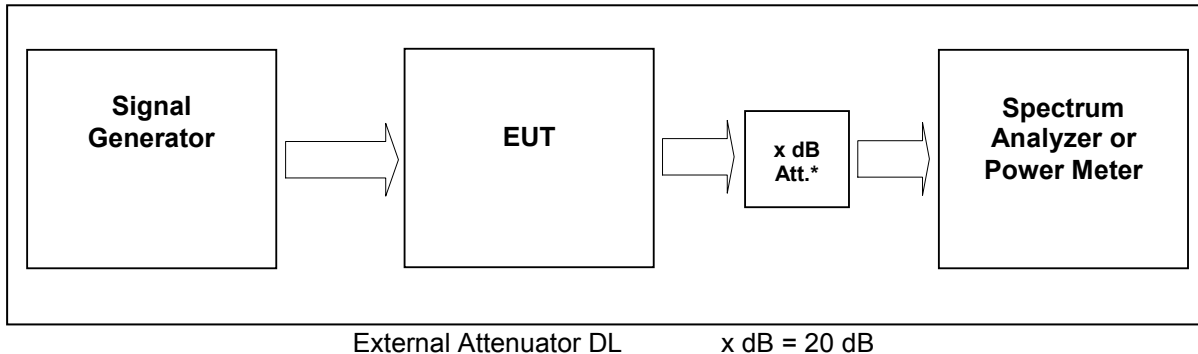

figure 5-#1 Test setup: RF Power Out: §27.50, §2.1046

Measurement uncertainty	± 0,38 dB
Test equipment used	9291, 9233, 7444; 7321; 7144; 7454; 7453; 7341; 7449; 7368

5.1 Limit

Minimum standard:

Para. No.27.50(b)(4) and (c)(1) and (c) (3)

(b) The following power and antenna height limits apply to transmitters operating in the 746–763 MHz, 775–793 MHz and 805–806 MHz bands:

(4) Fixed and base stations transmitting a signal in the 746–757 MHz, 758–763 MHz, 776–787 MHz, and 788–793 MHz bands with an emission bandwidth greater than 1 MHz must not exceed an ERP of 1000 watts/MHz and an antenna height of 305 m HAAT, except that antenna heights greater than 305 m HAAT are permitted if power levels are reduced below 1000 watts/MHz ERP accordance with Table 3 of this section.

(c) The following power and antenna height requirements apply to stations transmitting in the 698–746 MHz band:

(1) Fixed and base stations transmitting a signal with an emission bandwidth of 1 MHz or less must not exceed an effective radiated power (ERP) of 1000 watts and an antenna height of 305 m height above average terrain (HAAT), except that antenna heights greater than 305 m HAAT are permitted if power levels are reduced below 1000 watts ERP in accordance with Table 1 of this section;

(3) Fixed and base stations transmitting a signal with an emission bandwidth greater than 1 MHz must not exceed an ERP of 1000 watts/MHz and an antenna height of 305 m HAAT, except that antenna heights greater than 305 m HAAT are permitted if power levels are reduced below 1000 watts/MHz ERP in accordance with Table 3 of this section;

5.2 Test method

§ 2.1046 Measurements required: RF power output.

(a) For transmitters other than single sideband, independent sideband and controlled carrier radiotelephone, power output shall be measured at the RF output terminals when the transmitter is adjusted in accordance with the tune-up procedure to give the values of current and voltage on the circuit elements specified in § 2.1033(c)(8). The electrical characteristics of the radio frequency load attached to the output terminals when this test is made shall be stated.



(c) For measurements conducted pursuant to paragraphs (a) and (b) of this section, all calculations and methods used by the applicant for determining carrier power or peak envelope power, as appropriate, on the basis of measured power in the radio frequency load attached to the transmitter output terminals shall be shown. Under the test conditions specified, no components of the emission spectrum shall exceed the limits specified in the applicable rule parts as necessary for meeting occupied bandwidth or emission limitations

5.3 Test Results

Detector RMS.

Test signal LTE:

Signal waveform according to Test Model 1.1, E-TM1.1, clause 6.1.1.1-1, table 6.1.1.1-1 of standard specification 3GPP TS 36.141 V9.3.0 (2010-03).

5.3.1 Downlink

Modulation	Measured at	Path	RBW VBW Span	RF Power (dBm)	RF Power (W)	Plot -
LTE	Middle	737 MHz (Band 12 (Band Class 19))	3MHz 10MHz 50MHz	43.0	20	5.3.1.1 #1
LTE	Middle	751,5 MHz (Band 13 (Band Class 7))	3MHz 10MHz 50MHz	43.0	20	5.3.1.2 #1
Maximum output power = 43.0 dBm = 20 W						
Limit Maximum output power (erp) = 1000 W						

table 5.3.1-#1 RF Power Out: §27.50, §2.1046 Test Results Downlink

The max RF Power out is 43 dBm, so the maximum antenna gain (x) can be calculated as follow:

Limit = 1000W (erp) = 60 dBm

Info: 1000W (erp) = 1640W (eirp)

$60 \text{ dBm} > 43 \text{ dBm} + x \rightarrow x = 60 \text{ dBm} - 43 \text{ dBm} = 17 \text{ dBd}$

$x \text{ dBi} = 17 \text{ dBd} + 2.15 = 19.15 \text{ dBi}$

=> The antenna that will be used for the complete system have to have a gain lower than 19.15 dBi, relative to a dipol.

Modulation	Pin / dBm (Ref. point A)
LTE (Band 12 (Band Class 19))	2.0
LTE (Band 13 (Band Class 7))	1.4

table 5.3.1-#2 RF Power Out: §27.50, §2.1046 Test Results Downlink Input power



5.3.1.1 LTE 728 – 746MHz

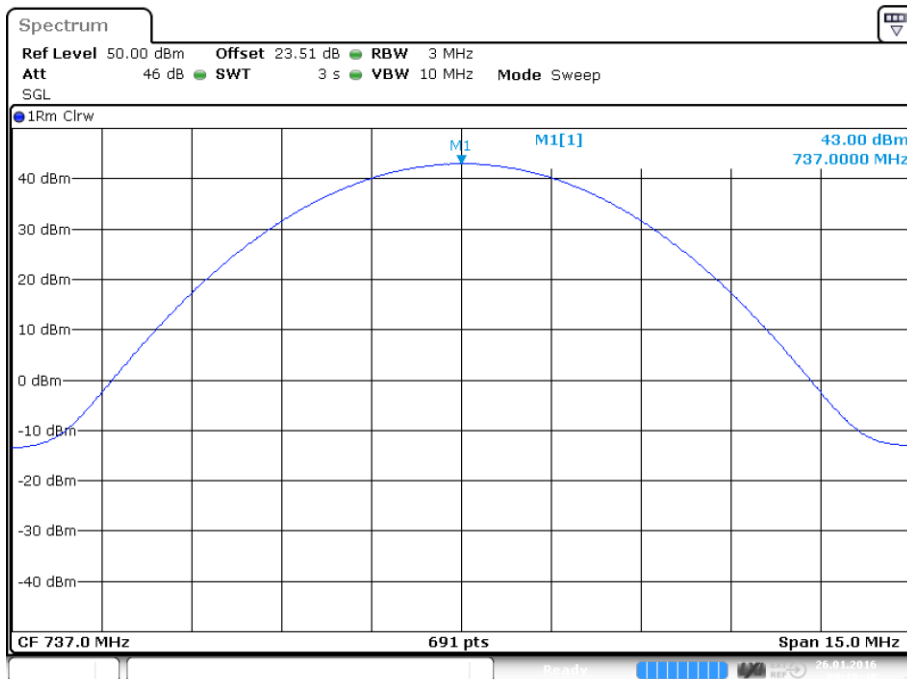

Date: 26.JAN.2016 09:18:48

plot 5.3.1.1-#1 RF Power Out: §27.50, §2.1046; Downlink; LTE 728 – 746MHz Middle

5.3.1.2 LTE 746 – 757MHz

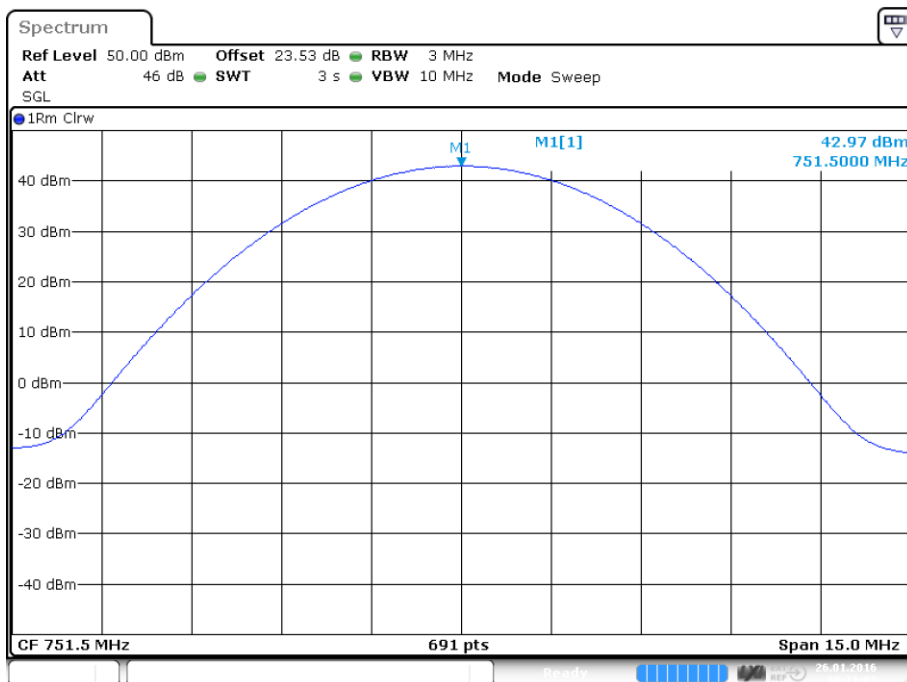

Date: 26.JAN.2016 09:21:03

plot 5.3.1.2-#1 RF Power Out: §27.50, §2.1046; Downlink; LTE 746 – 757MHz Middle



5.3.2 Uplink

n.a.

Note: The EUT does not transmit over the air in the uplink direction.

5.4 Summary test result

Test result	complies, according the plots above
Tested by:	M. Leinfelder
Date:	26.01.2016



6 Occupied Bandwidth: §2.1049

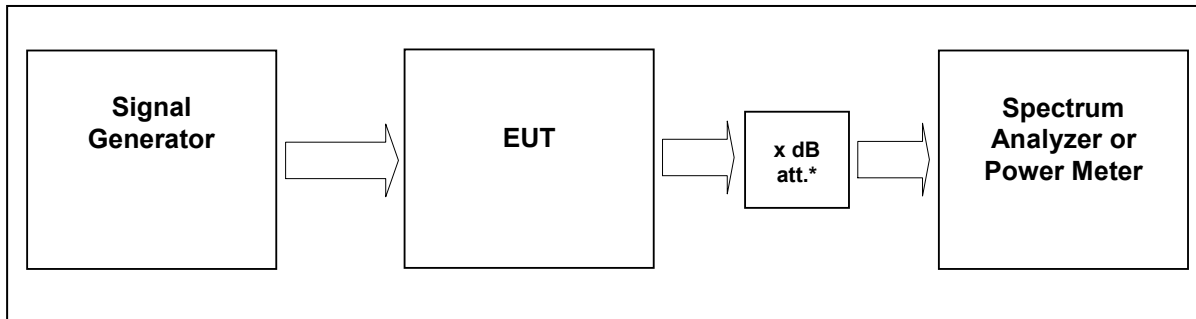

External Attenuator DL x dB = 20 dB
figure 6-#1 Test setup: Occupied Bandwidth: §2.1049

Measurement uncertainty	± 0,38 dB
Test equipment used	9291, 9233, 7444; 7321; 7144; 7454; 7453; 7341; 7449; 7368

6.1 Limit

The spectral shape of the output should look similar to input for all modulations.

6.2 Test method

Para. No.2.1049

The occupied bandwidth, that is the frequency bandwidth such that, below its lower and above its upper frequency limits, the mean powers radiated are each equal to 0.5 percent of the total mean power radiated by a given emission shall be measured under the following conditions as applicable:

6.3 Test results

6.3.1 Downlink

Detector PK.

Modulation	Measured at	Path	RBW VBW Span	Occupied Bandwidth / MHz	Plot #
LTE	Middle	737 MHz Band 12 (Band Class 19)	30 kHz 300 kHz 5 MHz	1.05	6.3.1.1 #1, #2
LTE	Middle	751,5 MHz Band 13 (Band Class 7)	30 kHz 300 kHz 5 MHz	1.05	6.3.1.2 #1, #2



Modulation	Measured at	Path	RBW VBW Span	26dB Bandwidth / MHz	Plot #
LTE	Middle	737 MHz Band 12 (Band Class 19)	30 kHz 300 kHz 5 MHz	1.316	6.3.2.1 #1, #2
LTE	Middle	751,5 MHz Band 13 (Band Class 7)	30 kHz 300 kHz 5 MHz	1.301	6.3.2.2 #1, #2

table 6.3-#1 Occupied Bandwidth: §2.1049 Test results

6.3.1.1 LTE 728 – 746MHz

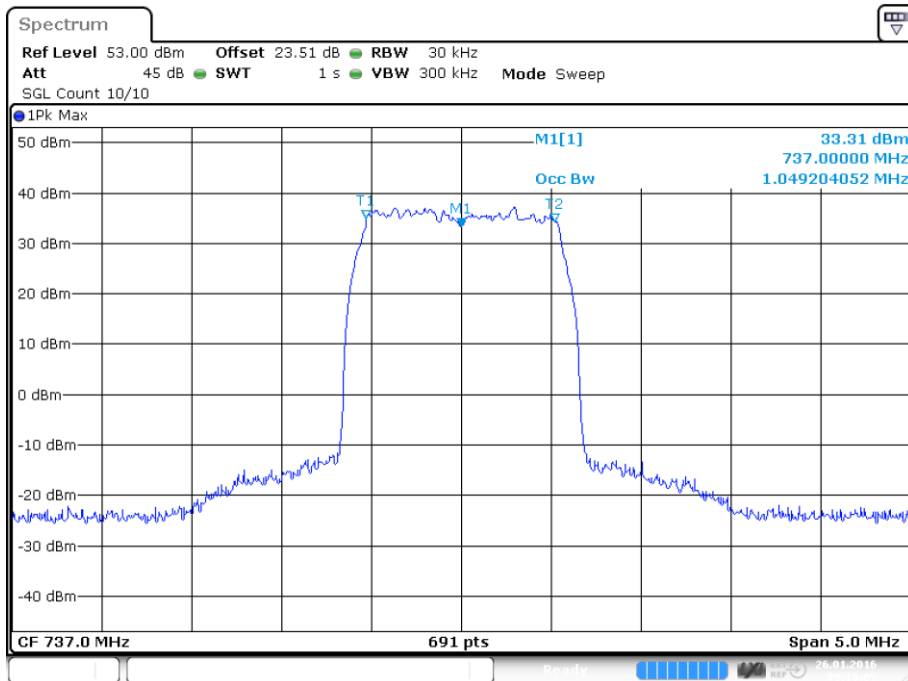

Date: 26.JAN.2016 09:19:05

plot 6.3.1.1-#1 Occupied Bandwidth: §2.1049; Test results; Downlink; LTE 728 – 746MHz Output

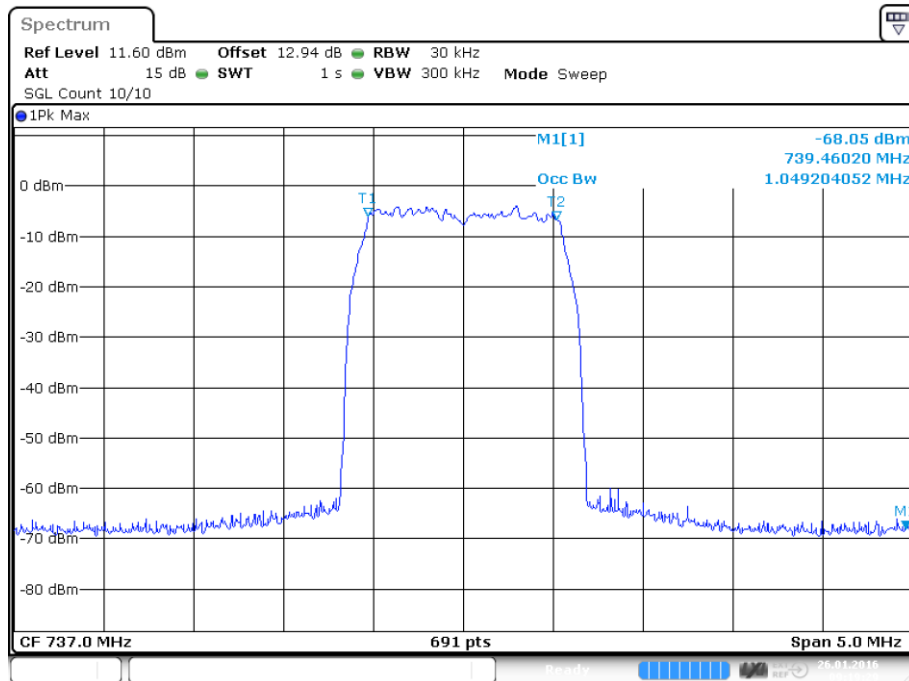

Date: 26.JAN.2016 09:19:29

plot 6.3.1.1-#2 Occupied Bandwidth: \$2.1049; Test results; Downlink; LTE 728 – 746MHz Input

6.3.1.2 LTE 746 – 757MHz

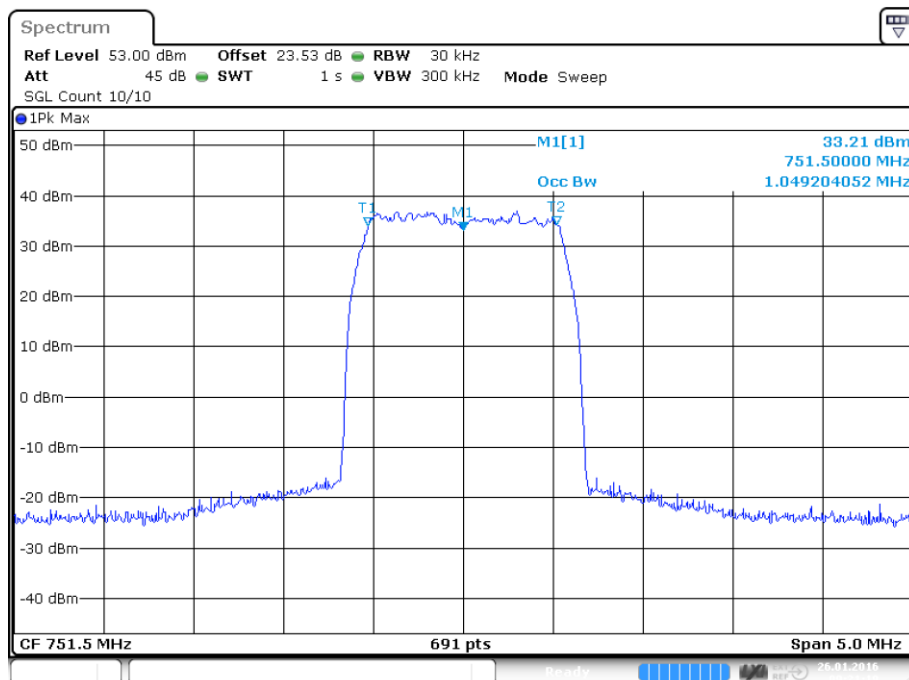

Date: 26.JAN.2016 09:21:19

plot 6.3.1.2-#1 Occupied Bandwidth: \$2.1049; Test results; Downlink; LTE 746 – 757MHz Output

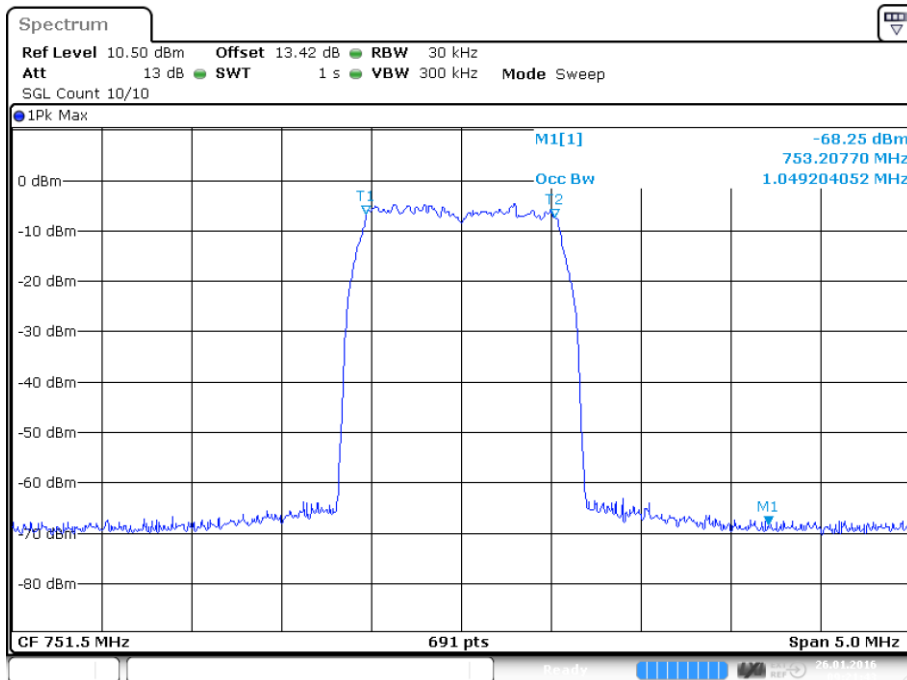

Date: 26.JAN.2016 09:21:43

plot 6.3.1.2-#2 Occupied Bandwidth: \$2.1049; Test results; Downlink; LTE 746 – 757MHz Input

6.3.2 26dB Bandwidth

6.3.2.1 LTE 728 – 746MHz

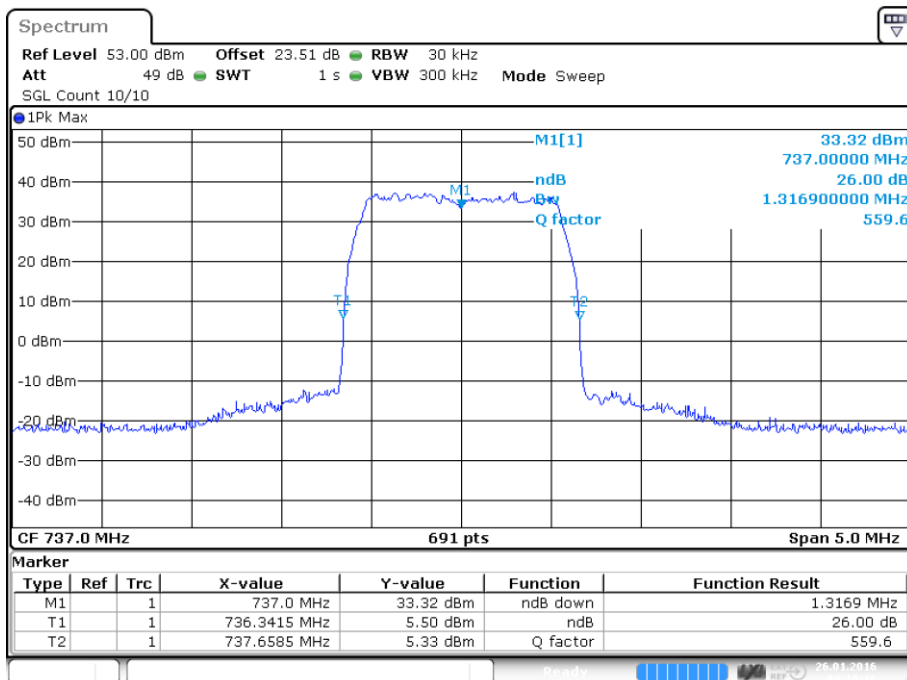

Date: 26.JAN.2016 09:19:16

plot 6.3.2.1-#1 Occupied Bandwidth: \$2.1049; Test results; 26dB Bandwidth; LTE 728 – 746MHz Output

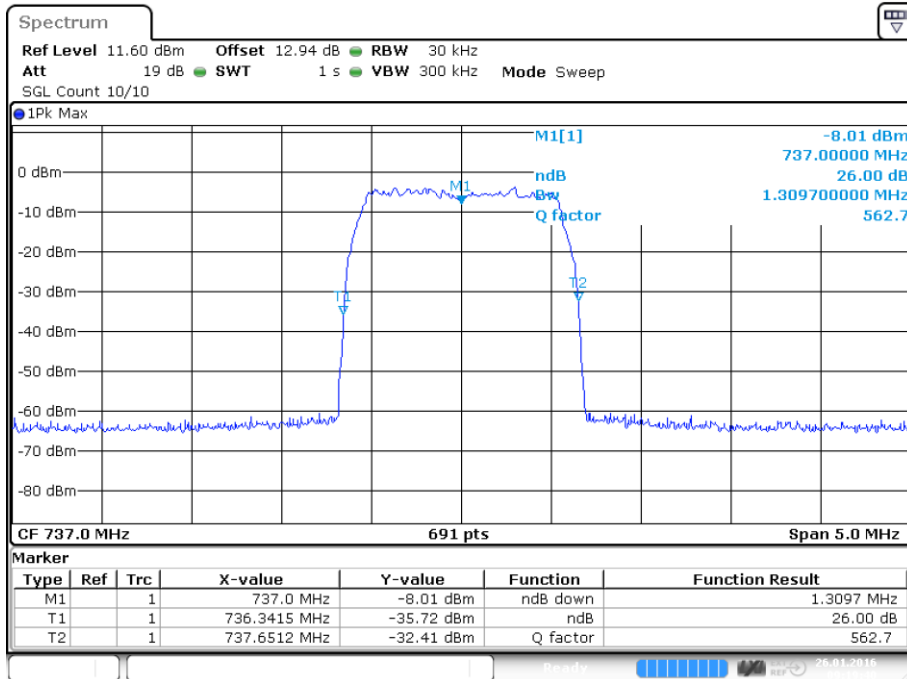

Date: 26.JAN.2016 09:19:40

plot 6.3.2.1-#2 Occupied Bandwidth: §2.1049; Test results; 26dB Bandwidth; LTE 728 – 746MHz Input

6.3.2.2 LTE 746 – 757MHz

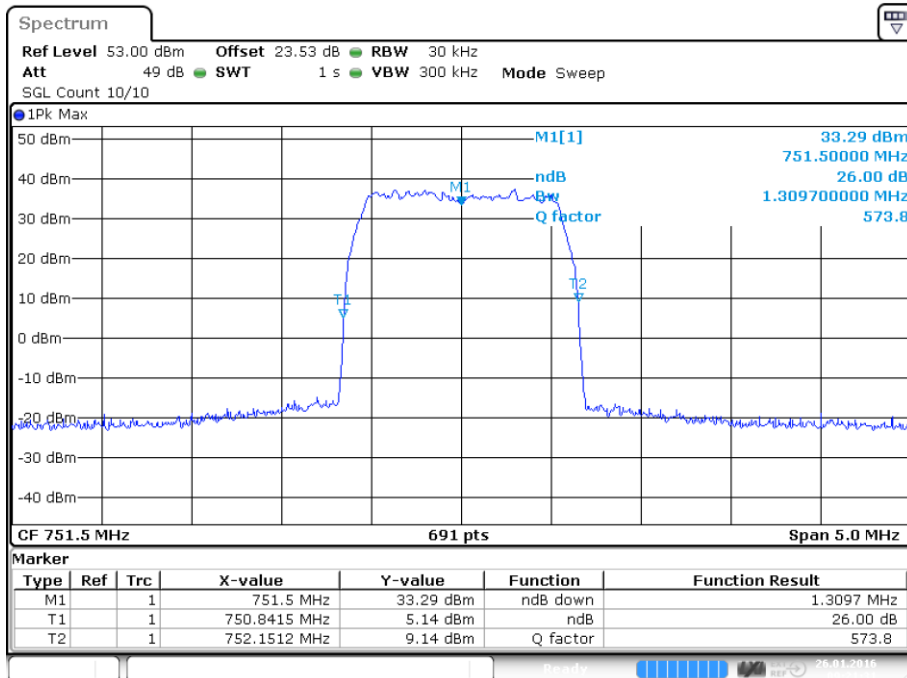

Date: 26.JAN.2016 09:21:31

plot 6.3.2.2-#1 Occupied Bandwidth: §2.1049; Test results; 26dB Bandwidth; LTE 746 – 757MHz Output

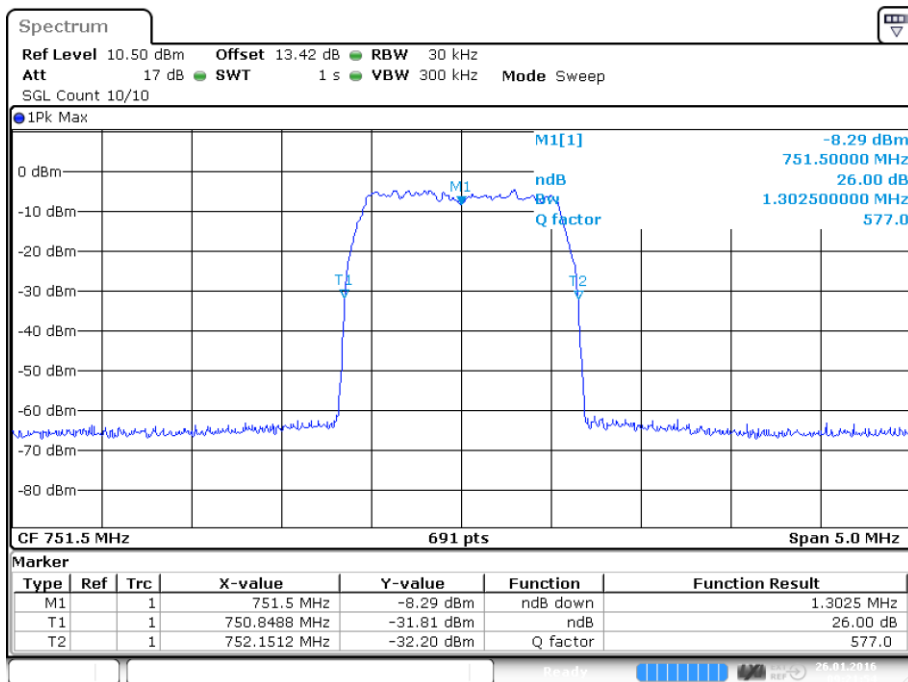

Date: 26.JAN.2016 09:21:54

plot 6.3.2.2-#2 Occupied Bandwidth: \$2.1049; Test results; 26dB Bandwidth; LTE 746 – 757MHz Input

6.3.3 Uplink

n.a.

Note: The EUT does not transmit over the air in the uplink direction.

6.4 Summary test result

Test result	complies, according the plots above
Tested by:	M. Leinfelder
Date:	26.01.2016



7 Spurious Emissions at Antenna Terminals: §27.53, §2.1051

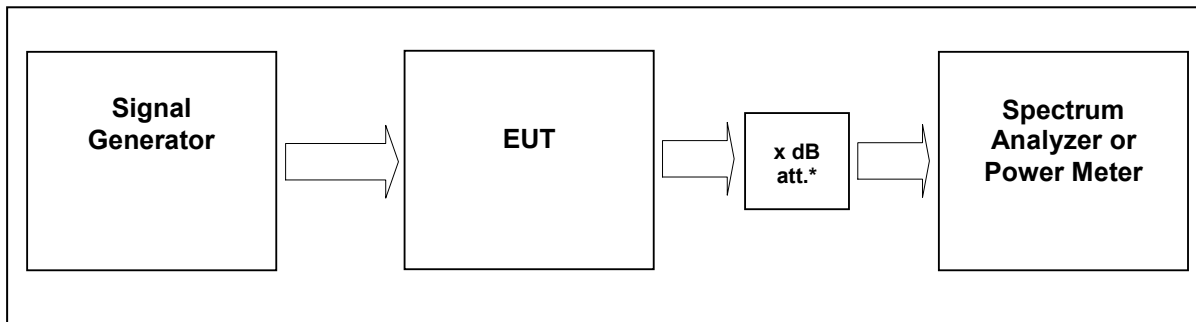

External Attenuator DL x dB = 20 dB

figure 7-#1 Test setup: Spurious Emissions at Antenna Terminals: §27.53, §2.1051

Measurement uncertainty	± 0,54 dB ± 1,2 dB ± 1,5 dB	9 kHz to 3 GHz 3 GHz to 7 GHz 7 GHz to 26 GHz
Test equipment used	9291, 9233, 7444; 7321; 7144; 7454; 7453; 7341; 7449; 7368	

7.1 Limit

Minimum standard:

Para. No.27.53 (c), (f) and (g)

(c) For operations in the 746–758 MHz band and the 776–788 MHz band, the power of any emission outside the licensee's frequency band(s) of operation shall be attenuated below the transmitter power (P) within the licensed band(s) of operation, measured in watts, in accordance with the following:

(1) On any frequency outside the 746–758 MHz band, the power of any emission shall be attenuated outside the band below the transmitter power (P) by at least $43 + 10 \log (P)$ dB;

(3) On all frequencies between 763–775 MHz and 793–805 MHz, by a factor not less than $76 + 10 \log (P)$ dB in a 6.25 kHz band segment, for base and fixed stations;

(f) For operations in the 746–763 MHz, 775–793 MHz, and 805–806 MHz bands, emissions in the band 1559–1610 MHz shall be limited to -70 dBW/MHz equivalent isotropically radiated power (EIRP) for wideband signals, and -80 dBW EIRP for discrete emissions of less than 700 Hz bandwidth. For the purpose of equipment authorization, a transmitter shall be tested with an antenna that is representative of the type that will be used with the equipment in normal operation.

(g) For operations in the 698–746 MHz band, the power of any emission outside a licensee's frequency band(s) of operation shall be attenuated below the transmitter power (P) within the licensed band(s) of operation, measured in watts, by at least $43 + 10 \log (P)$ dB. Compliance with this provision is based on the use of measurement instrumentation employing a resolution bandwidth of 100 kilohertz or greater. However, in the 100 kilohertz bands immediately outside and adjacent to a licensee's frequency block, a resolution bandwidth of at least 30 kHz may be employed



7.2 Test method

Para. No 2.1051 Measurements required: Spurious emissions at antenna terminals.

The radio frequency voltage or powers generated within the equipment and appearing on a spurious frequency shall be checked at the equipment output terminals when properly loaded with a suitable artificial antenna. Curves or equivalent data shall show the magnitude of each harmonic and other spurious emission that can be detected when the equipment is operated under the conditions specified in § 2.1049 as appropriate. The magnitude of spurious emissions which are attenuated more than 20 dB below the permissible value need not be specified.

[39 FR 5919, Feb. 15, 1974. Redesignated and amended at 63 FR 36599, July 7, 1998]

7.3 Test results

7.3.1 Downlink

Detector: RMS.

Modulation	Carrier	RBW VBW Span	Max. level (dBm)	Plot -
LTE Band 12 (Band Class 19)	737 MHz	1MHz 3MHz 30MHz – 8GHz	-31.3	7.3.1.1 #1
LTE Band 13 (Band Class 7)	751.5 MHz	1MHz 3MHz 30MHz – 8GHz	-30.4	7.3.1.2 #1

table 7.3-#1 Spurious Emissions at Antenna Terminals: §27.53, §2.1051 Test results



Calculation of the limit according to §27.53 (c)(3):

On all frequencies between 763–775 MHz and 793–805 MHz, by a factor not less than $76 + 10 \log (P)$ dB in a 6.25 kHz band segment, for base and fixed stations;

$P_{out} = 43 \text{ dBm} = 20 \text{ W}$.

$76 + 10 \cdot \log(20\text{W}/1\text{W}) \text{ dB} = 89 \text{ dB Attenuation} \Rightarrow 43\text{dBm} - 89\text{dB} = -46 \text{ dBm}$ in a 6.25 kHz band segment
Spurious measured in the plot with a RBW of 1MHz so the limit is calculated:

$\Rightarrow -46\text{dBm} / 6,25\text{kHz} + 10 \cdot \log(1\text{MHz}/6,25\text{kHz}) = -23,96\text{dBm} / 1\text{MHz}$
(in the frequency range 763–775 MHz and 793–805 MHz)

maximum measured emission level for frequencies between 763–775 MHz and 793–805 MHz is below -30 dBm / 1MHz.

Test passed.

Plots with test result see

plot 7.3.1.3 #2

plot 7.3.1.3 #3

plot 7.3.1.4 #2

plot 7.3.1.4 #3

Considerations to §27.53 (f):

To see if the standard 27.53(f) were met a calculation of the radiated power is necessary. The modulated carrier in the range of 747-757 MHz is working with maximum power and the frequency range of 1559-1610MHz is measured. For the calculation of the radiated power in this band, it was calculated with a typical antenna gain and typical cable loss.

Used 700 MHz narrow band antennas offer a gain of 0 dBi in the in the frequency range 1559 - 1610 MHz, furthermore an antenna cable with a loss of 2 dB is used.

The measured conducted emissions in the frequency range of 1599 - 1610 MHz are below -48.7 dBm/MHz (see at plot 7.3.1.3).

Conducted emissions (<-48.7 dBm) + antenna gain (0 dBi) - cable loss (0 dB) = radiated emissions (<-48.7 dBm) which is below the limit of Part 27.53(f).

Even with an antenna gain of 2 dBi (more than worst case) in the frequency range of 1599 - 1610 MHz, we are still under the limit of Part 27.53(f) with a radiated emission of -46.7 dBm.

Therefore the emission limit is met.

Test passed.

Plots with test result see

7.3.1.3

Test Report No.: 16-026

FCC ID: XS5-M7P17EHP



**BUREAU
VERITAS**

Measurement in the band of 1559 MHz – 1610 MHz



7.3.1.1 LTE 728 – 746MHz

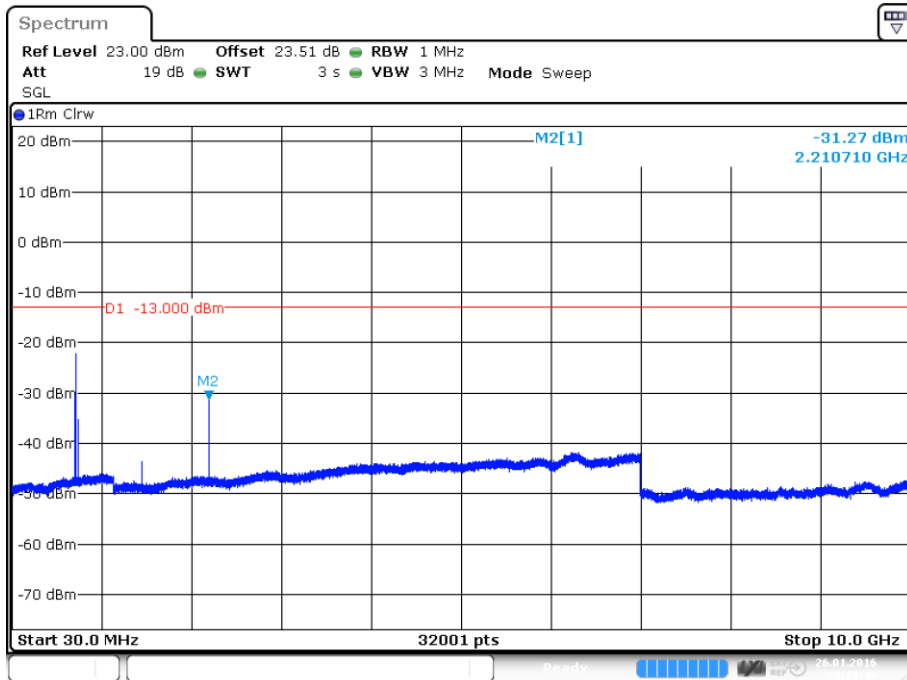

Date: 26.JAN.2016 09:19:47

plot 7.3.1.1-#1 Spurious Emissions at Antenna Terminals: §27.53, §2.1051; Test results; Downlink; LTE 728 – 746MHz; 30 MHz – 10 GHz; carrier (737MHz) notched

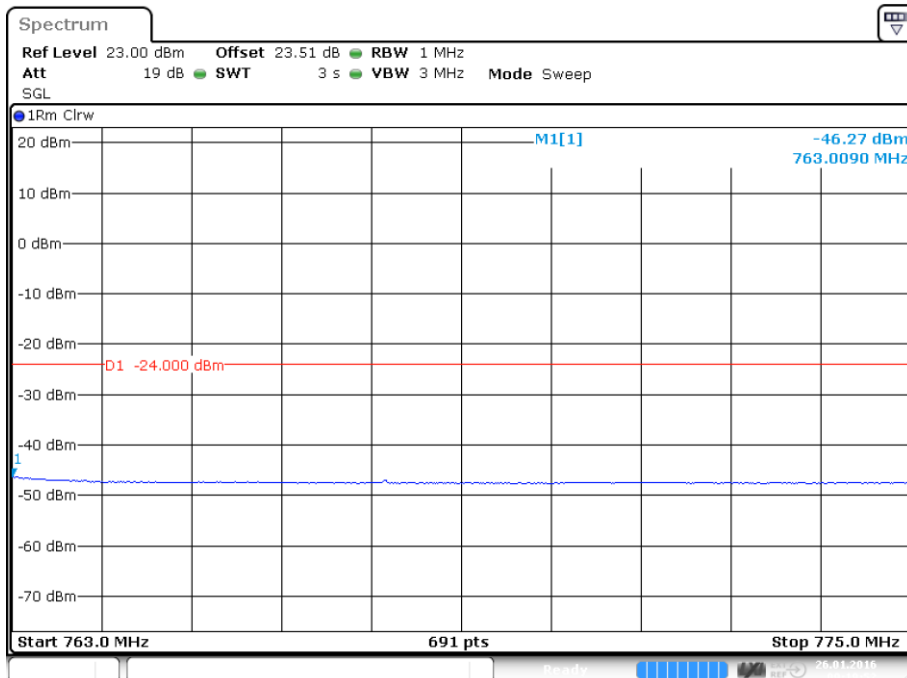

Date: 26.JAN.2016 09:19:52

plot 7.3.1.1-#2 Spurious Emissions at Antenna Terminals: §27.53, §2.1051; Test results; Downlink; LTE 728 – 746MHz; 763 MHz – 775 MHz

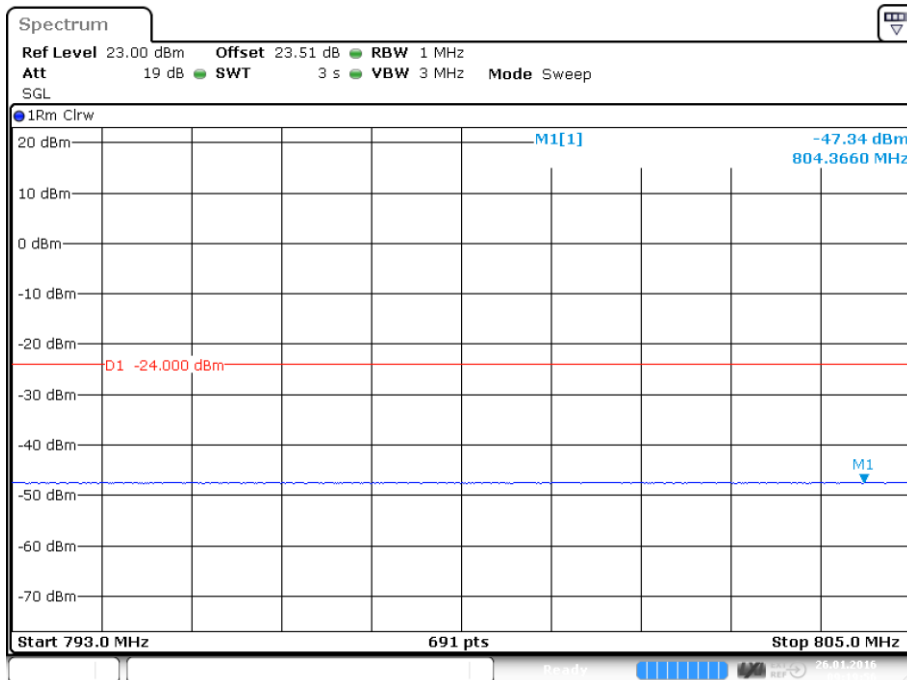

Date: 26.JAN.2016 09:19:56

plot 7.3.1.1-#3 Spurious Emissions at Antenna Terminals: §27.53, §2.1051; Test results; Downlink; LTE 728 – 746MHz; 793 MHz – 805 MHz

7.3.1.2 LTE 746 – 757MHz

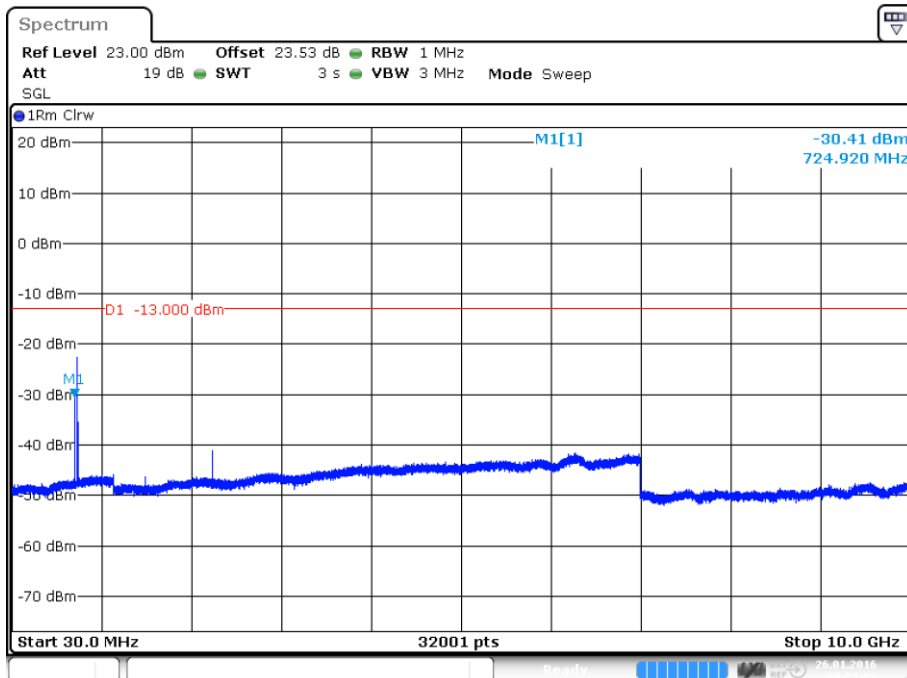

Date: 26.JAN.2016 09:22:01

plot 7.3.1.2-#1 Spurious Emissions at Antenna Terminals: §27.53, §2.1051; Test results; Downlink; LTE 746 – 757MHz; 30 MHz – 10 GHz; carrier (751,5MHz) notched

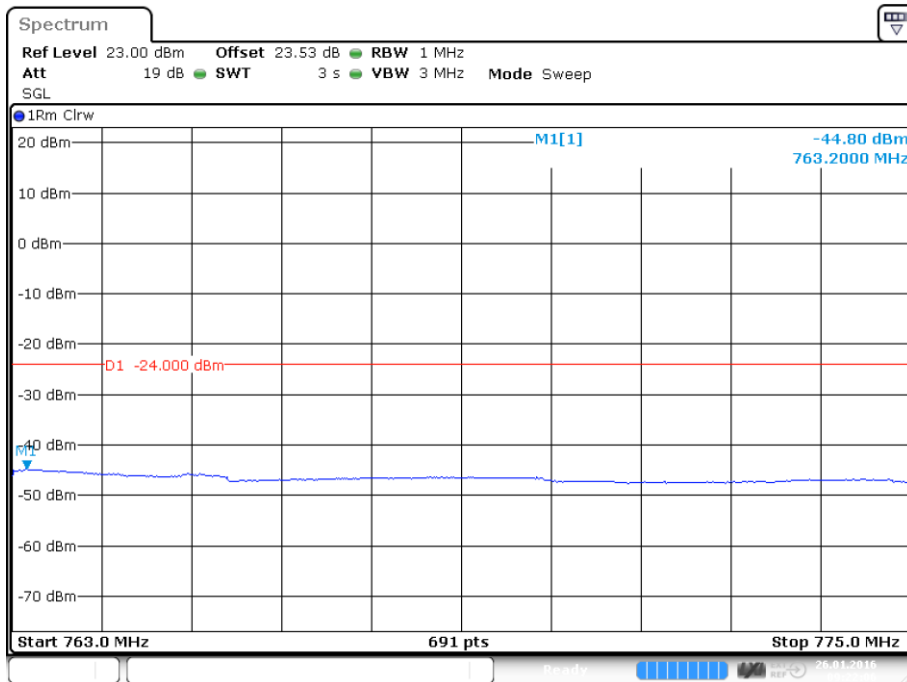

Date: 26.JAN.2016 09:22:06

plot 7.3.1.2-#2 Spurious Emissions at Antenna Terminals: §27.53, §2.1051; Test results; Downlink; LTE 746 – 757MHz; 763 MHz – 775 MHz

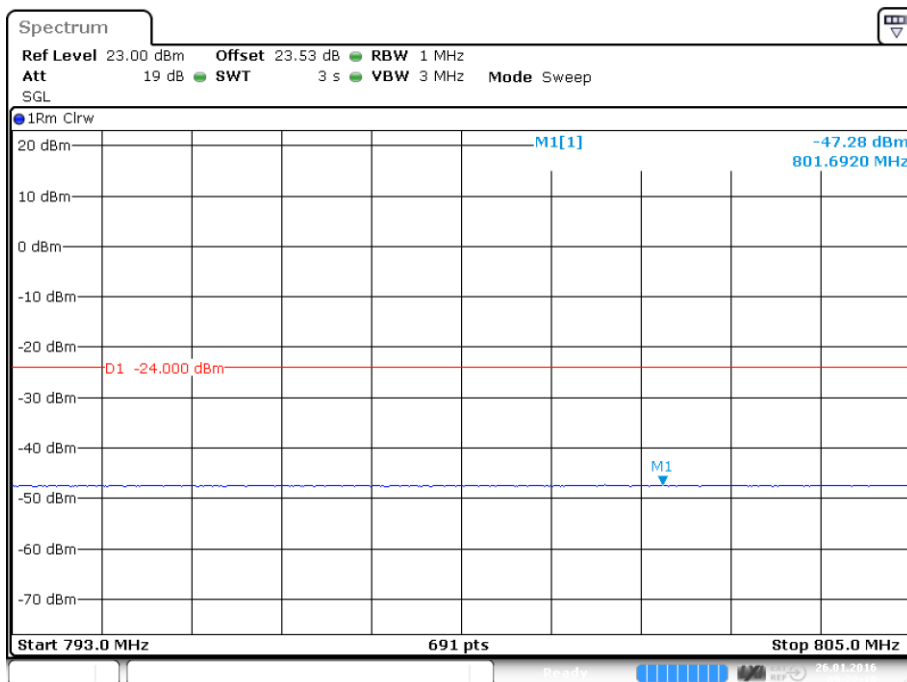

Date: 26.JAN.2016 09:22:10

plot 7.3.1.2-#3 Spurious Emissions at Antenna Terminals: §27.53, §2.1051; Test results; Downlink; LTE 746 – 757MHz; 793 MHz – 805 MHz



7.3.1.3 Measurement in the band of 1559 MHz – 1610 MHz acc. to 27.53(f)

Calculation see 7.3.1 Test results Downlink

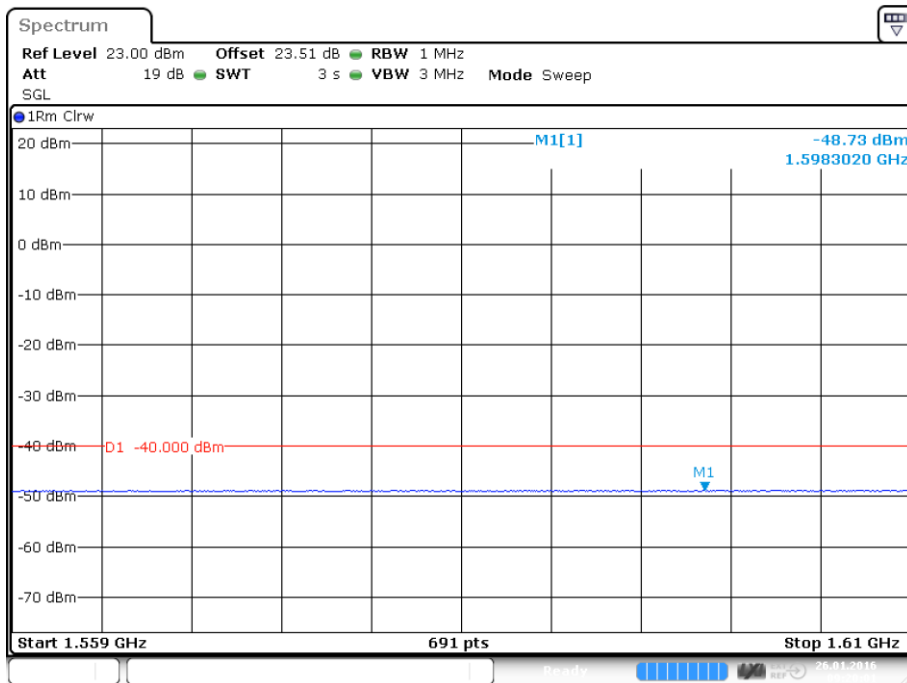

Date: 26.JAN.2016 09:20:01

plot 7.3.1.3-#1 Spurious Emissions at Antenna Terminals: §27.53, §2.1051; Test results; Downlink; Measurement in the band of 1559 MHz – 1610 MHz acc. to 27.53(f); LTE band 12

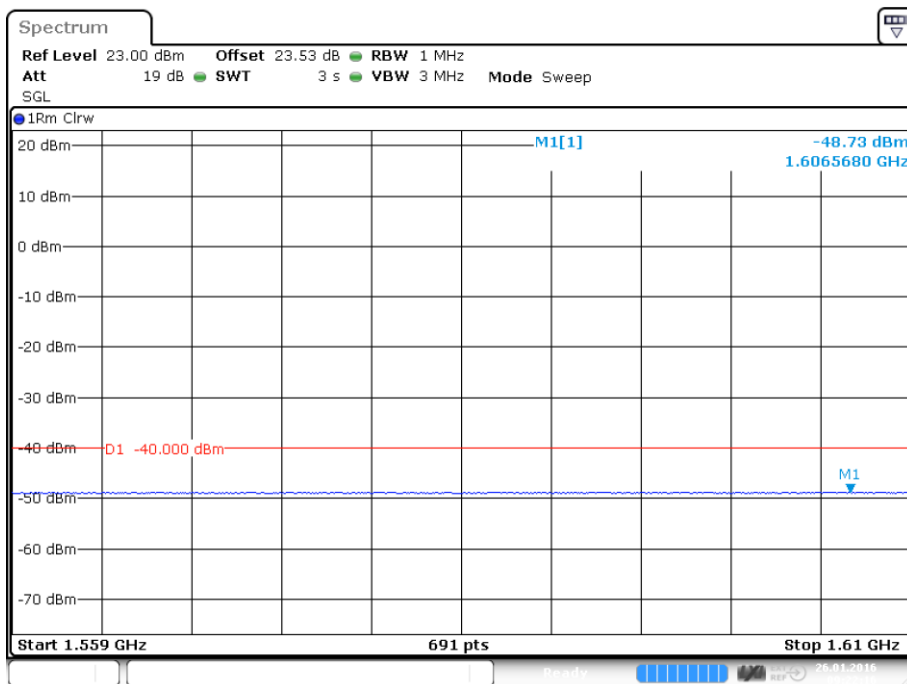

Date: 26.JAN.2016 09:22:15

plot 7.3.1.3-#2 Spurious Emissions at Antenna Terminals: §27.53, §2.1051; Test results; Downlink; Measurement in the band of 1559 MHz – 1610 MHz acc. to 27.53(f); LTE band 13



7.3.2 Uplink

n.a.

Note: The EUT does not transmit over the air in the uplink direction.

7.4 Summary test result

Test result	complies, according the plots above
Tested by:	M. Leinfelder
Date:	26.01.2016

8 Intermodulation: §27.53, §2.1051

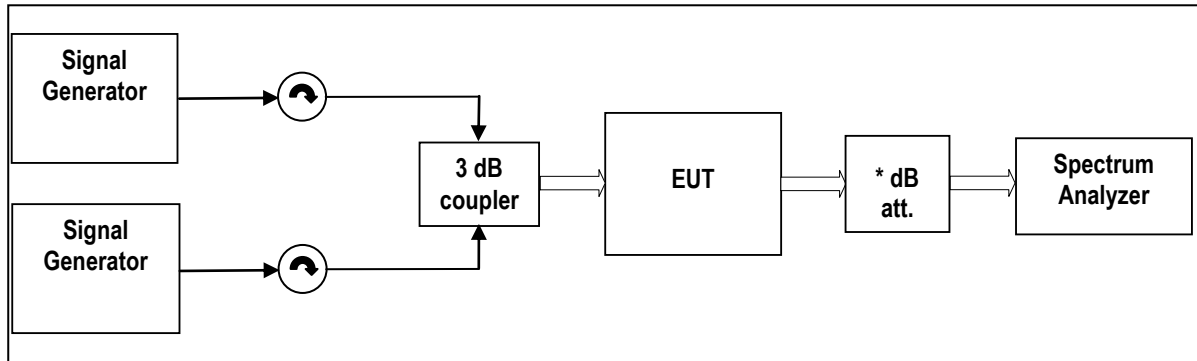

External Attenuator DL x dB = 20 dB
figure 8-#1 Test setup: Intermodulation: §27.53, §2.1051

Measurement uncertainty	± 0,54 dB ± 1,2 dB ± 1,5 dB	9 kHz to 3 GHz 3 GHz to 7 GHz 7 GHz to 26 GHz
Test equipment used	9291, 8849; 9233, 7444; 7321; 7326; 7144; 7454; 7453; 7341; 7449; 7368	

8.1 Limit

Minimum standard:

Para. No.27.53 (c), (f) and (g)

(c) For operations in the 746–758 MHz band and the 776–788 MHz band, the power of any emission outside the licensee's frequency band(s) of operation shall be attenuated below the transmitter power (P) within the licensed band(s) of operation, measured in watts, in accordance with the following:

(1) On any frequency outside the 746–758 MHz band, the power of any emission shall be attenuated outside the band below the transmitter power (P) by at least $43 + 10 \log (P)$ dB;

(3) On all frequencies between 763–775 MHz and 793–805 MHz, by a factor not less than $76 + 10 \log (P)$ dB in a 6.25 kHz band segment, for base and fixed stations;

(f) For operations in the 746–763 MHz, 775–793 MHz, and 805–806 MHz bands, emissions in the band 1559–1610 MHz shall be limited to -70 dBW/MHz equivalent isotropically radiated power (EIRP) for wideband signals, and -80 dBW EIRP for discrete emissions of less than 700 Hz bandwidth. For the purpose of equipment authorization, a transmitter shall be tested with an antenna that is representative of the type that will be used with the equipment in normal operation.

(g) For operations in the 698–746 MHz band, the power of any emission outside a licensee's frequency band(s) of operation shall be attenuated below the transmitter power (P) within the licensed band(s) of operation, measured in watts, by at least $43 + 10 \log (P)$ dB. Compliance with this provision is based on the use of measurement instrumentation employing a resolution bandwidth of 100 kilohertz or greater. However, in the 100 kilohertz bands immediately outside and adjacent to a licensee's frequency block, a resolution bandwidth of at least 30 kHz may be employed



8.2 Test method

Para. No 2.1051 Measurements required: Spurious emissions at antenna terminals.

The radio frequency voltage or powers generated within the equipment and appearing on a spurious frequency shall be checked at the equipment output terminals when properly loaded with a suitable artificial antenna. Curves or equivalent data shall show the magnitude of each harmonic and other spurious emission that can be detected when the equipment is operated under the conditions specified in § 2.1049 as appropriate. The magnitude of spurious emissions which are attenuated more than 20 dB below the permissible value need not be specified.

[39 FR 5919, Feb. 15, 1974. Redesignated and amended at 63 FR 36599, July 7, 1998]

8.3 Test results

8.3.1 Downlink

Detector: RMS.

Modulation	Measured at Band Edge	Carriers	RBW VBW Span	Max. level (dBm)	Plot -
LTE Band 12 (Band Class 19)	Lower Edge	728,7 MHz 730,1 MHz	30kHz 300kHz 6MHz	-24.9	8.3.1.1 #1
	Upper Edge	743,9 MHz 745,3 MHz			#2
LTE Band 13 (Band Class 7)	Lower Edge	746,7 MHz 748,1 MHz	30kHz 300kHz 6MHz	-26.4	8.3.1.2 #1
	Upper Edge	754,9 MHz 756,3 MHz			#2

table 8.3-#1 Intermodulation: §27.53, §2.1051 Test results



8.3.1.1 LTE 728 – 746MHz

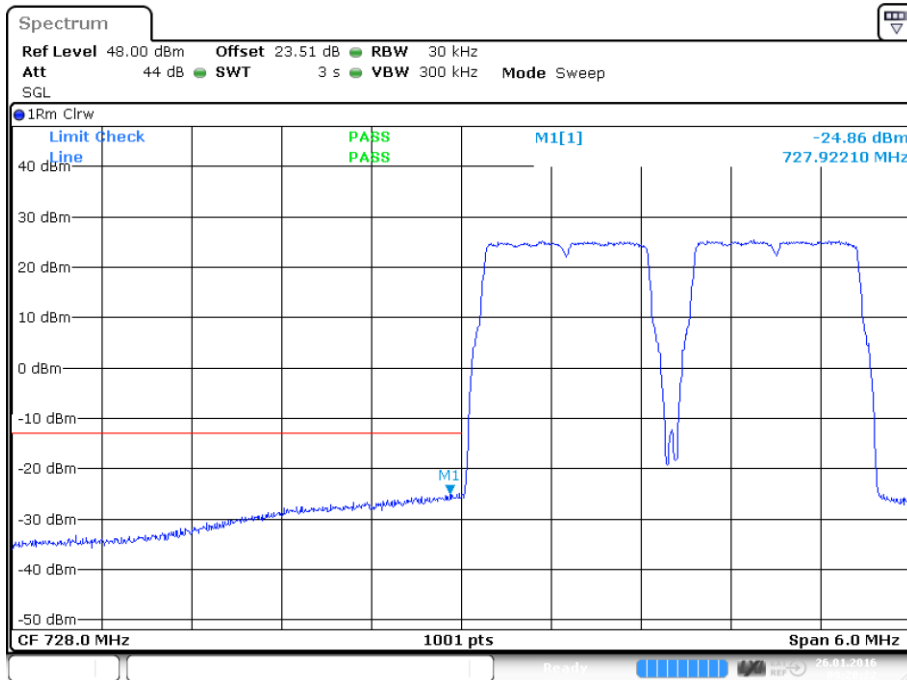

Date: 26 JAN.2016 09:20:23

plot 8.3.1.1-#1 Intermodulation: §27.53, §2.1051; Test results; Downlink; LTE 728 – 746MHz Lower Band Edge

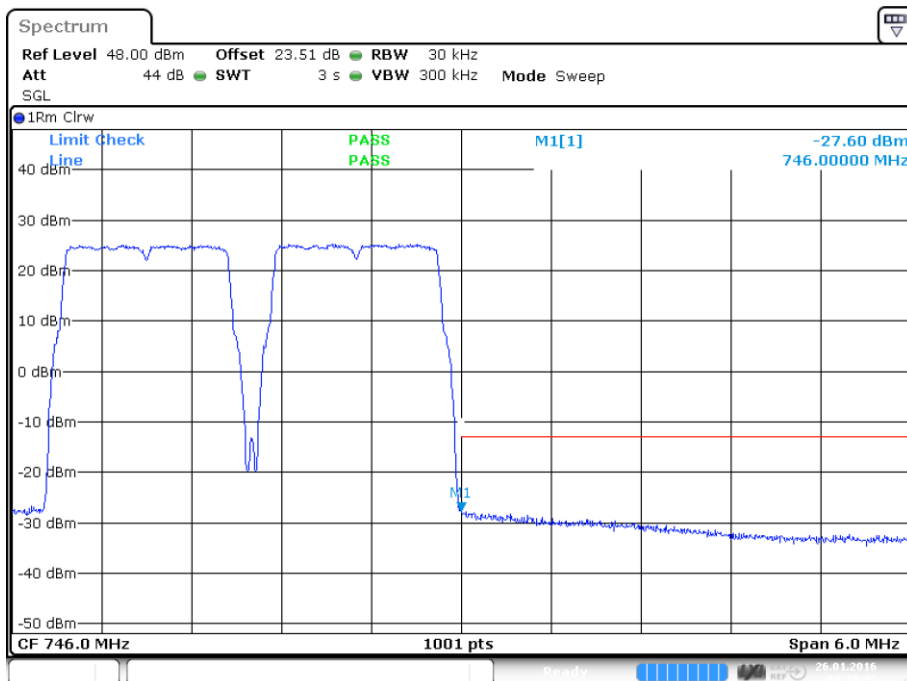

Date: 26 JAN.2016 09:20:33

plot 8.3.1.1-#2 Intermodulation: §27.53, §2.1051; Test results; Downlink; LTE 728 – 746MHz Upper Band Edge



8.3.1.2 LTE 746 – 757MHz

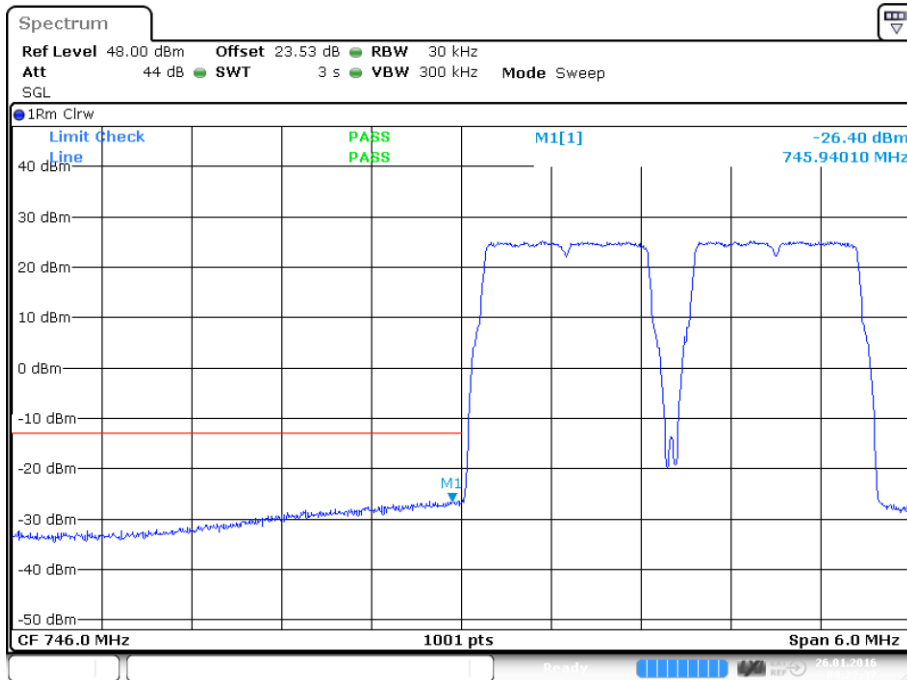

plot 8.3.1.2-#1 Intermodulation: §27.53, §2.1051; Test results; Downlink; LTE 746 – 757MHz Lower Band Edge

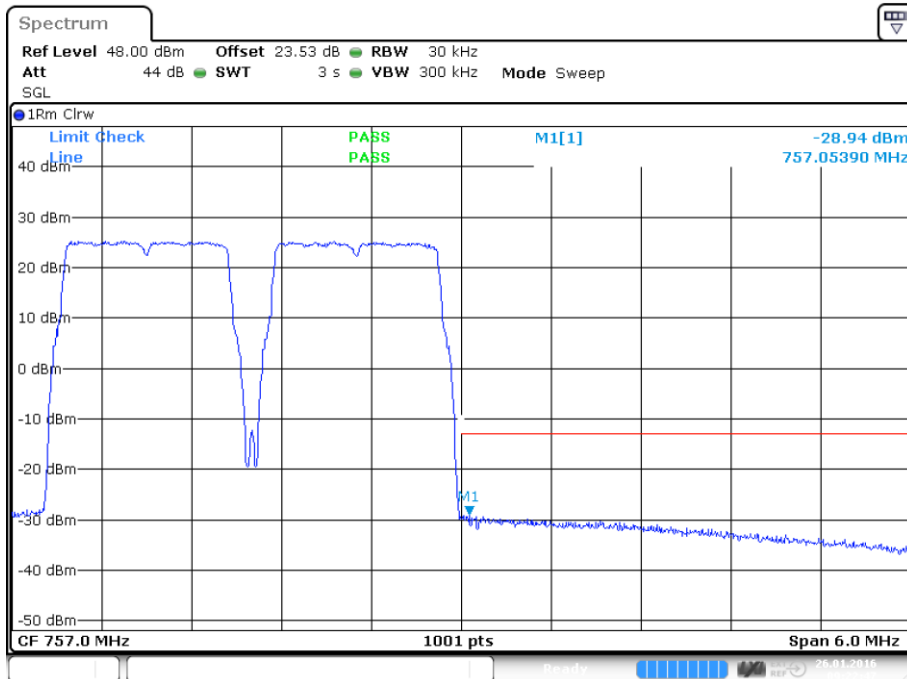

plot 8.3.1.2-#2 Intermodulation: §27.53, §2.1051; Test results; Downlink; LTE 746 – 757MHz Upper Band Edge



8.3.2 Uplink

n.a.

Note: The EUT does not transmit over the air in the uplink direction.

8.4 Summary test result

Test result	complies, according the plots above
Tested by:	M. Leinfelder
Date:	26.01.2016

9 Out of Band Rejection

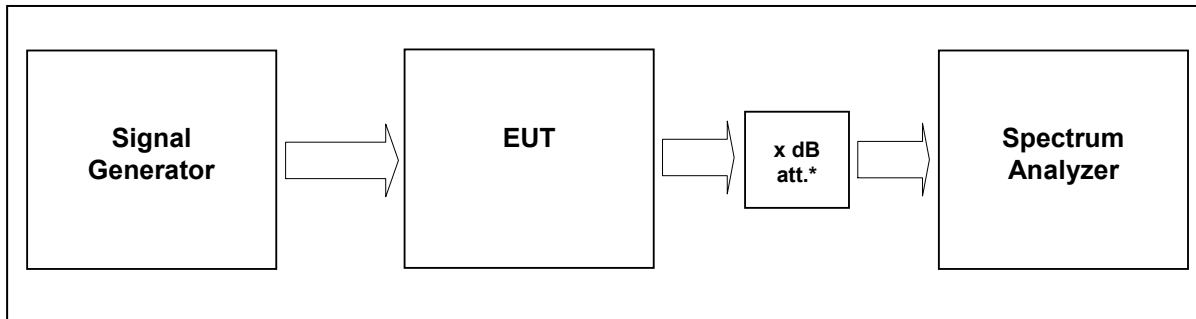

External Attenuator DL x dB = 20 dB
figure 9-#1 Test setup: Out of Band Rejection

Measurement uncertainty	± 0,38 dB
Test equipment used	9069, 9046, 9236, 7406, 7157, 7158, 7289, 7290, 7385

9.1 Limit

KDB 935210 D02 v02

Test for rejection of out of band signals. Filter frequency response plots are acceptable.

9.2 Test method

935210 D03 v02

7.1 Authorized frequency band verification test

9.3 Test results

Detector Peak max hold



9.3.1 Downlink

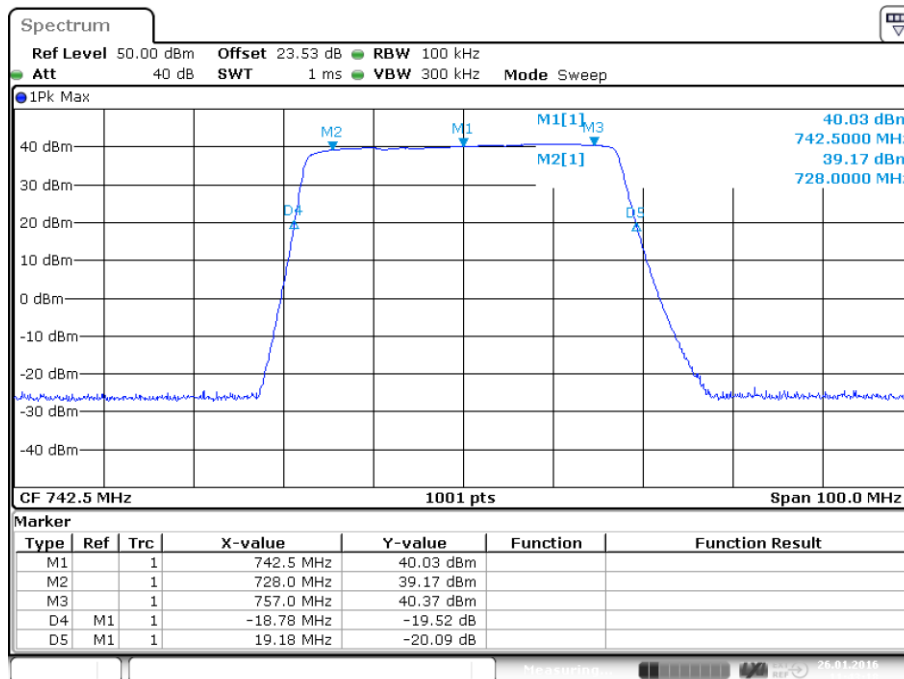

Date: 26. JAN.2016 11:43:18

plot 9.3.1-#1 Out of Band Rejection; Test results; Downlink;

9.3.2 Uplink

n.a.

Note: The EUT does not transmit over the air in the uplink direction.

9.4 Summary test result

Test result	complies, according the plots above
Tested by:	M. Leinfelder
Date:	26.01.2016

10 Radiated Spurious Emissions at the ECL (BV): §27.53, §2.1053



picture 8.1: label (EUT)

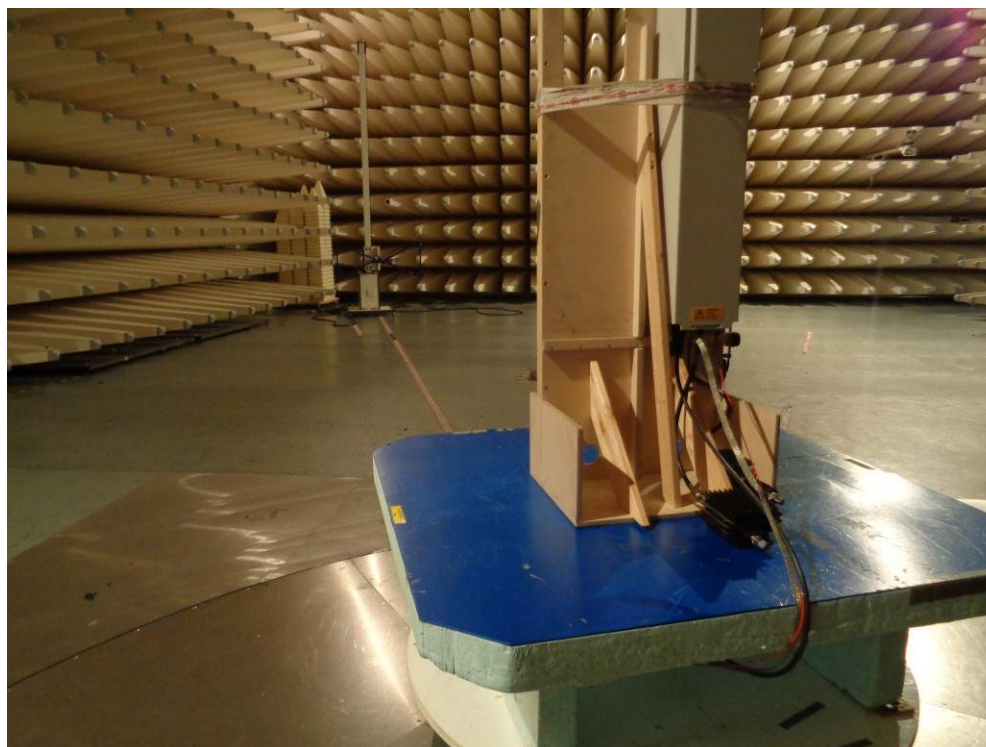

picture 8.2: Test setup: Field Strength Emission <1 GHz @10m in the SAC



picture 8.3: Test setup: Field Strength Emission 1 - 18 GHz @3m in the SAC

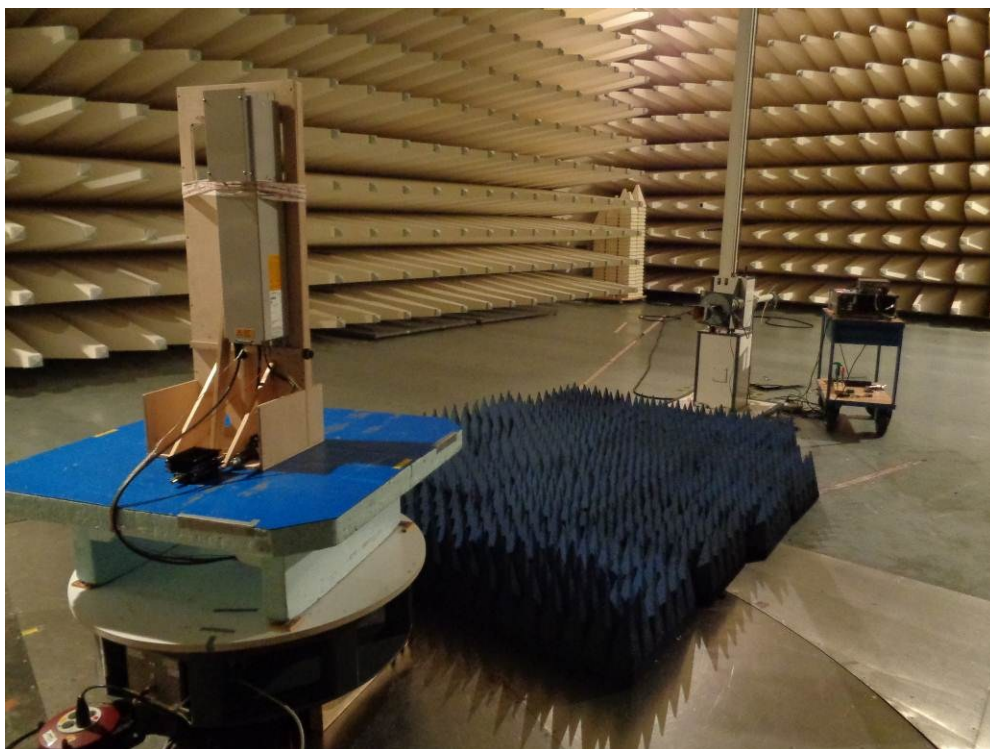

picture 8.4: Test setup: Field Strength Emission 18 - 26.5 GHz @3m in the SAC



This clause specifies requirements for the measurement of radiated emission.

Frequency range	Distance: EUT <-> antenna / location	Limit	Test method
30 MHz – 1 GHz	10 metres / SAC	FCC 47 CFR Part 27.53	TIA/EIA-603-C:2004
1 GHz – 26.5 GHz	3 metres / SAC	IC RSS-131 sec. 4.4	

Test equipment used:

Designation	Type	Manufacturer	Invent.-no.	Cal.-date	due Cal.- date	used
EMI test receiver	ESU40	Rohde & Schwarz	E2025	18.05.2015	18.05.2016	X
Antenna	CBL 6111	Chase	K1026	09.03.2015	09.03.2016	X
RF Cable	RG214	Frankonia	K1121	16.04.2015	16.04.2016	X
Antenna	HL 025	R&S	K1114	09.03.2015	09.03.2016	X
Preamplifier	AFS4-00102000	Miteq	K838	17.06.2015	17.06.2016	X
RF Cable	Sucoflex 100	Suhner	K1760	04.08.2015	04.08.2016	X
Antenna	MWH-1826/B	ARA Inc.	K1042	02.03.2012	02.03.2017	X

The REMI version 2.135 has been used to maximize radiated emission from the EUT with regards to ANSI C63.4:2009.

Test set-up:

Test location: SAC
 Both, the Fully Anechoic Chamber (FAC) and the Semi Anechoic Chamber (SAC) fulfil the requirements of ANSI C63.4 and CISPR 16-1-4 with regards to NSA and SVSWR.

Test Voltage: 110V / 60 Hz
 Type of EUT: Wall mounted

Measurement uncertainty:

Measurement uncertainty expanded (95% or K=2)	± 4,7 dB for ANSI C63.4 measurement ± 0,5 dB for TIA-603 measurement
--	---

10.1 Method of Measurement

Measurement procedure. TIA-603-C

The antenna substitution method is used to determine the equivalent radiated power at spurious frequencies. The spurious emissions are measured at a distance of 3 meters. The EUT is then replaced with a reference substitution antenna with a known gain referenced to a dipole. This antenna is fed with a signal at the spurious frequency. The level of the signal is adjusted to repeat the previously measured level. The resulting eirp is the signal level fed to the reference antenna corrected for gain referenced to an isotropic dipole (see Figure 7.2).

From KDB (AMPLIFIER, BOOSTER, AND REPEATER REMINDER SHEET):

Radiated spurs (enclosure) – Use of CW signal (low, mid, and high freq.) is acceptable rather than all modulations. The Bottom/Middle/Top frequencies for Part 27 F/H are as follows:

- 728/737/746 MHz (§27 Subpart H)
- 746/755/763 MHz (§27 Subpart F)

The maximum RFI field strength was determined during the measurement by rotating the turntable (± 180 degrees) as like defined in ANSI C63.4. A measurement receiver has been used with a RBW 120 kHz up to 1 GHz and 1 MHz above 1 GHz. Steps width during the measurement was half the RBW.

Both, the Fully Anechoic Chamber (FAC) and the Semi Anechoic Chamber (SAC) fulfil the requirements of ANSI C63.4 and CISPR 16-1-4 with regards to NSA and SVSWR.

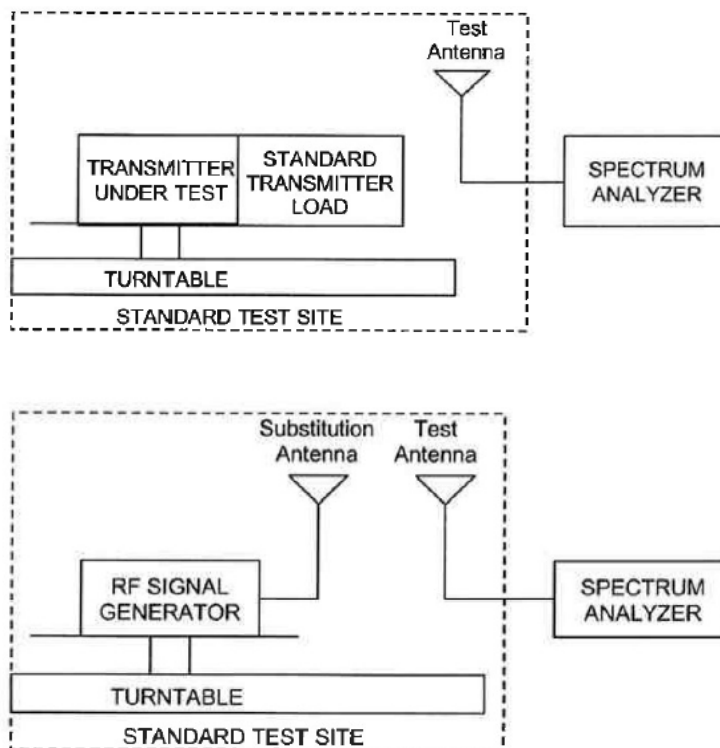

Figure #8.3 Substitution methods TIA/EIA-603-C



10.2 Limit

§27.53 Emission limitations / RSS-GEN sec. 4.9; RSS-131 sec. 4.4

Minimum standard:

Para. No.27.53 (c/d/g)

(c) For operations in the 746–758 MHz band and the 776–788 MHz band, the power of any emission outside the licensee's frequency band(s) of operation shall be attenuated below the transmitter power (P) within the licensed band(s) of operation, measured in watts, in accordance with the following:

(1) On any frequency outside the 746–758 MHz band, the power of any emission shall be attenuated outside the band below the transmitter power (P) by at least $43 + 10 \log (P)$ dB.

(g) For operations in the 698–746 MHz band, the power of any emission outside a licensee's frequency band(s) of operation shall be attenuated below the transmitter power (P) within the licensed band(s) of operation, measured in watts, by at least $43 + 10 \log (P)$ dB. Compliance with this provision is based on the use of measurement instrumentation employing a resolution bandwidth of 100 kilohertz or greater. However, in the 100 kilohertz bands immediately outside and adjacent to a licensee's frequency block, a resolution bandwidth of at least 30 kHz may be employed

The Emission limit is **-13dBm**.

(d) For operations in the 758–763 MHz and 788–793 MHz bands, the power of any emission outside the licensee's frequency bands of operation shall be attenuated below the transmitter power (P) within the licensed band(s) of operation, measured in watts, in accordance with the following:

(1) On all frequencies between 769–775 MHz and 799–805 MHz, by a factor not less than $76 + 10 \log (P)$ dB in a 6.25 kHz band segment, for base and fixed stations;

The Emission limit is:

- **-33dBm** for measurements up to 1GHz
- **-24dBm** for measurements above 1 GHz

These Values have been calculated by a formula, which was a result of an inquiry (No. 141765) of the KDB:

$$Limit = P_{OUT} - (76 + 10LOG(P_{OUT}) - 10LOG(Bwidth / 6.25kHz))$$

10.3 Receiver Settings

	up to 1 GHz	above 1 GHz
Measurement bandwidth	120 kHz	1 MHz
Step width	60 kHz	500 kHz
Dwell time	20ms	
Detector	Peak	Average

10.4 Climatic values in the lab

Temperature	18,5°C
Relative Humidity	45%
Air-pressure	1014 hPa



10.5 Test results

10.5.1 30 MHz to 1 GHz Downlink (Bottom – Middle – Top) Subpart H

Bottom: 728MHz; Middle: 737MHz; Top: 746MHz

Vertical

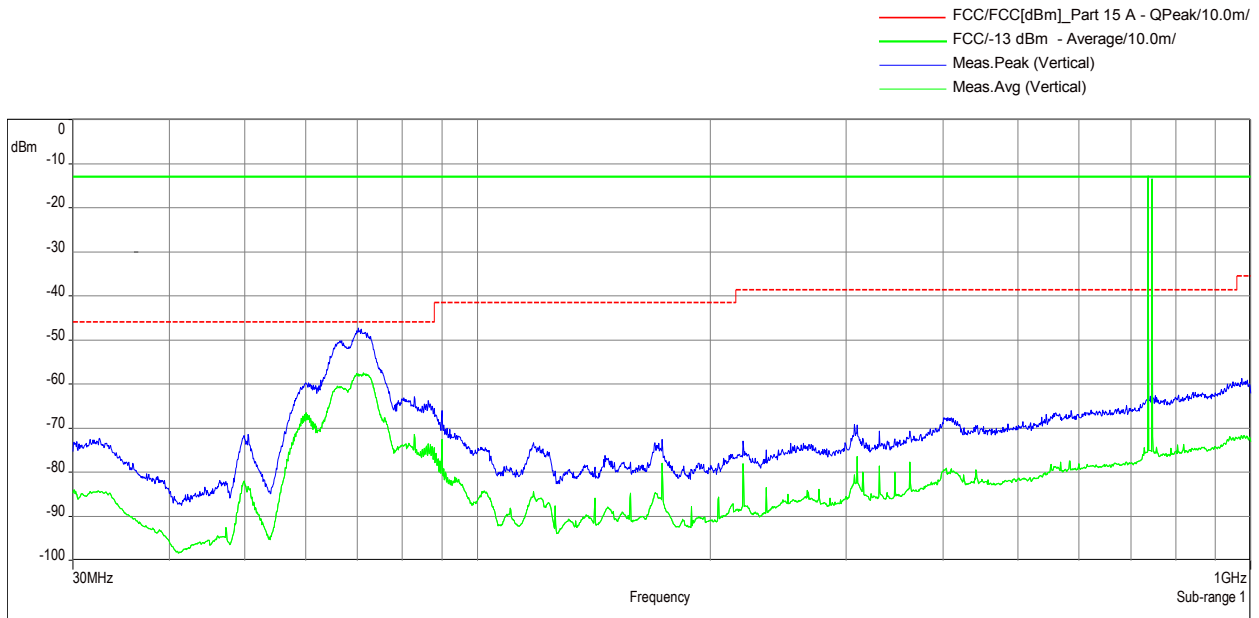

Horizontal

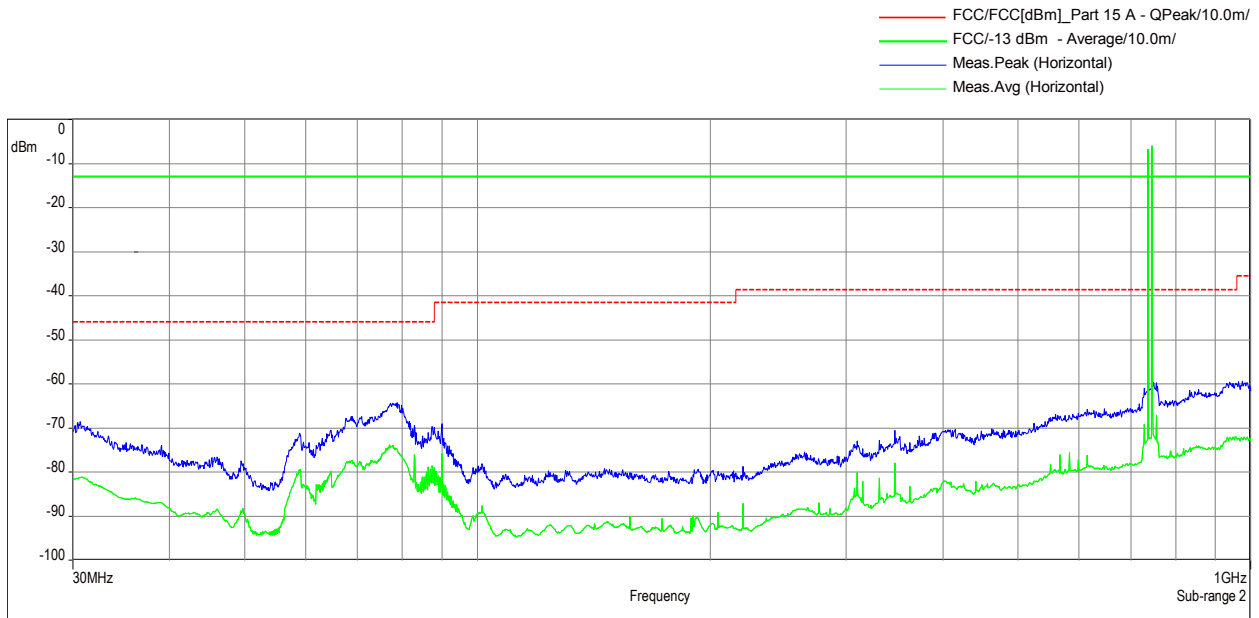

The RF output power is terminated.



10.5.2 30 MHz to 1 GHz Downlink (Bottom – Middle – Top) Subpart F

Bottom: 746MHz; Middle: 751,5MHz; Top: 757MHz

Vertical

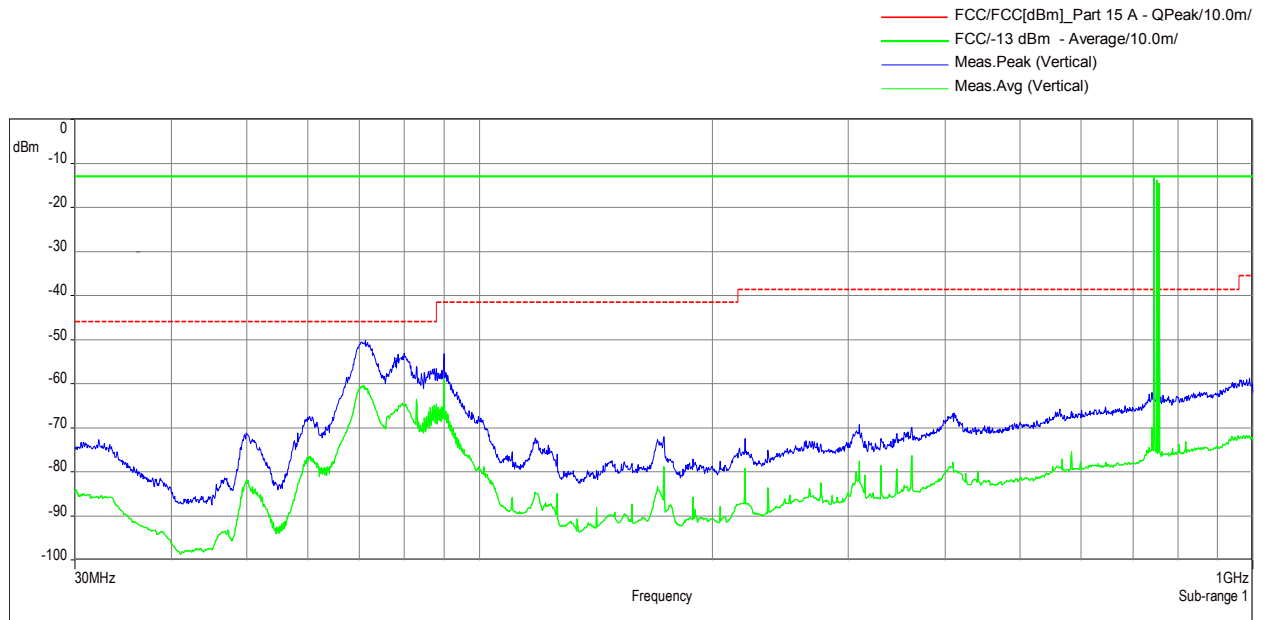

Horizontal

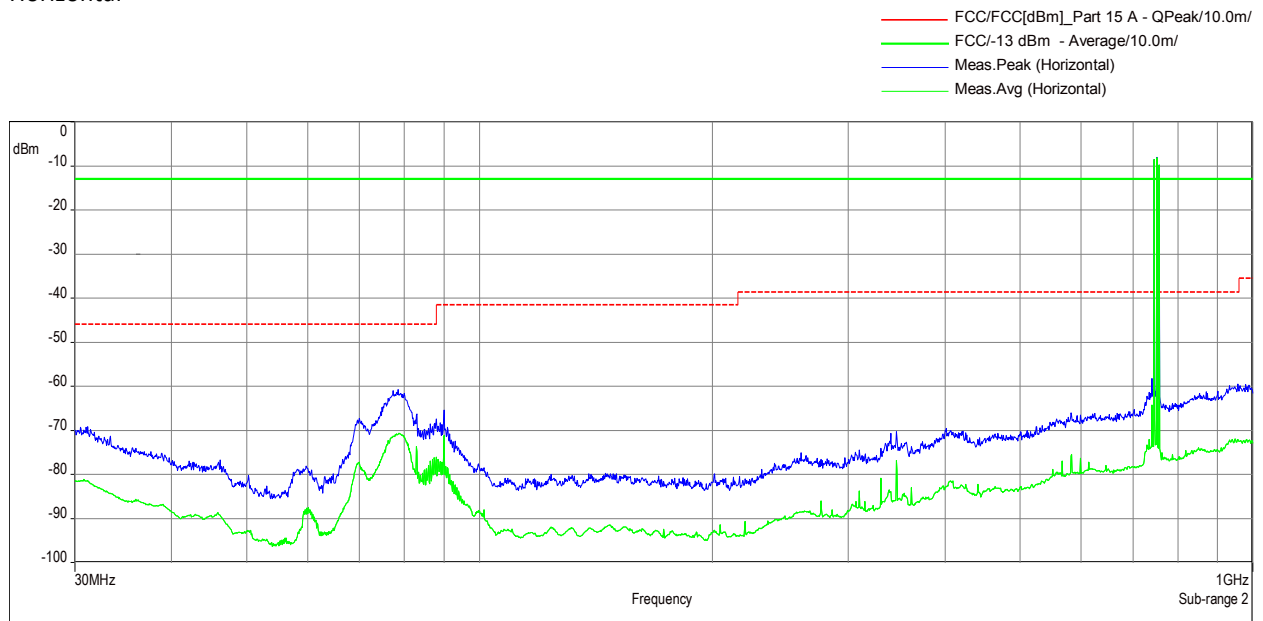

The RF output power is terminated.



10.5.3 30 MHz to 1 GHz Downlink (Middle of all paths)

F1: 737 MHz; F2: 751.5 MHz; F3: 2145 MHz

Vertikal

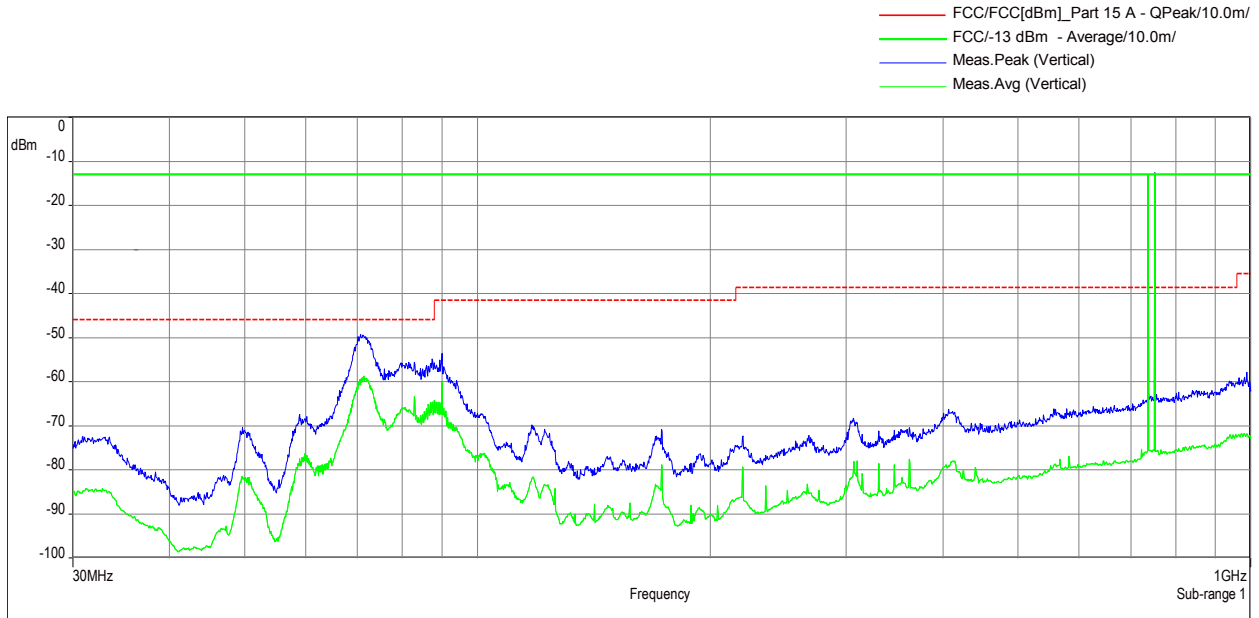

Horizontal

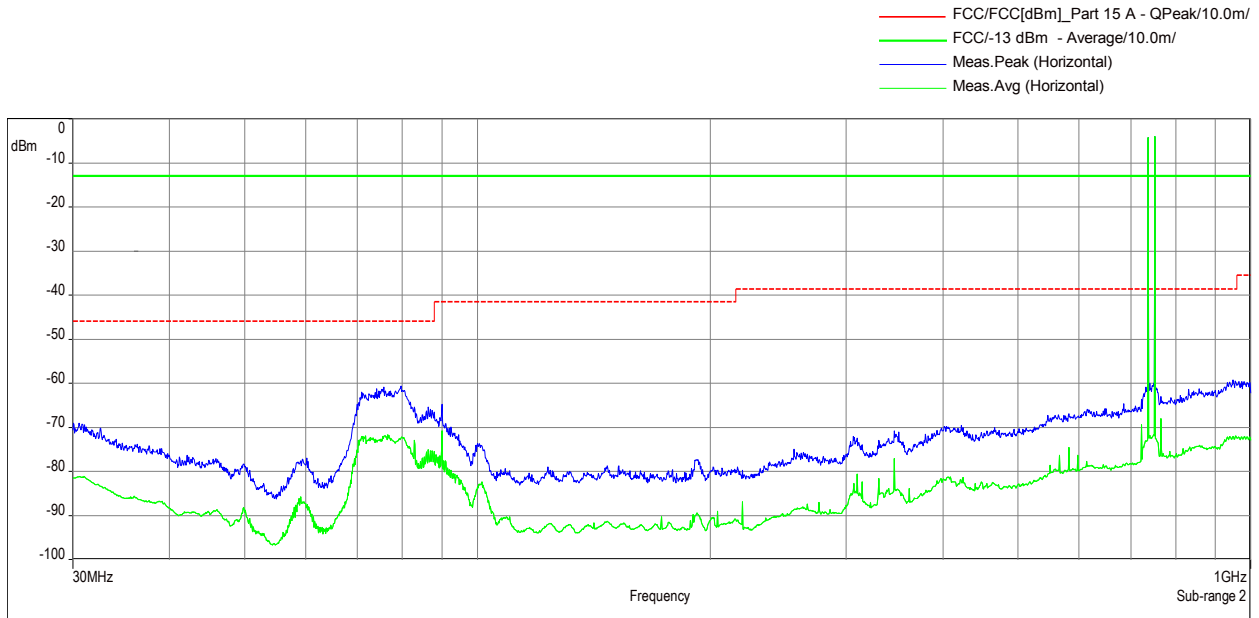

The RF output power is terminated.



10.5.4 1 GHz to 18 GHz Downlink (Bottom – Middle – Top) Subpart H

Bottom: 728MHz; Middle: 737MHz; Top: 746MHz

Vertical

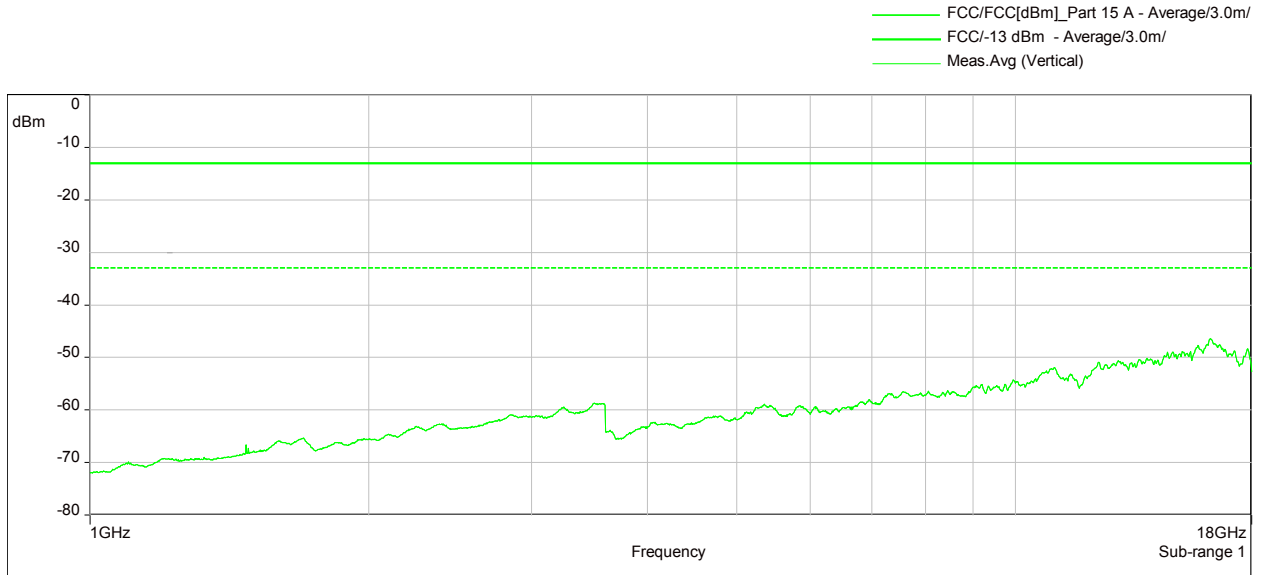

Horizontal

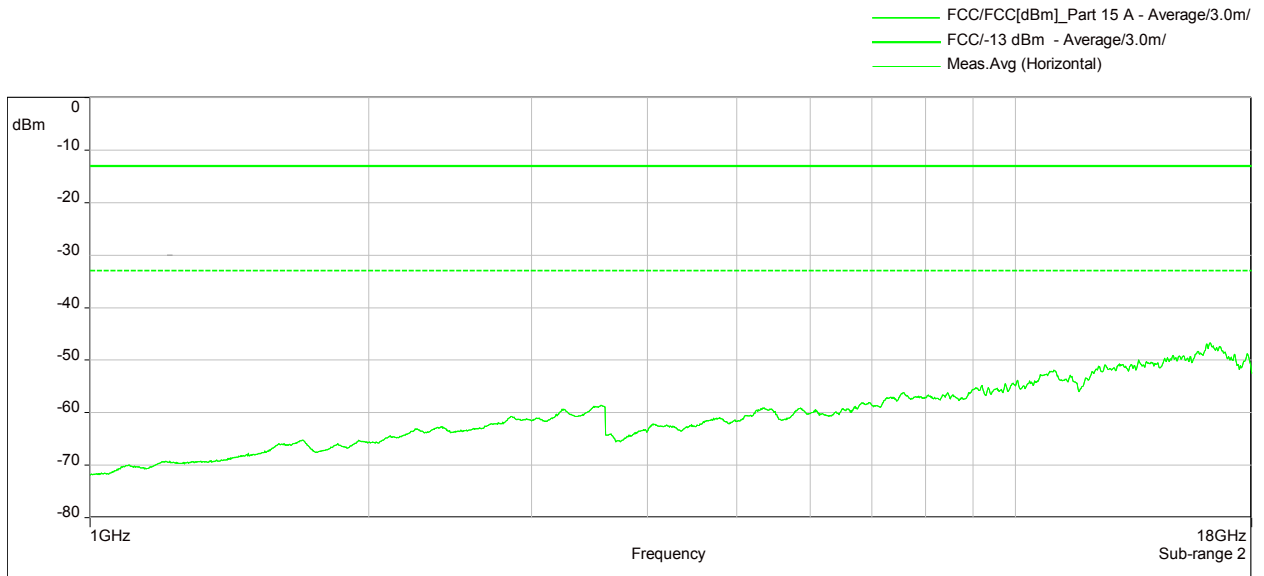

The RF output power is terminated.



10.5.5 1 GHz to 18 GHz Downlink (Bottom – Middle – Top) Subpart F

Bottom: 746MHz; Middle: 751,5MHz; Top: 757MHz

Vertical

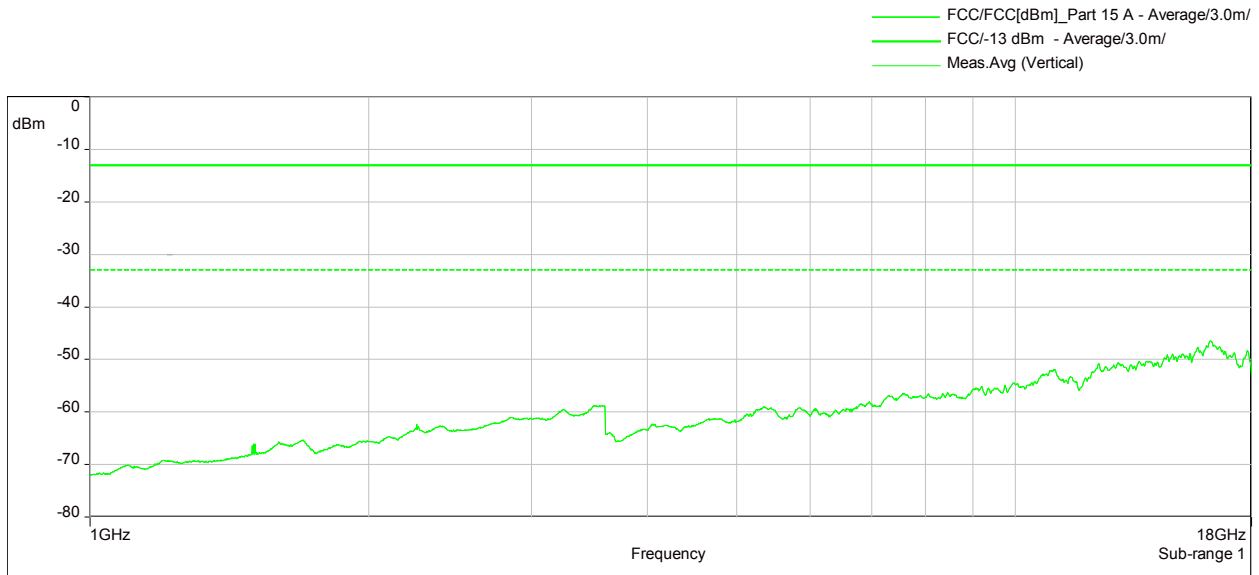

Horizontal

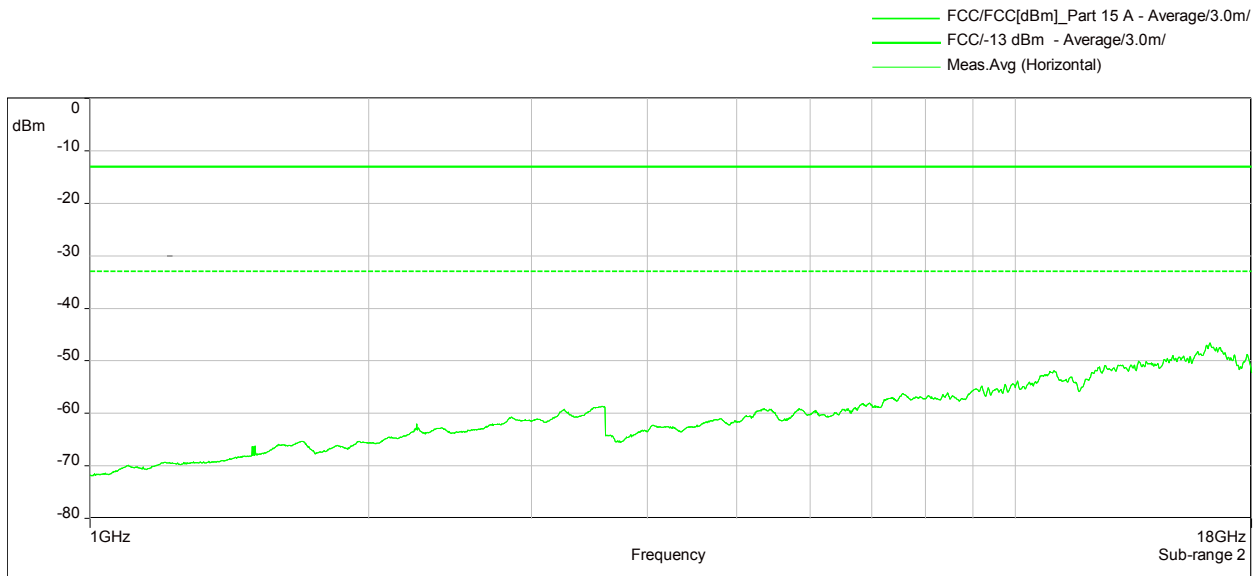

The RF output power is terminated.



10.5.6 1 GHz to 18 GHz Downlink (Middle of all paths)

F1: 737 MHz; F2: 751.5 MHz; F3: 2145 MHz (Operation with maximum composite power)

Vertikal

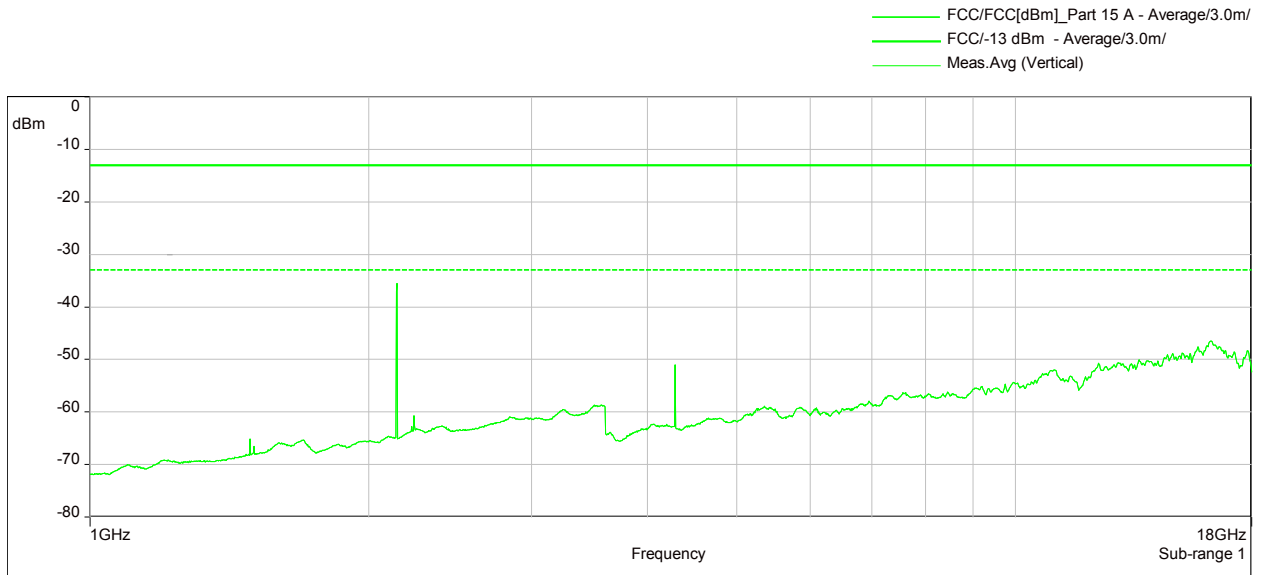

Horizontal

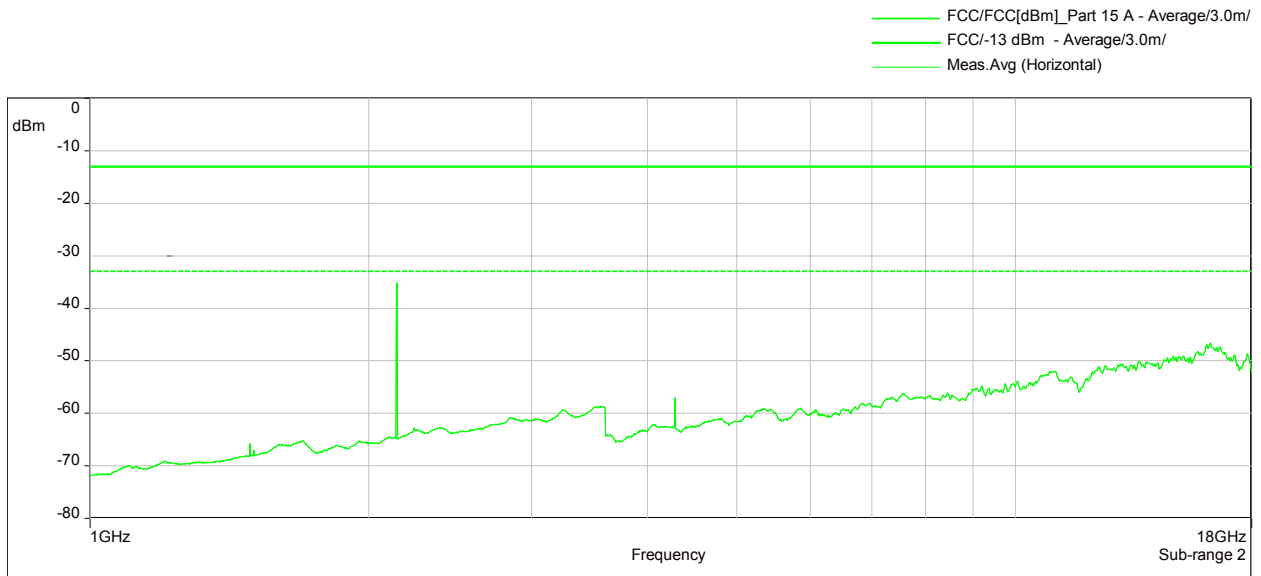

The RF output power is terminated.



10.5.7 18 GHz – 26.5 GHz Downlink (Bottom – Middle – Top)

Bottom: 728MHz; Middle: 737MHz; Top: 746MHz

Vertikal

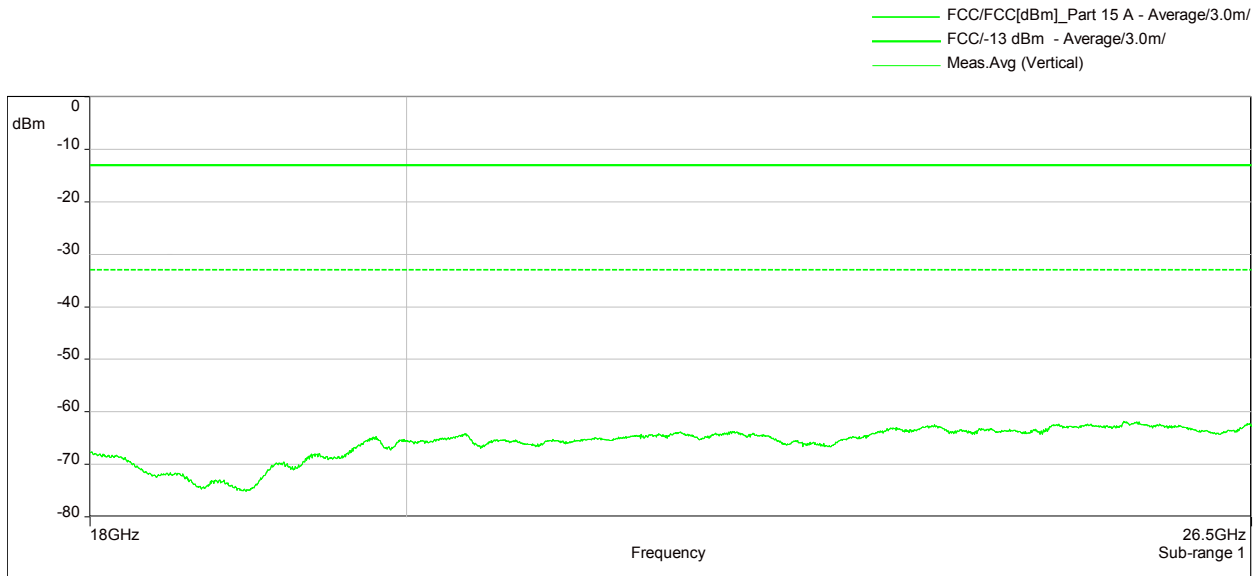

Horizontal

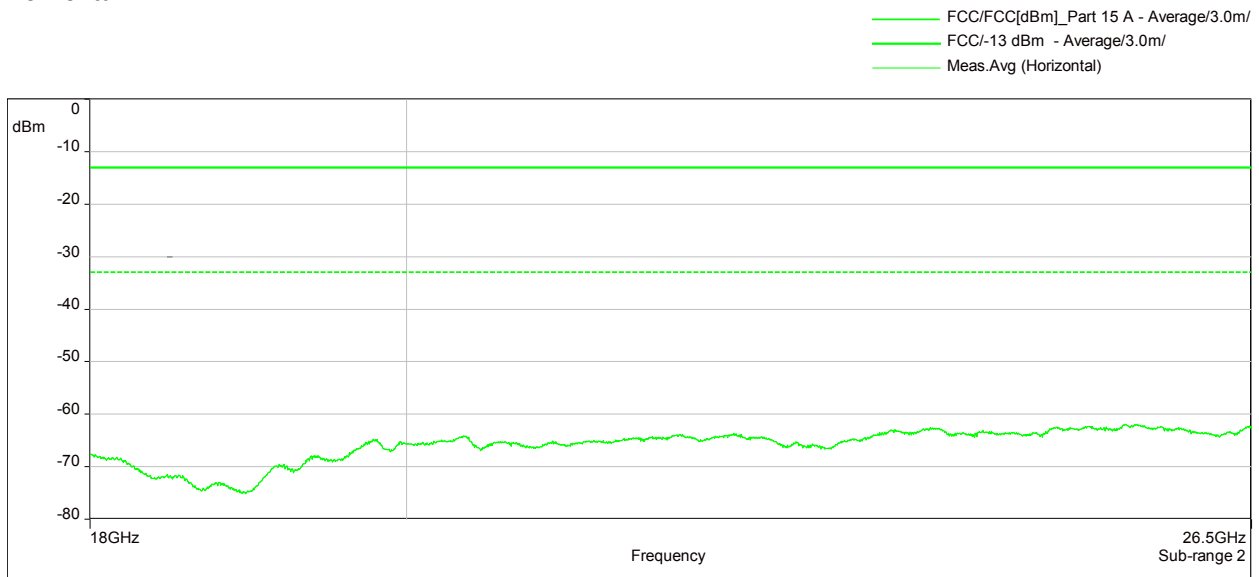

The RF output power is terminated.



10.5.8 18 GHz – 26.5 GHz Downlink (Bottom – Middle – Top)

Bottom: 746MHz; Middle: 751,5MHz; Top: 757MHz

Vertikal

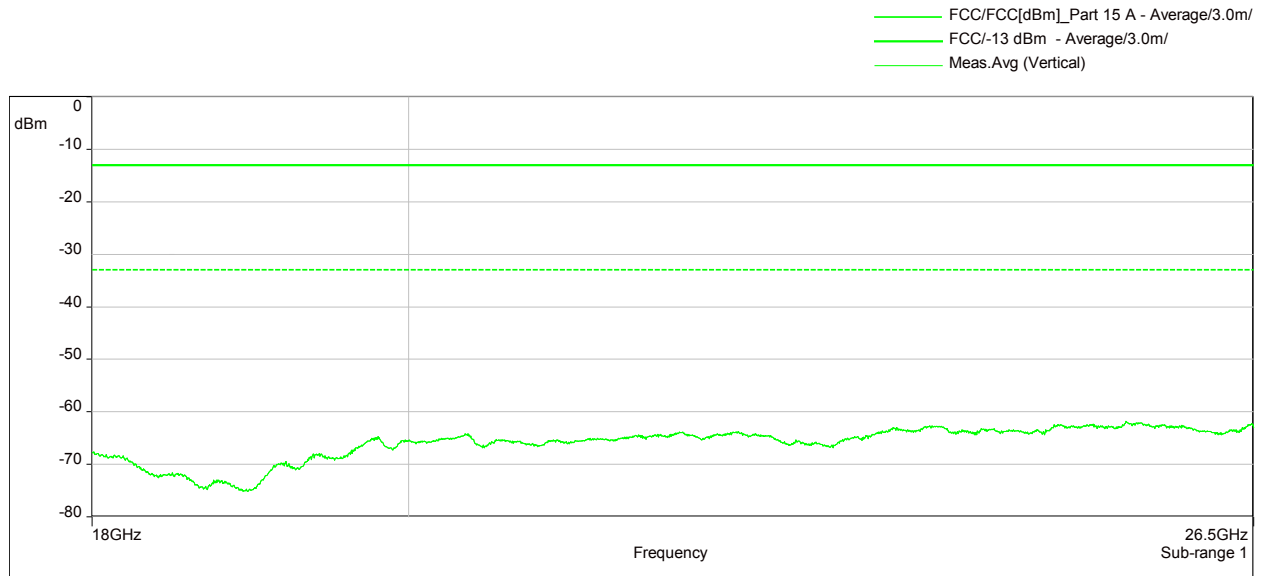

Horizontal

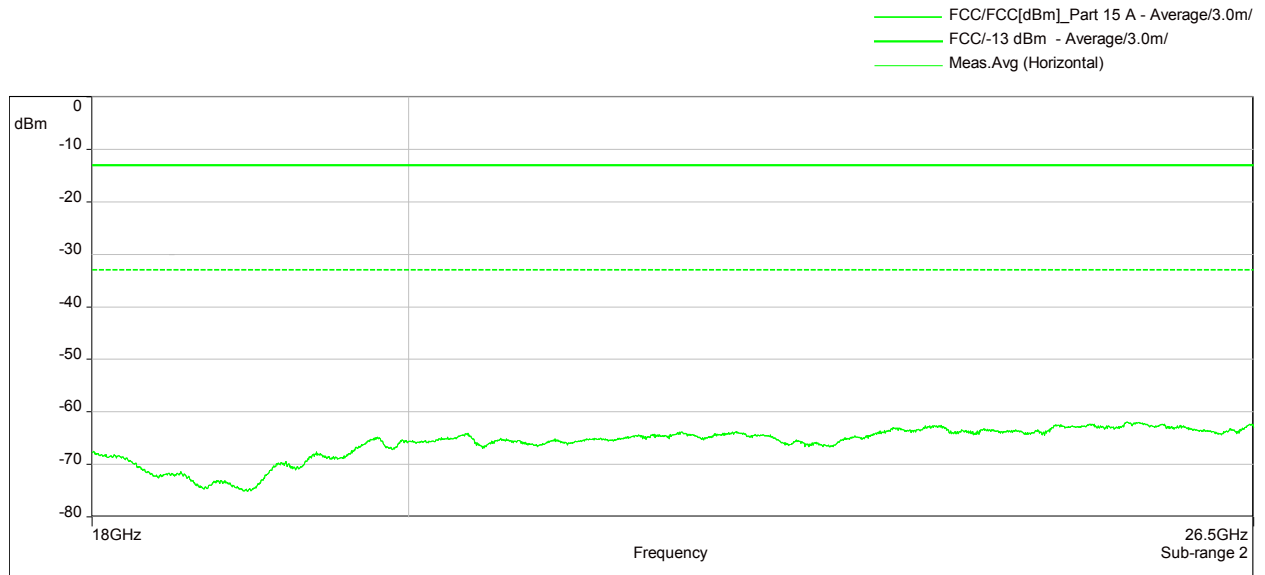

The RF output power is terminated.



10.5.9 18 GHz – 26.5 GHz Downlink (Middle of both paths)

F1: 737 MHz; F2: 751.5 MHz; F3: 2145 MHz

Vertikal

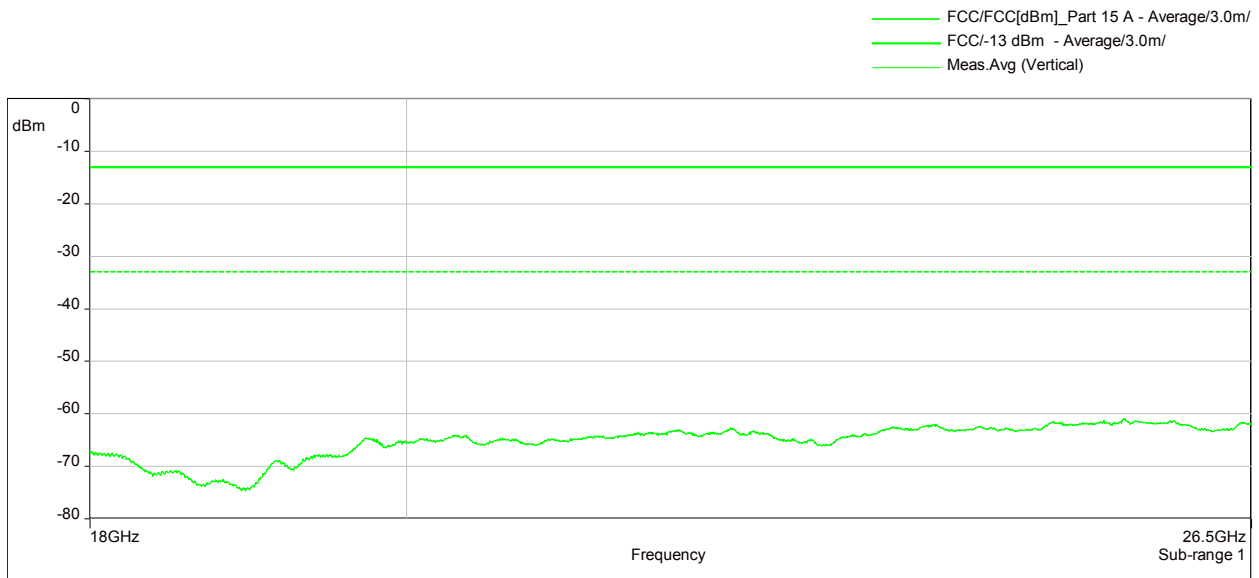

Horizontal

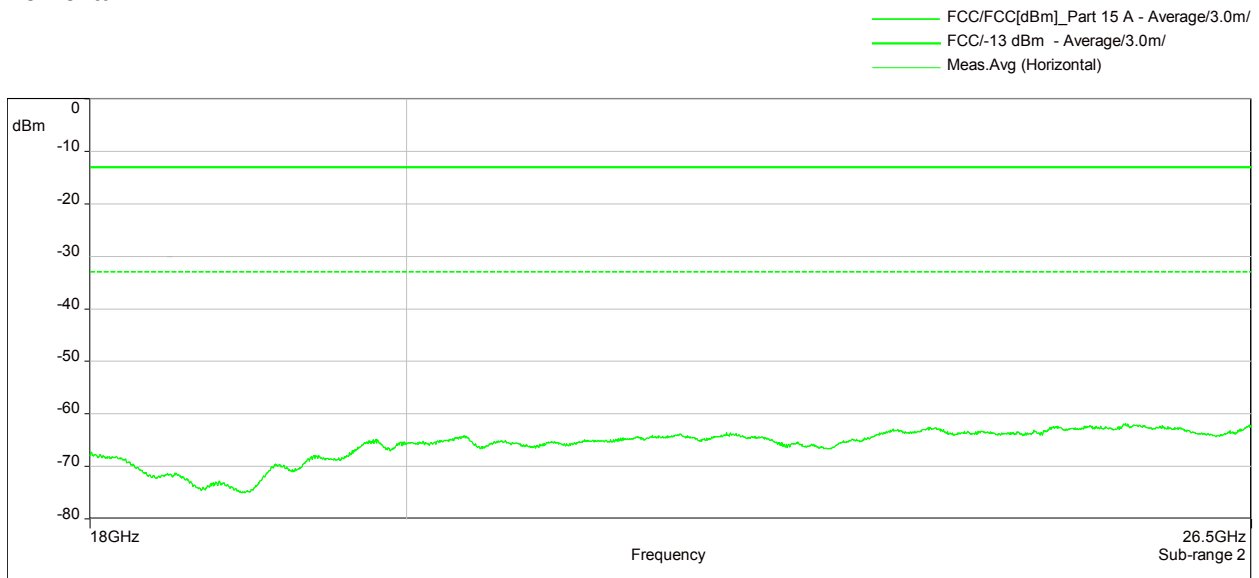

The RF output power is terminated.

Za / 16.02.2016



11 History

Revision	Modification	Date	Name
01.00	Initial Test report	17.02.2016	Tom Zahlmann

******* End of test report *******