

Test Site:  
FCC Test Site No.: 96997



BUREAU  
VERITAS

## ECL-EMC Test Report No.: 16-094

Equipment under test: **ION-M7P/85P/17EP/19P**  
**1900MHz Path**  
FCC ID: **XS5-M78517E19P**

Type of test: **FCC 47 CFR Part 24 Subpart E: 2016**  
Broadband PCS

Measurement Procedures: 47 CFR Parts 2: 2016(*Frequency Allocations and Radio Treaty Matters; General Rules and Regulations*),  
24 (Broadband PCS),  
ANSI/TIA-603-C (2004), *Land Mobile FM or PM Communications Equipment Measurement and Performance Standards*

Test result: **Passed**

Date of issue:	29.04.16	Signature:	
Issue-No.:	01	Author:	
Date of delivery:	25.04.16	Checked:	
Test dates:	24.03.16 – 26.04.16		
Pages:	56		

Test Report No.: 16-094

FCC ID: XS5-M78517E19P



BUREAU  
VERITAS

**Manufacturer:** ANDREW Wireless Systems GmbH  
Industriering 10

D-86675 Buchdorf

Tel.: +49 (0)9099 69 0

Fax: +49 (0)9099 69 140

**Test Location:** Bureau Veritas Consumer Products Services  
Germany GmbH  
European Compliance Laboratory (ECL)  
Thurn-und-Taxis-Straße 18

D-90411 Nürnberg

Tel.: +49 40 74041 0

Fax: +49 40 74041-2755

**General:**

The purpose of this report is to show compliance to the FCC regulations for unlicensed devices operating under part 24 of the Code of Federal Regulations title 47.

This report informs about the results of the EMC tests, it only refers to the equipment under test. No part of this report may be reproduced in any form, without written permission.



## Table of contents

1	TEST RESULTS SUMMARY .....	6
2	EQUIPMENT UNDER TEST (E.U.T.) .....	7
2.1	DESCRIPTION .....	7
2.1.1	DOWNLINK .....	7
2.1.2	UPLINK .....	7
2.1.3	DESCRIPTION OF EUT .....	8
2.1.4	BLOCK DIAGRAM OF MEASUREMENT REFERENCE POINTS .....	9
2.1.5	DOWNLINK SYSTEM GAIN AND OUTPUT POWER.....	9
3	TEST SITE (ANDREW BUCHDORF) .....	10
3.1	TEST ENVIRONMENT .....	10
3.2	TEST EQUIPMENT .....	10
3.3	INPUT AND OUTPUT LOSSES .....	11
3.4	MEASUREMENT UNCERTAINTY .....	11
4	TEST SITE (BUREAU VERITAS CONSUMER PRODUCTS SERVICES) .....	11
5	RF POWER OUT: §24.232, §2.1046 .....	12
5.1	LIMIT.....	12
5.2	TEST METHOD .....	12
5.3	TEST RESULTS.....	13
5.3.1	DOWNLINK.....	14
5.3.1.1	GSM.....	15
5.3.1.2	EDGE.....	15
5.3.1.3	CDMA .....	16
5.3.1.4	WCDMA.....	16
5.3.1.5	LTE .....	17
5.3.2	UPLINK .....	17
5.4	SUMMARY TEST RESULT.....	17
6	OCCUPIED BANDWIDTH: §2.1049; .....	18
6.1	LIMIT.....	18
6.2	TEST METHOD .....	18
6.3	TEST RESULTS .....	19
6.3.1	DOWNLINK.....	19
6.3.1.1	GSM.....	20
6.3.1.2	EDGE.....	21
6.3.1.3	CDMA .....	22
6.3.1.4	WCDMA.....	23
6.3.1.5	LTE .....	24
6.3.2	26DB BANDWIDTH.....	25
6.3.2.1	GSM.....	25
6.3.2.2	EDGE.....	26
6.3.2.3	CDMA .....	27
6.3.2.4	WCDMA.....	28



6.3.2.5	LTE .....	29
6.3.3	UPLINK .....	30
6.4	SUMMARY TEST RESULT .....	30
7	SPURIOUS EMISSIONS AT ANTENNA TERMINALS: §24.238, §2.1051 .....	31
7.1	LIMIT .....	31
7.2	TEST METHOD .....	31
7.3	TEST RESULTS .....	32
7.3.1	DOWNLINK .....	32
7.3.1.1	GSM .....	32
7.3.1.2	EDGE .....	33
7.3.1.3	CDMA .....	33
7.3.1.4	WCDMA .....	34
7.3.1.5	LTE .....	34
7.3.2	UPLINK .....	35
7.4	SUMMARY TEST RESULT .....	35
8	INTERMODULATION: §24.238, §2.1051 .....	36
8.1	LIMIT .....	36
8.2	TEST METHOD .....	36
8.3	TEST RESULTS .....	37
8.3.1	DOWNLINK .....	37
8.3.1.1	GSM .....	38
8.3.1.2	EDGE .....	39
8.3.1.3	CDMA .....	40
8.3.1.4	WCDMA .....	41
8.3.1.5	LTE .....	42
8.3.2	UPLINK .....	43
8.4	SUMMARY TEST RESULT .....	43
9	OUT OF BAND REJECTION .....	44
9.1	LIMIT .....	44
9.2	TEST METHOD .....	44
9.3	TEST RESULTS .....	44
9.3.1	DOWNLINK .....	45
9.3.2	UPLINK .....	45
9.4	SUMMARY TEST RESULT .....	45
10	FIELD STRENGTH OF SPURIOUS EMISSIONS: §24.238, §2.1053 .....	46
10.1	LIMIT §24.238 .....	49
10.2	TEST METHOD ANSI/TIA/EA-603-C .....	49
10.3	CLIMATIC VALUES IN THE LAB .....	49
10.4	TEST RESULTS .....	50
10.4.1	30 MHz TO 1 GHz DOWNLINK (BOTTOM – MIDDLE – TOP) SUBPART H .....	50
10.4.2	30 MHz TO 1 GHz DOWNLINK (MIDDLE OF ALL PATHS) .....	51
10.4.3	1 GHz TO 18 GHz DOWNLINK (BOTTOM – MIDDLE – TOP) SUBPART H .....	52
10.4.4	1 GHz TO 18 GHz DOWNLINK (MIDDLE OF ALL PATHS) .....	53
10.4.5	18 GHz – 26.5 GHz DOWNLINK (BOTTOM – MIDDLE – TOP) .....	54

Test Report No.: 16-094

FCC ID: XS5-M78517E19P



**BUREAU  
VERITAS**

---

10.4.6	18 GHz – 26.5 GHz DOWNLINK (MIDDLE OF BOTH PATHS) .....	55
11	HISTORY .....	56



## 1 Test Results Summary

Name of Test	FCC Para. No.	FCC Method	FCC Spec.	Result
RF Power Output	24.232(a)	2.1046(a)	1640 Watts E.I.R.P	Complies
Occupied Bandwidth	KDB 935210 D02 v03r02	2.1049(h)	Input/Output	Complies
Spurious Emissions at Antenna Terminals	24.238(a)	2.1051	-13dBm	Complies
Intermodulation	KDB 935210 D02 v03r02	KDB 935210 D02 v03r02	KDB 935210 D02 v03r02	Complies
Field Strength of Spurious Emissions	24.238(a)	2.1053	-13dBm E.I.R.P	Complies
Frequency Stability	NA	2.1055(a)(d)	Must stay in band	NA
Out of Band Rejection	KDB 935210 D02 v03r02	KDB 935210 D03 v04	KDB 935210 D03 v04	Complies

Frequency stability is given by: The system gets an electrical analog signal from the BSS which is converted into an analog optical signal, transmitted by the optical links and then reconverted in the Remote Unit into an analog electrical signal. During this process happens no frequency change/modification, so input and output have same frequency what can be seen under clause "Occupied Bandwidth".



## 2 Equipment under test (E.U.T.)

### 2.1 Description

Kind of equipment	ION-M7P/85P/17EP/19P
Andrew Ident. Number	7714179-0002
Serial no.(SN)	15
Revision	00
Software version and ID	n. a.
Type of modulation and Designator	GSM (GXW) <input checked="" type="checkbox"/> GSM EDGE (G7W) <input checked="" type="checkbox"/> CDMA (F9W) <input checked="" type="checkbox"/> W-CDMA (F9W) <input checked="" type="checkbox"/> LTE (G7D) <input checked="" type="checkbox"/>
Frequency Translation	F1-F1 <input checked="" type="checkbox"/> F1-F2 <input type="checkbox"/> N/A <input type="checkbox"/>
Band Selection	Software <input type="checkbox"/> Duplexer <input checked="" type="checkbox"/> Full band <input type="checkbox"/>

#### 2.1.1 Downlink

Pass band	Path 1930 MHz – 1995 MHz
Max. composite output power based on one carrier per path (rated)	43.0 dBm = 20 W
System Gain*	10 dB @ Pout BTS of 33 dBm

\*see 2.1.5

#### 2.1.2 Uplink

Pass band	Path 1850 MHz – 1915 MHz
Maximum rated output power	n. a.
System Gain*	n. a.

\*see 2.1.5

Note: The EUT does not transmit over the air in the uplink direction.



---

### 2.1.3 Description of EUT

CommScope's ION-M7P/85P/17EP/19P is a multi-band, multi-operator Remote Unit. It is used in conjunction with a Master Unit in the ION optical distribution system. This system transports up to 4 frequency bands simultaneously, providing a cost-effective solution for distributing capacity from one or more base stations.

This Test Report describes only the approval of the 1900 MHz Path.  
The ION-M7P/85P/17EP/19P Repeater system consists of one 700 MHz path, one 850 MHz path, one 1700/2100 MHz path and one 1900 MHz path with the intended use of simultaneous transmission.  
The antenna(s) used with device must be fixed-mounted on permanent structures.





### 2.1.4 Block diagram of measurement reference points

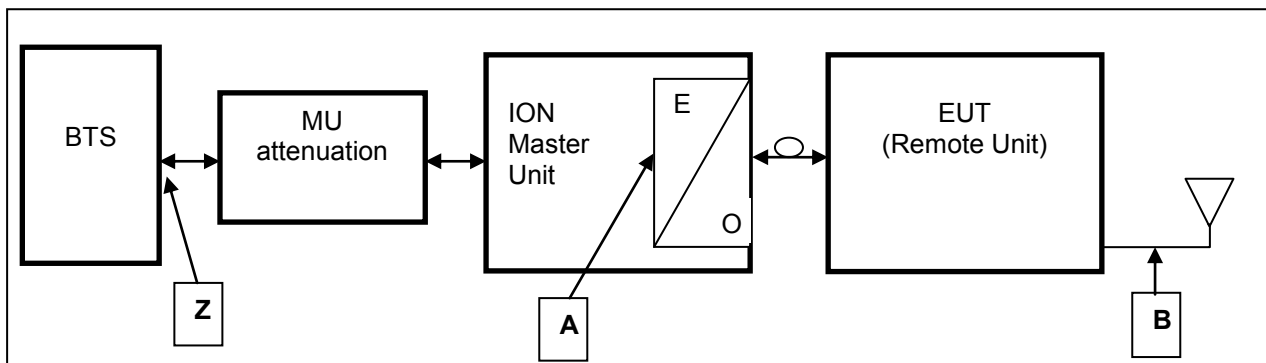

figure 2.1.4-#1 Block diagram of measurement reference points

Remote Unit (RU) is the EUT

O/E                                      Optical/Electrical converter  
 MU                                        Master Unit

Reference point A      MU                                      UL output,                      DL input  
 Reference point B      Remote Unit                      DL output,                      UL input  
 Reference point Z      BTS                                      DL output,                      UL input

Since a signal generator does not supply a good output signal with +33 or +43dBm, for the downlink measurement the MU Attenuation is not used.

That means for downlink measurements the signal generator is connected to measurement point A at the master optical / electrical converter and the analyzer to the measurement point B at the RU.

### 2.1.5 Downlink System Gain and Output Power

System optimized for BTS power (fixed value)  <b>Z</b>	MU Attenuation (manual leveling)	Maximum rated input power at the MU OTRX (fixed value)  <b>A</b>	RU Gain (fixed value)  <b>A to B</b>	Maximum rated output power at RU Antenna port (fixed value)  <b>B</b>
<b>+33 dBm</b>	<b>30 dB</b>	<b>3 dBm</b>	<b>+40 dB</b>	<b>+43 dBm</b> <i>@ 1 carrier</i>
<b>System Gain Z to B</b>	<b>+10 dB</b>			
<b>+43 dBm</b>	<b>40 dB</b>	<b>3 dBm</b>	<b>+40 dB</b>	<b>+43 dBm</b> <i>@ 1 carrier</i>
<b>System Gain Z to B</b>	<b>0 dB</b>			

table 2.1.5-#1 Equipment under test (E.U.T.) Description Downlink System Gain and Output Power



### 3 Test site (Andrew Buchdorf)

#### 3.1 Test environment

All tests were performed under the following environmental conditions:

Condition	Minimum value	Maximum value
Barometric pressure	86 kPa	106 kPa
Temperature	15°C	30°C
Relative Humidity	20 %	75 %
Power supply range	±5% of rated voltages	

#### 3.2 Test equipment

ANDREW Inv. No.	Test equipment	Type	Manufacturer	Serial No.	Calibration
9295	Network Analyzer	ZNB20	R&S	101540	11/16
9291	Spectrum Analyzer	FSV30	R&S	103090	06/16
9233	Signal Generator	SMBV100A	R&S	257777	06/16
8849	Signal Generator	SMU200A	R&S	101732	04/16
8671	Power Meter	E4418B	Agilent	GB39513094	06/16
8672	Power Sensor	E9300H	Agilent	US41090179	06/16
7306	Circulator	C25E-1FFF	AEROTEK	12580	CIU
7307	Circulator	C25E-1FFF	AEROTEK	12581	CIU
7408	RF-Cable	2,0m; N-N	Andrew	---	CIU
7409	RF-Cable	2,0m; N-N	Andrew	---	CIU
7410	RF-Cable	1,0m; N-N	Andrew	---	CIU
7411	RF-Cable	2,0m; N-N	Andrew	---	CIU
7373	RF-Cable	Multiflex141	Andrew	---	CIU
7374	RF-Cable	Multiflex141	Andrew	---	CIU
7437	RF-Cable	Multiflex141	Andrew	---	CIU
7438	RF-Cable	Multiflex141	Andrew	---	CIU
7439	RF-Cable	Multiflex141	Andrew	---	CIU
7443	RF-Cable	Multiflex141	Andrew	---	CIU
7444	RF-Cable	Multiflex141	Andrew	---	CIU
7445	RF-Cable	Multiflex141	Andrew	---	CIU
7446	RF-Cable	Multiflex141	Andrew	---	CIU
7447	RF-Cable	Multiflex141	Andrew	---	CIU
7448	RF-Cable	Multiflex141	Andrew	---	CIU
7449	RF-Cable	Multiflex141	Andrew	---	CIU
7450	RF-Cable	Multiflex141	Andrew	---	CIU
7440	RF-Cable	RG-223 0.8m	Andrew	---	CIU
7441	RF-Cable	RG-223 0.8m	Andrew	---	CIU
7453	RF-Cable	RG223 2m SMA.	Andrew	---	CIU
7454	RF-Cable	RG223 2m SMA.	Andrew	---	CIU
7455	RF-Cable	RG223 2m SMA.	Andrew	---	CIU
7144	Attenuator	2N-20dB	Inmet 64671	---	CIU
7336	Power Attenuator	769-20	Narda	---	CIU
7368	Matrix		COMMSCOPE	---	weekly

CIU = Calibrate in use



### 3.3 Input and output losses

All recorded power levels should be referenced to the input and output connectors of the repeater, unless explicitly stated otherwise.

The test equipment used in this test has to be calibrated, so that the functionality is also checked.

All cables, attenuators, splitter, isolator, circulator and combiner etc. must be measured before testing and used for compensation during testing.

### 3.4 Measurement uncertainty

The extended measurement uncertainty corresponds to the measurement results from the standard measurement uncertainty multiplied by the coverage factor  $k=2$ . The true value is located in the corresponding interval with a probability of 95 %.

## 4 Test site (Bureau Veritas Consumer Products Services)

FCC Test site: 96997

See relevant dates under section 10.



## 5 RF Power Out: §24.232, §2.1046

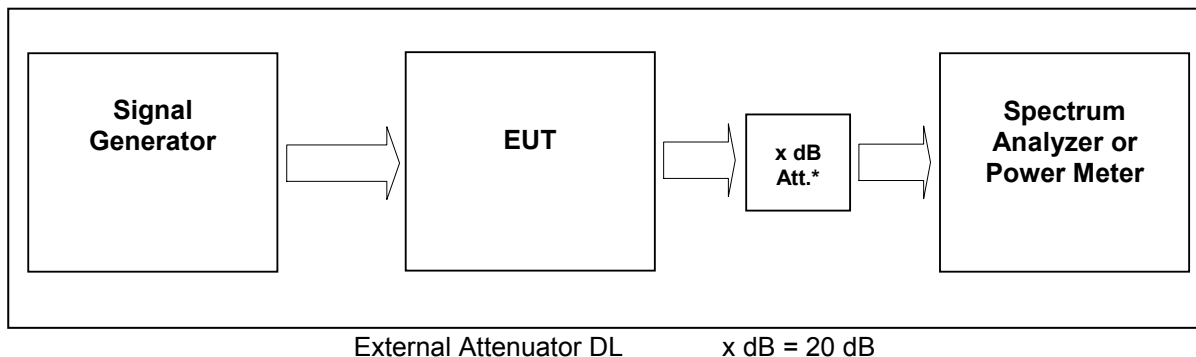

figure 5-#1 Test setup: RF Power Out: §24.232, §2.1046

Measurement uncertainty	± 0,38 dB
Test equipment used	9291, 9233, 7444; 7321; 7144; 7454; 7453; 7336; 7449; 7368

### 5.1 Limit

Minimum standard:

Para. No.24.232

(a)(1) Base stations with an emission bandwidth of 1 MHz or less are limited to 1640 watts equivalent isotropically radiated power (EIRP) with an antenna height up to 300 meters HAAT, except as described in paragraph (b) below.

(2) Base stations with an emission bandwidth greater than 1 MHz are limited to 1640 watts/MHz equivalent isotropically radiated power (EIRP) with an antenna height up to 300 meters HAAT, except as described in paragraph (b) below.

Table 1—Reduced Power for Base Station Antenna Heights Over 300 Meters

HAAT in meters	Maximum EIRP watts
≤ 300	1640
≤ 500	1070
≤ 1000	490
≤ 1500	270
≤ 2000	160

### 5.2 Test method

§ 2.1046 Measurements required: RF power output.

(a) For transmitters other than single sideband, independent sideband and controlled carrier radiotelephone, power output shall be measured at the RF output terminals when the transmitter is adjusted in accordance with the tune-up procedure to give the values of current and voltage on the circuit elements specified in § 2.1033(c)(8). The electrical characteristics of the radio frequency load attached to the output terminals when this test is made shall be stated.



(c) For measurements conducted pursuant to paragraphs (a) and (b) of this section, all calculations and methods used by the applicant for determining carrier power or peak envelope power, as appropriate, on the basis of measured power in the radio frequency load attached to the transmitter output terminals shall be shown. Under the test conditions specified, no components of the emission spectrum shall exceed the limits specified in the applicable rule parts as necessary for meeting occupied bandwidth or emission limitations

### **5.3 Test Results**

Detector RMS.

#### **Test signal GSM:**

Signal waveform with GMSK modulation in all time slots according to 3GPP TS45.004

#### **Test signal GSM EDGE:**

Signal waveform with 8-PSK modulation in all time slots according to 3GPP TS45.004

#### **Test signal CDMA:**

Signal waveform according to table 6.2-1 of standard specification 3GPP2 C.p0051-0 v1.0 16.February 2006 pilot, sync, paging, 37 traffics, which is equal to the table 6.5.2.1 of 3GPP2 C.S0010-C v2.0 24.February 2006.

#### **Test signal WCDMA:**

Signal waveform according to Test Model 1 of standard specification 3GPP TS25.141. Signal modulated with a combination of PCCPCH, SCCPCH and Dedicated Physical Channels specified as test model 1 64 DPCH.

#### **Test signal LTE:**

Signal waveform according to Test Model 1.1, E-TM1.1, clause 6.1.1.1-1, table 6.1.1.1-1 of standard specification 3GPP TS 36.141 V9.3.0 (2010-03).



**5.3.1 Downlink**

Modulation	Measured at	Carrier /MHz	RBW VBW Span	RF Power (dBm)	RF Power (W)	Plot -
GSM	Middle	1962.5 MHz	1MHz 3MHz 10MHz	43.0	20	5.3.1.1 #1
EDGE	Middle	1962.5 MHz	1MHz 3MHz 10MHz	43.0	20	5.3.1.2 #1
CDMA	Middle	1962.5 MHz	3MHz 10MHz 15MHz	42.5	18	5.3.1.3 #1
WCDMA	Middle	1962.5 MHz	10MHz 10MHz 50MHz	42.5	18	5.3.1.4 #1
LTE	Middle	1962.5 MHz	3MHz 10MHz 15MHz	43.0	20	5.3.1.5 #1
Maximum output power = 43.0 dBm = 20 W						
Limit Maximum output power (erp) = 1000 W						

table 5.3.1-#1 RF Power Out: §24.232, §2.1046 Test Results Downlink

The max RF Power out is 43.0 dBm, so the maximum antenna gain (x) can be calculated as follow:

**Limit = 1000W (erp) = 60 dBm**

Info: 1000W (erp) = 1640W (eirp)

$$60 \text{ dBm} > 43.0 \text{ dBm} + x \quad \text{----->} \quad x = 60 \text{ dBm} - 43.0 \text{ dBm} = \underline{17.0 \text{ dBd}}$$

$$x \text{ dBi} = 17.0 \text{ dBd} + 2.15 = \underline{19.15 \text{ dBi}}$$

=> The antenna that will be used for the complete system have to have a gain lower than 17.15 dBi, relative to a dipol.

Modulation	Pin / dBm (Ref. point A)
GSM	3.1
EDGE	3.0
CDMA	2.7
WCDMA	2.5
LTE	3.1

table 5.3.1-#2 RF Power Out: §24.232, §2.1046 Test Results Downlink Input power



### 5.3.1.1 GSM

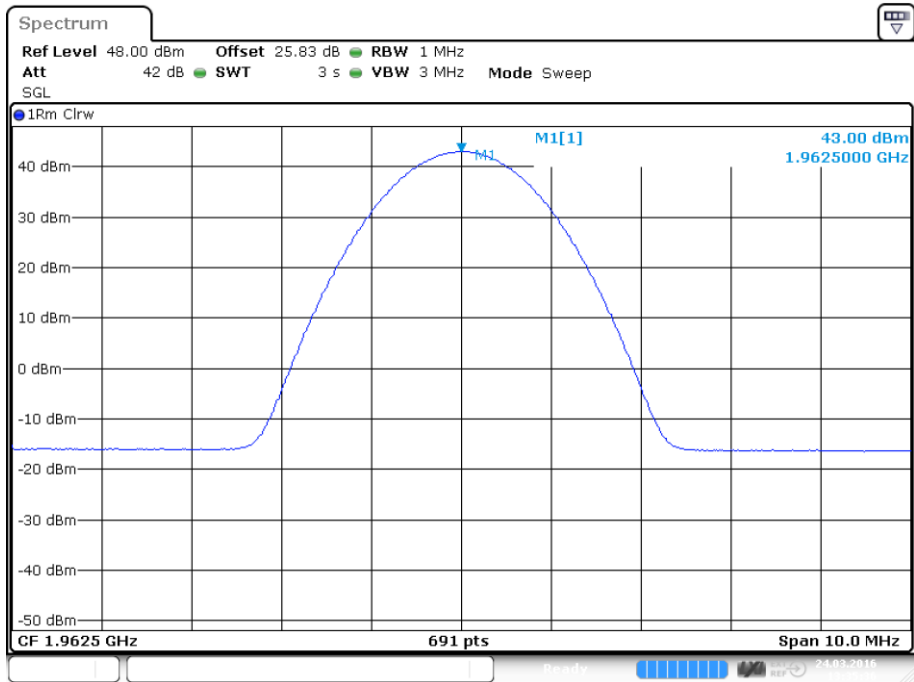

Date: 24.MAR.2016 13:35:36

plot 5.3.1.1-#1 RF Power Out: §24.232, §2.1046; Test Results; Downlink; GSM Middle

### 5.3.1.2 EDGE

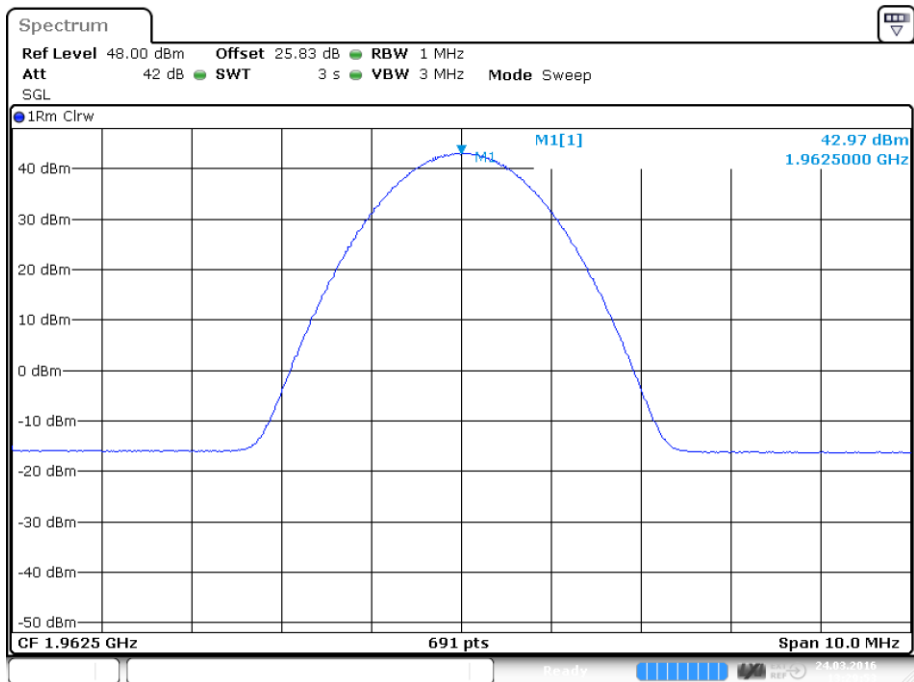

Date: 24.MAR.2016 13:29:53

plot 5.3.1.2-#1 RF Power Out: §24.232, §2.1046; Test Results; Downlink; EDGE Middle



### 5.3.1.3 CDMA

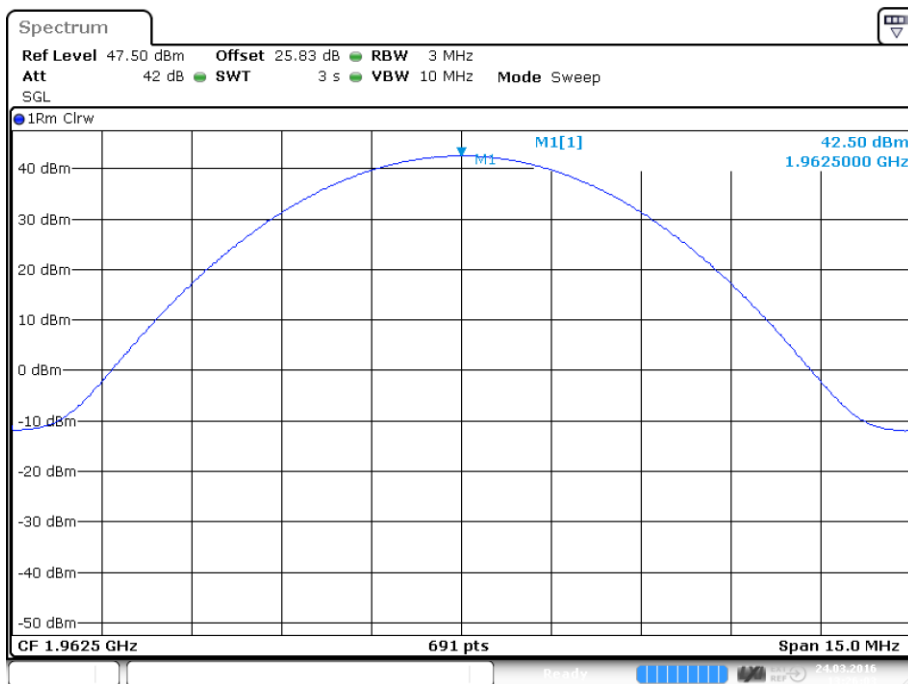

Date: 24.MAR.2016 13:26:03

plot 5.3.1.3-#1 RF Power Out: §24.232, §2.1046; Test Results; Downlink; CDMA Middle

### 5.3.1.4 WCDMA

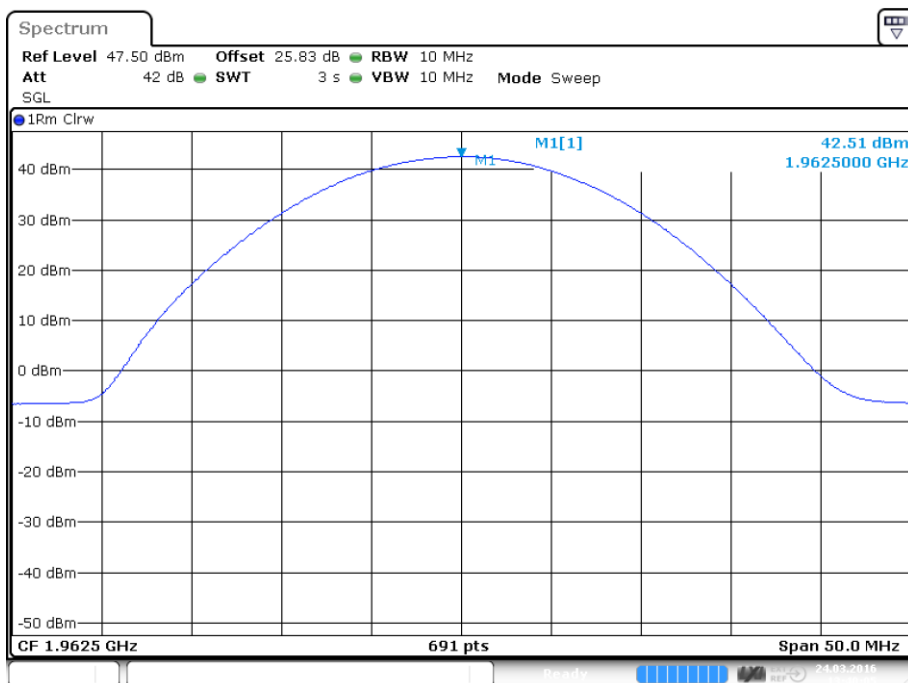

Date: 24.MAR.2016 13:40:05

plot 5.3.1.4-#1 RF Power Out: §24.232, §2.1046; Test Results; Downlink; WCDMA Middle





**5.3.1.5 LTE**

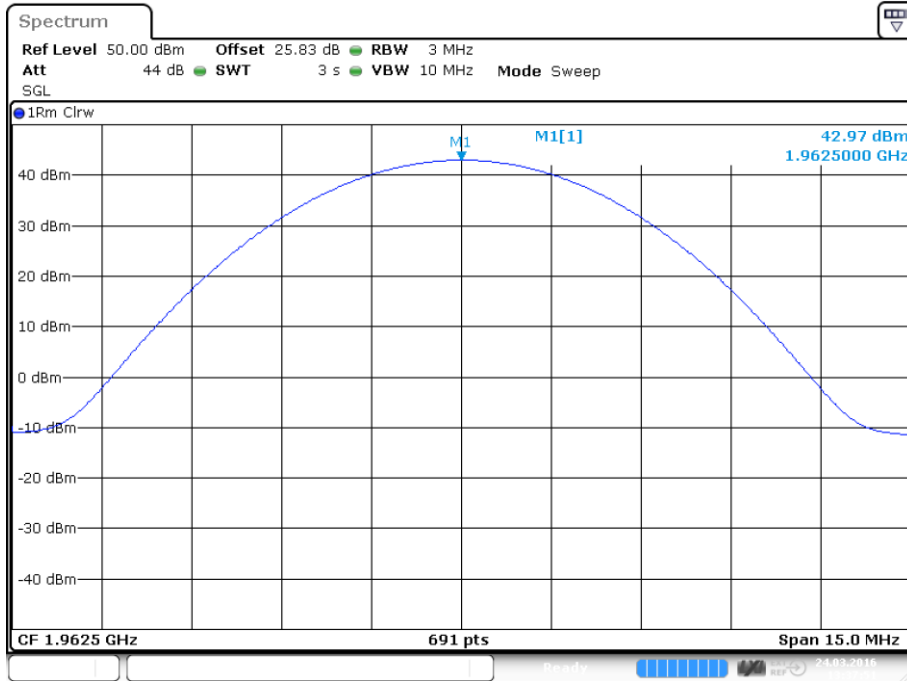

Date: 24.MAR.2016 13:37:51

plot 5.3.1.5-#1 RF Power Out: §24.232, §2.1046; Test Results; Downlink; LTE Middle

**5.3.2 Uplink**

n. a.

Note: The EUT does not transmit over the air in the uplink direction.

**5.4 Summary test result**

Test result	complies, according the plots above
Tested by:	M. Leinfelder
Date:	24.03.2016



## 6 Occupied Bandwidth: §2.1049;

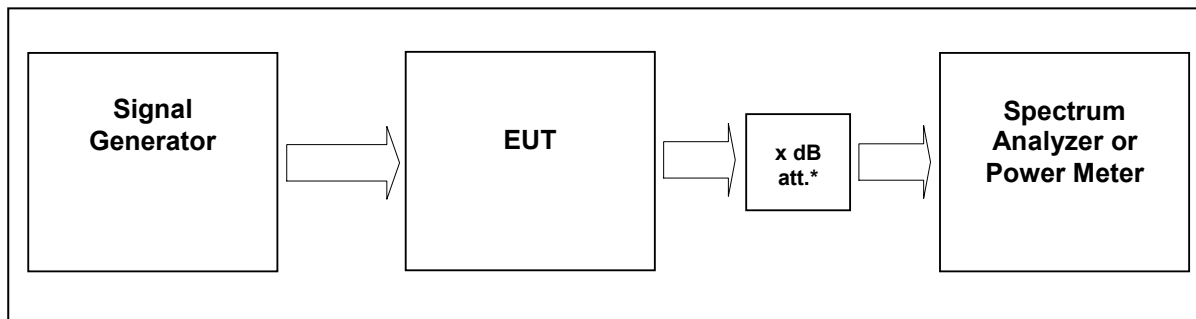

External Attenuator DL      x dB = 20 dB  
figure 6-#1 Test setup: Occupied Bandwidth: §2.1049;

Measurement uncertainty	± 0,38 dB
Test equipment used	9291, 9233, 7444; 7321; 7144; 7454; 7453; 7336; 7449; 7368

### 6.1 Limit

The spectral shape of the output should look similar to input for all modulations.

### 6.2 Test method

Para. No.2.1049

The occupied bandwidth, that is the frequency bandwidth such that, below its lower and above its upper frequency limits, the mean powers radiated are each equal to 0.5 percent of the total mean power radiated by a given emission shall be measured under the following conditions as applicable:



### 6.3 Test results

#### 6.3.1 Downlink

Detector PK.

Modulation	Measured at	Carrier /MHz	RBW VBW Span	Occupied Bandwidth	Plot #
GSM	Middle	1962,5 MHz	3 kHz 30 kHz 1 MHz	186.9 kHz	6.3.1.1 #1, #2
EDGE	Middle	1962,5 MHz	3 kHz 30 kHz 1 MHz	191.9 kHz	6.3.1.2 #1, #2
CDMA	Middle	1962,5 MHz	30 kHz 300 kHz 5 MHz	1.19 MHz	6.3.1.3 #1, #2
WCDMA	Middle	1962,5 MHz	100 kHz 1 MHz 10 MHz	3.79 MHz	6.3.1.4 #1, #2
LTE	Middle	1962,5 MHz	30 kHz 300 kHz 5 MHz	1.05 MHz	6.3.1.5 #1, #2

Modulation	Measured at	Carrier /MHz	RBW VBW Span	26dB Bandwidth	Plot #
GSM	Middle	1962,5 MHz	3 kHz 30 kHz 1 MHz	322.8 kHz	6.3.2.1 #1, #2
EDGE	Middle	1962,5 MHz	3 kHz 30 kHz 1 MHz	309.9 kHz	6.3.2.2 #1, #2
CDMA	Middle	1962,5 MHz	30 kHz 300 kHz 5 MHz	1.42 MHz	6.3.2.3 #1, #2
WCDMA	Middle	1962,5 MHz	100 kHz 1 MHz 10 MHz	4.69 MHz	6.3.2.4 #1, #2
LTE	Middle	1962,5 MHz	30 kHz 300 kHz 5 MHz	1.31 MHz	6.3.2.5 #1, #2

table 6.3-#1 Occupied Bandwidth: §2.1049; Test results



### 6.3.1.1 GSM

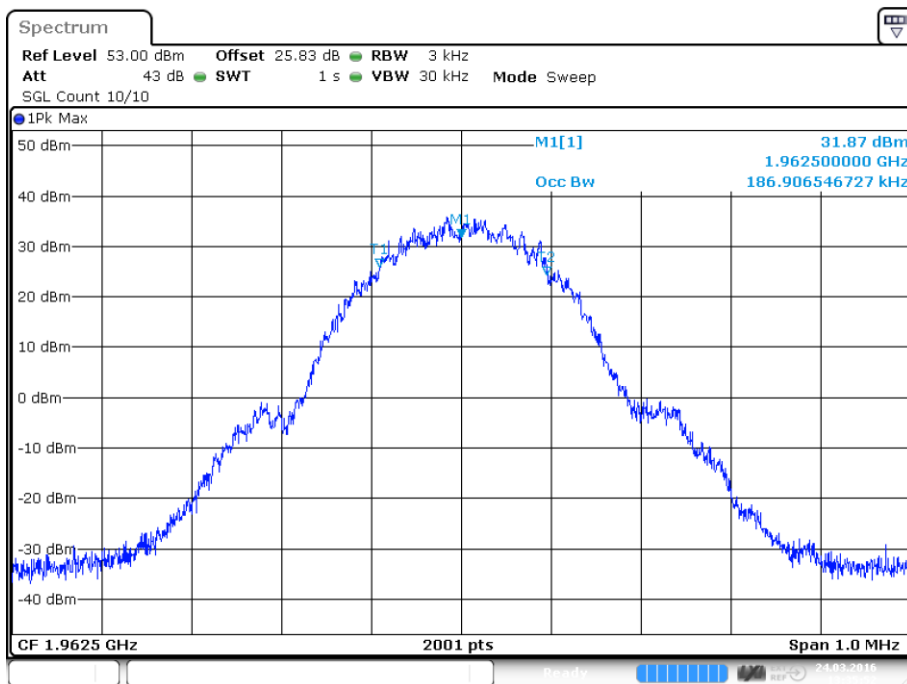

Date: 24.MAR.2016 13:35:52

plot 6.3.1.1-#1 Occupied Bandwidth: \$2.1049;; Test results; Downlink; GSM Output

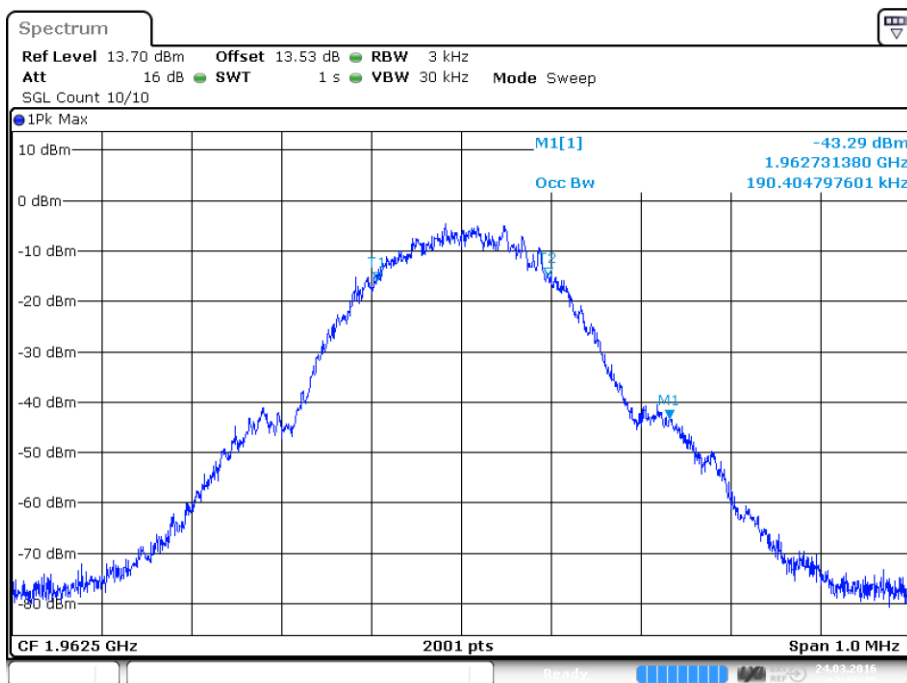

Date: 24.MAR.2016 13:36:16

plot 6.3.1.1-#2 Occupied Bandwidth: \$2.1049;; Test results; Downlink; GSM Input



6.3.1.2 EDGE

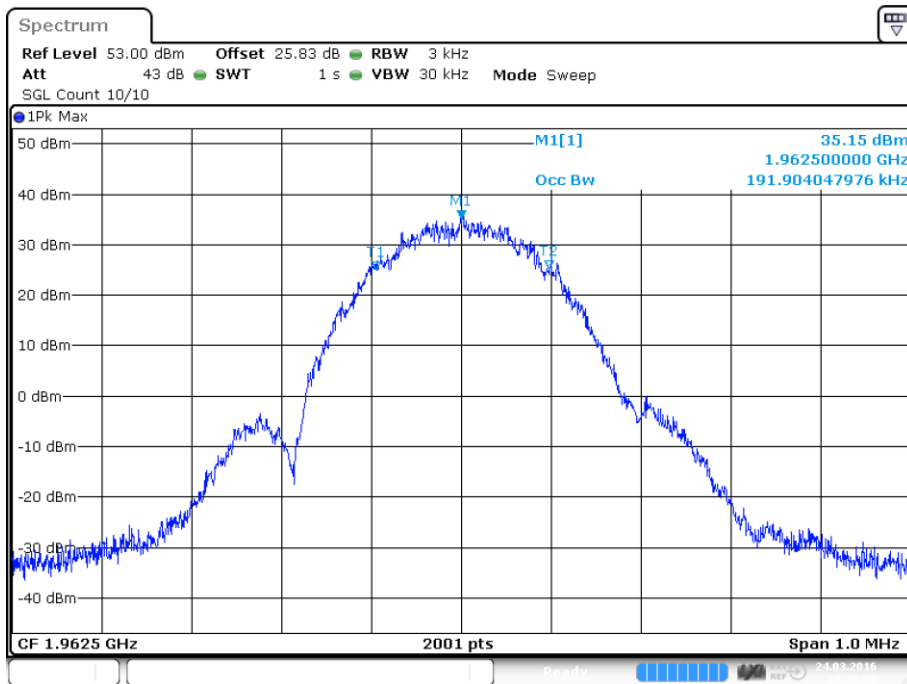

Date: 24.MAR.2016 13:30:09

plot 6.3.1.2-#1 Occupied Bandwidth: \$2.1049;; Test results; Downlink; EDGE Output

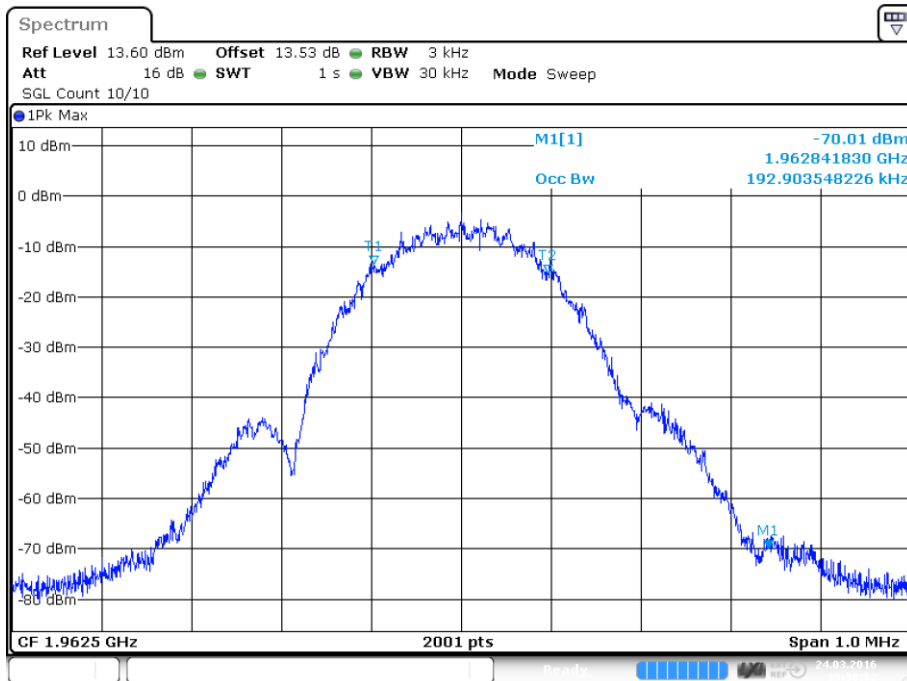

Date: 24.MAR.2016 13:30:32

plot 6.3.1.2-#2 Occupied Bandwidth: \$2.1049;; Test results; Downlink; EDGE Input



### 6.3.1.3 CDMA

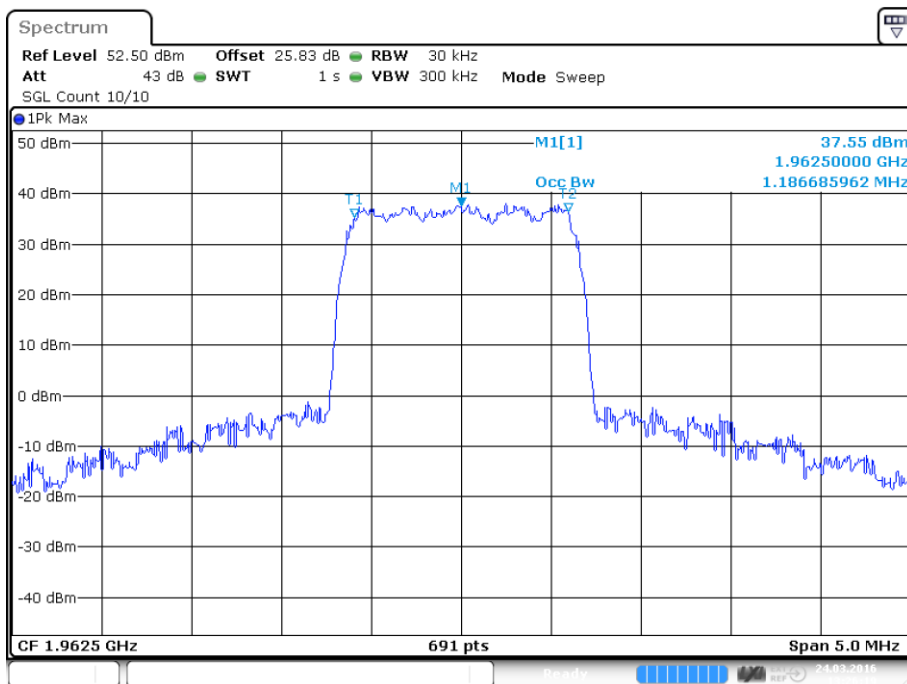

Date: 24.MAR.2016 13:26:20

plot 6.3.1.3-#1 Occupied Bandwidth: \$2.1049;; Test results; Downlink; CDMA Output

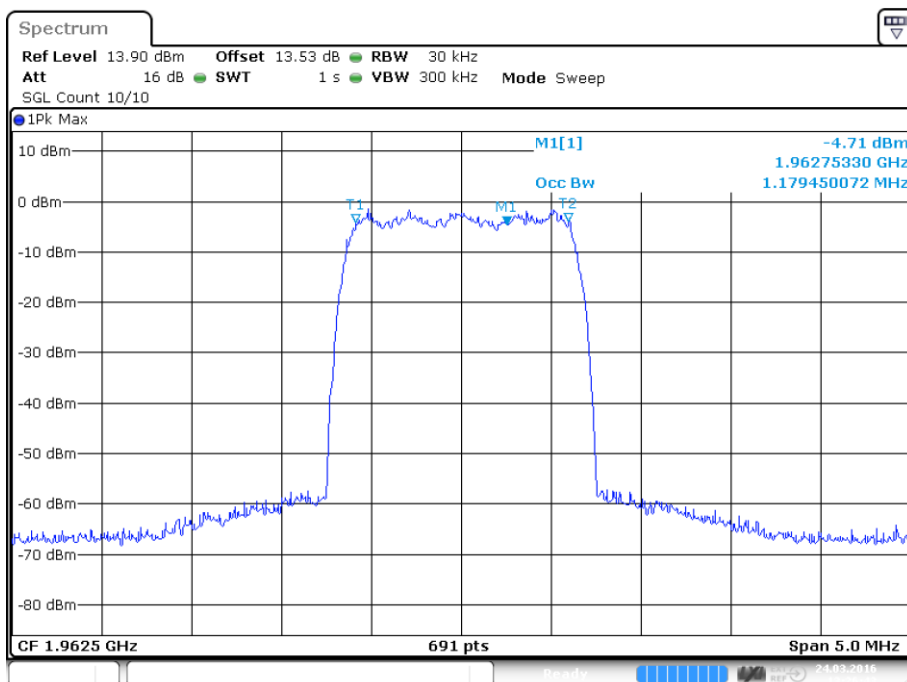

Date: 24.MAR.2016 13:26:43

plot 6.3.1.3-#2 Occupied Bandwidth: \$2.1049;; Test results; Downlink; CDMA Input



6.3.1.4 WCDMA

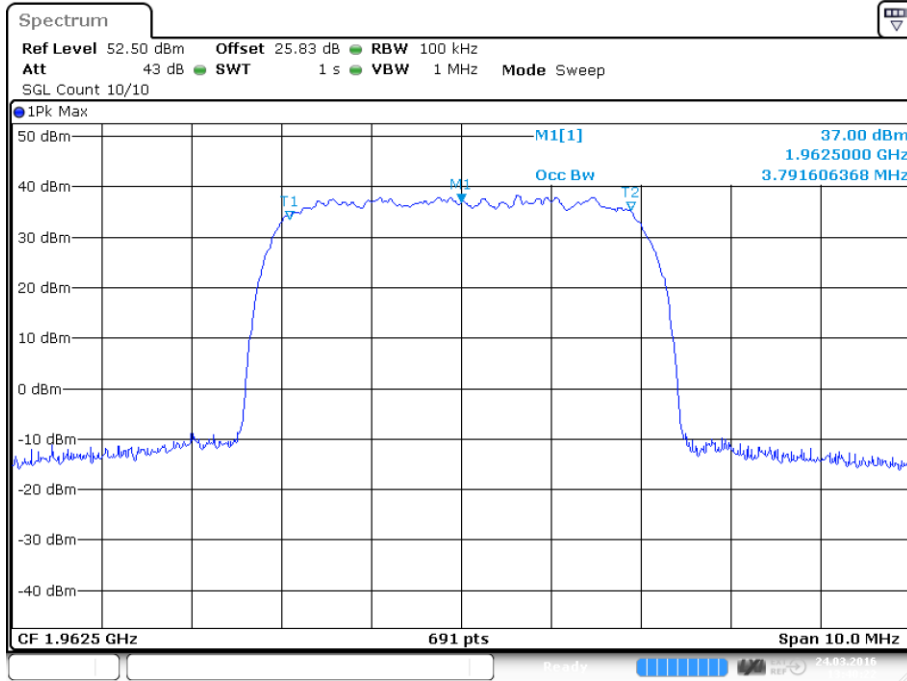

Date: 24.MAR.2016 13:40:22

plot 6.3.1.4-#1 Occupied Bandwidth: \$2.1049;; Test results; Downlink; WCDMA Output

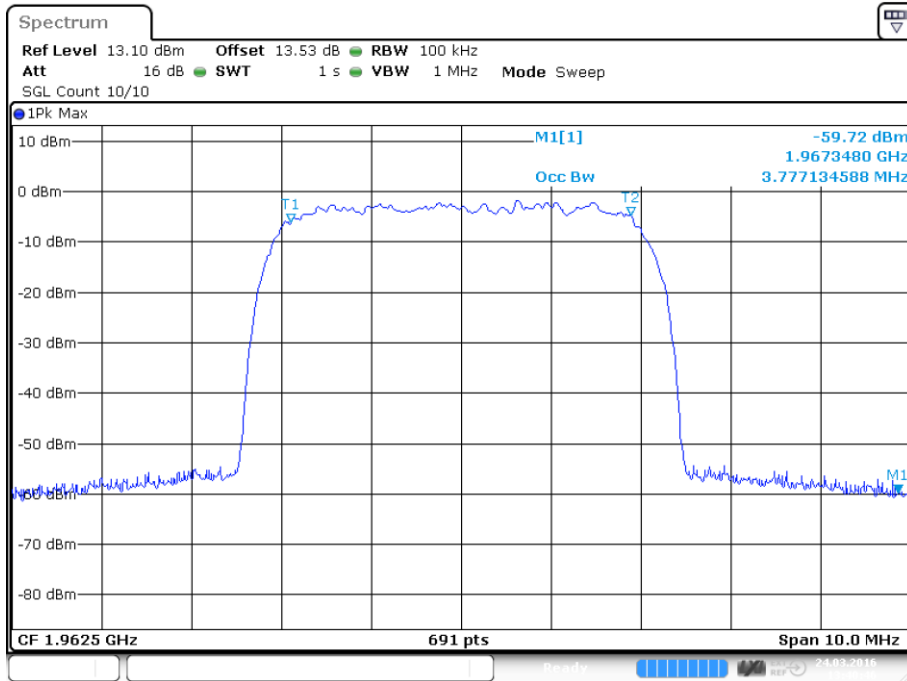

Date: 24.MAR.2016 13:40:46

plot 6.3.1.4-#2 Occupied Bandwidth: \$2.1049;; Test results; Downlink; WCDMA Input



### 6.3.1.5 LTE

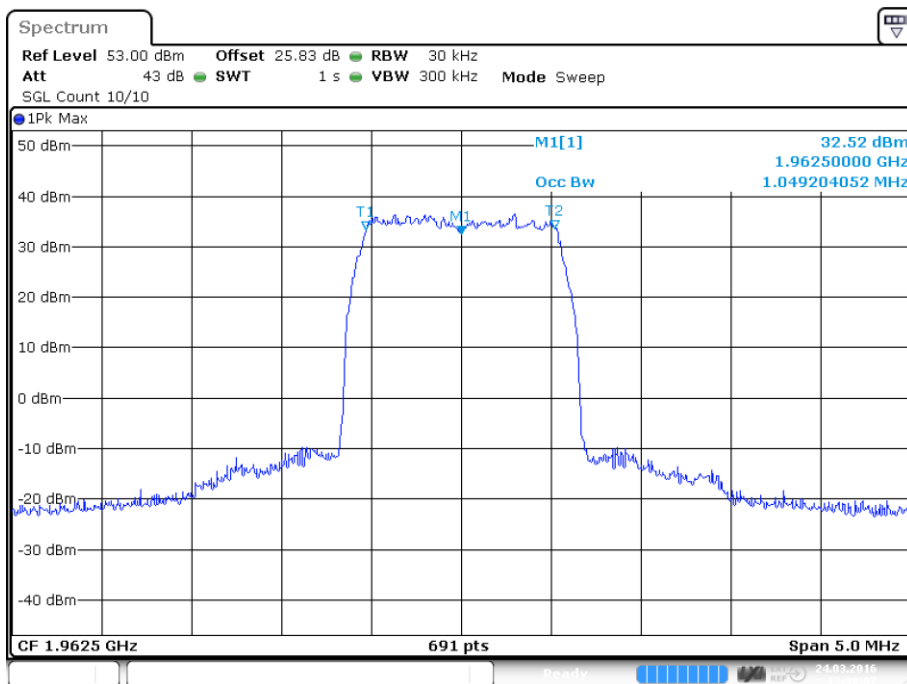

Date: 24.MAR.2016 13:38:07

plot 6.3.1.5-#1 Occupied Bandwidth: \$2.1049\$; Test results; Downlink; LTE Output

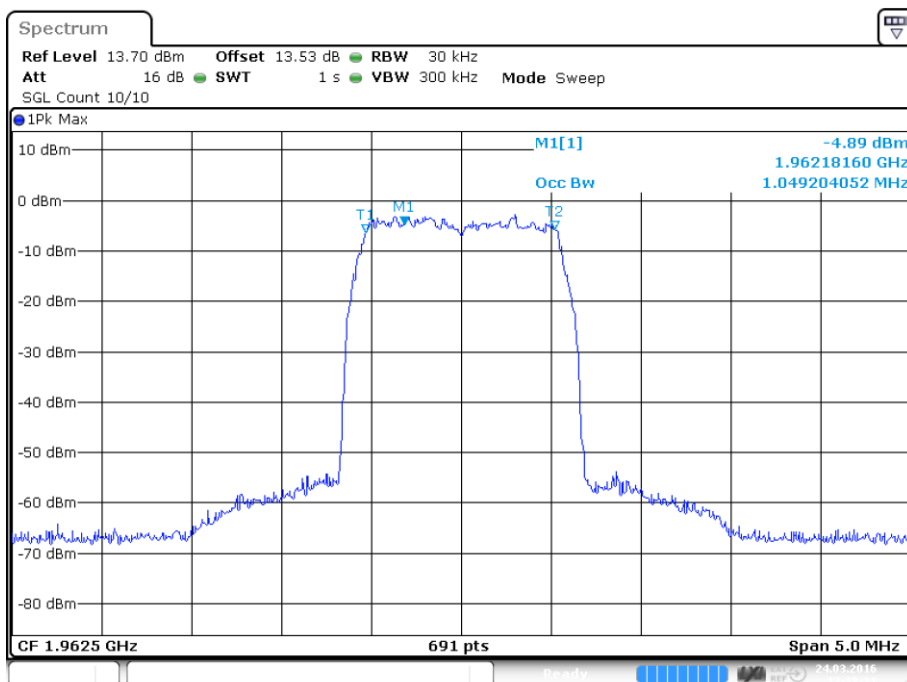

Date: 24.MAR.2016 13:38:31

plot 6.3.1.5-#2 Occupied Bandwidth: \$2.1049\$; Test results; Downlink; LTE Input





6.3.2 26dB Bandwidth

6.3.2.1 GSM

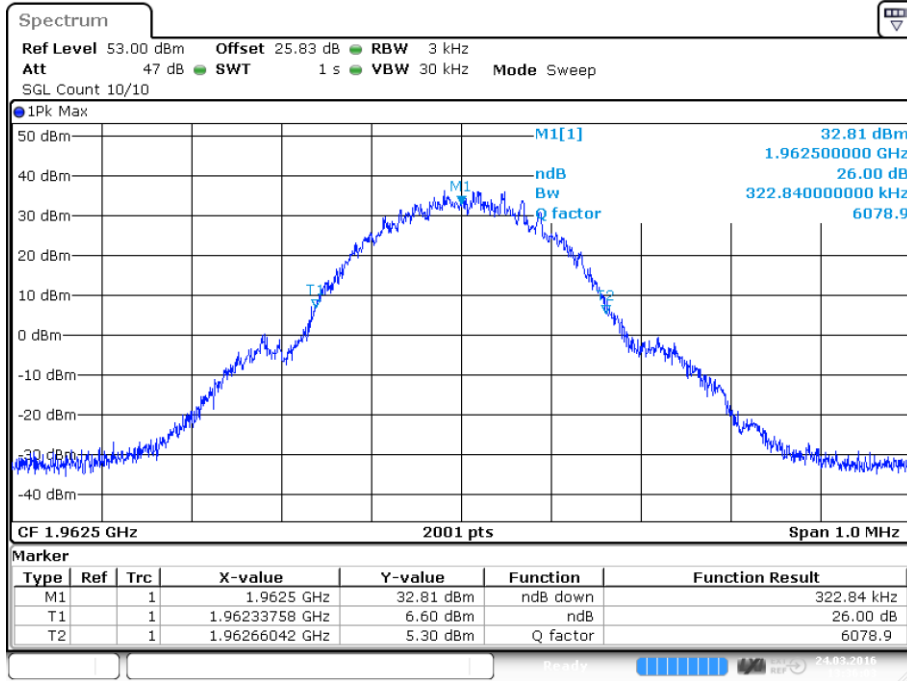

Date: 24.MAR.2016 13:36:03

plot 6.3.2.1-#1 Occupied Bandwidth: \$2.1049;; Test results; 26dB Bandwidth; GSM Output

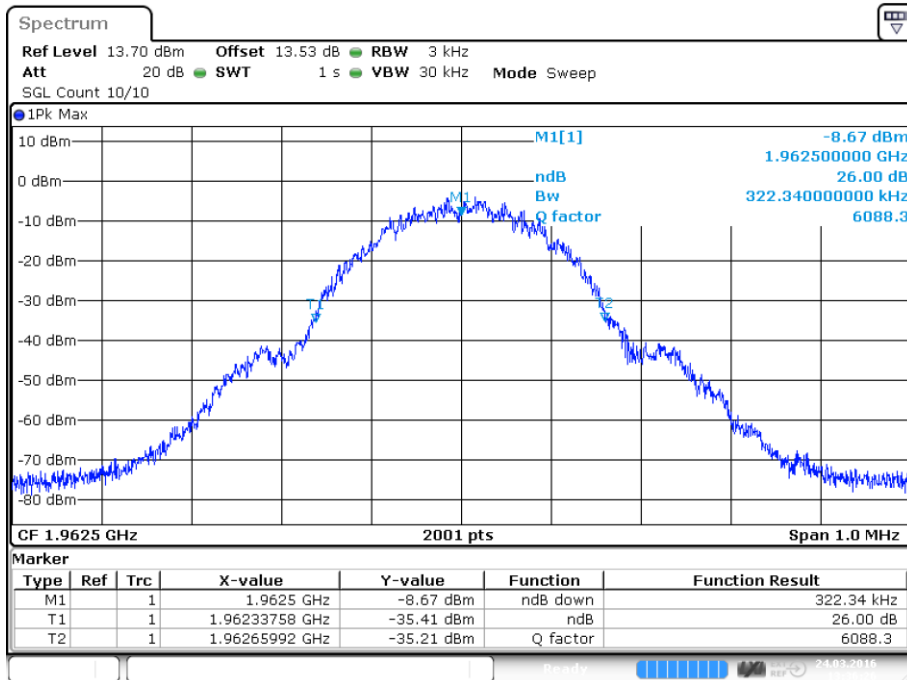

Date: 24.MAR.2016 13:36:27

plot 6.3.2.1-#2 Occupied Bandwidth: \$2.1049;; Test results; 26dB Bandwidth; GSM Input



6.3.2.2 EDGE

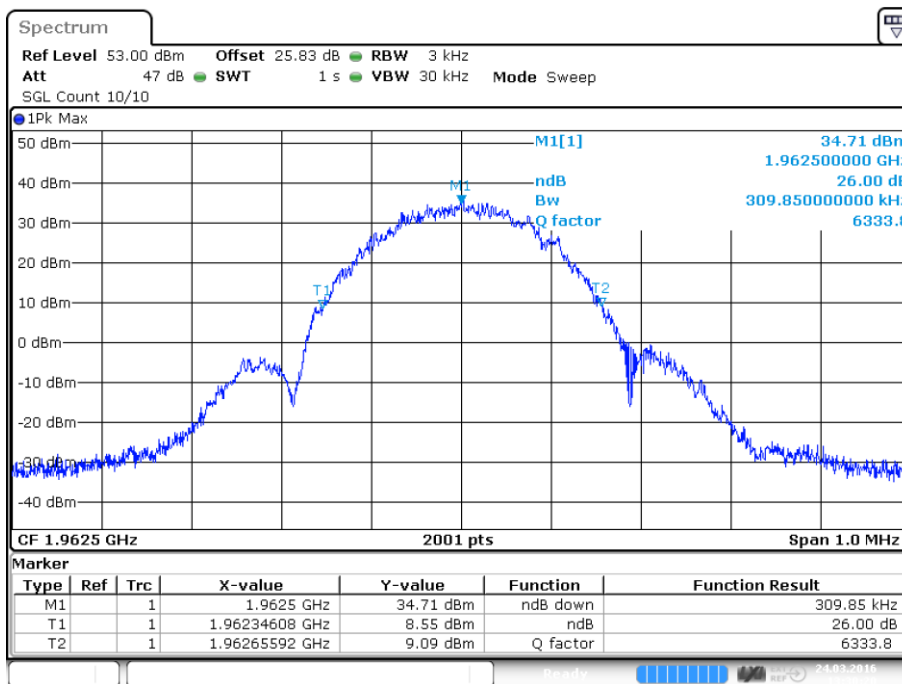

Date: 24.MAR.2016 13:30:20

plot 6.3.2.2-#1 Occupied Bandwidth: \$2.1049;; Test results; 26dB Bandwidth; EDGE Output

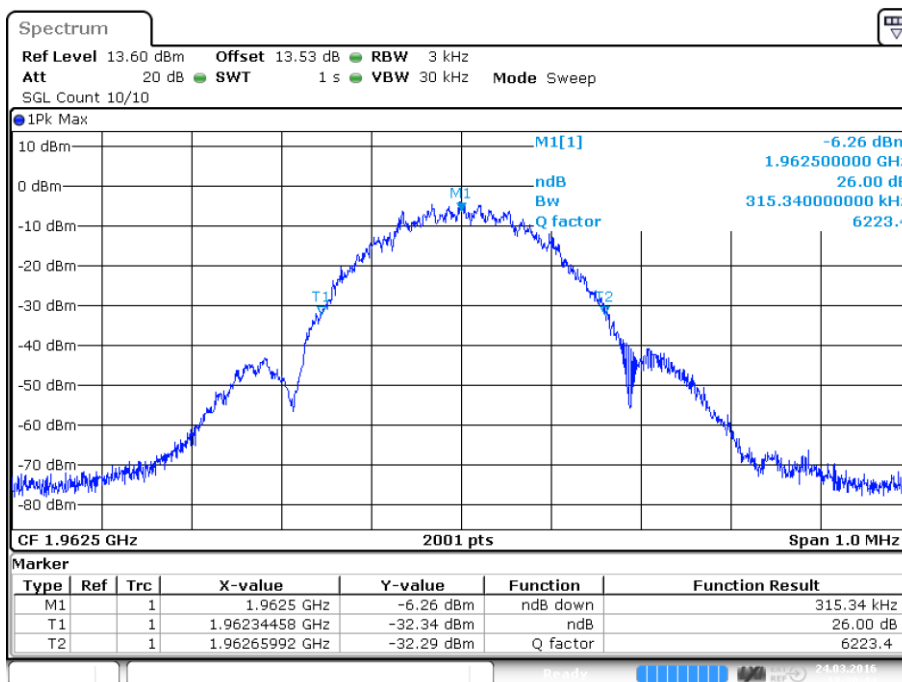

Date: 24.MAR.2016 13:30:43

plot 6.3.2.2-#2 Occupied Bandwidth: \$2.1049;; Test results; 26dB Bandwidth; EDGE Input



6.3.2.3 CDMA

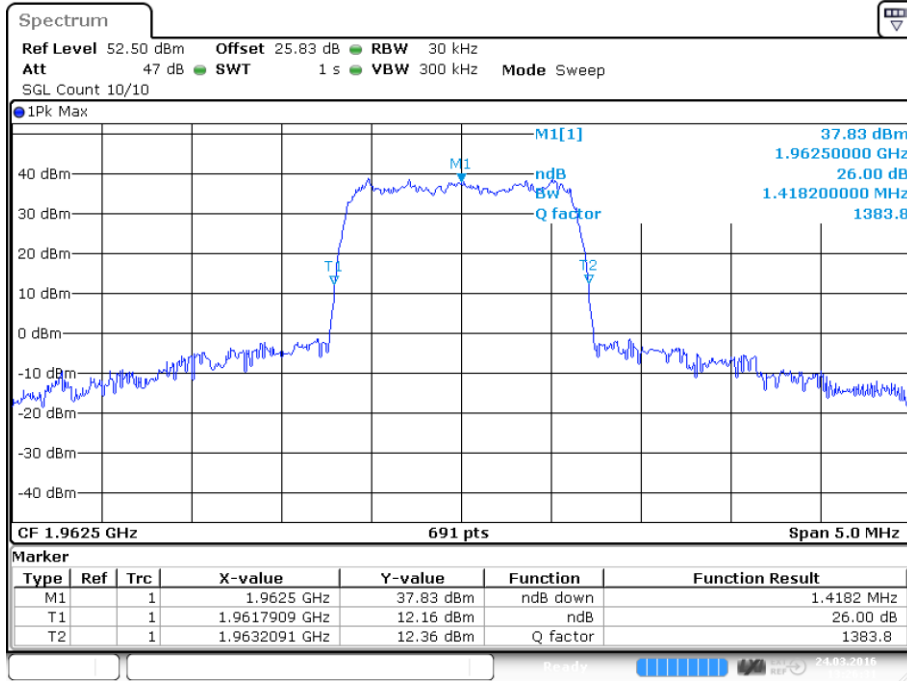

Date: 24.MAR.2016 13:26:31

plot 6.3.2.3-#1 Occupied Bandwidth: \$2.1049; Test results; 26dB Bandwidth; CDMA Output

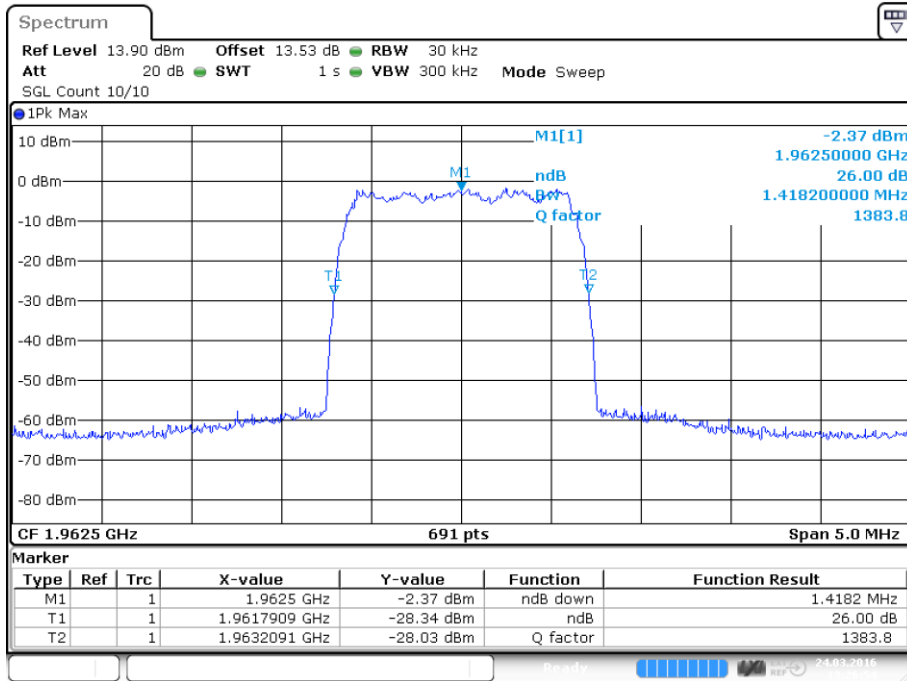

Date: 24.MAR.2016 13:26:55

plot 6.3.2.3-#2 Occupied Bandwidth: \$2.1049; Test results; 26dB Bandwidth; CDMA Input



6.3.2.4 WCDMA

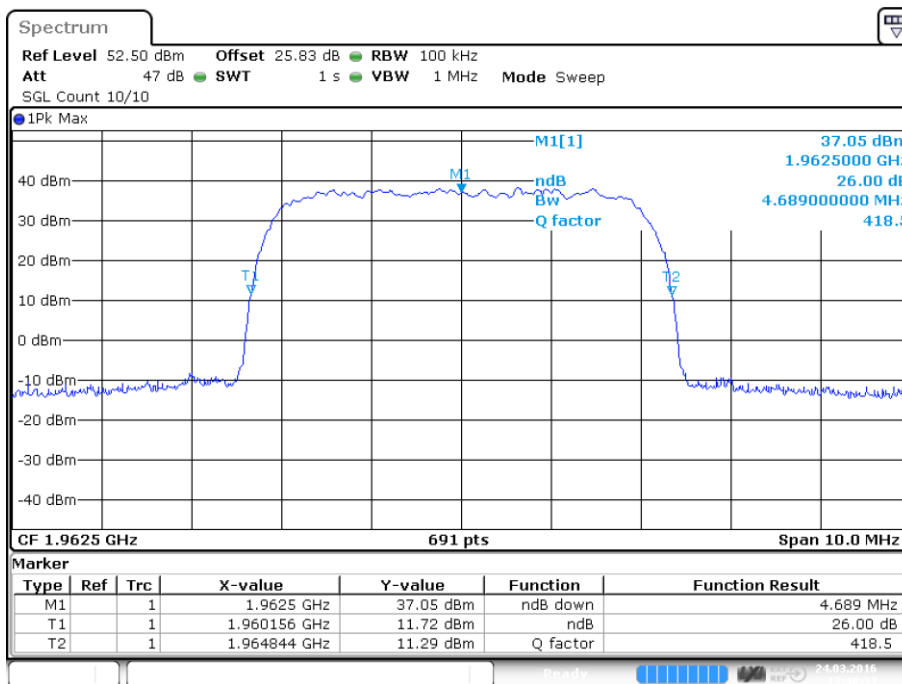

Date: 24.MAR.2016 13:40:33

plot 6.3.2.4-#1 Occupied Bandwidth: \$2.1049;; Test results; 26dB Bandwidth; WCDMA Output

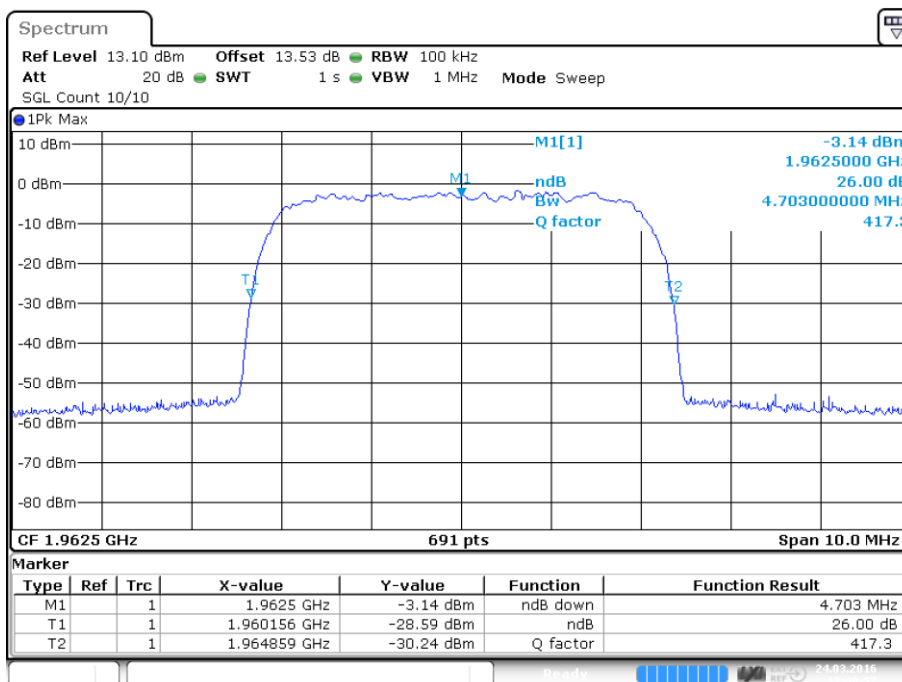

Date: 24.MAR.2016 13:40:57

plot 6.3.2.4-#2 Occupied Bandwidth: \$2.1049;; Test results; 26dB Bandwidth; WCDMA Input



6.3.2.5 LTE

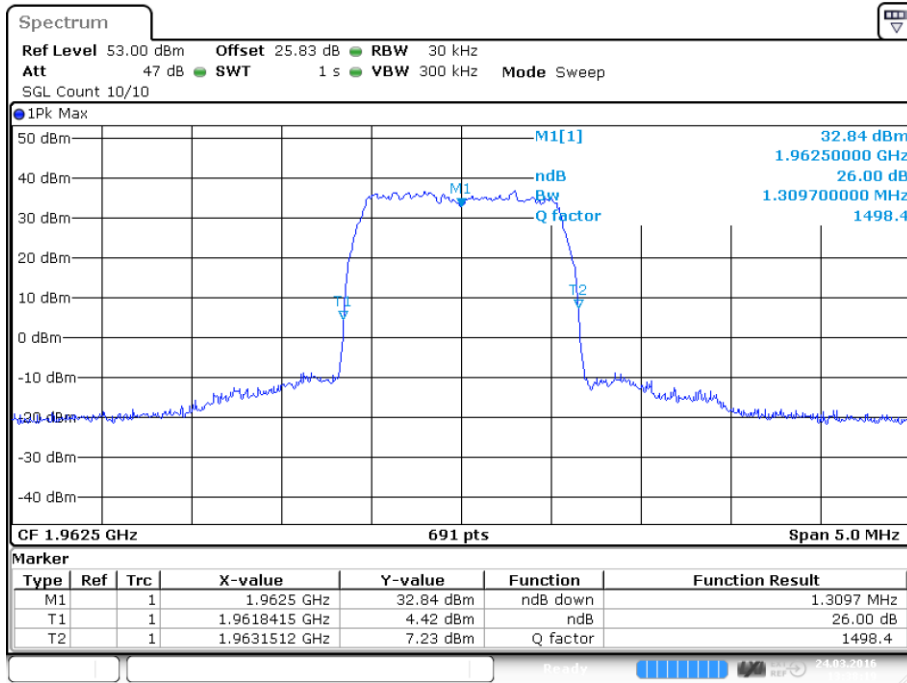

Date: 24.MAR.2016 13:38:19

plot 6.3.2.5-#1 Occupied Bandwidth: \$2.1049;; Test results; 26dB Bandwidth; LTE Output

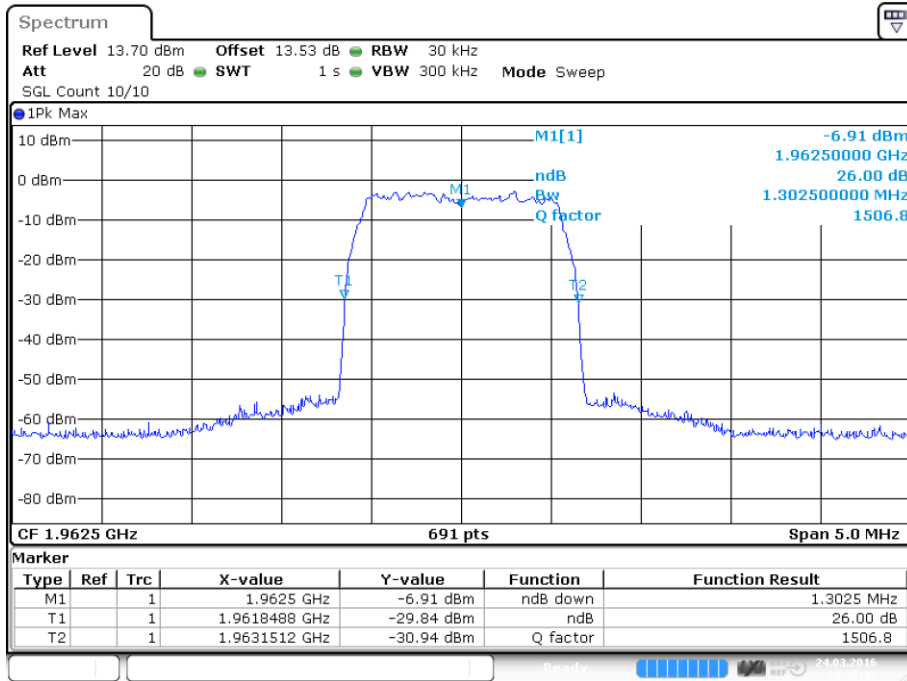

Date: 24.MAR.2016 13:38:43

plot 6.3.2.5-#2 Occupied Bandwidth: \$2.1049;; Test results; 26dB Bandwidth; LTE Input



### 6.3.3 Uplink

n. a.

Note: The EUT does not transmit over the air in the uplink direction.

### 6.4 Summary test result

Test result	complies, according the plots above
Tested by:	M. Leinfelder
Date:	24.03.2016



## 7 Spurious Emissions at Antenna Terminals: §24.238, §2.1051

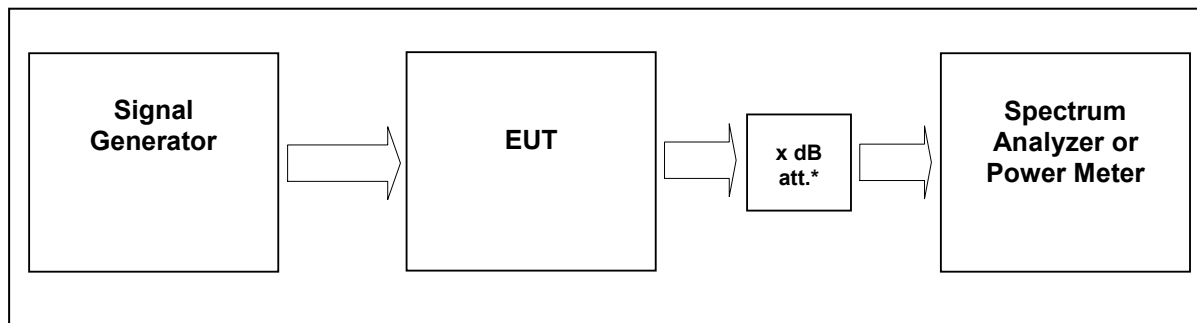

External Attenuator DL x dB = 20 dB  
 figure 7-#1 Test setup: Spurious Emissions at Antenna Terminals: §24.238, §2.1051

Measurement uncertainty	± 0,54 dB ± 1,2 dB ± 1,5 dB	9 kHz to 3 GHz 3 GHz to 7 GHz 7 GHz to 26 GHz
Test equipment used	9291, 9233, 7444; 7321; 7144; 7454; 7453; 7336; 7449; 7368	

### 7.1 Limit

Minimum standard:

Para. No.24.238(a)

The rules in this section govern the spectral characteristics of emissions in the Broadband Personal Communications Service.

(a) Out of band emissions. The power of any emission outside of the authorized operating frequency ranges must be attenuated below the transmitting power (P) by a factor of at least  $43 + 10 \log(P)$  dB.

### 7.2 Test method

Para. No 2.1051 Measurements required: Spurious emissions at antenna terminals.

The radio frequency voltage or powers generated within the equipment and appearing on a spurious frequency shall be checked at the equipment output terminals when properly loaded with a suitable artificial antenna. Curves or equivalent data shall show the magnitude of each harmonic and other spurious emission that can be detected when the equipment is operated under the conditions specified in § 2.1049 as appropriate. The magnitude of spurious emissions which are attenuated more than 20 dB below the permissible value need not be specified.

[39 FR 5919, Feb. 15, 1974. Redesignated and amended at 63 FR 36599, July 7, 1998]



### 7.3 Test results

#### 7.3.1 Downlink

Detector: RMS.

Modulation	Carrier	RBW VBW Span	Max. level (dBm)	Plot -
GSM	1962.5 MHz	1MHz 3MHz 30MHz – 23GHz	-24.5	7.3.1.1 #1
EDGE	1962.5 MHz	1MHz 3MHz 30MHz – 23GHz	-24.2	7.3.1.2 #1
CDMA	1962.5 MHz	1MHz 3MHz 30MHz – 23GHz	-23.6	7.3.1.3 #1
WCDMA	1962.5 MHz	1MHz 3MHz 30MHz – 23GHz	-23.6	7.3.1.4 #1
LTE	1962.5 MHz	1MHz 3MHz 30MHz – 23GHz	-23.3	7.3.1.5 #1

table 7.3-#1 Spurious Emissions at Antenna Terminals: §24.238, §2.1051 Test results

#### 7.3.1.1 GSM

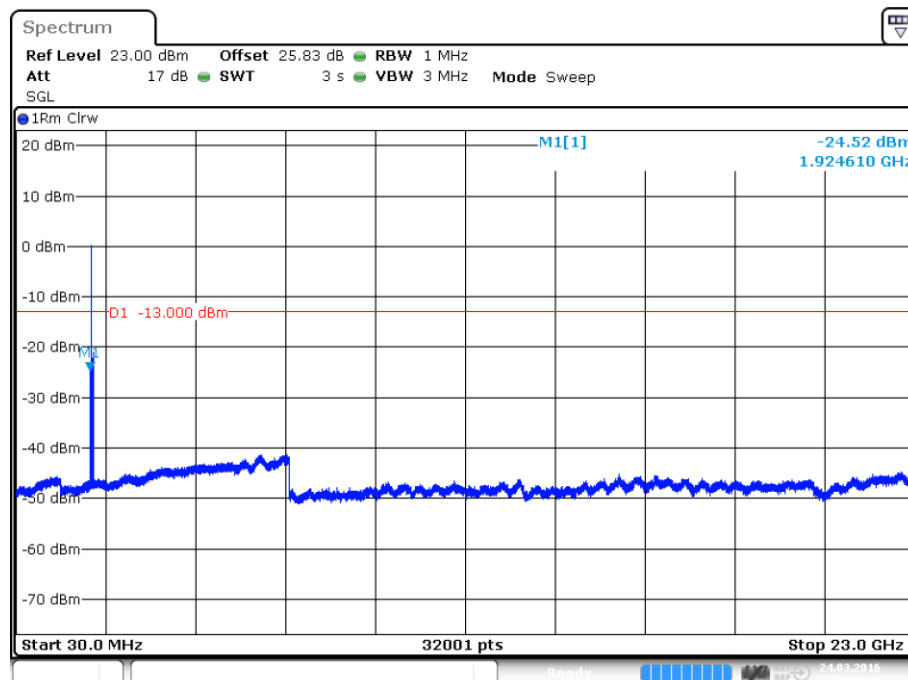

Date: 24.MAR.2016 13:36:33

plot 7.3.1.1-#1 Spurious Emissions at Antenna Terminals: §24.238, §2.1051; Test results; Downlink; GSM; carrier (1962.5 MHz) notched





### 7.3.1.2 EDGE

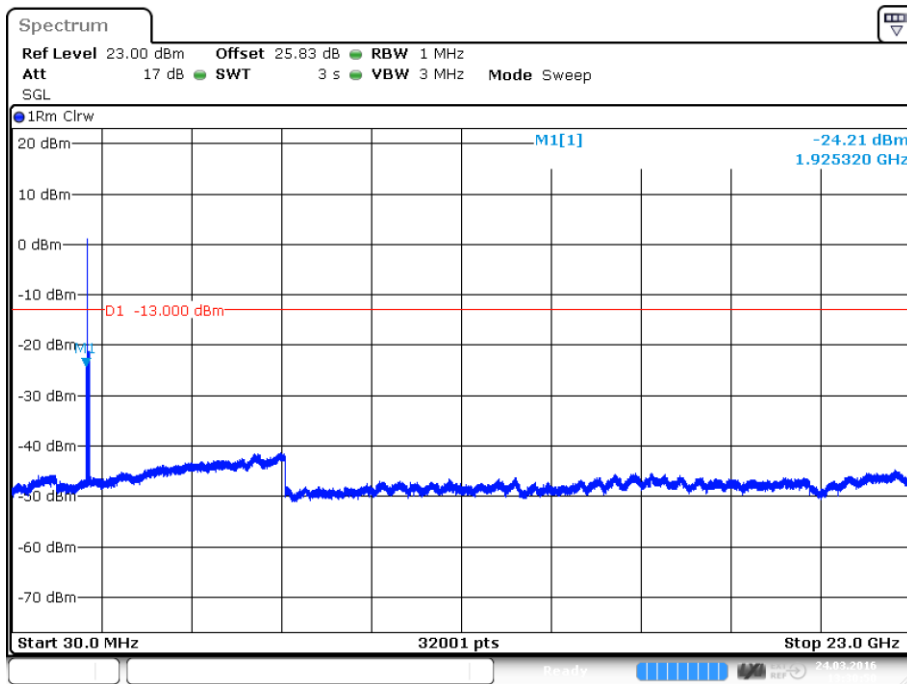

Date: 24.MAR.2016 13:30:50

plot 7.3.1.2-#1 Spurious Emissions at Antenna Terminals: §24.238, §2.1051; Test results; Downlink; EDGE; carrier (1962.5 MHz) notched

### 7.3.1.3 CDMA

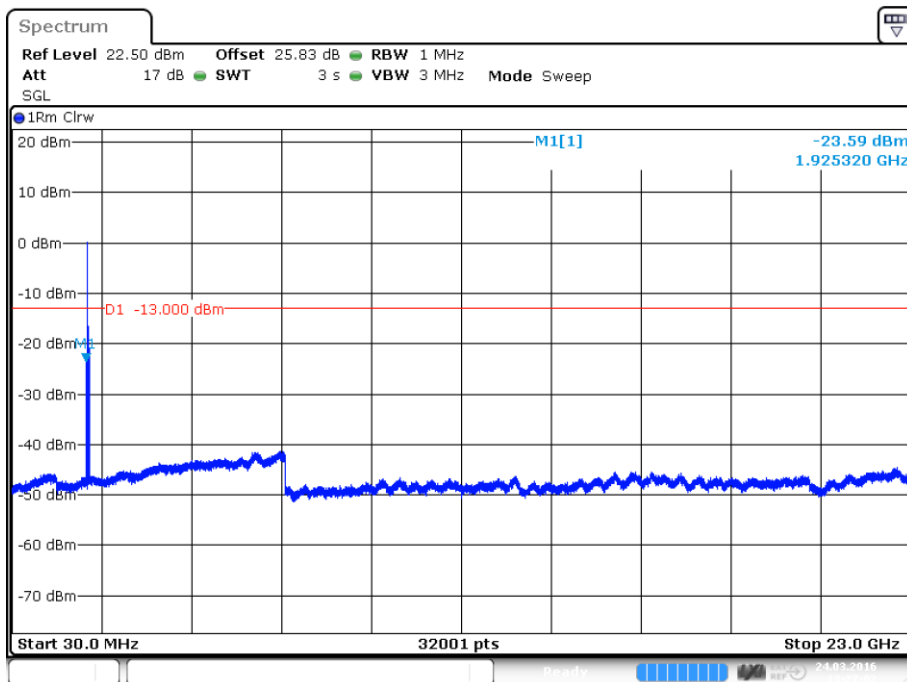

Date: 24.MAR.2016 13:27:02

plot 7.3.1.3-#1 Spurious Emissions at Antenna Terminals: §24.238, §2.1051; Test results; Downlink; CDMA; carrier (1962.5 MHz) notched



### 7.3.1.4 WCDMA

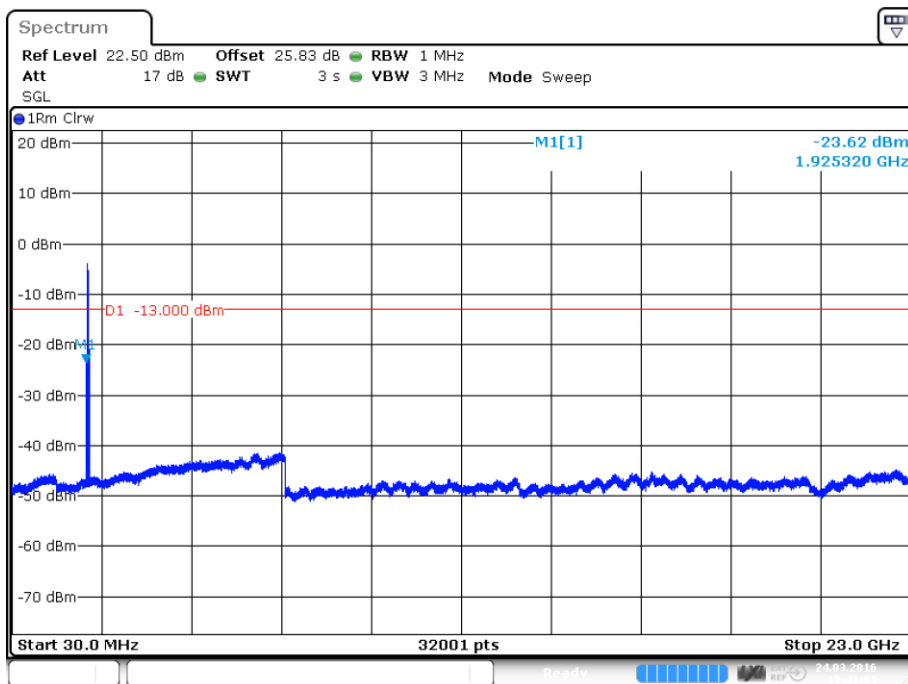

Date: 24.MAR.2016 13:41:04

plot 7.3.1.4-#1 Spurious Emissions at Antenna Terminals: §24.238, §2.1051; Test results; Downlink; WCDMA; carrier (1962.5 MHz) notched

### 7.3.1.5 LTE

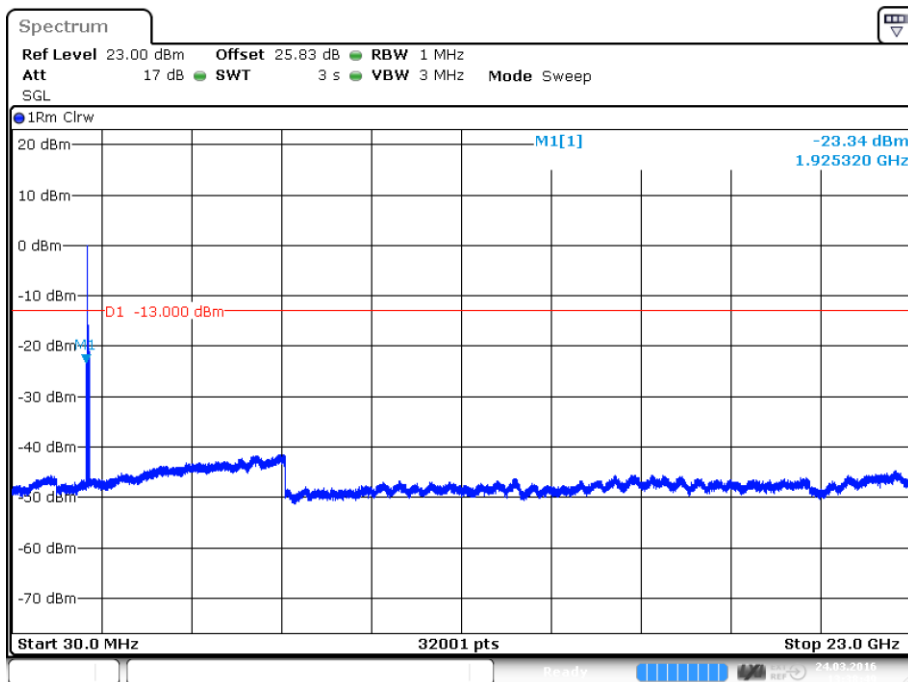

Date: 24.MAR.2016 13:38:49

plot 7.3.1.5-#1 Spurious Emissions at Antenna Terminals: §24.238, §2.1051; Test results; Downlink; LTE; carrier (1962.5 MHz) notched

Test Report No.: 16-094

FCC ID: XS5-M78517E19P



**BUREAU  
VERITAS**

### 7.3.2 Uplink

n. a.

Note: The EUT does not transmit over the air in the uplink direction.

### 7.4 Summary test result

Test result	complies, according the plots above
Tested by:	M. Leinfelder
Date:	24.03.2016



## 8 Intermodulation: §24.238, §2.1051

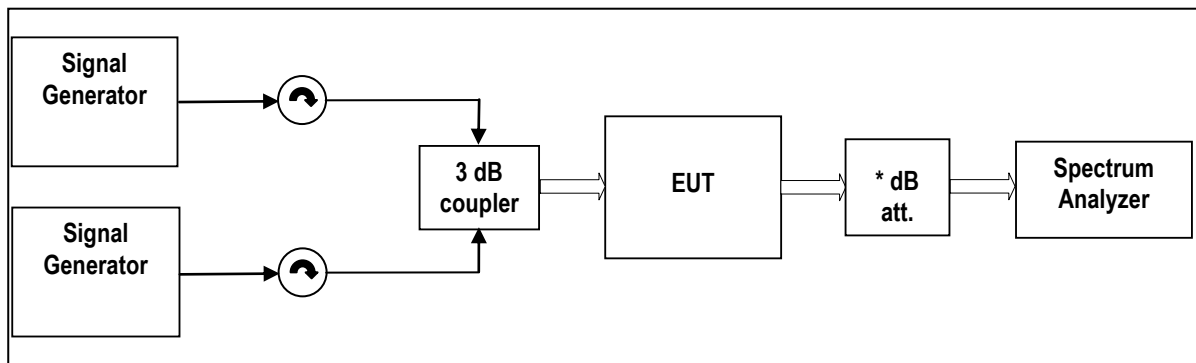

External Attenuator DL x dB = 20 dB  
figure 8-#1 Test setup: Intermodulation: §24.238, §2.1051

Measurement uncertainty	± 0,54 dB ± 1,2 dB ± 1,5 dB	9 kHz to 3 GHz 3 GHz to 7 GHz 7 GHz to 26 GHz
Test equipment used	9291, 8849; 9233, 7444; 7321; 7326; 7144; 7454; 7453; 7336; 7449; 7368	

### 8.1 Limit

Minimum standard:

Para. No.24.238(a)

The rules in this section govern the spectral characteristics of emissions in the Broadband Personal Communications Service.

(a) Out of band emissions. The power of any emission outside of the authorized operating frequency ranges must be attenuated below the transmitting power (P) by a factor of at least  $43 + 10 \log(P)$  dB.

### 8.2 Test method

Para. No 2.1051 Measurements required: Spurious emissions at antenna terminals.

The radio frequency voltage or powers generated within the equipment and appearing on a spurious frequency shall be checked at the equipment output terminals when properly loaded with a suitable artificial antenna. Curves or equivalent data shall show the magnitude of each harmonic and other spurious emission that can be detected when the equipment is operated under the conditions specified in § 2.1049 as appropriate. The magnitude of spurious emissions which are attenuated more than 20 dB below the permissible value need not be specified.

[39 FR 5919, Feb. 15, 1974. Redesignated and amended at 63 FR 36599, July 7, 1998]



### 8.3 Test results

#### 8.3.1 Downlink

Detector: RMS.

Modulation	Measured at Band Edge	Carriers	RBW VBW Span	Max. level (dBm)	Plot -
GSM	Lower Edge	1930,4 MHz 1930,6 MHz	3kHz 30kHz 2MHz	--33.1	8.3.1.1 #1
	Upper Edge	1994,4 MHz 1994,6 MHz			#2
EDGE	Lower Edge	1930,4 MHz 1930,6 MHz	3kHz 30kHz 2MHz	-33.2	8.3.1.2 #1
	Upper Edge	1994,4 MHz 1994,6 MHz			#2
CDMA	Lower Edge	1930,775 MHz 1932,025 MHz	30kHz 300kHz 6MHz	-21.2	8.3.1.3 #1
	Upper Edge	1992,975 MHz 1994,225 MHz			#2
WCDMA	Lower Edge	1932,6 MHz 1937,6 MHz	100kHz 1MHz 15MHz	-24.1	8.3.1.4 #1
	Upper Edge	1987,4 MHz 1992,4 MHz			#2
LTE	Lower Edge	1930.7 MHz 1932.1 MHz	30kHz 300kHz 6MHz	-21.9	8.3.1.5 #1
	Upper Edge	1992.9 MHz 1994.3 MHz			#2

table 8.3-#1 Intermodulation: §24.238, §2.1051 Test results



### 8.3.1.1 GSM

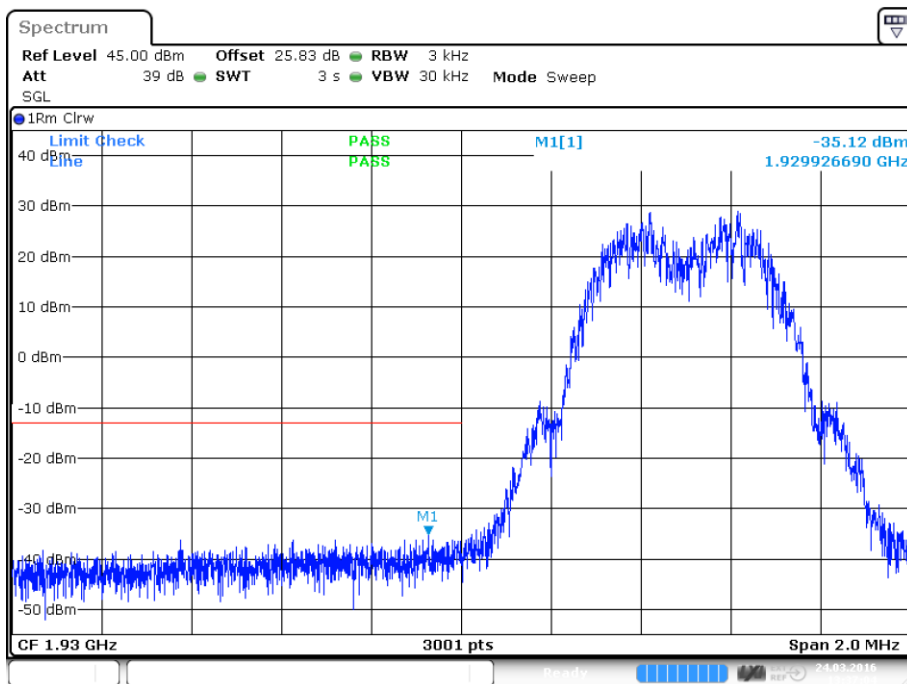

Date: 24.MAR.2016 13:37:04

plot 8.3.1.1-#1 Intermodulation: §24.238, §2.1051; Test results; Downlink; GSM Lower Band Edge

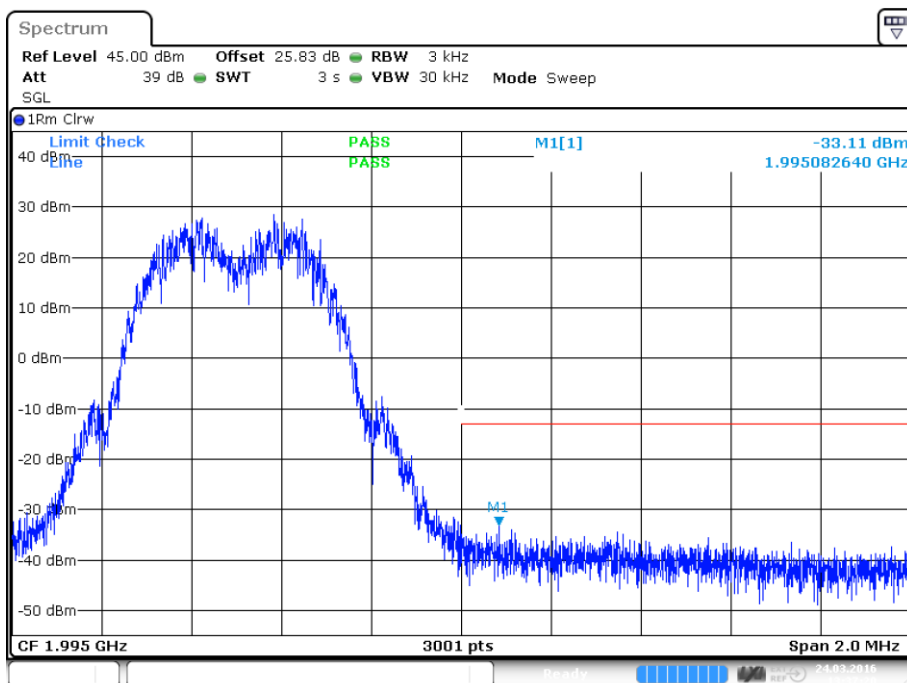

Date: 24.MAR.2016 13:37:20

plot 8.3.1.1-#2 Intermodulation: §24.238, §2.1051; Test results; Downlink; GSM Upper Band Edge



### 8.3.1.2 EDGE

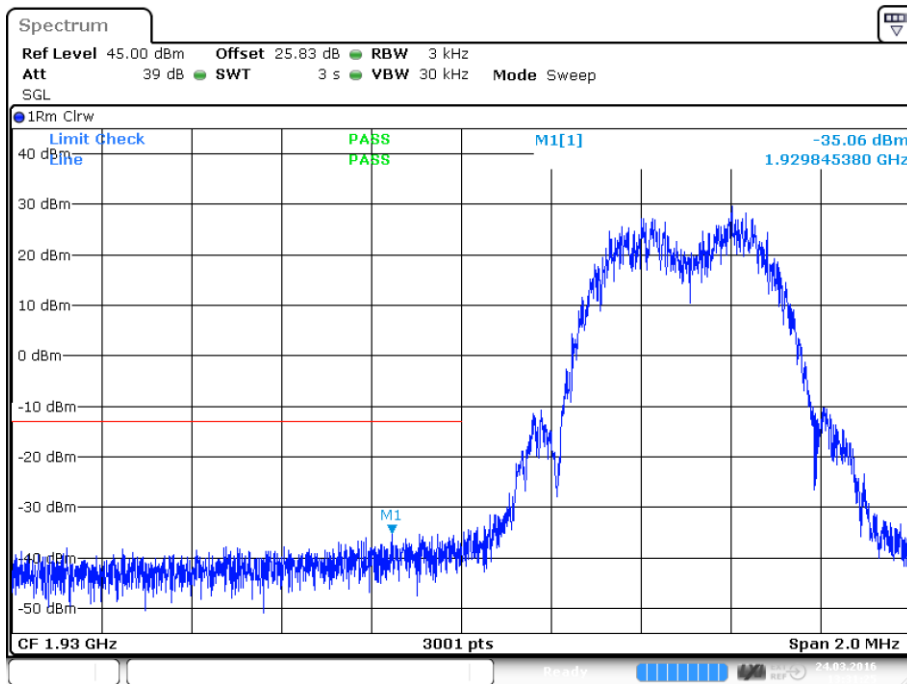

Date: 24.MAR.2016 13:31:26

plot 8.3.1.2-#1 Intermodulation: §24.238, §2.1051; Test results; Downlink; EDGE Lower Band Edge

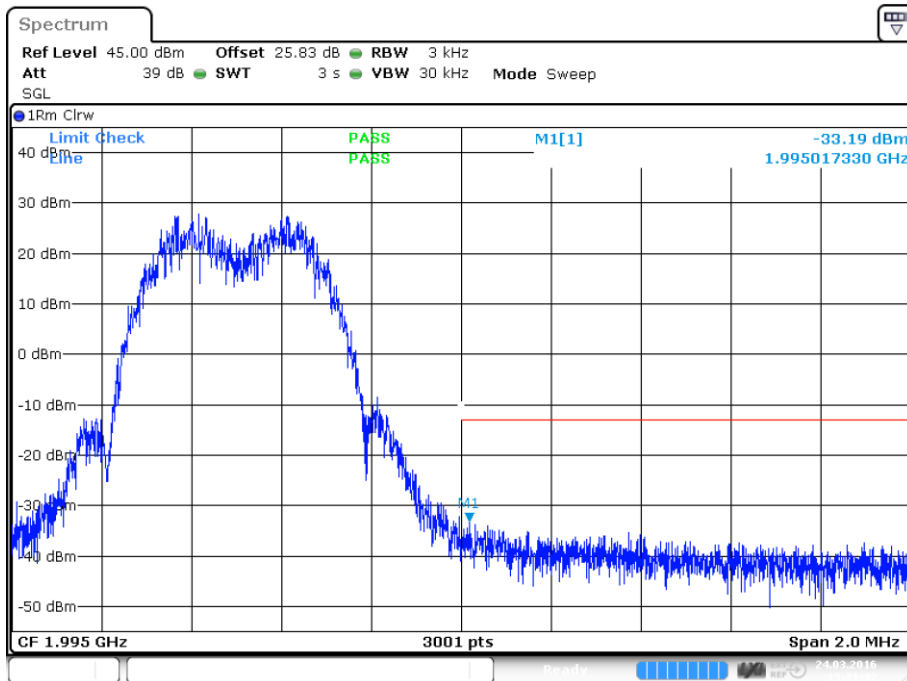

Date: 24.MAR.2016 13:31:42

plot 8.3.1.2-#2 Intermodulation: §24.238, §2.1051; Test results; Downlink; EDGE Upper Band Edge



### 8.3.1.3 CDMA

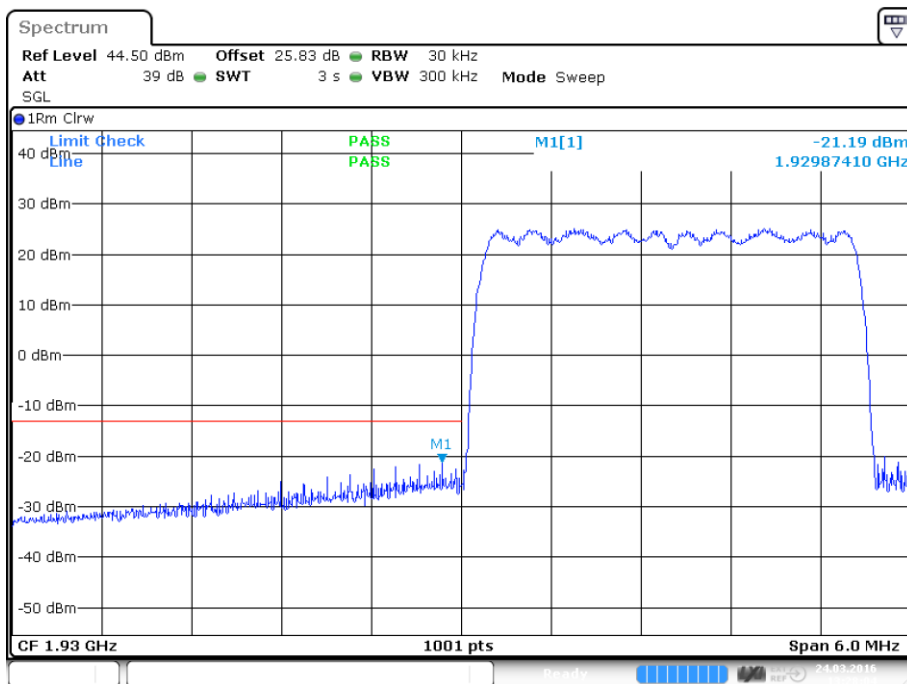

Date: 24.MAR.2016 13:28:05

plot 8.3.1.3-#1 Intermodulation: §24.238, §2.1051; Test results; Downlink; CDMA Lower Band Edge

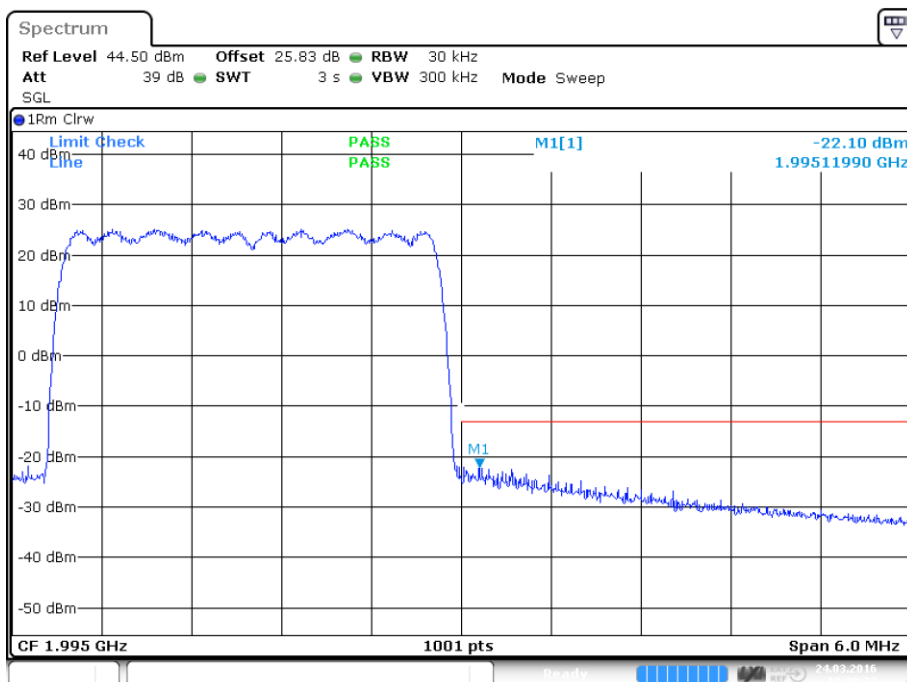

Date: 24.MAR.2016 13:28:21

plot 8.3.1.3-#2 Intermodulation: §24.238, §2.1051; Test results; Downlink; CDMA Upper Band Edge





### 8.3.1.4 WCDMA

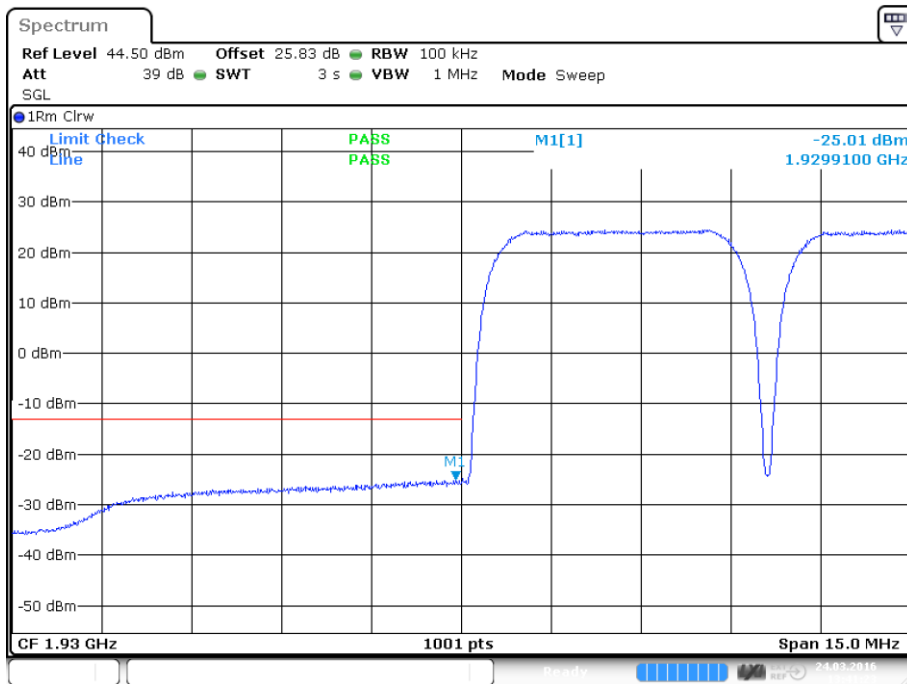

Date: 24.MAR.2016 13:41:24

plot 8.3.1.4-#1 Intermodulation: §24.238, §2.1051; Test results; Downlink; WCDMA Lower Band Edge

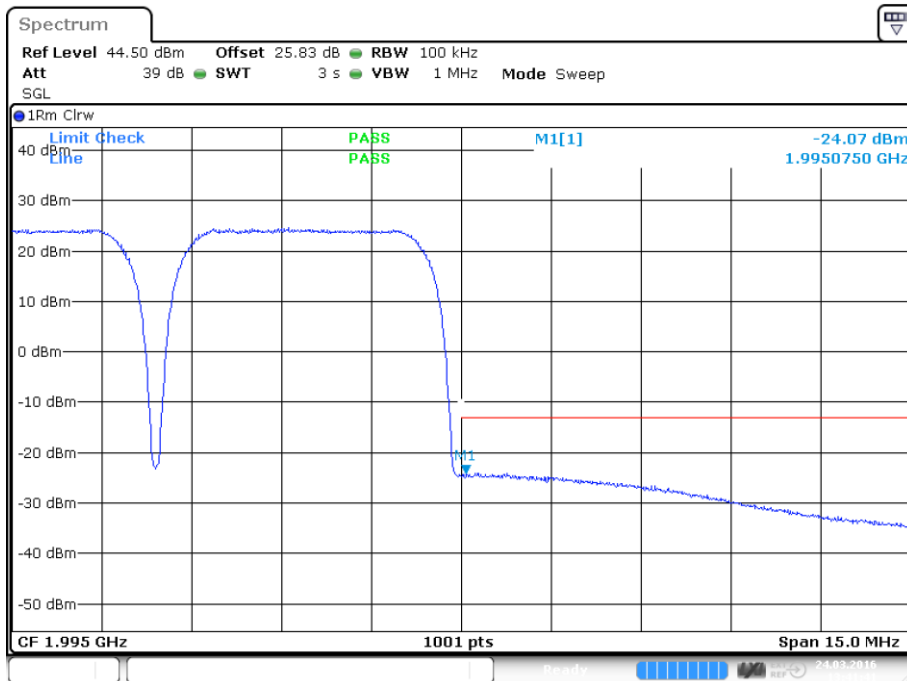

Date: 24.MAR.2016 13:41:41

plot 8.3.1.4-#2 Intermodulation: §24.238, §2.1051; Test results; Downlink; WCDMA Upper Band Edge



### 8.3.1.5 LTE

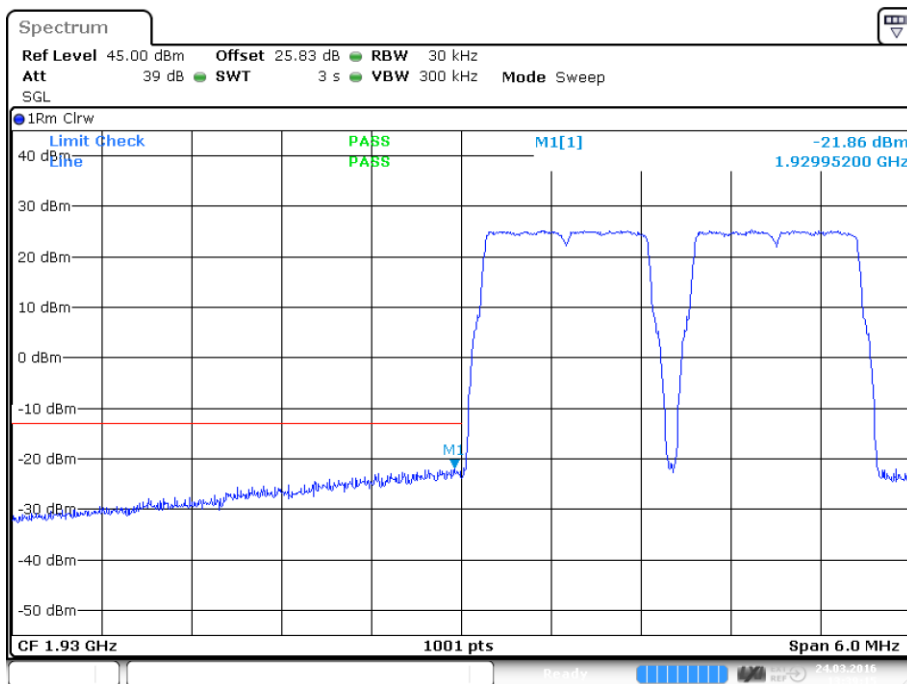

Date: 24.MAR.2016 13:39:15

plot 8.3.1.5-#1 Intermodulation: §24.238, §2.1051; Test results; Downlink; LTE Lower Band Edge

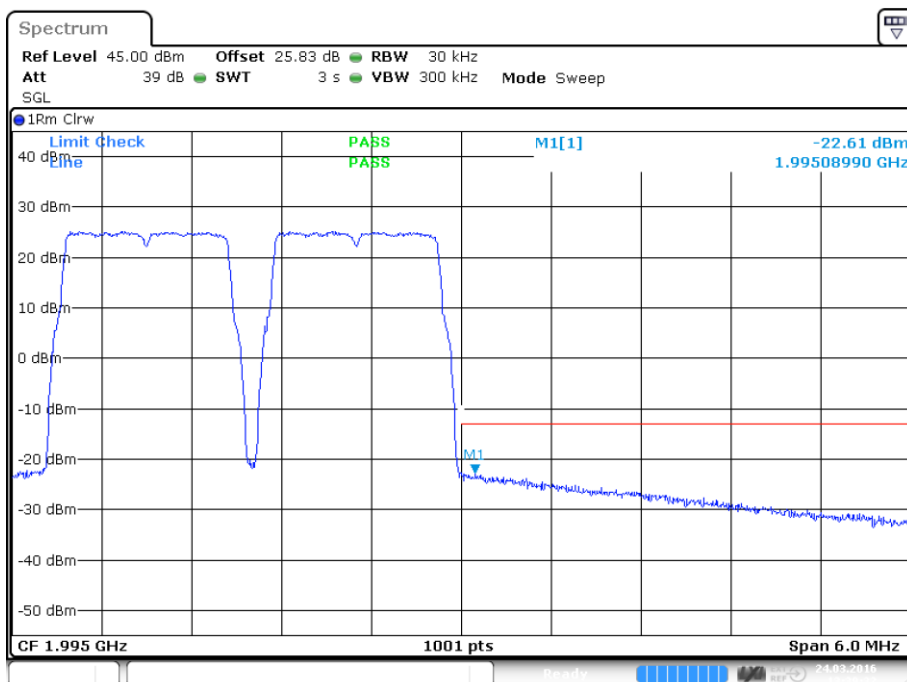

Date: 24.MAR.2016 13:39:32

plot 8.3.1.5-#2 Intermodulation: §24.238, §2.1051; Test results; Downlink; LTE Upper Band Edge

Test Report No.: 16-094

FCC ID: XS5-M78517E19P



**BUREAU  
VERITAS**

### 8.3.2 Uplink

n. a.

Note: The EUT does not transmit over the air in the uplink direction.

### 8.4 Summary test result

Test result	complies, according the plots above
Tested by:	M. Leinfelder
Date:	24.03.2016



## 9 Out of Band Rejection

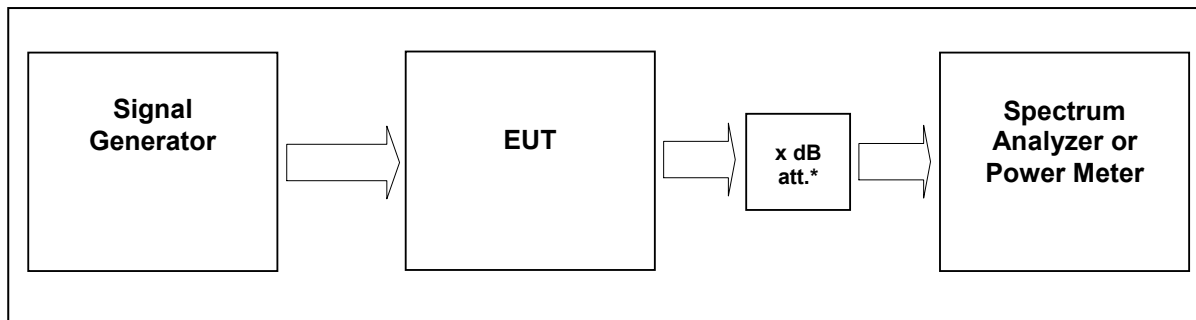

External Attenuator DL      x dB = 20 dB  
figure 9-#1 Test setup: Out of Band Rejection

Measurement uncertainty	± 0,38 dB
Test equipment used	9291, 9233, 7444; 7321; 7144; 7454; 7453; 7336; 7449; 7368

### 9.1 Limit

KDB 935210 D02 v03r02

Test for rejection of out of band signals. Filter frequency response plots are acceptable.

### 9.2 Test method

935210 D03 v04

7.1 Authorized frequency band verification test

### 9.3 Test results

Detector Peak max hold



### 9.3.1 Downlink

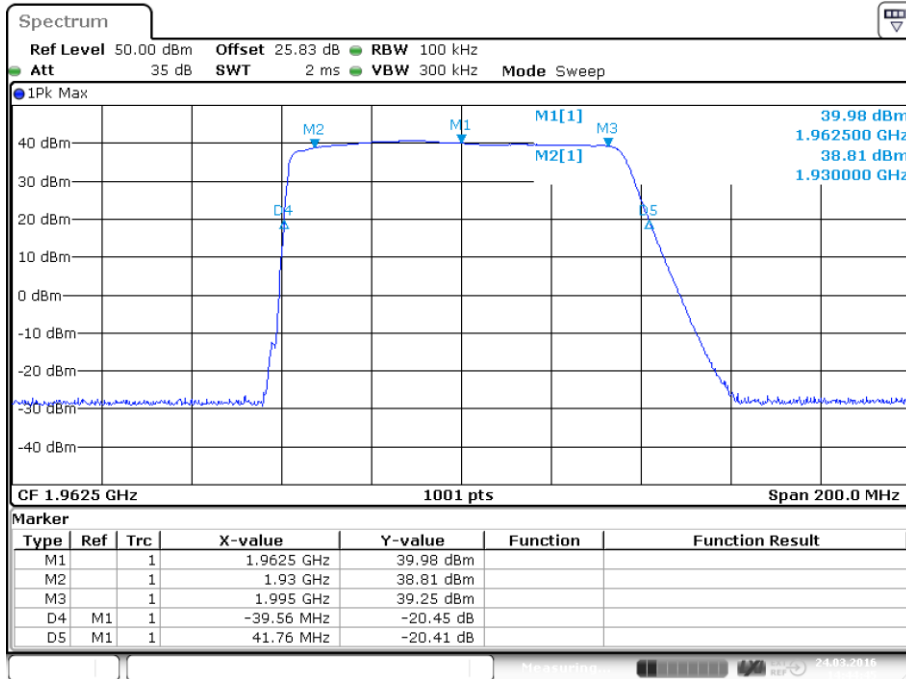

Date: 24.MAR.2016 14:44:45

plot 9.3.1-#1 Out of Band Rejection; Test results; Downlink;

### 9.3.2 Uplink

n.a.

Note: The EUT does not transmit over the air in the uplink direction.

### 9.4 Summary test result

Test result	complies, according the plots above
Tested by:	M. Leinfelder
Date:	24.03.2016

## 10 Field Strength of Spurious Emissions: §24.238, §2.1053



picture 8.1: label (EUT)

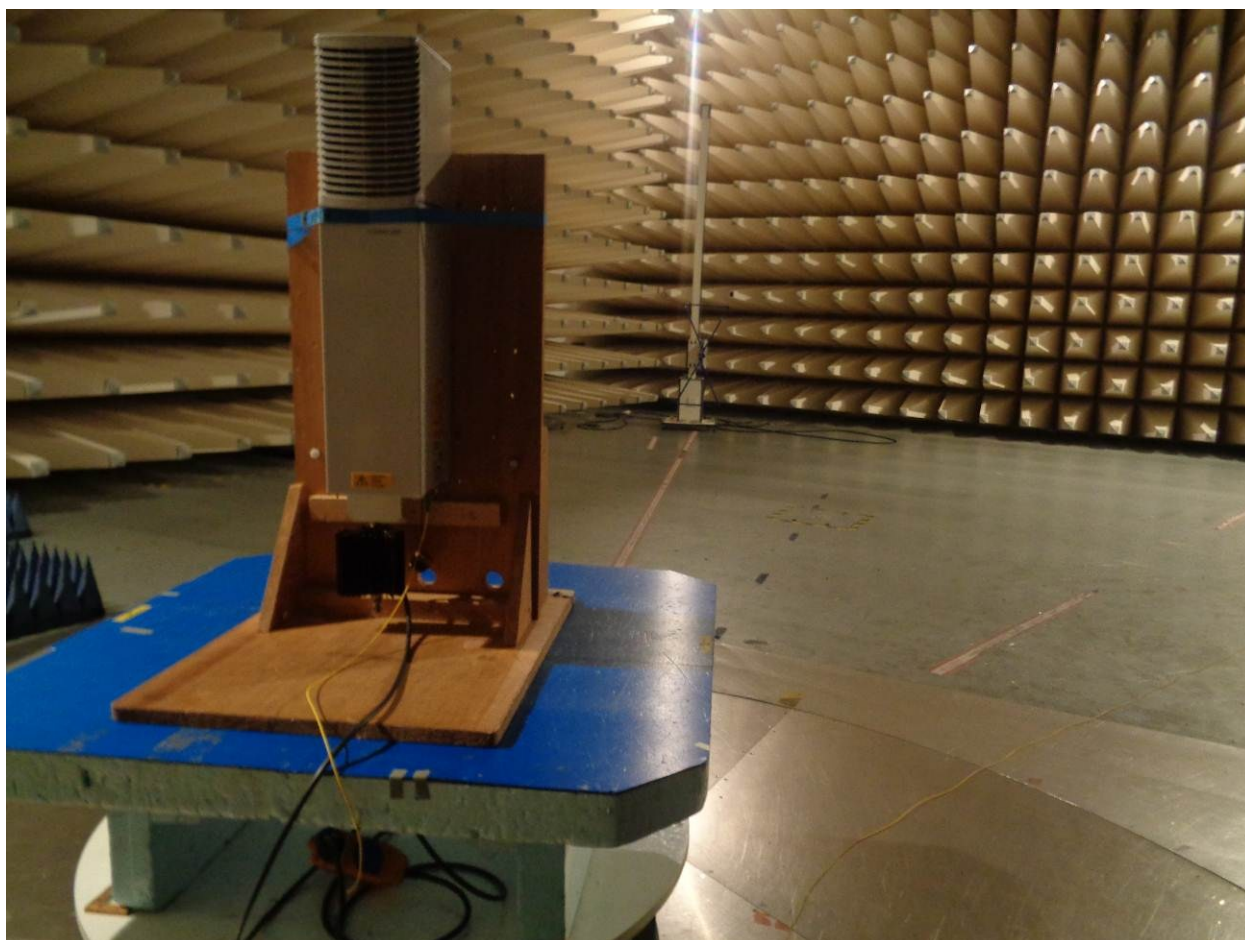

picture 8.3: Test setup: Field Strength Emission 30 M – 1 GHz @10m in the SAC

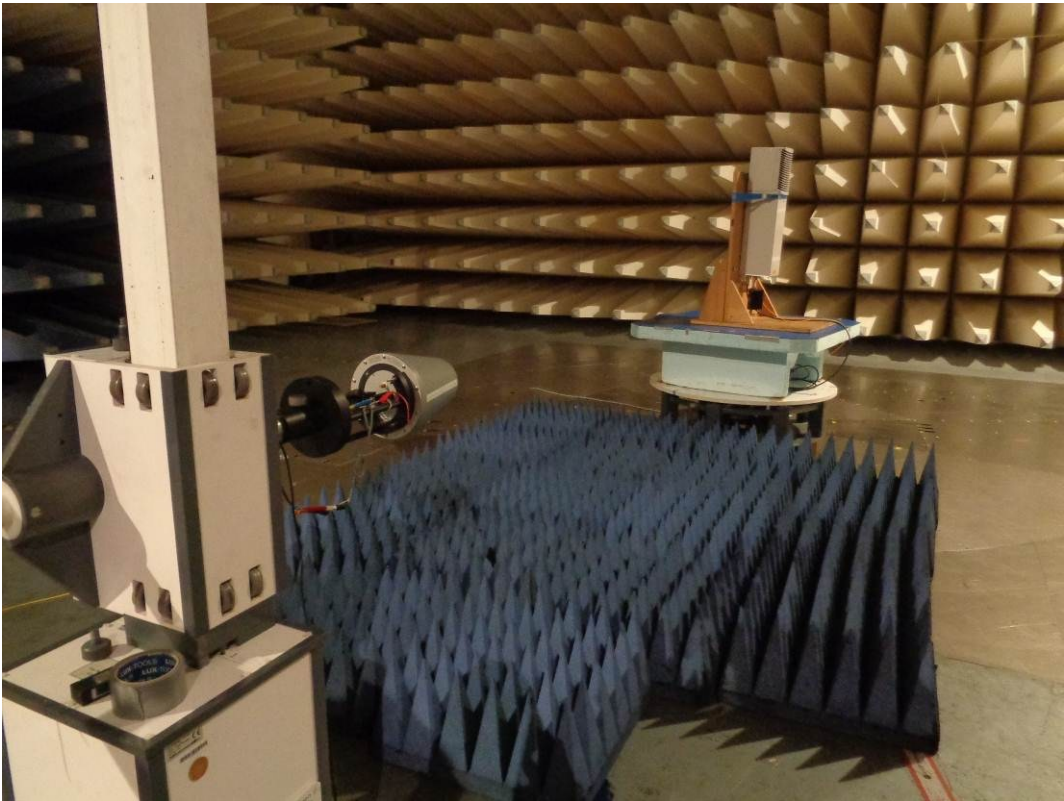

picture 8.4: Test setup: Field Strength Emission 1 – 18 GHz @3m in the SAC

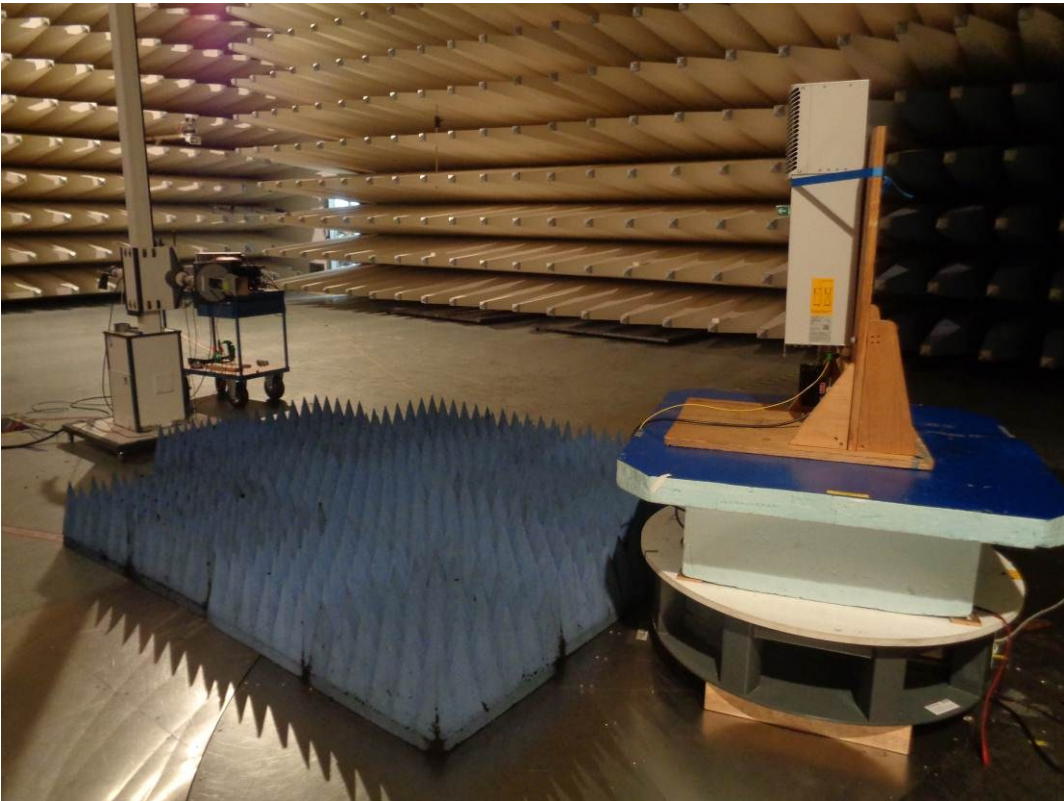

picture 8.4: Test setup: Field Strength Emission 18 – 26.5 GHz @3m in the SAC



This clause specifies requirements for the measurement of radiated emission.

Frequency range	Distance: EUT <-> antenna / location	Limit	Test method
30 MHz – 1 GHz	10 metres / SAC	FCC 47 CFR Part §24.238	TIA/EIA-603-C:2004
1 GHz – 18 GHz	3 metres / SAC		
18 GHz – 26.5 GHz	3 metres / SAC		

**Test equipment used:**

Designation	Type	Manufacturer	Invent.-no.	Cal.-date	due Cal.- date	used
EMI test receiver	ESU40	Rohde & Schwarz	E2025	25.02.2016	25.02.2017	X
Antenna	CBL 6111	Chase	K1026	12.02.2016	12.02.2017	X
RF Cable	RG214	Frankonia	K1121	16.04.2015	16.04.2017	X
Antenna	HL 025	R&S	K1114	09.02.2016	09.02.2017	X
Preamplifier	AFS4-00102000	Miteq	K838	17.06.2015	17.06.2016	X
RF Cable	Sucoflex 100	Suhner	K1760	04.08.2015	04.08.2016	X
Antenna	JXTXLB-42-25- C-KF	A-Info	K1175	09.03.2015	09.03.2017	X

The REMI version 2.135 has been used to maximize radiated emission from the EUT with regards to ANSI C63.4:2009.

**Test set-up:**

Test location: SAC  
 Both, the Fully Anechoic Chamber (FAC) and the Semi Anechoic Chamber (SAC) fulfil the requirements of ANSI C63.4 and CISPR 16-1-4 with regards to NSA and SVSWR.

Test Voltage: 110V / 60 Hz  
 Type of EUT: Wall mounted

**Measurement uncertainty:**

Measurement uncertainty expanded (95% or K=2)	± 4,7 dB for ANSI C63.4 measurement ± 0,5 dB for TIA-603 measurement
--	---



## 10.1 Limit §24.238

Minimum standard:

Para. No.24.238(a)

The rules in this section govern the spectral characteristics of emissions in the Broadband Personal Communications Service.

(a) Out of band emissions. The power of any emission outside of the authorized operating frequency ranges must be attenuated below the transmitting power (P) by a factor of at least  $43 + 10 \log(P)$  dB.

The limit is -13dBm (e.i.r.p).

## 10.2 Test method ANSI/TIA/EA-603-C

### Measurement procedure. TIA-603-C

The antenna substitution method is used to determine the equivalent radiated power at spurious frequencies. The spurious emissions are measured at a distance of 3 meters. The EUT is then replaced with a reference substitution antenna with a known gain referenced to a dipole. This antenna is fed with a signal at the spurious frequency. The level of the signal is adjusted to repeat the previously measured level. The resulting eirp is the signal level fed to the reference antenna corrected for gain referenced to an isotropic dipole (see Figure 7.2).

From KDB (AMPLIFIER, BOOSTER, AND REPEATER REMINDER SHEET):

Radiated spurs (enclosure) – Use of CW signal (low, mid, and high freq.) is acceptable rather than all modulations.

The maximum RFI field strength was determined during the measurement by rotating the turntable ( $\pm 180$  degrees) and varying the height of the receive antenna ( $h = 1 \dots 4$  m) as like defined in ANSI C63.4. A measurement receiver has been used with a RBW 120 kHz up to 1 GHz and 1 MHz above 1 GHz. Steps with during pre measurement was half the RBW.

Both, the Fully Anechoic Chamber (FAC) and the Semi Anechoic Chamber (SAC) fulfil the requirements of ANSI C63.4 and CISPR 16-1-4 with regards to NSA and SVSWR.

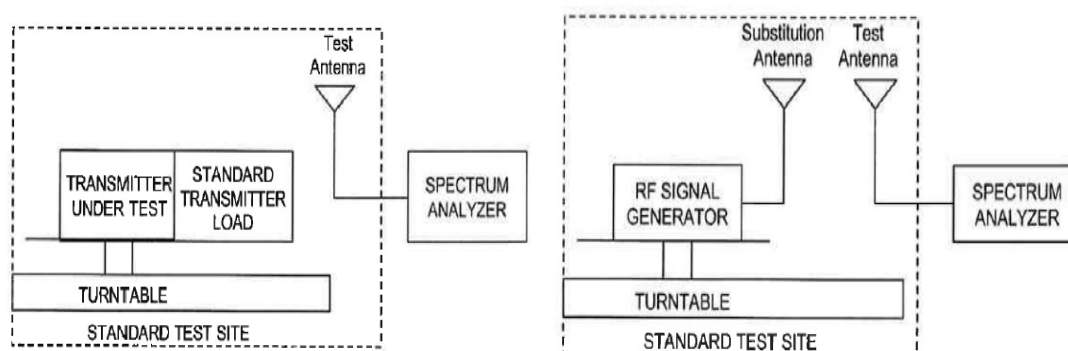

picture 8.3: Substitution method

## 10.3 Climatic values in the lab

Temperature: 20°  
 Relative Humidity: 45%  
 Air-pressure: 1009hPa



### 10.4 Test results

#### 10.4.1 30 MHz to 1 GHz Downlink (Bottom – Middle – Top) Subpart H

B/M/T: 1930 MHz/ 1962.5 MHz/ 1995 MHz

Vertikal

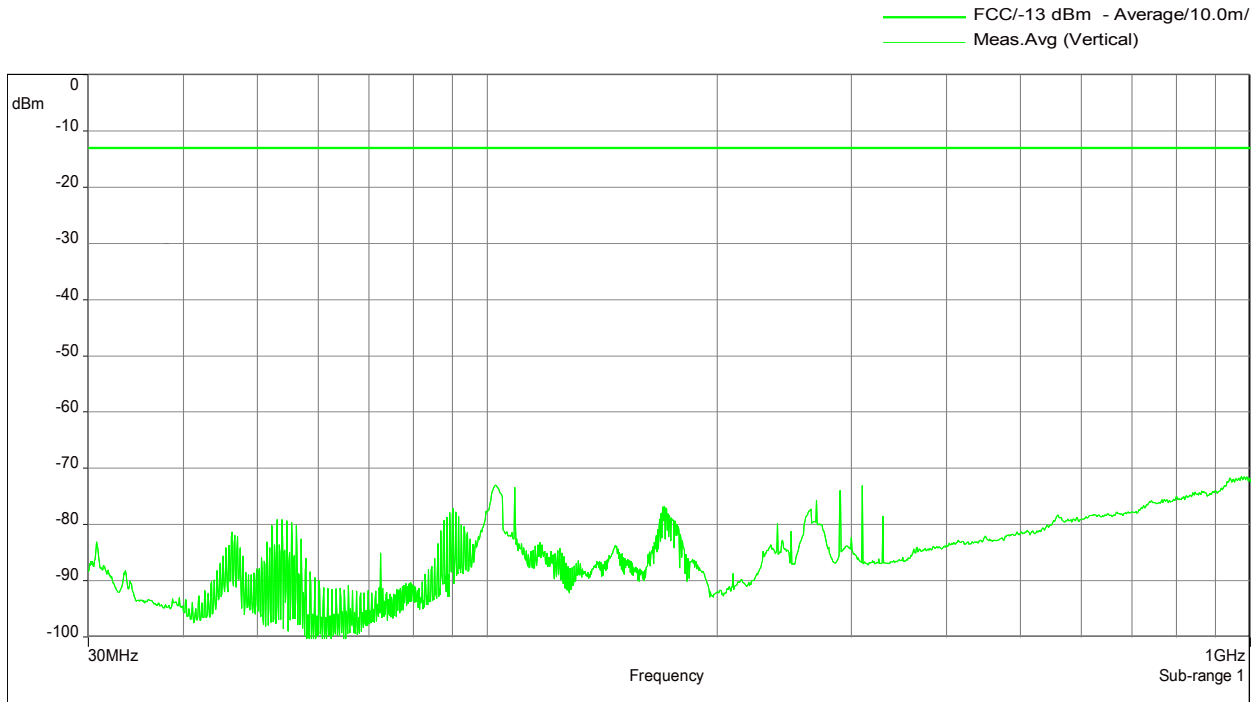

Horizontal

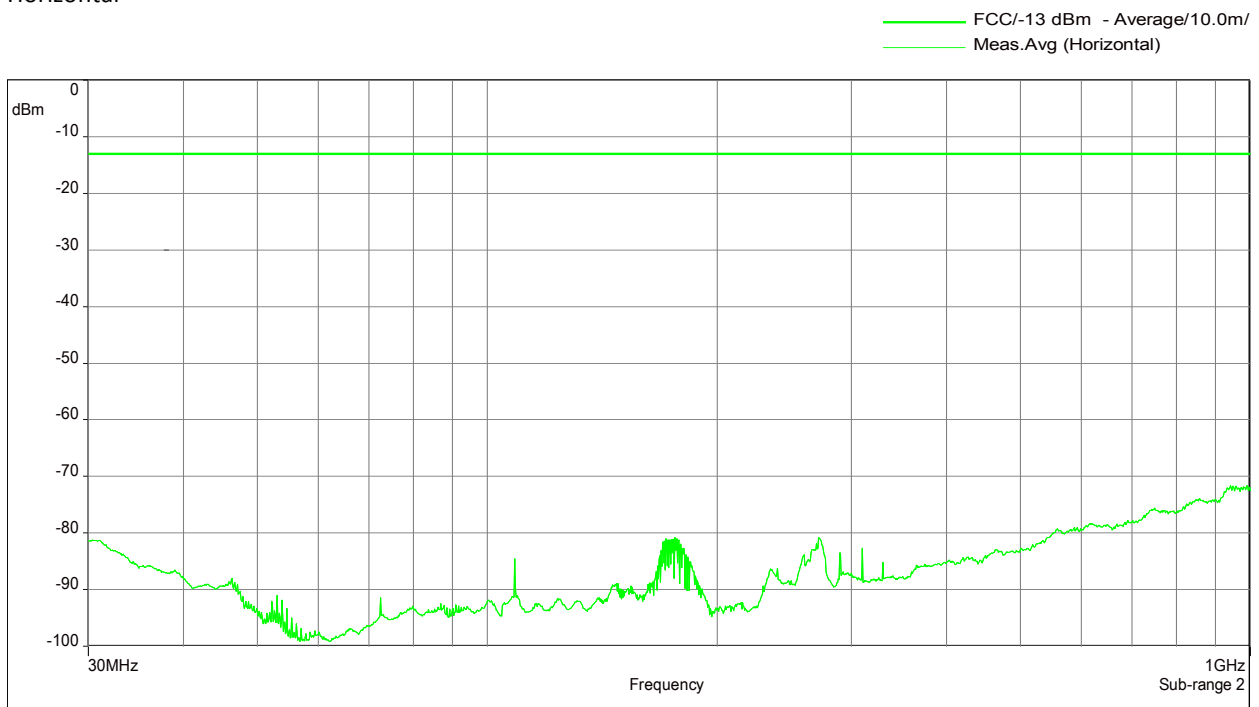

The RF output power is terminated.



### 10.4.2 30 MHz to 1 GHz Downlink (Middle of all paths)

F1: 746 MHz; F2: 869 MHz; F3: 1962.5 MHz; F4: 2145 MHz

Vertikal

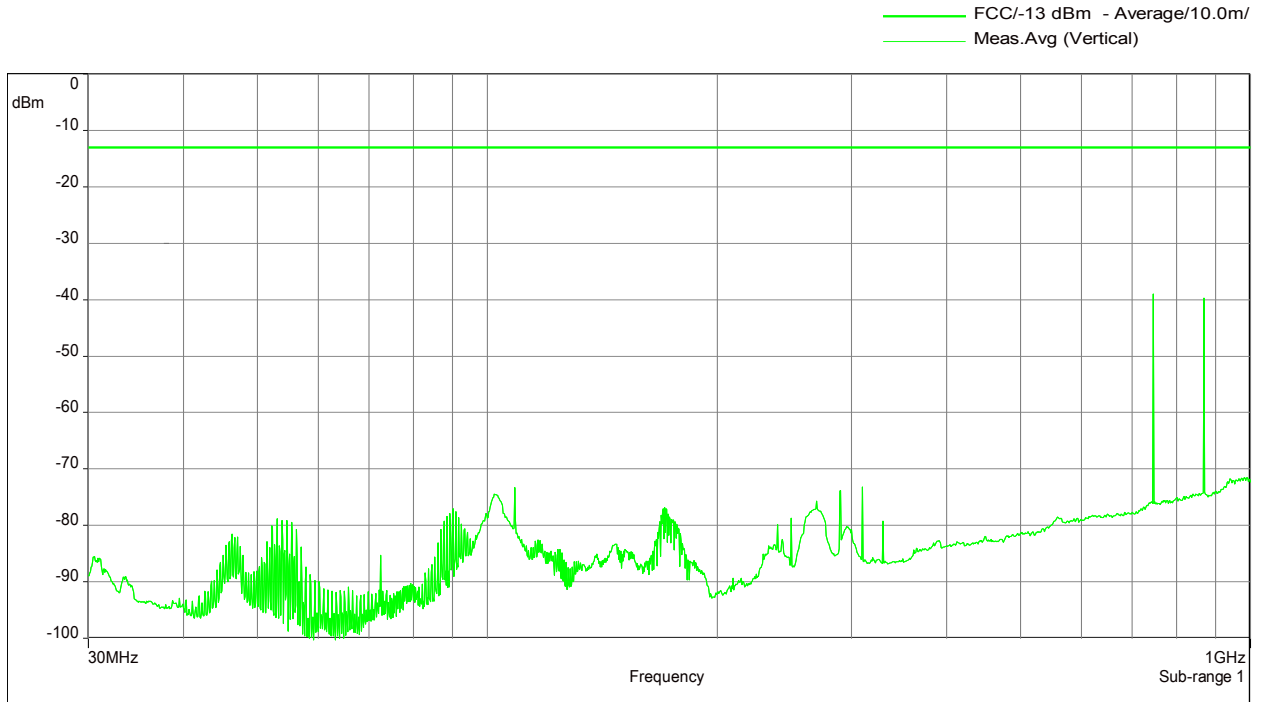

Horizontal

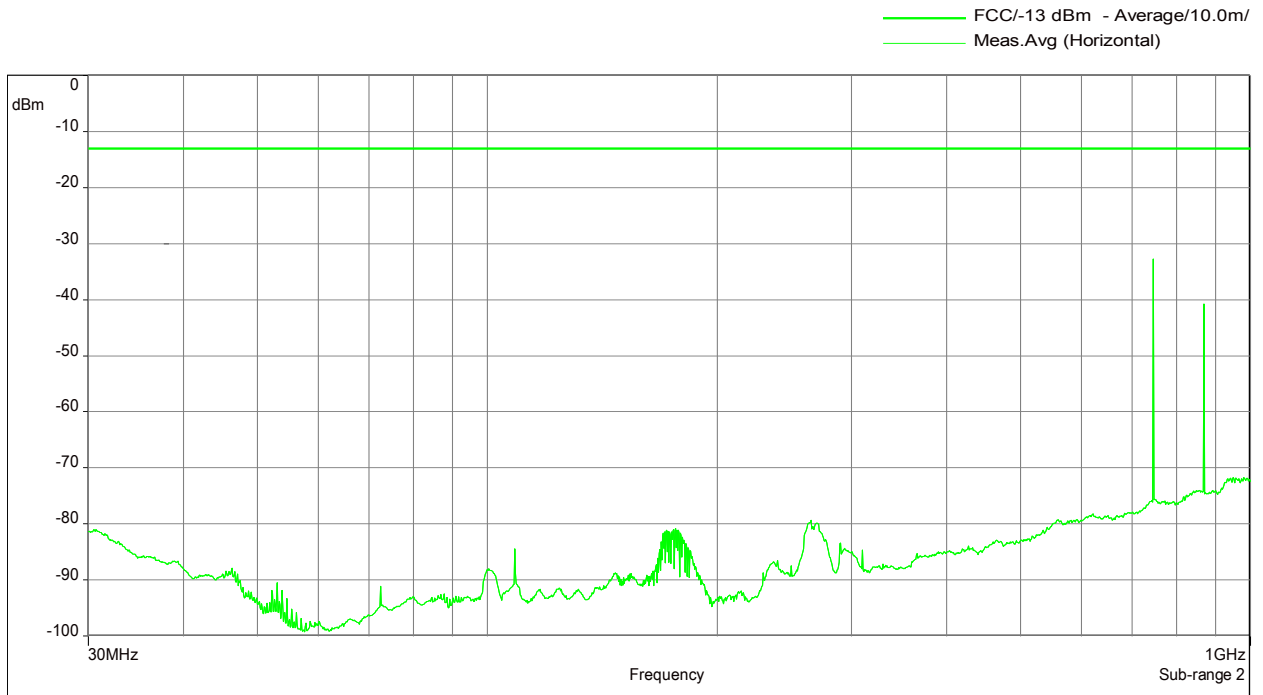

The RF output power is terminated.



### 10.4.3 1 GHz to 18 GHz Downlink (Bottom – Middle – Top) Subpart H

B/M/T: 1930 MHz/ 1962.5 MHz/ 1995 MHz

Vertikal

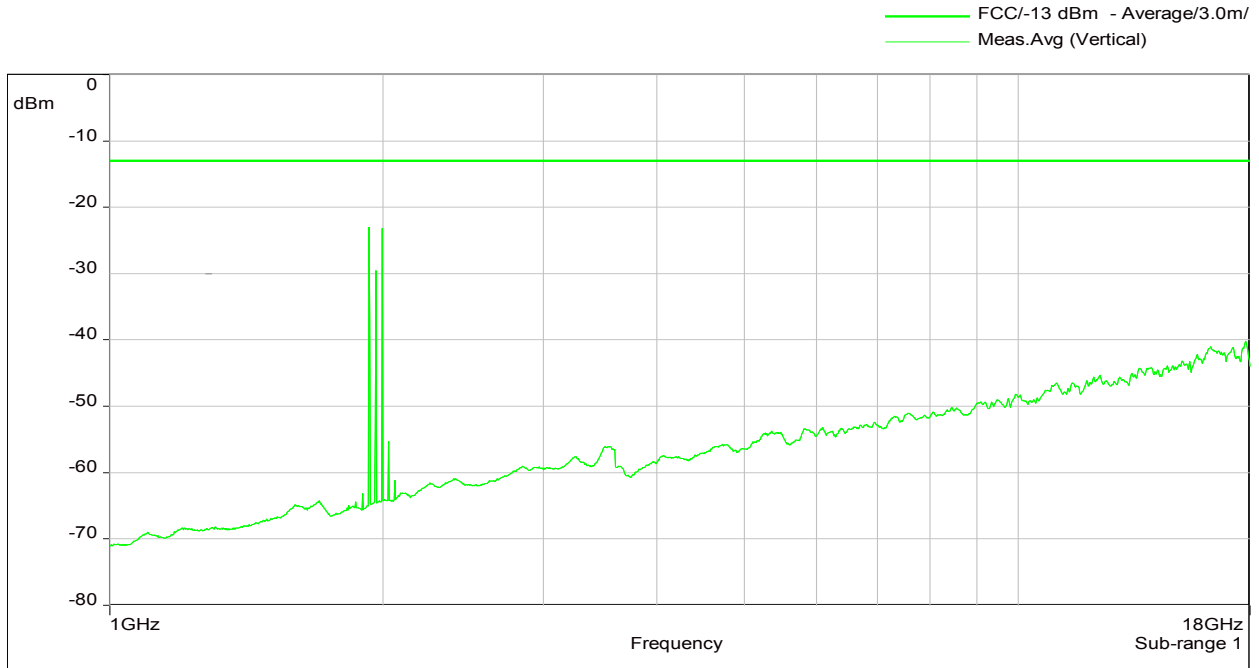

Horizontal

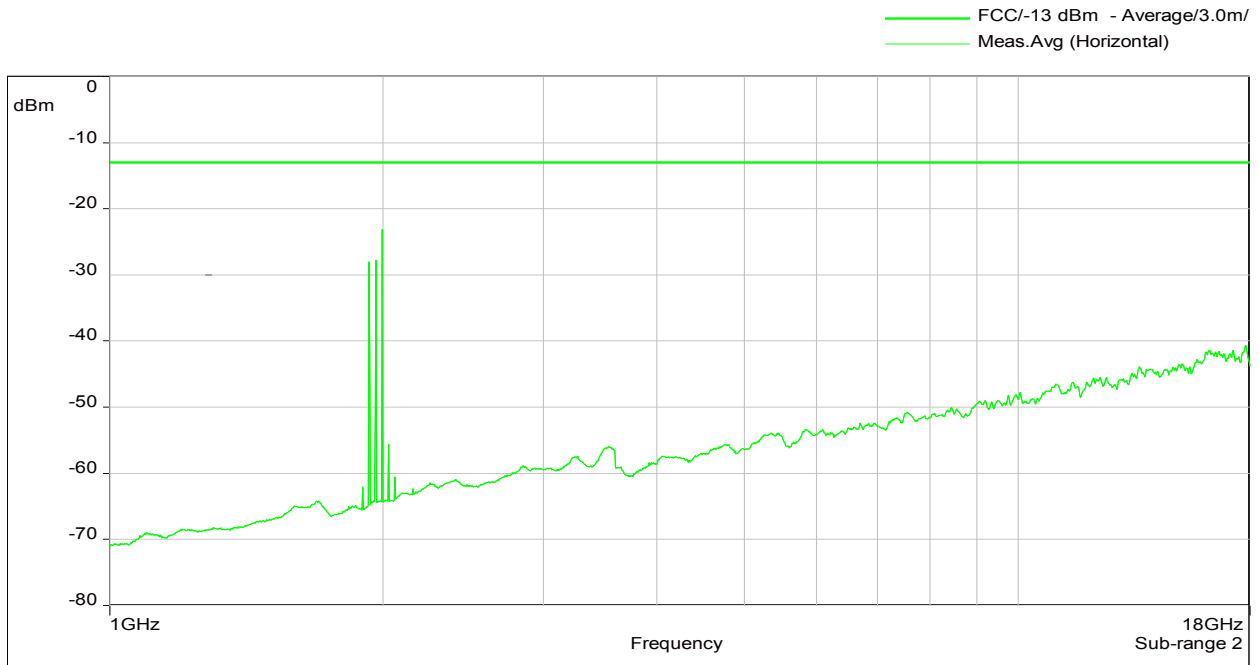

The RF output power is terminated.



### 10.4.4 1 GHz to 18 GHz Downlink (Middle of all paths)

F1: 746 MHz; F2: 869 MHz; F3: 1962.5 MHz; F4: 2145 MHz

Vertikal

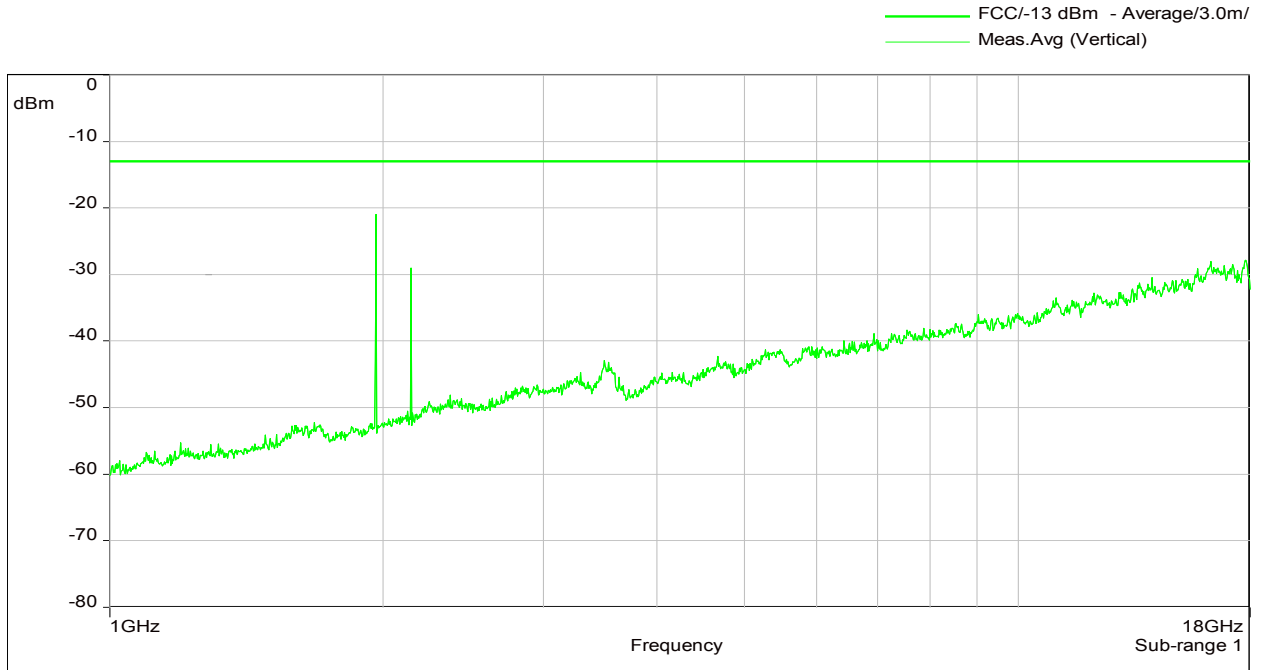

Horizontal

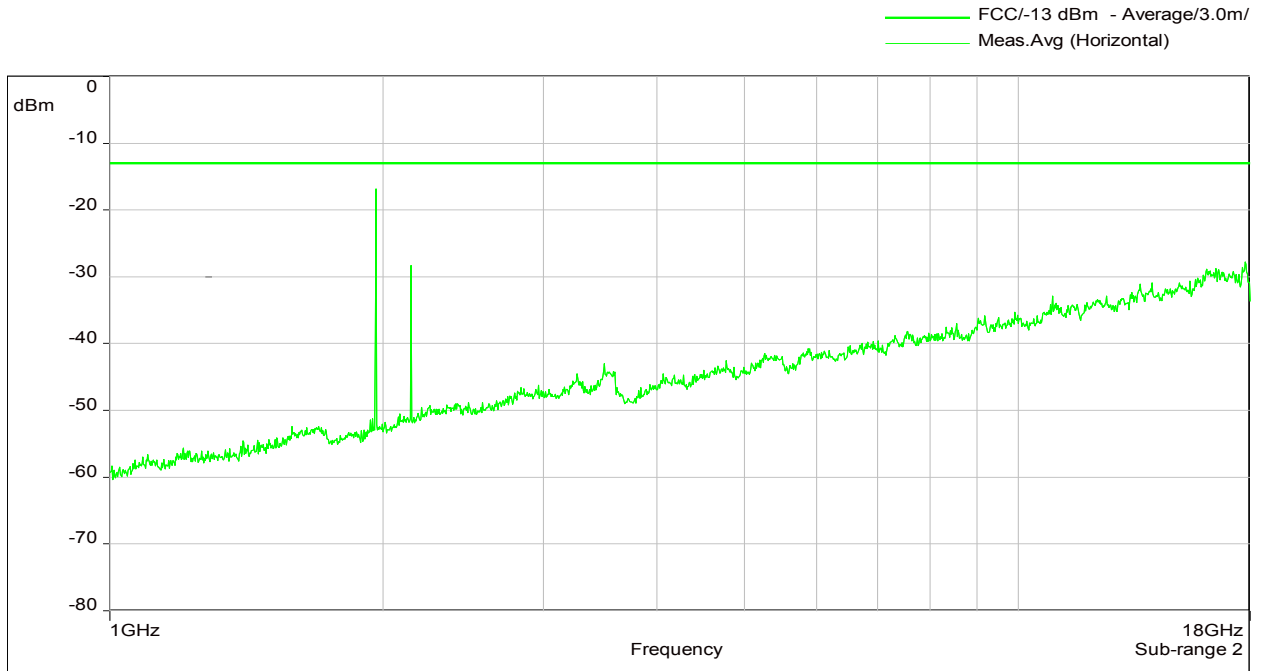

The RF output power is terminated.



### 10.4.5 18 GHz – 26.5 GHz Downlink (Bottom – Middle – Top)

B/M/T: 2110 MHz / 2145 MHz / 2180 MHz (Operation with maximum composite power)

Vertikal

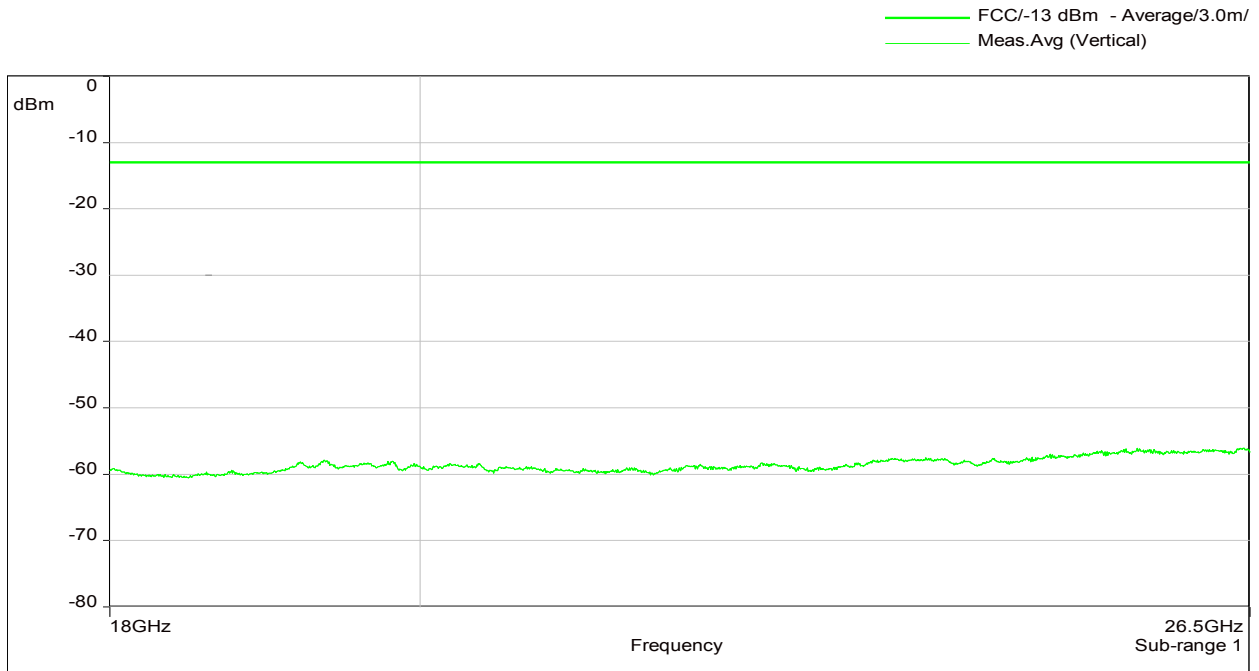

Horizontal

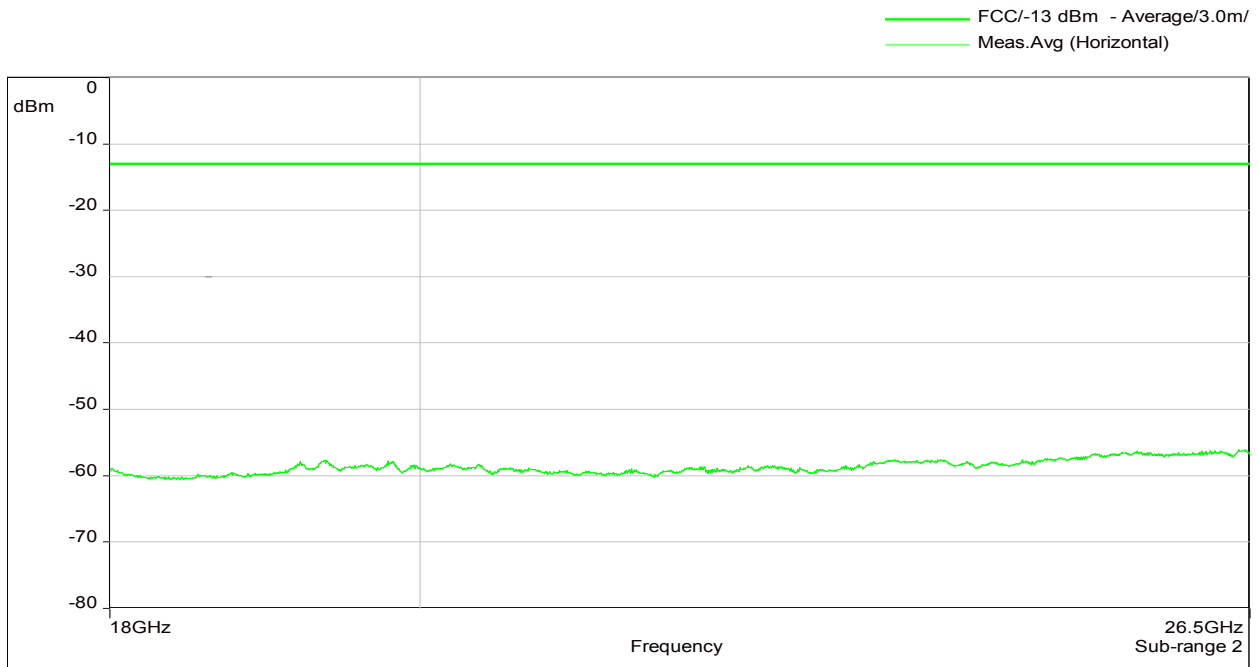

The RF output power is terminated.



### 10.4.6 18 GHz – 26.5 GHz Downlink (Middle of both paths)

F1: 746 MHz; F2: 869 MHz; F3: 1962.5 MHz; F4: 2145 MHz

Vertical

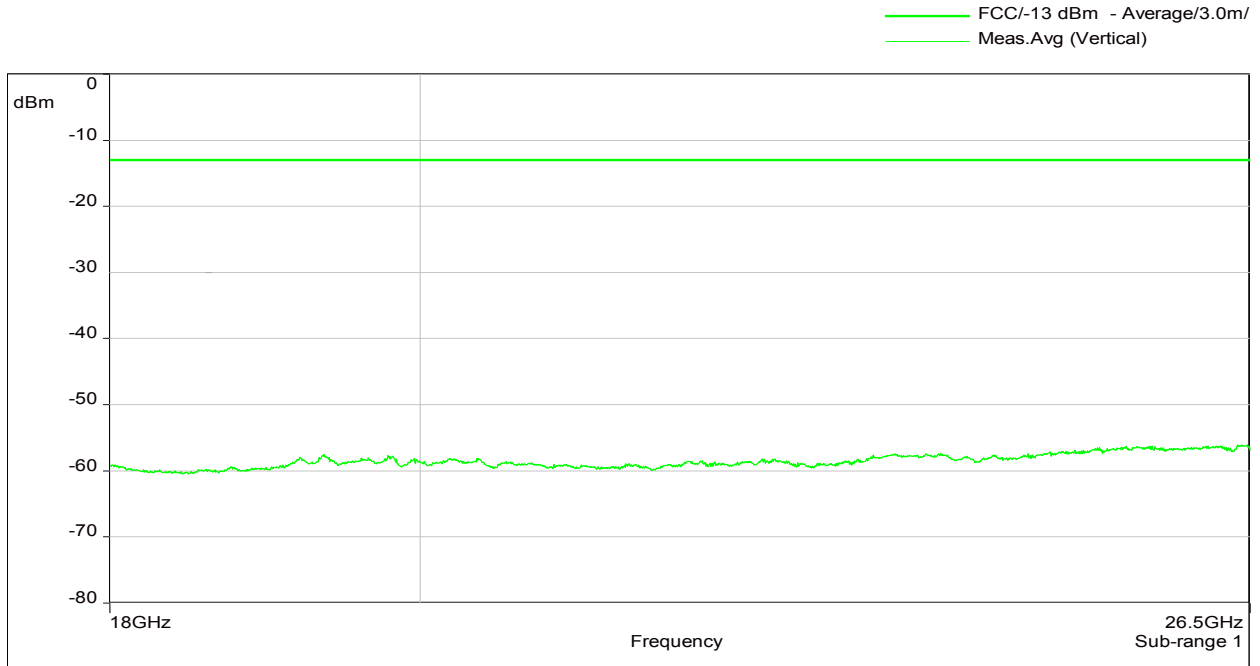

Horizontal

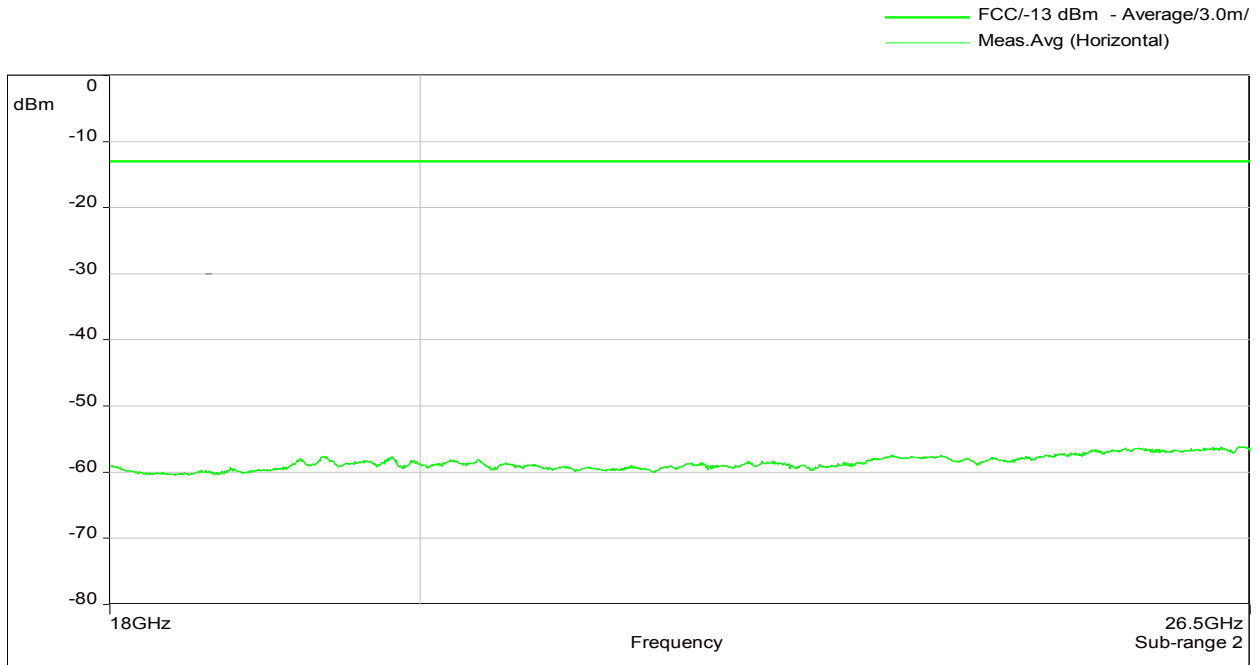

The RF output power is terminated.

Za / 26.04.2016

**The radiated spurious emission measurements have been passed!**



## 11 History

Revision	Modification	Date	Name
V01.00	Initial	29.04.2016	Tom Zahlmann

**\*\*\*\*\* End of test report \*\*\*\*\***