

Test Site:
FCC Test Site No.: 96997



**BUREAU
VERITAS**

ECL-EMC Test Report No.: 17-136

Equipment under test: ION-M17EP/19P

FCC ID: 1700MHz Path
XS5-M17E19P

Type of test: **FCC 47 CFR Part 27 Subpart C: 2016**
Miscellaneous Wireless Communication Services

Measurement Procedures: 47 CFR Parts 2 (*Frequency Allocations and Radio Treaty Matters; General Rules and Regulations*),
Part 27:2017 (*Miscellaneous Wireless Communication Services*),
ANSI/TIA-603-D (2010), *Land Mobile FM or PM Communications Equipment Measurement and Performance Standards*

Test result: **Passed**

Date of issue:	22.06.17		Signature:
Issue-No.:	01	Author:	
Date of delivery:	07.06.17	Checked:	
Test dates:	24.03.16 – 08.06.17		
Pages:	48		

Test Report No.: 17-136

FCC ID: XS5-M17E19P



BUREAU
VERITAS

Manufacturer: ANDREW Wireless Systems GmbH
Industriering 10

D-86675 Buchdorf

Tel.: +49 (0)9099 69 0

Fax: +49 (0)9099 69 140

Test Location: Bureau Veritas Consumer Products Services
Germany GmbH
European Compliance Laboratory (ECL)
Thurn-und-Taxis-Straße 18

D-90411 Nürnberg

Tel.: +49 40 74041 0

Fax: +49 40 74041-2755

General:

The purpose of this report is to show compliance to the FCC regulations for devices operating under Part N°27 of the Code of Federal Regulations title 47.

This report informs about the results of the EMC tests, it only refers to the equipment under test. No part of this report may be reproduced in any form, without written permission.



Table of contents

1	TEST RESULTS SUMMARY	5
2	EQUIPMENT UNDER TEST (E.U.T.)	6
2.1	DESCRIPTION	6
2.1.1	DOWNLINK	6
2.1.2	UPLINK	6
2.1.3	DESCRIPTION OF EUT	7
2.1.4	BLOCK DIAGRAM OF MEASUREMENT REFERENCE POINTS	8
2.1.5	DOWNLINK SYSTEM GAIN AND OUTPUT POWER	8
3	TEST SITE (ANDREW BUCHDORF)	9
3.1	TEST ENVIRONMENT	9
3.2	TEST EQUIPMENT	9
3.3	INPUT AND OUTPUT LOSSES	10
3.4	MEASUREMENT UNCERTAINTY	10
4	TEST SITE (BUREAU VERITAS CONSUMER PRODUCTS SERVICES)	10
5	RF POWER OUT: §27.50, §2.1046	11
5.1	LIMIT	11
5.2	TEST METHOD	11
5.3	TEST RESULTS	12
5.3.1	DOWNLINK	12
5.3.1.1	CDMA	13
5.3.1.2	W-CDMA	14
5.3.1.3	LTE	14
5.3.2	UPLINK	15
5.4	SUMMARY TEST RESULT	15
6	OCCUPIED BANDWIDTH: §2.1049	16
6.1	LIMIT	16
6.2	TEST METHOD	16
6.3	TEST RESULTS	17
6.3.1	DOWNLINK	17
6.3.1.1	CDMA	18
6.3.1.2	W-CDMA	19
6.3.1.3	LTE	20
6.3.2	26DB BANDWIDTH	21
6.3.2.1	CDMA	21
6.3.2.2	W-CDMA	22
6.3.2.3	LTE	23
6.3.3	UPLINK	24
6.4	SUMMARY TEST RESULT	24
7	SPURIOUS EMISSIONS AT ANTENNA TERMINALS: §27.53, §2.1051	25
7.1	LIMIT	25



7.2	TEST METHOD	25
7.3	TEST RESULTS	26
7.3.1	DOWNLINK	26
7.3.1.1	CDMA	27
7.3.1.2	W-CDMA.....	27
7.3.1.3	LTE	28
7.3.2	UPLINK	28
7.4	SUMMARY TEST RESULT	28
8	INTERMODULATION: §27.53, §2.1051.....	29
8.1	LIMIT.....	29
8.2	TEST METHOD	29
8.3	TEST RESULTS	30
8.3.1	DOWNLINK	30
8.3.1.1	CDMA	31
8.3.1.2	WCDMA.....	32
8.3.1.3	LTE	33
8.3.2	UPLINK	34
8.4	SUMMARY TEST RESULT	34
9	OUT OF BAND REJECTION	35
9.1	LIMIT.....	35
9.2	TEST METHOD	35
9.3	TEST RESULTS	35
9.3.1	DOWNLINK	36
9.3.2	UPLINK	36
9.4	SUMMARY TEST RESULT	36
10	FIELD STRENGTH OF SPURIOUS EMISSIONS: §27.53, §2.1053.....	37
10.1	METHOD OF MEASUREMENT	40
10.2	LIMIT §27.53 (H).....	41
10.3	CLIMATIC VALUES IN THE LAB	41
10.4	TEST RESULTS.....	42
10.4.1	30 MHz TO 1 GHz DOWNLINK (BOTTOM – MIDDLE – TOP)	42
10.4.2	30 MHz TO 1 GHz DOWNLINK (MIDDLE OF BOTH PATHS)	43
10.4.3	1 GHz – 18 GHz DOWNLINK (BOTTOM – MIDDLE – TOP)	44
10.4.4	1 GHz – 18 GHz DOWNLINK (MIDDLE OF BOTH PATHS).....	45
10.4.5	18 GHz – 26.5 GHz DOWNLINK (BOTTOM – MIDDLE – TOP)	46
10.4.6	18 GHz – 26.5 GHz DOWNLINK (MIDDLE OF BOTH PATHS).....	47
11	HISTORY	48



1 Test Results Summary

Name of Test	FCC Para. No.	FCC Method	FCC Spec.	Result
RF Power Output	27.50(d)	2.1046	1640 Watts/MHz	Complies
Occupied Bandwidth	KDB 935210 D02 v03r02	2.1049	Input/Output	Complies
Spurious Emissions at Antenna Terminals	27.53(h)	2.1051	-13dBm	Complies
Field Strength of Spurious Emissions	27.53(m)	2.1053 TIA/EA-603	-13dBm E.I.R.P	Complies
Intermodulation	KDB 935210 D02 v03r02	KDB 935210 D02 v03r02	KDB 935210 D02 v03r02	Complies
Frequency Stability	27.54	2.1055	Must stay in band	NA
Out of Band Rejection	KDB 935210 D02 v03r02	KDB 935210 D03 v04	KDB 935210 D03 v04	Complies

Frequency stability is given by: The system gets an electrical analog signal from the BSS which is converted into an analog optical signal, transmitted by the optical links and then reconverted in the Remote Unit into an analog electrical signal. During this process happens no frequency change/modification, so input and output have same frequency what can be seen under clause "Occupied Bandwidth".



2 Equipment under test (E.U.T.)

2.1 Description

Kind of equipment	ION-M17EP/19P	
Andrew Ident. Number	7774791-0001	
Serial no.(SN)	11	
Revision	00	
Software version and ID	n. a.	
Type of modulation and Designator	CDMA (F9W)	<input checked="" type="checkbox"/>
	W-CDMA (F9W)	<input checked="" type="checkbox"/>
	LTE (G7D)	<input checked="" type="checkbox"/>
Frequency Translation	F1-F1	<input checked="" type="checkbox"/>
	F1-F2	<input type="checkbox"/>
	N/A	<input type="checkbox"/>
Band Selection	Software	<input type="checkbox"/>
	Duplexer	<input checked="" type="checkbox"/>
	Full band	<input type="checkbox"/>

2.1.1 Downlink

Pass band	2110 MHz – 2180 MHz
Max. composite output power based on one carrier per path (rated)	43 dBm = 20 W
System Gain*	10 dB @ Pout BTS of 33 dBm

*see 2.1.5

2.1.2 Uplink

Pass band	1710 MHz – 1780 MHz
Maximum rated output power	n. a.
System Gain*	n. a.

*see 2.1.5

Note: The EUT does not transmit over the air in the uplink direction.

Test Report No.: 17-136

FCC ID: XS5-M17E19P



BUREAU
VERITAS

2.1.3 Description of EUT

CommScope's ION-M17EP/19P is a multi-band, multi-operator Remote Unit. It is used in conjunction with a Master Unit in the ION optical distribution system. This system transports up to 2 frequency bands simultaneously, providing a cost-effective solution for distributing capacity from one or more base stations.

This Test Report describes only the approval of the 1700/2100 MHz Path.

The ION-M17EP/19P Repeater system consists of one 1700/2100 MHz path and one 1900 MHz path with the intended use of simultaneous transmission.

The antenna(s) used with device must be fixed-mounted on permanent structures.



2.1.4 Block diagram of measurement reference points

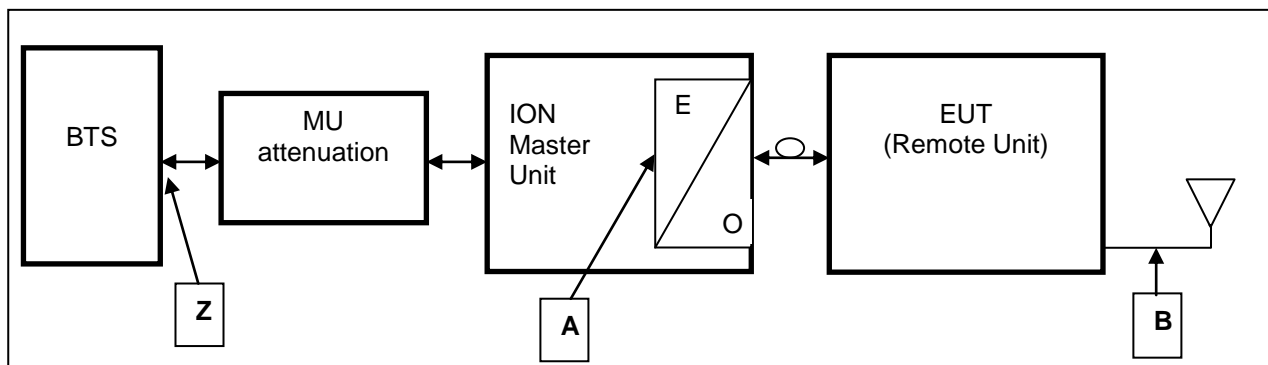

figure 2.1.4-#1 Block diagram of measurement reference points

Remote Unit (RU) is the EUT

O/E Opitcal/Electrical converter
 MU Master Unit

Reference point A MU UL output, DL input
 Reference point B Remote Unit DL output, UL input
 Reference point Z BTS DL output, UL input

Since a signal generator does not supply a good output signal with +33 or +43dBm, for the downlink measurement the MU Attenuation is not used.

That means for downlink measurements the signal generator is connected to measurement point A at the master optical / electrical converter and the analyzer to the measurement point B at the RU.

2.1.5 Downlink System Gain and Output Power

System optimized for BTS power (fixed value) Z	MU Attenuation (manual leveling)	Maximum rated input power at the MU OTRX (fixed value) A	RU Gain (fixed value) A to B	Maximum rated output power at RU Antenna port (fixed value) B
+33 dBm	30 dB	3 dBm	+40 dB	+43 dBm @ 1 carrier
System Gain Z to B	+10 dB			
+43 dBm	40 dB	3 dBm	+40 dB	+43 dBm @ 1 carrier
System Gain Z to B	0 dB			

table 2.1.5-#1 Equipment under test (E.U.T.) Description Downlink System Gain and Output Power



3 Test site (Andrew Buchdorf)

3.1 Test environment

All tests were performed under the following environmental conditions:

Condition	Minimum value	Maximum value
Barometric pressure	86 kPa	106 kPa
Temperature	15°C	30°C
Relative Humidity	20 %	75 %
Power supply range	±5% of rated voltages	

3.2 Test equipment

ANDREW Inv. No.	Test equipment	Type	Manufacturer	Serial No.	Calibration
9295	Network Analyzer	ZNB20	R&S	101540	11/16
9291	Spectrum Analyzer	FSV30	R&S	103090	06/16
9233	Signal Generator	SMBV100A	R&S	257777	06/16
8849	Signal Generator	SMU200A	R&S	101732	04/17
8671	Power Meter	E4418B	Agilent	GB39513094	06/16
8672	Power Sensor	E9300H	Agilent	US41090179	06/16
7321	Circulator	E10-1FFF	AEROTEK	25350	CIU
7326	Circulator	E10-1FFF	AEROTEK	25360	CIU
7408	RF-Cable	2,0m; N-N	Andrew	---	CIU
7409	RF-Cable	2,0m; N-N	Andrew	---	CIU
7410	RF-Cable	1,0m; N-N	Andrew	---	CIU
7411	RF-Cable	2,0m; N-N	Andrew	---	CIU
7373	RF-Cable	Multiflex141	Andrew	---	CIU
7374	RF-Cable	Multiflex141	Andrew	---	CIU
7437	RF-Cable	Multiflex141	Andrew	---	CIU
7438	RF-Cable	Multiflex141	Andrew	---	CIU
7439	RF-Cable	Multiflex141	Andrew	---	CIU
7443	RF-Cable	Multiflex141	Andrew	---	CIU
7444	RF-Cable	Multiflex141	Andrew	---	CIU
7445	RF-Cable	Multiflex141	Andrew	---	CIU
7446	RF-Cable	Multiflex141	Andrew	---	CIU
7447	RF-Cable	Multiflex141	Andrew	---	CIU
7448	RF-Cable	Multiflex141	Andrew	---	CIU
7449	RF-Cable	Multiflex141	Andrew	---	CIU
7450	RF-Cable	Multiflex141	Andrew	---	CIU
7440	RF-Cable	RG-223 0.8m	Andrew	---	CIU
7441	RF-Cable	RG-223 0.8m	Andrew	---	CIU
7453	RF-Cable	RG223 2m SMA.	Andrew	---	CIU
7454	RF-Cable	RG223 2m SMA.	Andrew	---	CIU
7455	RF-Cable	RG223 2m SMA.	Andrew	---	CIU
7144	Attenuator	2N-20dB	Inmet 64671	---	CIU
7336	Power Attenuator	769-20	Narda	---	CIU
7368	Matrix		COMMSCOPE	---	weekly

CIU = Calibrate in use



3.3 Input and output losses

All recorded power levels should be referenced to the input and output connectors of the repeater, unless explicitly stated otherwise.

The test equipment used in this test has to be calibrated, so that the functionality is also checked. All cables, attenuators, splitter, isolator, circulator and combiner etc. must be measured before testing and used for compensation during testing.

3.4 Measurement uncertainty

The extended measurement uncertainty corresponds to the measurement results from the standard measurement uncertainty multiplied by the coverage factor $k=2$. The true value is located in the corresponding interval with a probability of 95 %.

4 Test site (Bureau Veritas Consumer Products Services)

FCC Test site: 96997

See relevant dates under section 10 of this test report.



5 RF Power Out: §27.50, §2.1046

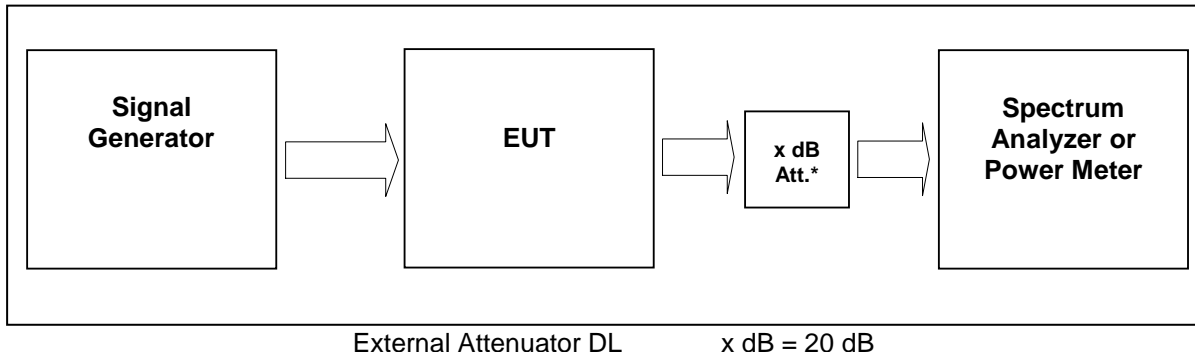

figure 5-#1 Test setup: RF Power Out: §27.50, §2.1046

Measurement uncertainty	± 0,38 dB
Test equipment used	9291, 9233, 7444; 7321; 7144; 7454; 7453; 7336; 7449; 7368

5.1 Limit

Minimum standard:

Para. No.27.50(d)

(d) The following power and antenna height requirements apply to stations transmitting in the 1695-1710 MHz, 1710-1755 MHz, 1755-1780 MHz, 1915-1920 MHz, 1995-2000 MHz, 2000-2020 MHz, 2110-2155 MHz, 2155-2180 MHz and 2180-2200 MHz bands:

(2) The power of each fixed or base station transmitting in the 1995-2000 MHz, the 2110-2155 MHz 2155-2180 MHz band, or 2180-2200 MHz band and situated in any geographic location other than that described in paragraph (d)(1) of this section is limited to:

- (i) An equivalent isotropically radiated power (EIRP) of 1640 watts when transmitting with an emission bandwidth of 1 MHz or less;
- (ii) An EIRP of 1640 watts/MHz when transmitting with an emission bandwidth greater than 1 MHz.

5.2 Test method

§ 2.1046 Measurements required: RF power output.

(a) For transmitters other than single sideband, independent sideband and controlled carrier radiotelephone, power output shall be measured at the RF output terminals when the transmitter is adjusted in accordance with the tune-up procedure to give the values of current and voltage on the circuit elements specified in § 2.1033(c)(8). The electrical characteristics of the radio frequency load attached to the output terminals when this test is made shall be stated.

(c) For measurements conducted pursuant to paragraphs (a) and (b) of this section, all calculations and methods used by the applicant for determining carrier power or peak envelope power, as appropriate, on the basis of measured power in the radio frequency load attached to the transmitter output terminals shall be shown. Under the test conditions specified, no components of the emission spectrum shall exceed the limits specified in the applicable rule parts as necessary for meeting occupied bandwidth or emission limitations



5.3 Test results

Detector RMS.

Test signal CDMA

Signal waveform according to table 6.2-1 of standard specification 3GPP2 C.p0051-0 v1.0 16.February 2006 pilot, sync, paging, 37 traffics, which is equal to the table 6.5.2.1 of 3GPP2 C.S0010-C v2.0 24.February 2006.

Test signal WCDMA

Signal waveform according to Test Model 1 of standard specification 3GPP TS25.141. Signal modulated with a combination of PCCPCH, SCCPCH and Dedicated Physical Channels specified as test model 1 64 DPCH.

Test signal LTE:

Signal waveform according to Test Model 1.1, E-TM1.1, clause 6.1.1.1-1, table 6.1.1.1-1 of standard specification 3GPP TS 36.141 V9.3.0 (2010-03).

5.3.1 Downlink

Modulation	Measured at	Path	RBW VBW Span	RF Power (dBm)	RF Power (W)	Plot -
CDMA	Middle	2145 MHz	3MHz 10MHz 15MHz	42.5	18	5.3.1.1 #1
WCDMA	Middle	2145 MHz	10MHz 10MHz 50MHz	42.5	18	5.3.1.2 #1
LTE	Middle	2145 MHz	3MHz 10MHz 15MHz	43.0	20	5.3.1.3 #1
Maximum output power = 43.0 dBm = 20 W						
Limit Maximum output power (erp) = 1000 W						

table 5.3.1-#1 RF Power Out: §27.50, §2.1046 Test results Downlink

The max RF Power out is 43.0 dBm, so the maximum antenna gain (x) can be calculated as follow:

Limit = 1000W (erp) = 60 dBm

Info: 1000W (erp) = 1640W (eirp)

$$60 \text{ dBm} > 43.0 \text{ dBm} + x \quad \text{-----} > \quad x = 60 \text{ dBm} - 43.0 \text{ dBm} = \underline{17 \text{ dBd}}$$

$$x \text{ dBi} = 17 \text{ dBd} + 2.15 = \underline{19.15 \text{ dBi}}$$

=> The antenna that will be used for the complete system have to have a gain lower than 19.15 dBi, relative to a dipol.



Modulation	Pin / dBm (Ref. point A)
CDMA	3.1
WCDMA	3.3
LTE	3.7

table 5.3.1-#2 RF Power Out: §27.50, §2.1046 Test results Downlink Input power

5.3.1.1 CDMA

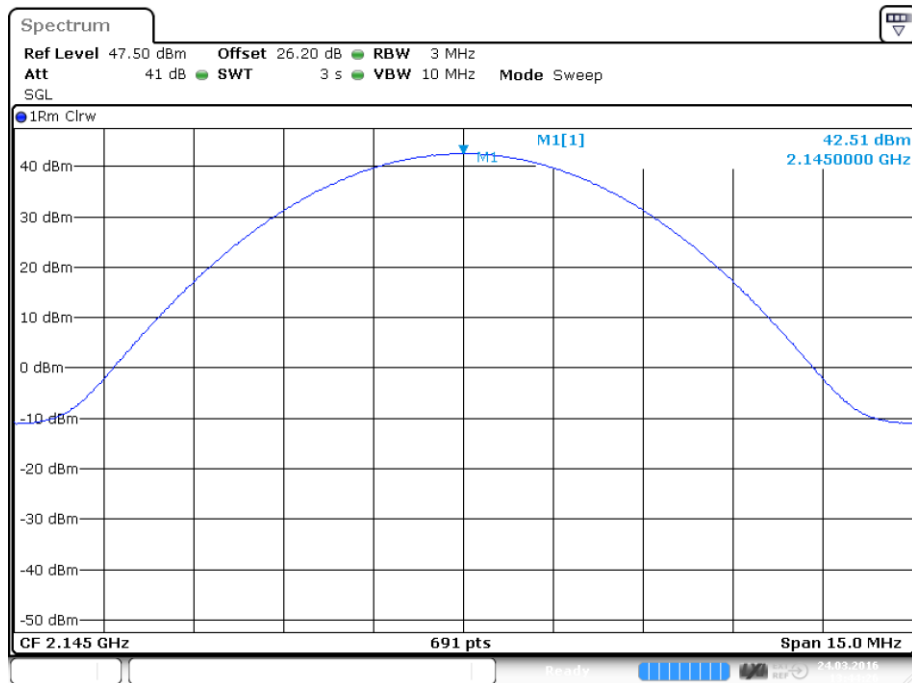

Date: 24.MAR.2016 13:44:26

plot 5.3.1.1-#1 RF Power Out: §27.50, §2.1046; Test results; Downlink; CDMA Middle



5.3.1.2 W-CDMA

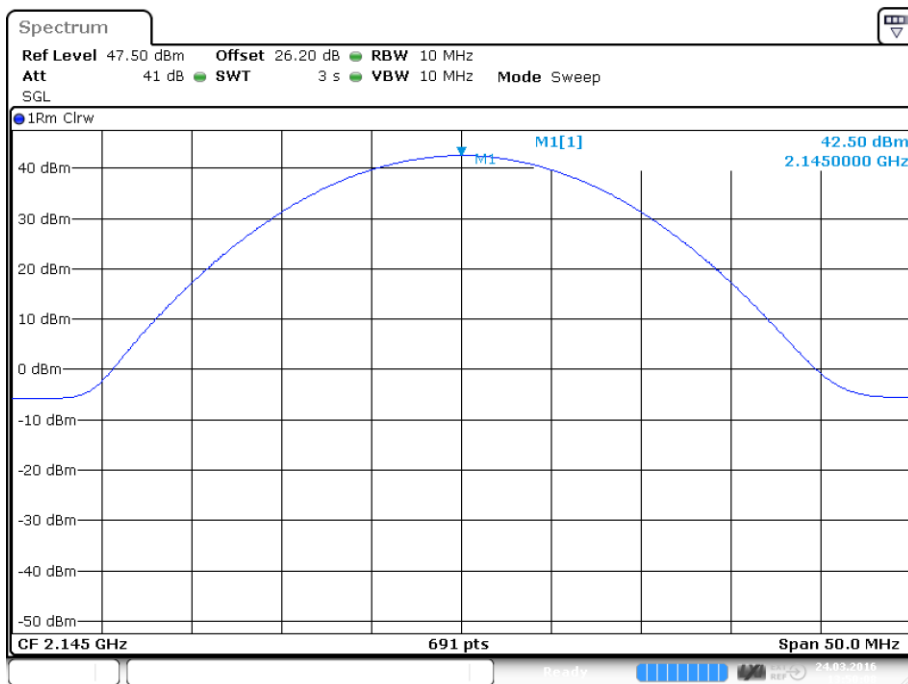

Date: 24.MAR.2016 13:50:07

plot 5.3.1.2-#1 RF Power Out: §27.50, §2.1046; Test results; Downlink; W-CDMA Middle

5.3.1.3 LTE

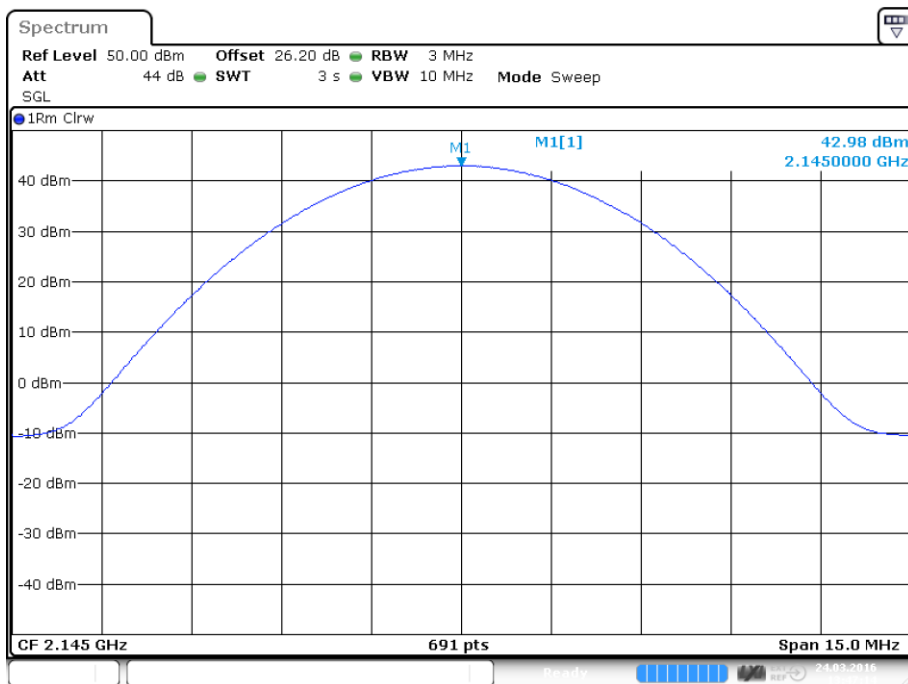

Date: 24.MAR.2016 13:47:14

plot 5.3.1.3-#1 RF Power Out: §27.50, §2.1046; Test results; Downlink; LTE Middle



5.3.2 Uplink

n. a.

Note: The EUT does not transmit over the air in the uplink direction.

5.4 Summary test result

Test result	complies, according the plots above
Tested by:	M. Leinfelder
Date:	24.03.2016



6 Occupied Bandwidth: §2.1049

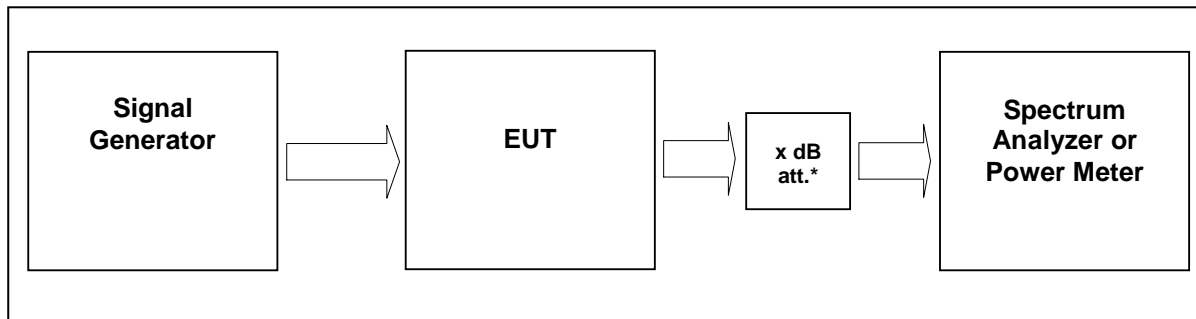

External Attenuator DL x dB = 20 dB
 figure 6-#1 Test setup: Occupied Bandwidth: §2.1049

Measurement uncertainty	± 0,38 dB
Test equipment used	9291, 9233, 7444; 7321; 7144; 7454; 7453; 7336; 7449; 7368

6.1 Limit

The spectral shape of the output should look similar to input for all modulations.

6.2 Test method

Para. No.2.1049

The occupied bandwidth, that is the frequency bandwidth such that, below its lower and above its upper frequency limits, the mean powers radiated are each equal to 0.5 percent of the total mean power radiated by a given emission shall be measured under the following conditions as applicable:

(h) Transmitters employing digital modulation techniques—when modulated by an input signal such that its amplitude and symbol rate represent the maximum rated conditions under which the equipment will be operated. The signal shall be applied through any filter networks, pseudo-random generators or other devices required in normal service. Additionally, the occupied bandwidth shall be shown for operation with any devices used for modifying the spectrum when such devices are optional at the discretion of the user.



6.3 Test results

6.3.1 Downlink

Detector PK.

Modulation	Measured at	F center / MHz	RBW VBW Span	Occupied Bandwidth / MHz	Plot #
CDMA	Middle	2145	30kHz 300kHz 5MHz	1.2	6.3.1.1 #1, #2
WCDMA	Middle	2145	100kHz 1MHz 10MHz	3.8	6.3.1.2 #1, #2
LTE	Middle	2145	30 kHz 300 kHz 5 MHz	1.05	6.3.1.3 #1,#2

Modulation	Measured at	F center / MHz	RBW VBW Span	26dB Bandwidth / MHz	Plot #
CDMA	Middle	2145	30kHz 300kHz 5MHz	1.4	6.3.2.1 #1, #2
WCDMA	Middle	2145	100kHz 1MHz 10MHz	4.7	6.3.2.2 #1, #2
LTE	Middle	2145	30 kHz 300 kHz 5 MHz	1.3	6.3.2.3 #1,#2

table 6.3-#1 Occupied Bandwidth: §2.1049 Test results Downlink



6.3.1.1 CDMA

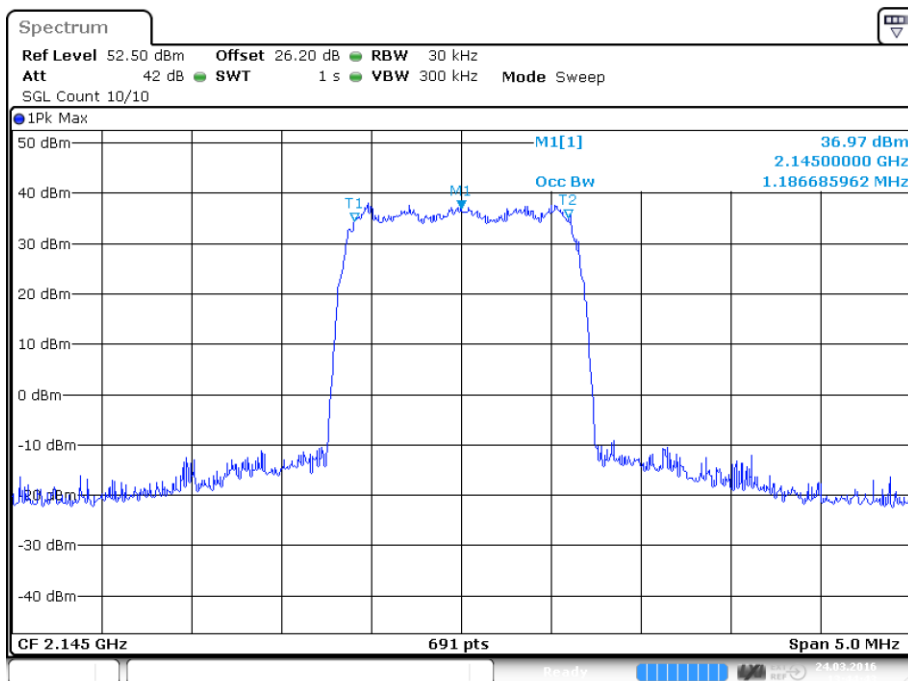

Date: 24.MAR.2016 13:44:43

plot 6.3.1.1-#1 Occupied Bandwidth: \$2.1049; Test results; Downlink; CDMA Output

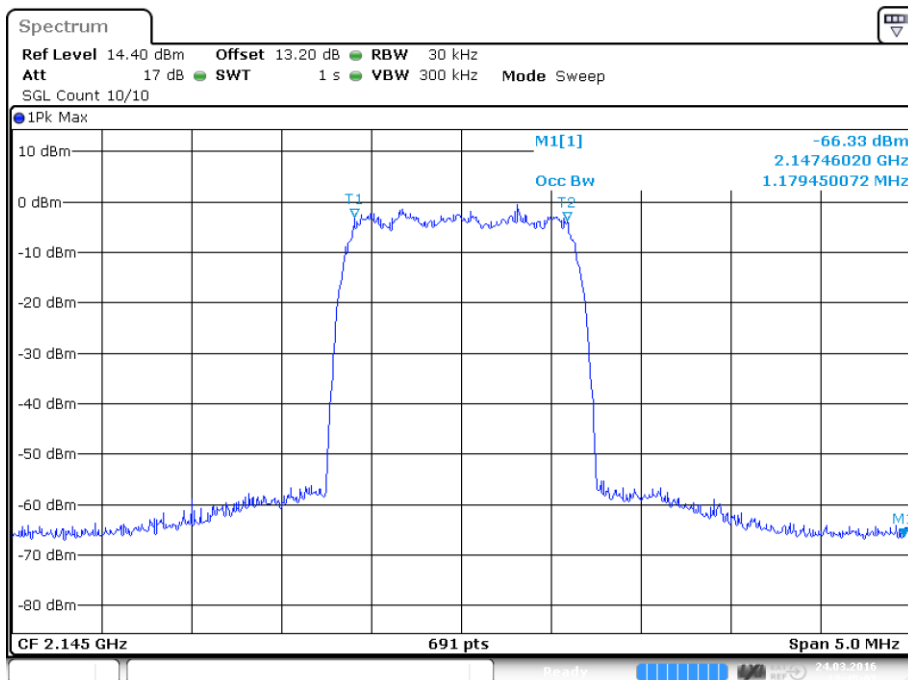

Date: 24.MAR.2016 13:45:07

plot 6.3.1.1-#2 Occupied Bandwidth: \$2.1049; Test results; Downlink; CDMA Input



6.3.1.2 W-CDMA

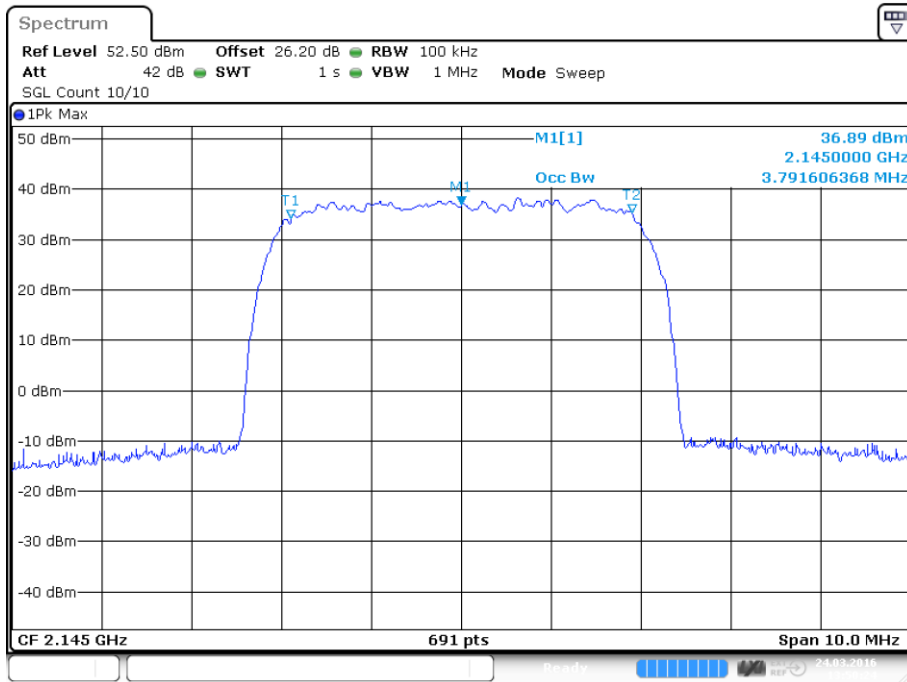

plot 6.3.1.2-#1 Occupied Bandwidth: 3.791606368 MHz; Test results; Downlink; W-CDMA Output

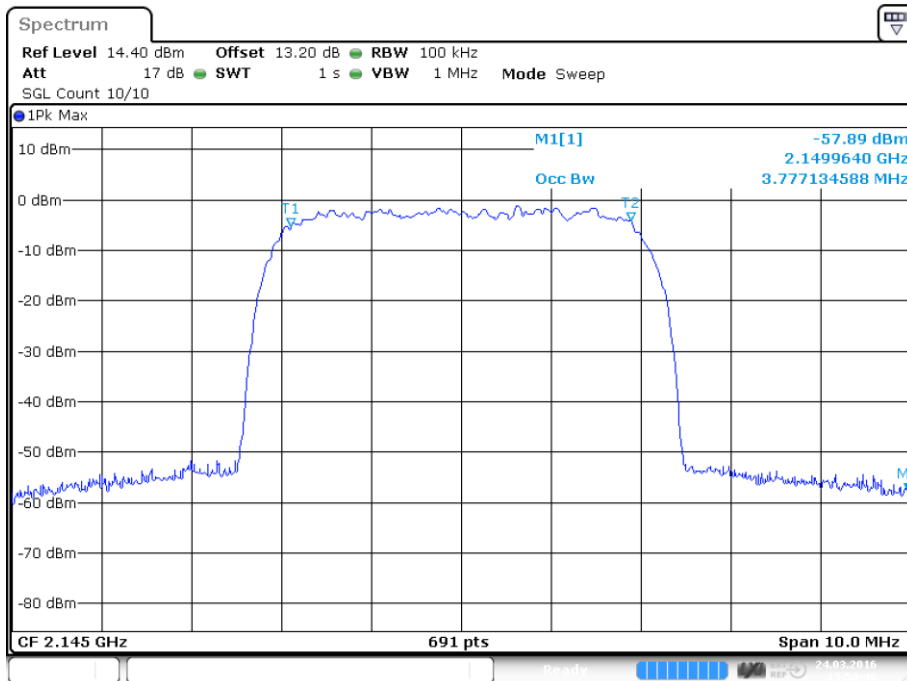

plot 6.3.1.2-#2 Occupied Bandwidth: 3.777134588 MHz; Test results; Downlink; W-CDMA Input



6.3.1.3 LTE

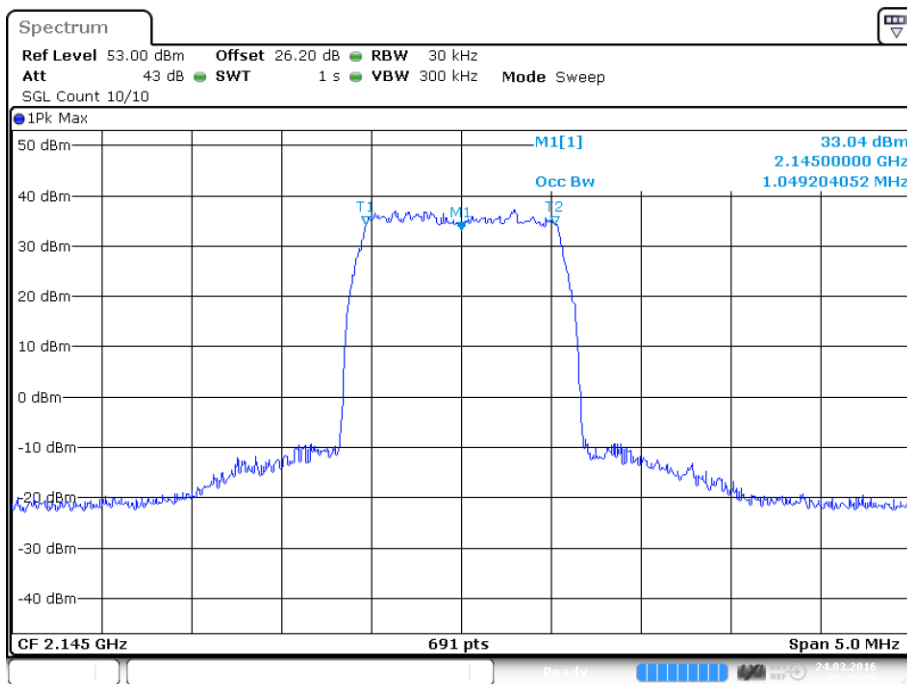

Date: 24.MAR.2016 13:47:31

plot 6.3.1.3-#1 Occupied Bandwidth: \$2.1049; Test results; Downlink; LTE Output

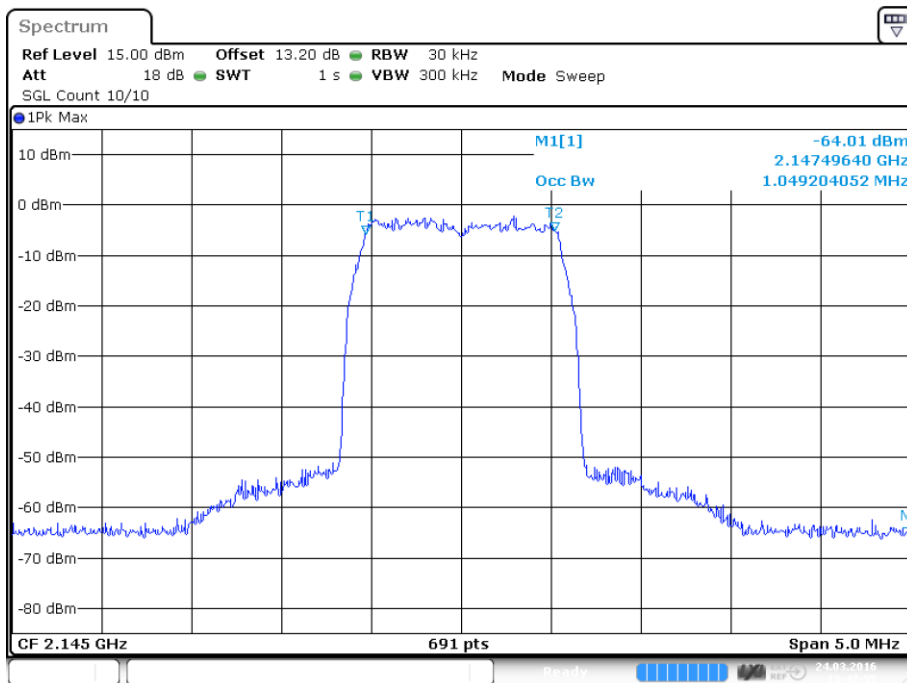

Date: 24.MAR.2016 13:47:55

plot 6.3.1.3-#2 Occupied Bandwidth: \$2.1049; Test results; Downlink; LTE Input



6.3.2 26dB Bandwidth

6.3.2.1 CDMA

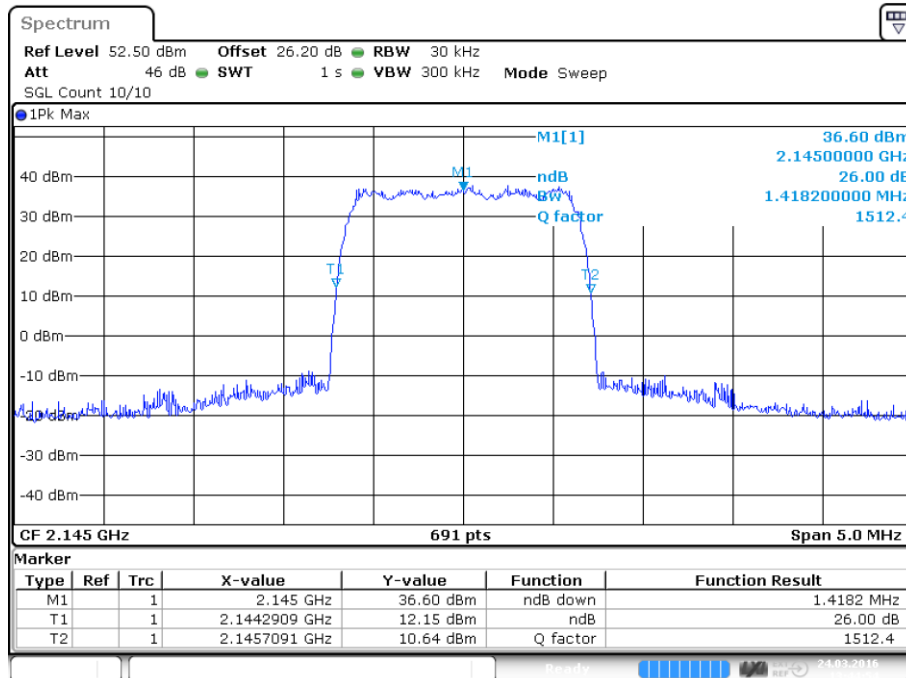

Date: 24.MAR.2016 13:44:55

plot 6.3.2.1-#1 Occupied Bandwidth: §2.1049; Test results; 26dB Bandwidth; CDMA Output

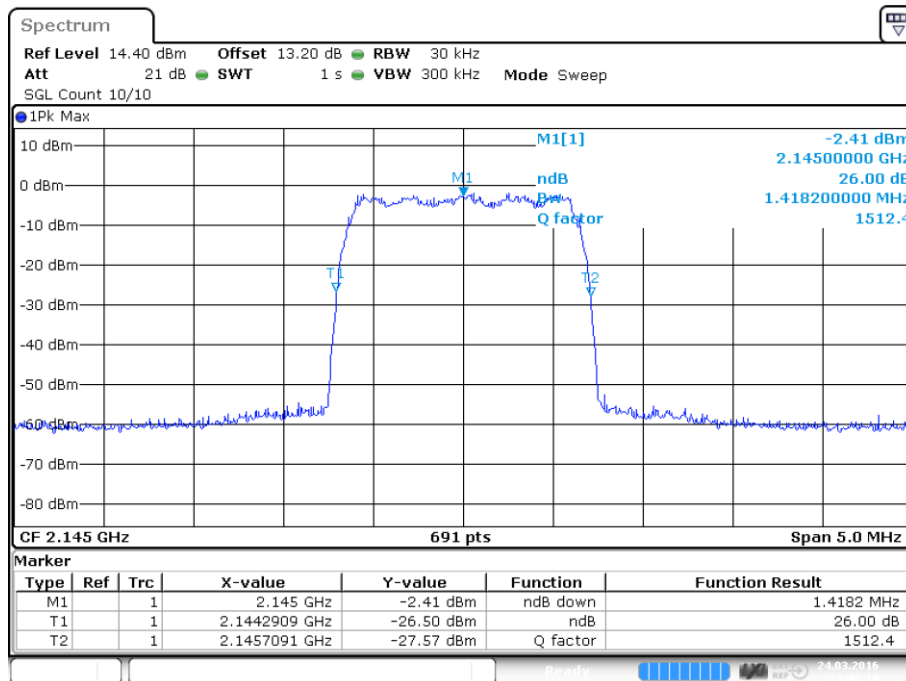

Date: 24.MAR.2016 13:45:18

plot 6.3.2.1-#2 Occupied Bandwidth: §2.1049; Test results; 26dB Bandwidth; CDMA Input



6.3.2.2 W-CDMA

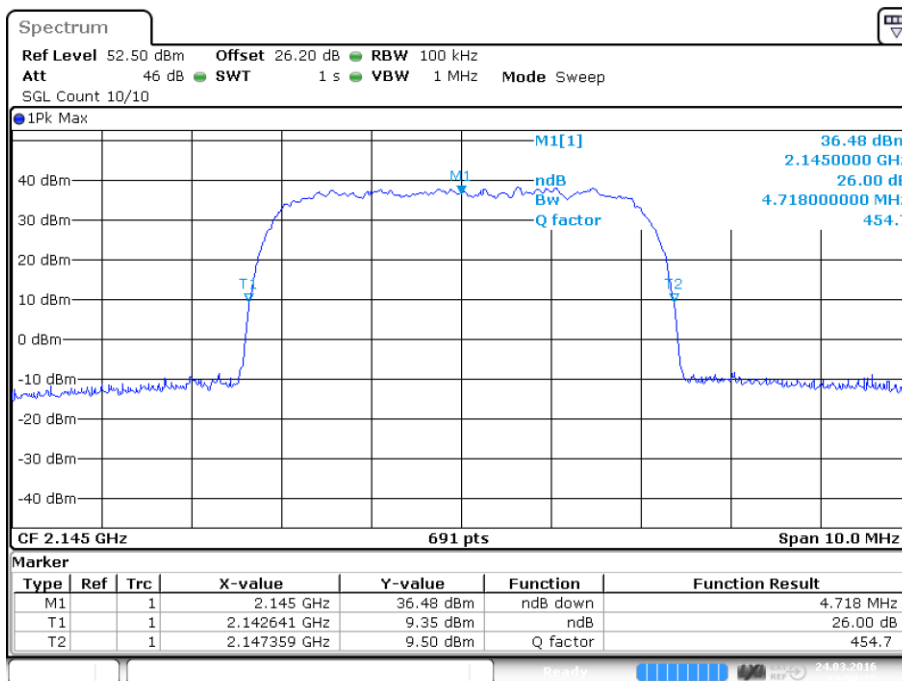

Date: 24.MAR.2016 13:50:35

plot 6.3.2.2-#1 Occupied Bandwidth: \$2.1049; Test results; 26dB Bandwidth; W-CDMA Output

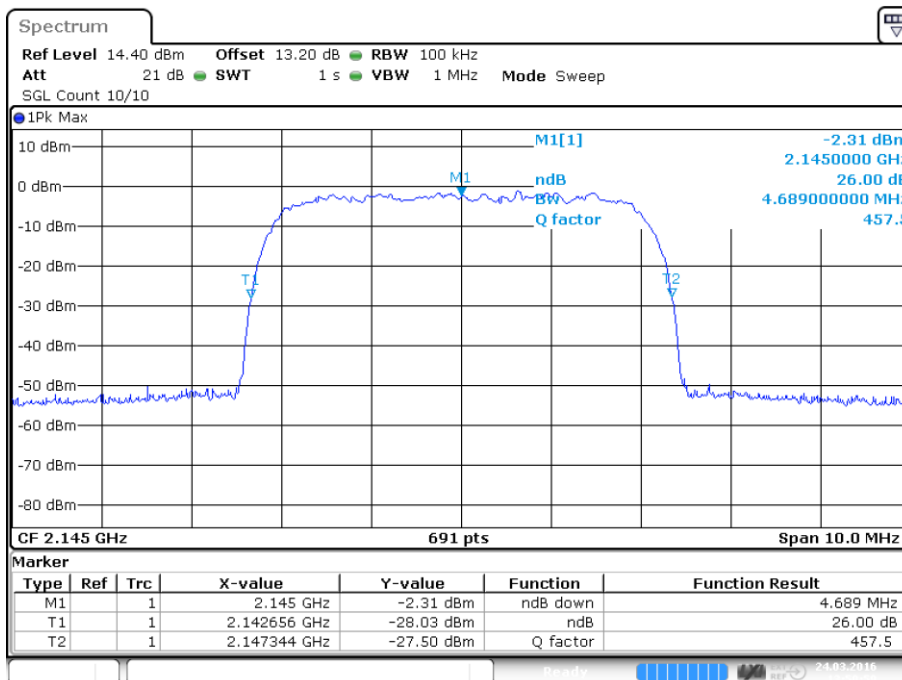

Date: 24.MAR.2016 13:50:59

plot 6.3.2.2-#2 Occupied Bandwidth: \$2.1049; Test results; 26dB Bandwidth; W-CDMA Input



6.3.2.3 LTE

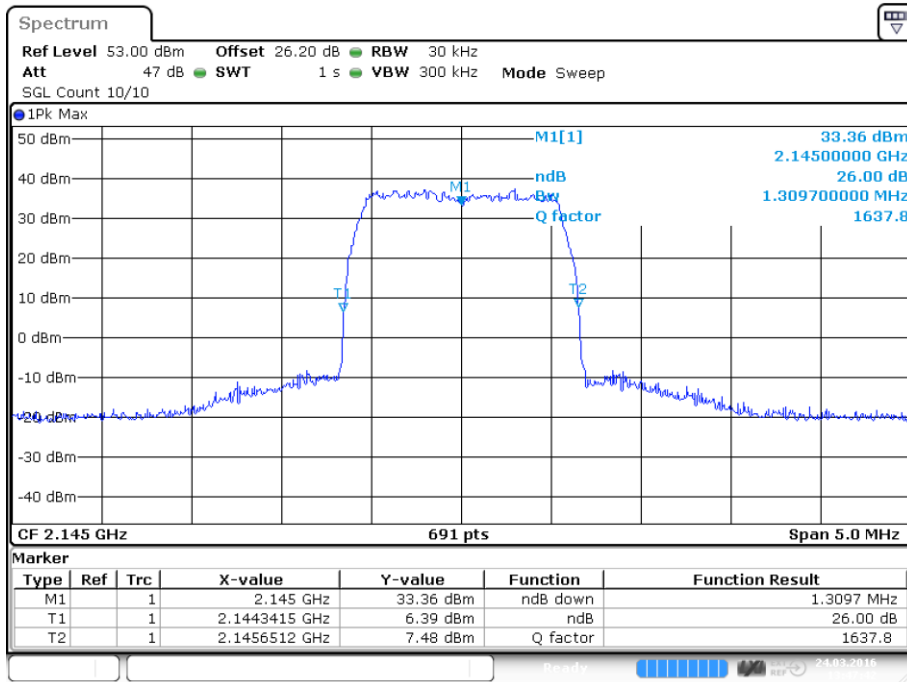

Date: 24.MAR.2016 13:47:42

plot 6.3.2.3-#1 Occupied Bandwidth: §2.1049; Test results; 26dB Bandwidth; LTE Output

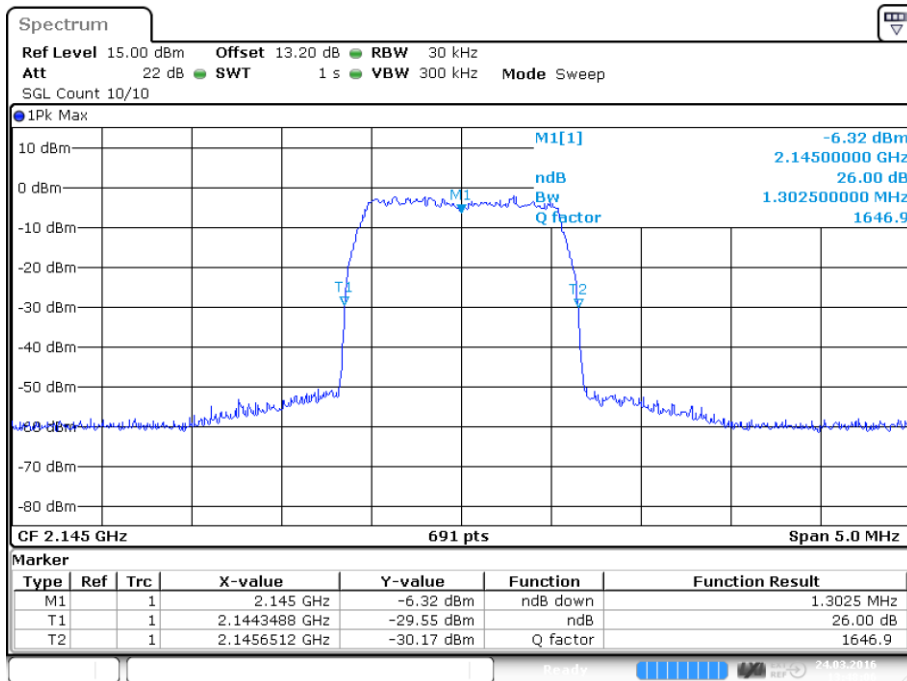

Date: 24.MAR.2016 13:48:06

plot 6.3.2.3-#2 Occupied Bandwidth: §2.1049; Test results; 26dB Bandwidth; LTE Input



6.3.3 Uplink

n. a.

Note: The EUT does not transmit over the air in the uplink direction.

6.4 Summary test result

Test result	complies, according the plots above
Tested by:	M. Leinfelder
Date:	24.03.2016



7 Spurious Emissions at Antenna Terminals: §27.53, §2.1051

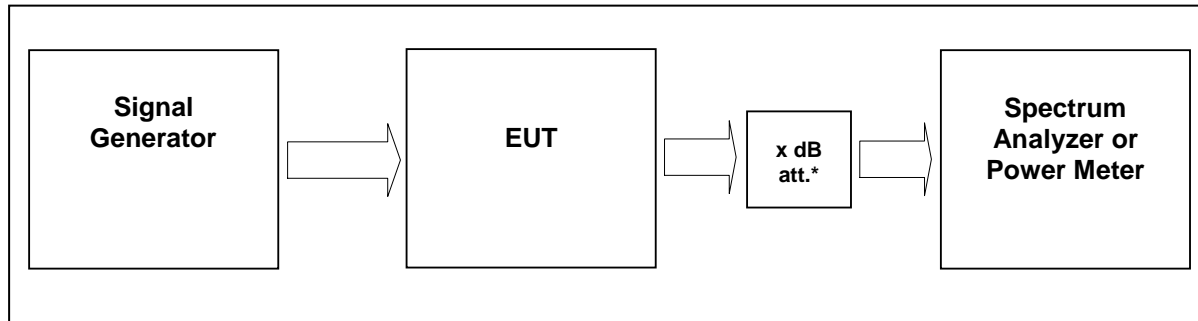

External Attenuator DL x dB = 20 dB

figure 7-#1 Test setup: Spurious Emissions at Antenna Terminals: §27.53, §2.1051

Measurement uncertainty	± 0,54 dB ± 1,2 dB ± 1,5 dB	9 kHz to 3 GHz 3 GHz to 7 GHz 7 GHz to 26 GHz
Test equipment used	9291, 9233, 7444; 7321; 7144; 7454; 7453; 7336; 7449; 7368	

7.1 Limit

Minimum standard:

Para. No.27.53(h)

(h) *AWS emission limits*

(1) *General protection levels.* Except as otherwise specified below, for operations in the 1695-1710 MHz, 1710-1755 MHz, 1755-1780 MHz, 1915-1920 MHz, 1995-2000 MHz, 2000-2020 MHz, 2110-2155 MHz, 2155-2180 MHz, and 2180-2200 bands, the power of any emission outside a licensee's frequency block shall be attenuated below the transmitter power (P) in watts by at least $43 + 10 \log_{10} (P)$ dB.

(3) *Measurement procedure.* (i) Compliance with this provision is based on the use of measurement instrumentation employing a resolution bandwidth of 1 megahertz or greater. However, in the 1 megahertz bands immediately outside and adjacent to the licensee's frequency block, a resolution bandwidth of at least one percent of the emission bandwidth of the fundamental emission of the transmitter may be employed. The emission bandwidth is defined as the width of the signal between two points, one below the carrier center frequency and one above the carrier center frequency, outside of which all emissions are attenuated at least 26 dB below the transmitter power.

(ii) When measuring the emission limits, the nominal carrier frequency shall be adjusted as close to the licensee's frequency block edges, both upper and lower, as the design permits.

(iii) The measurements of emission power can be expressed in peak or average values, provided they are expressed in the same parameters as the transmitter power.

7.2 Test method

Para. No 2.1051 Measurements required: Spurious emissions at antenna terminals.

The radio frequency voltage or powers generated within the equipment and appearing on a spurious frequency shall be checked at the equipment output terminals when properly loaded with a suitable artificial antenna. Curves or equivalent data shall show the magnitude of each harmonic and other spurious emission that can be detected when the equipment is operated under the conditions specified in § 2.1049 as appropriate. The magnitude of spurious emissions which are attenuated more than 20 dB below the permissible value need not be specified.

[39 FR 5919, Feb. 15, 1974. Redesignated and amended at 63 FR 36599, July 7, 1998]



7.3 Test results

7.3.1 Downlink

Detector: RMS.

Modulation	Carrier	RBW VBW Span	Max. level (dBm)	Plot -
CDMA	2145 MHz	1MHz 3MHz 30MHz – 23GHz	-24.8	7.3.1.1 #1
WCDMA	2145 MHz	1MHz 3MHz 30MHz – 23GHz	-24.8	7.3.1.2 #1
LTE	2145 MHz	1MHz 3MHz 30MHz – 23GHz	-25.2	7.3.1.3 #1

table 7.3-#1 Spurious Emissions at Antenna Terminals: §27.53, §2.1051 Test results



7.3.1.1 CDMA

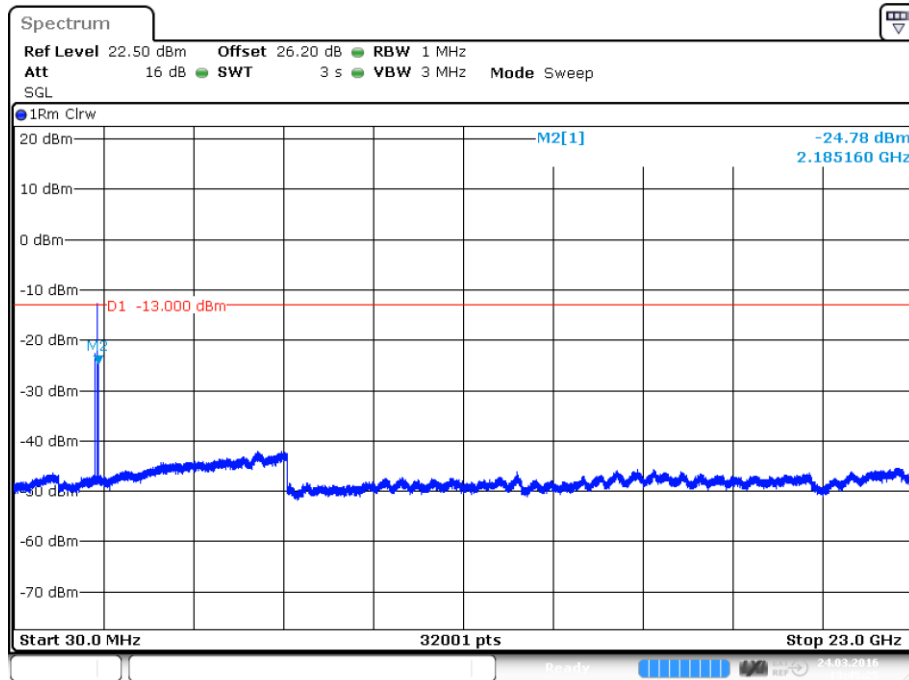

Date: 24.MAR.2016 13:45:25

plot 7.3.1.1-#1 Spurious Emissions at Antenna Terminals: §27.53, §2.1051; Test results; Downlink; CDMA; carrier (2145MHz) notched

7.3.1.2 W-CDMA

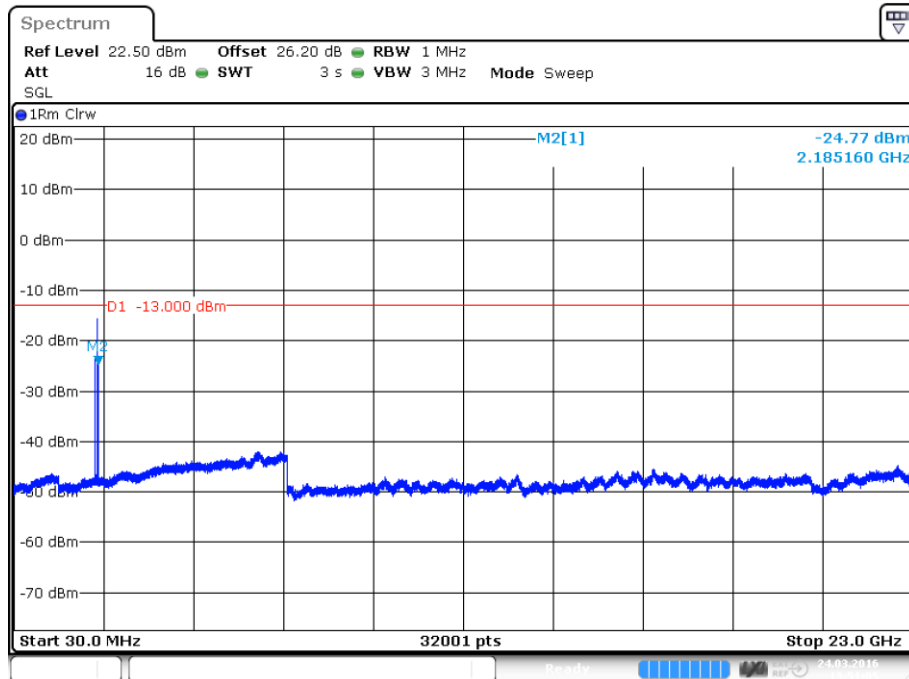

Date: 24.MAR.2016 13:51:06

plot 7.3.1.2-#1 Spurious Emissions at Antenna Terminals: §27.53, §2.1051; Test results; Downlink; W-CDMA; carrier (2145MHz) notched



7.3.1.3 LTE

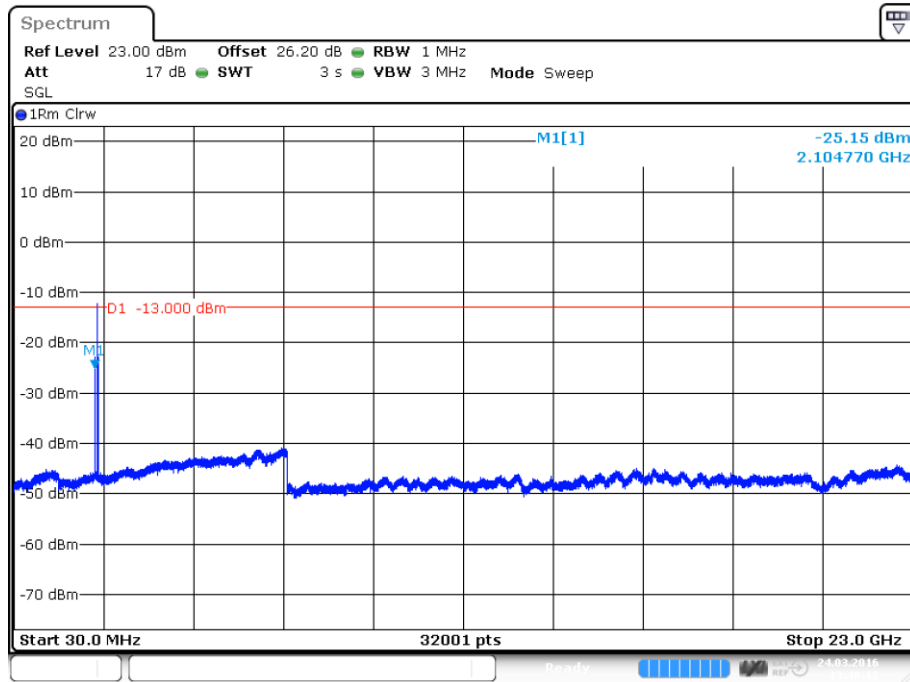

Date: 24.MAR.2016 13:48:13

plot 7.3.1.3-#1 Spurious Emissions at Antenna Terminals: §27.53, §2.1051; Test results; Downlink; LTE; carrier (2145MHz) notched

7.3.2 Uplink

n. a.

Note: The EUT does not transmit over the air in the uplink direction.

7.4 Summary test result

Test result	complies, according the plots above
Tested by:	M. Leinfelder
Date:	24.03.2016



8 Intermodulation: §27.53, §2.1051

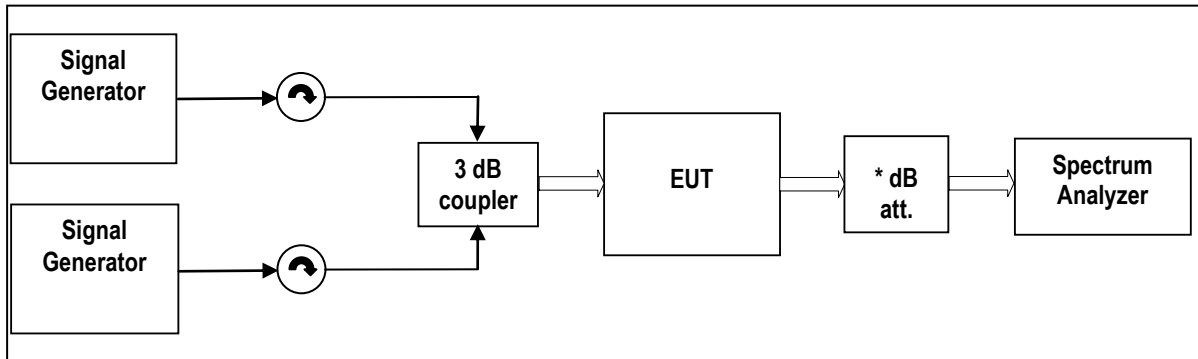

External Attenuator DL x dB = 20 dB
figure 8-#1 Test setup: Intermodulation: §27.53, §2.1051

Measurement uncertainty	± 0,54 dB ± 1,2 dB ± 1,5 dB	9 kHz to 3 GHz 3 GHz to 7 GHz 7 GHz to 26 GHz
Test equipment used	9291, 8849; 9233, 7444; 7321; 7326; 7144; 7454; 7453; 7336; 7449; 7368	

8.1 Limit

Minimum standard:

Minimum standard:

Para. No.27.53(h)

(h) *AWS emission limits*

(1) *General protection levels.* Except as otherwise specified below, for operations in the 1695-1710 MHz, 1710-1755 MHz, 1755-1780 MHz, 1915-1920 MHz, 1995-2000 MHz, 2000-2020 MHz, 2110-2155 MHz, 2155-2180 MHz, and 2180-2200 bands, the power of any emission outside a licensee's frequency block shall be attenuated below the transmitter power (P) in watts by at least $43 + 10 \log_{10}(P)$ dB.

(3) *Measurement procedure.* (i) Compliance with this provision is based on the use of measurement instrumentation employing a resolution bandwidth of 1 megahertz or greater. However, in the 1 megahertz bands immediately outside and adjacent to the licensee's frequency block, a resolution bandwidth of at least one percent of the emission bandwidth of the fundamental emission of the transmitter may be employed. The emission bandwidth is defined as the width of the signal between two points, one below the carrier center frequency and one above the carrier center frequency, outside of which all emissions are attenuated at least 26 dB below the transmitter power.

(ii) When measuring the emission limits, the nominal carrier frequency shall be adjusted as close to the licensee's frequency block edges, both upper and lower, as the design permits.

(iii) The measurements of emission power can be expressed in peak or average values, provided they are expressed in the same parameters as the transmitter power.

8.2 Test method

Para. No 2.1051 Measurements required: Spurious emissions at antenna terminals.

The radio frequency voltage or powers generated within the equipment and appearing on a spurious frequency shall be checked at the equipment output terminals when properly loaded with a suitable artificial antenna. Curves or equivalent data shall show the magnitude of each harmonic and other spurious emission that can be detected when the equipment is operated under the conditions specified in § 2.1049 as appropriate. The magnitude of spurious emissions which are attenuated more than 20 dB below the permissible value need not be specified.

[39 FR 5919, Feb. 15, 1974. Redesignated and amended at 63 FR 36599, July 7, 1998]



8.3 Test results

8.3.1 Downlink

Detector: RMS.

Modulation	Measured at Band Edge	Carriers	RBW VBW Span	Max. level (dBm)	Plot -
CDMA	Lower Edge	2110.775 MHz 2112.025 MHz	30kHz 300kHz 6MHz	-23.1	8.3.1.1 #1
	Upper Edge	2177.975 MHz 2179.225 MHz			#2
WCDMA	Lower Edge	2112.6 MHz 2117.6 MHz	100kHz 1MHz 15MHz	-25.6	8.3.1.2 #1
	Upper Edge	2172.4 MHz 2177.4 MHz			#2
LTE	Lower Edge	2110.7 MHz 2112.1 MHz	30kHz 300kHz 6MHz	-25.5	8.3.1.3 #1
	Upper Edge	2177.9 MHz 2179.3 MHz			#2

table 8.3-#1 Intermodulation: §27.53, §2.1051 Test results



8.3.1.1 CDMA

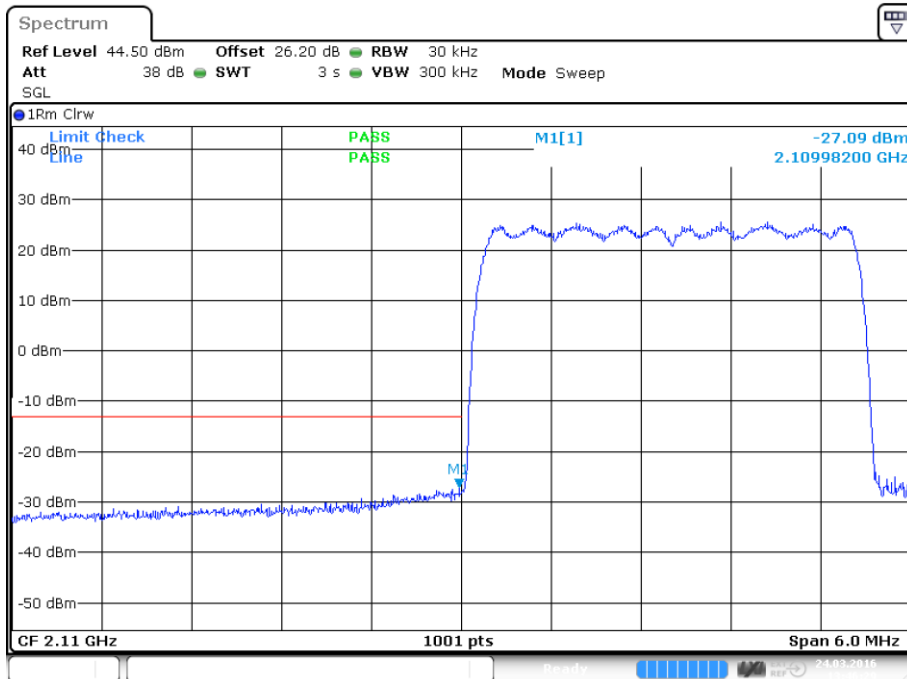

plot 8.3.1.1-#1 Intermodulation: §27.53, §2.1051; Test results; Downlink; CDMA Lower Band Edge

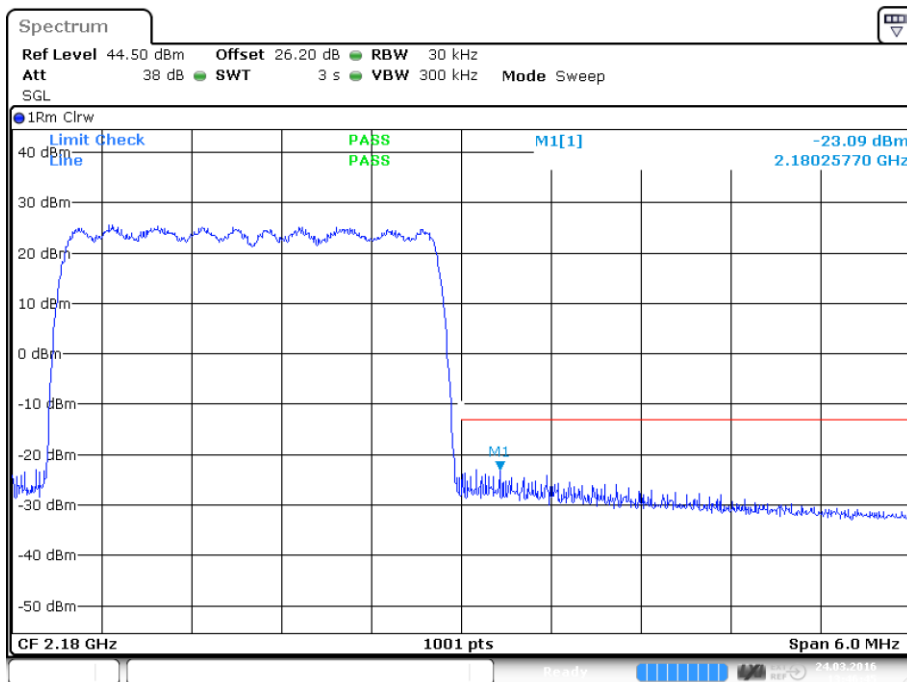

plot 8.3.1.1-#2 Intermodulation: §27.53, §2.1051; Test results; Downlink; CDMA Upper Band Edge



8.3.1.2 WCDMA

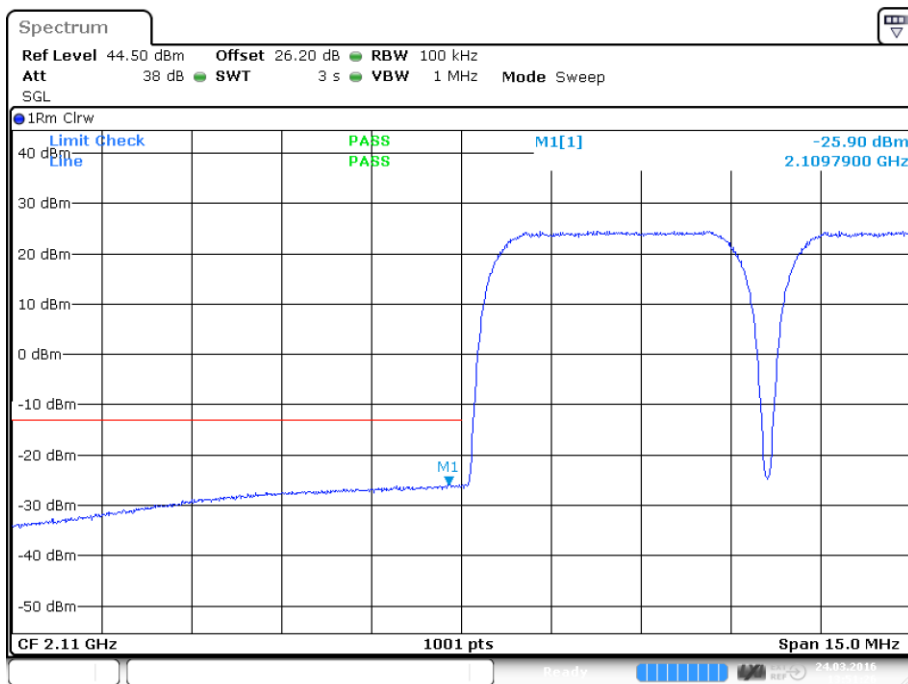

Date: 24.MAR.2016 13:51:26

plot 8.3.1.2-#1 Intermodulation: §27.53, §2.1051; Test results; Downlink; WCDMA Lower Band Edge

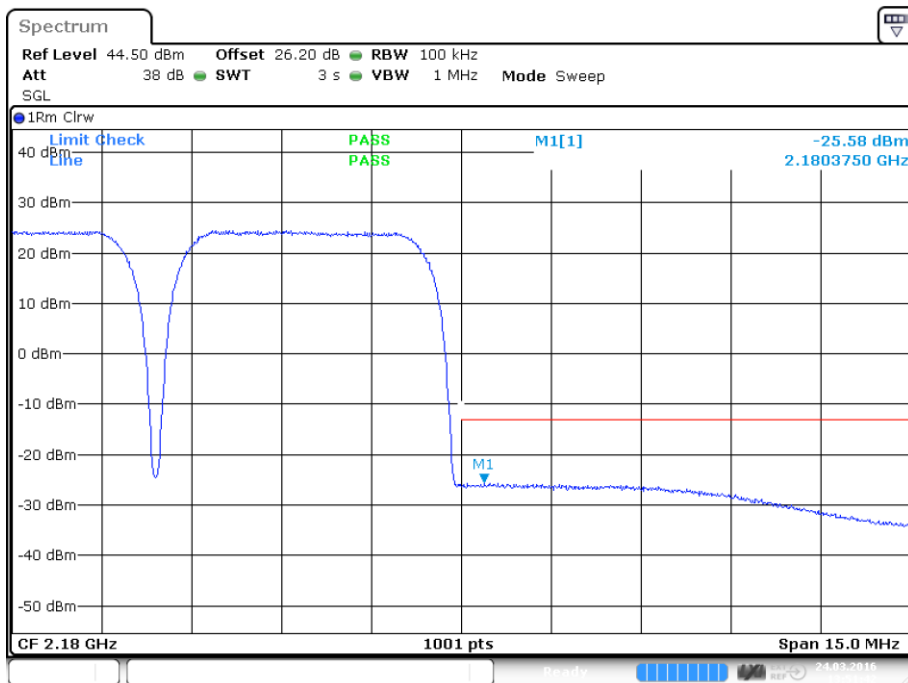

Date: 24.MAR.2016 13:51:43

plot 8.3.1.2-#2 Intermodulation: §27.53, §2.1051; Test results; Downlink; WCDMA Upper Band Edge



8.3.1.3 LTE

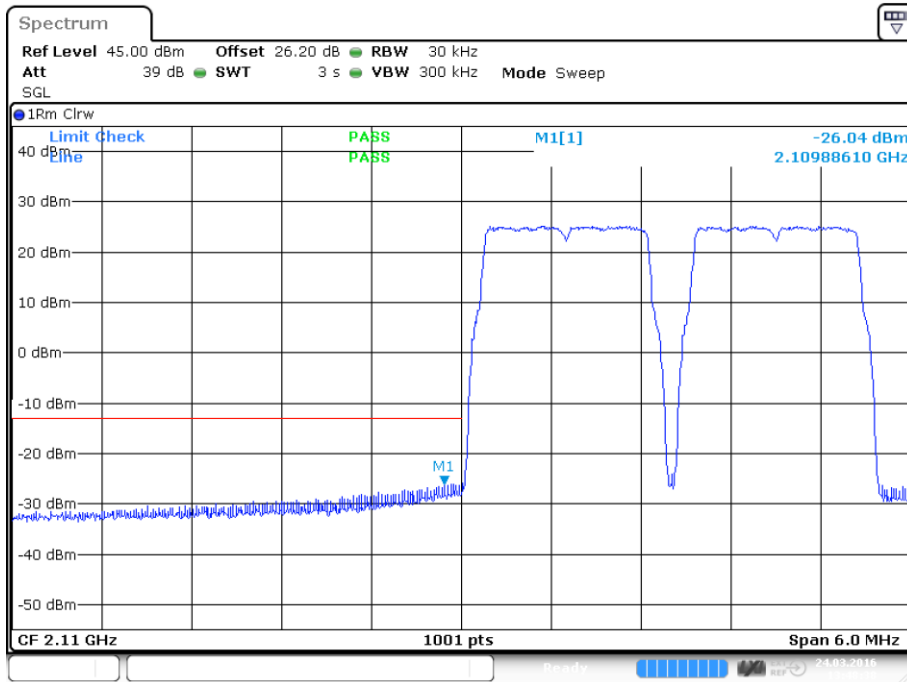

Date: 24.MAR.2016 13:48:39

plot 8.3.1.3-#1 Intermodulation: §27.53, §2.1051; Test results; Downlink; LTE Lower Band Edge

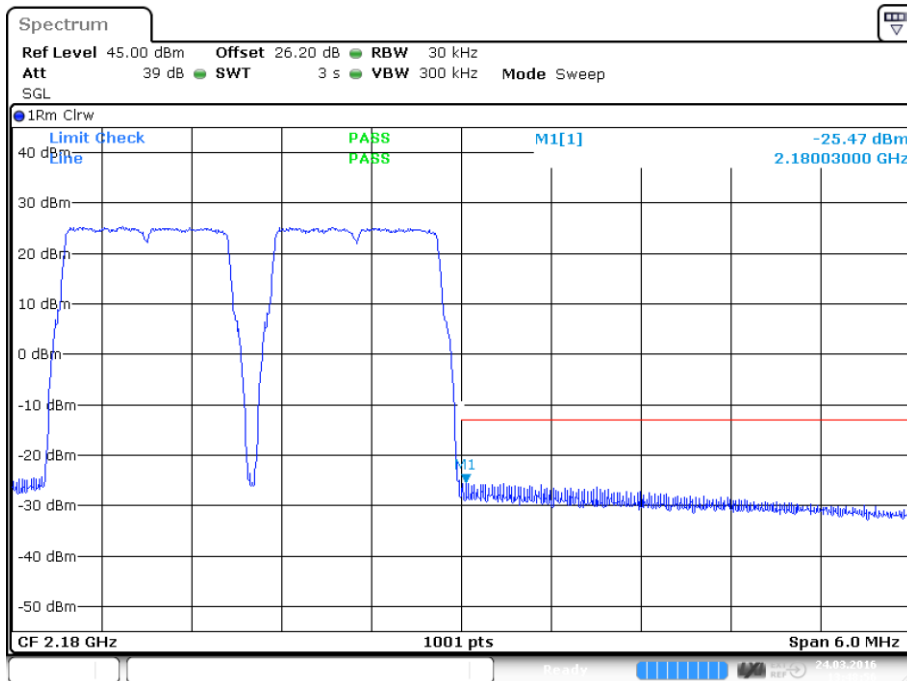

Date: 24.MAR.2016 13:48:55

plot 8.3.1.3-#2 Intermodulation: §27.53, §2.1051; Test results; Downlink; LTE Upper Band Edge



8.3.2 Uplink

n. a.

Note: The EUT does not transmit over the air in the uplink direction.

8.4 Summary test result

Test result	complies, according the plots above
Tested by:	M. Leinfelder
Date:	24.03.2016



9 Out of Band Rejection

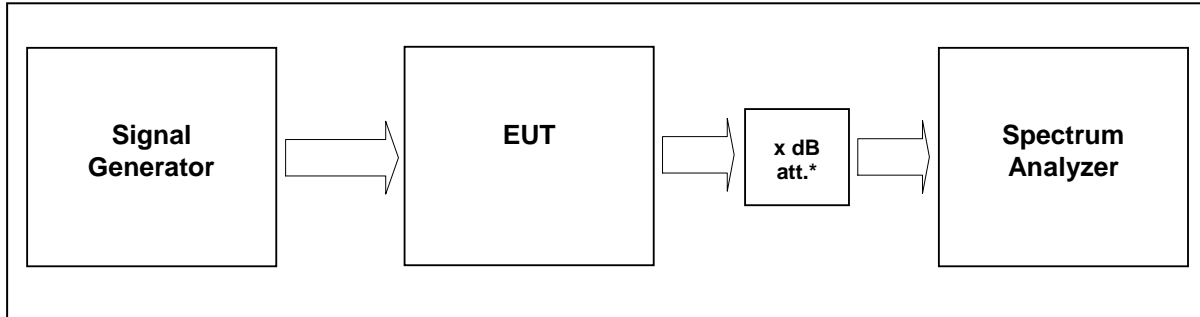

External Attenuator DL x dB = 20 dB
figure 9-#1 Test setup: Out of Band Rejection

Measurement uncertainty	± 0,38 dB
Test equipment used	9291, 9233, 7444; 7321; 7144; 7454; 7453; 7336; 7449; 7368

9.1 Limit

KDB 935210 D02 v03r02

Test for rejection of out of band signals. Filter frequency response plots are acceptable.

9.2 Test method

935210 D03 v04

7.1 Authorized frequency band verification test

9.3 Test results

Detector Peak max hold



9.3.1 Downlink

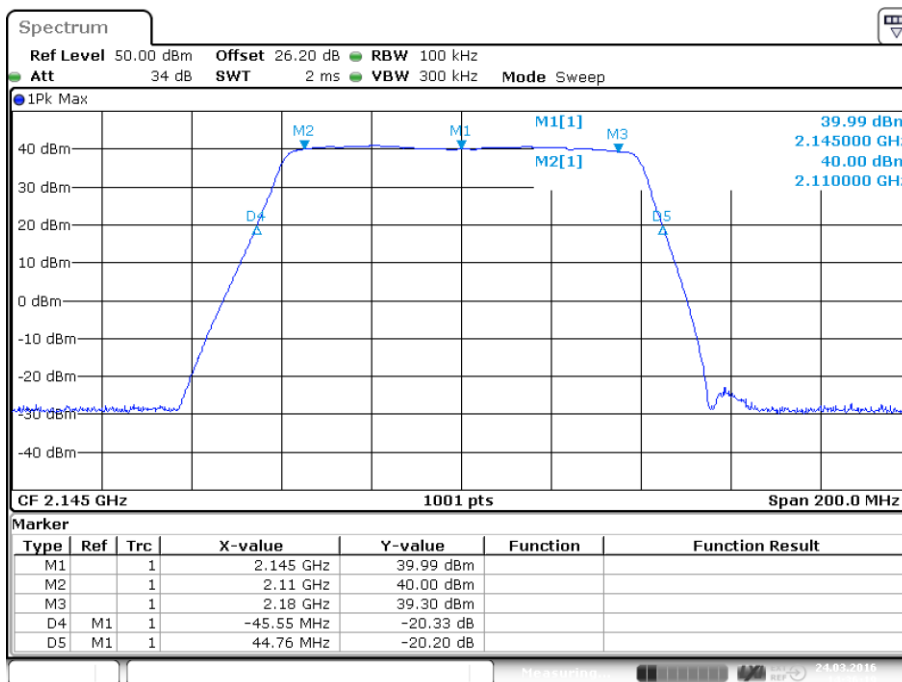

Date: 24.MAR.2016 14:36:19

plot 9.3.1-#1 Out of Band Rejection; Test results; Downlink;

9.3.2 Uplink

n.a.

Note: The EUT does not transmit over the air in the uplink direction.

9.4 Summary test result

Test result	complies, according the plots above
Tested by:	M. Leinfelder
Date:	24.03.2016

10 Field Strength of Spurious Emissions: §27.53, §2.1053

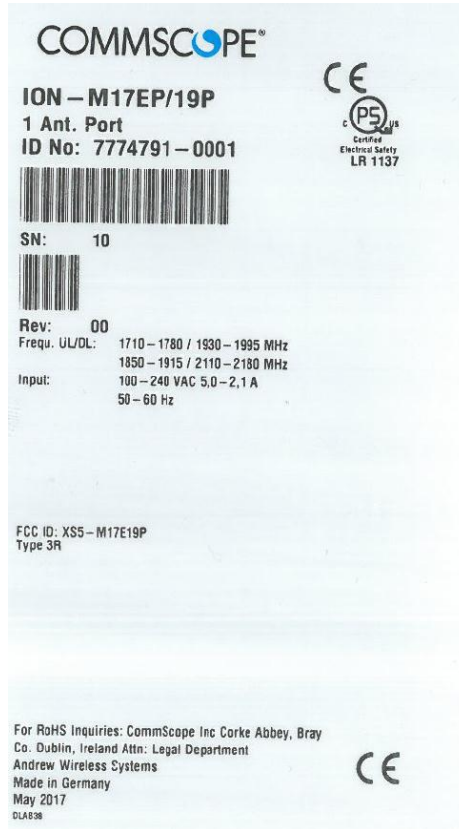

picture 8.1: label (EUT)

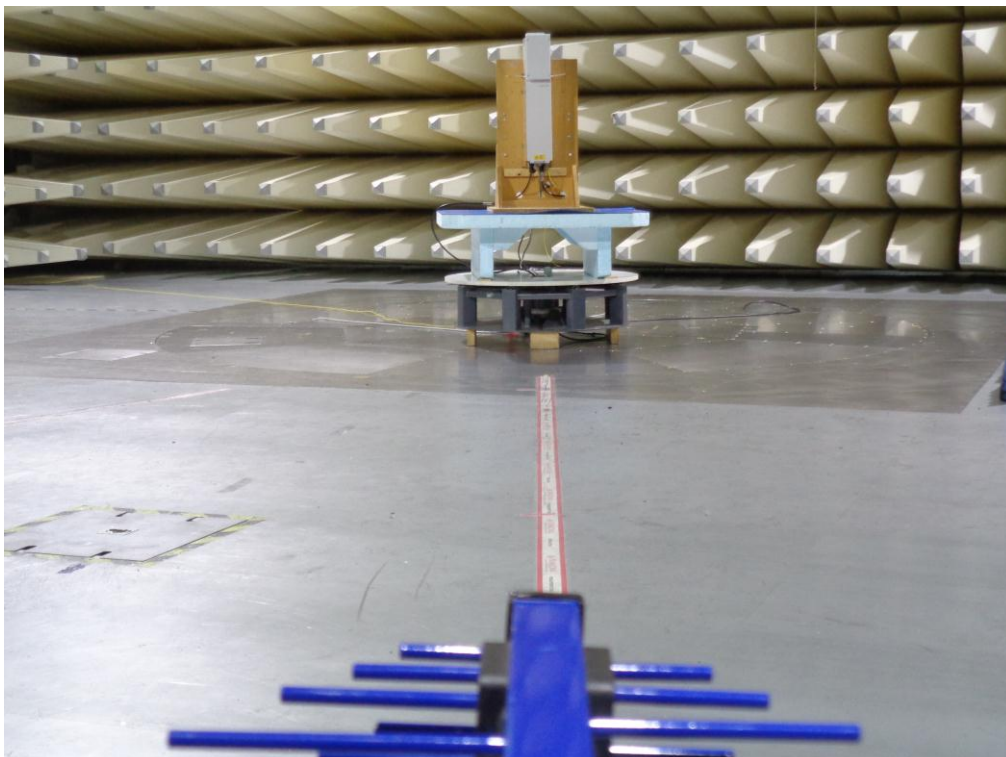

picture 8.2: Test setup: Field Strength Emission 30 M – 1 GHz @10m in the SAC

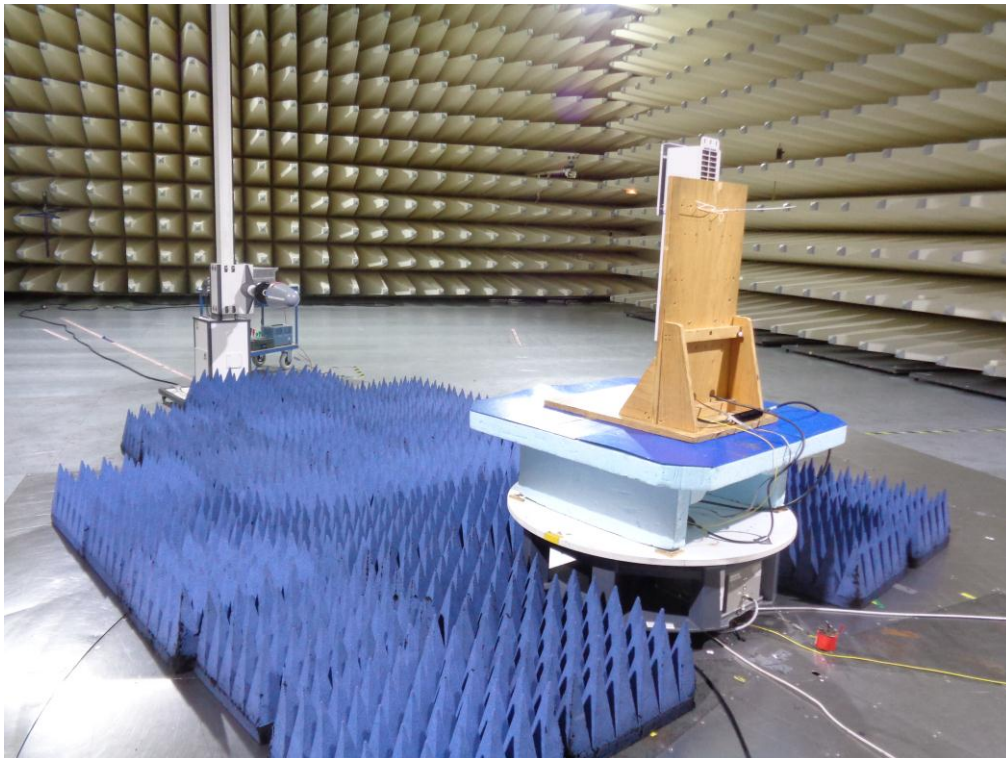

picture 8.3: Test setup: Field Strength Emission 1 – 18 GHz @3m in the SAC

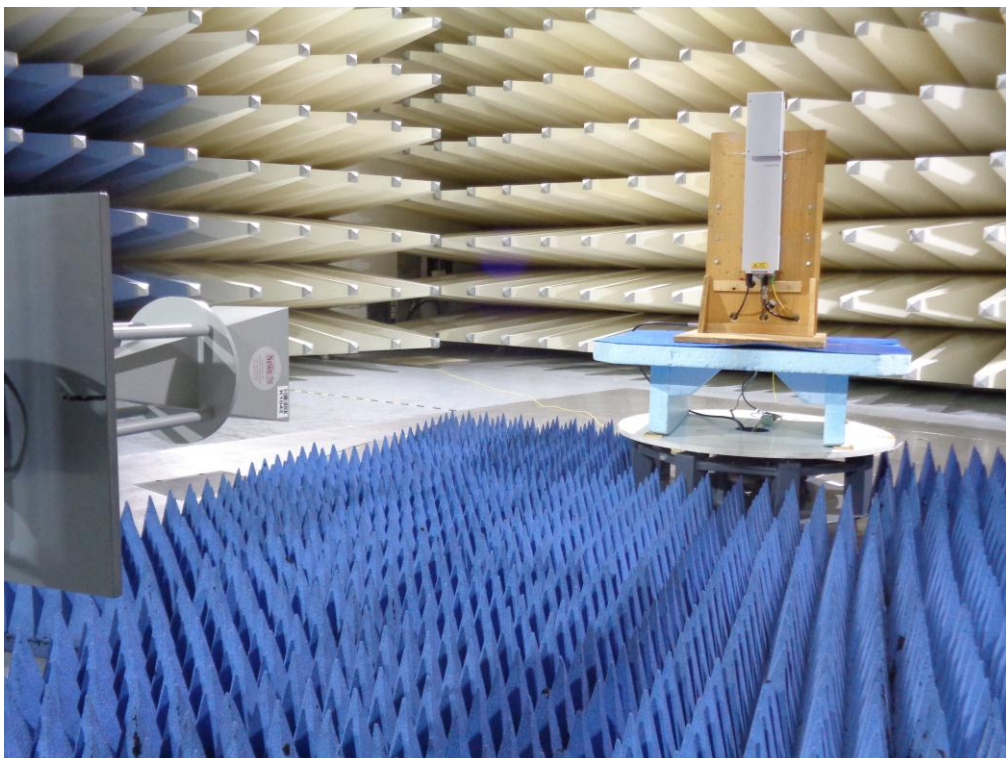

picture 8.4: Test setup: Field Strength Emission 18 – 26.5 GHz @3m in the SAC



This clause specifies requirements for the measurement of radiated emission.

Frequency range	Distance: EUT <-> antenna / location	Limit	Test method
30 MHz – 1 GHz	10 metres / SAC	FCC 47 CFR Part 27.53	TIA/EIA-603-C:2004
1 GHz – 18 GHz	3 metres / SAC		
18 GHz – 26.5 GHz	3 metres / SAC		

Test equipment used:

Designation	Type	Manufacturer	Invent.-no.	Cal.-date	due Cal.- date	used
EMI test receiver	ESU40	Rohde & Schwarz	E2025	18.10.2016	18.10.2017	X
Antenna	CBL 6111	Chase	K1026	26.05.2017	26.05.2018	X
Antenna	HL 025	R&S	K1114	24.05.2017	24.05.2018	X
Preamplifier	AFS4-00102000	Miteq	K838	10.05.2017	10.05.2018	X
RF Cable	Sucoflex 100	Suhner	K1760	04.08.2015	04.08.2017	X
Antenna	JTXLB-42-25- C-KF	A-Info	K1175	09.03.2015	09.03.2018	X

The REMI version 2.135 has been used to maximize radiated emission from the EUT with regards to ANSI C63.4:2014.

Test set-up:

Test location: SAC
 Both, the Fully Anechoic Chamber (FAC) and the Semi Anechoic Chamber (SAC) fulfil the requirements of ANSI C63.4 and CISPR 16-1-4 with regards to NSA and SVSWR.

Test Voltage: 110V / 60 Hz
 Type of EUT: Wall mounted

Measurement uncertainty:

Measurement uncertainty expanded (95% or K=2)	± 5,0 dB for ANSI C63.4 measurement ± 0,5 dB for TIA-603 measurement
--	---

10.1 Method of Measurement

Measurement procedure. TIA-603-C

The antenna substitution method is used to determine the equivalent radiated power at spurious frequencies. The spurious emissions are measured at a distance of 3 meters. The EUT is then replaced with a reference substitution antenna with a known gain referenced to a dipole. This antenna is fed with a signal at the spurious frequency. The level of the signal is adjusted to repeat the previously measured level. The resulting eirp is the signal level fed to the reference antenna corrected for gain referenced to an isotropic dipole (see Figure 7.2).

From KDB (AMPLIFIER, BOOSTER, AND REPEATER REMINDER SHEET):

Radiated spurs (enclosure) – Use of CW signal (low, mid. and high freq.) is acceptable rather than all modulations.

The maximum RFI field strength was determined during the measurement by rotating the turntable (± 180 degrees) and varying the height of the receive antenna ($h = 1 \dots 4$ m) as like defined in ANSI C63.4. A measurement receiver has been used with a RBW 120 kHz up to 1 GHz and 1 MHz above 1 GHz. Steps with during pre measurement was half the RBW.

Both, the Fully Anechoic Chamber (FAC) and the Semi Anechoic Chamber (SAC) fulfil the requirements of ANSI C63.4 and CISPR 16-1-4 with regards to NSA and SVSWR.

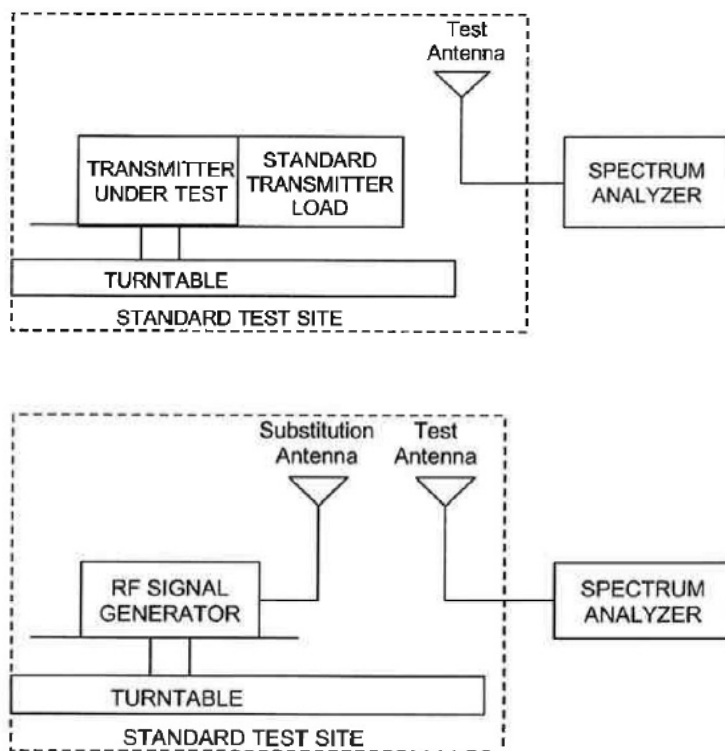

Figure #7.2 Substitution methods TIA/EIA-603-C



10.2 Limit §27.53 (h)

Minimum standard:

Para. No.27.53(h)

(h) *AWS emission limits*

(1) *General protection levels.* Except as otherwise specified below, for operations in the 1695-1710 MHz, 1710-1755 MHz, 1755-1780 MHz, 1915-1920 MHz, 1995-2000 MHz, 2000-2020 MHz, 2110-2155 MHz, 2155-2180 MHz, and 2180-2200 bands, the power of any emission outside a licensee's frequency block shall be attenuated below the transmitter power (P) in watts by at least $43 + 10 \log_{10}(P)$ dB.

(3) *Measurement procedure.* (i) Compliance with this provision is based on the use of measurement instrumentation employing a resolution bandwidth of 1 megahertz or greater. However, in the 1 megahertz bands immediately outside and adjacent to the licensee's frequency block, a resolution bandwidth of at least one percent of the emission bandwidth of the fundamental emission of the transmitter may be employed. The emission bandwidth is defined as the width of the signal between two points, one below the carrier center frequency and one above the carrier center frequency, outside of which all emissions are attenuated at least 26 dB below the transmitter power.

(ii) When measuring the emission limits, the nominal carrier frequency shall be adjusted as close to the licensee's frequency block edges, both upper and lower, as the design permits.

(iii) The measurements of emission power can be expressed in peak or average values, provided they are expressed in the same parameters as the transmitter power.

The Emission limit is -13dBm.

10.3 Climatic values in the lab

Temperature: 21°
Relative Humidity: 45%
Air-pressure: 1004 hPa



10.4 Test results

10.4.1 30 MHz to 1 GHz Downlink (Bottom – Middle – Top)

B/M/T: 2110 MHz / 2145 MHz / 2180 MHz (Operation with maximum composite power)

Vertikal

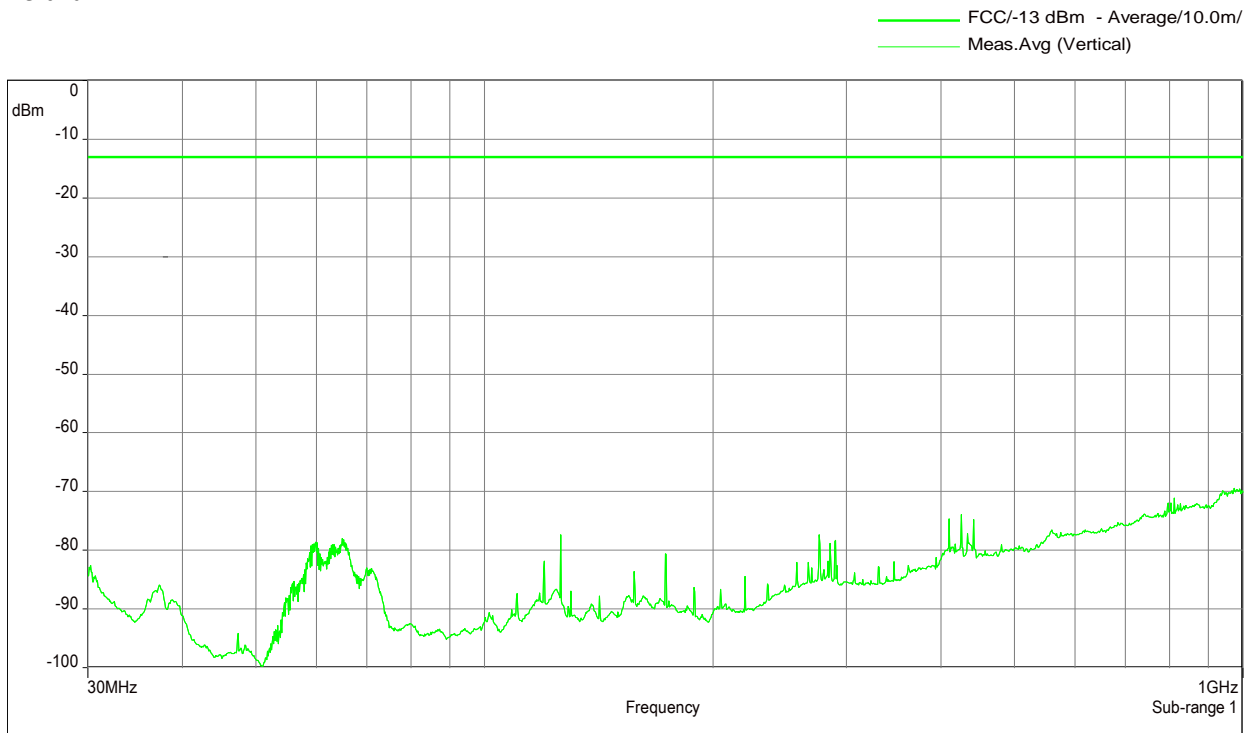

Horizontal

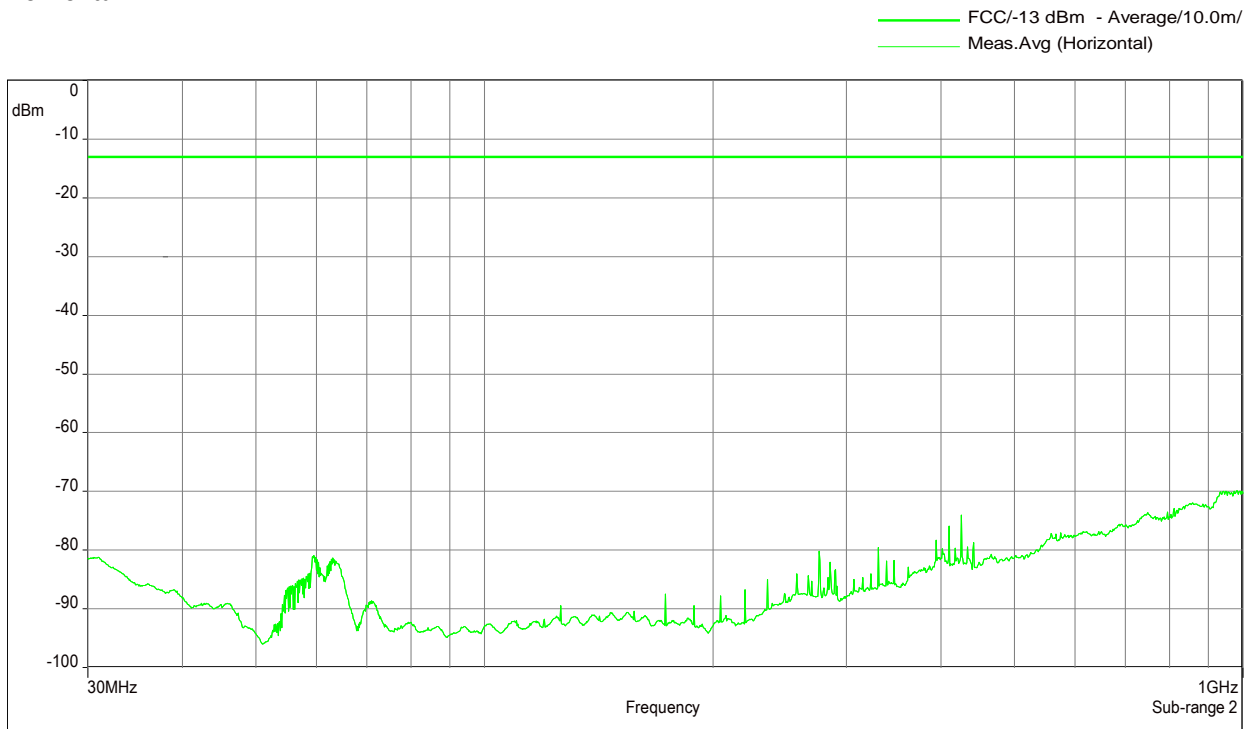

The RF output power is terminated.



10.4.2 30 MHz to 1 GHz Downlink (Middle of both paths)

F1: 1962.5 MHz; F2: 2145 MHz

Vertikal

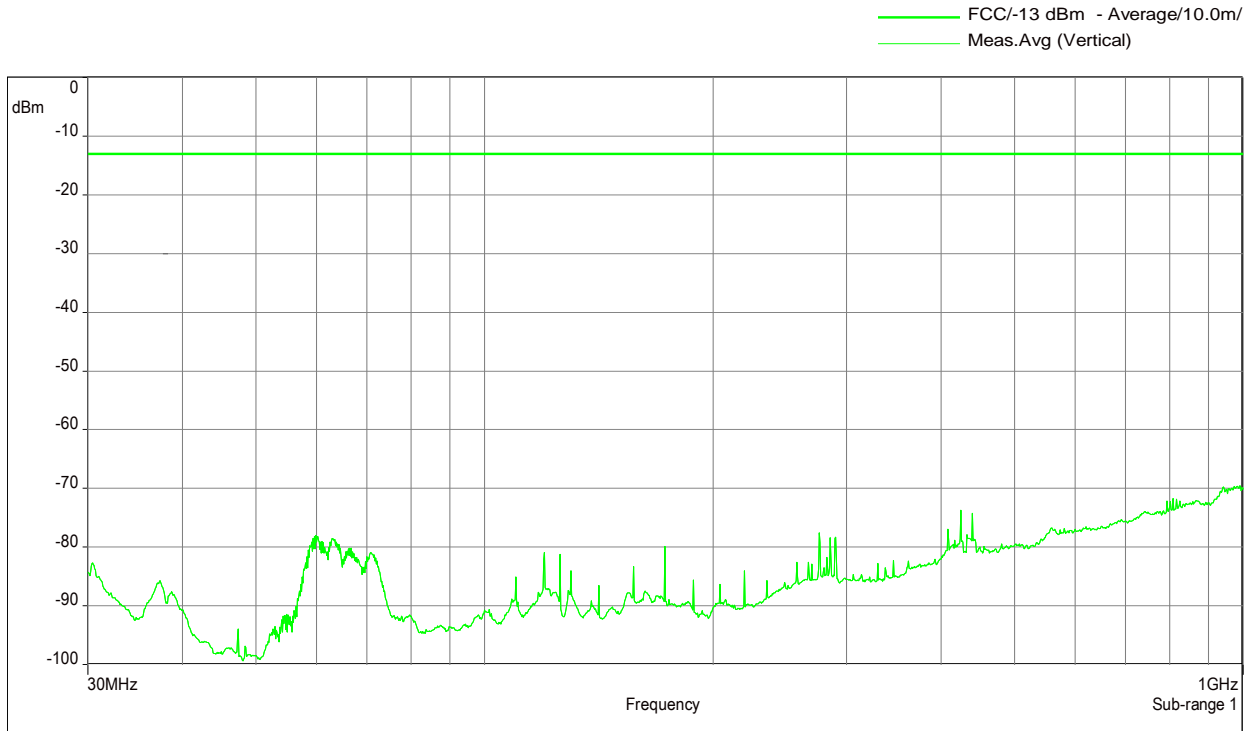

Horizontal

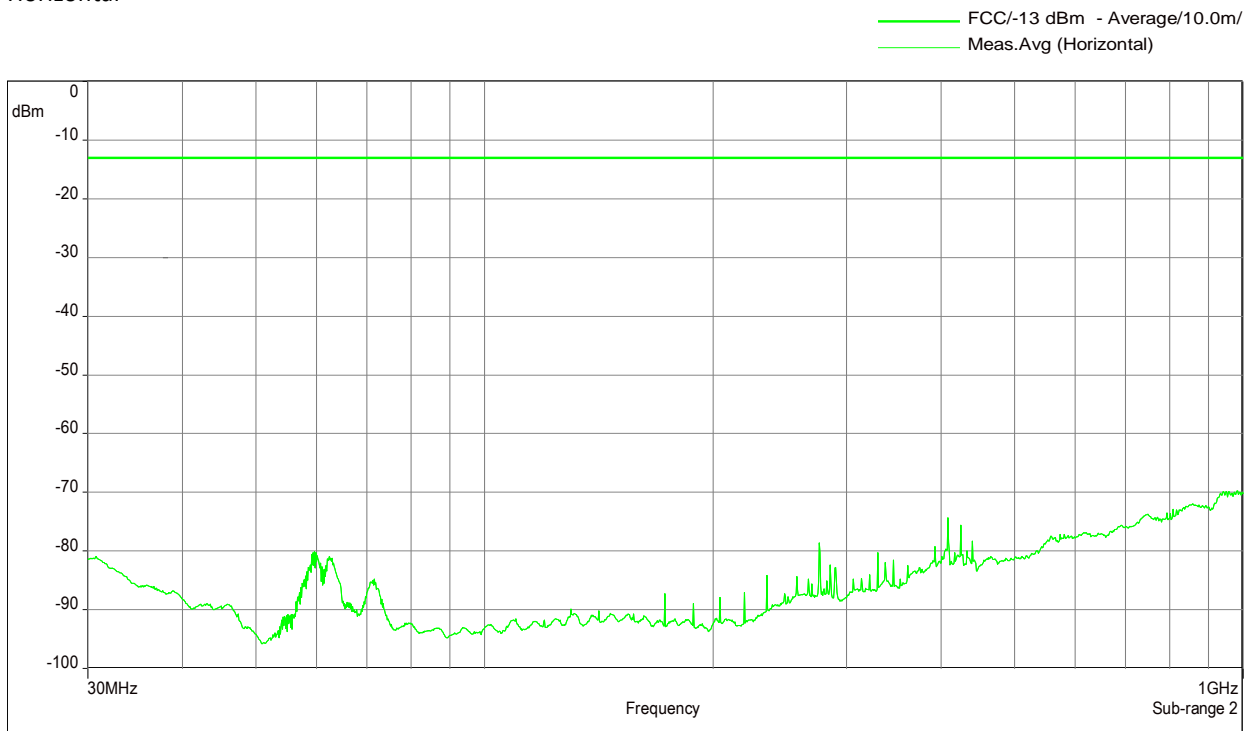

The RF output power is terminated.



10.4.3 1 GHz – 18 GHz Downlink (Bottom – Middle – Top)

B/M/T: 2110 MHz / 2145 MHz / 2180 MHz (Operation with maximum composite power)

Vertikal

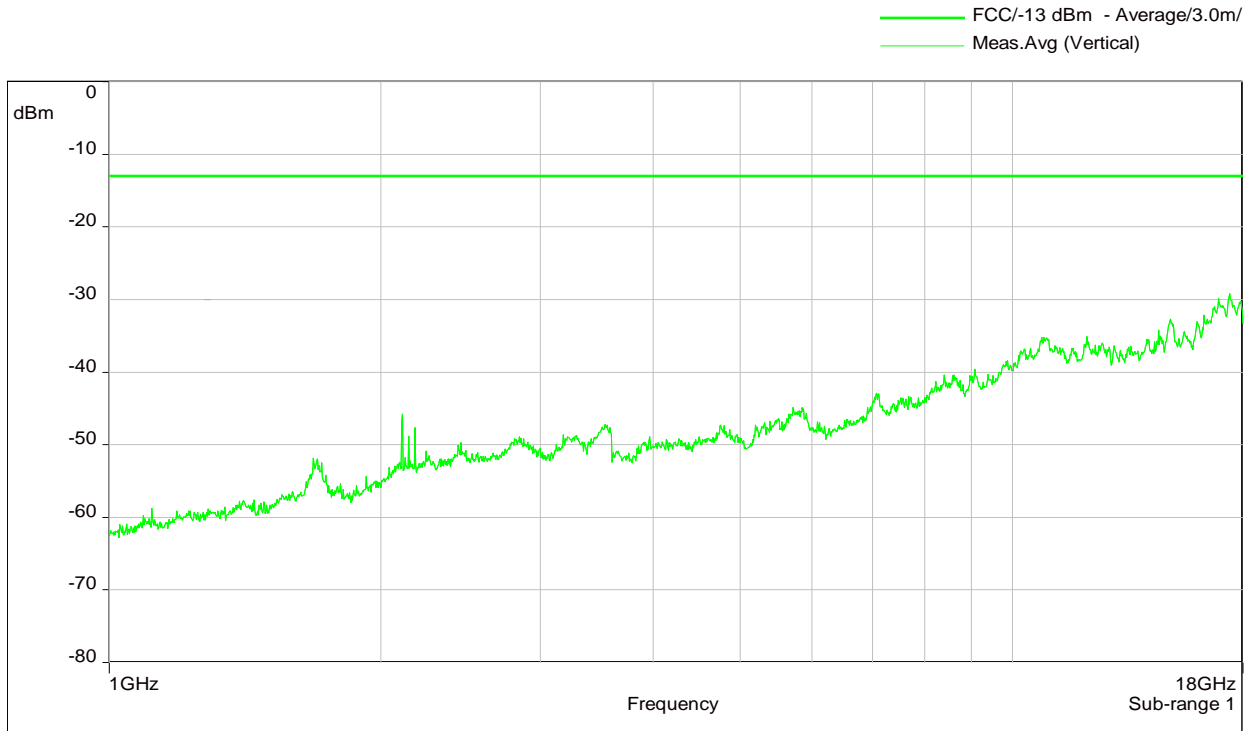

Horizontal

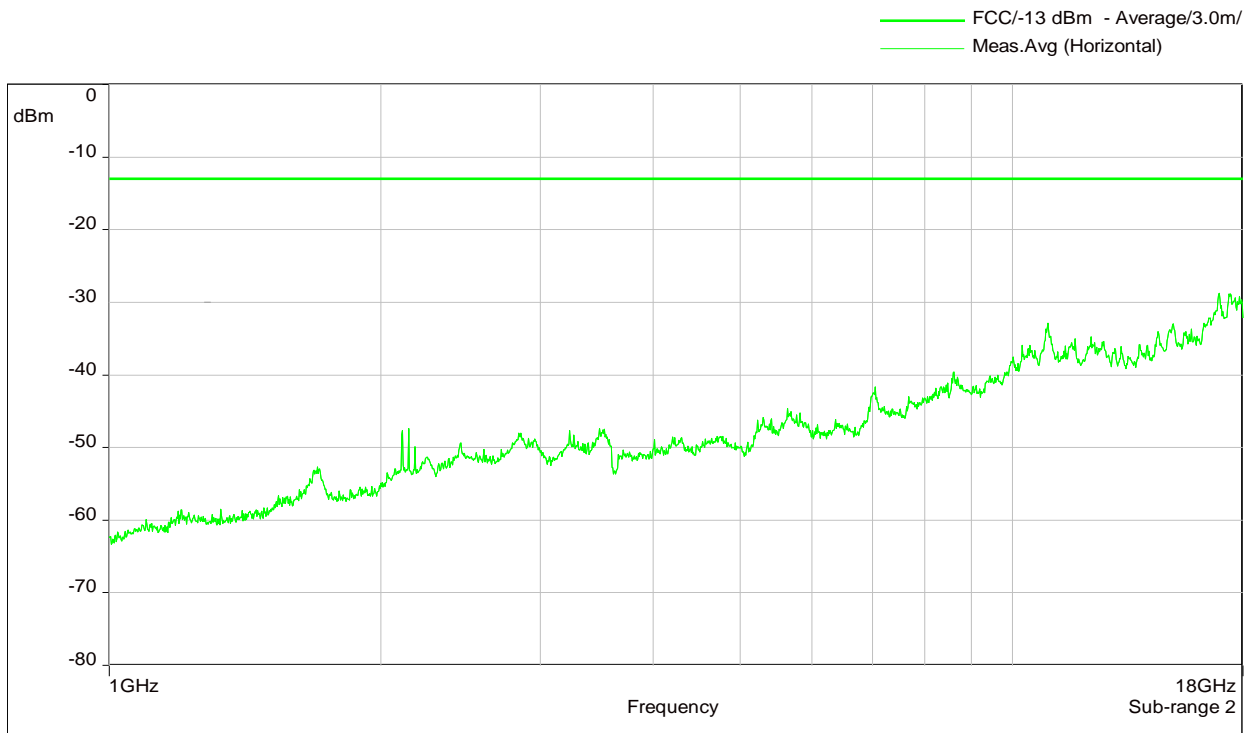

The RF output power is terminated.



10.4.4 1 GHz – 18 GHz Downlink (Middle of both paths)

F1: 1962.5 MHz; F2: 2145 MHz

Vertikal

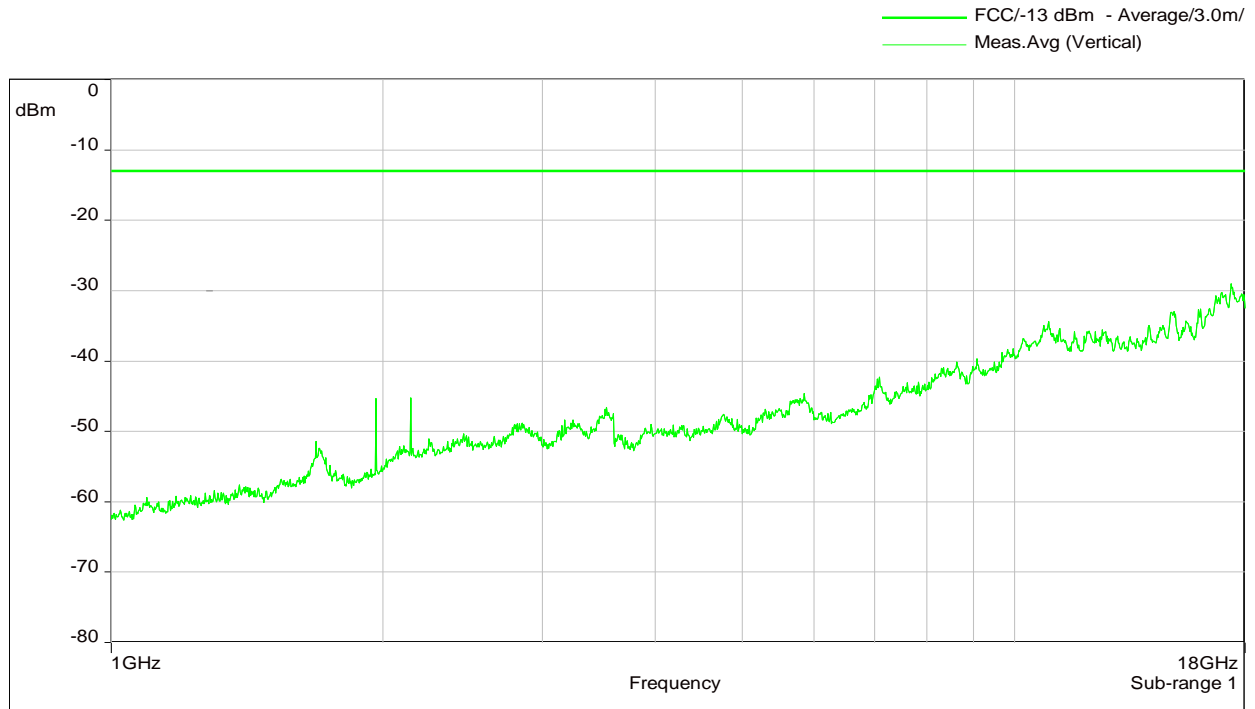

Horizontal

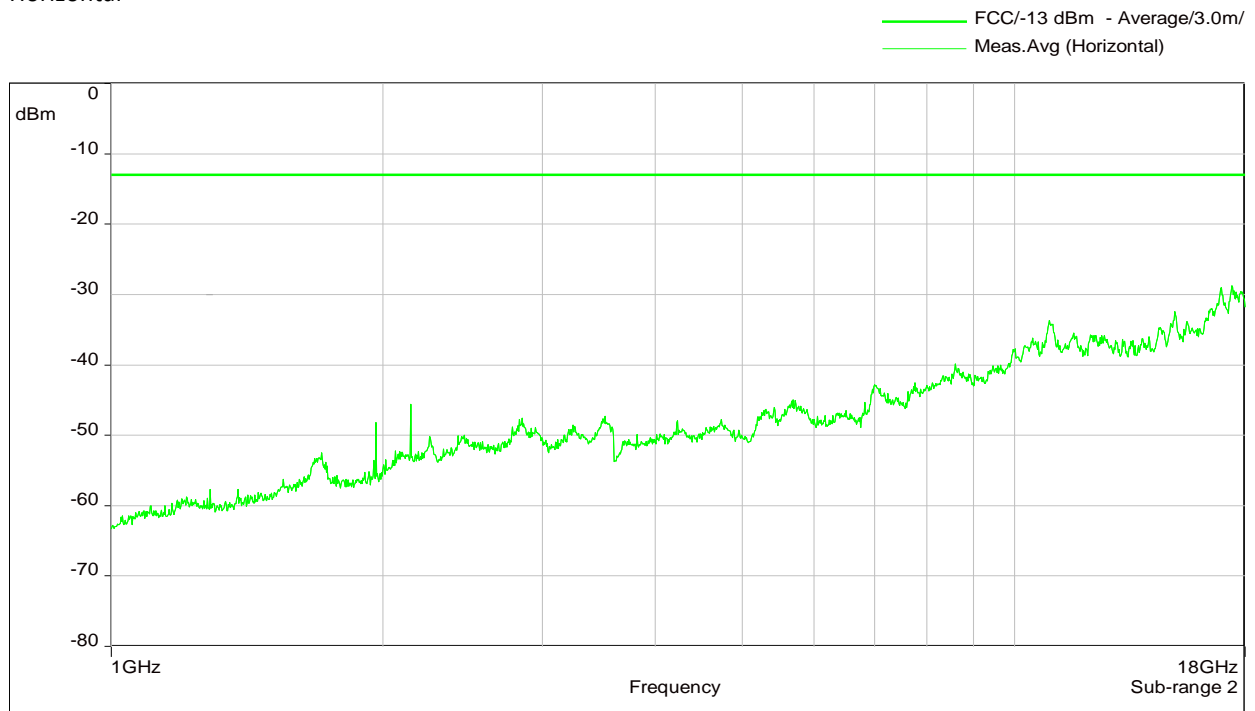

The RF output power is terminated.



10.4.5 18 GHz – 26.5 GHz Downlink (Bottom – Middle – Top)

B/M/T: 2110 MHz / 2145 MHz / 2180 MHz (Operation with maximum composite power)

Vertikal

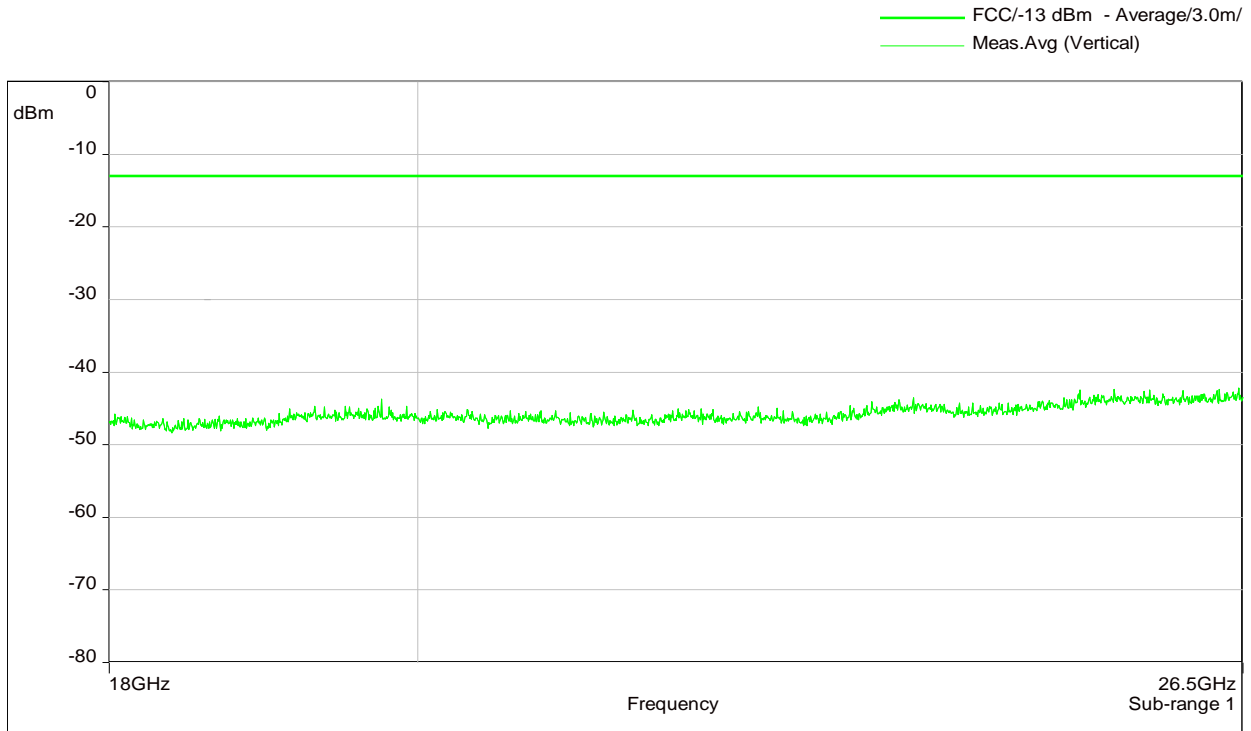

Horizontal

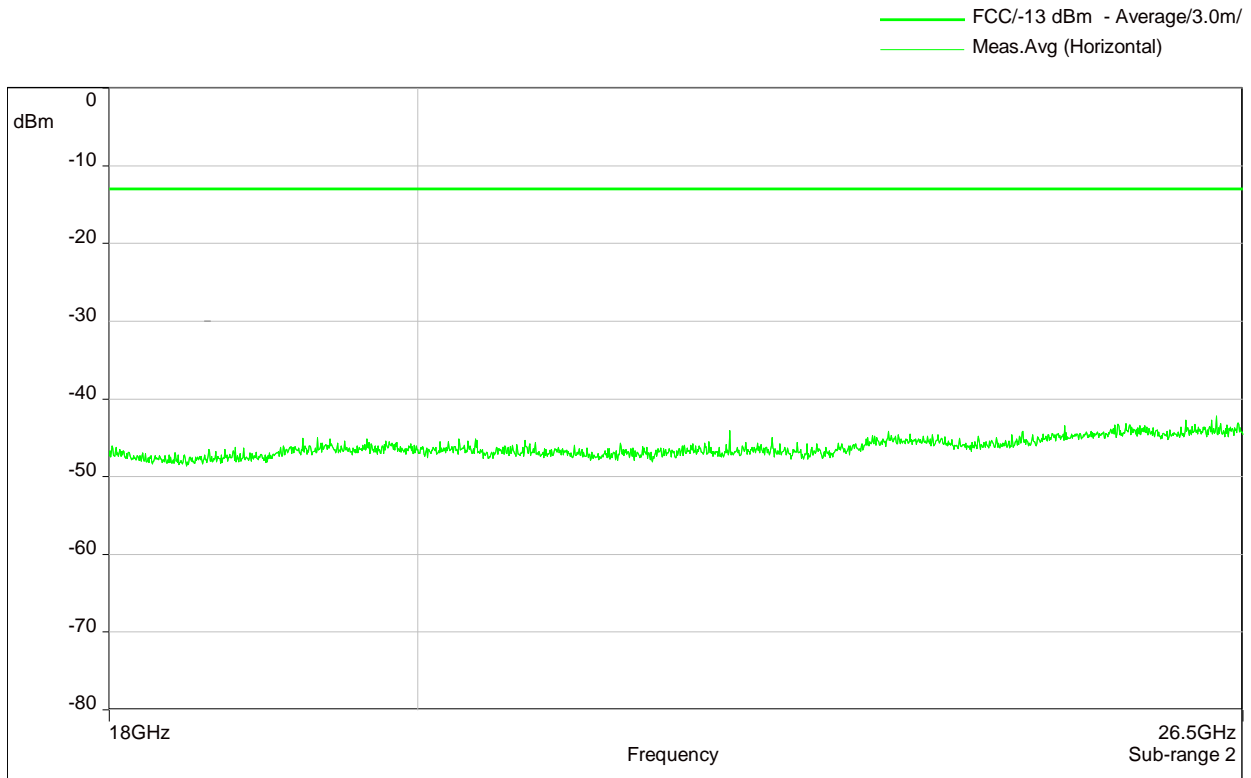

The RF output power is terminated.



10.4.6 18 GHz – 26.5 GHz Downlink (Middle of both paths)

F1: 1962.5 MHz; F2: 2145 MHz

Vertikal

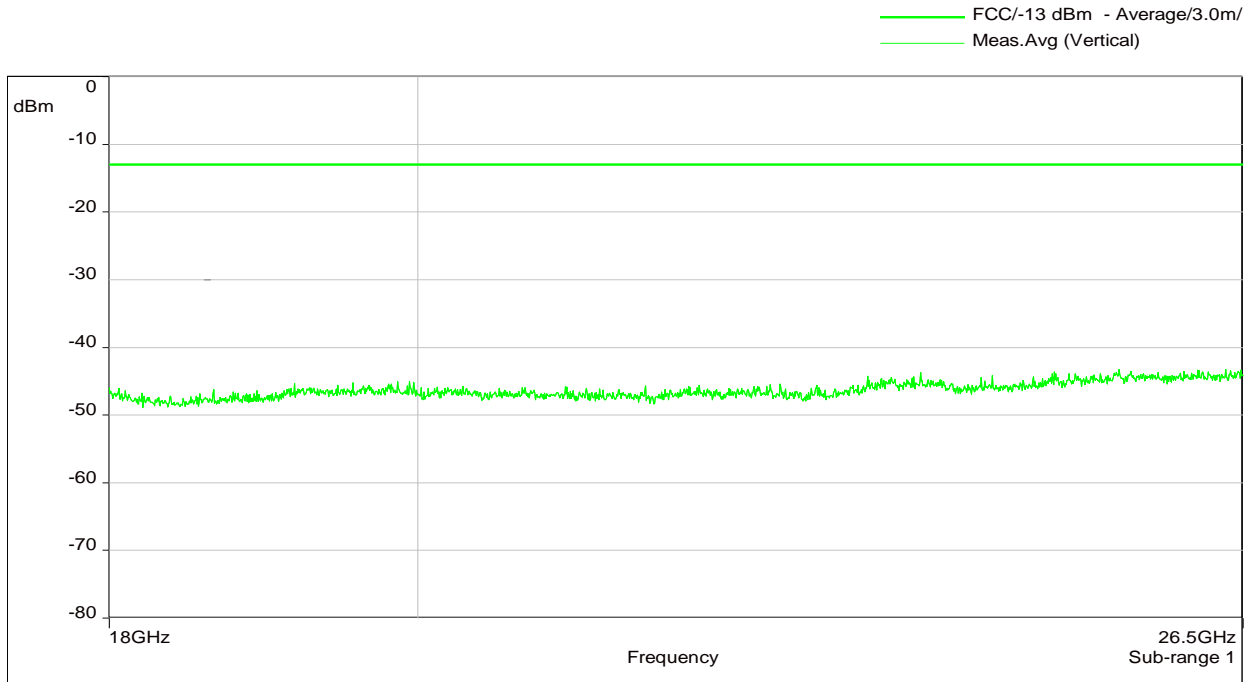

Horizontal

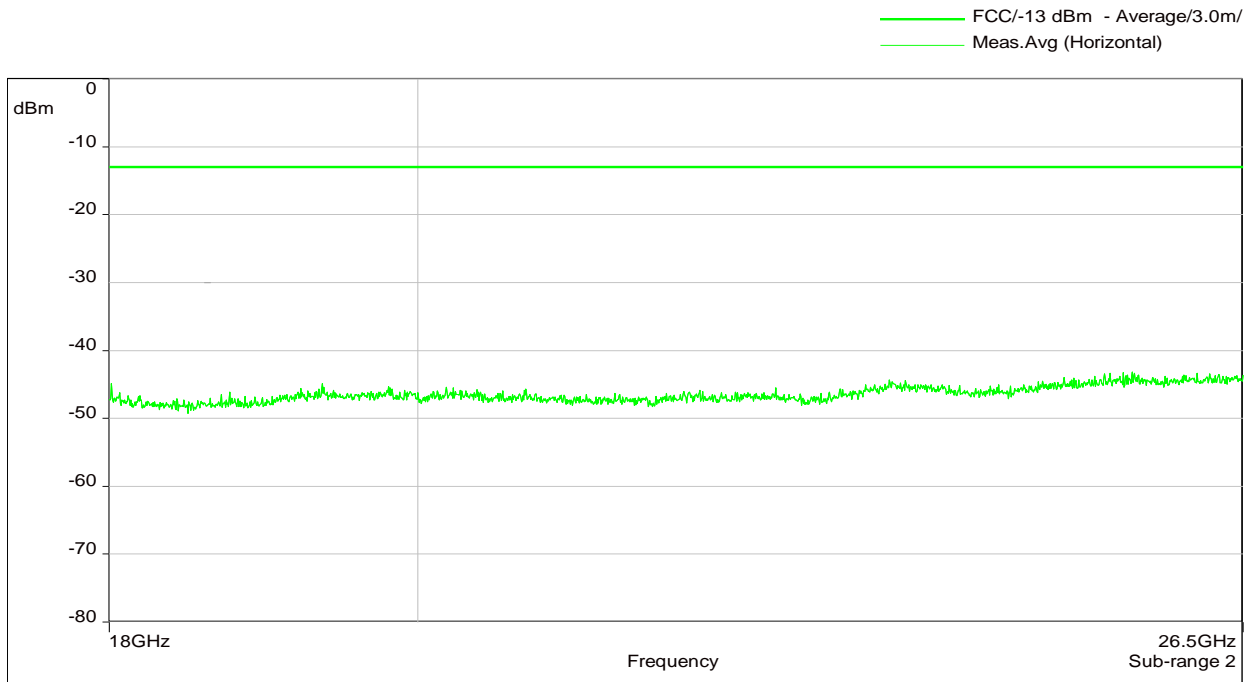

The RF output power is terminated.

GG / 08.06.2017

The radiated spurious emission measurements have been passed!

Test Report No.: 17-136

FCC ID: XS5-M17E19P



**BUREAU
VERITAS**

11 History

Revision	Modification	Date	Name
01.00	Initial Test report	22.06.2017	Tom Zahlmann

******* End of test report *******