

Test Site:
FCC Test Site No.: 96997
IC OATS No.: IC3475A-1





ECL-EMC Test Report No.: 10-062

Equipment under test: ION-M7P/8P S 800MHz Path
FCC ID: XS5- ION-M7P8PS
IC ID: 2237E-IONM7P8PS
Type of test: FCC 47 CFR Part 90 Subpart S:2009
Private Land Mobile Repeater
IC RSS-131:2003

Measurement Procedures: 47 CFR Parts 2:2009 (*Frequency Allocations and Radio Treaty Matters; General Rules and Regulations*), Part 90:2009 (*Private Land Mobile*), ANSI/TIA-603-C (2004), *Land Mobile FM or PM Communications Equipment Measurement and Performance Standards*
IC-RSS-GEN:2007 *General Requirements and Information for the Certification of Radiocommunication Equipment*

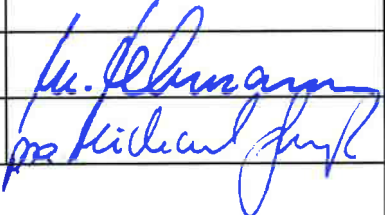
Test result: **Passed**

Date of issue:	24.03.10			Signature:
Issue-No.:	01	Author:	M. Lehmann Test engineer	
Date of delivery:	16.02.10	Checked:	M. Grytz Operational manager	
Test dates:	16.02. – 04.03.10			
Pages:	55			

Test Report No.: 10-062

FCC ID: XS5- ION-M7P8PS

IC ID: 2237E-IONM7P8PS



Manufacturer: ANDREW Wireless Systems GmbH
Industriering 10

D-86675 Buchdorf

Tel.: +49 (0)9099 69 0

Fax: +49 (0)9099 69 140

Test Location: TEMPTON Service Plus GmbH
European Compliance Laboratory (ECL)

Thurn-und-Taxis-Straße 18

D-90411 Nürnberg

Tel.: +49 0911 59835 0

Fax: +49 0911 59835 90

General:

The purpose of this report is to show compliance to the FCC regulations for licensed devices operating under section 90 of the Code of Federal Regulations title 47.

This report informs about the results of the RF tests, it only refers to the equipment under test. No part of this report may be reproduced in any form, without written permission.



Table of contents

1	TEST RESULTS SUMMARY	5
2	EQUIPMENT UNDER TEST (E.U.T.)	6
2.1	DESCRIPTION	6
2.1.1	DOWNLINK	6
2.1.2	UPLINK	6
2.1.3	DESCRIPTION OF EUT	6
2.1.4	SYSTEM DIAGRAMS	7
2.1.5	BLOCK DIAGRAM OF MEASUREMENT REFERENCE POINTS	8
3	TEST SITE (ANDREW BUCHDORF)	9
3.1	TEST ENVIRONMENT	9
3.2	TEST EQUIPMENT	9
3.3	INPUT AND OUTPUT LOSSES	9
3.4	MEASUREMENT UNCERTAINTY	9
4	TEST SITE (HERBERG)	10
5	RF POWER OUT: §90.635, §2.1046; IC RSS-131	11
5.1	LIMIT	11
5.1.1	FCC CFR47	11
5.1.2	RSS-131	11
5.2	TEST METHOD	11
5.2.1	FCC CFR47	11
5.2.2	IC RSS-GEN	12
5.3	TEST RESULTS	13
5.3.1	DOWNLINK	14
5.3.1.1	Analog	15
5.3.1.2	TDMA	15
5.3.1.3	EDGE	16
5.3.1.4	CDMA	16
5.3.1.5	EV-DO	17
5.3.1.6	WCDMA	17
5.3.1.7	HSPA	18
5.3.2	UPLINK	18
5.4	SUMMARY TEST RESULT	18
6	OCCUPIED BANDWIDTH: §90.210, §2.1049; RSS-GEN	19
6.1	LIMIT	19
6.2	TEST METHOD	19
6.2.1	FCC CFR47	19
6.2.2	IC RSS-GEN	19
6.3	TEST RESULTS	20
6.3.1	DOWNLINK	20
6.3.1.1	Analog	21
6.3.1.2	TDMA	22



6.3.1.3	EDGE	23
6.3.1.4	CDMA	24
6.3.1.5	EV-DO.....	25
6.3.1.6	WCDMA.....	26
6.3.1.7	HSPA	27
6.3.2	UPLINK	28
6.4	SUMMARY TEST RESULT.....	28
7	SPURIOUS EMISSIONS AT ANTENNA TERMINALS: §90.210, §2.1051; RSS-131, RSS-GEN.....	29
7.1	LIMIT.....	29
7.1.1	FCC CFR47.....	29
7.1.2	IC RSS-131	29
7.2	TEST METHOD	29
7.2.1	FCC CFR47.....	29
7.2.2	IC RSS-GEN	29
7.3	TEST RESULTS	30
7.3.1	DOWNLINK	30
7.3.1.1	Analog < 1MHz to band edge.....	32
7.3.1.2	TDMA < 1MHz to band edge.....	33
7.3.1.3	EDGE < 1MHz to band edge.....	34
7.3.1.4	CDMA < 1MHz to band edge.....	35
7.3.1.5	EV-DO < 1MHz to band edge.....	36
7.3.1.6	WCDMA < 1MHz to band edge	37
7.3.1.7	HSPA < 1MHz to band edge	38
7.3.1.8	Analog > 1MHz to band edge.....	39
7.3.1.9	TDMA > 1MHz to band edge	39
7.3.1.10	EDGE > 1MHz to band edge.....	40
7.3.1.11	CDMA > 1MHz to band edge.....	41
7.3.1.12	EV-DO > 1MHz to band edge.....	41
7.3.1.13	WCDMA > 1MHz to band edge	42
7.3.1.14	HSPA > 1MHz to band edge	42
7.3.2	UPLINK	43
7.4	SUMMARY TEST RESULT.....	43
8	RADIATED SPURIOUS EMISSIONS AT THE ECL (TEMPTON): §90.210, §2.1053, RSS-GEN, RSS-131	44
8.1	METHOD OF MEASUREMENT.....	46
8.2	LIMIT.....	47
8.3	CLIMATIC VALUES IN THE LAB.....	47
8.4	TEST RESULTS	48
8.4.1	PREMEASUREMENTS	48
8.4.1.1	30 MHz to 1 GHz Downlink (<u>B</u> ottom – <u>M</u> iddle – <u>T</u> op).....	48
8.4.1.2	1 GHz to 9 GHz Downlink (<u>B</u> ottom – <u>M</u> iddle – <u>T</u> op).....	52
8.4.2	FINAL MEASUREMENTS	54
8.4.2.1	30 MHz to 1 GHz Downlink (<u>B</u> ottom – <u>M</u> iddle – <u>T</u> op).....	54
8.4.2.2	1 GHz to 9 GHz Downlink (<u>B</u> ottom – <u>M</u> iddle – <u>T</u> op).....	54
9	HISTORY.....	55

Test Report No.: 10-062

FCC ID: XS5- ION-M7P8PS

IC ID: 2237E-IONM7P8PS



1 Test Results Summary

Name of Test	FCC Para. No.	FCC Method	FCC Spec.	Result
RF Power Output	90.635	2.1046	1000 Watts	Complies
Occupied Bandwidth	90.210	2.1049	Input/Output	Complies
Spurious Emissions at Antenna Terminals	90.210	2.1051	-13dBm	Complies
Radiated Spurious emission	90.543	2.1053	-13dBm	Complies
Frequency Stability	90.213	2.1055	1 ppm	NA

Name of Test	IC Para. No.	IC Method	Result
RF Power Output	RSS-131	RSS-GEN 4.8	Complies
Occupied Bandwidth	RSS-131	RSS-GEN 4.6.1	Complies
Spurious Emissions at Antenna Terminals	RSS-131	RSS-GEN 4.9	Complies
Field Strength of Spurious Emissions	RSS-131 6.4	RSS-GEN 4.9	Complies
Frequency Stability	RSS-131	RSS-GEN 4.7	NA

Frequency stability is not applicable because the device uses a common oscillator to up convert and down convert the RF signal. The EUT does not contain modulation circuitry, or frequency generation, therefore the test was not performed.

2 Equipment under test (E.U.T.)

2.1 Description

Kind of equipment	ION-M7P/8P S Repeater
Andrew Ident. Number	Id.No. 7611167-0001
Serial no.(SN)	11
Revision	00
Software version and ID	V03.18.00.03 Id.No. 7162793-00
Type of modulation and Designator	F3E (Voice) <input checked="" type="checkbox"/> GXW <input checked="" type="checkbox"/> G7W <input checked="" type="checkbox"/> F9W <input checked="" type="checkbox"/>
Frequency Translation	F1-F1 <input checked="" type="checkbox"/> F1-F2 <input type="checkbox"/> N/A <input type="checkbox"/>
Band Selection	Software <input type="checkbox"/> Duplexer <input checked="" type="checkbox"/> Full band <input type="checkbox"/>

2.1.1 Downlink

Pass band	Path 851 MHz – 869 MHz
Max. composite output power based on one carrier per path (rated)	44 dBm = 25,1 W
Gain	11 dB @ Pout BTS of 33 dBm

2.1.2 Uplink

Pass band	Path 806 MHz – 824 MHz
Gain	n.a.

Note: The EUT does not transmit over the air in the uplink direction.

2.1.3 Description of EUT

Andrew ION-M7P/8P S is a multi-band, multi-operator remote unit with various extension units. It is used in conjunction with a master unit in the ION optical distribution system.

This Test Report describes only the approval of the 700 MHz Path (ION-M7P).

The ION-M7P/8P S Repeater consists of one 700 MHz path and one 800 MHz path, with the intended use of simultaneous transmission

2.1.4 System diagrams

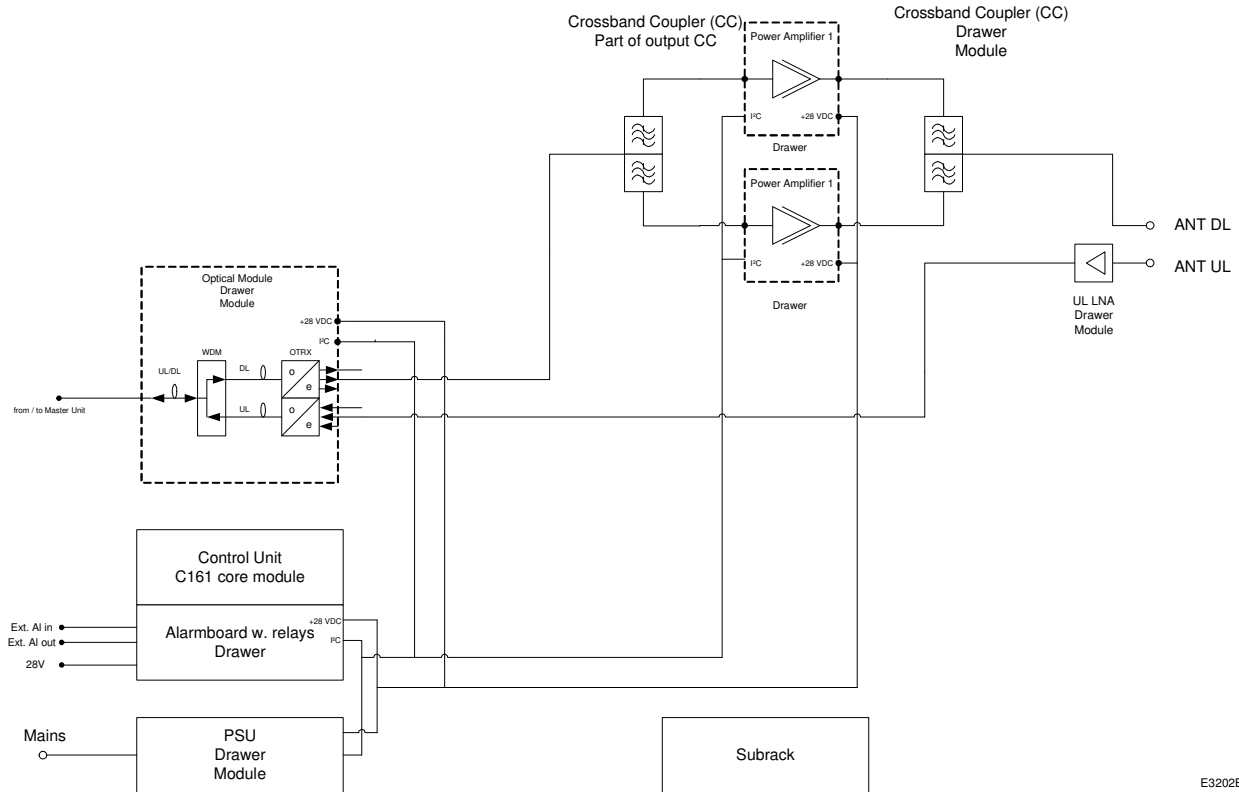

figure 2.1.4-#1 System diagrams: ION optical distribution system

E3202B0

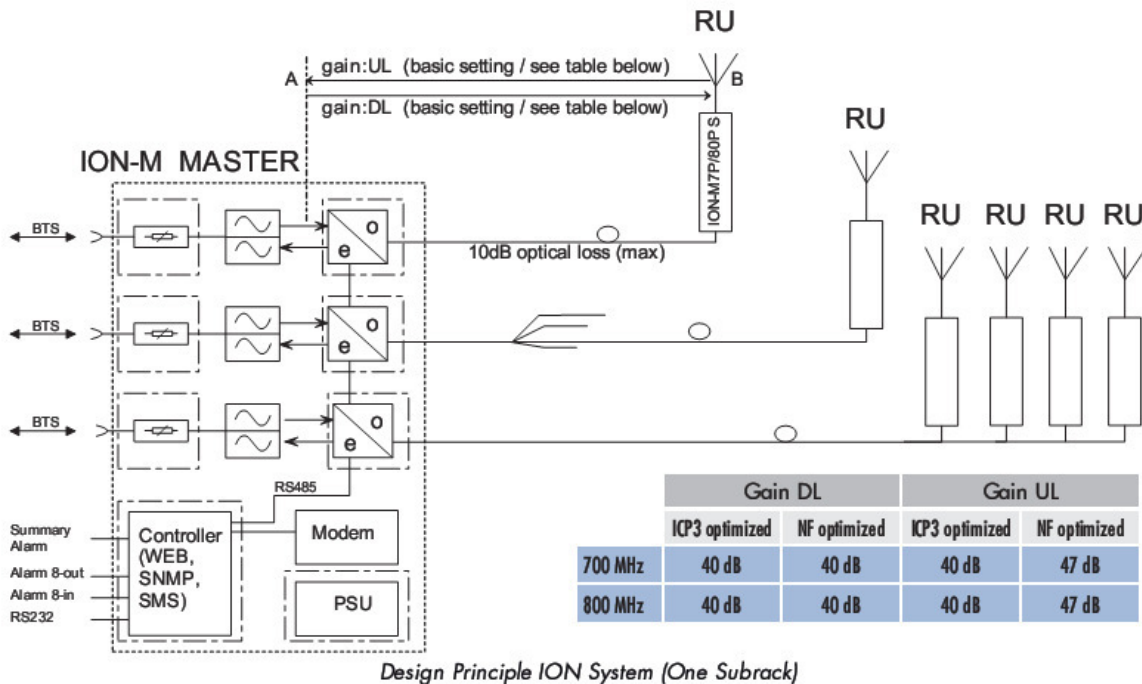

figure 2.1.4-#2 System diagrams: EUT is Remote Unit

2.1.5 Block diagram of measurement reference points

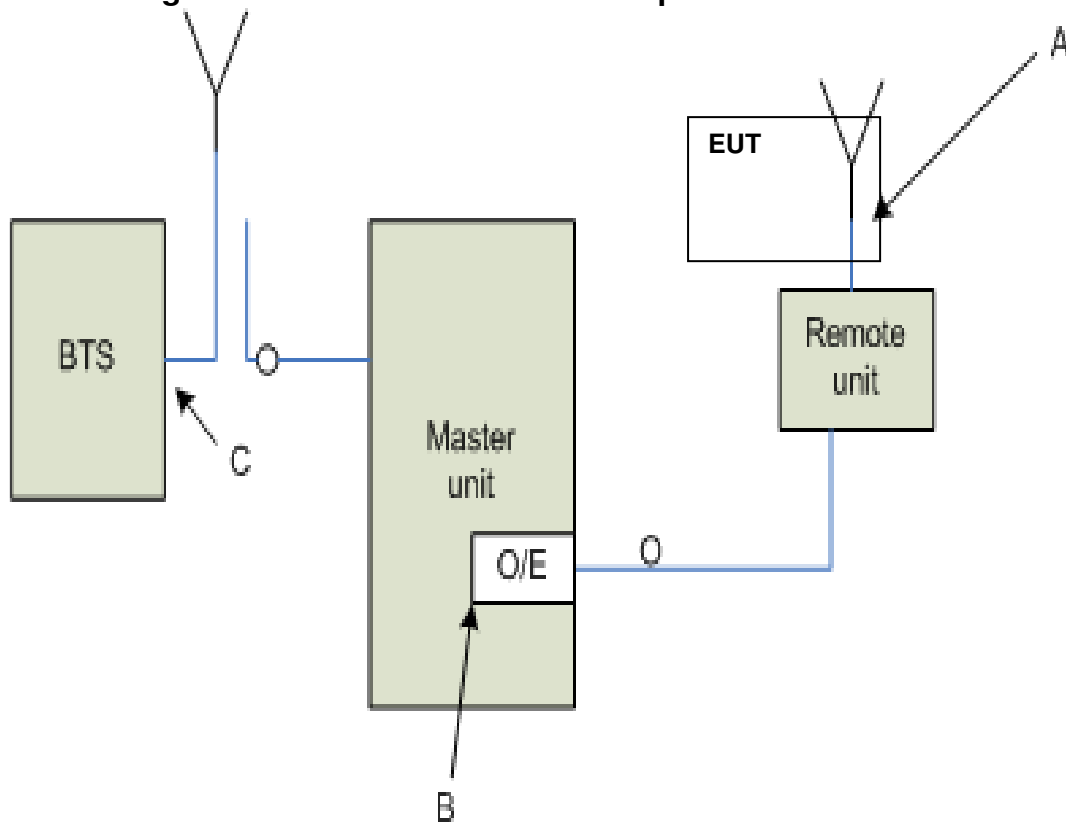

figure 2.1.5-#1 Block diagram of measurement reference points

Remote Unit is the EUT
O/E Optcal/Electrical converter
SRMU SubRackMaster Unit

Reference point A, Remote Unit DL output, UL input
Reference point B, SRMU UL output, DL input
Reference point C, BTS DL output, UL input

3 Test site (Andrew Buchdorf)

3.1 Test environment

All tests were performed under the following environmental conditions:

Condition	Minimum value	Maximum value
Barometric pressure	86 kPa	106 kPa
Temperature	15 °C	30 °C
Relative Humidity	20 %	75 %
Power supply range	±5% of rated voltages	

3.2 Test equipment

Andrew Inv. No.	Test equipment	Type	Manufacturer	Serial No.	Calibration
8741	Network Analyzer	ZVRE	R&S	100034	02/2011
8890	Spectrum Analyzer	FSP	R&S	100674	07/2010
8848	Generator	E4438C	Agilent	My45092504	04/2010
8667	Power Meter	E4418A	Agilent	GB38273230	04/2010
8668	Power Sensor	E8481H	Agilent	US3318A192 08	04/2010
7355	Power Amplifier	3-Band Amp	Andrew	---	CIU
7157	RF-Cable	Succoflex	Suhner	36180/4P	CIU
7158	RF-Cable	Succoflex	Suhner	36182/4P	CIU
7289	RF-Cable	Succoflex	Suhner	28443/4PE	CIU
7290	RF-Cable	Succoflex	Suhner	28444/4PE	CIU
7385	RF-Cable	Succoflex	Suhner	36267/4P	CIU
7387	RF-Cable	Succoflex	Suhner	36267/4P	CIU
7390	RF-Cable	Succoflex	Suhner	40193/4P	CIU
7381	RF-Cable	Succoflex	Suhner	40200/4P	CIU
7384	RF-Cable	Succoflex	Suhner	40448/4P	CIU
7294	RF-Cable	Succoflex	Suhner	40448/4P	CIU
7382	RF-Cable	Succoflex	Suhner	40221/4P	CIU
7160	Divider	SMP 317	Mikom	784	CIU

CIU = Calibrate in use

3.3 Input and output losses

All recorded power levels should be referenced to the input and output connectors of the repeater, unless explicitly stated otherwise.

The test equipment used in this test has to be calibrated, so that the functionality is also checked.

All cables, attenuators, splitter, isolator, circulator and combiner etc. must be measured before testing and used for compensation during testing.

3.4 Measurement uncertainty

The extended measurement uncertainty corresponds to the measurement results from the standard measurement uncertainty multiplied by the coverage factor $k=2$. The true value is located in the corresponding interval with a probability of 95 %.

Test Report No.: 10-062

FCC ID: XS5- ION-M7P8PS

IC ID: 2237E-IONM7P8PS



4 Test site (Herberg)

FCC Test site: 96997
IC OATS: IC3475A-1

See relevant dates under section 8.

5 RF Power Out: §90.635, §2.1046; IC RSS-131

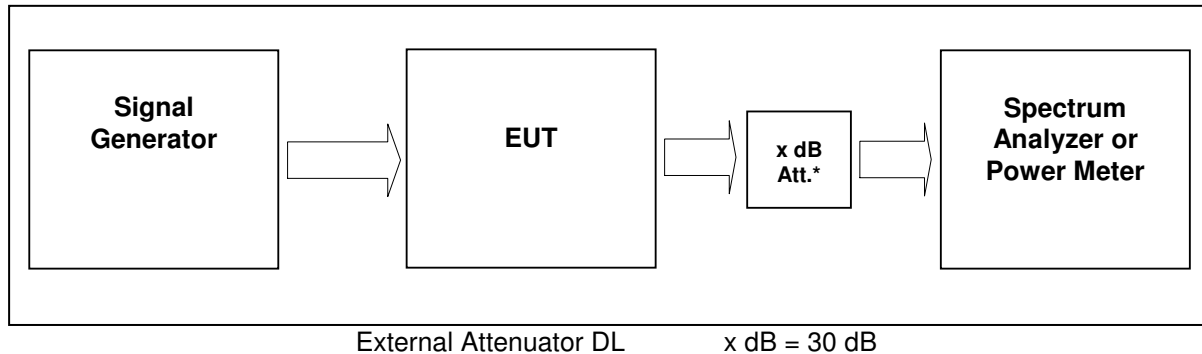

figure 5-#1 Test setup: RF Power Out: §90.635, §2.1046; IC RSS-131

Measurement uncertainty	± 0,38 dB
Test equipment used	8890; 8667; 8668; 8848; 7355; 7160

5.1 Limit

5.1.1 FCC CFR47

Minimum standard:

§ 90.635 Limitations on power and antenna height.

(a) The effective radiated power and antenna height for base stations may not exceed 1 kilowatt (30 dBw) and 304 m. (1,000 ft.) above average terrain (AAT), respectively, or the equivalent thereof as determined from the Table. These are maximum values, and applicants will be required to justify power levels and antenna heights requested.

5.1.2 RSS-131

5.2 Test method

5.2.1 FCC CFR47

§ 2.1046 Measurements required: RF power output.

(a) For transmitters other than single sideband, independent sideband and controlled carrier radiotelephone, power output shall be measured at the RF output terminals when the transmitter is adjusted in accordance with the tune-up procedure to give the values of current and voltage on the circuit circuit elements specified in § 2.1033(c)(8). The electrical characteristics of the radio frequency load attached to the output terminals when this test is made shall be stated.

(c) For measurements conducted pursuant to paragraphs (a) and (b) of this section, all calculations and methods used by the applicant for determining carrier power or peak envelope power, as appropriate, on the basis of measured power in the radio frequency load attached to the transmitter output terminals shall be shown. Under the test conditions specified, no components of the emission spectrum shall exceed the limits specified in the applicable rule parts as necessary for meeting occupied bandwidth or emission limitations



5.2.2 IC RSS-GEN

4.8 Transmitter Output Power

Transmitter output power measurements shall be carried out before the unwanted emissions test. The transmitter output power value, obtained from this test, serves as the reference level used to determine the unwanted emissions. For comparative purposes, the measurements of emission power and unwanted emissions can be in peak or average provided the same parameter is used when measuring both. This information shall be included in the test report.

If the transmission is in bursts, the output power shall be averaged over any 100 millisecond period or, over the burst duration if the burst is shorter than 100 milliseconds, during which its value is at its maximum. The power shall only be averaged over the duration of actual transmission. No off times are to be included in the average.

If the RF output power is internally or externally adjustable or remotely controllable, set or control the power to the maximum rating of the range for which equipment certification is sought. If the spectrum analyzer selectivity or bandwidth is insufficient when measuring emission power, a resolution bandwidth, narrower than that specified, plus numerical integration, in terms of linear power to sum the transmitter output power, is permitted. The method used shall be described in the test report.

If the antenna is detachable, the transmitter output power may be measured at the antenna port using conducted measurement.

If the antenna is not detachable, field strength measurements shall be made using a calibrated open area test site.

The following formula may be used to convert field strength (FS) in volts/metre to transmitter output power (TP) in watts:

$$TP = (FS \times D)^2 / (30 \times G)$$

Where D is the distance in metres between the two antennas and G is the antenna numerical gain referenced to isotropic gain. (Note: In an open-area test measurement, the effect due to the metal ground plane should be subtracted from the maximum field strength value in order to reference it to free space, before calculating TP.)

Measure and record the transmitter output power using a measurement bandwidth at least 3 times the emission bandwidth of the transmitter, or use power summation as described above.

Test Report No.: 10-062

FCC ID: XS5- ION-M7P8PS

IC ID: 2237E-IONM7P8PS



5.3 Test Results

Detector RMS.

Test signal Analog:

FM signal with 3.0 kHz deviation and 2.5 kHz rate and sine waveform.

Test signal TDMA GSM:

Signal waveform with GMSK modulation in all time slots according to 3GPP TS45.004

Test signal GSM EDGE:

Signal waveform with 8-PSK modulation in all time slots according to 3GPP TS45.004

Test signal CDMA

Signal waveform according to table 6.2-1 of standard specification 3GPP2 C.p0051-0 v1.0

16.February 2006 pilot, sync, paging, 37 traffics, which is equal to the table 6.5.2.1 of 3GPP2 C.S0010-C v2.0 24.February 2006.

Test signal EV-DO

Signal waveform according to 1xEV-DO Forward Link definition of standard specification 3GPP2 C.S0032 Recommended Minimum Performance Standards for cdma2000 High Rate Packet Data Access Network

Test signal WCDMA

Signal waveform according to Test Model 1 of standard specification 3GPP TS25.141. Signal modulated with a combination of PCCPCH, SCCPCH and Dedicated Physical Channels specified as test model 1 64 DPCH.

Test signal HSPA

Signal waveform according to Test Model 5 (8 HS-PDSCH + 30 DPCH) of standard specification 3GPP TS25.141. Each HS-PDSCH is modulated by 16QAM.

According to ANSI C63.4 section 13.1 Table 5 for operating frequencies more then 10MHz: The test shall be performed at Bottom, Middle and Top frequencies.



5.3.1 Downlink

Modulation	Measured at		RBW VBW Span	RF Power [dBm]	RF Power [W]	Plot -
Analog	Middle	860 MHz	1MHz 3MHz 2MHz	44,0	25,1	5.3.1.1 #1
TDMA	Middle	860 MHz	1MHz 3MHz 2MHz	44,0	25,1	5.3.1.2 #1
EDGE	Middle	860 MHz	1MHz 3MHz 2MHz	44,0	25,1	5.3.1.3 #1
CDMA	Middle	860 MHz	3MHz 10MHz 15MHz	44,0	25,1	5.3.1.4 #1
EV-DO	Middle	860 MHz	3MHz 10MHz 15MHz	44,0	25,1	5.3.1.5 #1
WCDMA	Middle	860 MHz	10MHz 10MHz 50MHz	44,0	25,1	5.3.1.6 #1
HSPA	Middle	860 MHz	10MHz 10MHz 50MHz	44,0	25,1	5.3.1.7 #1
Maximum output power = 44,0 dBm = 25,1 W						
Limit Maximum output power = 1000 W						

table 5.3.1-#1 RF Power Out: §90.635, §2.1046; IC RSS-131 Test Results Downlink

Modulation	Pin / dBm (Ref. point B)
Analog	5,0
TDMA/EDGE	4,9
CDMA/EV-DO	4,4
WCDMA/HSPA	4,9

table 5.3.1-#2 RF Power Out: §90.635, §2.1046; IC RSS-131 Test Results Downlink Input power

Test Report No.: 10-062

FCC ID: XS5- ION-M7P8PS

IC ID: 2237E-IONM7P8PS



5.3.1.1 Analog

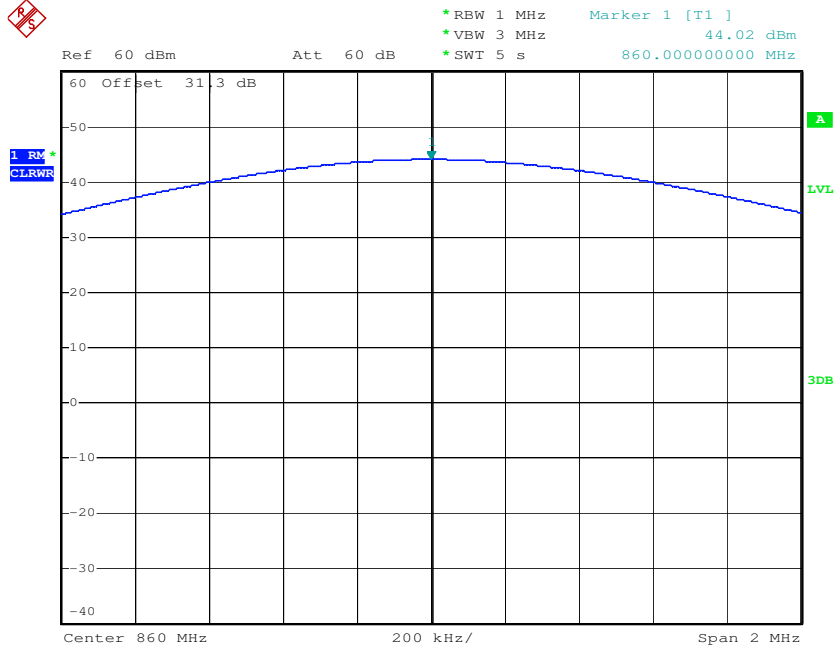

Date: 3.MAR.2010 11:11:55

plot 5.3.1.1-#1 RF Power Out: §90.635, §2.1046; IC RSS-131; Test Results; Downlink; Analog Middle

5.3.1.2 TDMA

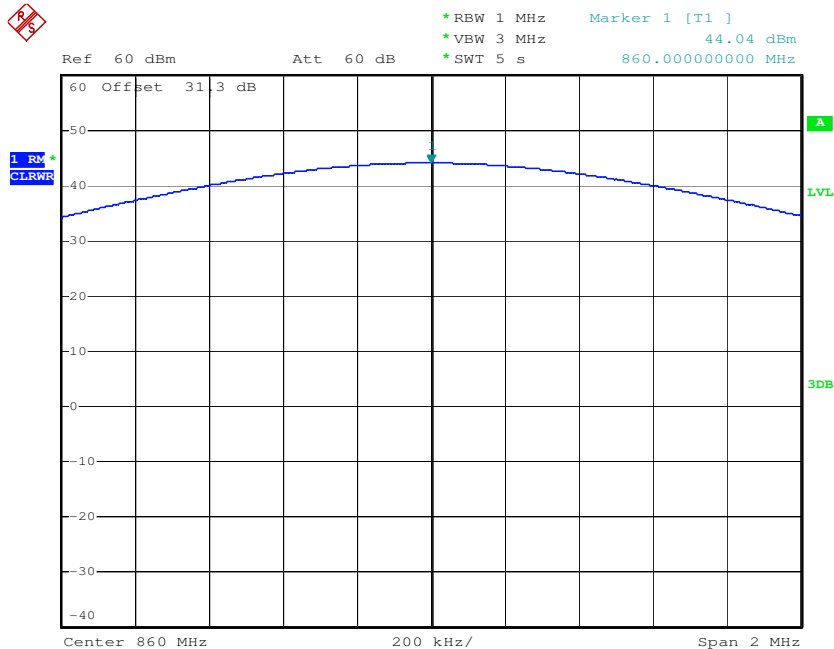

Date: 3.MAR.2010 11:07:16

plot 5.3.1.2-#1 RF Power Out: §90.635, §2.1046; IC RSS-131; Test Results; Downlink; TDMA Middle



5.3.1.3 EDGE

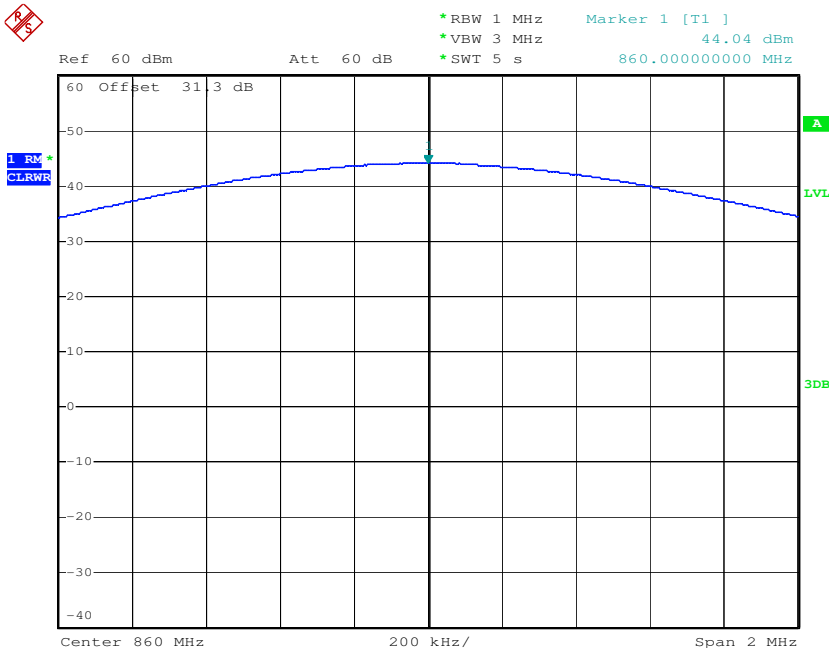

Date: 3.MAR.2010 11:16:58

plot 5.3.1.3-#1 RF Power Out: §90.635, §2.1046; IC RSS-131; Test Results; Downlink; EDGE Middle

5.3.1.4 CDMA

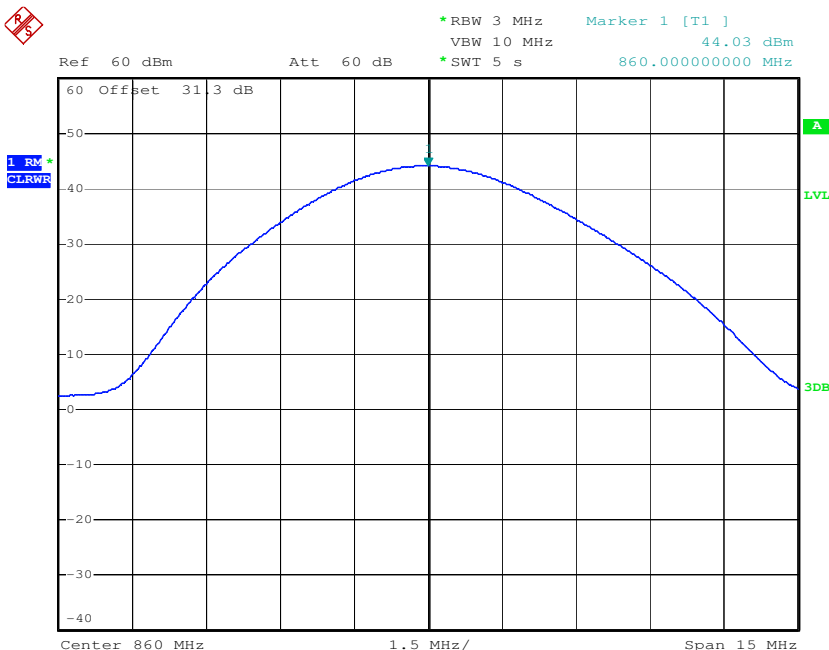

Date: 3.MAR.2010 11:28:40

plot 5.3.1.4-#1 RF Power Out: §90.635, §2.1046; IC RSS-131; Test Results; Downlink; CDMA Middle

5.3.1.5 EV-DO

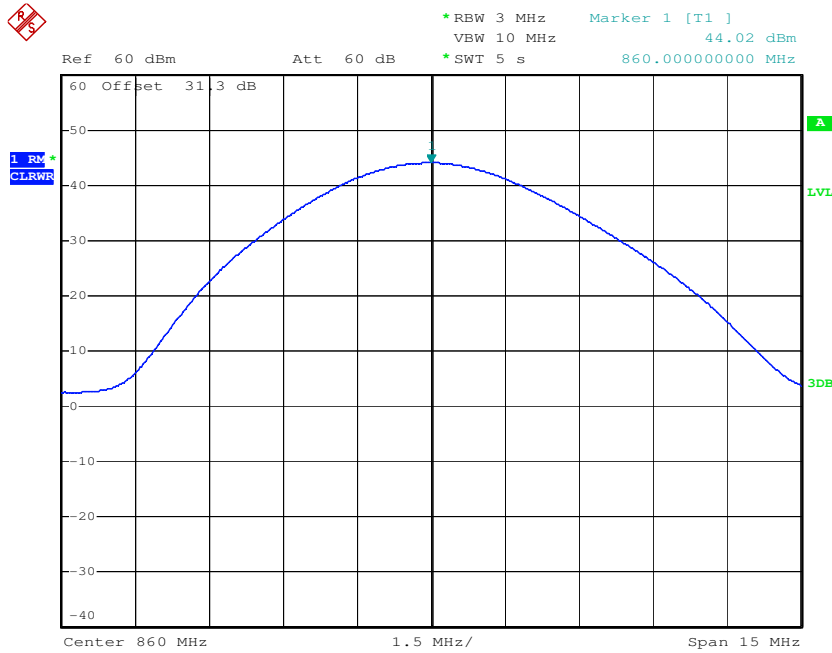

Date: 3.MAR.2010 11:45:39

plot 5.3.1.5-#1 RF Power Out: §90.635, §2.1046; IC RSS-131; Test Results; Downlink; EV-DO Middle

5.3.1.6 WCDMA

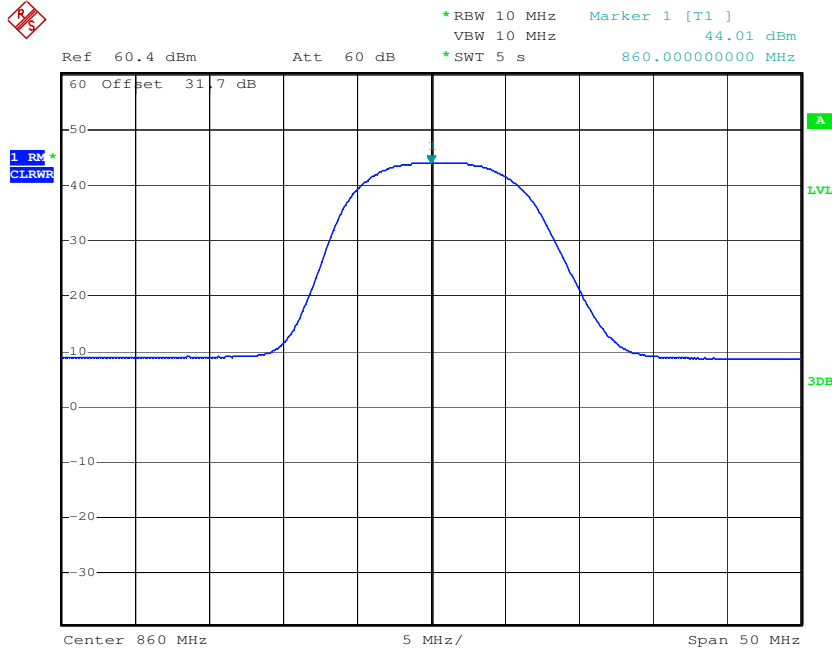

Date: 3.MAR.2010 11:54:07

plot 5.3.1.6-#1 RF Power Out: §90.635, §2.1046; IC RSS-131; Test Results; Downlink; WCDMA Middle

Test Report No.: 10-062

FCC ID: XS5- ION-M7P8PS

IC ID: 2237E-IONM7P8PS



5.3.1.7 HSPA

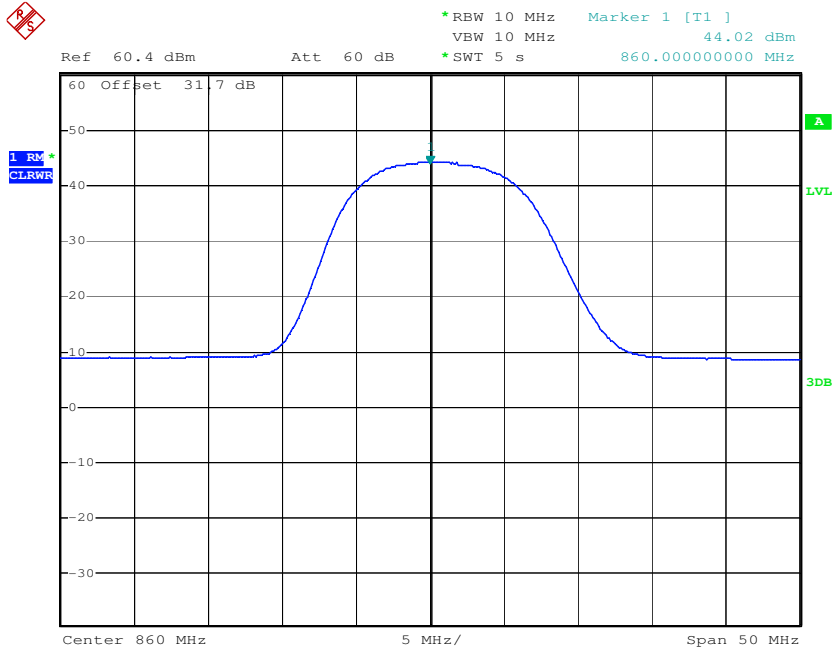

Date: 3.MAR.2010 13:37:52

plot 5.3.1.7-#1 RF Power Out: §90.635, §2.1046; IC RSS-131; Test Results; Downlink; HSPA Middle

5.3.2 Uplink

n.a.

Note: The EUT does not transmit over the air in the uplink direction.

5.4 Summary test result

Test result	complies, according the plots above
Tested by:	W. Meir
Date:	3.03.2010

6 Occupied Bandwidth: §90.210, §2.1049; RSS-GEN

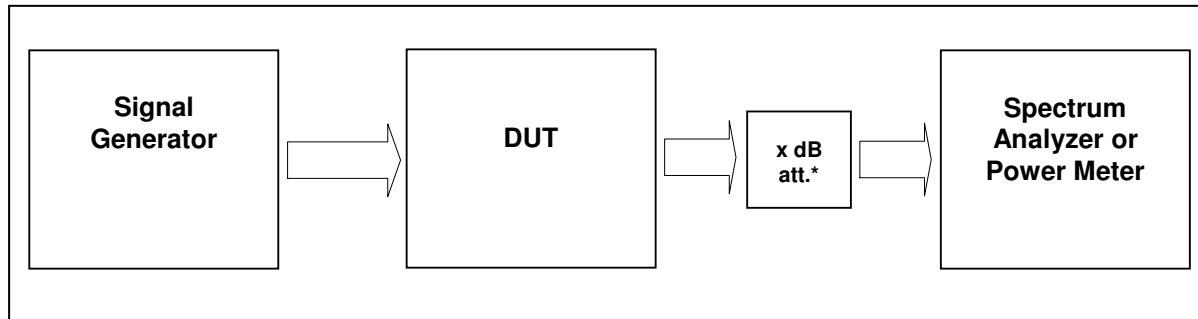

External Attenuator DL x dB = 30 dB
figure 6-#1 Test setup: Occupied Bandwidth: §90.210, §2.1049; RSS-GEN

Measurement uncertainty	± 0,38 dB
Test equipment used	8890; 8667; 8668; 8848; 7355; 7160

6.1 Limit

The spectral shape of the output should look similar to input for all modulations.

6.2 Test method

6.2.1 FCC CFR47

Para. No.2.1049

The occupied bandwidth, that is the frequency bandwidth such that, below its lower and above its upper frequency limits, the mean powers radiated are each equal to 0.5 percent of the total mean power radiated by a given emission shall be measured under the following conditions as applicable:

6.2.2 IC RSS-GEN

4.6.1 Occupied Bandwidth

When an occupied bandwidth value is not specified in the applicable RSS, the transmitted signal bandwidth to be reported is to be its 99% emission bandwidth, as calculated or measured.

The transmitter shall be operated at its maximum carrier power measured under normal test conditions.

The span of the analyzer shall be set to capture all products of the modulation process, including the emission skirts. The resolution bandwidth shall be set to as close to 1% of the selected span as is possible without being below 1%. The video bandwidth shall be set to 3 times the resolution bandwidth. Video averaging is not permitted. Where practical, a sampling detector shall be used since a peak or, peak hold, may produce a wider bandwidth than actual.

The trace data points are recovered and are directly summed in linear terms. The recovered amplitude data points, beginning at the lowest frequency, are placed in a running sum until 0.5% of the total is reached and that frequency recorded. The process is repeated for the highest frequency data points. This frequency is recorded.

The span between the two recorded frequencies is the occupied bandwidth.



6.3 Test results

6.3.1 Downlink

Detector RMS.

Modulation	Measured at		RBW VBW Span	Occupied Bandwidth	Plot #
Analog	Middle	860 MHz	1 kHz 10 kHz 125 kHz	10,9 kHz	6.3.1.1 #1, #2
TDMA	Middle	860 MHz	3 kHz 30 kHz 1 MHz	246,0 kHz	6.3.1.2 #1, #2
EDGE	Middle	860 MHz	3 kHz 30 kHz 1 MHz	246,0 kHz	6.3.1.3 #1, #2
CDMA	Middle	860 MHz	30 kHz 300 kHz 5 MHz	1,26 MHz	6.3.1.4 #1, #2
EV-DO	Middle	860 MHz	30 kHz 300 kHz 5 MHz	1,24 MHz	6.3.1.5 #1, #2
WCDMA	Middle	860 MHz	100 kHz 1 MHz 10 MHz	4,18 MHz	6.3.1.6 #1, #2
HSPA	Middle	860 MHz	100 kHz 1 MHz 10 MHz	4,17 MHz	6.3.1.7 #1, #2

table 6.3-#1 Occupied Bandwidth: §90.210, §2.1049; RSS-GEN Test results



6.3.1.1 Analog

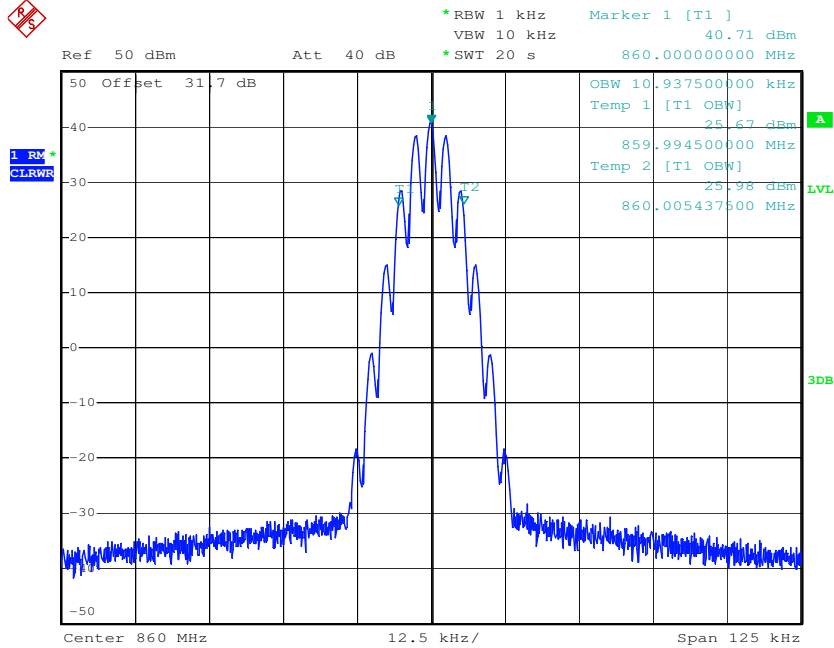

Date: 2.MAR.2010 15:26:36

plot 6.3.1.1-#1 Occupied Bandwidth: §90.210, §2.1049; RSS-GEN; Test results; Downlink; Analog Output

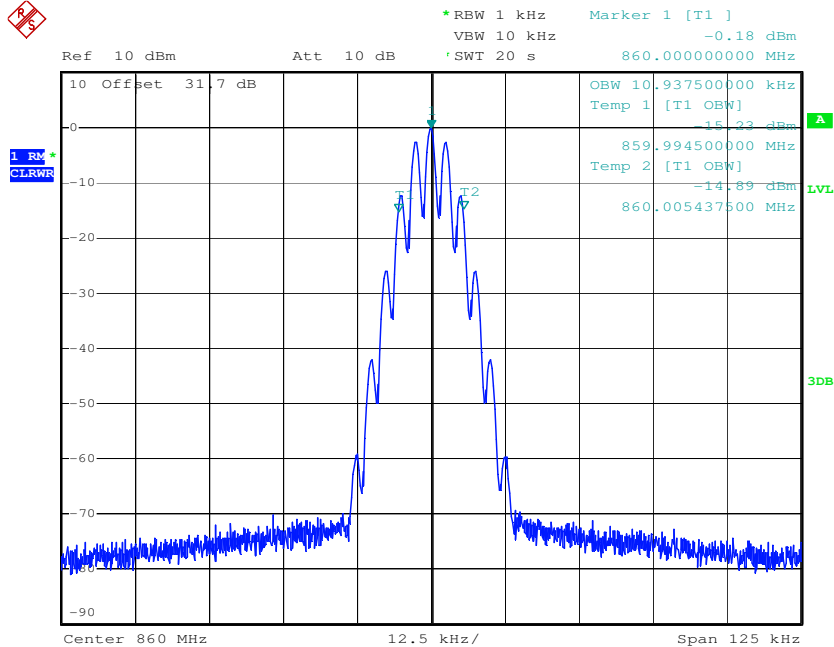

Date: 2.MAR.2010 15:27:49

plot 6.3.1.1-#2 Occupied Bandwidth: §90.210, §2.1049; RSS-GEN; Test results; Downlink; Analog Input



6.3.1.2 TDMA

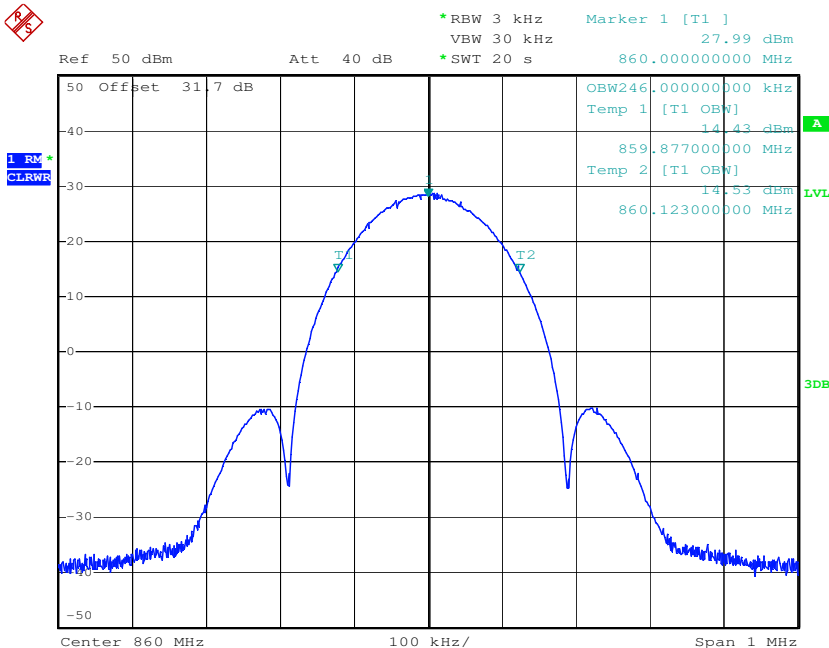

Date: 2.MAR.2010 15:21:55

plot 6.3.1.2-#1 Occupied Bandwidth: §90.210, §2.1049; RSS-GEN; Test results; Downlink; TDMA Output

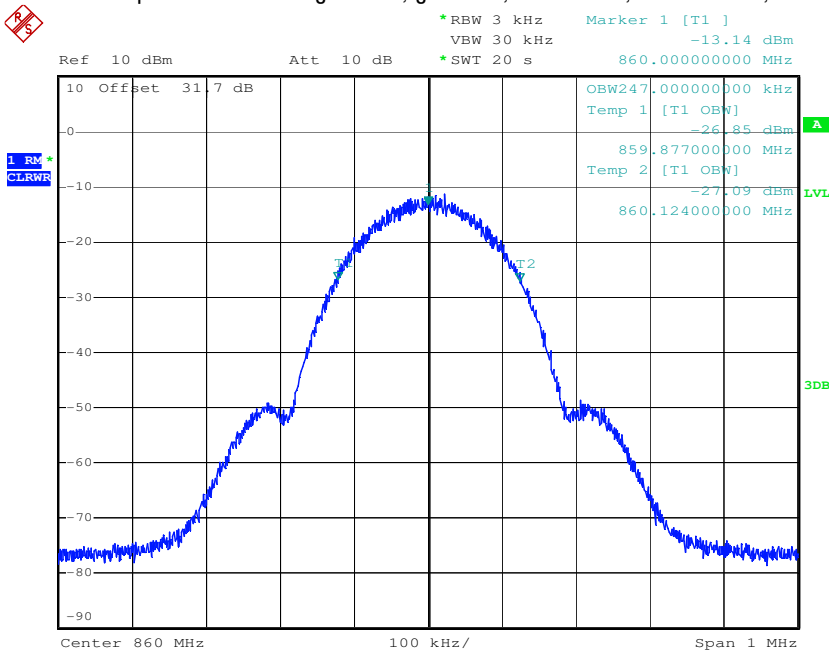

Date: 2.MAR.2010 15:32:04

plot 6.3.1.2-#2 Occupied Bandwidth: §90.210, §2.1049; RSS-GEN; Test results; Downlink; TDMA Input



6.3.1.3 EDGE

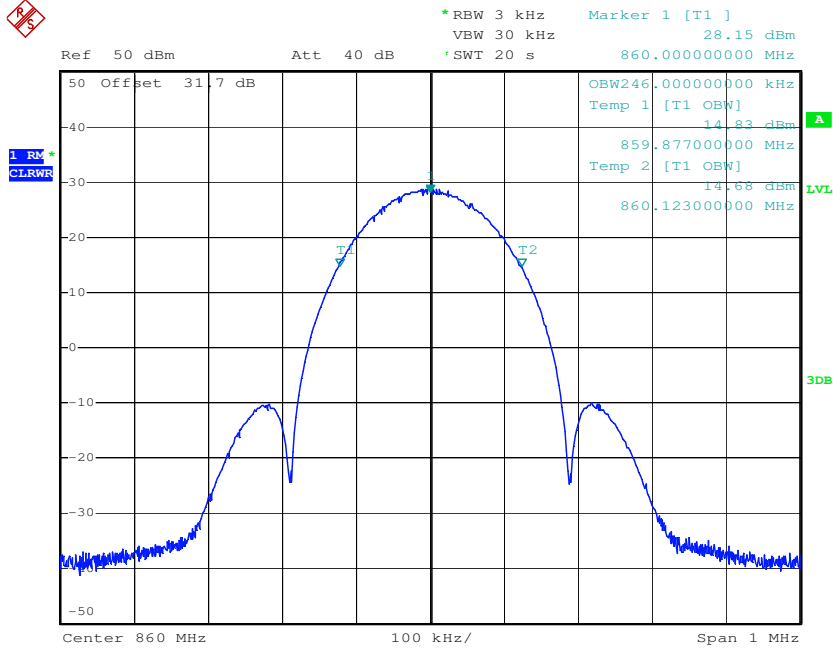

Date: 2.MAR.2010 15:38:23

plot 6.3.1.3-#1 Occupied Bandwidth: §90.210, §2.1049; RSS-GEN; Test results; Downlink; EDGE Output

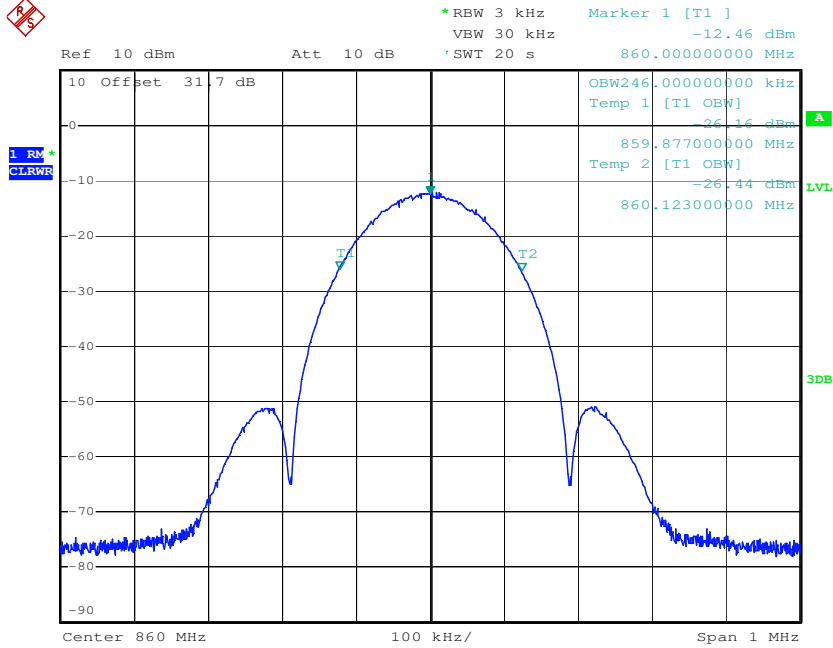

Date: 2.MAR.2010 15:43:55

plot 6.3.1.3-#2 Occupied Bandwidth: §90.210, §2.1049; RSS-GEN; Test results; Downlink; EDGE Input



6.3.1.4 CDMA

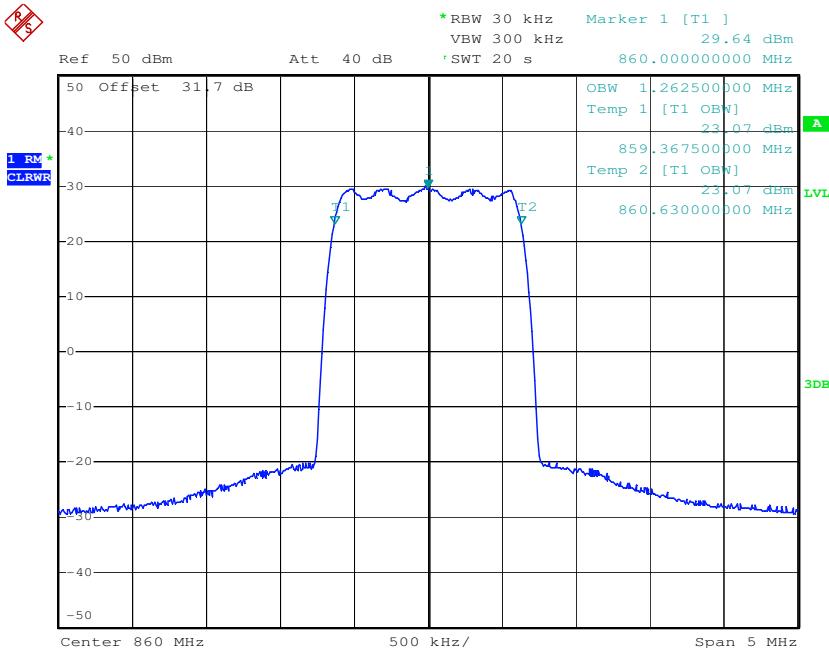

Date: 2.MAR.2010 15:48:12

plot 6.3.1.4-#1 Occupied Bandwidth: §90.210, §2.1049; RSS-GEN; Test results; Downlink; CDMA Output

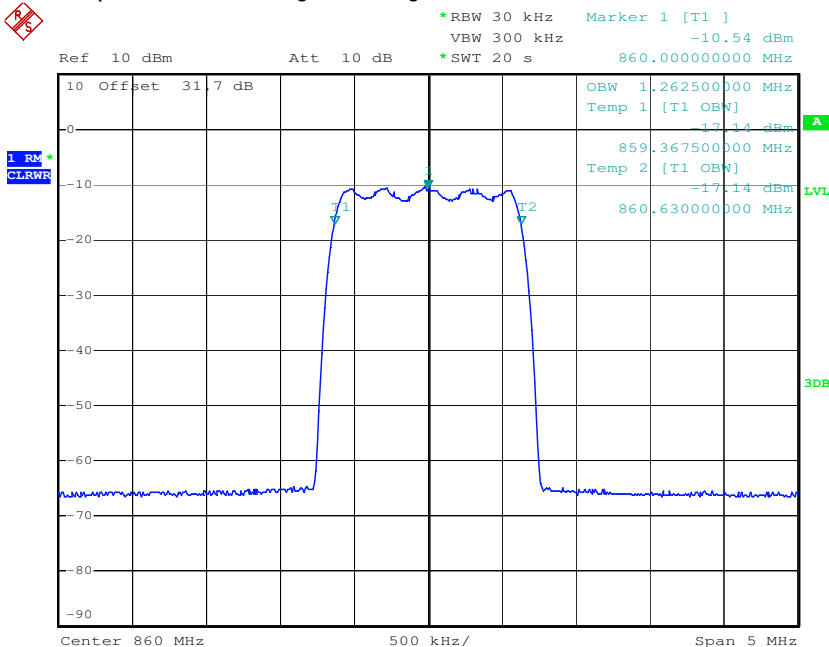

Date: 2.MAR.2010 15:46:22

plot 6.3.1.4-#2 Occupied Bandwidth: §90.210, §2.1049; RSS-GEN; Test results; Downlink; CDMA Input

Test Report No.: 10-062

FCC ID: XS5- ION-M7P8PS

IC ID: 2237E-IONM7P8PS



6.3.1.5 EV-DO

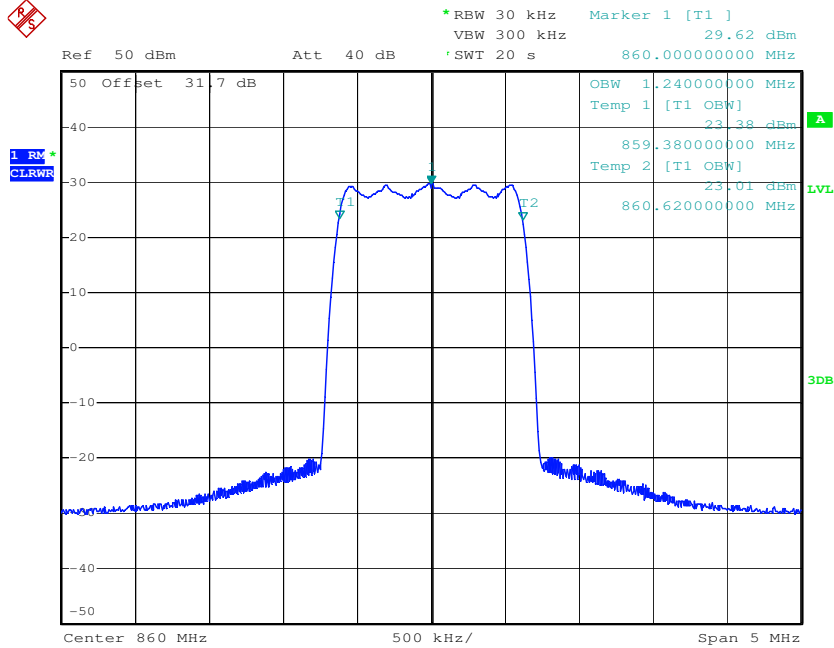

Date: 2.MAR.2010 16:10:39

plot 6.3.1.5-#1 Occupied Bandwidth: §90.210, §2.1049; RSS-GEN; Test results; Downlink; EV-DO Output

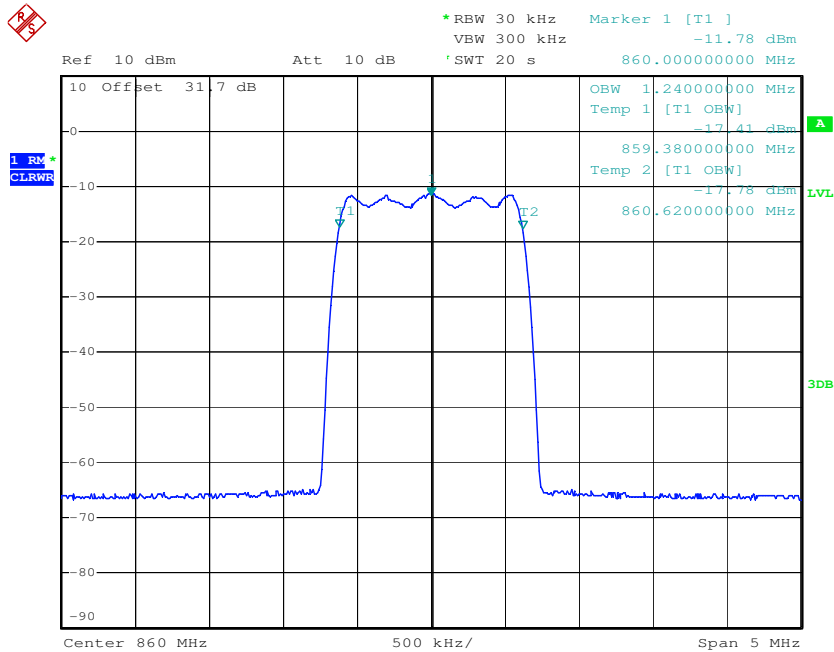

Date: 2.MAR.2010 16:12:24

plot 6.3.1.5-#2 Occupied Bandwidth: §90.210, §2.1049; RSS-GEN; Test results; Downlink; EV-DO Input



6.3.1.6 WCDMA

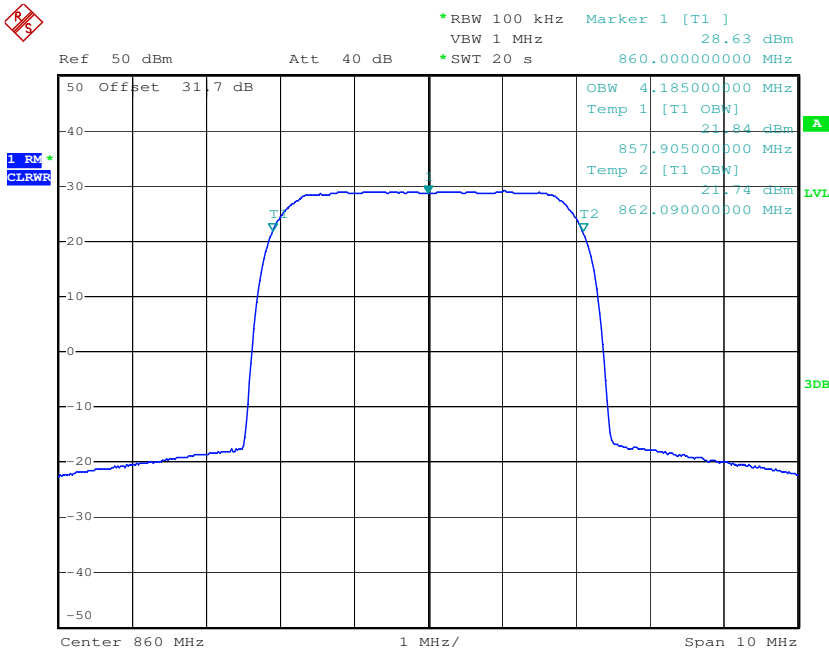

Date: 2.MAR.2010 16:15:36

plot 6.3.1.6-#1 Occupied Bandwidth: §90.210, §2.1049; RSS-GEN; Test results; Downlink; WCDMA Output

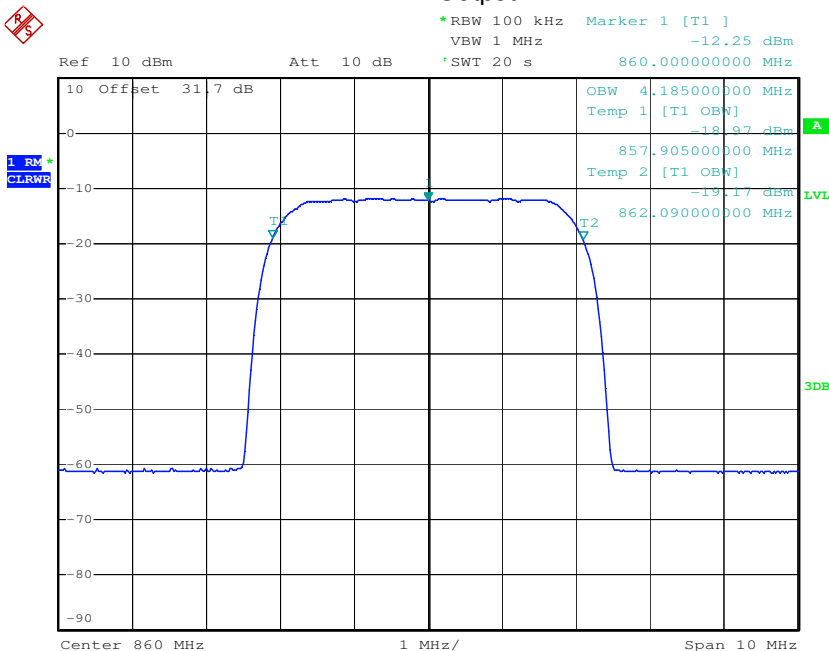

Date: 2.MAR.2010 16:17:01

plot 6.3.1.6-#2 Occupied Bandwidth: §90.210, §2.1049; RSS-GEN; Test results; Downlink; WCDMA Input

6.3.1.7 HSPA

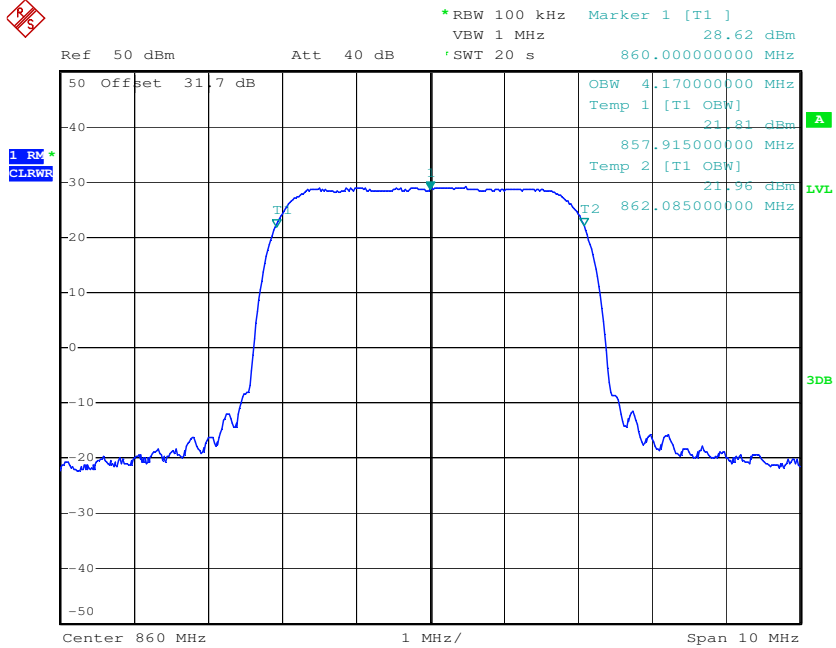

Date: 2.MAR.2010 16:25:26

plot 6.3.1.7-#1 Occupied Bandwidth: §90.210, §2.1049; RSS-GEN; Test results; Downlink; HSPA Output

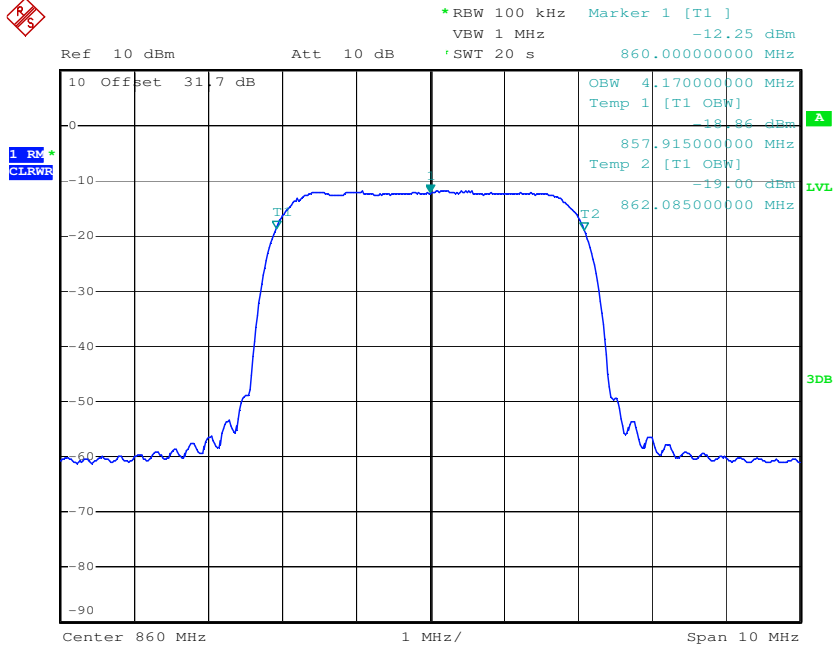

Date: 2.MAR.2010 16:27:24

plot 6.3.1.7-#2 Occupied Bandwidth: §90.210, §2.1049; RSS-GEN; Test results; Downlink; HSPA Input

Test Report No.: 10-062

FCC ID: XS5- ION-M7P8PS

IC ID: 2237E-IONM7P8PS



6.3.2 Uplink

n.a.

Note: The EUT does not transmit over the air in the uplink direction.

6.4 Summary test result

Test result	complies, according the plots above
Tested by:	W. Meir
Date:	2.03.2010

7 Spurious Emissions at Antenna Terminals: §90.210, §2.1051; RSS-131, RSS-GEN

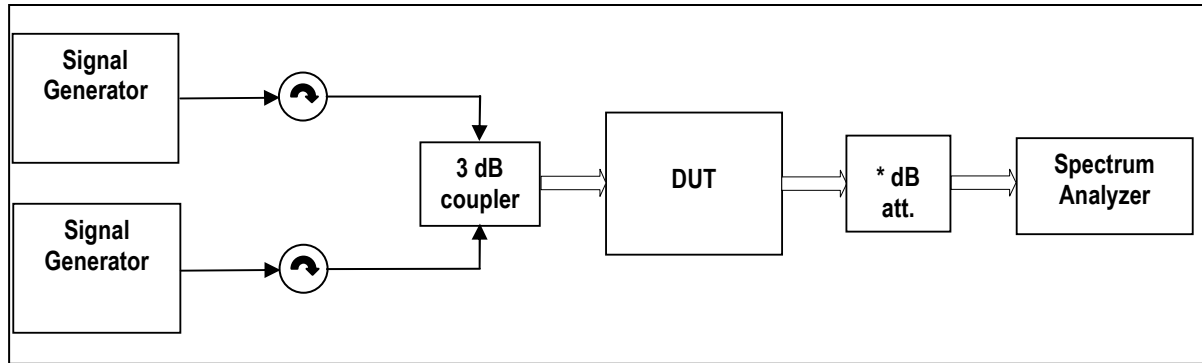

External Attenuator DL x dB = 30 dB

figure 7-#1 Test setup: Spurious Emissions at Antenna Terminals: §90.210, §2.1051; RSS-131, RSS-GEN

Measurement uncertainty	± 0,54 dB ± 1,2 dB ± 1,5 dB	9 kHz to 3 GHz 3 GHz to 7 GHz 7 GHz to 26 GHz
Test equipment used	8890; 8667; 8668; 8848; 7355; 7160	

7.1 Limit

7.1.1 FCC CFR47

§ 90.543 Emission limitations.

Transmitters designed to operate in 769–775 MHz and 799–805 MHz frequency bands must meet the emission limitations in paragraphs (a) through (d) of this section. Transmitters operating in 763–768 MHz and 793–798 MHz bands must meet the emission limitations in(e) of this section.

Limit -13dBm

7.1.2 IC RSS-131

7.2 Test method

7.2.1 FCC CFR47

Para. No 2.1051 Measurements required: Spurious emissions at antenna terminals.

The radio frequency voltage or powers generated within the equipment and appearing on a spurious frequency shall be checked at the equipment output terminals when properly loaded with a suitable artificial antenna. Curves or equivalent data shall show the magnitude of each harmonic and other spurious emission that can be detected when the equipment is operated under the conditions specified in § 2.1049 as appropriate. The magnitude of spurious emissions which are attenuated more than 20 dB below the permissible value need not be specified.

[39 FR 5919, Feb. 15, 1974. Redesignated and amended at 63 FR 36599, July 7, 1998]

7.2.2 IC RSS-GEN



7.3 Test results

7.3.1 Downlink

<1MHz from Band Edge

Detector: RMS.

Modulation	Measured at Band Edge	Carriers	RBW VBW Span Sweep points	Max. level (dBm)	Plot -
Analog	Lower Edge Upper Edge	851,0125 MHz 851,0375 MHz 868,9625 MHz 868,9875 MHz	300Hz 3kHz 100kHz 2000 points	< -25	7.3.1.1 #1 #2
TDMA	Lower Edge Upper Edge	851,3 MHz 851,7 MHz 868,5 MHz 868,7 MHz	3kHz 30kHz 2MHz 2000 points	< -27	7.3.1.2 #1 #2
EDGE	Lower Edge Upper Edge	851,3 MHz 851,7 MHz 868,5 MHz 868,7 MHz	3kHz 30kHz 2MHz	< -28	7.3.1.3 #1 #2
CDMA	Lower Edge Upper Edge	852,875 MHz 854,125 MHz 865,875 MHz 867,125 MHz	30kHz 300kHz 10MHz	< -24	7.3.1.4 #1 #2
EV-DO	Lower Edge Upper Edge	852,875 MHz 854,125 MHz 865,875 MHz 867,125 MHz	30kHz 300kHz 10MHz	< -16	7.3.1.5 #1 #2
WCDMA	Lower Edge Upper Edge	856 MHz 861 MHz 859 MHz 864 MHz	100kHz 1MHz 25MHz	< -19	7.3.1.6 #1 #2
HSPA	Lower Edge Upper Edge	856 MHz 861 MHz 859 MHz 864 MHz	100kHz 1MHz 25MHz	< -15	7.3.1.7 #1 #2

table 7.3-#1 Spurious Emissions at Antenna Terminals: §90.210, §2.1051; RSS-131, RSS-GEN Test results <1MHz from Band Edge

Test Report No.: 10-062

FCC ID: XS5- ION-M7P8PS

IC ID: 2237E-IONM7P8PS



>1MHz from Band Edge

Detector: RMS.

Modulation	Carrier	RBW VBW Span	Max. level (dBm)	Plot -
Analog	860 MHz	1MHz 3MHz 30MHz – 8GHz	< -35	7.3.1.8 #1
TDMA	860 MHz	1MHz 3MHz 30MHz – 8GHz	< -35	7.3.1.9 #1
EDGE	860 MHz	1MHz 3MHz 30MHz – 8GHz	< -35	7.3.1.10 #1
CDMA	860 MHz	1MHz 3MHz 30MHz – 8GHz	< -35	7.3.1.11 #1
EV-DO	860 MHz	1MHz 3MHz 30MHz – 8GHz	< -35	7.3.1.12 #1
WCDMA	860 MHz	1MHz 3MHz 30MHz – 8GHz	< -35	7.3.1.13 #1
HSPA	860 MHz	1MHz 3MHz 30MHz – 8GHz	< -35	7.3.1.14 #1

table 7.3-#2 Spurious Emissions at Antenna Terminals: §90.210, §2.1051; RSS-131, RSS-GEN Test results <1MHz from Band Edge



7.3.1.1 Analog < 1MHz to band edge

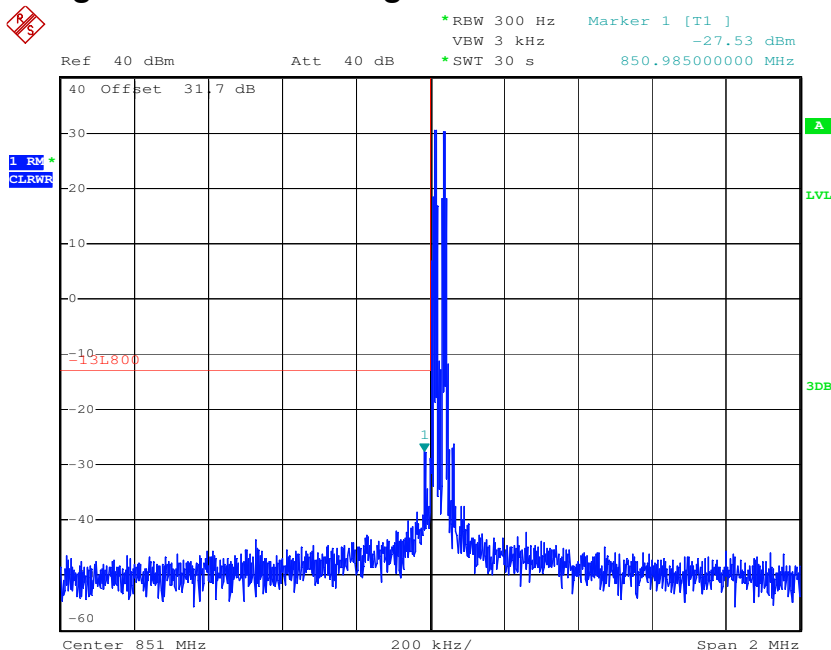

Date: 16.MAR.2010 15:00:36

plot 7.3.1.1-#1 Spurious Emissions at Antenna Terminals: §90.210, §2.1051; RSS-131, RSS-GEN; Test results; Downlink; Analog < 1MHz to band edge Lower Band Edge

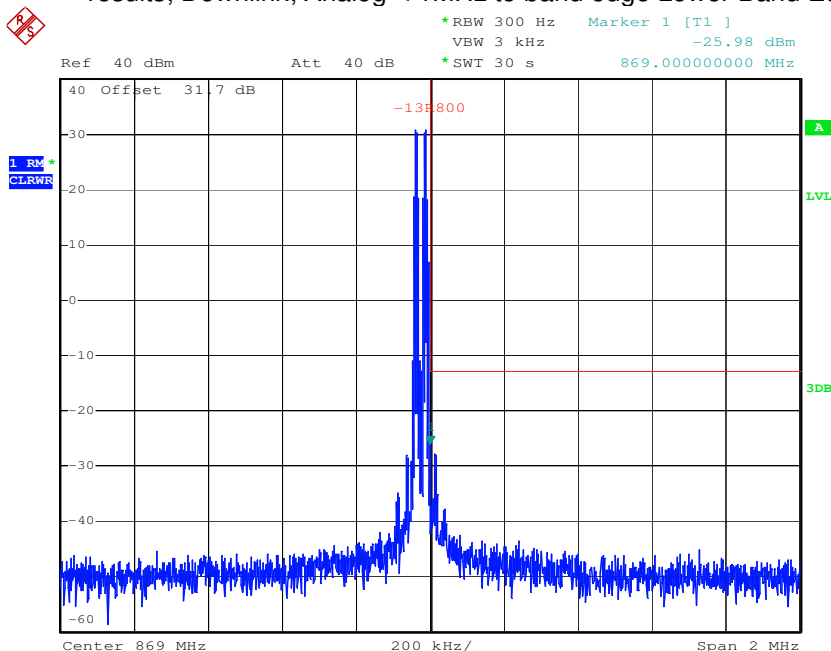

Date: 16.MAR.2010 15:14:33

plot 7.3.1.1-#2 Spurious Emissions at Antenna Terminals: §90.210, §2.1051; RSS-131, RSS-GEN; Test results; Downlink; Analog < 1MHz to band edge Upper Band Edge

Test Report No.: 10-062

FCC ID: XS5- ION-M7P8PS

IC ID: 2237E-IONM7P8PS



7.3.1.2 TDMA < 1MHz to band edge

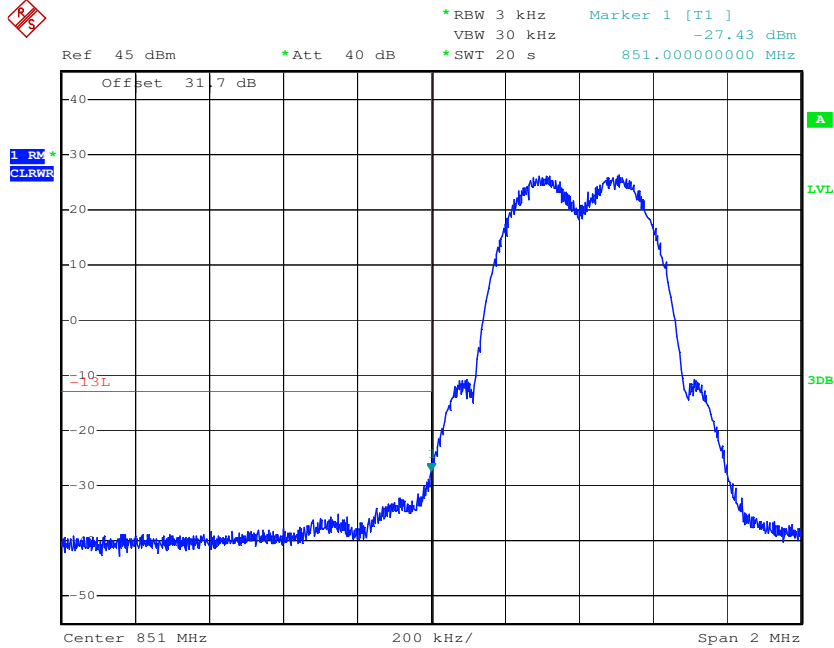

Date: 3.MAR.2010 14:55:37

plot 7.3.1.2-#1 Spurious Emissions at Antenna Terminals: §90.210, §2.1051; RSS-131, RSS-GEN; Test results; Downlink; TDMA < 1MHz to band edge Lower Band Edge

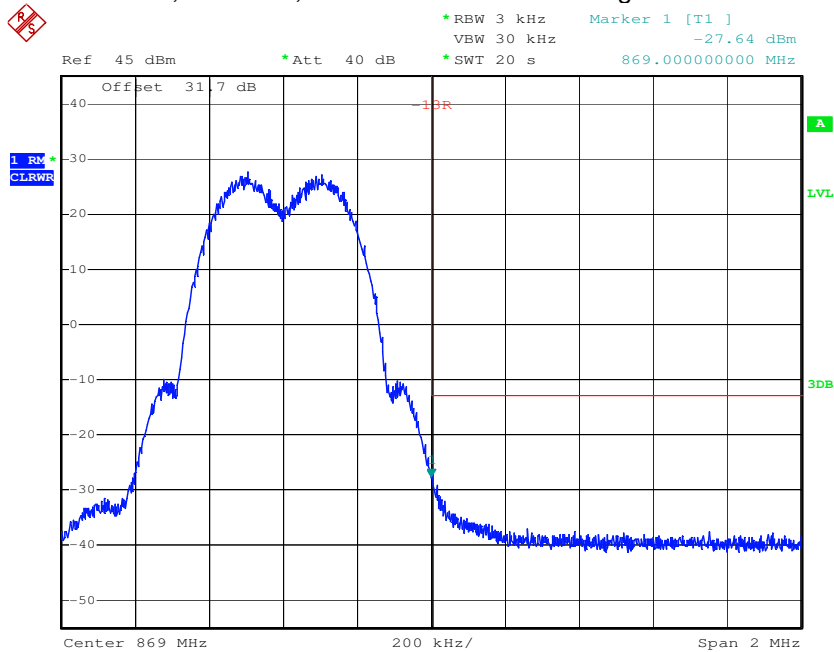

Date: 3.MAR.2010 14:58:47

plot 7.3.1.2-#2 Spurious Emissions at Antenna Terminals: §90.210, §2.1051; RSS-131, RSS-GEN; Test results; Downlink; TDMA < 1MHz to band edge Upper Band Edge



7.3.1.3 EDGE < 1MHz to band edge

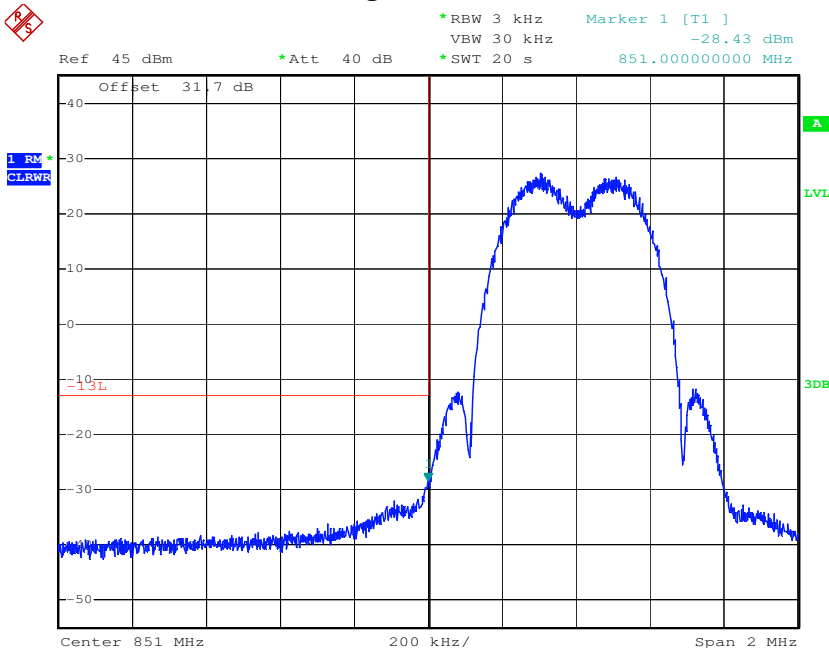

Date: 3.MAR.2010 15:46:01

plot 7.3.1.3-#1 Spurious Emissions at Antenna Terminals: §90.210, §2.1051; RSS-131, RSS-GEN; Test results; Downlink; EDGE < 1MHz to band edge Lower Band Edge

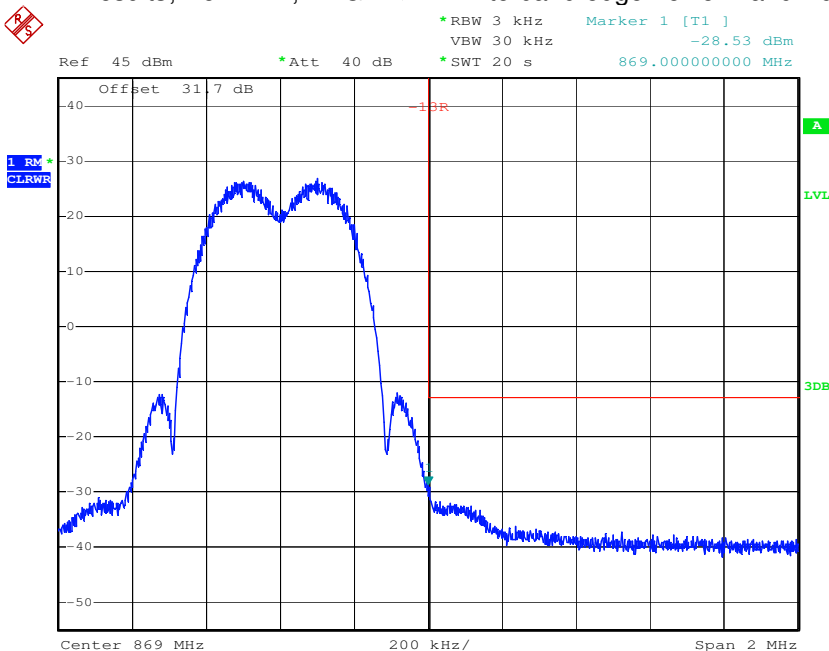

Date: 3.MAR.2010 15:04:14

plot 7.3.1.3-#2 Spurious Emissions at Antenna Terminals: §90.210, §2.1051; RSS-131, RSS-GEN; Test results; Downlink; EDGE < 1MHz to band edge Upper Band Edge



7.3.1.4 CDMA < 1MHz to band edge

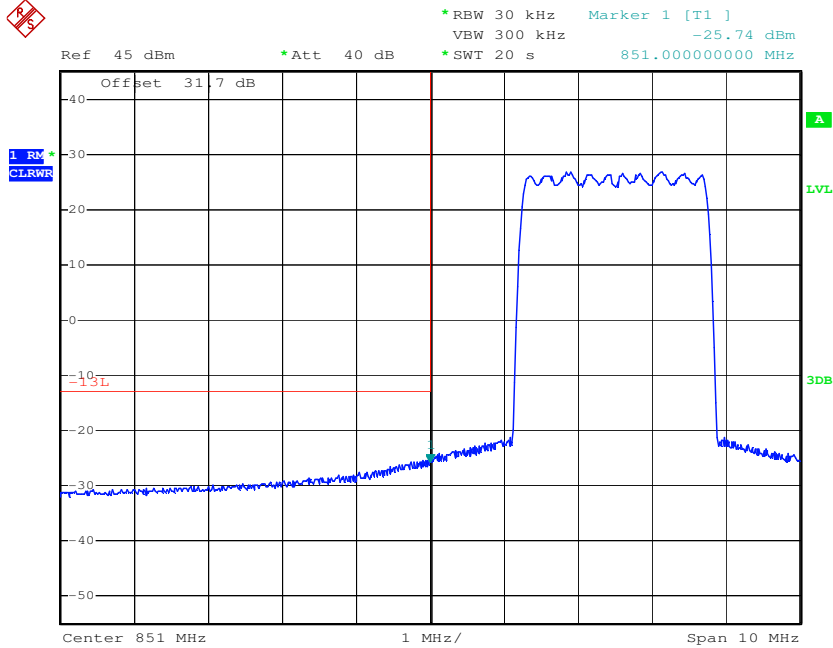

Date: 3.MAR.2010 15:59:29

plot 7.3.1.4-#1 Spurious Emissions at Antenna Terminals: §90.210, §2.1051; RSS-131, RSS-GEN; Test results; Downlink; CDMA < 1MHz to band edge Lower Band Edge

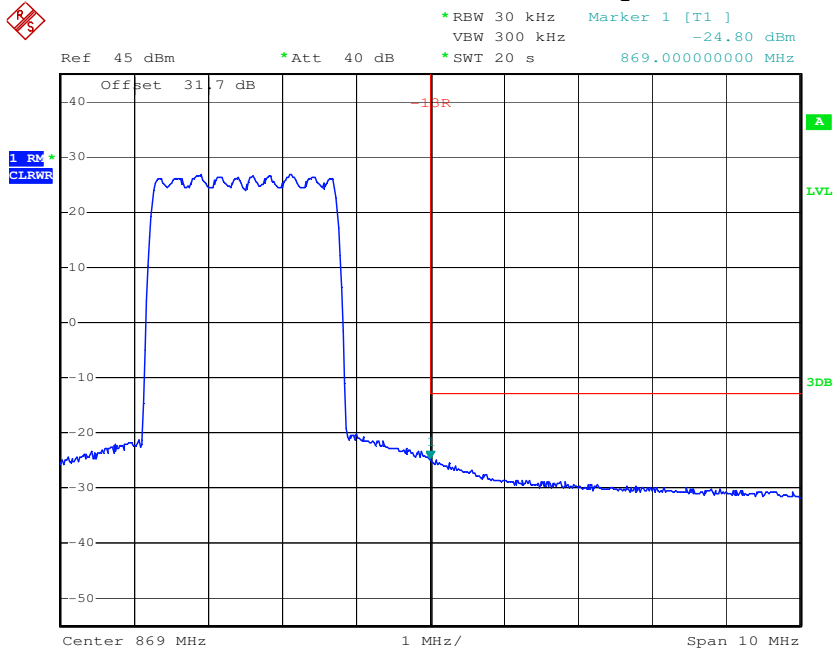

Date: 3.MAR.2010 16:03:16

plot 7.3.1.4-#2 Spurious Emissions at Antenna Terminals: §90.210, §2.1051; RSS-131, RSS-GEN; Test results; Downlink; CDMA < 1MHz to band edge Upper Band Edge



7.3.1.5 EV-DO < 1MHz to band edge

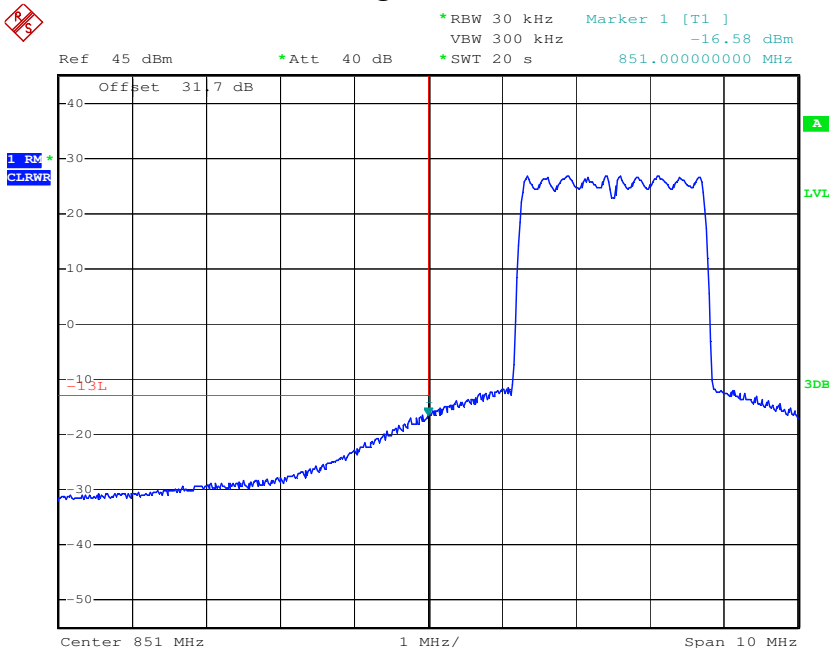

Date: 3.MAR.2010 16:15:04

plot 7.3.1.5-#1 Spurious Emissions at Antenna Terminals: §90.210, §2.1051; RSS-131, RSS-GEN; Test results; Downlink; EV-DO < 1MHz to band edge Lower Band Edge

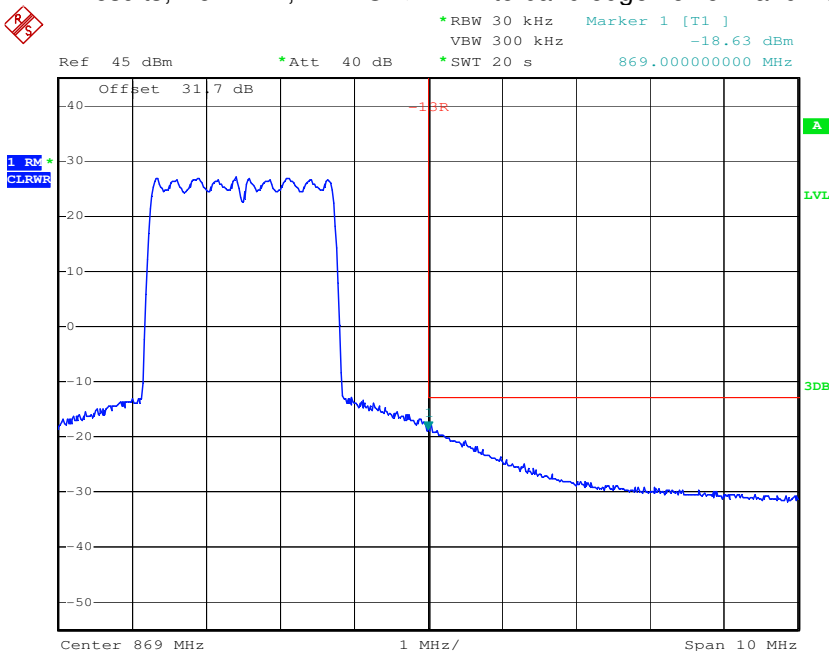

Date: 3.MAR.2010 16:06:42

plot 7.3.1.5-#2 Spurious Emissions at Antenna Terminals: §90.210, §2.1051; RSS-131, RSS-GEN; Test results; Downlink; EV-DO < 1MHz to band edge Upper Band Edge

7.3.1.6 WCDMA < 1MHz to band edge

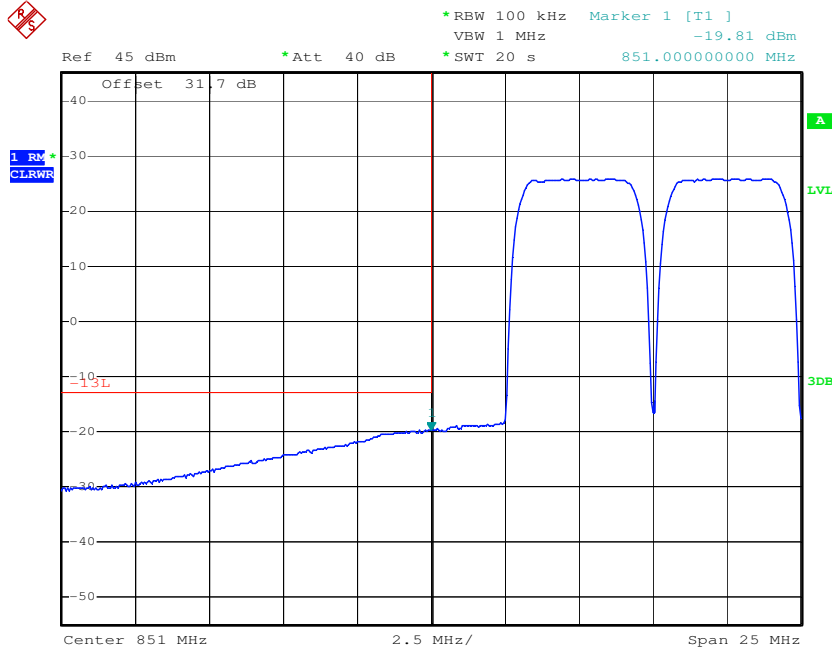

Date: 3.MAR.2010 16:34:54

plot 7.3.1.6-#1 Spurious Emissions at Antenna Terminals: §90.210, §2.1051; RSS-131, RSS-GEN; Test results; Downlink; WCDMA < 1MHz to band edge Lower Band Edge

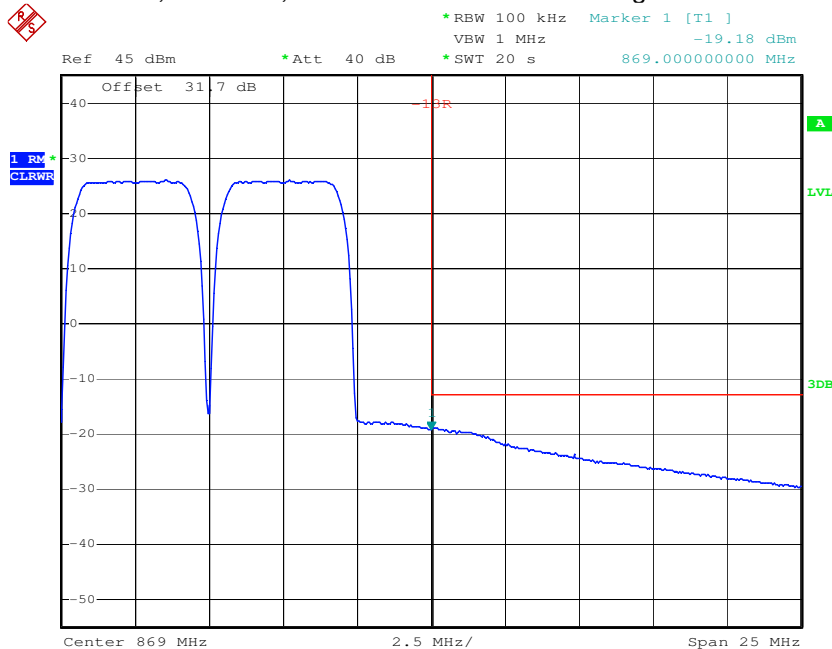

Date: 3.MAR.2010 16:33:48

plot 7.3.1.6-#2 Spurious Emissions at Antenna Terminals: §90.210, §2.1051; RSS-131, RSS-GEN; Test results; Downlink; WCDMA < 1MHz to band edge Upper Band Edge



7.3.1.7 HSPA < 1MHz to band edge

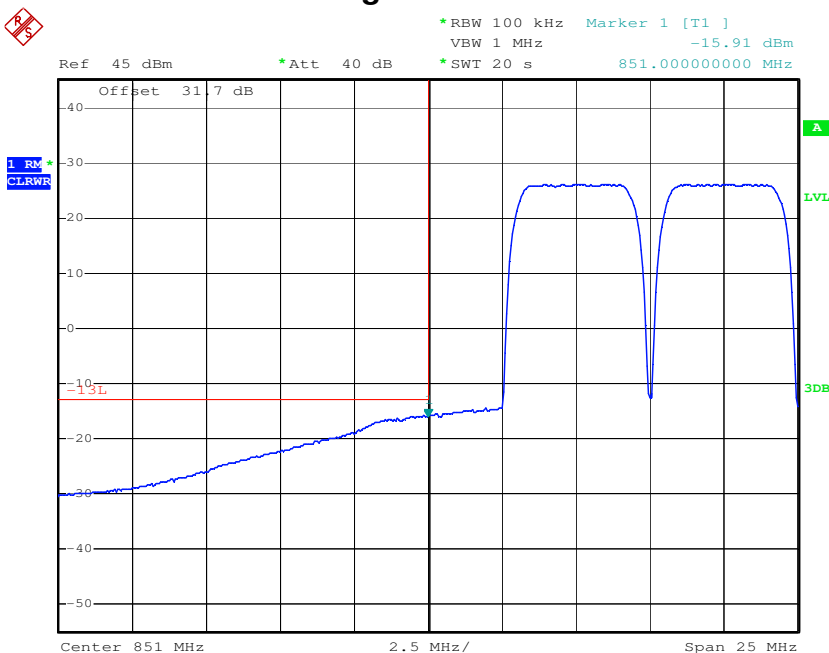

Date: 3.MAR.2010 16:36:25

plot 7.3.1.7-#1 Spurious Emissions at Antenna Terminals: §90.210, §2.1051; RSS-131, RSS-GEN; Test results; Downlink; HSPA < 1MHz to band edge Lower Band Edge

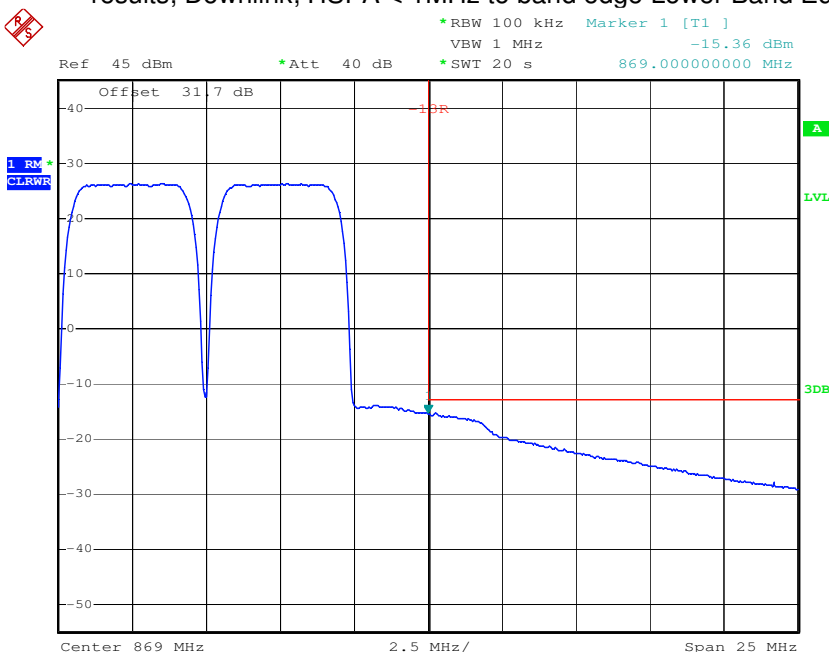

Date: 3.MAR.2010 16:44:37

plot 7.3.1.7-#2 Spurious Emissions at Antenna Terminals: §90.210, §2.1051; RSS-131, RSS-GEN; Test results; Downlink; HSPA < 1MHz to band edge Upper Band Edge

7.3.1.8 Analog > 1MHz to band edge

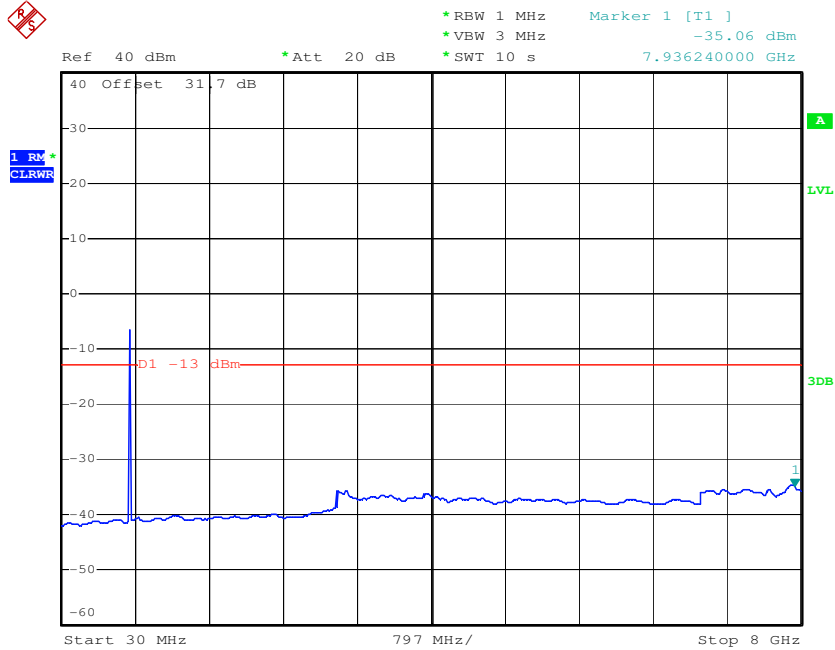

Date: 4.MAR.2010 09:55:12

plot 7.3.1.8-#1 Spurious Emissions at Antenna Terminals: §90.210, §2.1051; RSS-131, RSS-GEN; Test results; Downlink; Analog > 1MHz to band edge; carrier notched

7.3.1.9 TDMA > 1MHz to band edge

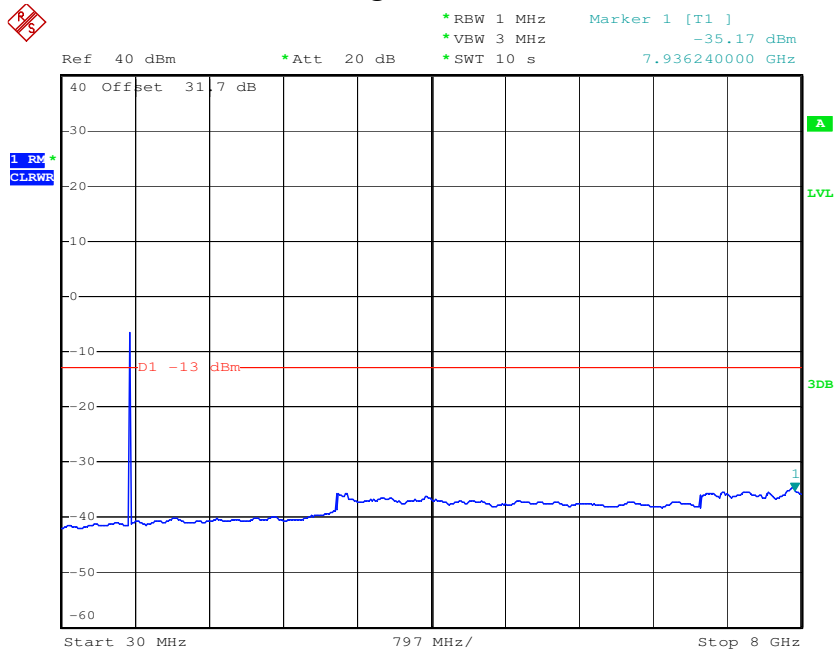

Date: 4.MAR.2010 10:12:13



plot 7.3.1.9-#1 Spurious Emissions at Antenna Terminals: §90.210, §2.1051; RSS-131, RSS-GEN; Test results; Downlink; TDMA > 1MHz to band edge; carrier notched

7.3.1.10 EDGE > 1MHz to band edge

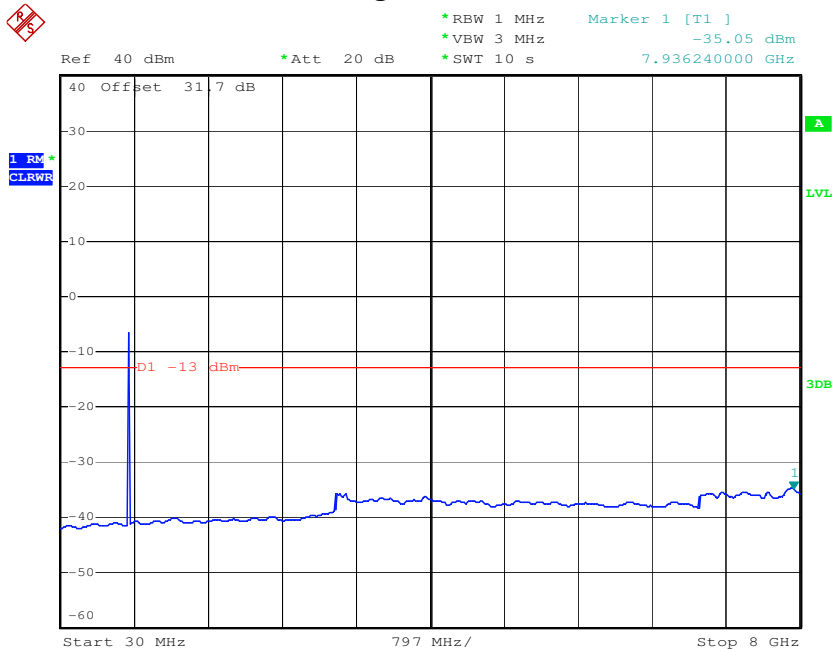

Date: 4.MAR.2010 10:13:41

plot 7.3.1.10-#1 Spurious Emissions at Antenna Terminals: §90.210, §2.1051; RSS-131, RSS-GEN; Test results; Downlink; EDGE > 1MHz to band edge; carrier notched

Test Report No.: 10-062

FCC ID: XS5- ION-M7P8PS

IC ID: 2237E-IONM7P8PS



7.3.1.11 CDMA > 1MHz to band edge

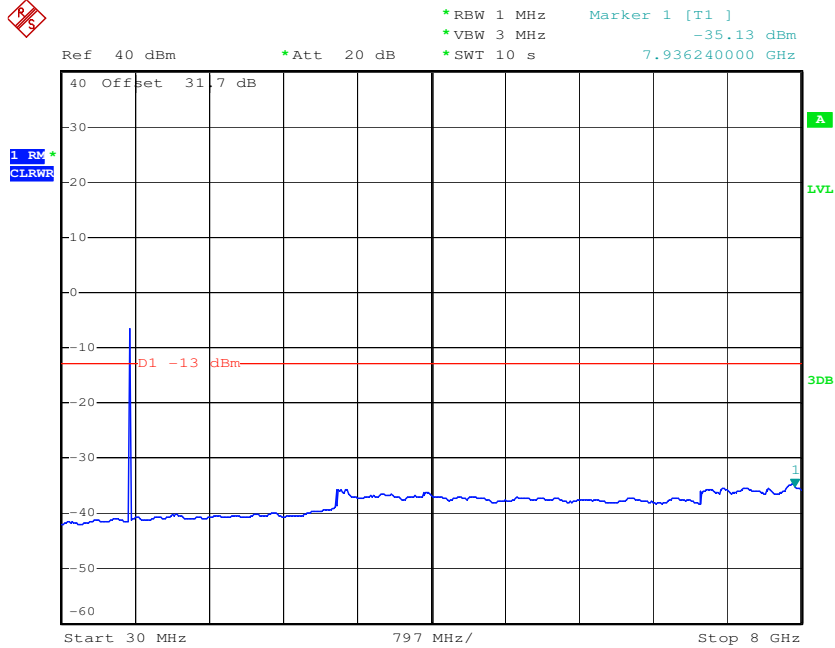

Date: 4.MAR.2010 10:17:11

plot 7.3.1.11-#1 Spurious Emissions at Antenna Terminals: §90.210, §2.1051; RSS-131, RSS-GEN; Test results; Downlink; CDMA > 1MHz to band edge; carrier notched

7.3.1.12 EV-DO > 1MHz to band edge

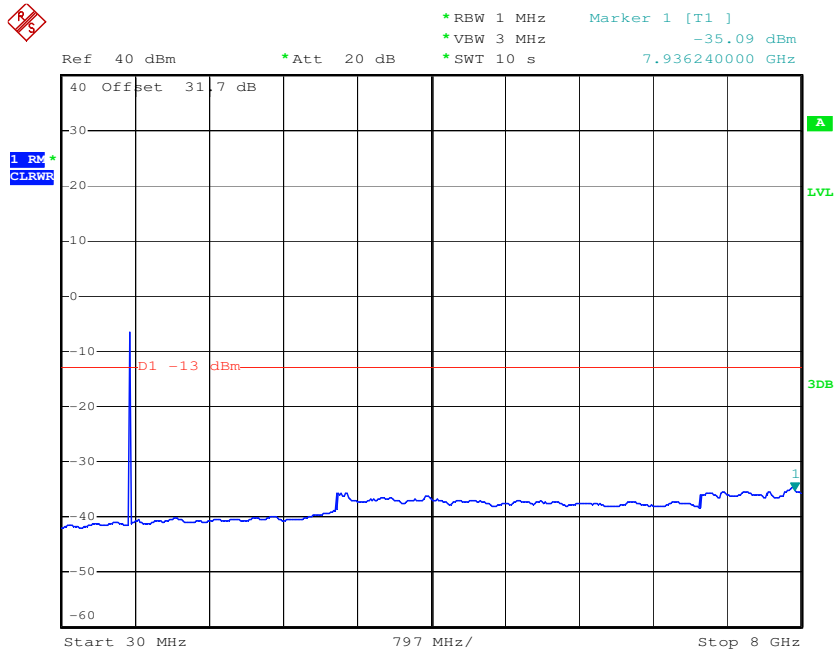

Date: 4.MAR.2010 10:21:14

plot 7.3.1.12-#1 Spurious Emissions at Antenna Terminals: §90.210, §2.1051; RSS-131, RSS-GEN; Test results; Downlink; EV-DO > 1MHz to band edge; carrier notched



7.3.1.13 WCDMA > 1MHz to band edge

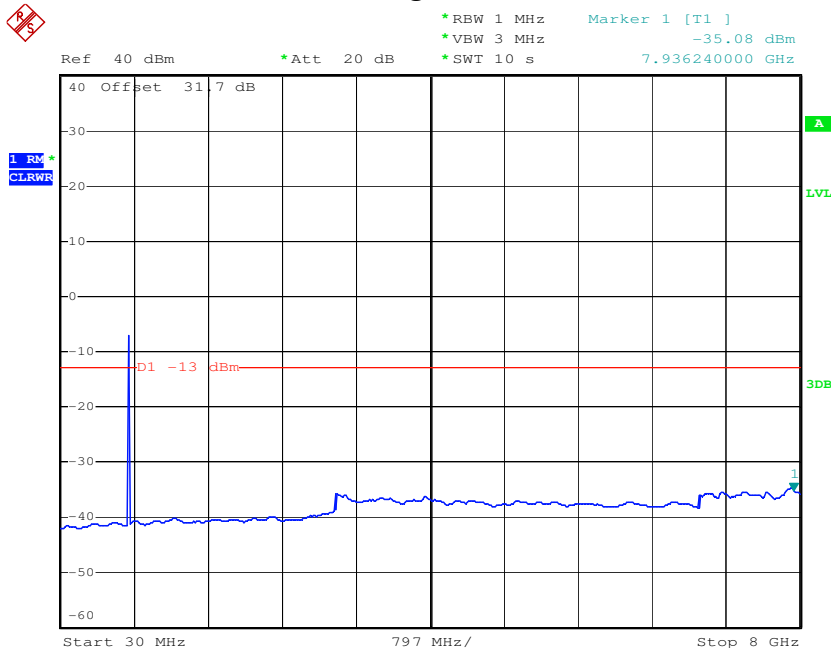

Date: 4.MAR.2010 10:31:45

plot 7.3.1.13-#1 Spurious Emissions at Antenna Terminals: §90.210, §2.1051; RSS-131, RSS-GEN; Test results; Downlink; WCDMA > 1MHz to band edge; carrier notched

7.3.1.14 HSPA > 1MHz to band edge

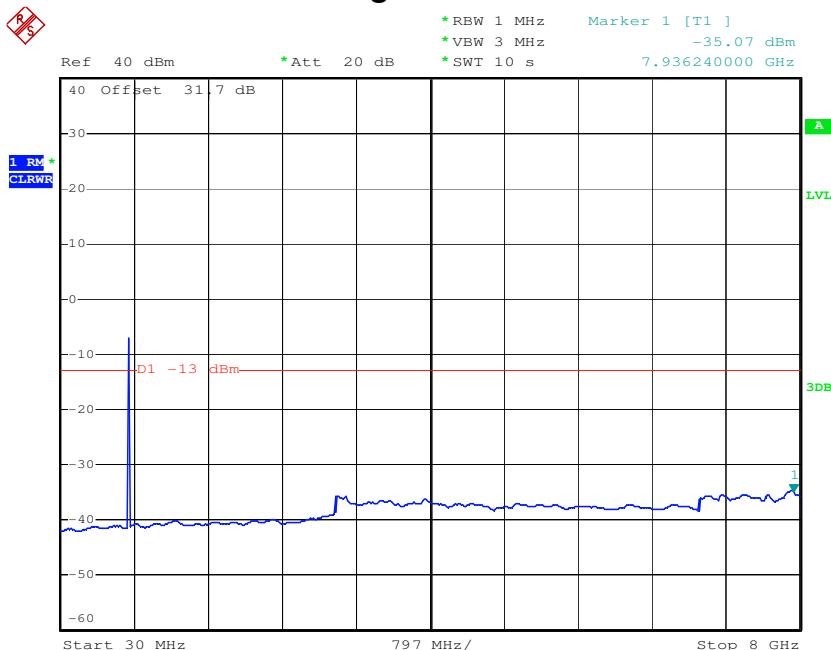

Date: 4.MAR.2010 10:40:50

plot 7.3.1.14-#1 Spurious Emissions at Antenna Terminals: §90.210, §2.1051; RSS-131, RSS-GEN; Test results; Downlink; HSPA > 1MHz to band edge; carrier notched

Test Report No.: 10-062

FCC ID: XS5- ION-M7P8PS

IC ID: 2237E-IONM7P8PS



7.3.2 Uplink

n.a.

Note: The EUT does not transmit over the air in the uplink direction.

7.4 Summary test result

Test result	complies, according the plots above
Tested by:	W. Meir
Date:	4.03.2010

8 Radiated Spurious Emissions at the ECL (TEMPTON): §90.210, §2.1053, RSS-Gen, RSS-131

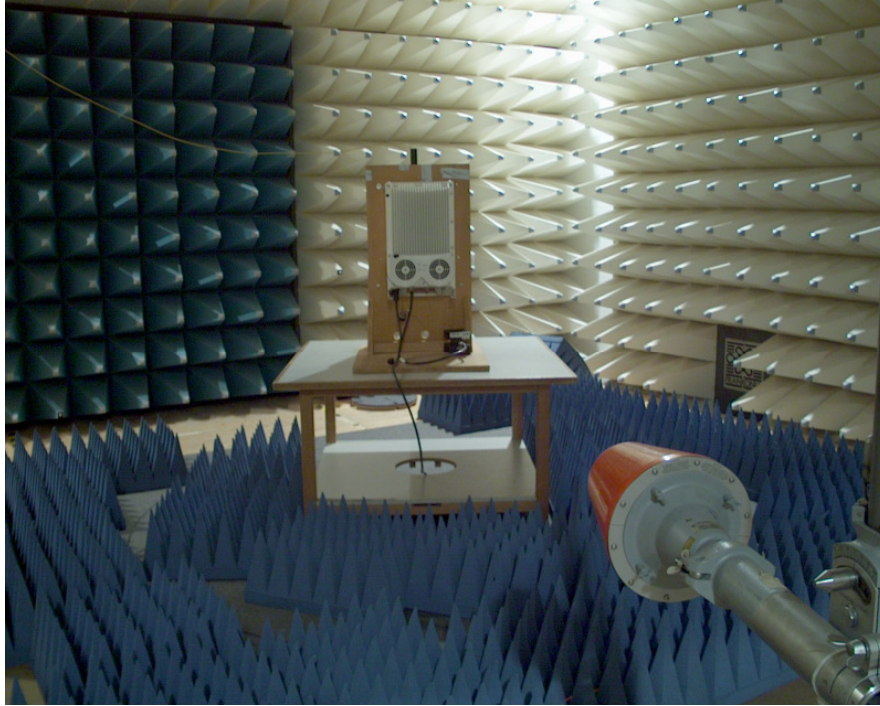

picture 7.1: Test setup: Field Strength Emission >1 GHz @3m in the FAC

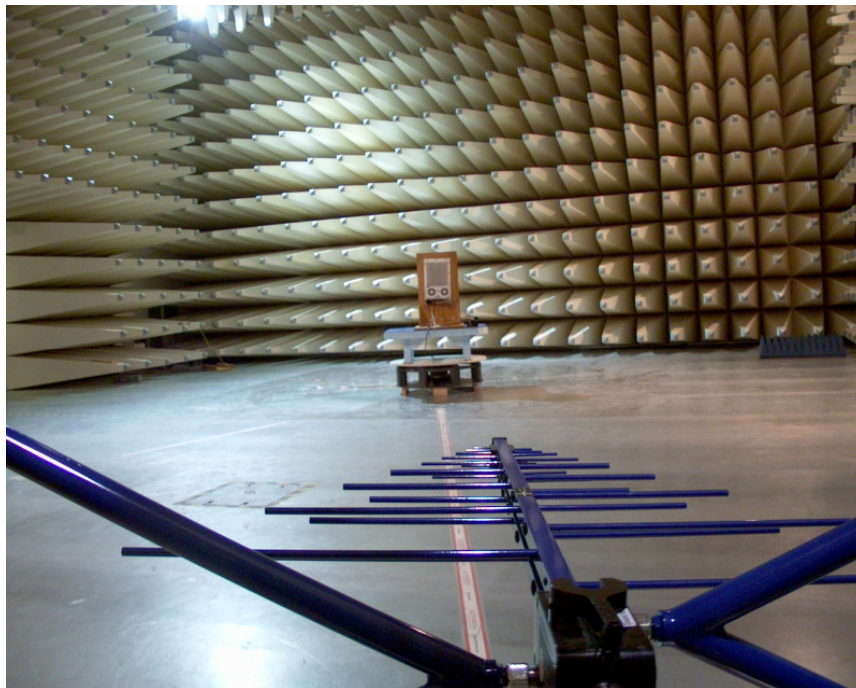

picture 7.2: Test setup: Field Strength Emission <1 GHz @10m in the SAC

Test Report No.: 10-062

FCC ID: XS5- ION-M7P8PS

IC ID: 2237E-IONM7P8PS



This clause specifies requirements for the measurement of radiated emission.

Frequency range	Distance: EUT <-> antenna / location	Limit	Test method
30 MHz - 1 GHz	10 metres / SAC	FCC 47 CFR Part 90.543 IC RSS-131 sec. 6.4	TIA/EIA-603-C:2004
1 GHz – 9 GHz	3 metres / FAC	FCC 47 CFR Part 90.543 IC RSS-131 sec. 6.4	

Test equipment used:

Designation	Type	Manufacturer	Invent.-no.	Cal.-date	due Cal.- date	used
EMI test receiver	ESI40	Rohde & Schwarz	E1687	20.10.2009	20.10.2010	X
EMI test receiver	ESI40	Rohde & Schwarz	E1607	04.03.2009	04.03.2010	
Antenna	CBL 6111	Chase	K1149	14.09.2009	14.09.2010	X
Antenna	CBL 6111	Chase	K1026	14.09.2009	14.09.2010	
RF Cable		Frankonia	K1121 SET	28.12.2009	28.12.2010	X
Pre amplifier	AM1431	Miteq	K1721	27.04.2009	27.04.2010	X
Antenna	HL 025	R&S	K809	06.05.2009	06.05.2010	X
Antenna	MWH-1826 / B	ARA Inc.	K1042	06.04.2009	06.04.2010	
Antenna	MWH-2640 / B	ARA Inc.	K1043	06.04.2009	06.04.2010	
Preamplifier	AFS4-00102000	Miteq	K817	11.11.2009	11.11.2010	X
Preamplifier	AFS4-00102000	Miteq	K838	06.10.2009	06.10.2010	
Preamplifier	JS43-1800-4000	Miteq	K1104	26.08.2009	26.08.2010	
RF Cable	Sucoflex 100	Suhner	K1742	09.04.2009	09.04.2010	X

The Tile-Software Version 4 has been used to maximize radiated emission from the EUT in the frequency area up to 1 GHz. Above 1 GHz the REMI version 2.135 has been used for max search.

Test set-up:

Test location: SAC/FAC
Both, the Fully Anechoic Chamber (FAC) and the Semi Anechoic Chamber (SAC) fulfil the requirements of ANSI C63.4 and CISPR 16-1-4 with regards to NSA and SVSWR.

Test Voltage: 115V / 60 Hz
Type of EUT: Wall mounted

Measurement uncertainty:

Measurement uncertainty expanded (95% or K=2)	± 4,7 dB for ANSI C63.4 measurement ± 0,5 dB for TIA-603 measurement
--	---

8.1 Method of Measurement

Measurement procedure. TIA-603-C

The antenna substitution method is used to determine the equivalent radiated power at spurious frequencies. The spurious emissions are measured at a distance of 3 meters. The EUT is then replaced with a reference substitution antenna with a known gain referenced to a dipole. This antenna is fed with a signal at the spurious frequency. The level of the signal is adjusted to repeat the previously measured level. The resulting eirp is the signal level fed to the reference antenna corrected for gain referenced to an isotropic dipole (see Figure 7.2).

From KDB (AMPLIFIER, BOOSTER, AND REPEATER REMINDER SHEET):

Radiated spurs (enclosure) – Use of CW signal (low, mid, and high freq.) is acceptable rather than all modulations.

The maximum RFI field strength was determined during the measurement by rotating the turntable (± 180 degrees) and varying the height of the receive antenna ($h = 1 \dots 4$ m) as like defined in ANSI C63.4. A measurement receiver has been used with a RBW 120 kHz up to 1 GHz and 1 MHz above 1 GHz. Steps with during pre measurement was half the RBW.

Both, the Fully Anechoic Chamber (FAC) and the Semi Anechoic Chamber (SAC) fulfil the requirements of ANSI C63.4 and CISPR 16-1-4 with regards to NSA and SVSWR.

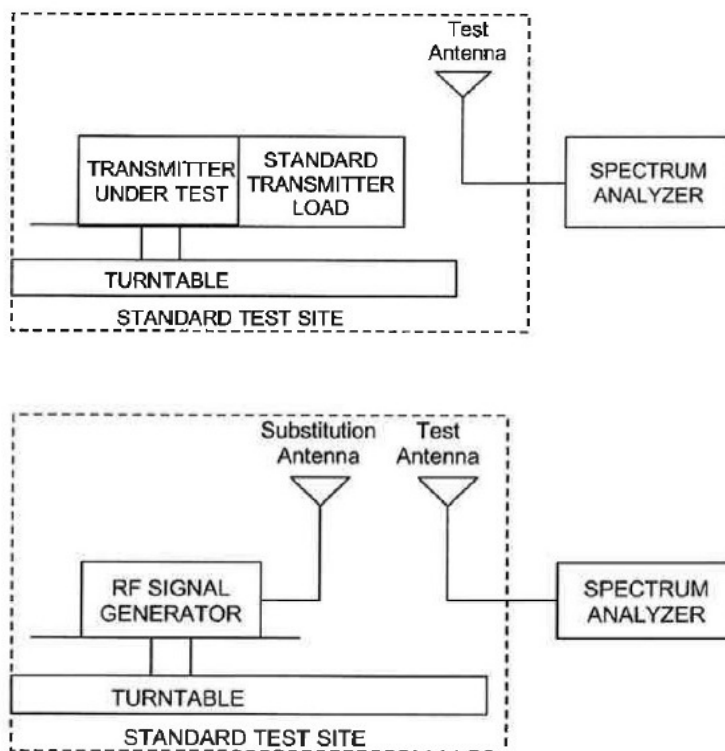

Figure #7.2 Substitution methods TIA/EIA-603-C

Test Report No.: 10-062

FCC ID: XS5- ION-M7P8PS

IC ID: 2237E-IONM7P8PS



8.2 Limit

§90.210 Emission masks / RSS-GEN sec. 4.9; RSS-131 sec. 6.4

Frequency band (MHz)	Mask for equipment with Audio low pass filter	Mask for equipment without audio low pass filter
806–809/851–854	B	H
809–824/854–869	B	G

(g) *Emission Mask G.* For transmitters that are not equipped with an audio low-pass filter, the power of any emission must be attenuated below the unmodulated carrier power (P) as follows:

(2) On any frequency removed from the center of the authorized bandwidth by more than 250 percent of the authorized bandwidth: At least $43 + 10 \log (P)$ dB.

(h) *Emission Mask H.* For transmitters that are not equipped with an audio low-pass filter, the power of any emission must be attenuated below the unmodulated carrier power (P) as follows:

(5) On any frequency removed from the center of the authorized bandwidth by more than 25 kHz: At least $43 + \log (P)$ dB.

The Emission limit is -13dBm

8.3 Climatic values in the lab

Temperature: 19,5°
Relative Humidity: 43%
Air-pressure: 998 hPa



8.4 Test results

8.4.1 Premeasurements

8.4.1.1 30 MHz to 1 GHz Downlink (Bottom – Middle – Top)

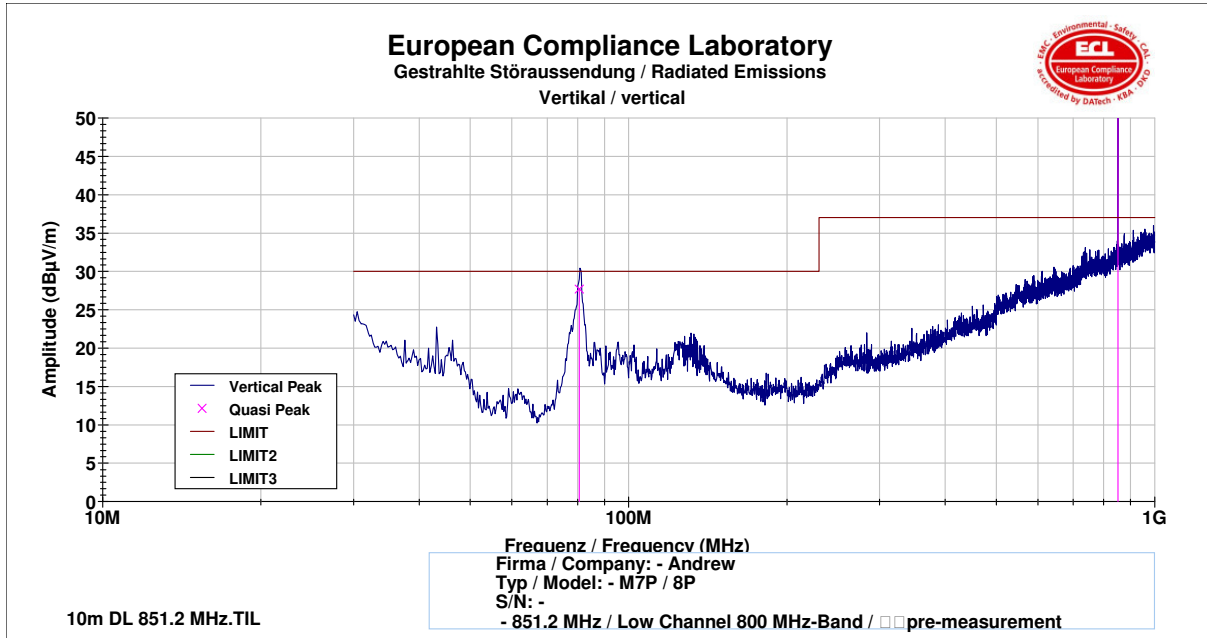

Frequency	Polarisation	Height	TT-Position	Cable Loss	Antenna Factor	Reading	Field Intensity	Limit	Margin Class B
[MHz]	H/V	[cm]	[°]	[dB]	[dB]	[dB]	[dBµV/m]	[dBµV/m]	[dB]
80.6041	V	119	153	-2.2	7.9	17.6	27.7	30.0	2.3

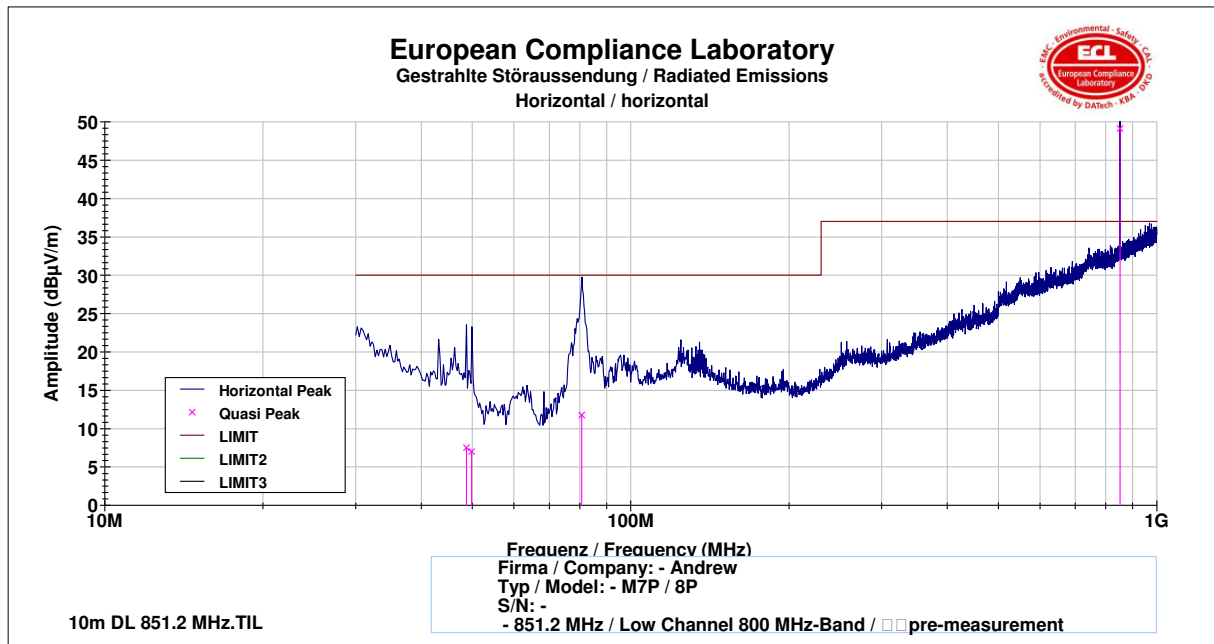

Frequency	Polarisation	Height	TT-Position	Cable Loss	Antenna Factor	Reading	Field Intensity	Limit	Margin Class B
[MHz]	H/V	[cm]	[°]	[dB]	[dB]	[dB]	[dBµV/m]	[dBµV/m]	[dB]
48.7099	H	102	134	-1.7	8.8	-3.0	7.5	30.0	22.5
49.8048	H	313	-133	-1.7	8.4	-3.2	7.0	30.0	23.0
80.6641	H	364	142	-2.2	7.9	1.7	11.8	30.0	18.2

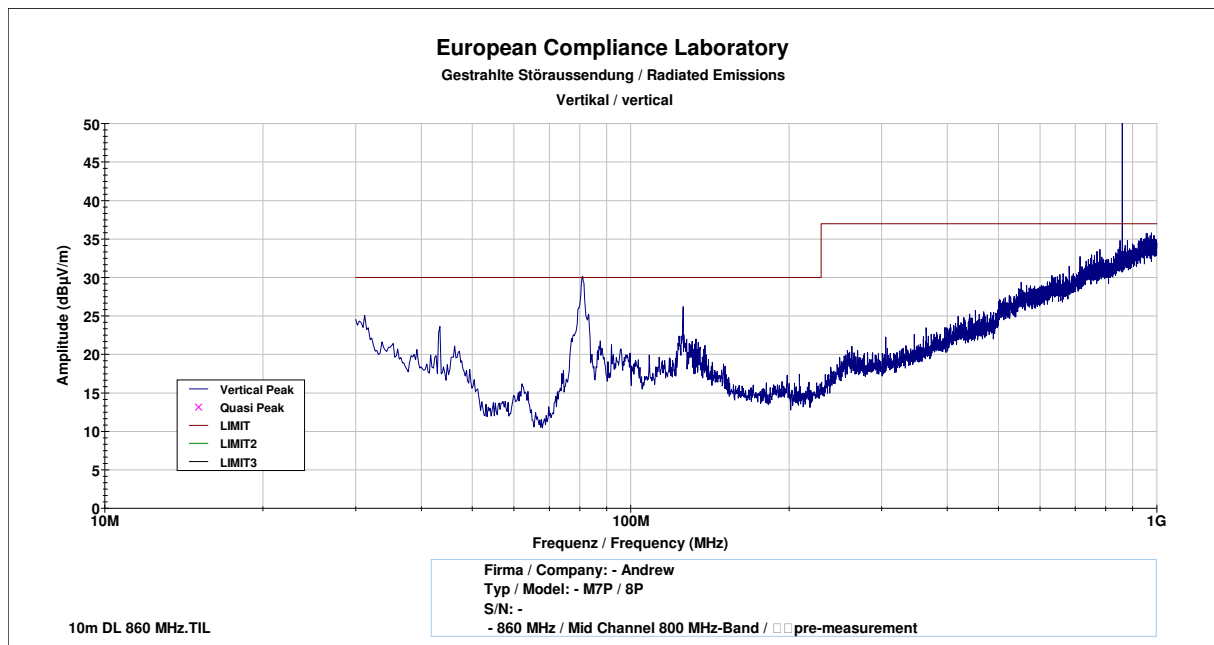

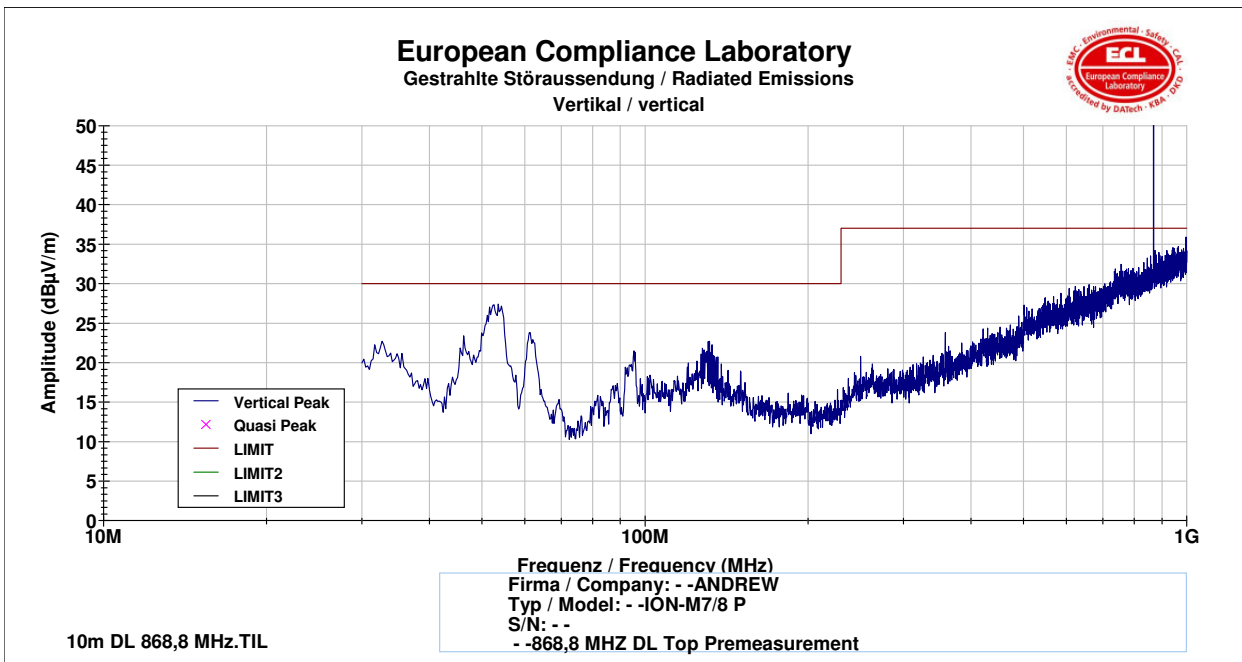
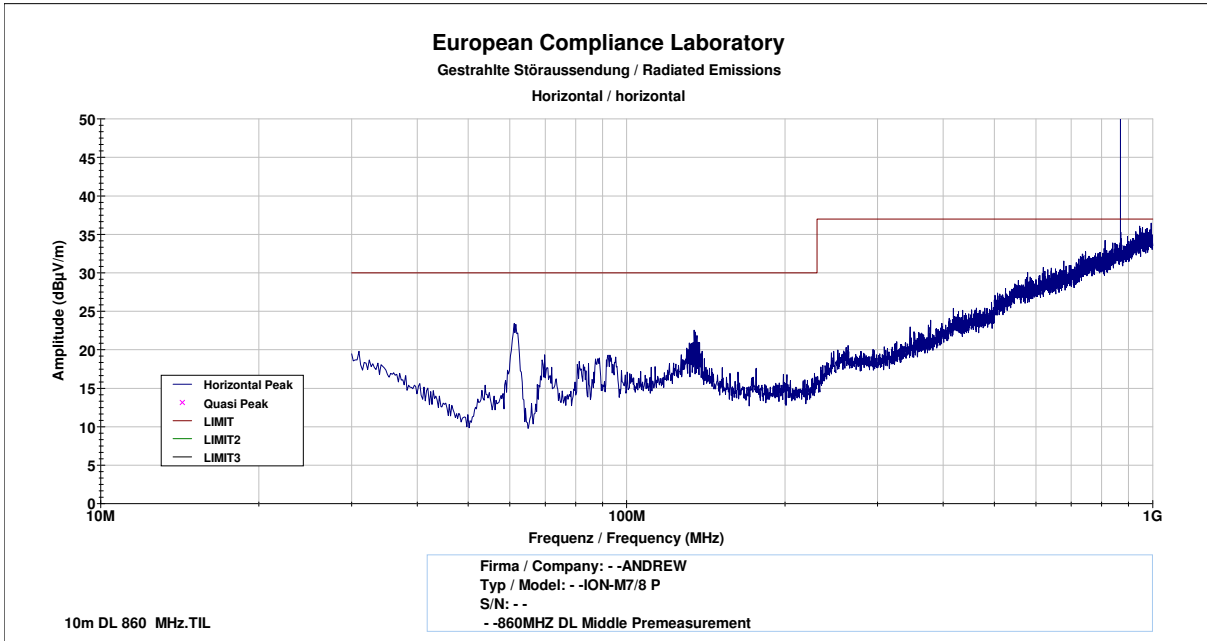

Frequency	Polarisation	Height	TT-Position	Cable Loss	Antenna Factor	Reading	Field Intensity	Limit	Margin
[MHz]	H/V	[cm]	[°]	[dB]	[dB]	[dB]	[dBµV/m]	[dBµV/m]	[dB]
53.9986	V	168	-132	-1.8	6.9	17.2	27.1	30.0	2.9
61.1022	V	353	-19	-1.9	4.4	16.0	23.8	30.0	6.2

Test Report No.: 10-062

FCC ID: XS5- ION-M7P8PS

IC ID: 2237E-IONM7P8PS

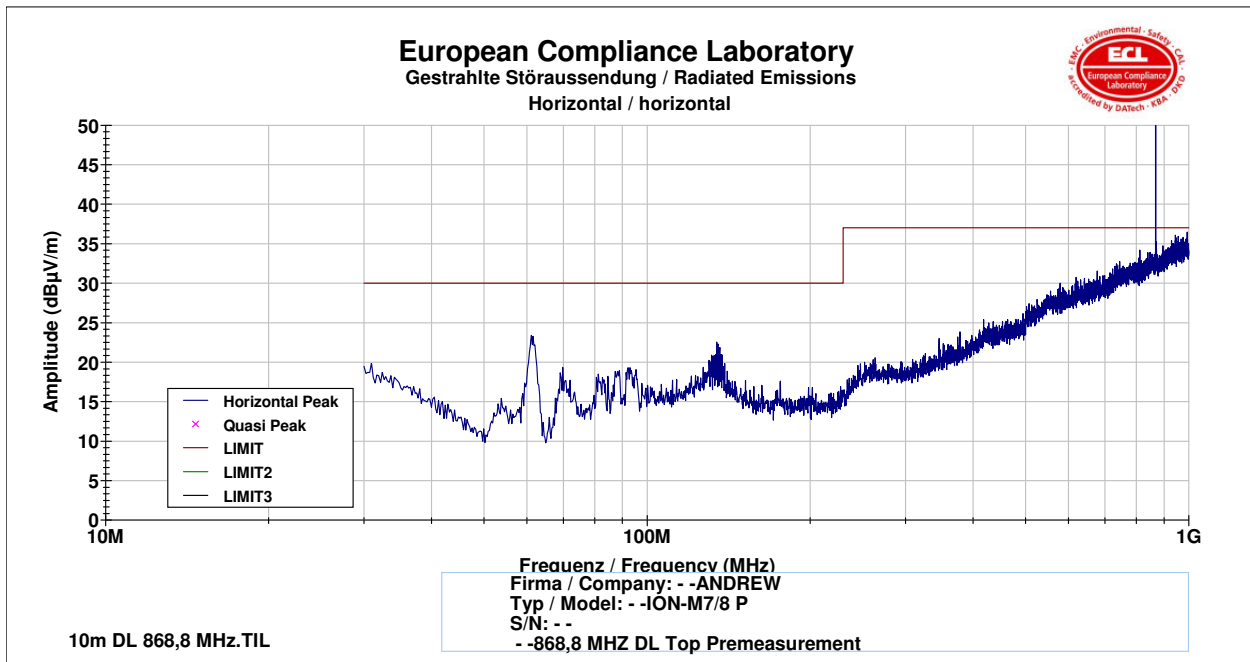

Test Report No.: 10-062

FCC ID: XS5- ION-M7P8PS

IC ID: 2237E-IONM7P8PS



8.4.1.2 1 GHz to 9 GHz Downlink (Bottom – Middle – Top)
Vertikal / Horizontal

851,2 MHz Bottom:

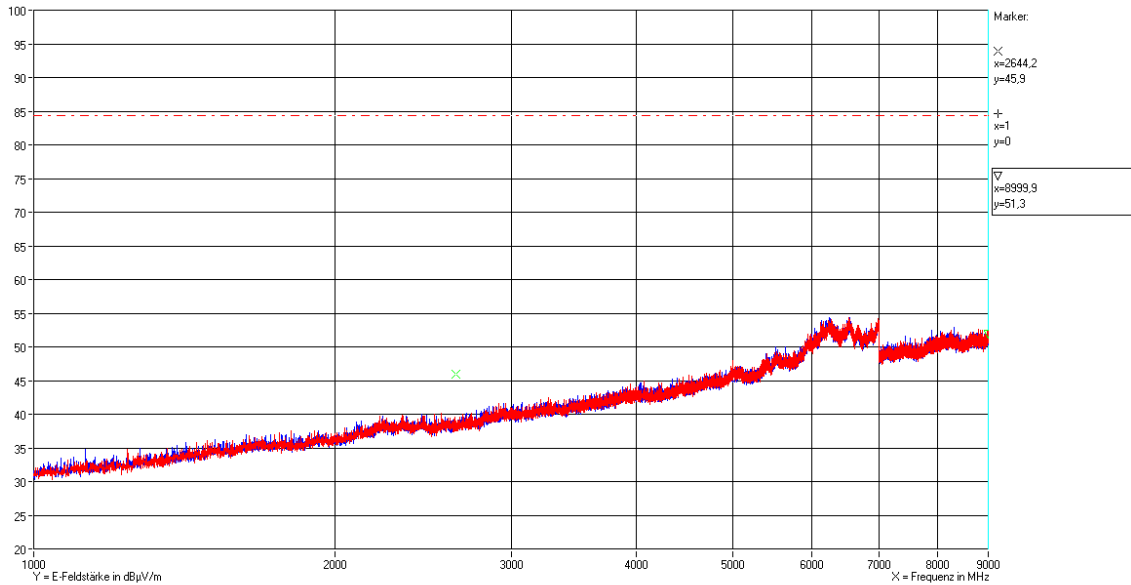

860 MHz Middle:

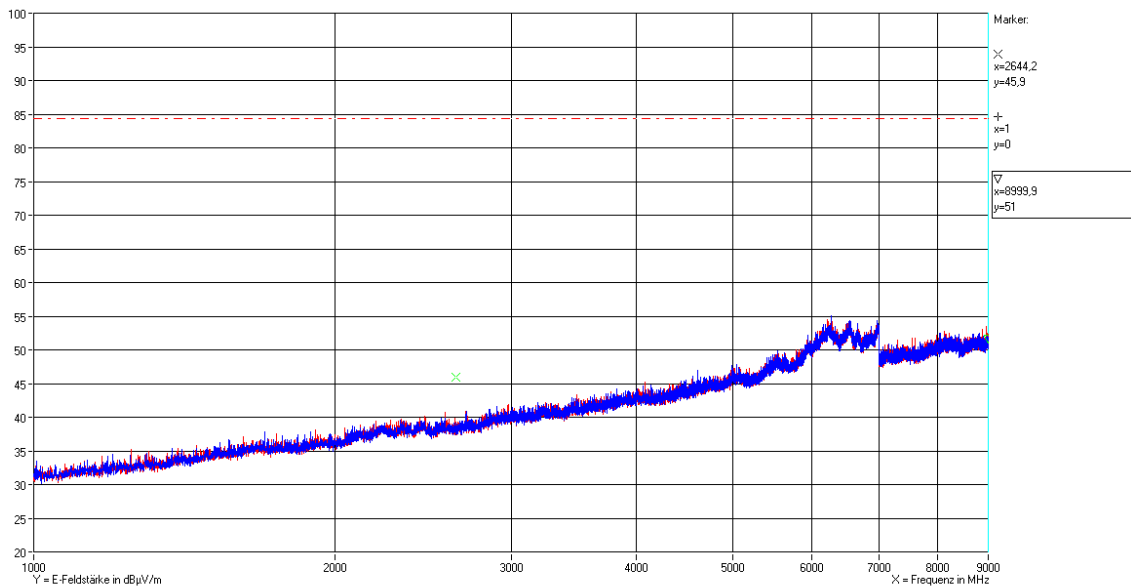

Test Report No.: 10-062

FCC ID: XS5- ION-M7P8PS

IC ID: 2237E-IONM7P8PS



868,8 MHz Top:

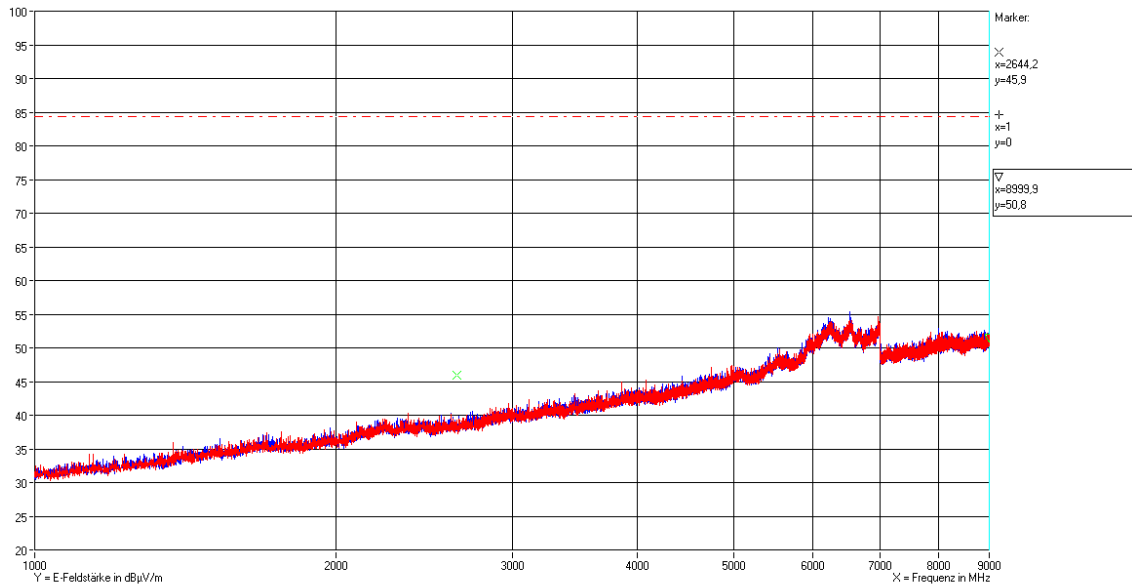

Because there were no disturbances with a significant signal to noise ratio an additional measurement has been performed at top frequency starting at 800 MHz.

Approval of the measurement chain by starting measurement at 800 MHz.

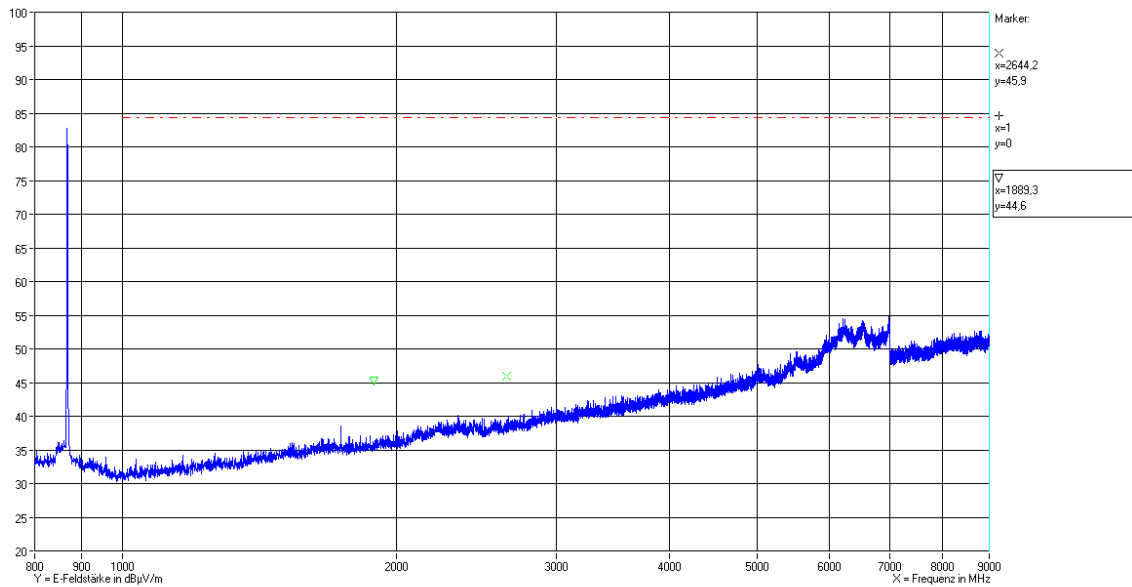

Test Report No.: 10-062

FCC ID: XS5- ION-M7P8PS

IC ID: 2237E-IONM7P8PS



8.4.2 Final measurements

8.4.2.1 30 MHz to 1 GHz Downlink (Bottom – Middle – Top)

B/M/T	Frequency	Polarisation	Height	TT	e. r. p.	Limit	Margin
	[MHz]	H/V	[cm]	Deg	dBm	dBm	[dB]
T	53.9986	V	158	-153	-56.92	-13	43.92
T	61.6512	V	212	-101	-56.32	-13	43.32
M	80.6041	V	119	-153	-59.22	-13	46.22

8.4.2.2 1 GHz to 9 GHz Downlink (Bottom – Middle – Top)

There were no disturbances with a significant signal to noise ratio!

Lehmann / 17.02.2010

The radiated spurious emission measurements have been passed!

Test Report No.: 10-062

FCC ID: XS5- ION-M7P8PS

IC ID: 2237E-IONM7P8PS



9 History

Revision	Modification	Date	Name
01.00	Initial report	24.03.2010	Lehmann

******* End of test report *******