

Test Site:
FCC Test Site No.: 96997
IC OATS No.: IC3475A-1



ECL-TAL Test Report No.: 10-279

Equipment under test: ION-M19P/19HP Block C
FCC ID: XS5-ION-M19P19HP

Type of test: FCC 47 CFR Part 24 Subpart E
Broadband PCS

Measurement Procedures: 47 CFR Parts 2 (*Frequency Allocations and Radio Treaty Matters; General Rules and Regulations*),
24 E (Broadband PCS),
ANSI/TIA-603-C (2004),

Test result: Passed

Date of issue:	11.11.2010			Signature:
Issue-No.:	01	Author:	G. Weinfurtnner Test engineer	
Date of delivery:	02.11.10	Checked:	M. Lehmann Head of the EMC Lab	
Test dates:	02.11.10			



Manufacturer: ANDREW Wireless Systems GmbH
Industriering 10

D-86675 Buchdorf

Tel.: +49 (0)9099 69 0

Fax: +49 (0)9099 69 140

Test Location: HERBERG Service Plus GmbH
European Compliance Laboratory (ECL)

Thurn-und Taxis-Straße 18

D-90411 Nürnberg

Tel.: +49 0911 59835 923

Fax: +49 0911 59835 90

General:

The purpose of this report is to show compliance to the FCC regulations for licensed devices operating under section 24 E of the Code of Federal Regulations title 47.

This report informs about the results of the EMC tests, it only refers to the equipment under test. No part of this report may be reproduced in any form, without written permission.



Table of contents

1	TEST RESULTS SUMMARY	5
2	EQUIPMENT UNDER TEST (E.U.T.)	6
2.1	DESCRIPTION	6
2.1.1	DOWNLINK	6
2.1.2	UPLINK	6
2.1.3	DESCRIPTION OF EUT	6
2.1.4	SYSTEM DIAGRAM OF EUT	7
2.1.5	BLOCK DIAGRAM OF MEASUREMENT REFERENCE POINTS	8
3	TEST SITE (ANDREW BUCHDORF)	9
3.1	TEST ENVIRONMENT	9
3.2	TEST EQUIPMENT	9
3.3	INPUT AND OUTPUT LOSSES	9
3.4	MEASUREMENT UNCERTAINTY	9
4	TEST SITE (TEMPTON SERVICE PLUS GMBH)	10
5	RF POWER OUT: §24.232, §2.1046	11
5.1	LIMIT	11
5.2	TEST METHOD	11
5.3	TEST RESULTS	12
5.3.1	DOWNLINK	13
5.3.1.1	GSM	14
5.3.1.2	GSM EDGE	14
5.3.1.3	CDMA	15
5.3.1.4	W-CDMA	15
5.3.1.5	LTE	16
5.3.2	UPLINK	16
5.4	SUMMARY TEST RESULT	16
6	OCCUPIED BANDWIDTH: §2.1049	17
6.1	LIMIT	17
6.2	TEST METHOD	17
6.3	TEST RESULTS	17
6.3.1	DOWNLINK	17
6.3.1.1	GSM	19
6.3.1.2	GSM EDGE	20
6.3.1.3	CDMA	21
6.3.1.4	W-CDMA	22
6.3.1.5	LTE	23
6.3.2	UPLINK	24
6.4	SUMMARY TEST RESULT	24
7	SPURIOUS EMISSIONS AT ANTENNA TERMINALS: §24.238, §2.1051	25
7.1	LIMIT	25



7.2	TEST METHOD	25
7.3	TEST RESULTS	25
7.3.1	DOWNLINK	25
7.3.1.1	GSM < 1MHz to band edge	27
7.3.1.2	GSM EDGE < 1MHz to band edge	28
7.3.1.3	CDMA < 1MHz to band edge	29
7.3.1.4	W-CDMA < 1MHz to band edge	30
7.3.1.5	LTE < 1MHz to band edge	31
7.3.1.6	GSM > 1MHz to band edge	32
7.3.1.7	GSM EDGE > 1MHz to band edge	32
7.3.1.8	CDMA > 1MHz to band edge	33
7.3.1.9	W-CDMA > 1MHz to band edge	33
7.3.1.10	LTE > 1MHz to band edge	34
7.3.2	UPLINK	34
7.4	SUMMARY TEST RESULT	34
8	FIELD STRENGTH OF SPURIOUS EMISSIONS: §24.53, §2.1053	35
8.1	LIMIT §24.238	38
8.2	TEST METHOD ANSI/TIA/EA-603-C	39
8.3	CLIMATIC VALUES IN THE LAB	39
8.4	TEST RESULTS	40
8.4.1	30 MHz TO 22 GHz DOWNLINK (BOTTOM – MIDDLE – TOP)	40
8.5	SUMMARY TEST RESULT	41
9	HISTORY	42

1 Test Results Summary

Name of Test	FCC Para. No.	FCC Method	FCC Spec.	Result
RF Power Output	24.232(a)	2.1046(a)	160 Watts	Complies
Occupied Bandwidth		2.1049(h)	Input/Output	Complies
Spurious Emissions at Antenna Terminals	24.238(a)	2.1051	-13dBm	Complies
Field Strength of Spurious Emissions	24.238(a)	2.1053	-13dBm E.I.R.P	Complies
Frequency Stability		2.1055(a)(d)	Must stay in band	NA

Frequency stability is not applicable because the device uses a common oscillator to up convert and down convert the RF signal. The EUT does not contain modulation circuitry, or frequency generation, therefore the test was not performed.

2 Equipment under test (E.U.T.)

2.1 Description

Kind of equipment	ION-M19P/19HP	
Andrew Ident. Number	7563447-0001	
Serial no.(SN)	11	
Revision	00	
Software version and ID	V3.19.0	Id.No. 7162793
Type of modulation and Designator	GSM (GXW)	<input checked="" type="checkbox"/>
	GSM EDGE (G7W)	<input checked="" type="checkbox"/>
	CDMA (F9W)	<input checked="" type="checkbox"/>
	W-CDMA (F9W)	<input checked="" type="checkbox"/>
	LTE QAM (D7D)	<input checked="" type="checkbox"/>
Frequency Translation	F1-F1	<input checked="" type="checkbox"/>
	F1-F2	<input type="checkbox"/>
	N/A	<input type="checkbox"/>
Band Selection	Software	<input type="checkbox"/>
	Duplexer	<input checked="" type="checkbox"/>
	Full band	<input type="checkbox"/>

2.1.1 Downlink

Pass band	1975 MHz – 1990 MHz
Maximum rated output power	43 dBm =20W
Gain max.	10 dB @ Pout BTS of 33 dBm

2.1.2 Uplink

Pass band	1895 MHz – 1910 MHz
Maximum rated output power	n.a.
Gain max.	n.a.

Note: The EUT does not transmit over the air in the uplink direction.

2.1.3 Description of EUT

Andrew ION-Mx is a multi-band, multi-operator remote unit with various extension units. It is used in conjunction with a master unit in the ION optical distribution system.

This Test Report describes only the approval of the frequency block C (ION-M19P).

The ION-M19P/19HP Repeater consists of tow 1900 MHz path, can amplify and transmit in frequency block A and block C, with the intended use of simultaneous transmission.

2.1.4 System diagram of EUT

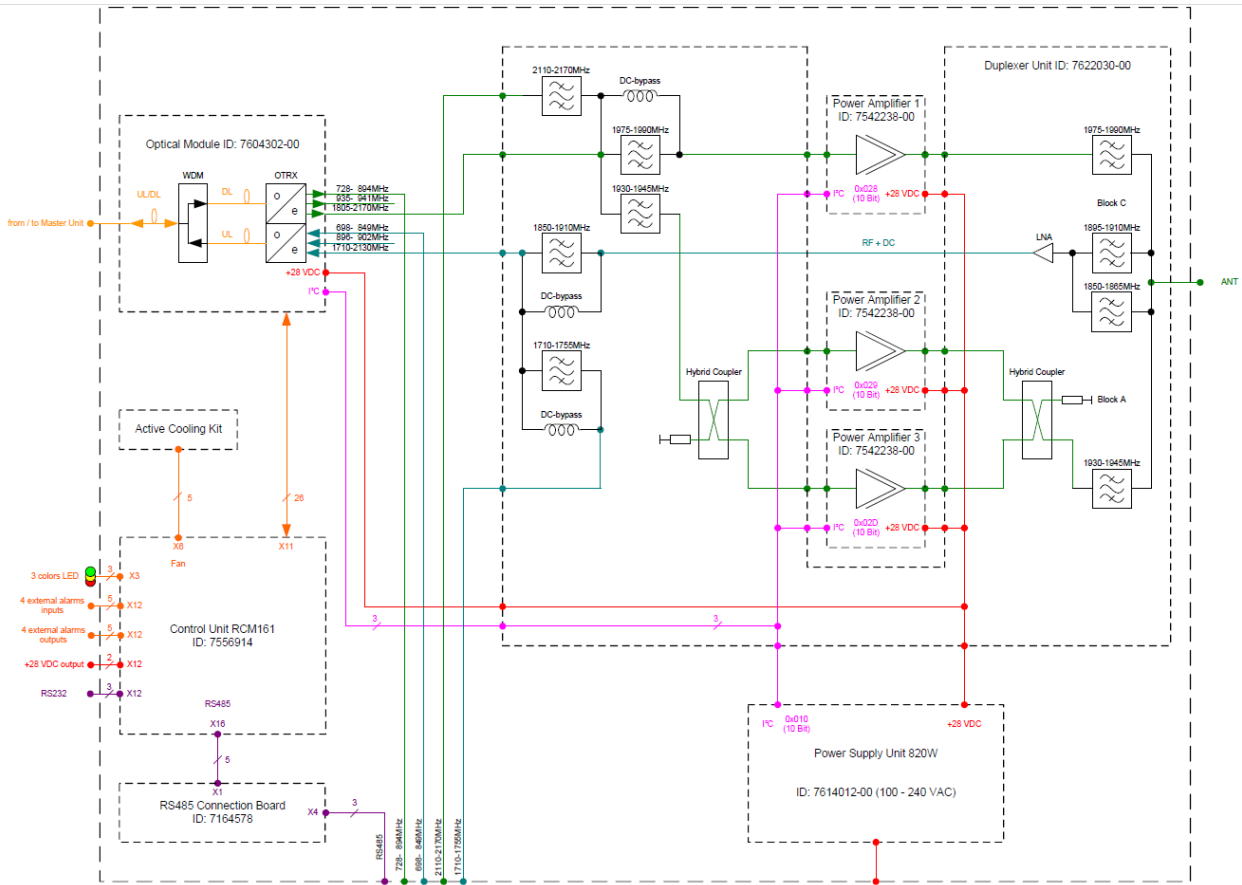

figure 2.1.4-#1 System diagram of EUT: ION optical distribution system

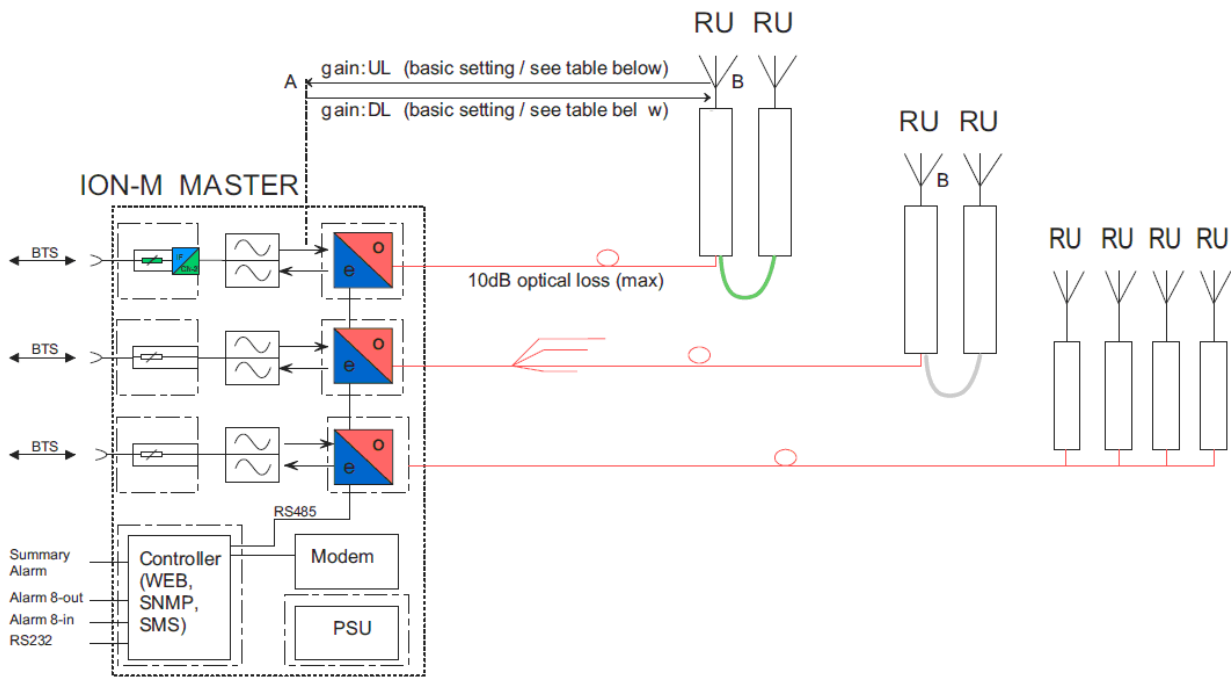

figure 2.1.4-#2 System diagram of EUT: EUT is Remote Unit

2.1.5 Block diagram of measurement reference points

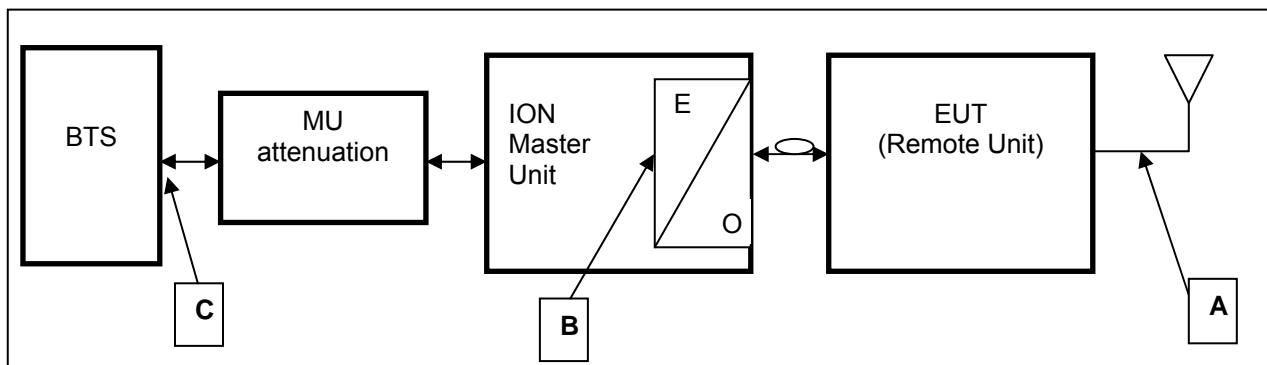

figure 2.1.5-#1 Block diagram of measurement reference points

Remote Unit is the EUT

O/E Optical / Electrical converter

SRMU Sub Rack Master Unit

Reference point A, Remote Unit DL output, UL input

Reference point B, SRMU UL output, DL input

Reference point C, BTS DL output, BTS UL input

3 Test site (Andrew Buchdorf)

3.1 Test environment

All tests were performed under the following environmental conditions:

Condition	Minimum value	Maximum value
Barometric pressure	86 kPa	106 kPa
Temperature	15°C	30°C
Relative Humidity	20 %	75 %
Power supply range	±5% of rated voltages	

3.2 Test equipment

ANDREW Inv. No.	Test equipment	Type	Manufacturer	Serial No.	Calibration
8917	Network Analyzer	ZVCE8	R&S	827712/009	12/10
9054	Spectrum Analyzer	FSV13	R&S	100859	01/11
8798	Spectrum Analyzer	FSQ-26	R&S	100340	03/11
8877	Signal Generator	E4438C	Agilent	MY42082954	01/11
8990	Signal Generator	SMJ100A	R&S	101288	07/11
9052	Signal Generator	SMBV100A	R&S	255089	01/11
8671	Power Meter	E4418B	Agilent	GB39513094	06/11
8672	Power Sensor	E9300H	Agilent	US41090179	06/11
7280	Power Attenuator	768-30	Narda	---	CIU
7403	Divider	2way	Mikom	4148	CIU
7397	RF-Cable	0.5m; SMA	Huber & Suhner	40226/4P	CIU
7398	RF-Cable	0.5m; SMA	Huber & Suhner	40227/4P	CIU
7399	RF-Cable	1m; SMA	Huber & Suhner	40444/4P	CIU
7400	RF-Cable	1m; SMA	Huber & Suhner	40445/4P	CIU
7401	RF-Cable	2m; SMA	Huber & Suhner	40189/4P	CIU
7402	RF-Cable	2m; SMA	Huber & Suhner	40187/4P	CIU
7363	RF-Cable	2,0m; N-N	Huber & Suhner	28439/4PEA	CIU
7295	RF-Cable	2,5m; N-N	Huber & Suhner	28964/4PEA	CIU
7299	RF-Cable	2,5m; N-N	Huber & Suhner	28964/4PEA	CIU
7364	RF-Cable	1,0m; SMA	Huber & Suhner	36309/4P	CIU
7365	RF-Cable	1,0m; SMA	Huber & Suhner	36292/4P	CIU
7366	RF-Cable	2,0m; SMA	Huber & Suhner	36183/4P	CIU
7367	RF-Cable	2,0m; SMA	Huber & Suhner	36158/4P	CIU
7368	Matrix	Extended Version	Andrew	---	monthly

CIU = Calibrate in use

3.3 Input and output losses

All recorded power levels should be referenced to the input and output connectors of the repeater, unless explicitly stated otherwise.

The test equipment used in this test has to be calibrated, so that the functionality is also checked.

All cables, attenuators, splitter, isolator, circulator and combiner etc. must be measured before testing and used for compensation during testing.

3.4 Measurement uncertainty

The extended measurement uncertainty corresponds to the measurement results from the standard measurement uncertainty multiplied by the coverage factor $k=2$. The true value is located in the corresponding interval with a probability of 95 %.

EMC Test Report No.: 10-279

FCC ID: XS5-ION-M19P19HP



4 Test site (TEMPTON Service Plus GmbH)

FCC Test site:

IC OATS:

See relevant dates under section 8.

5 RF Power Out: §24.232, §2.1046

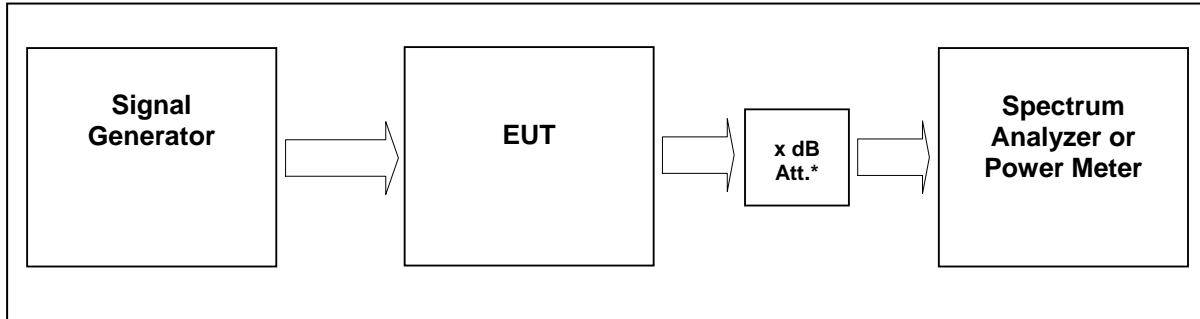

External Attenuator DL x dB = 30 dB
 figure 5-#1 Test setup: RF Power Out: §24.232, §2.1046

Measurement uncertainty	± 0,38 dB
Test equipment used	9054, 7399, 7280, 7299, 7401, 7367, 9052, 8990, 8877

5.1 Limit

Minimum standard:

Para. No.24.232(a)

a) Base stations are limited to 1640 watts peak equivalent isotropically radiated power (EIRP) with an antenna height up to 300 meters HAAT, except as described in paragraph (b) below. See §24.53 for HAAT calculation method. Base station antenna heights may exceed 300 meters with a corresponding reduction in power; see Table 1 of this section. The service area boundary limit and microwave protection criteria specified in §§24.236 and 24.237 apply.

Table 1—Reduced Power for Base Station Antenna Heights Over 300 Meters

HAAT in meters	Maximum EIRP watts
≤ 300	1640
≤ 500	1070
≤ 1000	490
≤ 1500	270
≤ 2000	160

5.2 Test method

§ 2.1046 Measurements required: RF power output.

(a) For transmitters other than single sideband, independent sideband and controlled carrier radiotelephone, power output shall be measured at the RF output terminals when the transmitter is adjusted in accordance with the tune-up procedure to give the values of current and voltage on the circuit circuit elements specified in § 2.1033(c)(8). The electrical characteristics of the radio frequency load attached to the output terminals when this test is made shall be stated.

(c) For measurements conducted pursuant to paragraphs (a) and (b) of this section, all calculations and methods used by the applicant for determining carrier power or peak envelope power, as appropriate, on the basis of measured power in the radio frequency load attached to the transmitter output terminals shall be shown. Under the test conditions specified, no components of the emission spectrum shall exceed the limits specified in the applicable rule parts as necessary for meeting occupied bandwidth or emission limitations



5.3 Test results

Detector RMS.

Test signal GSM:

Signal waveform with GMSK modulation in all time slots according to 3GPP TS45.004

Test signal GSM EDGE:

Signal waveform with 8-PSK modulation in all time slots according to 3GPP TS45.004

Test signal CDMA

Signal waveform according to table 6.2-1 of standard specification 3GPP2 C.p0051-0 v1.0 16.February 2006 pilot, sync, paging, 37 traffics, which is equal to the table 6.5.2.1 of 3GPP2 C.S0010-C v2.0 24.February 2006.

Test signal WCDMA

Signal waveform according to Test Model 1 of standard specification 3GPP TS25.141. Signal modulated with a combination of PCCPCH, SCCPCH and Dedicated Physical Channels specified as test model 1 64 DPCH.

Test signal LTE:

Signal waveform according to E-TM 3.1 widest possible bandwidth of standard specification 3GPP TS36.141

5.3.1 Downlink

Modulation	RBW VBW Span	Measured at f / (MHz)		RF Power (dBm)	RF Power (W)	Plot
GSM	1 MHz 3 MHz 10 MHz	Middle	1982,5	43,0	20	5.3.1.1
						#1
GSM EDGE	1 MHz 3 MHz 10 MHz	Middle	1982,5	43,0	20	5.3.1.2
						#1
CDMA	3 MHz 10 MHz 15 MHz	Middle	1982,5	43,0	20	5.3.1.3
						#1
WCDMA	10 MHz 10 MHz 50 MHz	Middle	1982,5	43,0	20	5.3.1.4
						#1
LTE	3 MHz 10 MHz 15 MHz	Middle	1982,5	43,0	20	5.3.1.5
						#1
Maximum output power = 43,04 dBm = 20,14 W						
Limit Maximum output power = 52 dBm = 160 W						

table 5.3.1-#1 RF Power Out: §24.232, §2.1046; Test results; Downlink

Modulation	Pin / dBm (Ref. point B)
GSM	1,5
EDGE	1,5
CDMA	1,5
WCDMA	1,7
LTE	1,9

table 5.3.1-#2 RF Power Out: §24.232, §2.1046; Test results; Downlink; Input power



5.3.1.1 GSM

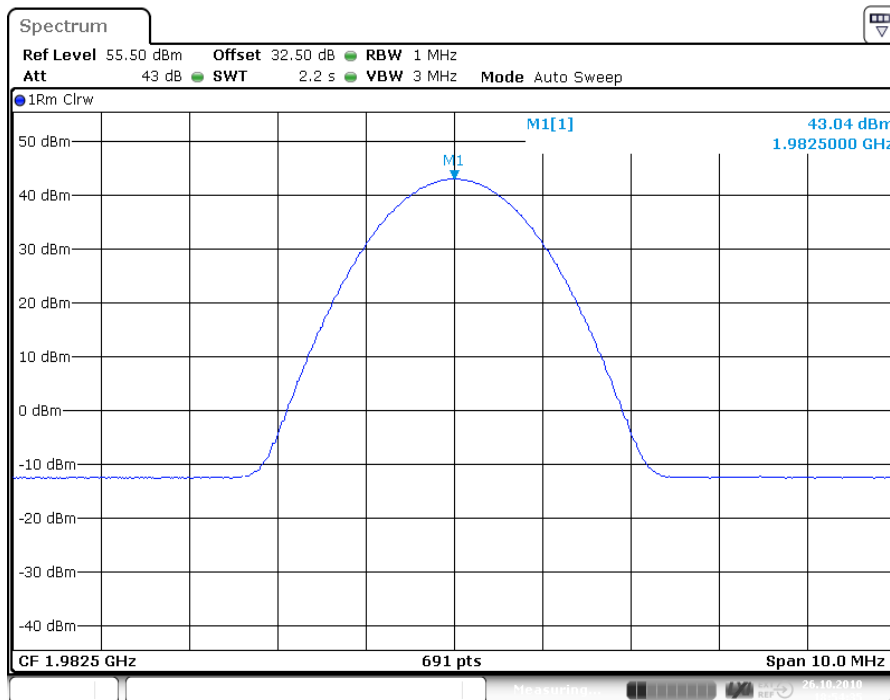

Date: 26.OCT.2010 18:54:36

plot 5.3.1.1-#1 RF Power Out: §24.232, §2.1046; Test results; Downlink; GSM Middle

5.3.1.2 GSM EDGE

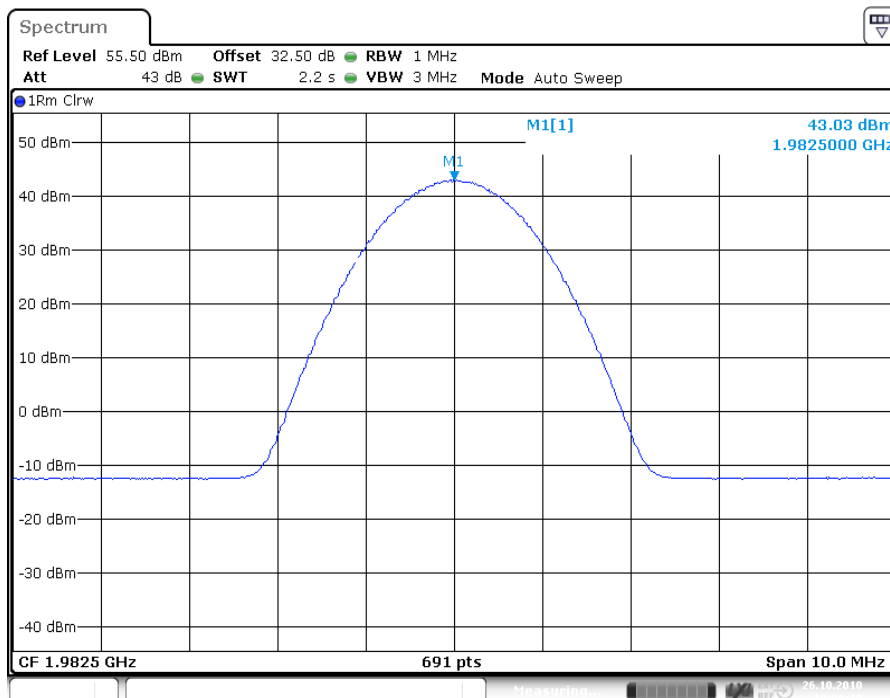

Date: 26.OCT.2010 19:09:19

plot 5.3.1.2-#1 RF Power Out: §24.232, §2.1046; Test results; Downlink; GSM EDGE Middle



5.3.1.3 CDMA

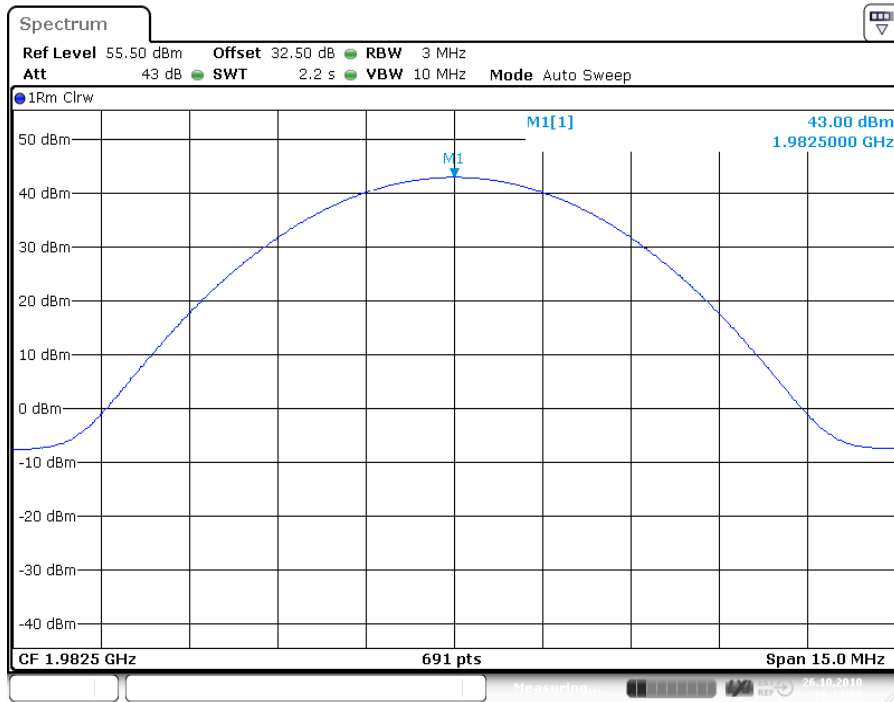

Date: 26.OCT.2010 19:14:29

plot 5.3.1.3-#1 RF Power Out: §24.232, §2.1046; Test results; Downlink; CDMA Middle

5.3.1.4 W-CDMA

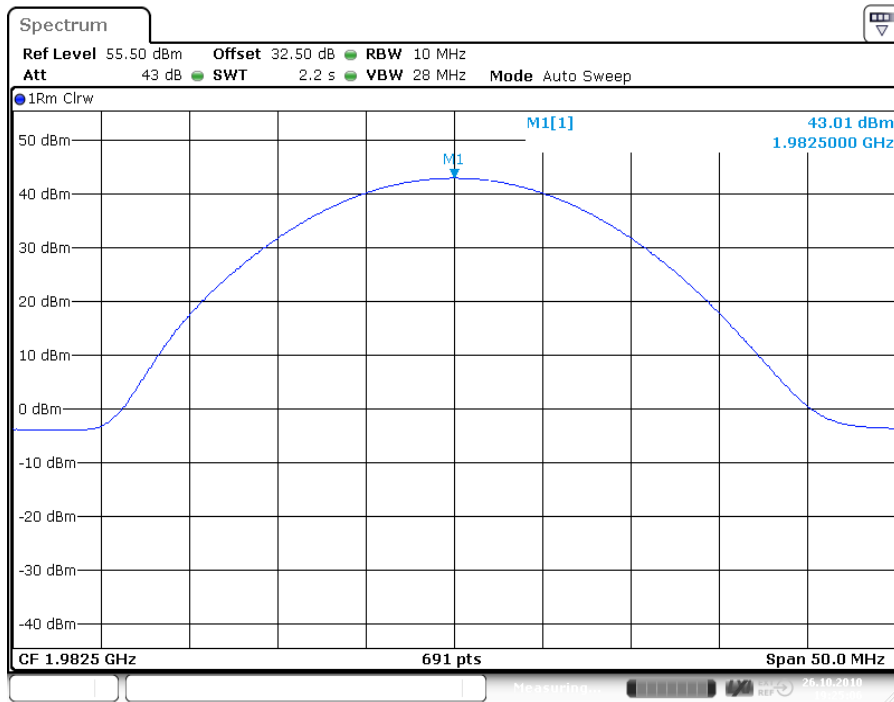

Date: 26.OCT.2010 19:25:07

plot 5.3.1.4-#1 RF Power Out: §24.232, §2.1046; Test results; Downlink; W-CDMA Middle



5.3.1.5 LTE

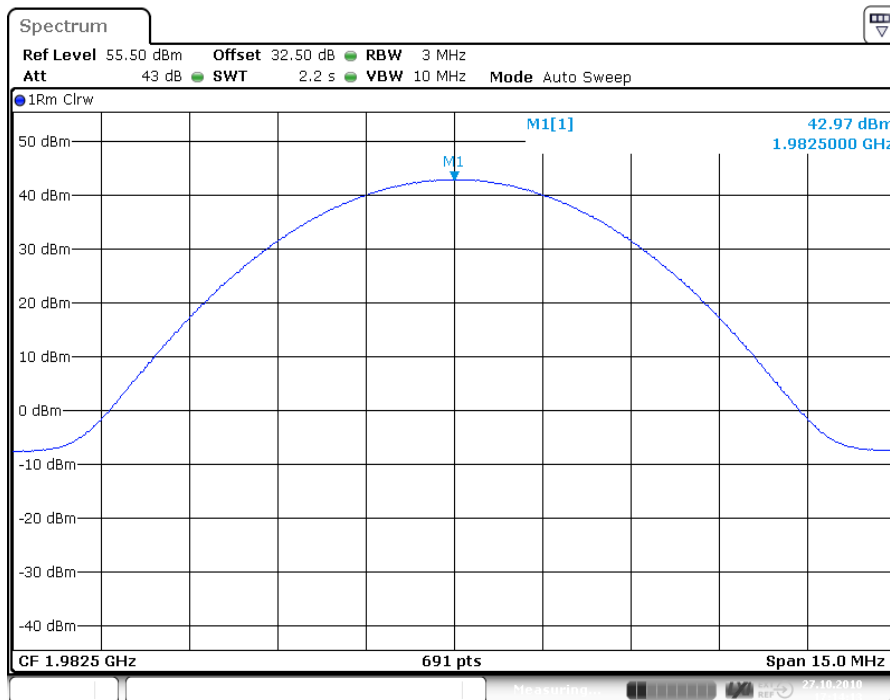

plot 5.3.1.5-#1 RF Power Out: §24.232, §2.1046; Test results; Downlink; LTE Middle

5.3.2 Uplink

n.a.

Note: The EUT does not transmit over the air in the uplink direction.

5.4 Summary test result

Test result	complies, according the plots above
Tested by:	Michael Leinfelder
Date:	27.10.2010

6 Occupied Bandwidth: §2.1049

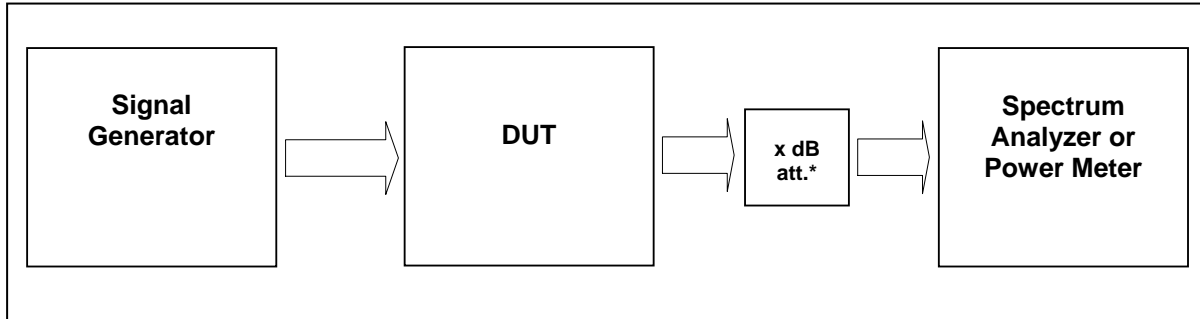

External Attenuator DL x dB = 30 dB
figure 6-#1 Test setup: Occupied Bandwidth: §2.1049

Measurement uncertainty	± 0,38 dB
Test equipment used	9054, 7399, 7280, 7299, 7401, 7367, 9052, 8990, 8877

6.1 Limit

The spectral shape of the output should look similar to input for all modulations.

6.2 Test method

Para. No.2.1049

The occupied bandwidth, that is the frequency bandwidth such that, below its lower and above its upper frequency limits, the mean powers radiated are each equal to 0.5 percent of the total mean power radiated by a given emission shall be measured under the following conditions as applicable:

(h) Transmitters employing digital modulation techniques—when modulated by an input signal such that its amplitude and symbol rate represent the maximum rated conditions under which the equipment will be operated. The signal shall be applied through any filter networks, pseudo-random generators or other devices required in normal service. Additionally, the occupied bandwidth shall be shown for operation with any devices used for modifying the spectrum when such devices are optional at the discretion of the user.

6.3 Test results

For composite power measurements: Detector RMS.

6.3.1 Downlink

Modulation	Measured at f / MHz		RBW VBW Span	Occupied Bandwidth / MHz	Plot
GSM	Middle	1982,5	3 kHz 30 kHz 1 MHz	0,243	6.3.1.1
					#1, #2
GSM EDGE	Middle	1982,5	3 kHz 30 kHz 1 MHz	0,246	6.3.1.2
					#1, #2



CDMA	Middle	1982,5	30kHz 300kHz 5 MHz	1,259	6.3.1.3
					#1, #2
WCDMA	Middle	1982,5	100kHz 1 MHz 10 MHz	4,182	6.3.1.4
					#1, #2
LTE	Middle	1982,5	30kHz 300kHz 5 MHz	1,1	6.3.1.5
					#1, #2

table 6.3-#1 Occupied Bandwidth: §2.1049 Test results



6.3.1.1 GSM

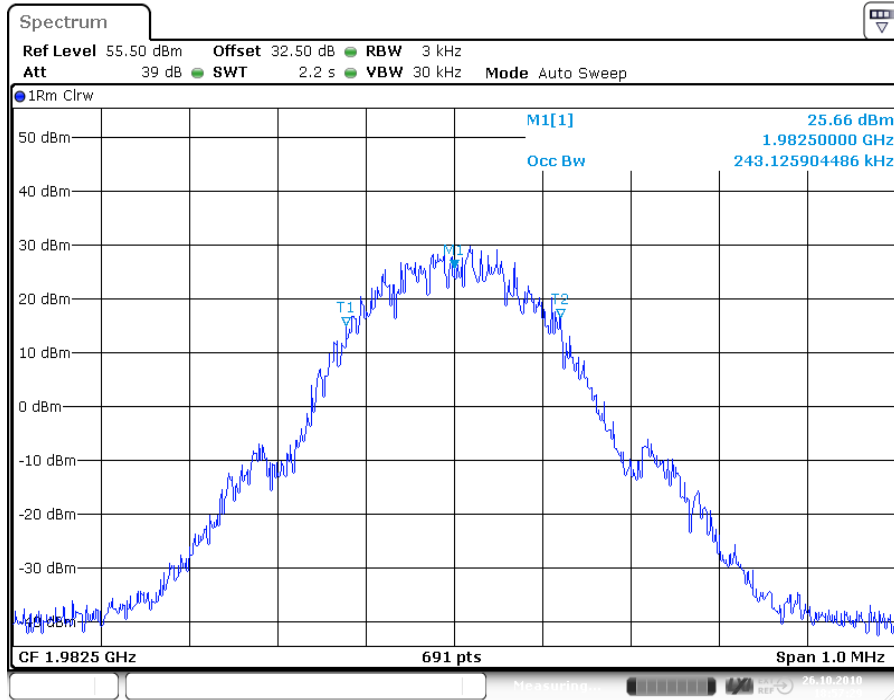

plot 6.3.1.1-#1 Occupied Bandwidth: \$2.1049; Test results; Downlink; GSM Output; Middle

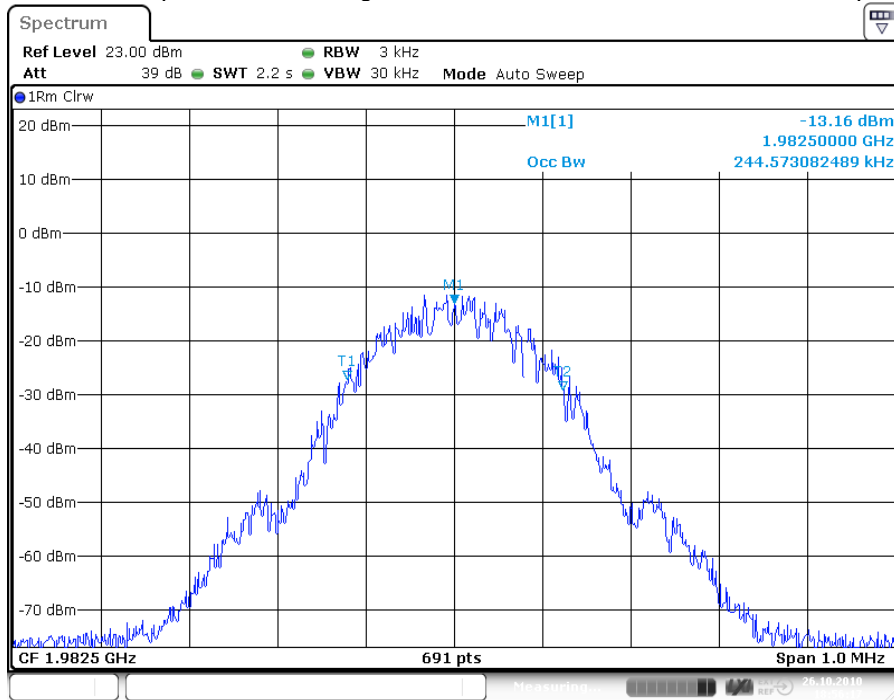

plot 6.3.1.1-#2 Occupied Bandwidth: \$2.1049; Test results; Downlink; GSM Input; Middle



6.3.1.2 GSM EDGE

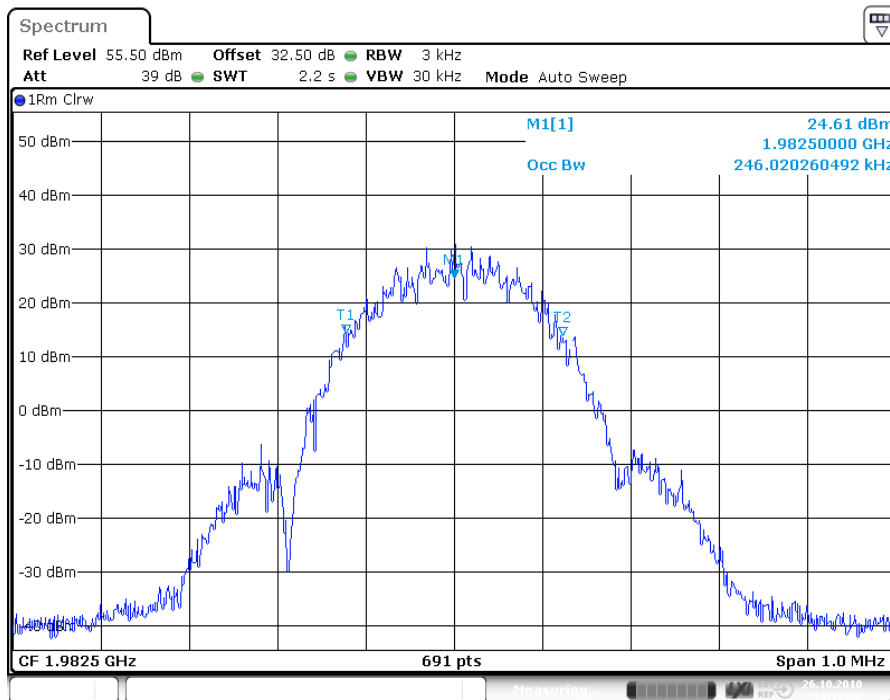

Date: 26.OCT.2010 19:12:36

plot 6.3.1.2-#1 Occupied Bandwidth: §2.1049; Test results; Downlink; GSM EDGE Output; Middle

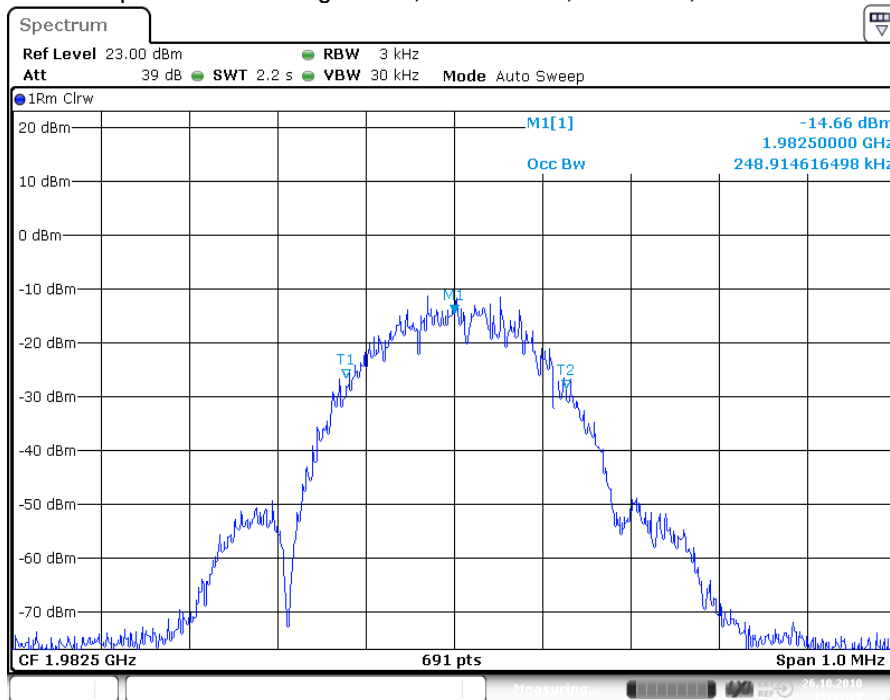

Date: 26.OCT.2010 19:11:20

plot 6.3.1.2-#2 Occupied Bandwidth: §2.1049; Test results; Downlink; GSM EDGE Input; Middle



6.3.1.3 CDMA

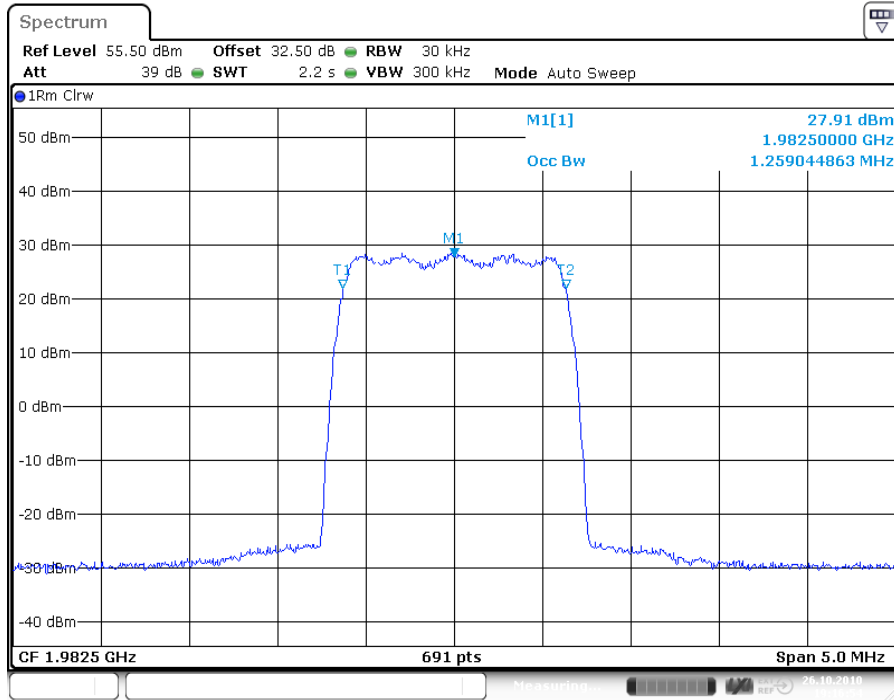

plot 6.3.1.3-#1 Occupied Bandwidth: \$2.1049; Test results; Downlink; CDMA Output; Middle

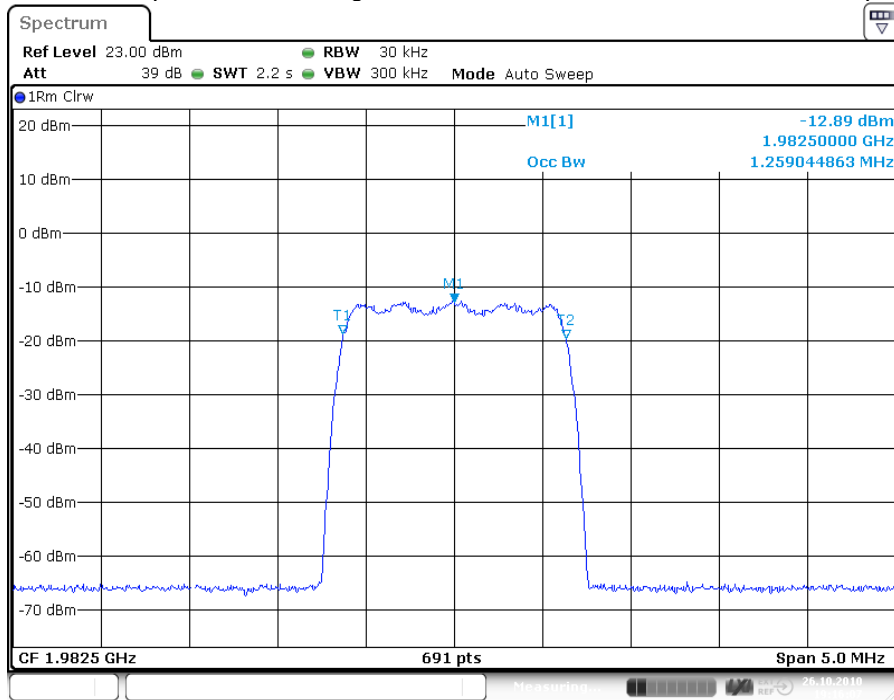

plot 6.3.1.3-#2 Occupied Bandwidth: \$2.1049; Test results; Downlink; CDMA Input; Middle



6.3.1.4 W-CDMA

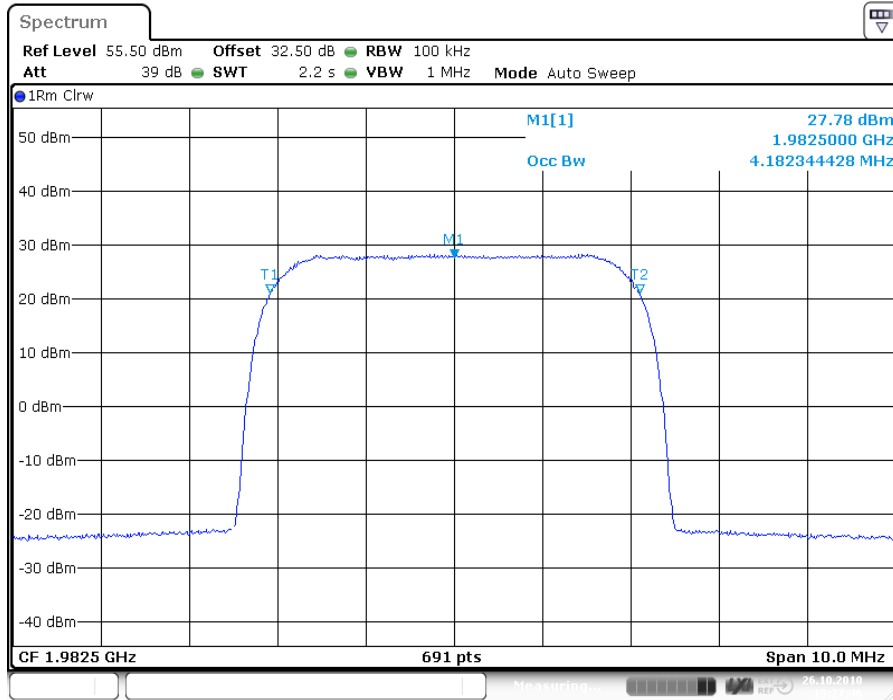

Date: 26.OCT.2010 19:27:46

plot 6.3.1.4-#1 Occupied Bandwidth: \$2.1049; Test results; Downlink; W-CDMA Output; Middle

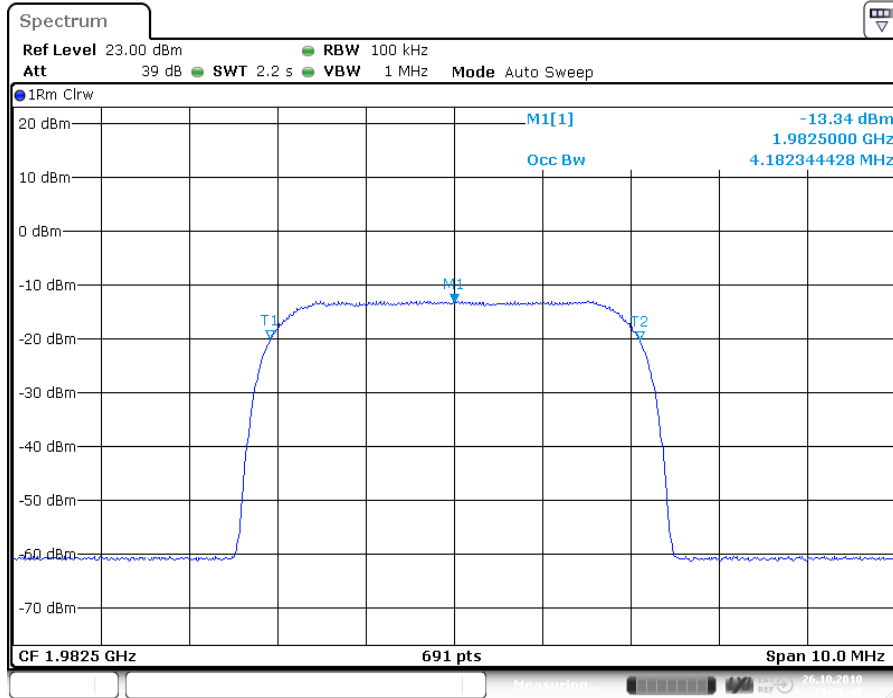

Date: 26.OCT.2010 19:26:40

plot 6.3.1.4-#2 Occupied Bandwidth: \$2.1049; Test results; Downlink; W-CDMA Input; Middle



6.3.1.5 LTE

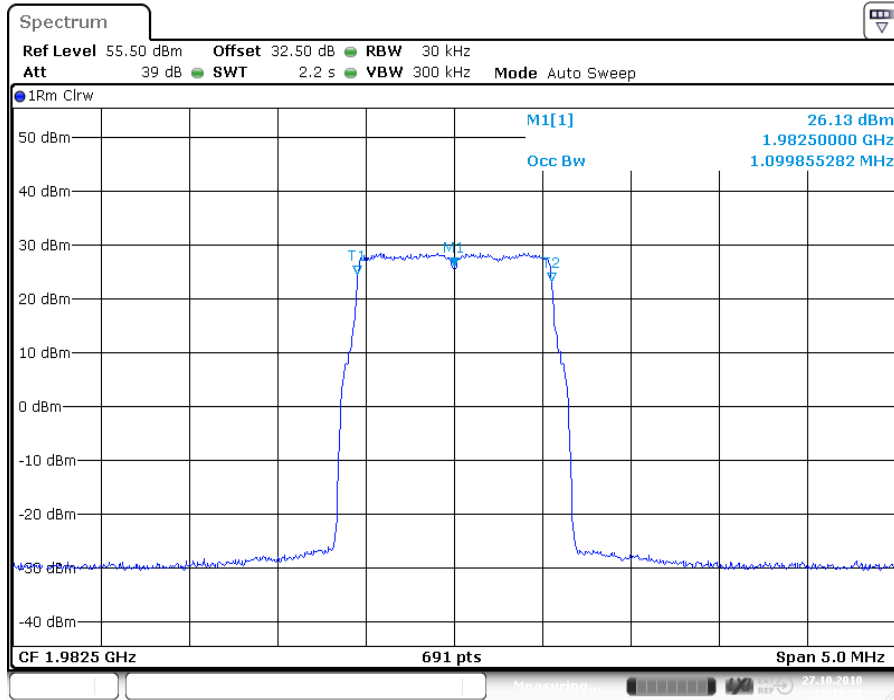

Date: 27.OCT.2010 17:17:30

plot 6.3.1.5-#1 Occupied Bandwidth: \$2.1049; Test results; Downlink; LTE Output; Middle

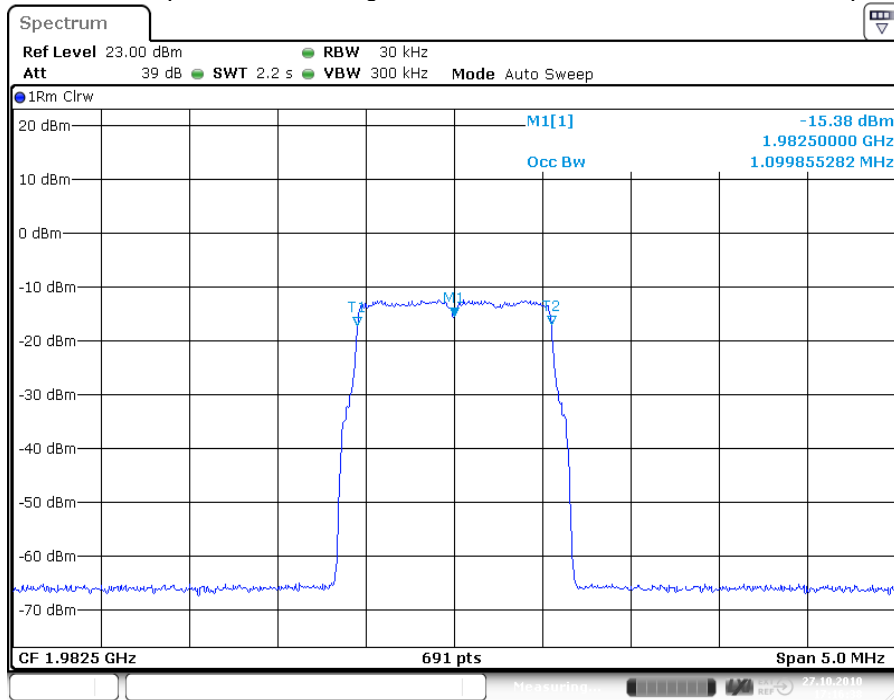

Date: 27.OCT.2010 17:16:38

plot 6.3.1.5-#2 Occupied Bandwidth: \$2.1049; Test results; Downlink; LTE Input; Middle



6.3.2 Uplink

n.a.

Note: The EUT does not transmit over the air in the uplink direction.

6.4 Summary test result

Test result	complies, according the plots above
Tested by:	Michael Leinfelder
Date:	27.10.2010

7 Spurious Emissions at Antenna Terminals: §24.238, §2.1051

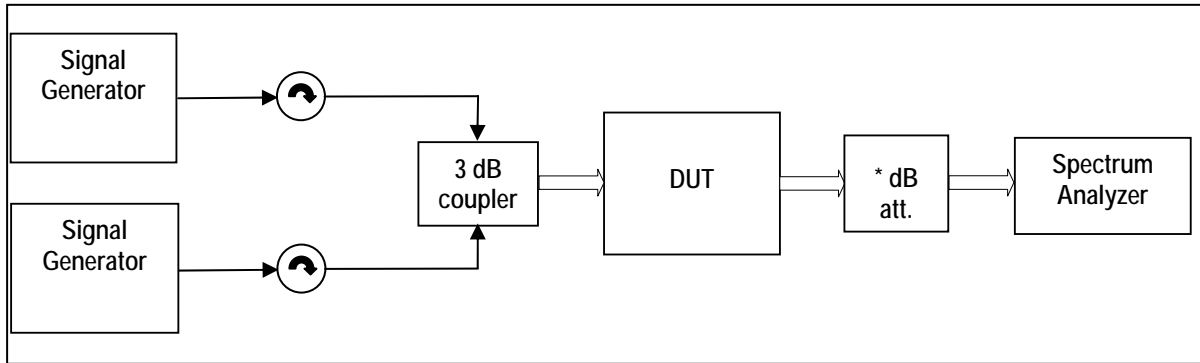

External Attenuator DL x dB = 30 dB

figure 7-#1 Test setup: Spurious Emissions at Antenna Terminals: §24.238, §2.1051

Measurement uncertainty	± 0,43 dB ± 0,95 dB ± 1,2 dB	9 kHz to 3 GHz 3 GHz to 7 GHz 7 GHz to 22 GHz
Test equipment used	9054, 8798, 7399, 7280, 7299, 7401, 7367, 7403, 7397, 7398, 9052, 8990, 8877	

7.1 Limit

Minimum standard:

Para. No.24.238(a)

The rules in this section govern the spectral characteristics of emissions in the Broadband Personal Communications Service.

(a) Out of band emissions. The power of any emission outside of the authorized operating frequency ranges must be attenuated below the transmitting power (P) by a factor of at least $43 + 10 \log(P)$ dB.

7.2 Test method

Para. No 2.1051 Measurements required: Spurious emissions at antenna terminals.

The radio frequency voltage or powers generated within the equipment and appearing on a spurious frequency shall be checked at the equipment output terminals when properly loaded with a suitable artificial antenna. Curves or equivalent data shall show the magnitude of each harmonic and other spurious emission that can be detected when the equipment is operated under the conditions specified in § 2.1049 as appropriate. The magnitude of spurious emissions which are attenuated more than 20 dB below the permissible value need not be specified.

[39 FR 5919, Feb. 15, 1974. Redesignated and amended at 63 FR 36599, July 7, 1998]

7.3 Test results

7.3.1 Downlink

<1MHz from Band Edge

Detector: RMS.

Modulation	RBW VBW Span	Measured at f / MHz		Max. level (dBm)	Plot
GSM	3 kHz 30 kHz 2 MHz	Bottom	1975,4 1975,6	-30,2	7.3.1.1 #1
		Top	1989,4 1989,6	-31,1	7.3.1.1 #2



GSM EDGE	3 kHz 30 kHz 2 MHz	Bottom	1975,4 1975,6	-32,0	7.3.1.2 #1
		Top	1989,4 1989,6	-30,8	7.3.1.2 #2
CDMA	30 kHz 300 kHz 6 MHz	Bottom	1975,75 1977,0	-22,9	7.3.1.3 #1
		Top	1987,98 1989,25	-23,9	7.3.1.3 #1
WCDMA	100 kHz 1 MHz 15 MHz	Bottom	1977,6 1982,6	-21,6	7.3.1.4 #1
		Top	1982,4 1987,4	-21,3	7.3.1.4 #1
LTE	30 kHz 300 kHz 6 MHz	Bottom	1975,7 1977,1	-27,6	7.3.1.5 #1
		Top	1987,9 1989,3	-27,0	7.3.1.5 #2

table 7.3-#1 Spurious Emissions at Antenna Terminals: §24.238, §2.1051 Test results; Downlink; <1MHz from Band Edge

>1MHz from Band Edge

Detector: RMS.

Modulation	RBW VBW Span	Measured at f / (MHz)		Max. level (dBm)	Plot
GSM	1 MHz 3 MHz 30 MHz – 20 GHz	Middle	1982,5	-23,6	7.3.1.6
					#1
GSM EDGE	1 MHz 3 MHz 30 MHz – 20 GHz	Middle	1982,5	-23,0	7.3.1.7
					#1
CDMA	3 MHz 10 MHz 30 MHz – 20 GHz	Middle	1982,5	-23,1	7.3.1.8
					#1
WCDMA	10 MHz 10 MHz 30 MHz – 20 GHz	Middle	1982,5	-24,0	7.3.1.9
					#1
LTE	10 MHz 10 MHz 30 MHz – 20 GHz	Middle	1982,5	-23,0	7.3.1.10
					#1

table 7.3-#2 Spurious Emissions at Antenna Terminals: §24.238, §2.1051 Test results; Downlink;



7.3.1.1 GSM < 1MHz to band edge

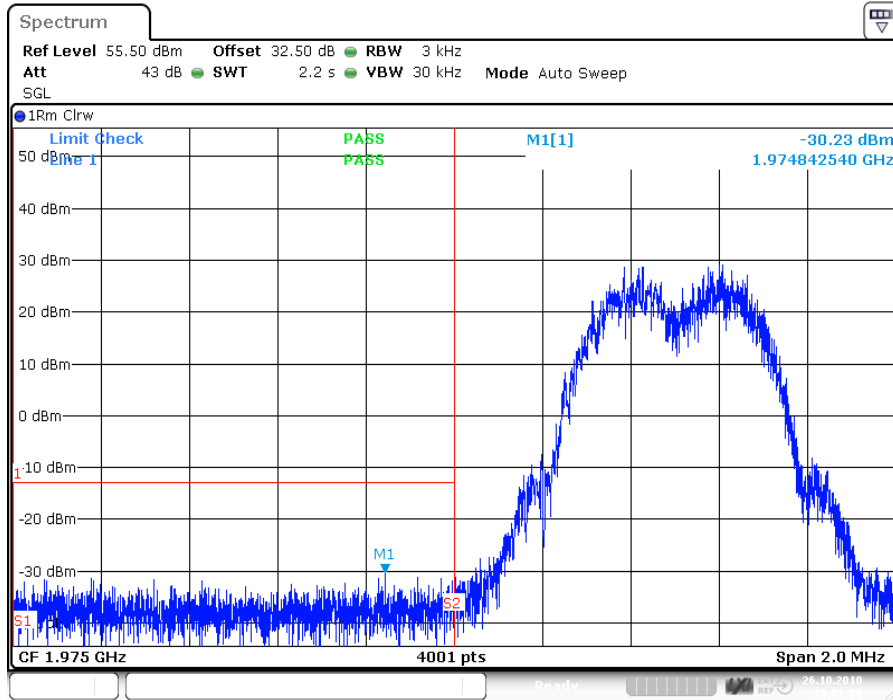

Date: 26.OCT.2010 19:01:10

plot 7.3.1.1-#1 Spurious Emissions at Antenna Terminals: §24.238, §2.1051; Test results; Downlink; GSM < 1MHz to band edge; Bottom

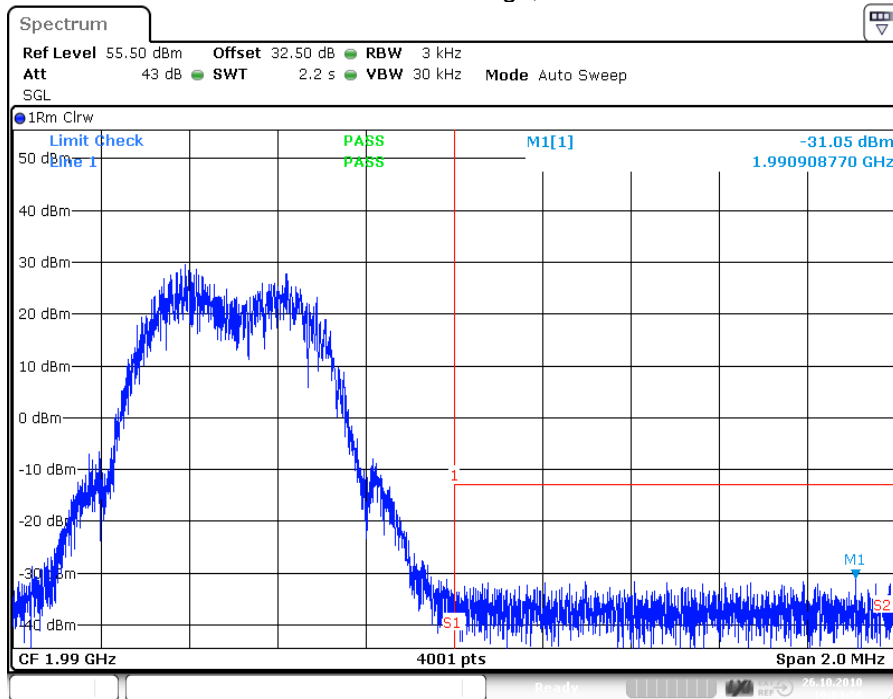

Date: 26.OCT.2010 19:04:50

plot 7.3.1.1-#2 Spurious Emissions at Antenna Terminals: §24.238, §2.1051; Test results; Downlink; GSM < 1MHz to band edge; Top



7.3.1.2 GSM EDGE < 1MHz to band edge

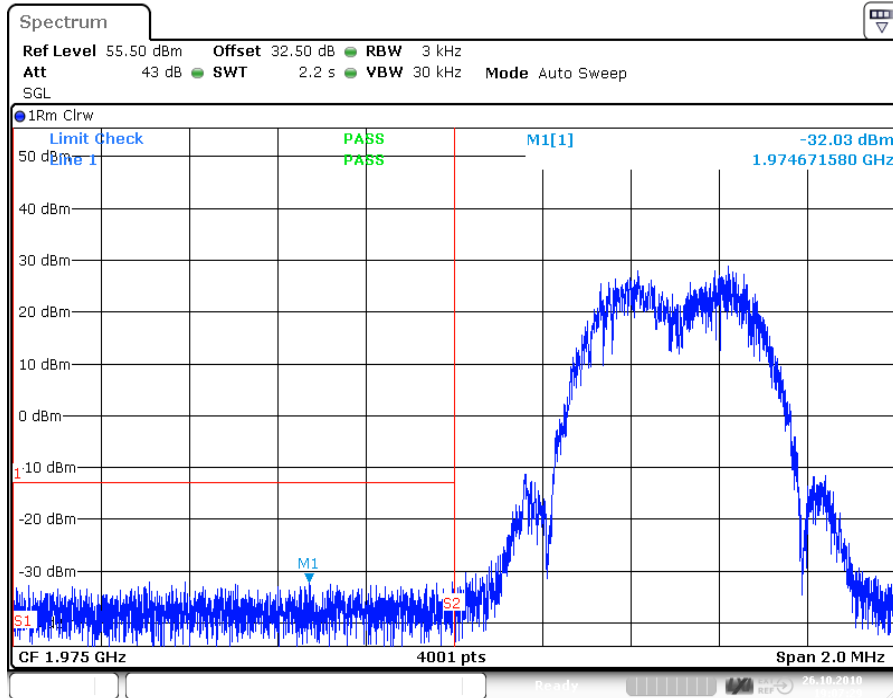

Date: 26.OCT.2010 19:07:29

plot 7.3.1.2-#1 Spurious Emissions at Antenna Terminals: §24.238, §2.1051; Test results; Downlink; GSM EDGE < 1MHz to band edge; Bottom

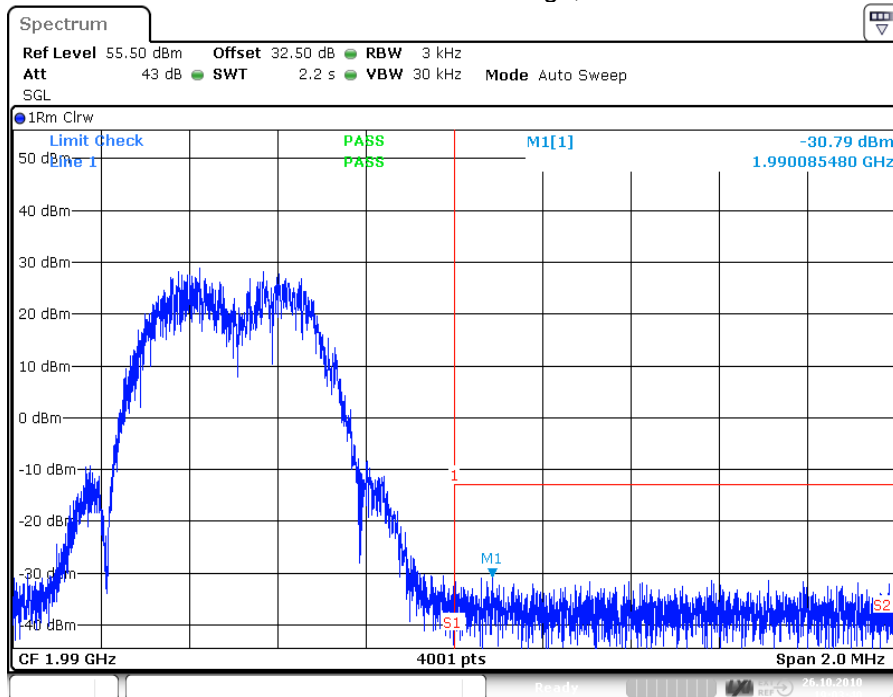

Date: 26.OCT.2010 19:03:40

plot 7.3.1.2-#2 Spurious Emissions at Antenna Terminals: §24.238, §2.1051; Test results; Downlink; GSM EDGE < 1MHz to band edge; Top



7.3.1.3 CDMA < 1MHz to band edge

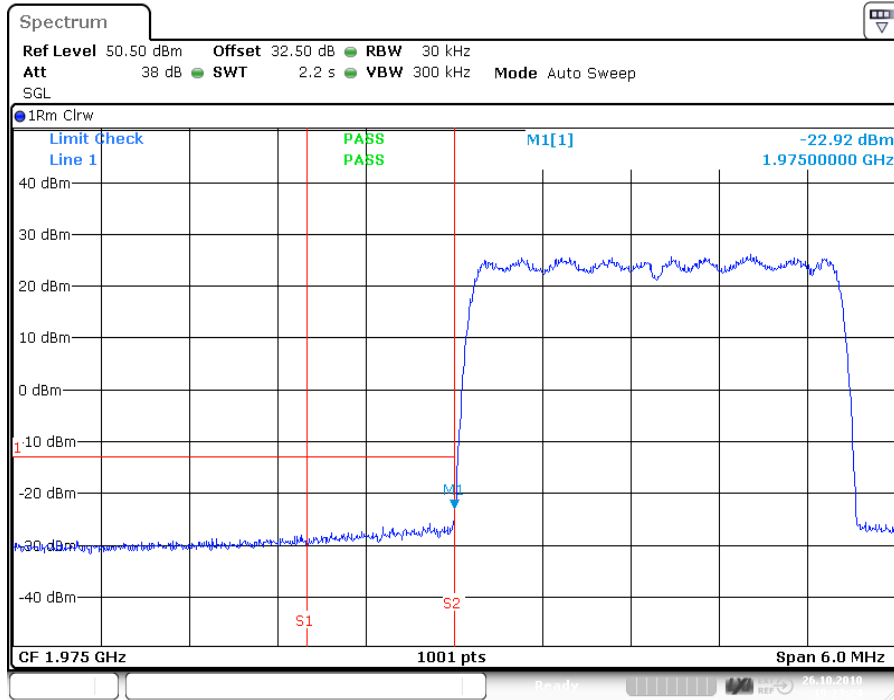

Date: 26.OCT.2010 19:23:24

plot 7.3.1.3-#1 Spurious Emissions at Antenna Terminals: §24.238, §2.1051; Test results; Downlink; CDMA < 1MHz to band edge; Bottom

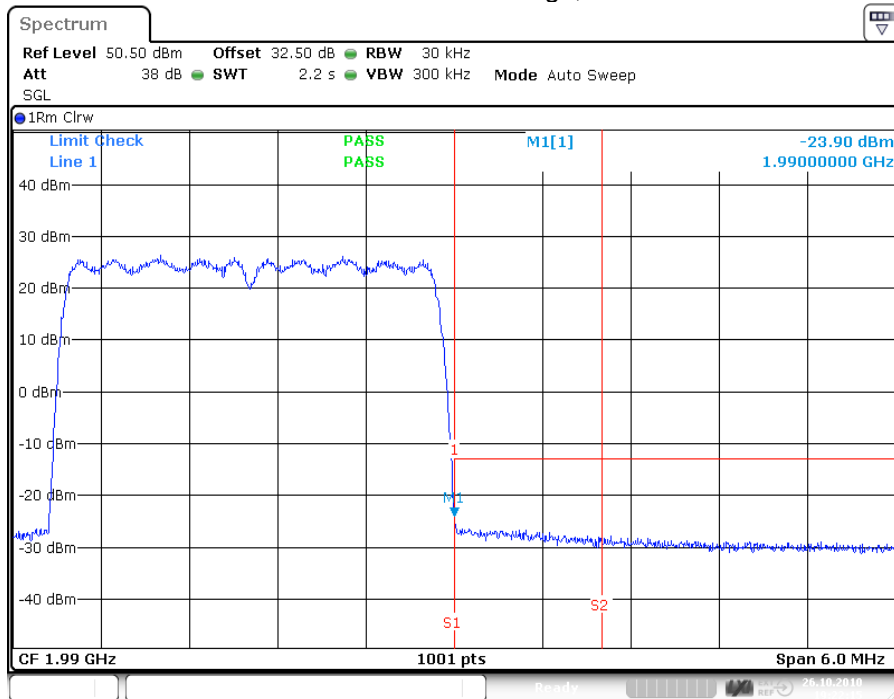

Date: 26.OCT.2010 19:22:15

plot 7.3.1.3-#2 Spurious Emissions at Antenna Terminals: §24.238, §2.1051; Test results; Downlink; CDMA < 1MHz to band edge; Top



7.3.1.4 W-CDMA < 1MHz to band edge

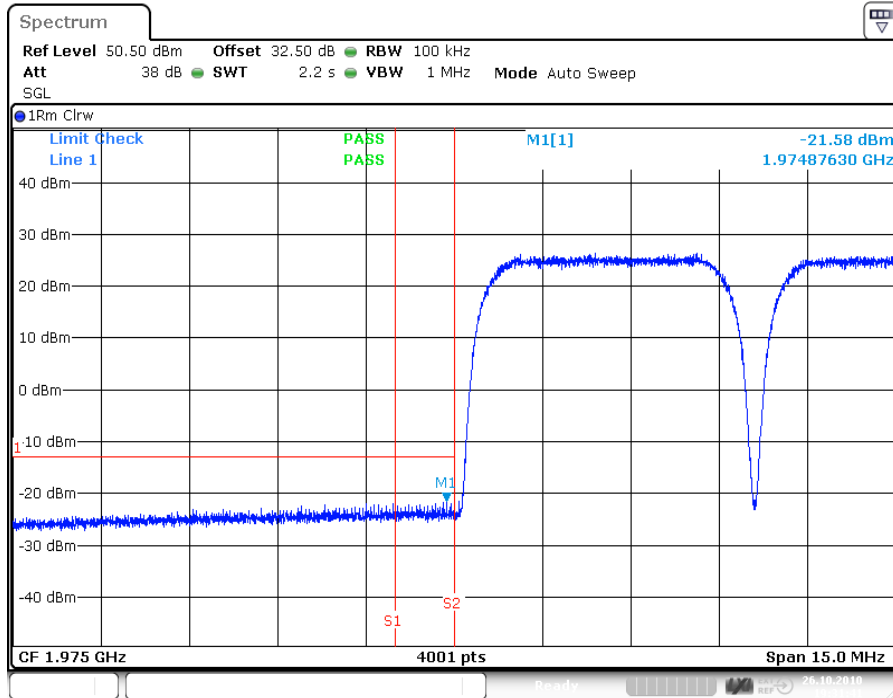

Date: 26.OCT.2010 19:31:41

plot 7.3.1.4-#1 Spurious Emissions at Antenna Terminals: §24.238, §2.1051; Test results; Downlink; W-CDMA < 1MHz to band edge; Bottom

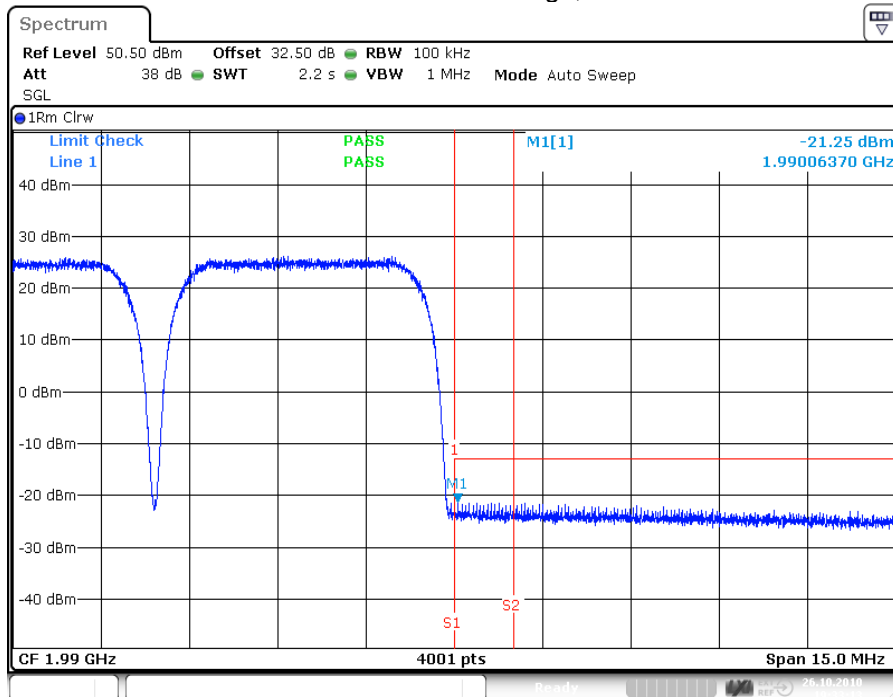

Date: 26.OCT.2010 19:33:13

plot 7.3.1.4-#2 Spurious Emissions at Antenna Terminals: §24.238, §2.1051; Test results; Downlink; W-CDMA < 1MHz to band edge; Top



7.3.1.5 LTE < 1MHz to band edge

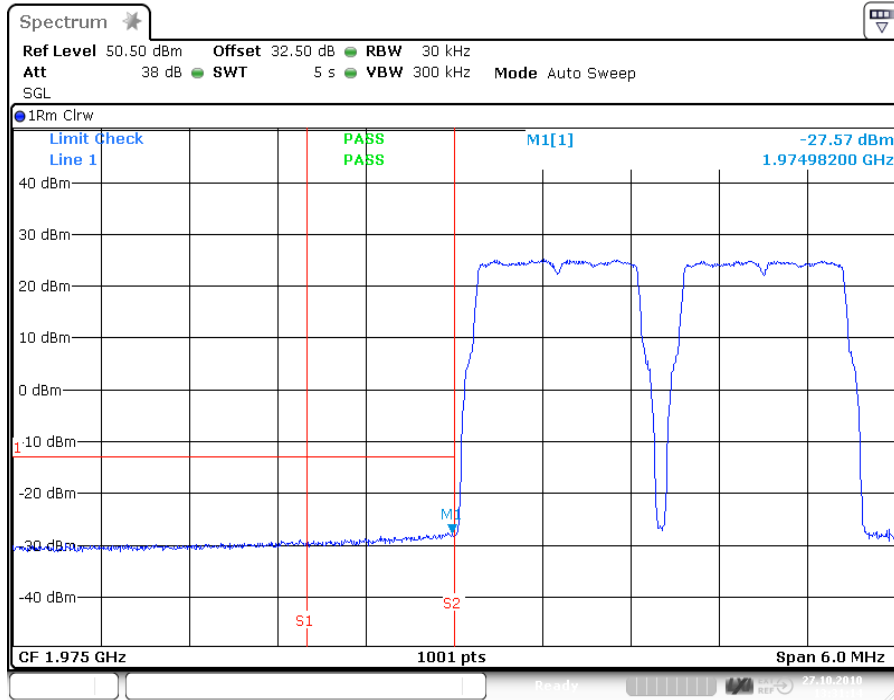

plot 7.3.1.5-#1 Spurious Emissions at Antenna Terminals: §24.238, §2.1051; Test results; Downlink; LTE < 1MHz to band edge; Bottom

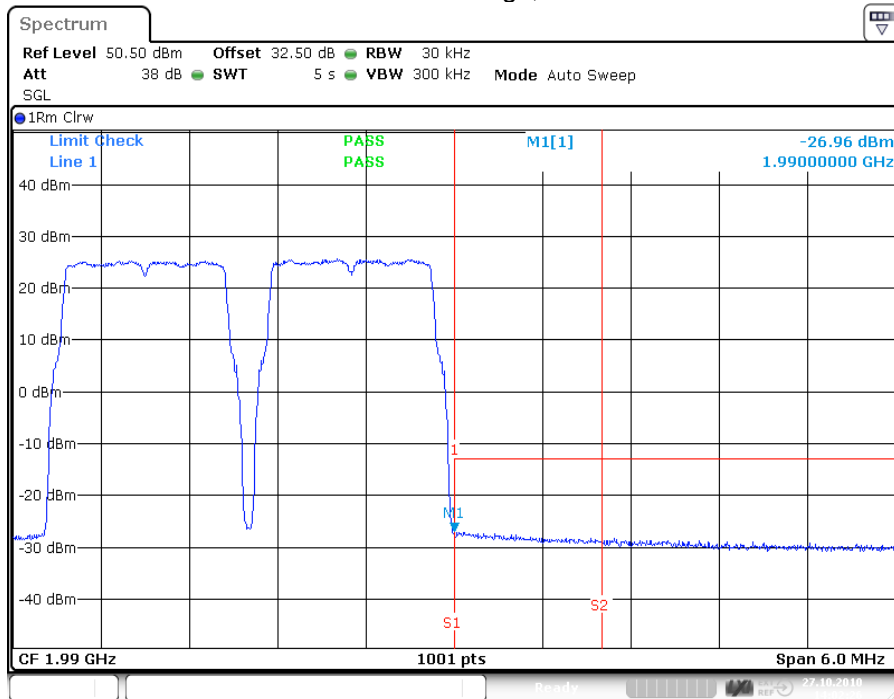

plot 7.3.1.5-#2 Spurious Emissions at Antenna Terminals: §24.238, §2.1051; Test results; Downlink; LTE < 1MHz to band edge; Top



7.3.1.6 GSM > 1MHz to band edge

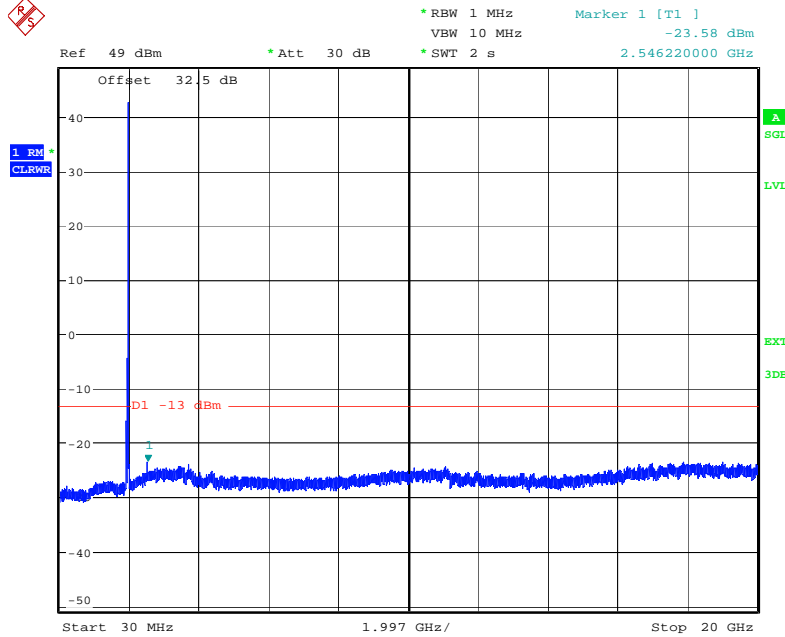

Date: 27.OCT.2010 17:26:07

plot 7.3.1.6-#1 Spurious Emissions at Antenna Terminals: §24.238, §2.1051; Test results; Downlink; GSM > 1MHz to band edge; Middle

7.3.1.7 GSM EDGE > 1MHz to band edge

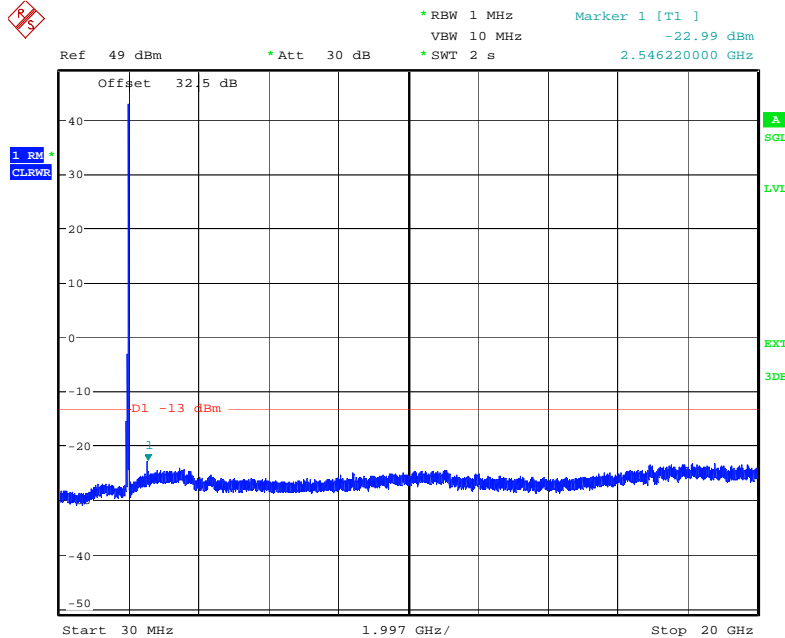

Date: 27.OCT.2010 17:26:38

plot 7.3.1.7-#1 Spurious Emissions at Antenna Terminals: §24.238, §2.1051; Test results; Downlink; GSM EDGE > 1MHz to band edge; Middle



7.3.1.8 CDMA > 1MHz to band edge

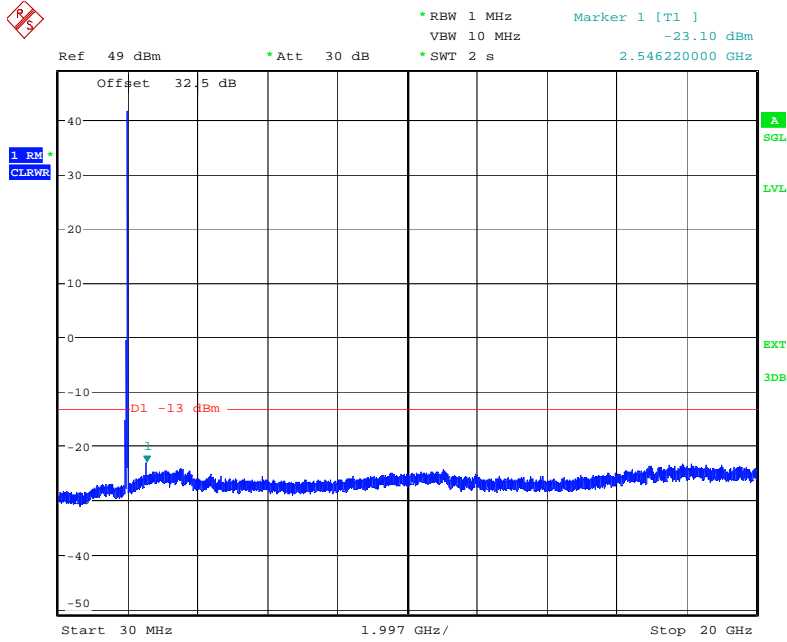

Date: 27.OCT.2010 17:24:15

plot 7.3.1.8-#1 Spurious Emissions at Antenna Terminals: §24.238, §2.1051; Test results; Downlink; CDMA > 1MHz to band edge; Middle

7.3.1.9 W-CDMA > 1MHz to band edge

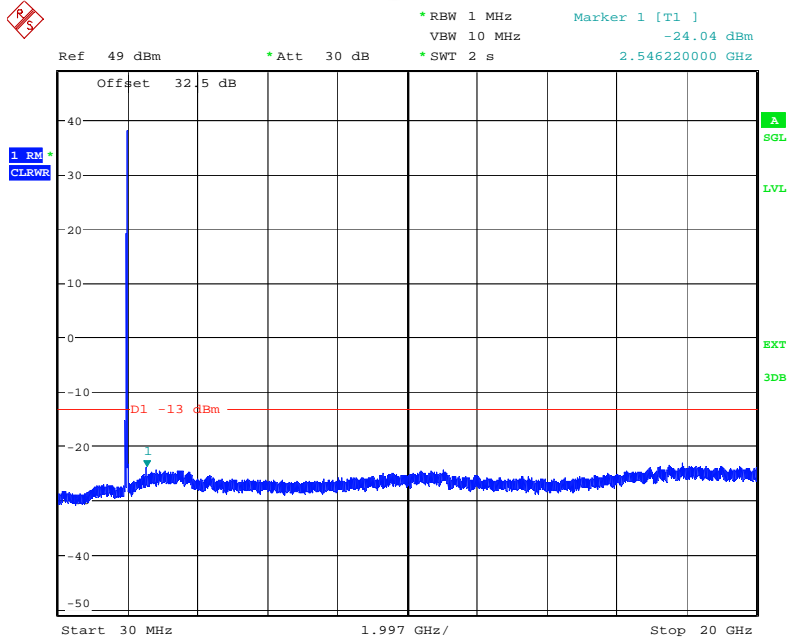

Date: 27.OCT.2010 17:22:31

plot 7.3.1.9-#1 Spurious Emissions at Antenna Terminals: §24.238, §2.1051; Test results; Downlink; W-CDMA > 1MHz to band edge; Middle



7.3.1.10 LTE > 1MHz to band edge

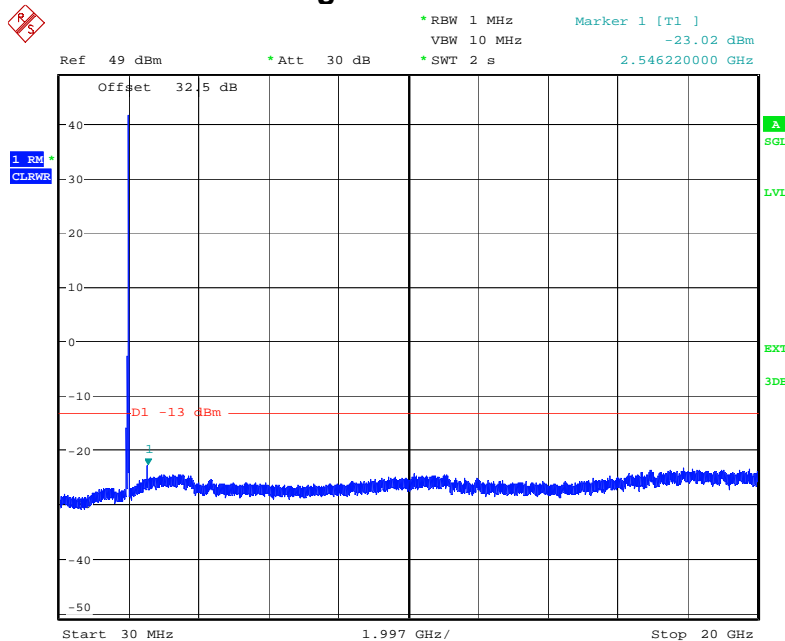

Date: 27.OCT.2010 17:21:05

plot 7.3.1.10-#1 Spurious Emissions at Antenna Terminals: §24.238, §2.1051; Test results; Downlink; LTE > 1MHz to band edge; Middle

7.3.2 Uplink

n.a.

Note: The EUT does not transmit over the air in the uplink direction.

7.4 Summary test result

Test result	complies, according the plots above
Tested by:	Michael Leinfelder
Date:	27.10.2010

8 Field Strength of Spurious Emissions: §24.53, §2.1053

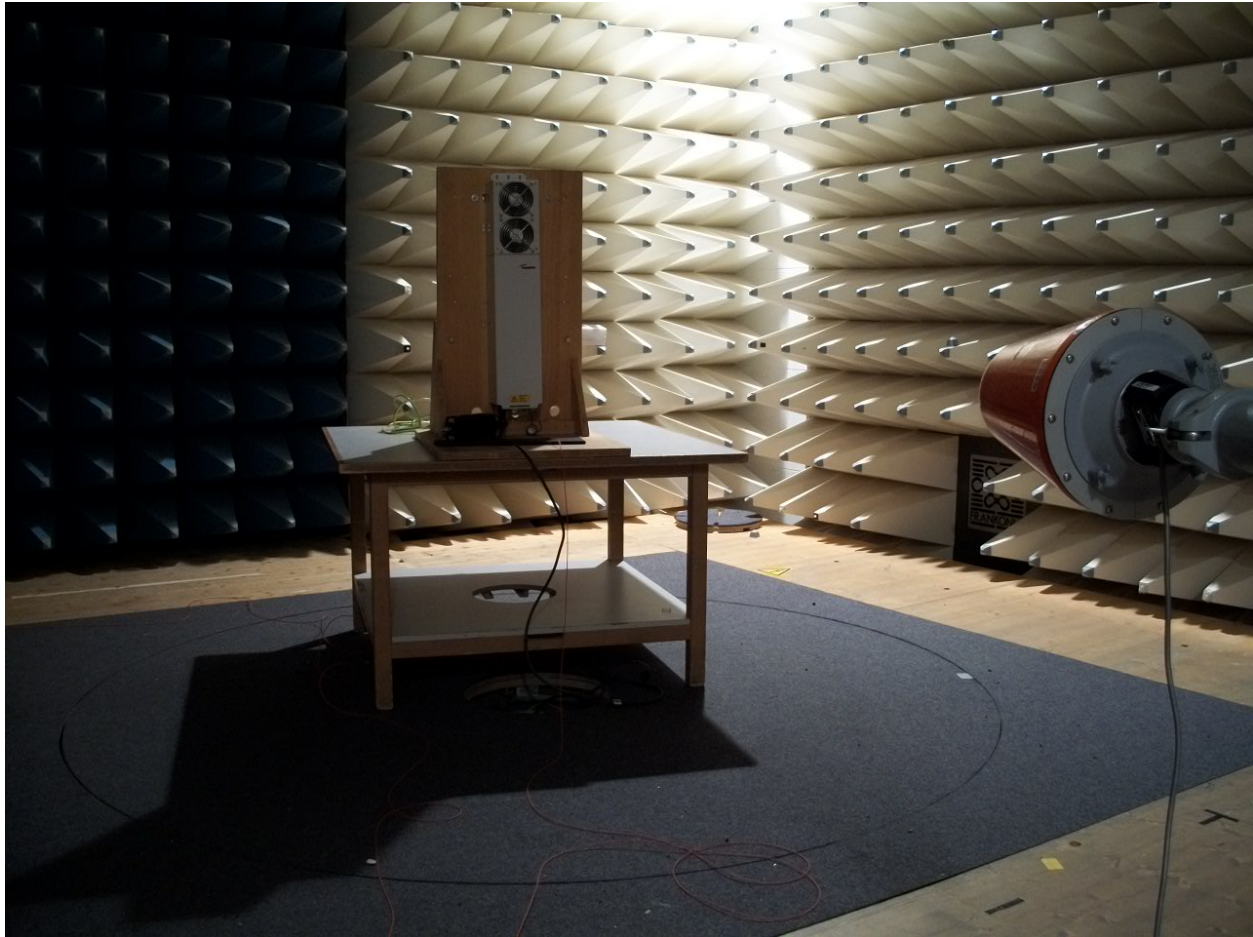

picture 8.1: Test setup: Field Strength Emission 1GHz to 22GHz @3m in the FAC

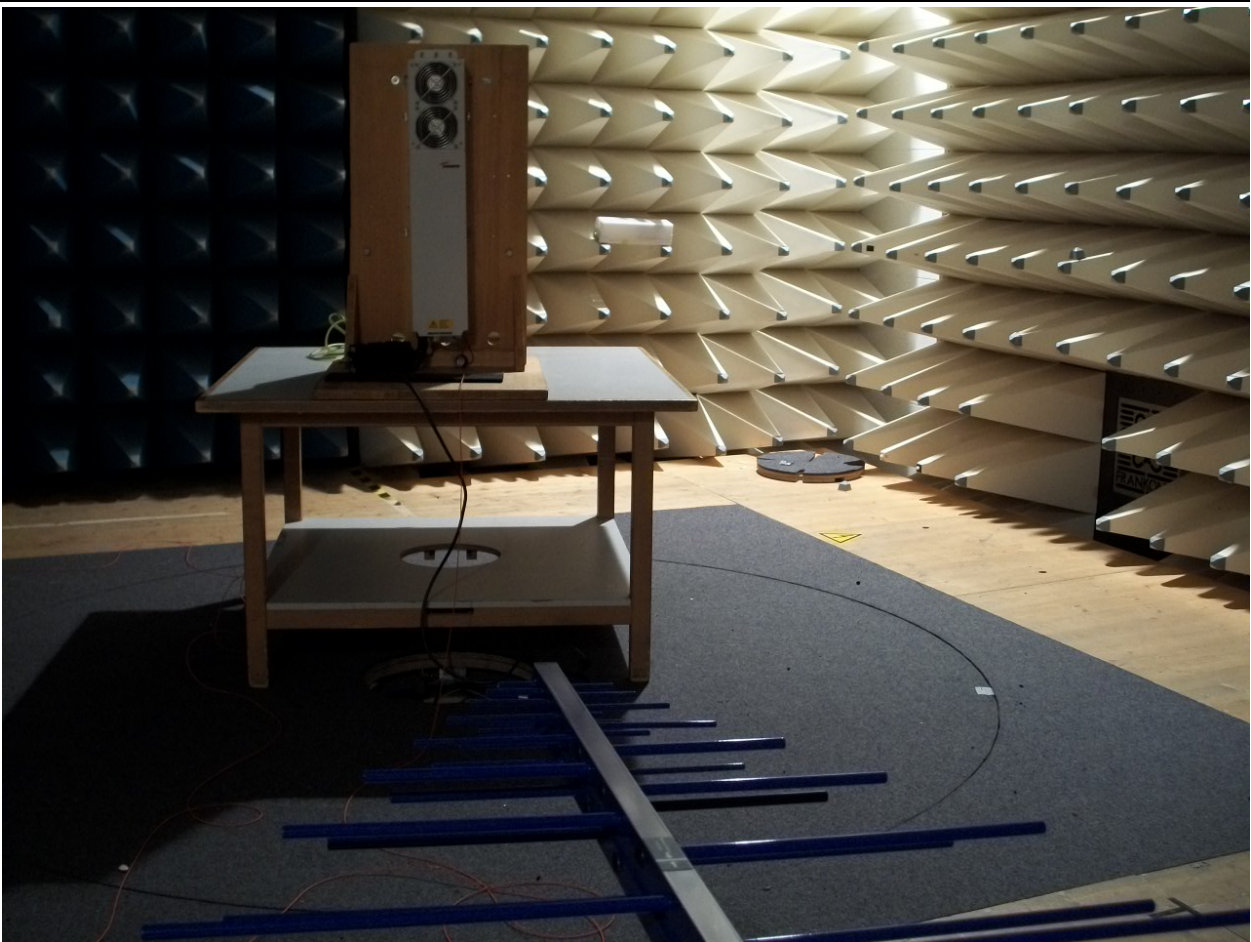

picture 8.2: Test setup: Field Strength Emission $< 1 \text{ GHz}$ @3m in the FAC

This clause specifies requirements for the measurement of radiated emission.

Frequency range	Distance: EUT <-> antenna / location	Limit	Test method
30 MHz - 1 GHz	3 metres / FAC	FCC 47 CFR Part 27.53	TIA/EIA-603-C:2004
1 GHz – 22 GHz		FCC 47 CFR Part 27.53	

Test equipment used:

Designation	Type	Manufacturer	Invent.-no.	Cal.-date	due Cal.- date	used
EMI test receiver	ESI40	Rohde & Schwarz	E1687	20.10.2009	20.10.2010	X
EMI test receiver	ESI40	Rohde & Schwarz	E1607	04.03.2009	04.03.2010	
Antenna	CBL 6111	Chase	K1149	21.05.2010	21.05.2011	X
Antenna	CBL 6111	Chase	K1026	14.09.2009	14.09.2010	
RF Cable	Rosenberger	Frankonia	K1121 SET	28.12.2009	28.12.2010	
Pre amplifier	AM1431	Miteq	K1721	02.07.2010	02.07.2011	
Antenna	HL 025	R&S	K809	04.02.2010	04.02.2011	X
Antenna	MWH-1826 / B	ARA Inc.	K1042	06.04.2009	06.04.2011	
Antenna	MWH-2640 / B	ARA Inc.	K1043	06.04.2009	06.04.2011	
Preamplifier	AFS4-00102000	Miteq	K817	11.11.2009	11.11.2010	X
Preamplifier	AFS4-00102000	Miteq	K838	06.10.2009	06.10.2010	
Preamplifier	JS43-1800-4000	Miteq	K1104	26.08.2009	26.08.2010	
RF Cable	Sucoflex 100	Suhner	K1742	09.04.2010	09.04.2011	X

The REMI version 2.135 has been used for max search.

Test set-up:

Test location: FAC
 Both, the Fully Anechoic Chamber (FAC) and the Semi Anechoic Chamber (SAC) fulfil the requirements of ANSI C63.4 and CISPR 16-1-4 with regards to NSA and SVSWR.

Test Voltage: 115V / 60 Hz
 Type of EUT: Wall mounted

Measurement uncertainty:

Measurement uncertainty expanded (95% or K=2)	± 4,7 dB for ANSI C63.4 measurement ± 0,5 dB for TIA-603 measurement
--	---



8.1 Limit §24.238

The rules in this section govern the spectral characteristics of emissions in the Broadband Personal Communications Service.

(a) *Out of band emissions.* The power of any emission outside of the authorized operating frequency ranges must be attenuated below the transmitting power (P) by a factor of at least $43 + 10 \log(P)$ dB.

(b) *Measurement procedure.* Compliance with these rules is based on the use of measurement instrumentation employing a resolution bandwidth of 1 MHz or greater. However, in the 1 MHz bands immediately outside and adjacent to the frequency block a resolution bandwidth of at least one percent of the emission bandwidth of the fundamental emission of the transmitter may be employed. A narrower resolution bandwidth is permitted in all cases to improve measurement accuracy provided the measured power is integrated over the full required measurement bandwidth (*i.e.* 1 MHz or 1 percent of emission bandwidth, as specified). The emission bandwidth is defined as the width of the signal between two points, one below the carrier center frequency and one above the carrier center frequency, outside of which all emissions are attenuated at least 26 dB below the transmitter power.

The emission measurements have been made with transmission at **Bottom/ Middle/Top** frequency

1975/1982.5/1990 MHz

The limit is -13dBm (e.i.r.p).

8.2 Test method ANSI/TIA/EA-603-C

Measurement procedure. TIA-603-C

The antenna substitution method is used to determine the equivalent radiated power at spurious frequencies. The spurious emissions are measured at a distance of 3 meters. The EUT is then replaced with a reference substitution antenna with a known gain referenced to a dipole. This antenna is fed with a signal at the spurious frequency. The level of the signal is adjusted to repeat the previously measured level. The resulting eirp is the signal level fed to the reference antenna corrected for gain referenced to an isotropic dipole (see Figure 7.2).

From KDB (AMPLIFIER, BOOSTER, AND REPEATER REMINDER SHEET):

Radiated spurs (enclosure) – Use of CW signal (low, mid. and high freq.) is acceptable rather than all modulations.

The maximum RFI field strength was determined during the measurement by rotating the turntable (± 180 degrees) and varying the height of the receive antenna ($h = 1 \dots 4$ m) as like defined in ANSI C63.4. A measurement receiver has been used with a RBW 120 kHz up to 1 GHz and 1 MHz above 1 GHz. Steps with during pre measurement was half the RBW.

Both, the Fully Anechoic Chamber (FAC) and the Semi Anechoic Chamber (SAC) fulfil the requirements of ANSI C63.4 and CISPR 16-1-4 with regards to NSA and SVSWR.

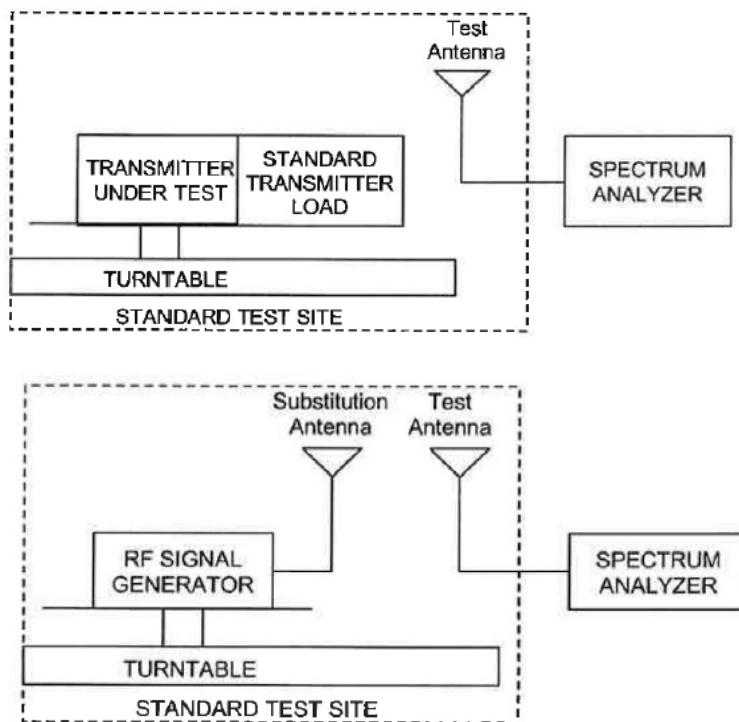

picture 8.3: Substitution method

8.3 Climatic values in the lab

Temperature: 20°
 Relative Humidity: 45%
 Air-pressure: 1009hPa



8.4 Test results

8.4.1 30 MHz to 22 GHz Downlink (Bottom – Middle – Top)

B/M/T: 1975/1982.5/1990 MHz

Polarisation: horizontal, vertical

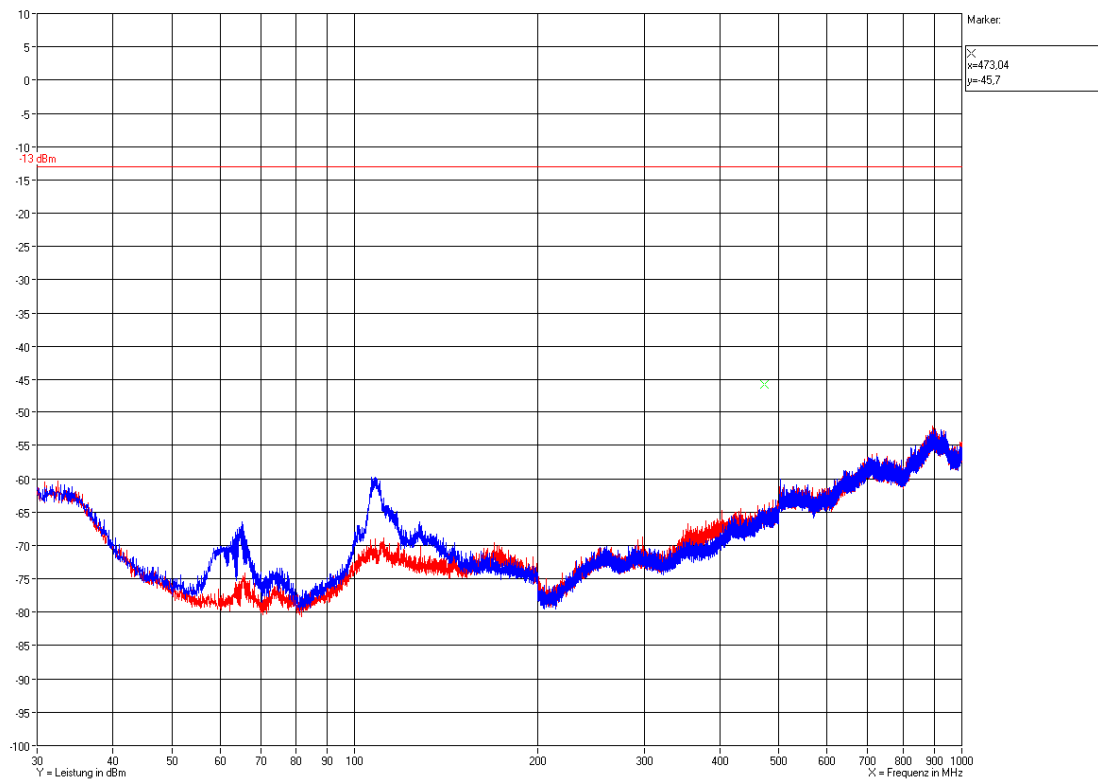

Plot 8.1: Measurement: Field Strength Emission <1 GHz @3m in the FAC max.hold

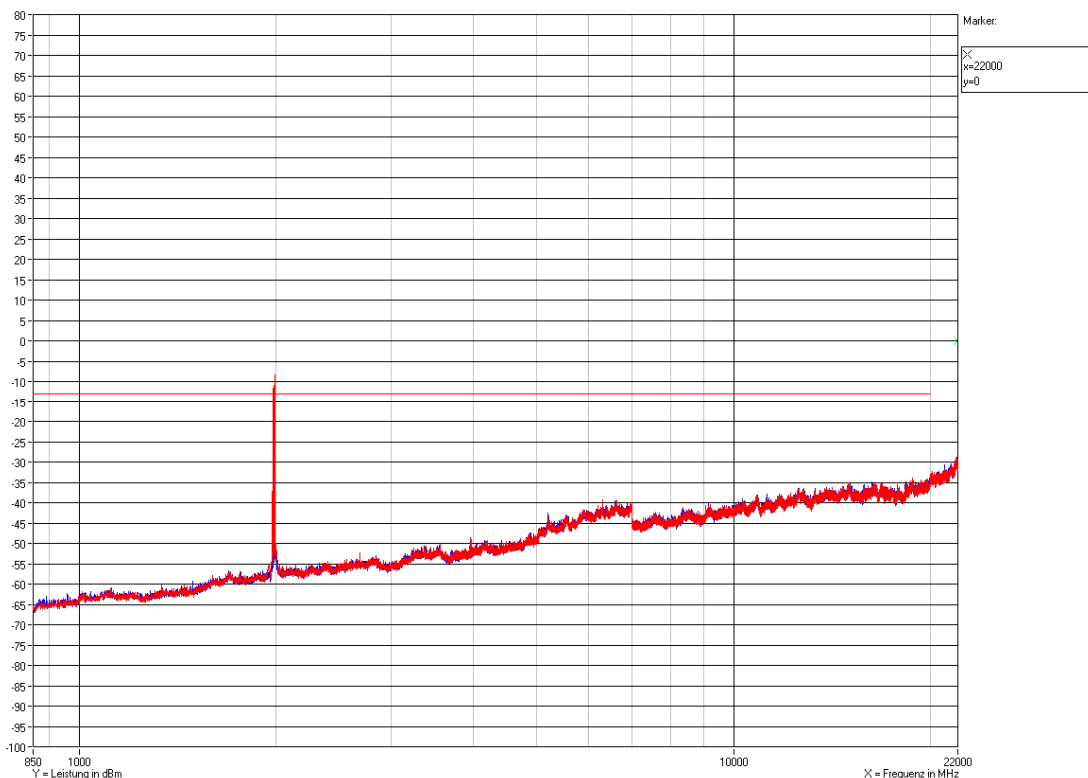

Plot 8.2: Measurement: Field Strength Emission >1 GHz to 22GHz @3m in the FAC max.hold

No further disturbance could be measured than noise.
Margin to the limits is more than 15dB.

8.5 Summary test result

Test result	complies, according to the plots above
Tested by:	Günter Weinfurter
Date:	02.11.2010



9 History

Revision	Modification	Date	Name
01.00	Initial release	11.11.2010	G. Weinfurter

***** End of test report *****