



ECL-TA Test Report No.: 20-010

Designation:	CAP MX AC 6/7E/80-85/17E/19/23/25T
Manufacturer:	Andrew
Serial No(s):	8
ID No.	7830127-0001, Rev.: 00
Test Specification(s):	ANSI 63.26:2015 FCC Rules and Regulations as listed in 47 CFR, Part 20:2019-10-01
Test Plan:	Measurement of Band 30/WCS 2300 downlink.
Test Result:	Passed

Date of issue:	2020-10-23		Signature:
Version:	01	Technical Reviewer:	
Date of delivery:	2020-07		
Performance date:	2020-07-29. – 2020-09-09	Report Reviewer:	



The test results relates only to the tested item. The sample has been provided by the client.
Without the written consent of Bureau Veritas Consumer Products Services Germany GmbH excerpts of this report shall not be reproduced.

Bureau Veritas
Consumer Products Services Germany GmbH
www.bureauveritas.de/cps
Phone: +49 (0)40 – 740 41 – 0

Schwerin
Wilhelm-Hennemann-Str. 8, 19061 Schwerin
cps-schwerin@de.bureauveritas.com

Tuerkheim
Businesspark A96, 86842 Tuerkheim
cps-tuerkheim@de.bureauveritas.com

Managing Director: Sebastian Doose/Stefan Kischka

Hamburg
Oehleckerring 40, 22419 Hamburg
cps-hamburg@de.bureauveritas.com

Nuremberg
Thurn-und-Taxis-Str. 18, 90411 Nuremberg
cps-nuernberg@de.bureauveritas.com

Reg.No.: Schwerin HRB 3564



**BUREAU
VERITAS**

EfectiveECL-TA-20-010-V01.00

TA tests on Andrew CAP MX AC 6/7E/80-
85/17E/19/23/25T

Commscope

Client:

Andrew Wireless System GmbH

Industriering 10

86675 Buchdorf Germany

Test Laboratory:

Bureau Veritas Consumer Products Services Germany GmbH

Thurn-und-Taxis-Straße 18

D-90411 Nürnberg

Tel.: +49 40 74041 0

Fax: +49 40 74041-2755

Versions management:

V01.00

Initial release



Effective ECL-TA-20-010-V01.00

TA tests on Andrew CAP MX AC 6/7E/80-
85/17E/19/23/25T

Table of Contents

1	ADMINISTRATIVE DATA	4
1.1	TESTING LABORATORY.....	4
1.2	APPLICANT DATA	4
1.3	MANUFACTURER DATA	4
2	APPLIED STANDARDS AND TEST SUMMARY	5
2.1	APPLIED STANDARDS	5
2.2	FCC-IC CORRELATION TABLE	6
2.3	MEASUREMENT SUMMARY/SIGNATURES	7
3	TEST OBJECT DATA.....	10
3.1	GENERAL EUT DESCRIPTION	10
3.2	EUT MAIN COMPONENTS	11
3.3	ANCILLARY EQUIPMENT	11
3.4	AUXILIARY EQUIPMENT.....	12
3.5	EUT SETUPS.....	13
3.6	PRODUCT LABELLING.....	14
4	TEST RESULTS	15
4.1	EFFECTIVE RADIATED POWER, MEAN OUTPUT POWER AND ZONE ENHANCER GAIN 15	
4.2	PEAK TO AVERAGE RATIO	24
4.3	OCCUPIED BANDWIDTH/INPUT-VERSUS-OUTPUT SPECTRUM.....	29
4.4	CONDUCTED SPURIOUS EMISSIONS AT ANTENNA TERMINALS.....	37
4.5	OUT-OF-BAND EMISSION LIMITS	48
4.6	OUT-OF-BAND REJECTION	62
4.7	FIELD STRENGTH OF SPURIOUS RADIATION.....	64
5	TEST EQUIPMENT	75
6	ANTENNA FACTORS, CABLE LOSS AND SAMPLE CALCULATIONS	76
6.1	ANTENNA CHASE CBL 6111C (30 MHZ – 1 GHZ)	76
6.2	ANTENNA ROHDE & SCHWARZ HL 025 (1 GHZ – 18 GHZ)	77
6.3	ANTENNA ARA INC. MWH-1826-B (18 GHZ – 26.5 GHZ) PARTIALLY IN CONJUNCTION WITH PRE-AMPLIFIER MITEQ JS43-1800-4000: THE USE OF THE PRE-AMPLIFIER IS DEPENDENT FROM THE FIELD STRENGTH	78
7	MEASUREMENT UNCERTAINTIES.....	79
8	PHOTO REPORT	80
	Annex A: Accreditation certificate (for information)	81
	Annex B: Additional information provided by client.....	82



EfectiveECL-TA-20-010-V01.00

TA tests on Andrew CAP MX AC 6/7E/80-
85/17E/19/23/25T

1 ADMINISTRATIVE DATA

1.1 TESTING LABORATORY

Bureau Veritas Consumer Products Services Germany GmbH
Thurn-und-Taxis-Straße 18
D-90411 Nürnberg
Tel.: +49 40 74041 0
Fax: +49 40 74041-2755

1.2 APPLICANT DATA

Company Name: Commscope
Andrew Wireless Systems GmbH

Address: Industriering 10
86675 Buchdorf
Germany

Contact Person: Mr. Frank Futter

1.3 MANUFACTURER DATA

Company Name: Please see applicant data.

Address:



Effective ECL-TA-20-010-V01.00

TA tests on Andrew CAP MX AC 6/7E/80-
85/17E/19/23/25T

2 APPLIED STANDARDS AND TEST SUMMARY

2.1 APPLIED STANDARDS

Type of Authorization

Certification for an Industrial Signal Booster.

Applicable FCC Rules

Prepared in accordance with the requirements of FCC Rules and Regulations as listed in 47 CFR Ch.1 Parts 2 and 20, 22 and 24. The following subparts are applicable to the results in this test report.

Part 2, Subpart J - Equipment Authorization Procedures, Certification

Part 20, Commercial Mobile Services

§ 20.21 Signal Boosters

Part 27; Miscellaneous Wireless Communications Services
Subpart C – Technical standards

§ 27.50 – Power and antenna height limits

§ 27.54 – Frequency stability

§ 27.53 – Emission limitations for broadband PCS equipment

The tests were selected and performed with reference to:

- FCC Public Notice 935210 applying "Signal Boosters Basic Certification Requirements" 935210 D02, 2019-15-04.
- FCC Public Notice 935210 applying "Measurement guidance for industrial and non-consumer signal booster, repeater and amplifier devices" 935210 D05, 2019-04-03.
- FCC Public Notice 971168 applying "Measurement guidance for certification of licensed digital transmitters" 971168 D01, 2019-04-09.
- ANSI C63.26: 2015



Effective ECL-TA-20-010-V01.00

TA tests on Andrew CAP MX AC 6/7E/80-
85/17E/19/23/25T

Summary Test Results:

The EUT complies with all performed tests as listed in chapter 1.3 Measurement Summary/Signatures.

2.2 FCC-IC CORRELATION TABLE

**Correlation of measurement requirements for
Industrial Signal Booster from FCC and ISED Canada**

Measurement	FCC reference	ISED reference
Effective radiated power, mean output power and zone enhancer gain	§ 2.1046 § 27.50 KDB 935210 D05 v01r04: 3.5	RSS-GEN Issue 5, 6.12 RSS-131 Issue 3: 5.2.3 RSS-195 Issue 2, 5.5 SRSP-516, Issue 1, 5.1.1
Peak to Average Ratio	§ 27.50	RSS-195 Issue 2, 5.5
Occupied bandwidth Input-versus-output spectrum	§ 2.1049 KDB 935210 D05 v01r04: 3.4	RSS-GEN Issue 5, 6.7 RSS-131 Issue 3: 5.2.2
Conducted spurious Emission at Antenna Terminal	§ 2.1051 § 27.53 KDB 935210 D05 v01r04: 3.6	RSS-GEN Issue 5, 6.13 RSS-195 Issue 3, 5.6
Out-of-band emissions limits	§ 2.1051 § 27.53 KDB 935210 D05 v01r04: 3.6	RSS-GEN Issue 5, 6.13 RSS-195 Issue 3, 5.6
Frequency stability	§ 2.1055 § 27.54	RSS-GEN Issue 5, 6.11 RSS-131 Issue 3: 5.2.4 RSS-195 Issue 3, 5.6
Field strength of spurious radiation	§ 2.1053 § 27.53	RSS-GEN Issue 5, 6.13 RSS-195 Issue 3, 5.6
Out-of-band rejection	KDB 935210 D05 v01r04: 3.3	RSS-131 Issue 3: 5.2.1
All measurements	ANSI 63.26	ANSI 63.26



Effective ECL-TA-20-010-V01.00

TA tests on Andrew CAP MX AC 6/7E/80-85/17E/19/23/25T

2.3 MEASUREMENT SUMMARY/SIGNATURES

47 CFR CHAPTER I FCC PART 24 Subpart E [Base § 2.1046, § 27.50 Stations/Repeater]

Effective Radiated Power, mean output power and zone enhancer gain
 The measurement was performed according to ANSI C63.26, KDB 935210 D05 v01r04: 3.5

Final Result

OP-Mode

Frequency Band, Direction, Input Power, Signal Type

- Band 30 WCS 2300, RF downlink, 0.3 dB < AGC, Narrowband
- Band 30 WCS 2300, RF downlink, 0.3 dB < AGC, Wideband
- Band 30 WCS 2300, RF downlink, 3 dB > AGC, Narrowband
- Band 30 WCS 2300, RF downlink, 3 dB > AGC, Wideband

FCC	IC
Passed	Passed
Passed	Passed
Passed	Passed
Passed	Passed

47 CFR CHAPTER I FCC PART 24 Subpart E [Base § 27.50 Stations/Repeater]

Peak to Average Ratio
 The measurement was performed according to ANSI C63.26

Final Result

- Band 30 WCS 2300, RF downlink, 0.3 dB < AGC, Narrowband
- Band 30 WCS 2300, RF downlink, 0.3 dB < AGC, Wideband
- Band 30 WCS 2300, RF downlink, 3 dB > AGC, Narrowband
- Band 30 WCS 2300, RF downlink, 3 dB > AGC, Wideband

Passed	Passed
Passed	Passed
Passed	Passed
Passed	Passed

47 CFR CHAPTER I FCC PART 24 Subpart E [Base § 2.1049 Stations/Repeater]

Occupied Bandwidth/Input-versus-output Spectrum
 The measurement was performed according to ANSI C63.26, KDB 935210 D05 v01r04: 3.4

Final Result

OP-Mode

Frequency Band, Direction, Input Power, Signal Type

- Band 30 WCS 2300, RF downlink, 0.3 dB < AGC, Narrowband
- Band 30 WCS 2300, RF downlink, 0.3 dB < AGC, Wideband
- Band 30 WCS 2300, RF downlink, 3 dB > AGC, Narrowband
- Band 30 WCS 2300, RF downlink, 3 dB > AGC, Wideband

FCC	IC
Passed	Passed
Passed	Passed
Passed	Passed
Passed	Passed



EffectiveECL-TA-20-010-V01.00

TA tests on Andrew CAP MX AC 6/7E/80-85/17E/19/23/25T

47 CFR CHAPTER I FCC PART 24 Subpart E [Base § 2.1051, § 27.53 Stations/Repeater]

Conducted spurious emissions at antenna terminals The measurement was performed according to ANSI C63.26	Final Result	
OP-Mode	FCC	IC
Frequency Band, Direction, Input Power, Signal Type		
Band 30 WCS 2300, RF downlink, 0.3 dB < AGC, Narrowband	Passed	Passed
Band 30 WCS 2300, RF downlink, 0.3 dB < AGC, Wideband	Passed	Passed
Band 30 WCS 2300, RF downlink, 3 dB > AGC, Narrowband	Passed	Passed
Band 30 WCS 2300, RF downlink, 3 dB > AGC, Wideband	Passed	Passed

47 CFR CHAPTER I FCC PART 24 Subpart E [Base § 2.1051, § 27.53 Stations/Repeater]

Out-of-band emission limits The measurement was performed according to ANSI C63.26, KDB 935210 D05 v01r04: 3.6	Final Result	
OP-Mode	FCC	IC
Band Edge, Frequency Band, Number of signals, Direction, Input Power, Signal Type		
Band 30 WCS 2300, RF downlink, 0.3 dB < AGC, Narrowband	Passed	Passed
Band 30 WCS 2300, RF downlink, 0.3 dB < AGC, Wideband	Passed	Passed
Band 30 WCS 2300, RF downlink, 3 dB > AGC, Narrowband	Passed	Passed
Band 30 WCS 2300, RF downlink, 3 dB > AGC, Wideband	Passed	Passed

47 CFR CHAPTER I FCC PART 24 Subpart E [Base § 2.1051, § 27.53 Stations/Repeater]

Out-of-band emission limits The measurement was performed according to ANSI C63.26, KDB 935210 D05 v01r04: 3.6	Final Result	
OP-Mode	FCC	IC
Band Edge, Frequency Band, Number of signals, Direction, Input Power, Signal Type		
Lower, Band 30 WCS 2300, 1, RF downlink, 0.3 dB < AGC, Narrowband	Passed	Passed
Lower, Band 30 WCS 2300, 1, RF downlink, 0.3 dB < AGC, Wideband	Passed	Passed
Lower, Band 30 WCS 2300, 1, RF downlink, 3 dB > AGC, Narrowband	Passed	Passed
Lower, Band 30 WCS 2300, 1, RF downlink, 3 dB > AGC, Wideband	Passed	Passed
Lower, Band 30 WCS 2300, 2, RF downlink, 0.3 dB < AGC, Narrowband	Passed	Passed
Lower, Band 30 WCS 2300, 2, RF downlink, 0.3 dB < AGC, Wideband	Passed	Passed
Lower, Band 30 WCS 2300, 2, RF downlink, 3 dB > AGC, Narrowband	Passed	Passed
Lower, Band 30 WCS 2300, 2, RF downlink, 3 dB > AGC, Wideband	Passed	Passed



Effective ECL-TA-20-010-V01.00

TA tests on Andrew CAP MX AC 6/7E/80-85/17E/19/23/25T

47 CFR CHAPTER I FCC PART 24 Subpart E [Base § 2.1051, § 27.53 Stations/Repeater]

Out-of-band emission limits
The measurement was performed according to ANSI C63.26, KDB 935210 D05 v01r04: 3.6 **Final Result**

OP-Mode	FCC	IC
Band Edge, Frequency Band, Number of signals, Direction, Input Power, Signal Type		
Upper, Band 30 WCS 2300, 1, RF downlink, 0.3 dB < AGC, Narrowband	Passed	Passed
Upper, Band 30 WCS 2300, 1, RF downlink, 0.3 dB < AGC, Wideband	Passed	Passed
Upper, Band 30 WCS 2300, 1, RF downlink, 3 dB > AGC, Narrowband	Passed	Passed
Upper, Band 30 WCS 2300, 1, RF downlink, 3 dB > AGC, Wideband	Passed	Passed
Upper, Band 30 WCS 2300, 2, RF downlink, 0.3 dB < AGC, Narrowband	Passed	Passed
Upper, Band 30 WCS 2300, 2, RF downlink, 0.3 dB < AGC, Wideband	Passed	Passed
Upper, Band 30 WCS 2300, 2, RF downlink, 3 dB > AGC, Narrowband	Passed	Passed
Upper, Band 30 WCS 2300, 2, RF downlink, 3 dB > AGC, Wideband	Passed	Passed

47 CFR CHAPTER I FCC PART 24 Subpart E [Base KDB 935210 D05 v01r04: 3.3 Stations/Repeater]

Out-of-band rejection
The measurement was performed according to ANSI C63.26; KDB 935210 D05 v01r04: 3.3 **Final Result**

OP-Mode	Setup	FCC	IC
Frequency Band, Direction			
Band 30 WCS 2300, RF downlink		Passed	Passed

47 CFR CHAPTER I FCC PART 24 Subpart E [Base § 2.1053, § 27.53 Stations/Repeater]

Field strength of spurious radiation
The measurement was performed according to ANSI C63.26 **Final Result**

OP-Mode	FCC	IC
Frequency Band, Test Frequency, Direction		
Band 30 WCS 2300, high, RF downlink	Passed	Passed
Band 30 WCS 2300, low, RF downlink	Passed	Passed
Band 30 WCS 2300, mid, RF downlink	Passed	Passed

The test case frequency stability was not performed, since the EUT is not equipped with signal processing capabilities.



EfectiveECL-TA-20-010-V01.00

TA tests on Andrew CAP MX AC 6/7E/80-
85/17E/19/23/25T

3 TEST OBJECT DATA

3.1 GENERAL EUT DESCRIPTION

Kind of Device product description	Cellular Repeater
Product name	Cellular Repeater
Type	
Declared EUT data by the supplier	
General Product Description	The EUT is an industrial signal booster supporting the following: Band 5/CELL 850 Band 5 CELL 850/USA 700E Band 5 CELL 850/USA 750 Band 14/LMR 750 Band 25/PCS 1900 Band 27/CELL 800 Band 30/WCS 2300 Band 41/BRS Band 66/AWS 1700E (partly) Band 70/Band 70 Band 71/USA 600 A RF operation is only supported for the downlink.
Booster Type	Industrial Signal Booster
Voltage Type	AC/50 Hz – 60 Hz
Voltage Level	100 V - 240 V
Maximum Output Donor Port [Uplink]	-
Nominal Output Server Port [Downlink]	All bands: 33 dBm
Nominal Gain [Uplink]	-
Nominal Gain [Downlink]	All bands: 33 dB

The main components of the EUT are listed and described in chapter 3.2 EUT Main components.



Effective ECL-TA-20-010-V01.00

TA tests on Andrew CAP MX AC 6/7E/80-
85/17E/19/23/25T

3.2 EUT MAIN COMPONENTS

Sample Name	FCC-ID	IC-ID
	XS5-CAPMX	2237E-CAPMX
Sample Parameter	Value	
Serial Number	8	
HW Version	7830127-0001 Rev.: 00	
SW Version	2.9.0.292	
Comment	-----	

NOTE: The short description is used to simplify the identification of the EUT in this test report.

3.3 ANCILLARY EQUIPMENT

For the purposes of this test report, ancillary equipment is defined as equipment which is used in conjunction with the EUT to provide operational and control features to the EUT. It is necessary to configure the system in a typical fashion, as a customer would normally use it. But nevertheless Ancillary Equipment can influence the test results.

Device	Details (Manufacturer, Type Model, OUT Code)	Description
-	-	-



EfectiveECL-TA-20-010-V01.00

TA tests on Andrew CAP MX AC 6/7E/80-
85/17E/19/23/25T

3.4 AUXILIARY EQUIPMENT

For the purposes of this test report, auxiliary equipment is defined as equipment which is used temporarily to enable operational and control features especially used for the tests of the EUT which is not used during normal operation or equipment that is used during the tests in combination with the EUT but is not subject of this test report. It is necessary to configure the system in a typical fashion, as a customer would normally use it. But nevertheless Auxiliary Equipment can influence the test results.

Device	Details (Manufacturer; Type; S/N)	Description
AUX1	Commscope/General Electric; ION-E PSU Shelf, AC; DM77662	Rack in Conjunction with AUX 2
AUX2	Commscope/General Electric; Power Supply Unit; LBGPE17KZ39047532	Power Supply
AUX3	Commscope; ION-E WCS-2; SZAEAJ1952A0032	Subrack in Conjunction with AUX 4, 5,6, 7 and 8
AUX4	Commscope; ION-E OPT; SZBEAD1951A0011	Optical Card
AUX5	Commscope; ION-E SUI; SZBEAC1746A0015	LAN System Interface
AUX6	Commscope; ION-E RFD; SZBEAP1920A0057	RF Card
AUX7	Commscope; ION-E RFD; SZBEAP1924A0023	RF Card
AUX 8	Commscope; ION-E RFD; SZBEAP1946A0003	RF Card



Effective ECL-TA-20-010-V01.00

TA tests on Andrew CAP MX AC 6/7E/80-85/17E/19/23/25T

3.5 EUT SETUPS

This chapter describes the combination of EUTs and equipment used for testing. The rationale for selecting the EUTs, ancillary and auxiliary equipment and interconnecting cables, is to test a representative configuration meeting the requirements of the referenced standards.

Setup	Combination of EUTs	Description and Rationale
		Setup for all tests

OPERATING MODES

This chapter describes the operating modes of the EUT used for testing.

3.5.1 TEST CHANNELS

Band	Direction	Lower Frequency Band Edge [MHz]	Upper Frequency Band Edge [MHz]	Center Frequency [MHz]	Port
30, WCS 2300	Downlink	2350.00	2360.00	2355.00	Donor

3.5.2 AUTOMATIC GAIN CONTROL LEVELS

AGC Levels							
Band	Direction	Signal Type	AGC Start Pin [dBm]	AGC Start Pin -0.3 dB [dBm]	AGC Start Pin +3 dB [dBm]	Frequency [MHz]	Frequency
30, WCS 2300	Downlink	Narrowband	-2.1	-2.4	0.9	2355.00	Mid
30, WCS 2300	Downlink	Wideband	-2.1	-2.4	0.9	2355.00	
30, WCS 2300	Downlink	Narrowband	-1.8	-2.1	1.2	2350.20	Low
30, WCS 2300	Downlink	Wideband	-2.1	-2.4	0.9	2352.50	
30, WCS 2300	Downlink	Narrowband	-1.8	-2.1	1.2	2359.80	High
30, WCS 2300	Downlink	Wideband	-2.0	-2.3	1.0	2357.50	
30, WCS 2300	Downlink	Narrowband	-2.0	-2.3	1.0	2357.60	Max.Power
30, WCS 2300	Downlink	Wideband	-2.0	-2.3	1.0	2357.50	

Remark:

If the measured frequency f_0 for the max power has a too low distance to the band edges, because in the tests modulated signals must be used: The next possible frequency to the according band edge is used.

For example for minimum distances to the band edges:

GSM-Signal (narrowband): 0.2 MHz

AWGN-signal (wideband): 2.5 MHz



BUREAU
VERITAS

EffectiveECL-TA-20-010-V01.00

TA tests on Andrew CAP MX AC 6/7E/80-
85/17E/19/23/25T

3.6 PRODUCT LABELLING

3.6.1 FCC ID LABEL

Please refer to the documentation of the applicant.

3.6.2 LOCATION OF THE LABEL ON THE EUT

Please refer to the documentation of the applicant.



EffectiveECL-TA-20-010-V01.00

TA tests on Andrew CAP MX AC 6/7E/80-85/17E/19/23/25T

4 TEST RESULTS

4.1 EFFECTIVE RADIATED POWER, MEAN OUTPUT POWER AND ZONE ENHANCER GAIN

Standard FCC PART 24, § 27.50

The test was performed according to:
ANSI C63.26, KDB 935210 D05 v01r04: 3.5

Test date: 2020-10-21

Environmental conditions: 23 ° C; 32 % r. F

Test engineer: Thomas Gerngroß

4.1.1 TEST DESCRIPTION

This test case is intended to demonstrate compliance to the signal booster power and gain limits and requirements for industrial signal boosters per FCC § 27.50, RSS-195 with subpart 5.5 and SRSP-516 with subpart 5.1.1.

The EUT was connected to the test setup according to the following diagram:

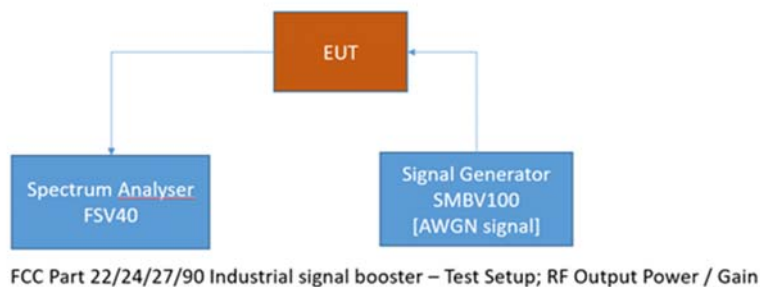

The attenuation of the measuring and stimulus path are known for each measured frequency and are considered.

The Spectrum Analyzer settings can be directly found in the measurement diagrams.



Effective ECL-TA-20-010-V01.00

TA tests on Andrew CAP MX AC 6/7E/80-85/17E/19/23/25T

4.1.2 TEST REQUIREMENTS/LIMITS: ABSTRACTS FROM STANDARDS

Part 27; Miscellaneous Wireless Communication Services

Subpart C – Technical standards

§ 27.50

Abstract § 27.50 from FCC:

(a) The following power limits and related requirements apply to stations transmitting in the 2305-2320 MHz band or the 2345-2360 MHz band.

(1) Base and fixed stations. (i) For base and fixed stations transmitting in the 2305-2315 MHz band or the 2350-2360 MHz band:

(A) The average equivalent isotropically radiated power (EIRP) must not exceed 2,000 watts within any 5 megahertz of authorized bandwidth and must not exceed 400 watts within any 1 megahertz of authorized bandwidth.

Abstract RSS-195 from ISED:

RSS-195; 5.5 Transmitter Output Power and Equivalent Isotropically Radiated Power

The equivalent isotropically radiated power (e.i.r.p.) of base and fixed station equipment shall comply with the e.i.r.p. limit in SRSP-516.

Abstract SRSP-516 from ISED:

SRSP-517; 5.1 Radiated Power Limits and Antenna Height Limit

5.1.1.1

The equivalent isotropically radiated power (e.i.r.p.) of the base and fixed stations³ (with the exception of fixed subscriber stations) operating in the band 2305-2315 MHz or in the band 2350-2360 MHz shall not exceed 400 watts within any 1 MHz band; and shall not exceed 2000 W within any 5 MHz of bandwidth. The peak-to-average power ratio (PAPR) of these transmissions shall comply with the limits specified in RSS-195.



BUREAU
VERITAS

EffectiveECL-TA-20-010-V01.00

TA tests on Andrew CAP MX AC 6/7E/80-85/17E/19/23/25T

4.1.3 MEASUREMENT PLOT

Band: WCS 2300; Frequency: 2357.5 MHz; Band Edge: f0; Mod: AWGN; Input OCBW 0.3 dB < AGC

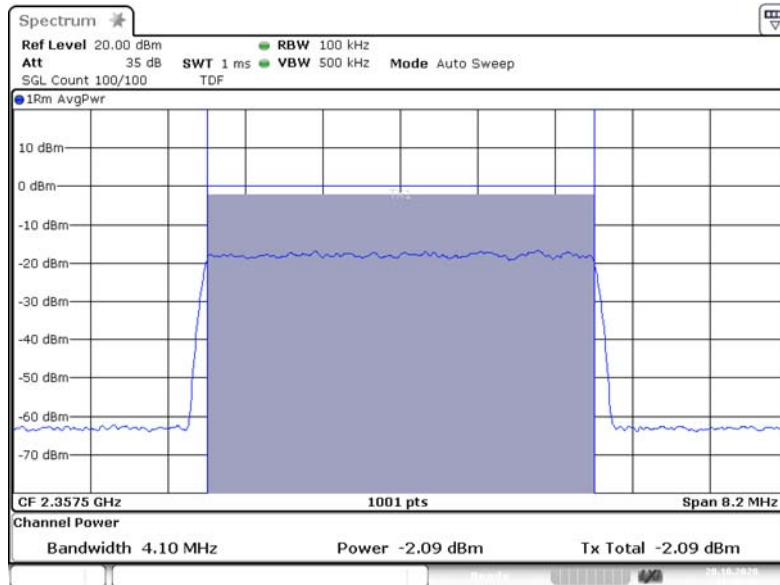

3.5.3 Power AWGN In -0.3 2.35750G

Input Signal



3.5.3 Power AWGN Out -0.3 2.35750G

Output Signal



BUREAU
VERITAS

EffectiveECL-TA-20-010-V01.00

TA tests on Andrew CAP MX AC 6/7E/80-85/17E/19/23/25T

Band: WCS 2300; Frequency: 2357.5 MHz; Band Edge: f0; Mod: AWGN; Input OCBW 3 dB > AGC

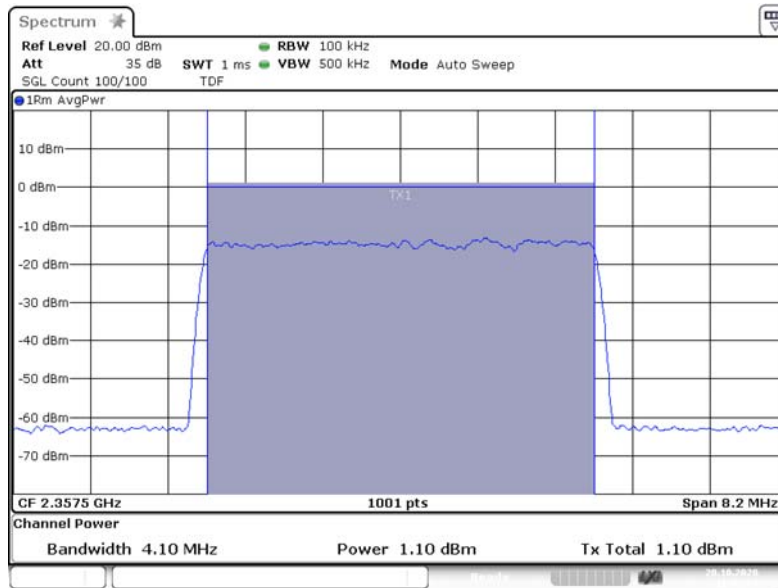

3.5.3 Power AWGN In +3 2.35750G

Input Signal

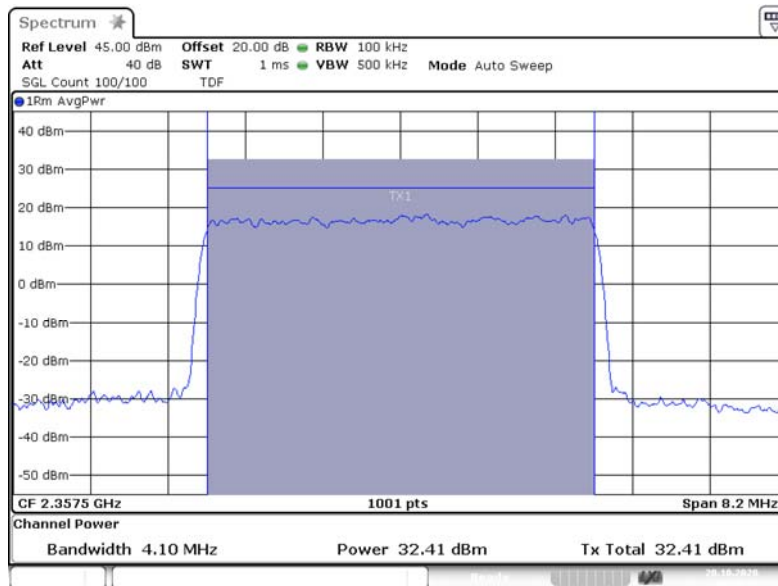

3.5.3 Power AWGN Out +3 2.35750G

Output Signal



BUREAU
VERITAS

EffectiveECL-TA-20-010-V01.00

TA tests on Andrew CAP MX AC 6/7E/80-85/17E/19/23/25T

Band: WCS 2300; Frequency: 2357.6 MHz; Band Edge: f0; Mod: GSM; Input OCBW 0.3 dB < AGC

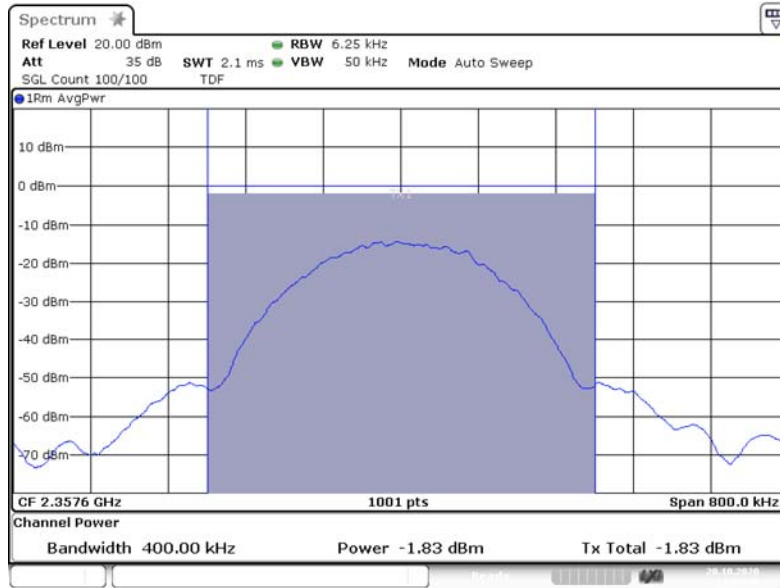

Input Signal



Output Signal



BUREAU
VERITAS

EffectiveECL-TA-20-010-V01.00

TA tests on Andrew CAP MX AC 6/7E/80-85/17E/19/23/25T

Band: WCS 2300; Frequency: 2357.6 MHz; Band Edge: f0; Mod: GSM; Input OCBW 3 dB > AGC

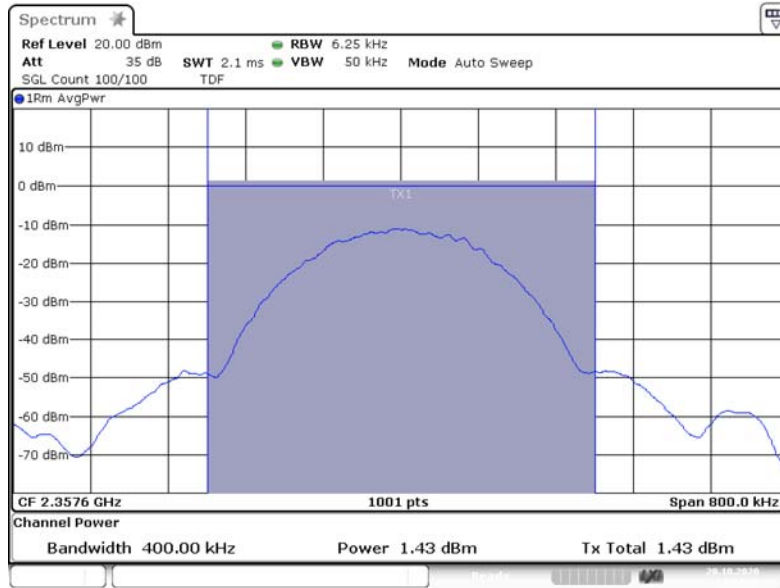

3.5.3 Power GSM In +3 2.35760G

Input Signal

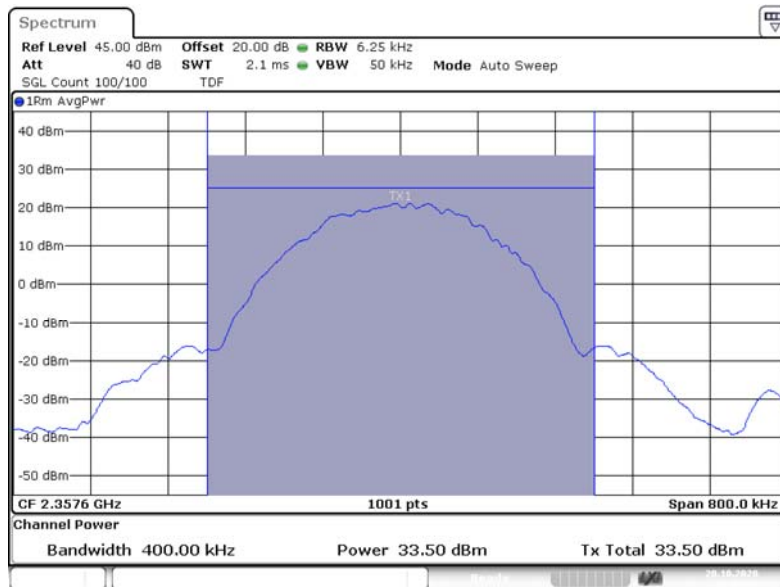

3.5.3 Power GSM Out +3 2.35760G



Effective ECL-TA-20-010-V01.00

TA tests on Andrew CAP MX AC 6/7E/80-85/17E/19/23/25T

4.1.4 TEST PROTOCOL

Band 30 WCS 2300, downlink,							
Signal Type	Input Power	Frequency [MHz]	Input Power [dBm]	Maximum Average Output Power [dBm]	Limit Average Output Power [dBm]	Margin to Limit [dB]	Gain [dB]
Wideband	0.3 dB < AGC	2357.50	-2.3	34.1	63.0	28.9	36.4
Wideband	3 dB > AGC	2357.50	1.0	34.8	63.0	28.2	33.8
Narrowband	0.3 dB < AGC	2357.60	-2.3	34.1	56.0	21.9	36.4
Narrowband	3 dB > AGC	2357.60	1.0	34.0	56.0	22.0	33.0

Remarks: Please see next sub-clause for the measurement plot.



BUREAU
VERITAS

EffectiveECL-TA-20-010-V01.00

TA tests on Andrew CAP MX AC 6/7E/80-85/17E/19/23/25T

4.1.5 MEASUREMENT PLOT

Band: WCS 2300; Frequency: 2.5452 GHz; Band Edge: f0; Mod: AWGN; Output Power 0.3 dB < AGC

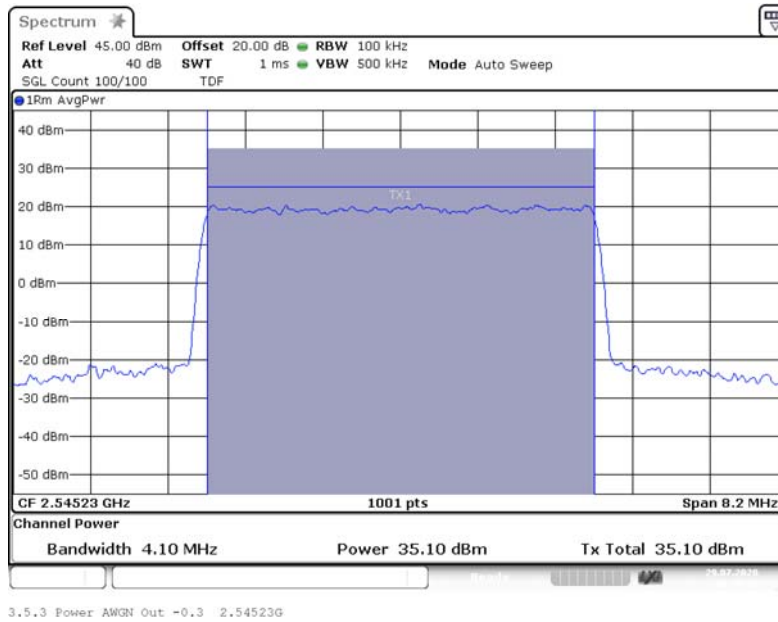

Band: WCS 2300; Frequency: 2.5452 GHz; Band Edge: f0; Mod: AWGN; Output Power 3 dB > AGC





BUREAU
VERITAS

EffectiveECL-TA-20-010-V01.00

TA tests on Andrew CAP MX AC 6/7E/80-
85/17E/19/23/25T

Band: WCS 2300; Frequency: 2.5452 GHz; Band Edge: f0; Mod: GSM; Output Power 0.3 dB < AGC



Band: WCS 2300; Frequency: 2.5452 GHz; Band Edge: f0; Mod: GSM; Output Power 3 dB > AGC



4.1.6 TEST EQUIPMENT USED

- Conducted

EffectiveECL-TA-20-010-V01.00

TA tests on Andrew CAP MX AC 6/7E/80-
85/17E/19/23/25T

4.2 PEAK TO AVERAGE RATIO

Standard FCC PART 24, § 27.50

The test was performed according to:
ANSI C63.26

Test date: 2020-07-07; 2020-07-23

Environmental conditions: 25 ° C; 40 % r. F. (07-07); 25 °C; 42 % r. F. (07-23)

Test engineer: Thomas Hufnagel

4.2.1 TEST DESCRIPTION

This test case is intended to demonstrate compliance to the signal booster power and gain limits and requirements for industrial signal boosters per FCC § 27.50 and RSS-195 with subpart 4.4.

The EUT was connected to the test setup according to the following diagram:

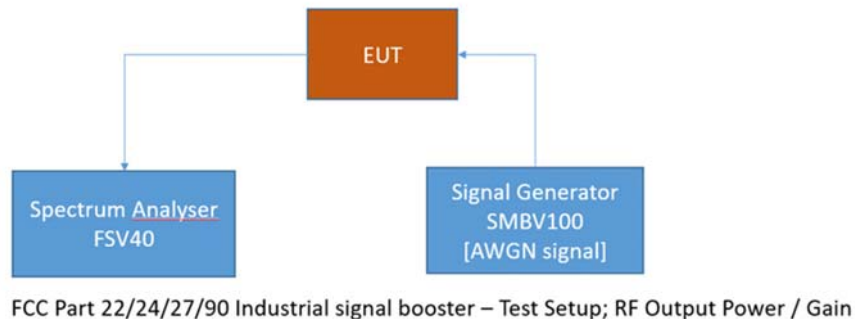

The attenuation of the measuring and stimulus path are known for each measured frequency and are considered.

The Spectrum Analyzer settings can be directly found in the measurement diagrams.



Effective ECL-TA-20-010-V01.00

TA tests on Andrew CAP MX AC 6/7E/80-
85/17E/19/23/25T

4.2.2 TEST REQUIREMENTS/LIMITS

Part 27; Miscellaneous Wireless Communication Services

Subpart C – Technical standards

§ 27.50

Abstract § 27.50 from FCC:

(a) The following power limits and related requirements apply to stations transmitting in the 2305-2320 MHz band or the 2345-2360 MHz band.

(B) The peak-to-average power ratio (PAPR) of the transmitter output power must not exceed 13 dB. The PAPR measurements should be made using either an instrument with complementary cumulative distribution function (CCDF) capabilities to determine that PAPR will not exceed 13 dB for more than 0.1 percent of the time or other Commission approved procedure. The measurement must be performed using a signal corresponding to the highest PAPR expected during periods of continuous transmission.

Abstract RSS-195 from ISED:

RSS-195; 5.5 Transmitter Output Power and Equivalent Isotropically Radiated Power

5.5.1

Peak to Average Power Ratio (PAPR) for Base and Fixed Station Equipment in the Frequency Ranges 2305-2315 MHz and 2350-2360 MHz

The PAPR of the transmitter output power of base and fixed station equipment shall not exceed 13 dB for more than 0.1% of the time, using a signal that corresponds to the highest PAPR during periods of continuous transmission.



Effective ECL-TA-20-010-V01.00

TA tests on Andrew CAP MX AC 6/7E/80-85/17E/19/23/25T

4.2.3 TEST PROTOCOL

Band 30 WCS 2300, downlink						
Signal Type	Input Power	Frequency [MHz]	Input Power [dBm]	PAPR [dB]	Fictive Limit PAPR [dB]	Margin to Fictive Limit [dB]
Wideband	0.3 dB < AGC	2357.50	-2.3	8.8	13.0	4.2
Wideband	3 dB > AGC	2357.50	0.9	8.6	13.0	4.4
Narrowband	0.3 dB < AGC	2355.00	-2.4	0.2	13.0	12.8
Narrowband	3 dB > AGC	2355.00	0.9	0.2	13.0	12.8

Remark: Please see next sub-clause for the measurement plot.



BUREAU
VERITAS

EffectiveECL-TA-20-010-V01.00

TA tests on Andrew CAP MX AC 6/7E/80-85/17E/19/23/25T

4.2.4 MEASUREMENT PLOT (SHOWING THE HIGHEST VALUE, "WORST CASE")

Band: WCS 2300; Frequency: 2.3575 GHz; Band Edge: f0; Mod: AWGN; PAPR 0.3 dB < AGC

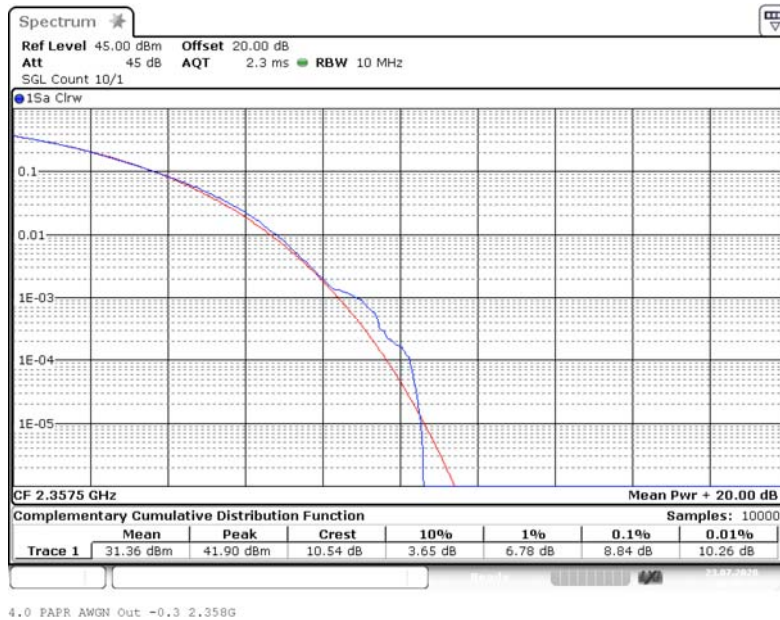

Band: WCS 2300; Frequency: 2.3575 GHz; Band Edge: mid; Mod: AWGN; PAPR 3 dB > AGC

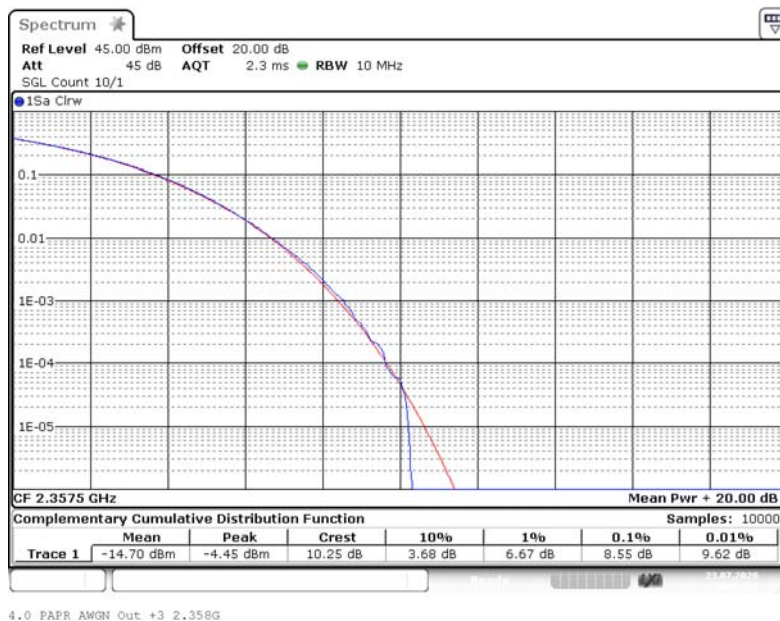



BUREAU
VERITAS

EffectiveECL-TA-20-010-V01.00

TA tests on Andrew CAP MX AC 6/7E/80-85/17E/19/23/25T

Band: WCS 2300; Frequency: 2.3550 GHz; Band Edge: mid; Mod: GSM; PAPR 0.3 dB < AGC

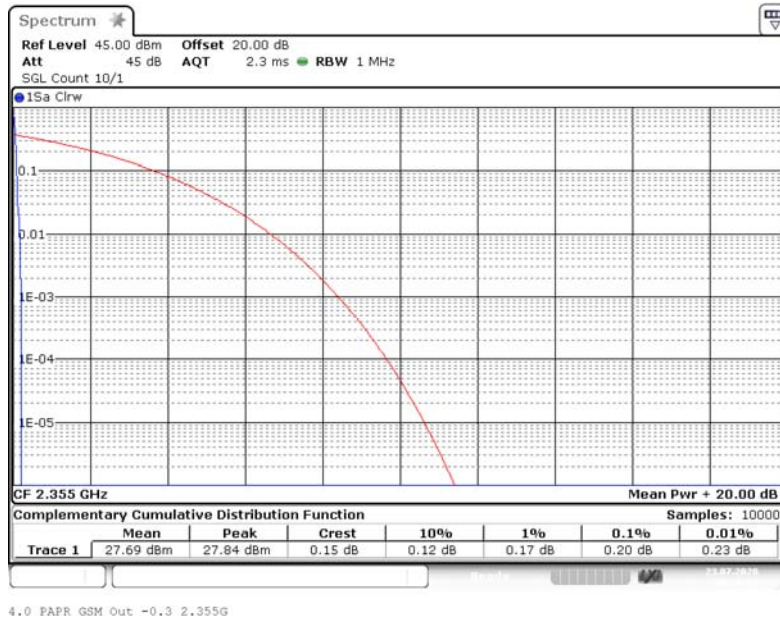

Band: WCS 2300; Frequency: 2.3550 GHz; Band Edge: mid; Mod: GSM; PAPR 3 dB > AGC

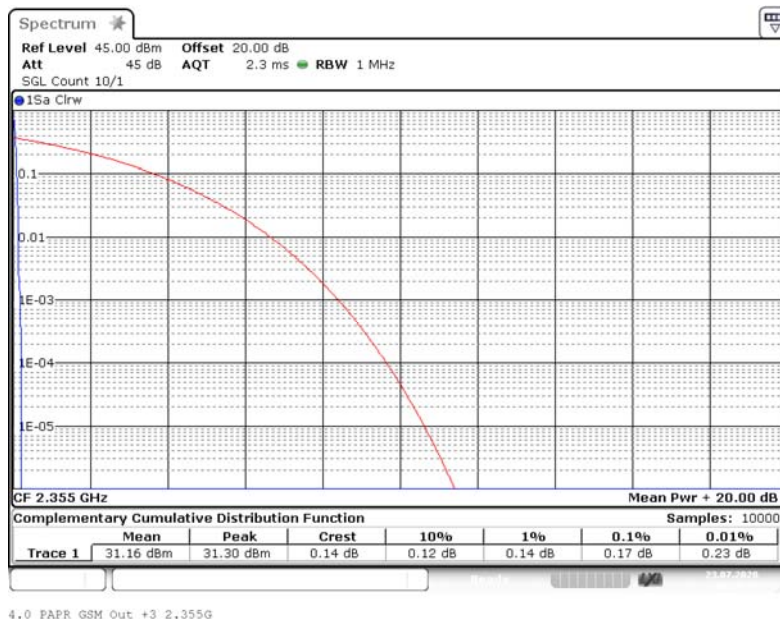

4.2.5 TEST EQUIPMENT USED

- Conducted

EfectiveECL-TA-20-010-V01.00

TA tests on Andrew CAP MX AC 6/7E/80-85/17E/19/23/25T

4.3 OCCUPIED BANDWIDTH/INPUT-VERSUS-OUTPUT SPECTRUM

Standard FCC Part 2.1049; Occupied Bandwidth

The test was performed according to:
ANSI C63.26, KDB 935210 D05 v01r04: 3.4

Test date: 2020-07-23; 2020-07-27

Environmental conditions: 25 ° C; 42 % r. F. (07-23); 25 °C; 41 % r. F. (07-27)

Test engineer: Thomas Hufnagel

4.3.1 TEST DESCRIPTION

This test case is intended to demonstrate compliance to the applicable conducted spurious emission limits per FCC § 2.1049, RSS-GEN with subpart 6.7 and RSS-131 with subpart 5.2.2

The EUT was connected to the test setups according to the following diagram:

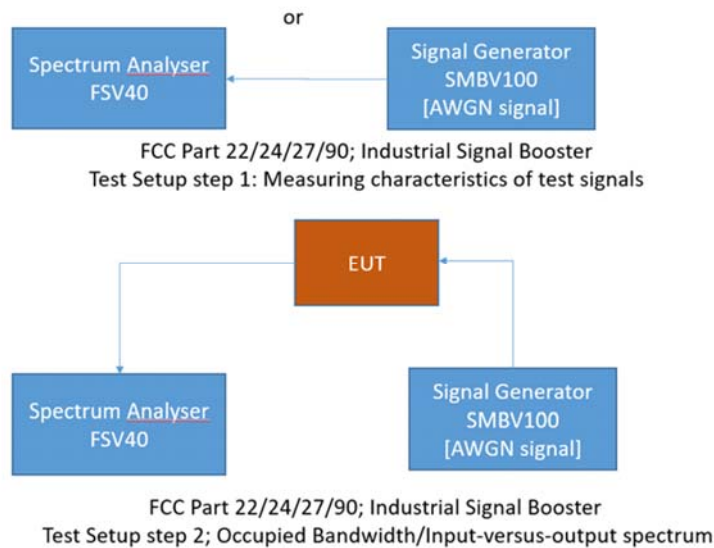

The attenuation of the measuring and stimulus path are known for each measured frequency and are considered.

The Spectrum Analyzer settings can be directly found in the measurement diagrams.



Effective ECL-TA-20-010-V01.00

TA tests on Andrew CAP MX AC 6/7E/80-85/17E/19/23/25T

4.3.2 TEST REQUIREMENTS/LIMITS

Abstract § 2.1049 from FCC:

FCC Part 2.1049; Occupied Bandwidth:

The occupied bandwidth, that is the frequency bandwidth such that, below its lower and above its upper frequency limits, the mean powers radiated are each equal to 0.3 percent of the total mean power radiated by a given emission shall be measured under the following conditions as applicable:

(h) Transmitters employing digital modulation techniques—when modulated by an input signal such that its amplitude and symbol rate represent the maximum rated conditions under which the equipment will be operated. The signal shall be applied through any filter networks, pseudo-random generators or other devices required in normal service. Additionally, the occupied bandwidth shall be shown for operation with any devices used for modifying the spectrum when such devices are optional at the discretion of the user.

(i) Transmitters designed for other types of modulation—when modulated by an appropriate signal of sufficient amplitude to be representative of the type of service in which used. A description of the input signal should be supplied.

Abstract RSS-GEN from ISED:

RSS-GEN; 6.7 Occupied Bandwidth

The occupied bandwidth or the “99% emission bandwidth” is defined as the frequency range between two points, one above and the other below the carrier frequency, within which 99% of the total transmitted power of the fundamental transmitted emission is contained. The occupied bandwidth shall be reported for all equipment in addition to the specified bandwidth required in the applicable RSSs.

In some cases, the “x dB bandwidth” is required, which is defined as the frequency range between two points, one at the lowest frequency below and one at the highest frequency above the carrier frequency, at which the maximum power level of the transmitted emission is attenuated x dB below the maximum in-band power level of the modulated signal, where the two points are on the outskirts of the in-band emission.

The following conditions shall be observed for measuring the occupied bandwidth and x dB bandwidth:

- The transmitter shall be operated at its maximum carrier power measured under normal test conditions.
- The span of the spectrum analyzer shall be set large enough to capture all products of the modulation process, including the emission skirts, around the carrier frequency, but small enough to avoid having other emissions (e.g. on adjacent channels) within the span.



BUREAU
VERITAS

Effective ECL-TA-20-010-V01.00

TA tests on Andrew CAP MX AC 6/7E/80-
85/17E/19/23/25T

- The detector of the spectrum analyzer shall be set to "Sample". However, a peak, or peak hold, may be used in place of the sampling detector since this usually produces a wider bandwidth than the actual bandwidth (worst-case measurement). Use of a peak hold (or "Max Hold") may be necessary to determine the occupied / x dB bandwidth if the device is not transmitting continuously.
- The resolution bandwidth (RBW) shall be in the range of 1% to 5% of the actual occupied / x dB bandwidth and the video bandwidth (VBW) shall not be smaller than three times the RBW value. Video averaging is not permitted.

For the 99% emission bandwidth, the trace data points are recovered and directly summed in linear power level terms. The recovered amplitude data points, beginning at the lowest frequency, are placed in a running sum until 0.5% of the total is reached, and that frequency recorded. The process is repeated for the highest frequency data points (starting at the highest frequency, at the right side of the span, and going down in frequency). This frequency is then recorded. The difference between the two recorded frequencies is the occupied bandwidth (or the 99% emission bandwidth).

Abstract RSS-130 from ISED:

RSS-131; 5.2.2 Input-versus-output spectrum

The spectral growth of the 26 dB bandwidth of the output signal shall be less than 5% of the input signal spectrum.



EffectiveECL-TA-20-010-V01.00

TA tests on Andrew CAP MX AC 6/7E/80-
85/17E/19/23/25T

4.3.3 TEST PROTOCOL

Band 30 WCS 2300, downlink							
Signal Type	Input Power	Signal Frequency [MHz]	Occupied Bandwidth SG [kHz]	Occupied Bandwidth Booster [kHz]	Delta Occupied Bandwidth [kHz]	Limit Delta Occupied Bandwidth [kHz]	Margin to Limit [kHz]
Wideband	0.3 dB < AGC	2355.00	4336.5	4334.1	2.4	205.0	202.6
Wideband	3 dB > AGC	2355.00	4334.1	4335.3	1.2	205.0	203.8
Narrowband	0.3 dB < AGC	2355.00	316.3	318.6	2.3	10.0	7.7
Narrowband	3 dB > AGC	2355.00	319.3	320.9	1.6	10.0	8.4

Remark: Please see next sub-clause for the measurement plot.



BUREAU VERITAS

EffectiveECL-TA-20-010-V01.00

TA tests on Andrew CAP MX AC 6/7E/80-85/17E/19/23/25T

4.3.4 MEASUREMENT PLOT

Band: WCS 2300; Frequency: 2355.0 MHz; Band Edge: mid; Mod: AWGN; Input OCBW 0.3 dB < AGC

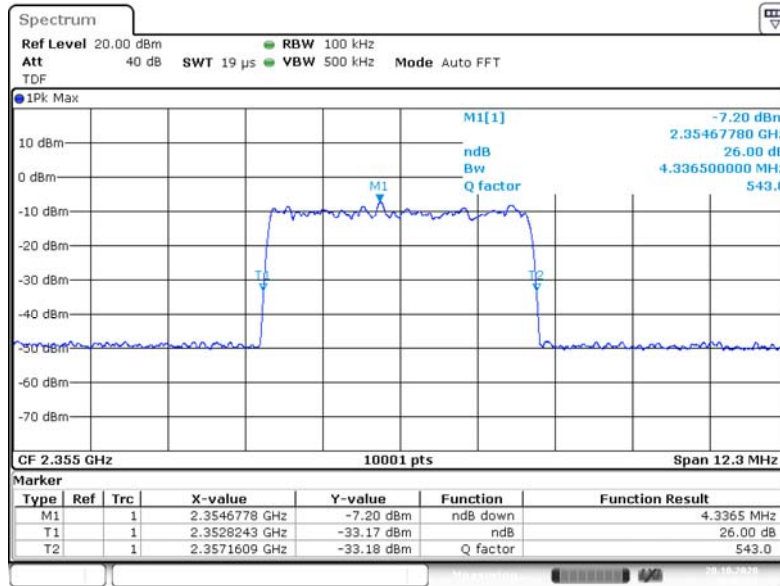

3.4 OCBw AWGN In -0.3 2.3550G _26dB

Input Signal

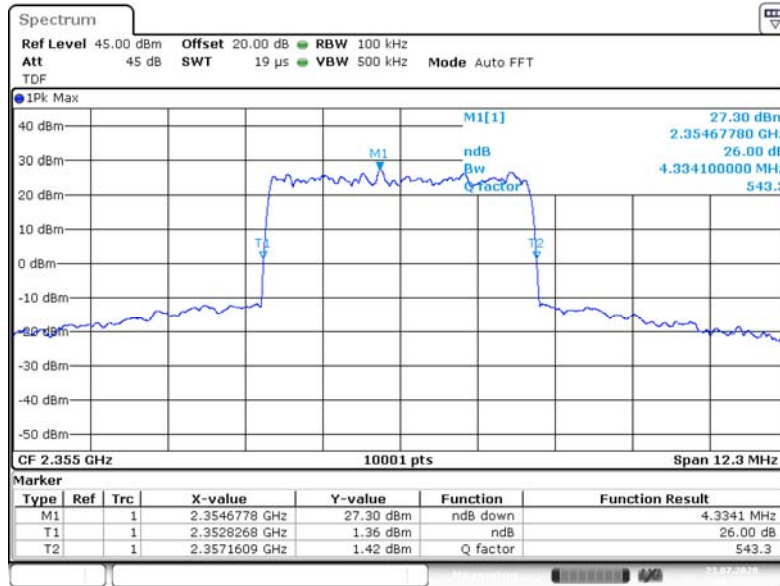

3.4 OCBw AWGN Out -0.3 2.3550G _26dB

Output Signal



BUREAU VERITAS

EffectiveECL-TA-20-010-V01.00

TA tests on Andrew CAP MX AC 6/7E/80-85/17E/19/23/25T

Band: WCS 2300; Frequency: 2355.0 MHz; Band Edge: mid; Mod: AWGN; Input OCBW 3 dB > AGC

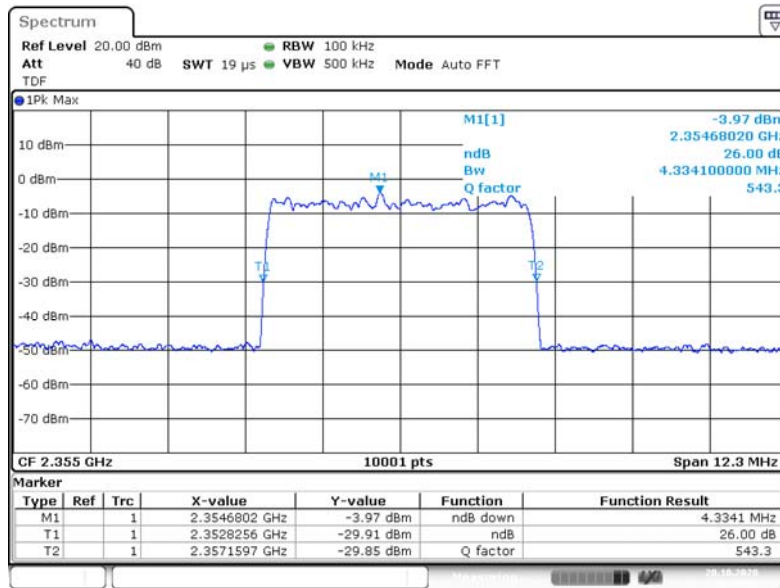

3.4 OCBw AWGN In +3 2.3550G _26dB

Input Signal

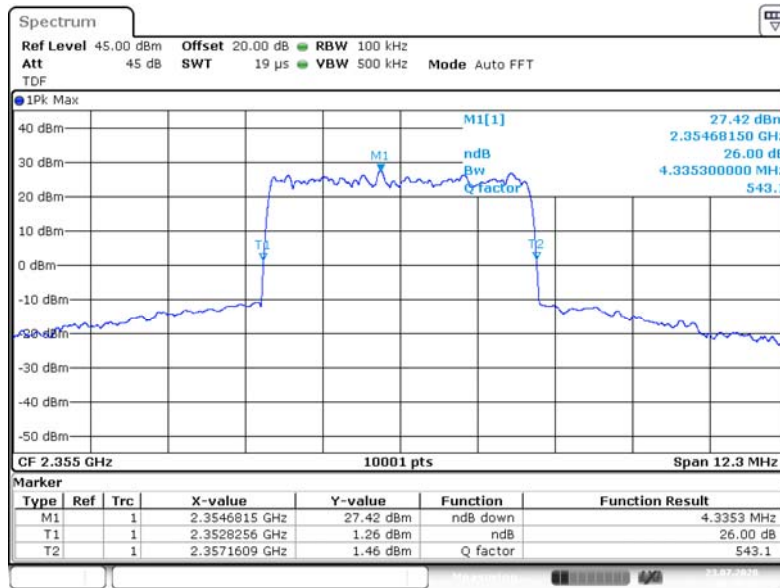

3.4 OCBw AWGN Out +3 2.3550G _26dB

Output Signal



**BUREAU
VERITAS**

EfectiveECL-TA-20-010-V01.00

TA tests on Andrew CAP MX AC 6/7E/80-85/17E/19/23/25T

Band: WCS 2300; Frequency: 2355.0 MHz; Band Edge: mid; Mod: GSM; Input OCBW 0.3 dB < AGC

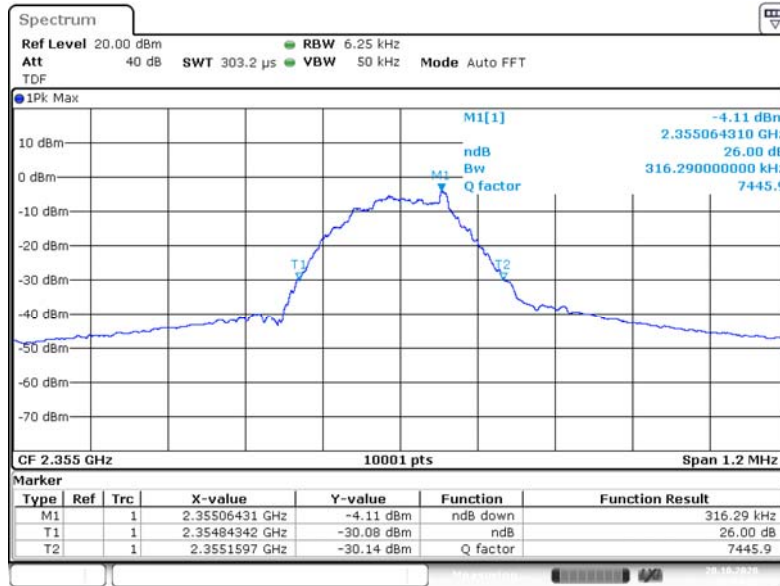

3.4 OCBw GSM In -0.3 2.3550G _26dB

Input Signal

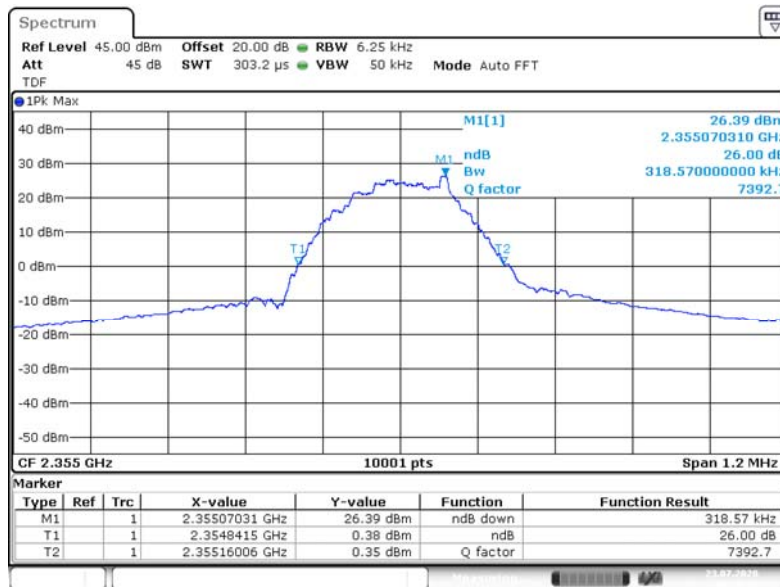

3.4 OCBw GSM Out -0.3 2.3550G _26dB

Output Signal



BUREAU VERITAS

EffectiveECL-TA-20-010-V01.00

TA tests on Andrew CAP MX AC 6/7E/80-85/17E/19/23/25T

Band: WCS 2300; Frequency: 2355.0 MHz; Band Edge: mid; Mod: GSM; Input OCBW 3 dB > AGC

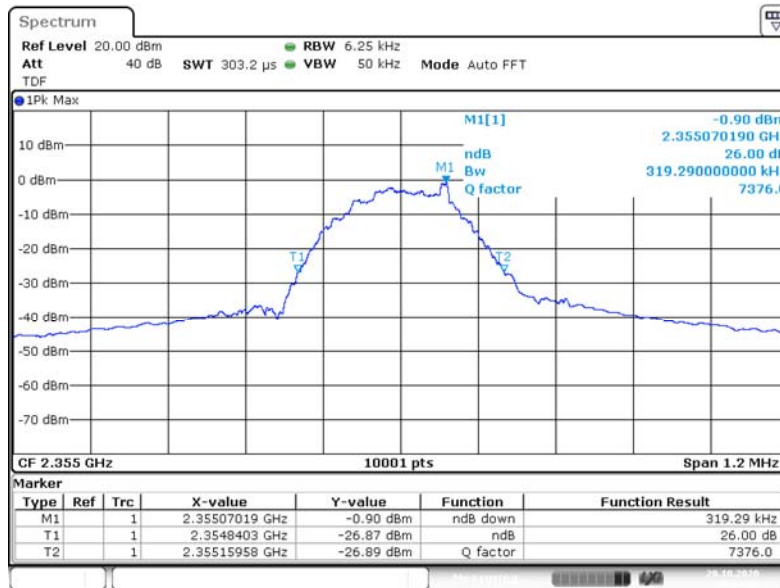

3.4 OCBw GSM In +3 2.3550G _26dB

Input Signal

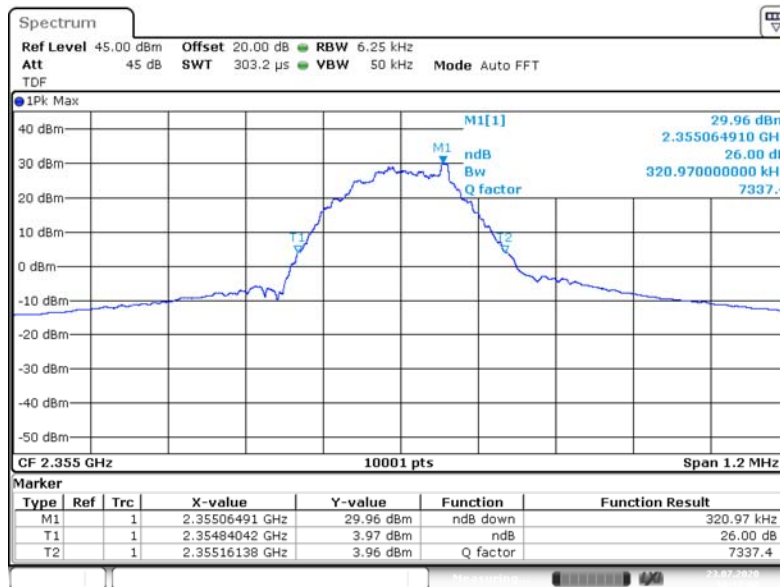

3.4 OCBw GSM Out +3 2.3550G _26dB

4.3.5 TEST EQUIPMENT USED

- Conducted



BUREAU
VERITAS

Effective ECL-TA-20-010-V01.00

TA tests on Andrew CAP MX AC 6/7E/80-
85/17E/19/23/25T

4.4 CONDUCTED SPURIOUS EMISSIONS AT ANTENNA TERMINALS

Standard FCC Part § 2.1051, § 27.53

The test was performed according to:
ANSI C63.26, KDB 935210 D05 v01r04: 3.6

Test date: 2020-09-09

Environmental conditions: 24 ° C; 43 % r. F.

Test engineer: Thomas Hufnagel

4.4.1 TEST DESCRIPTION

This test case is intended to demonstrate compliance to the signal booster power and gain limits and requirements for industrial signal boosters per FCC § 2.1051, FCC § 27.53, RSS-GEN with subpart 6.13 and RSS-199 with subpart 4.5.

The EUT was connected to the test setup according to the following diagram:

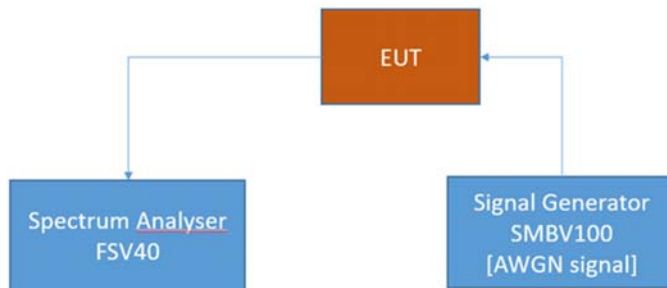

FCC Part 22/24/27/90 Industrial signal booster – Test Setup; RF Output Power / Gain

The attenuation of the measuring and stimulus path are known for each measured frequency and are considered.

The Spectrum Analyzer settings can be directly found in the measurement diagrams.



Effective ECL-TA-20-010-V01.00

TA tests on Andrew CAP MX AC 6/7E/80-85/17E/19/23/25T

4.4.2 TEST REQUIREMENTS/LIMITS

Abstract § 2.1051 from FCC:

FCC Part 2.1051; Measurement required: Spurious emissions at antenna terminal:

The radio frequency voltage or powers generated within the equipment and appearing on a spurious frequency shall be checked at the equipment output terminals when properly loaded with a suitable artificial antenna. Curves or equivalent data shall show the magnitude of each harmonic and other spurious emission that can be detected when the equipment is operated under the conditions specified in § 2.1049 as appropriate. The magnitude of spurious emissions which are attenuated more than 20 dB below the permissible value need not be specified.

Part 27; Miscellaneous Wireless Communication Services

Subpart C – Technical standards

§27.53 – Emission limits

Abstract § 27.53 FCC:

(a) For operations in the 2305-2320 MHz band and the 2345-2360 MHz band, the power of any emission outside a licensee's frequency band(s) of operation shall be attenuated below the transmitter power P (with averaging performed only during periods of transmission) within the licensed band(s) of operation, in watts, by the following amounts:

(1) For base and fixed stations' operations in the 2305-2320 MHz band and the 2345-2360 MHz band:

(i) By a factor of not less than $43 + 10 \log (P)$ dB on all frequencies between 2305 and 2320 MHz and on all frequencies between 2345 and 2360 MHz that are outside the licensed band(s) of operation, and not less than $75 + 10 \log (P)$ dB on all frequencies between 2320 and 2345 MHz;

(ii) By a factor of not less than $43 + 10 \log (P)$ dB on all frequencies between 2300 and 2305 MHz, $70 + 10 \log (P)$ dB on all frequencies between 2287.5 and 2300 MHz, $72 + 10 \log (P)$ dB on all frequencies between 2285 and 2287.5 MHz, and $75 + 10 \log (P)$ dB below 2285 MHz;

(iii) By a factor of not less than $43 + 10 \log (P)$ dB on all frequencies between 2360 and 2362.5 MHz, $55 + 10 \log (P)$ dB on all frequencies between 2362.5 and 2365 MHz, $70 + 10 \log (P)$ dB on all frequencies between 2365 and 2367.5 MHz, $72 + 10 \log (P)$ dB on all frequencies between 2367.5 and 2370 MHz, and $75 + 10 \log (P)$ dB above 2370 MHz.



Effective ECL-TA-20-010-V01.00

TA tests on Andrew CAP MX AC 6/7E/80-
85/17E/19/23/25T

(2) For fixed customer premises equipment (CPE) stations operating in the 2305-2320 MHz band and the 2345-2360 MHz band transmitting with more than 2 watts per 5 megahertz average EIRP:

(i) By a factor of not less than $43 + 10 \log (P)$ dB on all frequencies between 2305 and 2320 MHz and on all frequencies between 2345 and 2360 MHz that are outside the licensed band(s) of operation, and not less than $75 + 10 \log (P)$ dB on all frequencies between 2320 and 2345 MHz;

(ii) By a factor of not less than $43 + 10 \log (P)$ dB on all frequencies between 2300 and 2305 MHz, $70 + 10 \log (P)$ dB on all frequencies between 2287.5 and 2300 MHz, $72 + 10 \log (P)$ dB on all frequencies between 2285 and 2287.5 MHz, and $75 + 10 \log (P)$ dB below 2285 MHz;

(iii) By a factor of not less than $43 + 10 \log (P)$ dB on all frequencies between 2360 and 2362.5 MHz, $55 + 10 \log (P)$ dB on all frequencies between 2362.5 and 2365 MHz, $70 + 10 \log (P)$ dB on all frequencies between 2365 and 2367.5 MHz, $72 + 10 \log (P)$ dB on all frequencies between 2367.5 and 2370 MHz, and $75 + 10 \log (P)$ dB above 2370 MHz.

(3) For fixed CPE stations operating in the 2305-2320 MHz and 2345-2360 MHz bands transmitting with 2 watts per 5 megahertz average EIRP or less:

(i) By a factor of not less than $43 + 10 \log (P)$ dB on all frequencies between 2305 and 2320 MHz and on all frequencies between 2345 and 2360 MHz that are outside the licensed band(s) of operation, not less than $55 + 10 \log (P)$ dB on all frequencies between 2320 and 2324 MHz and between 2341 and 2345 MHz, not less than $61 + 10 \log (P)$ dB on all frequencies between 2324 and 2328 MHz and between 2337 and 2341 MHz, and not less than $67 + 10 \log (P)$ dB on all frequencies between 2328 and 2337 MHz;

(ii) By a factor of not less than $43 + 10 \log (P)$ dB on all frequencies between 2300 and 2305 MHz, $55 + 10 \log (P)$ dB on all frequencies between 2296 and 2300 MHz, $61 + 10 \log (P)$ dB on all frequencies between 2292 and 2296 MHz, $67 + 10 \log (P)$ dB on all frequencies between 2288 and 2292 MHz, and $70 + 10 \log (P)$ dB below 2288 MHz;

(iii) By a factor of not less than $43 + 10 \log (P)$ dB on all frequencies between 2360 and 2365 MHz, and not less than $70 + 10 \log (P)$ dB above 2365 MHz.



Effective ECL-TA-20-010-V01.00

TA tests on Andrew CAP MX AC 6/7E/80-85/17E/19/23/25T

Abstract RSS-199 from ISED:

RSS-195; 5.6 Transmitter unwanted emissions

The transmitter unwanted emissions shall be measured with a resolution bandwidth of 1 MHz. A smaller resolution bandwidth is permitted provided that the measured power is integrated over the full required measurement bandwidth of 1 MHz. However, in the 1 MHz bands immediately adjacent to the edges of the frequency range(s) in which the equipment is allowed to operate, a resolution bandwidth of as close as possible to, without being less than 1% of the occupied bandwidth, shall be employed provided that the measured power is integrated over the full required measurement bandwidth of 1 MHz.

5.6.1 Base Station, Fixed Station and High-Power Fixed Subscriber Equipment

Equipment shall comply with the following unwanted emission limits:

The power of any emission outside the frequency range(s) in which the equipment operates shall be attenuated below the transmitter power, P(dBW), by the amount indicated in Table 1 and graphically represented in Figure 1, where p is the transmitter output power measured in watts.

Table 1 — Unwanted Emissions for Base Station, Fixed Station and High-Power Fixed Subscriber Equipment

Table 1 — Unwanted Emissions for Base Station, Fixed Station and High-Power Fixed Subscriber Equipment

Frequency (MHz)	Attenuation (dB)
<2200	$43 + 10 \log_{10}(p)$
2200 - 2285	$75 + 10 \log_{10}(p)$
2285 - 2287.5	$72 + 10 \log_{10}(p)$
2287.5 - 2300	$70 + 10 \log_{10}(p)$
2300 - 2305	$43 + 10 \log_{10}(p)$
2305 - 2320	$43 + 10 \log_{10}(p)$ ^{Note}
2320 - 2345	$75 + 10 \log_{10}(p)$
2345 - 2360	$43 + 10 \log_{10}(p)$ ^{Note}
2360 - 2362.5	$43 + 10 \log_{10}(p)$
2362.5 - 2365	$55 + 10 \log_{10}(p)$
2365 - 2367.5	$70 + 10 \log_{10}(p)$
2367.5 - 2370	$72 + 10 \log_{10}(p)$
2370 - 2395	$75 + 10 \log_{10}(p)$
>2395	$43 + 10 \log_{10}(p)$

Note: Measured at the edges of the highest and lowest frequency range(s) in which the equipment is designed to operate. See Section 5.2 for the permitted frequency ranges for the various equipment types.



EffectiveECL-TA-20-010-V01.00

TA tests on Andrew CAP MX AC 6/7E/80-85/17E/19/23/25T

4.4.3 TEST PROTOCOL

Band 30, WCS 2300, downlink							
Test Frequency	Signal Type	Spurious Freq. [MHz]	Spurious Level [dBm]	Detector	RBW [kHz]	Limit [dBm]	Margin to Limit [dB]
low	Wideband	0.019506	-58.6	RMS	1	-33	25.6
low	Wideband	0.0524996	-51.0	RMS	10	-23	28.0
low	Wideband	69.8208	-44.9	RMS	100	-13	31.9
low	Wideband	892.3576	-35.3	RMS	1000	-13	22.3
low	Wideband	1811.9	-36.7	RMS	1000	-13	23.7
low	Wideband	2349.0	-35.4	RMS	100	-13	22.4
low	Wideband	2361.0	-42.9	RMS	100	-13	29.9
low	Wideband	6933.5	-31.1	RMS	1000	-13	18.1
low	Wideband	19590.8	-30.9	RMS	1000	-13	17.9
low	Wideband	20295.2	-30.0	RMS	1000	-13	17.0
mid	Wideband	0.0487917	-58.4	RMS	1	-33	25.4
mid	Wideband	0.0524996	-50.3	RMS	10	-23	27.3
mid	Wideband	122.7651	-45.4	RMS	100	-13	32.4
mid	Wideband	890.3596	-35.8	RMS	1000	-13	22.8
mid	Wideband	2207.3	-36.8	RMS	1000	-13	23.8
mid	Wideband	2320.3	-38.9	RMS	100	-13	25.9
mid	Wideband	2361.3	-37.1	RMS	100	-13	24.1
mid	Wideband	6949.4	-31.3	RMS	1000	-13	18.3
mid	Wideband	19582.3	-30.6	RMS	1000	-13	17.6
mid	Wideband	20317.2	-30.0	RMS	1000	-13	17.0
high	Wideband	0.0097168	-61.4	RMS	1	-33	28.4
high	Wideband	0.0774954	-54.7	RMS	10	-23	31.7
high	Wideband	120.2154	-45.2	RMS	100	-13	32.2
high	Wideband	892.8572	-34.7	RMS	1000	-13	21.7
high	Wideband	2123.8	-36.6	RMS	1000	-13	23.6
high	Wideband	2347.8	-42.9	RMS	100	-13	29.9
high	Wideband	2362.7	-45.8	RMS	100	-13	32.8
high	Wideband	6842.5	-31.4	RMS	1000	-13	18.4
high	Wideband	19581.3	-30.9	RMS	1000	-13	17.9
high	Wideband	20298.7	-30.0	RMS	1000	-13	17.0



EffectiveECL-TA-20-010-V01.00

TA tests on Andrew CAP MX AC 6/7E/80-85/17E/19/23/25T

Band 30, WCS 2300, downlink							
Test Frequency	Signal Type	Spurious Freq. [MHz]	Spurious Level [dBm]	Detector	RBW [kHz]	Limit [dBm]	Margin to Limit [dB]
low	Narrowband	0.0097168	-61.4	RMS	1	-33	28.4
low	Narrowband	0.0774954	-54.7	RMS	10	-23	31.7
low	Narrowband	120.2154	-45.2	RMS	100	-13	32.2
low	Narrowband	892.8572	-34.7	RMS	1000	-13	21.7
low	Narrowband	2123.8	-36.6	RMS	1000	-13	23.6
low	Narrowband	2347.8	-42.9	RMS	100	-13	29.9
low	Narrowband	2362.7	-45.8	RMS	100	-13	32.8
low	Narrowband	6842.5	-31.4	RMS	1000	-13	18.4
low	Narrowband	19581.3	-30.9	RMS	1000	-13	17.9
low	Narrowband	20298.7	-30.0	RMS	1000	-13	17.0
mid	Narrowband	0.0090205	-60.4	RMS	1	-33	27.4
mid	Narrowband	0.0774954	-54.7	RMS	10	-23	31.7
mid	Narrowband	67.121	-45.4	RMS	100	-13	32.4
mid	Narrowband	890.3596	-34.8	RMS	1000	-13	21.8
mid	Narrowband	2087.3	-36.0	RMS	1000	-13	23.0
mid	Narrowband	2341.6	-45.2	RMS	100	-13	32.2
mid	Narrowband	2361.2	-45.7	RMS	100	-13	32.7
mid	Narrowband	6828.0	-30.9	RMS	1000	-13	17.9
mid	Narrowband	19540.8	-30.7	RMS	1000	-13	17.7
mid	Narrowband	20315.7	-29.8	RMS	1000	-13	16.8
high	Narrowband	0.0090205	-60.5	RMS	1	-33	27.5
high	Narrowband	0.0724962	-55.0	RMS	10	-23	32.0
high	Narrowband	66.8711	-45.1	RMS	100	-13	32.1
high	Narrowband	847.9021	-34.9	RMS	1000	-13	21.9
high	Narrowband	2107.3	-36.8	RMS	1000	-13	23.8
high	Narrowband	2348.5	-44.0	RMS	100	-13	31.0
high	Narrowband	2362.2	-44.6	RMS	100	-13	31.6
high	Narrowband	6909.0	-31.3	RMS	1000	-13	18.3
high	Narrowband	19540.8	-31.1	RMS	1000	-13	18.1
high	Narrowband	20312.7	-29.9	RMS	1000	-13	16.9

Remark: Please see next sub-clause for the measurement plot.



BUREAU
VERITAS

Effective ECL-TA-20-010-V01.00

TA tests on Andrew CAP MX AC 6/7E/80-
85/17E/19/23/25T

General considerations concerning the measurement plots:

The measuring bandwidth of 100 kHz was chosen according to the test requirements except at the band edges: At the band edges reducing of measurement bandwidth was necessary to prevent overlaying the RF-signal over the spurious emissions.

Also outside the downlink frequency band at lower frequencies the measurement bandwidths were reduced to have the possibility to record the spurious emissions at these lower frequencies.

At frequencies where measuring bandwidths were reduced also the border lines were reduced according to the given formula:

$$p_{RBW_{reduced}} [dBm] = 10 * \log \left(\frac{RBW_{reduced} [kHz] - 100 \text{ kHz}}{100 \text{ kHz}} \right) + p_{RBW 100 \text{ kHz}} [dBm]$$

Hereby "p" are the border lines' values.



EffectiveECL-TA-20-010-V01.00

TA tests on Andrew CAP MX AC 6/7E/80-
85/17E/19/23/25T

4.4.4 MEASUREMENT PLOT (SHOWING THE HIGHEST VALUE, "WORST CASE")

Frequency Band = WCS 2300, Test Frequency = low, Direction = RF downlink, Signal Type = AWGN

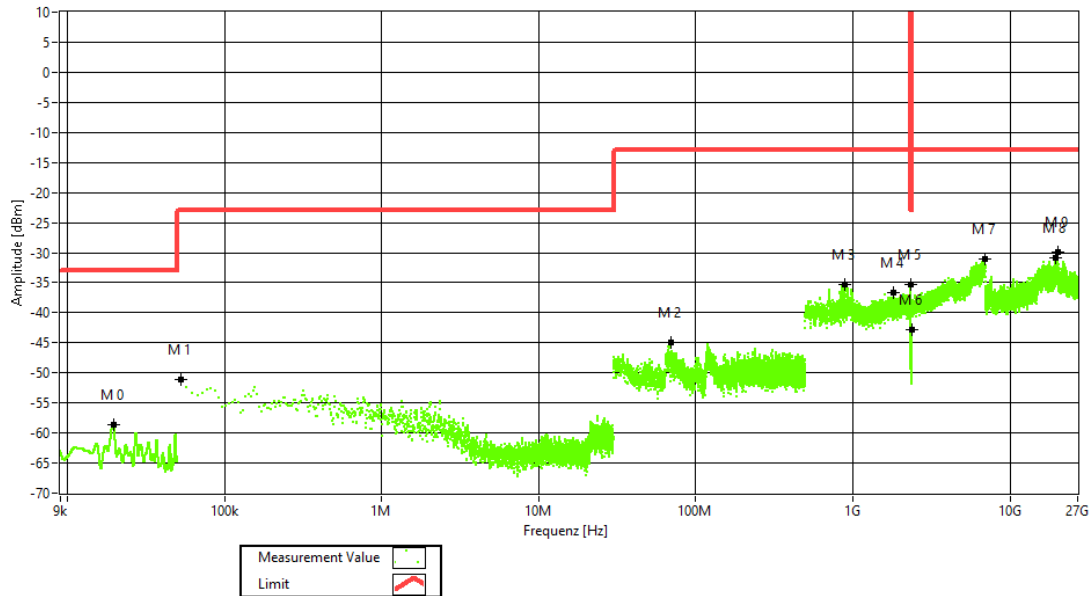

Frequency Band = WCS 2300, Test Frequency = mid, Direction = RF downlink, Signal Type = AWGN

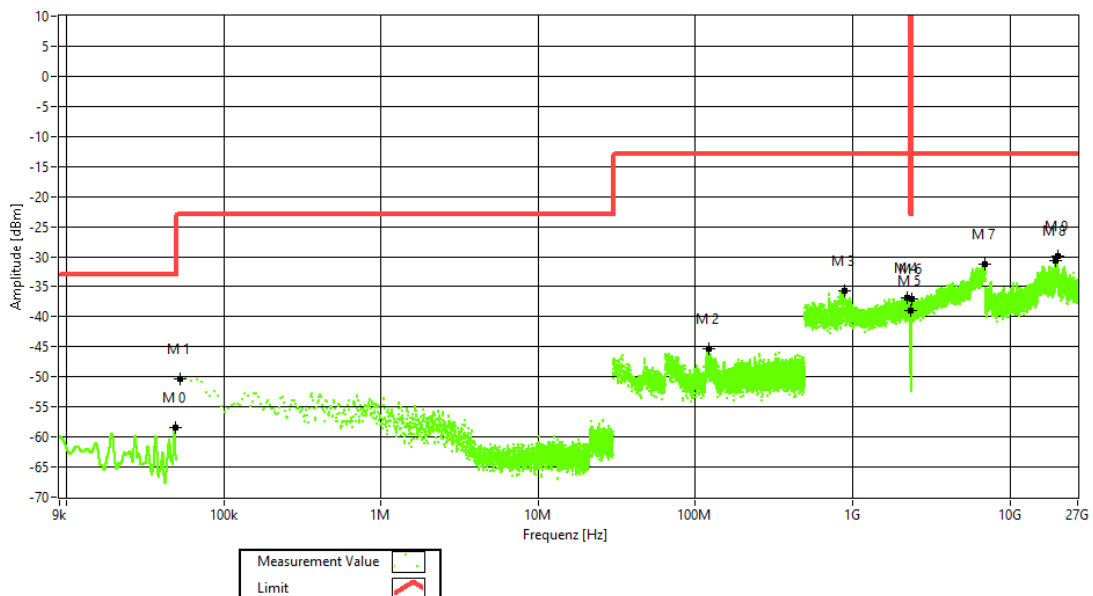



BUREAU
VERITAS

EffectiveECL-TA-20-010-V01.00

TA tests on Andrew CAP MX AC 6/7E/80-
85/17E/19/23/25T

Frequency Band = WCS 2300, Test Frequency = high, Direction = RF downlink, Signal Type =
AWGN

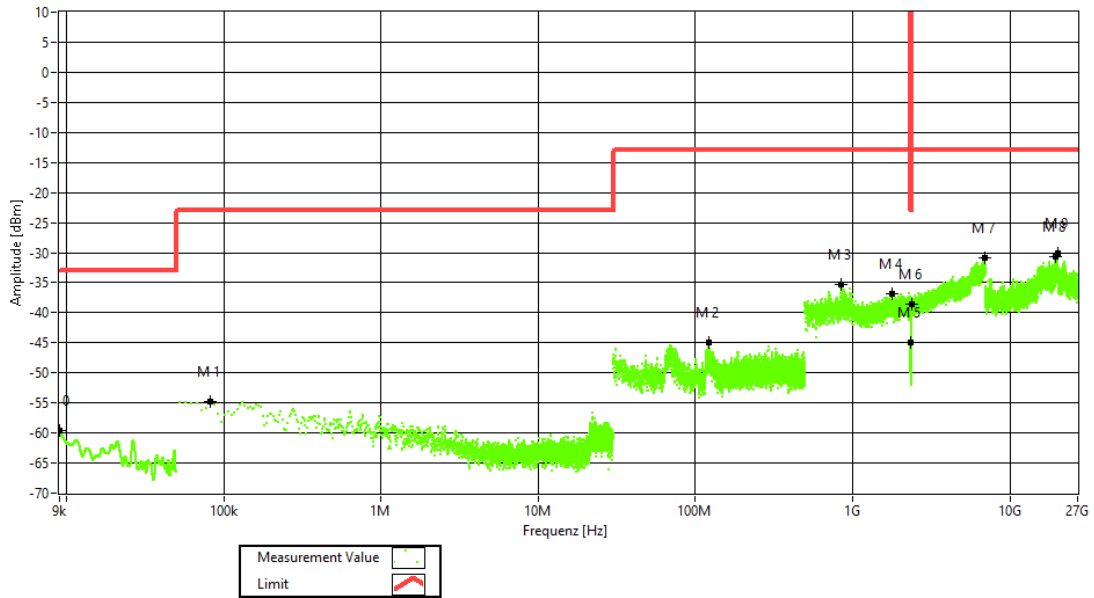



**BUREAU
VERITAS**

EffectiveECL-TA-20-010-V01.00

TA tests on Andrew CAP MX AC 6/7E/80-
85/17E/19/23/25T

Frequency Band = WCS 2300, Test Frequency = low, Direction = RF downlink, Signal Type = GSM

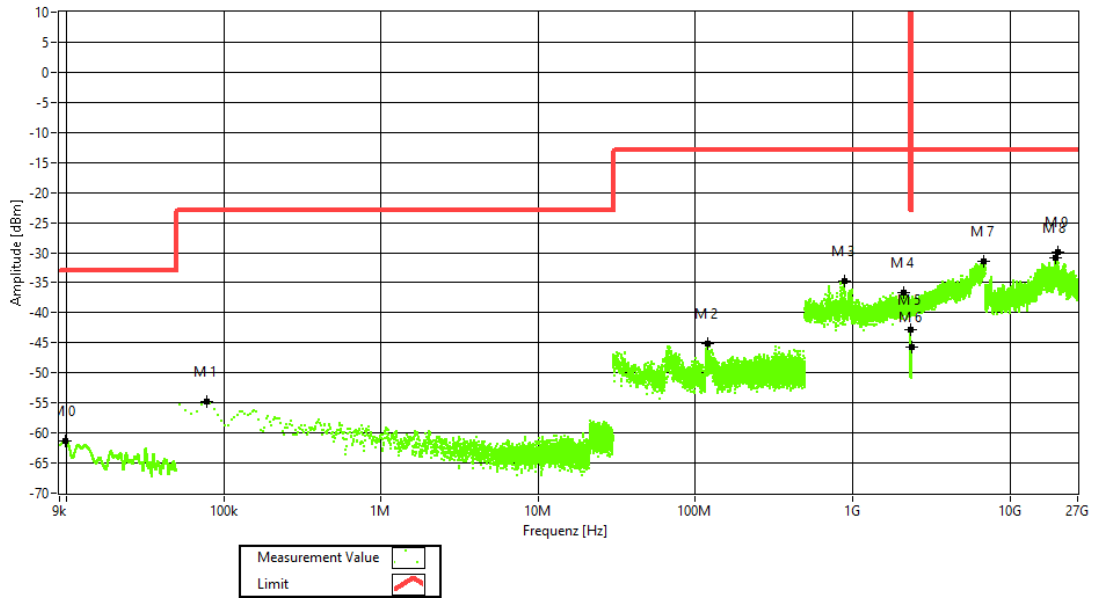

Frequency Band = WCS 2300, Test Frequency = mid, Direction = RF downlink, Signal Type = GSM

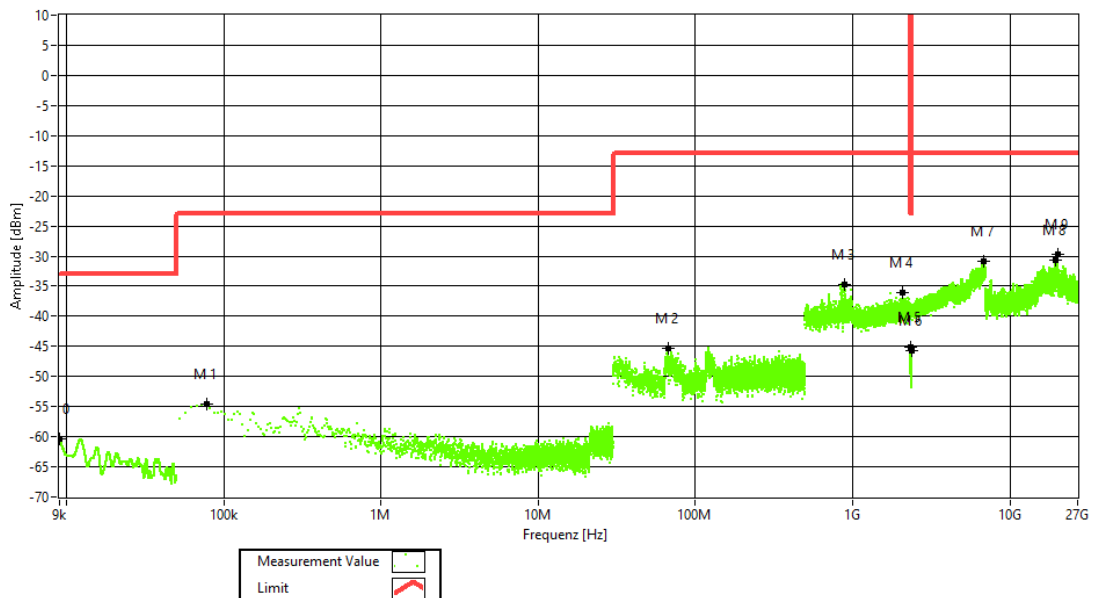



BUREAU
VERITAS

EffectiveECL-TA-20-010-V01.00

TA tests on Andrew CAP MX AC 6/7E/80-
85/17E/19/23/25T

Frequency Band = WCS 2300, Test Frequency = high, Direction = RF downlink, Signal Type = GSM

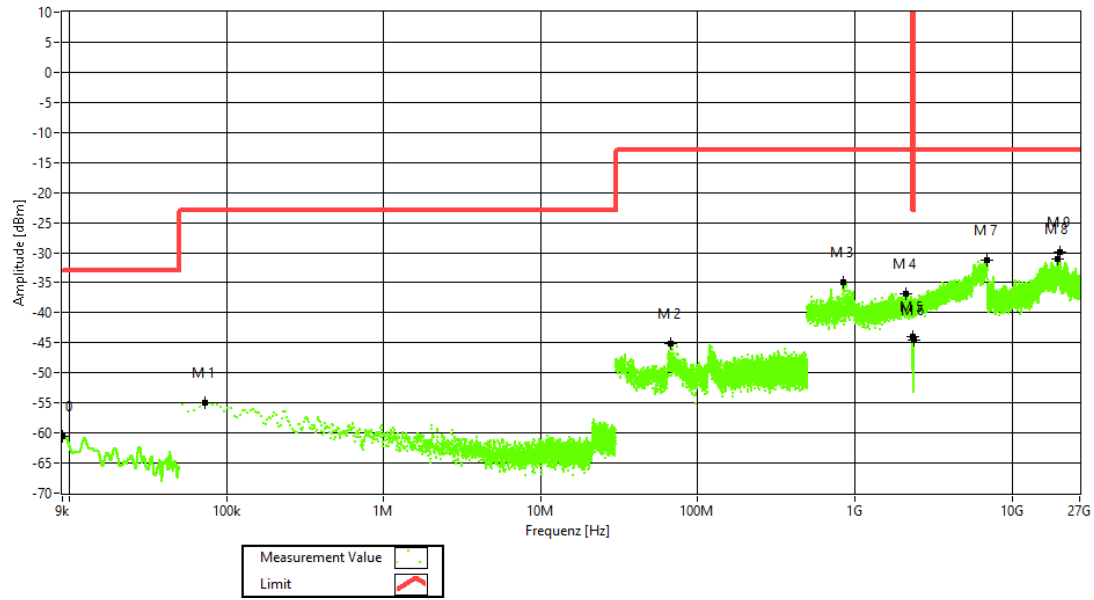

4.4.5 TEST EQUIPMENT USED

- Conducted



**BUREAU
VERITAS**

Effective ECL-TA-20-010-V01.00

TA tests on Andrew CAP MX AC 6/7E/80-
85/17E/19/23/25T

4.5 OUT-OF-BAND EMISSION LIMITS

Standard FCC Part § 2.1051, § 27.53

The test was performed according to:
ANSI C63.26, KDB 935210 D05 v01r04: 3.6

Test date: 2020-07-07; 2020-07-23

Environmental conditions: 25 ° C; 40 % r. F. (07-07); 25 ° C; 42 % r. F. (07-23)

Test engineer: Thomas Hufnagel

4.5.1 TEST DESCRIPTION

This test case is intended to demonstrate compliance to the out-of-band emission limit for industrial signal boosters. The limits itself come from the applicable rule part for each operating band per FCC § 2.1051, FCC § 27.53, RSS-GEN with subpart 6.13 and RSS-199 with subpart 4.5.

The EUT was connected to the test setup according to the following diagram:

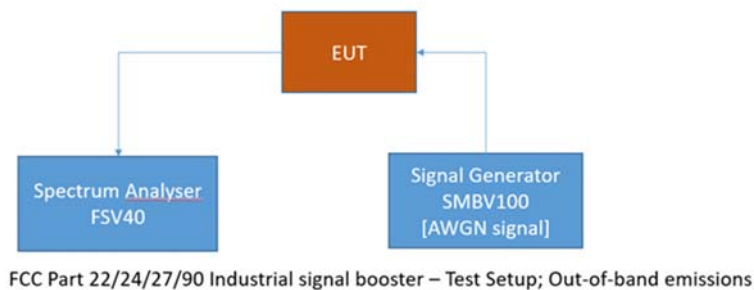

The attenuation of the measuring and stimulus path are known for each measured frequency and are considered.

The Spectrum Analyzer settings can be directly found in the measurement diagrams.



Effective ECL-TA-20-010-V01.00

TA tests on Andrew CAP MX AC 6/7E/80-85/17E/19/23/25T

4.5.2 TEST REQUIREMENTS/LIMITS

Abstract § 2.1051 from FCC:

FCC Part 2.1051; Measurement required: Spurious emissions at antenna terminal:

The radio frequency voltage or powers generated within the equipment and appearing on a spurious frequency shall be checked at the equipment output terminals when properly loaded with a suitable artificial antenna. Curves or equivalent data shall show the magnitude of each harmonic and other spurious emission that can be detected when the equipment is operated under the conditions specified in § 2.1049 as appropriate. The magnitude of spurious emissions which are attenuated more than 20 dB below the permissible value need not be specified.

Part 27; Miscellaneous Wireless Communication Services

Subpart C – Technical standards

§27.53 – Emission limits

Abstract § 27.53 FCC:

(a) For operations in the 2305-2320 MHz band and the 2345-2360 MHz band, the power of any emission outside a licensee's frequency band(s) of operation shall be attenuated below the transmitter power P (with averaging performed only during periods of transmission) within the licensed band(s) of operation, in watts, by the following amounts:

(1) For base and fixed stations' operations in the 2305-2320 MHz band and the 2345-2360 MHz band:

(i) By a factor of not less than $43 + 10 \log (P)$ dB on all frequencies between 2305 and 2320 MHz and on all frequencies between 2345 and 2360 MHz that are outside the licensed band(s) of operation, and not less than $75 + 10 \log (P)$ dB on all frequencies between 2320 and 2345 MHz;

(ii) By a factor of not less than $43 + 10 \log (P)$ dB on all frequencies between 2300 and 2305 MHz, $70 + 10 \log (P)$ dB on all frequencies between 2287.5 and 2300 MHz, $72 + 10 \log (P)$ dB on all frequencies between 2285 and 2287.5 MHz, and $75 + 10 \log (P)$ dB below 2285 MHz;

(iii) By a factor of not less than $43 + 10 \log (P)$ dB on all frequencies between 2360 and 2362.5 MHz, $55 + 10 \log (P)$ dB on all frequencies between 2362.5 and 2365 MHz, $70 + 10 \log (P)$ dB on all frequencies between 2365 and 2367.5 MHz, $72 + 10 \log (P)$ dB on all frequencies between 2367.5 and 2370 MHz, and $75 + 10 \log (P)$ dB above 2370 MHz.



**BUREAU
VERITAS**

Effective ECL-TA-20-010-V01.00

TA tests on Andrew CAP MX AC 6/7E/80-
85/17E/19/23/25T

(2) For fixed customer premises equipment (CPE) stations operating in the 2305-2320 MHz band and the 2345-2360 MHz band transmitting with more than 2 watts per 5 megahertz average EIRP:

(i) By a factor of not less than $43 + 10 \log (P)$ dB on all frequencies between 2305 and 2320 MHz and on all frequencies between 2345 and 2360 MHz that are outside the licensed band(s) of operation, and not less than $75 + 10 \log (P)$ dB on all frequencies between 2320 and 2345 MHz;

(ii) By a factor of not less than $43 + 10 \log (P)$ dB on all frequencies between 2300 and 2305 MHz, $70 + 10 \log (P)$ dB on all frequencies between 2287.5 and 2300 MHz, $72 + 10 \log (P)$ dB on all frequencies between 2285 and 2287.5 MHz, and $75 + 10 \log (P)$ dB below 2285 MHz;

(iii) By a factor of not less than $43 + 10 \log (P)$ dB on all frequencies between 2360 and 2362.5 MHz, $55 + 10 \log (P)$ dB on all frequencies between 2362.5 and 2365 MHz, $70 + 10 \log (P)$ dB on all frequencies between 2365 and 2367.5 MHz, $72 + 10 \log (P)$ dB on all frequencies between 2367.5 and 2370 MHz, and $75 + 10 \log (P)$ dB above 2370 MHz.

(3) For fixed CPE stations operating in the 2305-2320 MHz and 2345-2360 MHz bands transmitting with 2 watts per 5 megahertz average EIRP or less:

(i) By a factor of not less than $43 + 10 \log (P)$ dB on all frequencies between 2305 and 2320 MHz and on all frequencies between 2345 and 2360 MHz that are outside the licensed band(s) of operation, not less than $55 + 10 \log (P)$ dB on all frequencies between 2320 and 2324 MHz and between 2341 and 2345 MHz, not less than $61 + 10 \log (P)$ dB on all frequencies between 2324 and 2328 MHz and between 2337 and 2341 MHz, and not less than $67 + 10 \log (P)$ dB on all frequencies between 2328 and 2337 MHz;

(ii) By a factor of not less than $43 + 10 \log (P)$ dB on all frequencies between 2300 and 2305 MHz, $55 + 10 \log (P)$ dB on all frequencies between 2296 and 2300 MHz, $61 + 10 \log (P)$ dB on all frequencies between 2292 and 2296 MHz, $67 + 10 \log (P)$ dB on all frequencies between 2288 and 2292 MHz, and $70 + 10 \log (P)$ dB below 2288 MHz;

(iii) By a factor of not less than $43 + 10 \log (P)$ dB on all frequencies between 2360 and 2365 MHz, and not less than $70 + 10 \log (P)$ dB above 2365 MHz.



Effective ECL-TA-20-010-V01.00

TA tests on Andrew CAP MX AC 6/7E/80-85/17E/19/23/25T

Abstract RSS-199 from ISED:

RSS-195; 5.6 Transmitter unwanted emissions

The transmitter unwanted emissions shall be measured with a resolution bandwidth of 1 MHz. A smaller resolution bandwidth is permitted provided that the measured power is integrated over the full required measurement bandwidth of 1 MHz. However, in the 1 MHz bands immediately adjacent to the edges of the frequency range(s) in which the equipment is allowed to operate, a resolution bandwidth of as close as possible to, without being less than 1% of the occupied bandwidth, shall be employed provided that the measured power is integrated over the full required measurement bandwidth of 1 MHz.

5.6.1 Base Station, Fixed Station and High-Power Fixed Subscriber Equipment

Equipment shall comply with the following unwanted emission limits:

The power of any emission outside the frequency range(s) in which the equipment operates shall be attenuated below the transmitter power, P(dBW), by the amount indicated in Table 1 and graphically represented in Figure 1, where p is the transmitter output power measured in watts.

Table 1 — Unwanted Emissions for Base Station, Fixed Station and High-Power Fixed Subscriber Equipment

Table 1 — Unwanted Emissions for Base Station, Fixed Station and High-Power Fixed Subscriber Equipment

Frequency (MHz)	Attenuation (dB)
<2200	$43 + 10 \log_{10}(p)$
2200 - 2285	$75 + 10 \log_{10}(p)$
2285 - 2287.5	$72 + 10 \log_{10}(p)$
2287.5 - 2300	$70 + 10 \log_{10}(p)$
2300 - 2305	$43 + 10 \log_{10}(p)$
2305 - 2320	$43 + 10 \log_{10}(p)$ ^{Note}
2320 - 2345	$75 + 10 \log_{10}(p)$
2345 - 2360	$43 + 10 \log_{10}(p)$ ^{Note}
2360 - 2362.5	$43 + 10 \log_{10}(p)$
2362.5 - 2365	$55 + 10 \log_{10}(p)$
2365 - 2367.5	$70 + 10 \log_{10}(p)$
2367.5 - 2370	$72 + 10 \log_{10}(p)$
2370 - 2395	$75 + 10 \log_{10}(p)$
>2395	$43 + 10 \log_{10}(p)$

Note: Measured at the edges of the highest and lowest frequency range(s) in which the equipment is designed to operate. See Section 5.2 for the permitted frequency ranges for the various equipment types.



EffectiveECL-TA-20-010-V01.00

TA tests on Andrew CAP MX AC 6/7E/80-85/17E/19/23/25T

4.5.3 TEST PROTOCOL

Band 30 WCS 2300, downlink, Number of input signals = 1							
Signal Type	Input Power	Band Edge	Signal Frequency [MHz]	Input Power [dBm]	Maximum Out-of-band Power [dBm]	Limit Out-of-band Power [dBm]	Margin to Limit [dB]
Wideband	-0.3 dB < AGC	upper	2357.50	-2.3	-36.0	-13.0	23.0
Wideband	3 dB > AGC	upper	2357.50	1.0	-36.0	-13.0	23.0
Narrowband	-0.3 dB < AGC	upper	2359.80	-2.3	-49.3	-13.0	36.3
Narrowband	3 dB > AGC	upper	2359.80	1.0	-49.3	-13.0	36.3
Wideband	-0.3 dB < AGC	lower	2352.50	-2.4	-36.1	-13.0	23.1
Wideband	3 dB > AGC	lower	2352.50	0.9	-35.8	-13.0	22.8
Narrowband	-0.3 dB < AGC	lower	2350.20	-2.1	-28.9	-13.0	15.9
Narrowband	3 dB > AGC	lower	2350.20	1.2	-49.4	-13.0	36.4

Band 30 WCS 2300, downlink, Number of input signals = 2								
Signal Type	Input Power	Band Edge	Signal Frequency f1 [MHz]	Signal Frequency f2 [MHz]	Input Power [dBm]	Maximum Out-of-band Power [dBm]	Limit Out-of-band Power [dBm]	Margin to Limit [dB]
WB	-0.3 dB < AGC	upper	2357.50	2355.00	-2.3	-35.9	-13.0	22.9
WB	3 dB > AGC	upper	2357.50	2355.00	1.0	-36.1	-13.0	23.1
NB	-0.3 dB < AGC	upper	2359.80	2359.60	-2.3	-49.5	-13.0	36.5
NB	3 dB > AGC	upper	2359.80	2359.60	1.0	-49.5	-13.0	36.5
WB	-0.3 dB < AGC	lower	2352.50	2355.00	-2.4	-36.0	-13.0	23.0
WB	3 dB > AGC	lower	2352.50	2355.00	0.9	-36.1	-13.0	23.1
NB	-0.3 dB < AGC	lower	2350.20	2350.40	-2.1	-31.7	-13.0	18.7
NB	3 dB > AGC	lower	2350.20	2350.40	1.2	-49.5	-13.0	36.5

Remark: Please see next sub-clause for the measurement plot.

Explanations concerning table with two input signals:

“WB” means Wideband.
 “NB” means Narrowband.



BUREAU
VERITAS

EffectiveECL-TA-20-010-V01.00

TA tests on Andrew CAP MX AC 6/7E/80-85/17E/19/23/25T

4.5.4 MEASUREMENT PLOT (SHOWING THE HIGHEST VALUE, "WORST CASE")

Band: WCS 2300; Frequency: 2.3500 GHz to 2.3600 GHz; Band Edge: upper; Mod: AWGN; Input Power = 0.3 dB < AGC; Number of signals 1

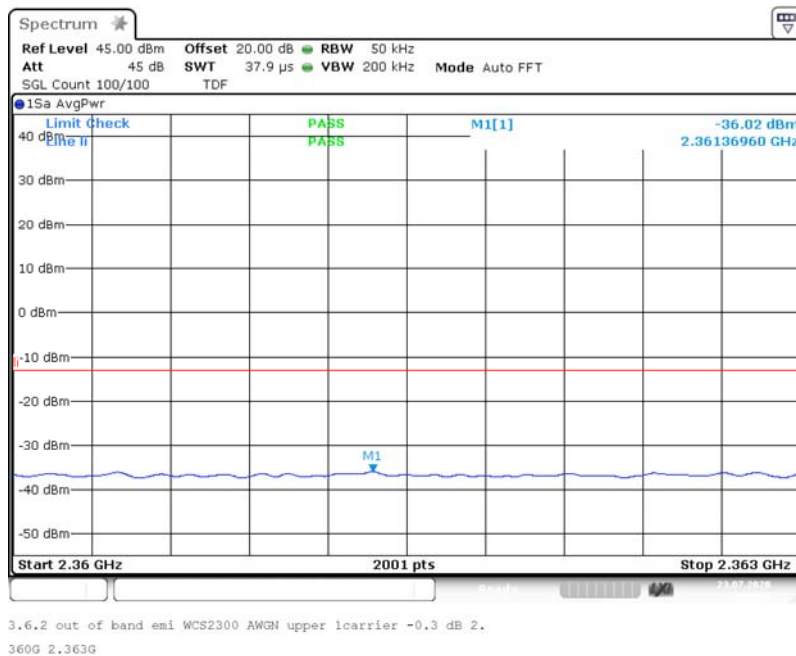

Band: WCS 2300; Frequency: 2.3500 GHz to 2.3600 GHz; Band Edge: upper; Mod: AWGN; Input Power = 3 dB > AGC; Number of signals 1

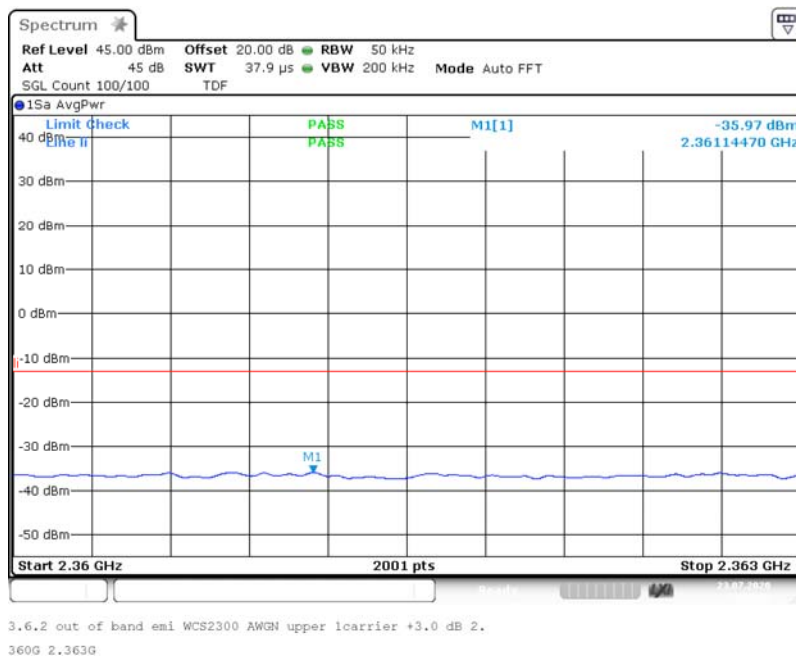



BUREAU
VERITAS

EffectiveECL-TA-20-010-V01.00

TA tests on Andrew CAP MX AC 6/7E/80-85/17E/19/23/25T

Band: WCS 2300; Frequency: 2.3500 GHz to 2.3600 GHz; Band Edge: upper; Mod: GSM; Input Power = 0.3 dB < AGC; Number of signals 1

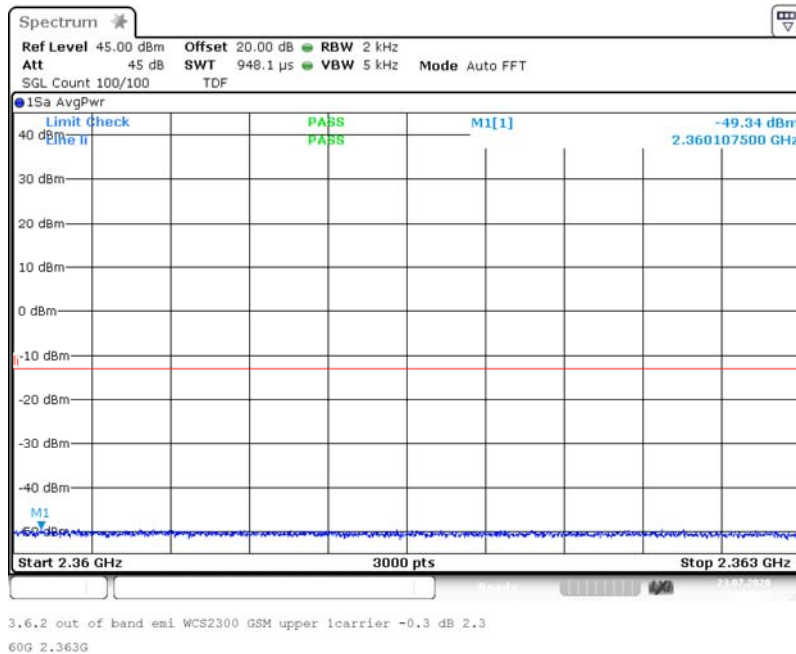

Band: WCS 2300; Frequency: 2.3500 GHz to 2.3600 GHz; Band Edge: upper; Mod: GSM; Input Power = 3 dB > AGC; Number of signals 1

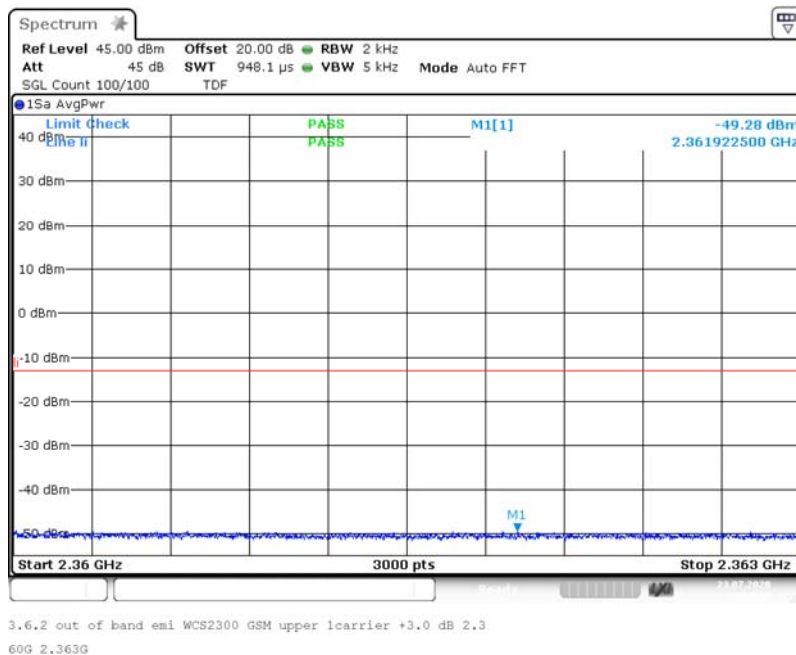



BUREAU
VERITAS

EffectiveECL-TA-20-010-V01.00

TA tests on Andrew CAP MX AC 6/7E/80-85/17E/19/23/25T

Band: WCS 2300; Frequency: 2.3500 GHz to 2.3600 GHz; Band Edge: lower; Mod: AWGN; Input Power = 0.3 dB < AGC; Number of signals 1

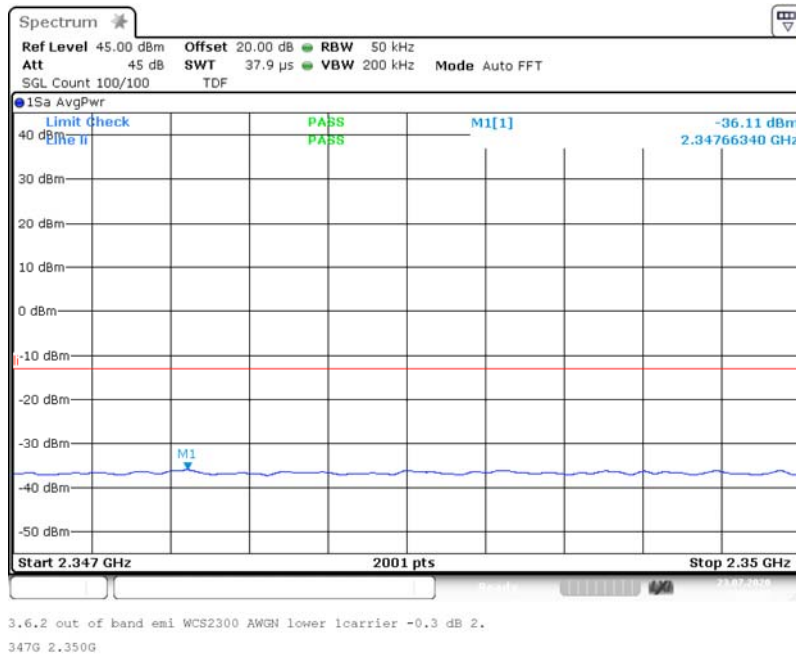

Band: WCS 2300; Frequency: 2.3500 GHz to 2.3600 GHz; Band Edge: lower; Mod: AWGN; Input Power = 3 dB > AGC; Number of signals 1

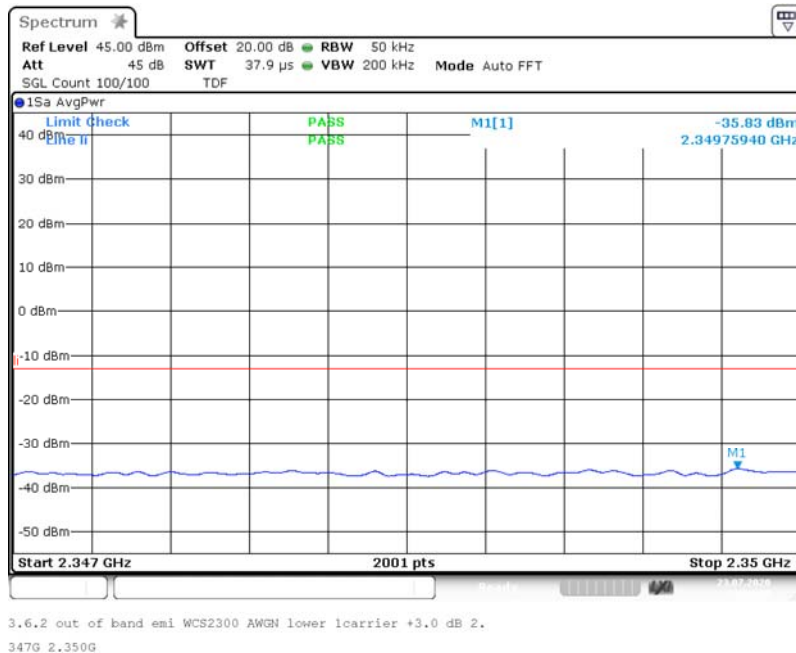



BUREAU
VERITAS

EffectiveECL-TA-20-010-V01.00

TA tests on Andrew CAP MX AC 6/7E/80-85/17E/19/23/25T

Band: WCS 2300; Frequency: 2.3500 GHz to 2.3600 GHz; Band Edge: lower; Mod: GSM; Input Power = 0.3 dB < AGC; Number of signals 1

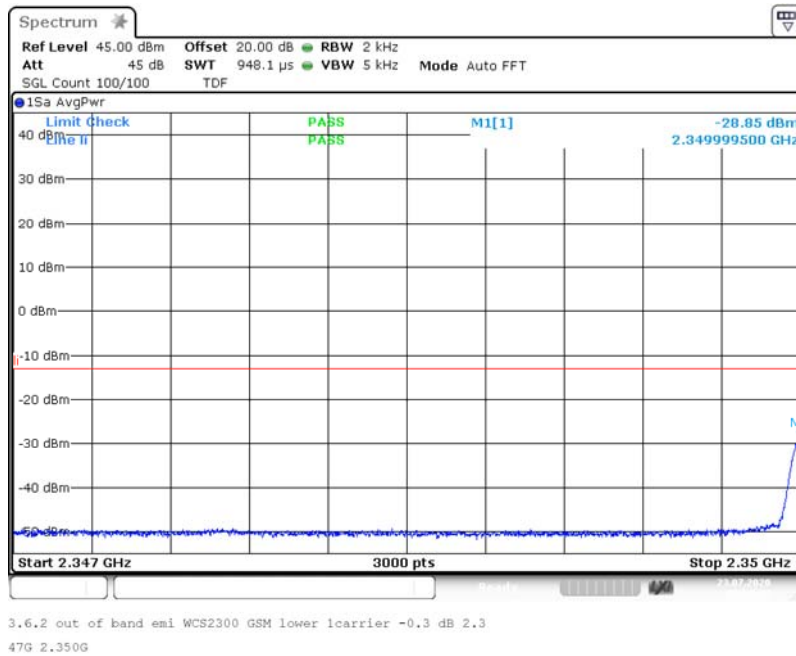

Band: WCS 2300; Frequency: 2.3500 GHz to 2.3600 GHz; Band Edge: lower; Mod: GSM; Input Power = 3 dB > AGC; Number of signals 1

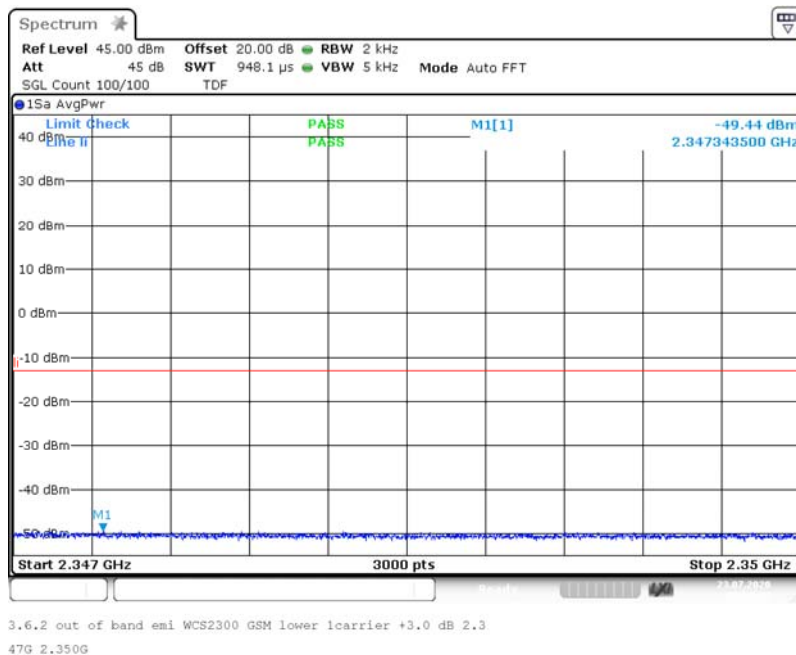



BUREAU
VERITAS

EffectiveECL-TA-20-010-V01.00

TA tests on Andrew CAP MX AC 6/7E/80-85/17E/19/23/25T

Band: WCS 2300; Frequency: 2.3500 GHz to 2.3600 GHz; Band Edge: upper; Mod: AWGN; Input Power = 0.3 dB < AGC; Number of signals 2

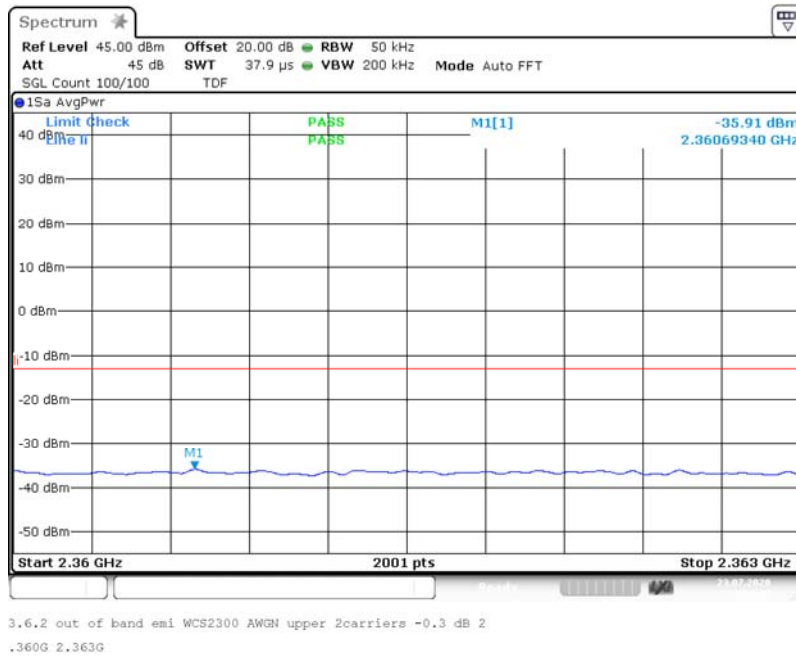

Band: WCS 2300; Frequency: 2.3500 GHz to 2.3600 GHz; Band Edge: upper; Mod: AWGN; Input Power = 3 dB > AGC; Number of signals 2

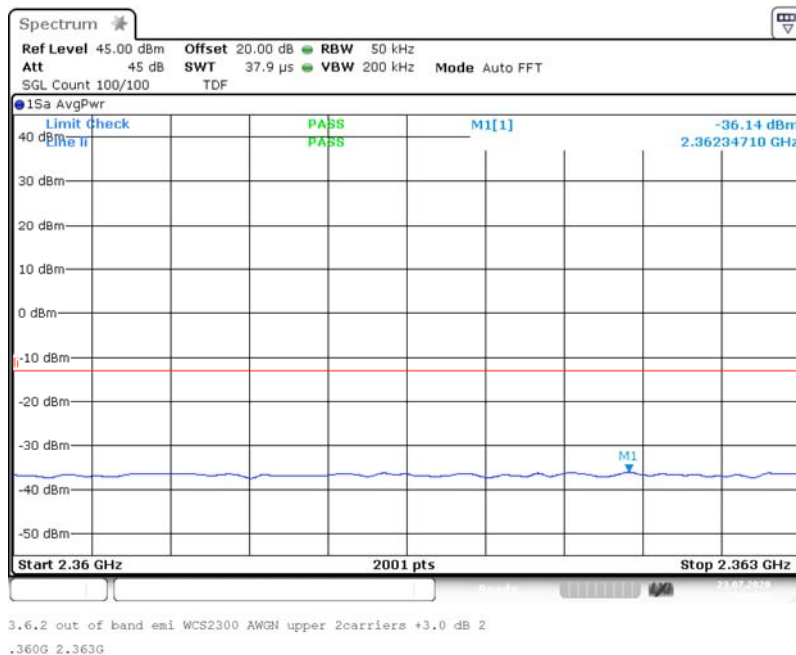



BUREAU
VERITAS

EffectiveECL-TA-20-010-V01.00

TA tests on Andrew CAP MX AC 6/7E/80-85/17E/19/23/25T

Band: WCS 2300; Frequency: 2.3500 GHz to 2.3600 GHz; Band Edge: upper; Mod: GSM; Input Power = 0.3 dB < AGC; Number of signals 2

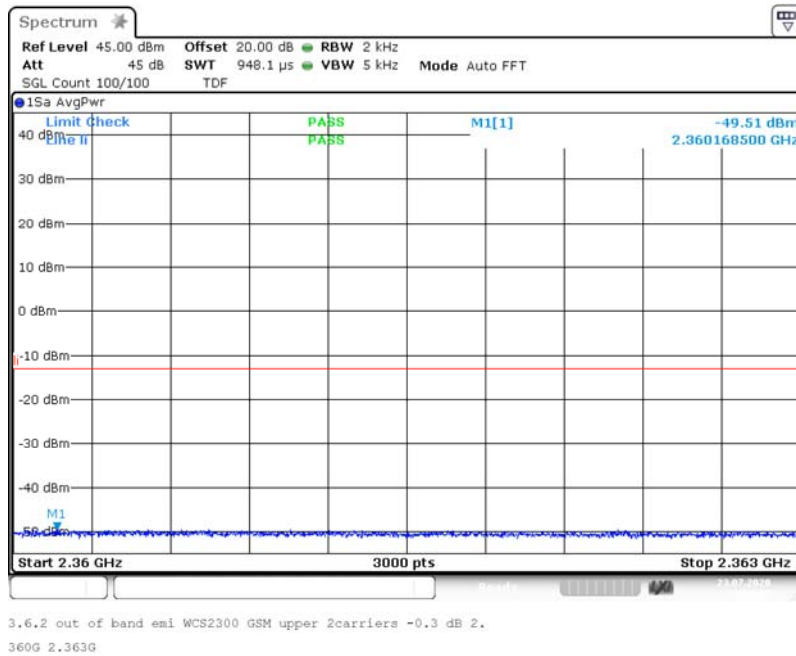

Band: WCS 2300; Frequency: 2.3500 GHz to 2.3600 GHz; Band Edge: upper; Mod: GSM; Input Power = 3 dB > AGC; Number of signals 2

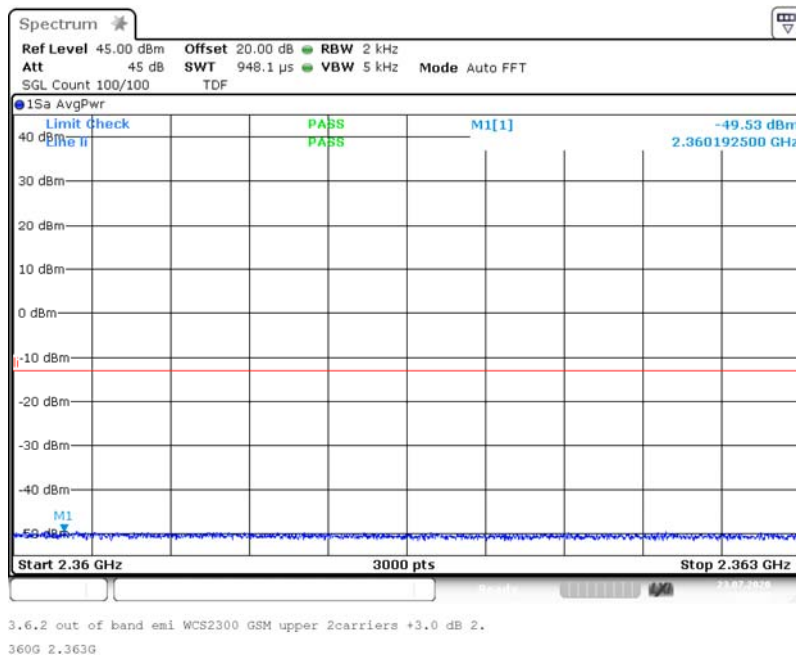



BUREAU
VERITAS

EffectiveECL-TA-20-010-V01.00

TA tests on Andrew CAP MX AC 6/7E/80-85/17E/19/23/25T

Band: WCS 2300; Frequency: 2.3500 GHz to 2.3600 GHz; Band Edge: lower; Mod: AWGN; Input Power = 0.3 dB < AGC; Number of signals 2

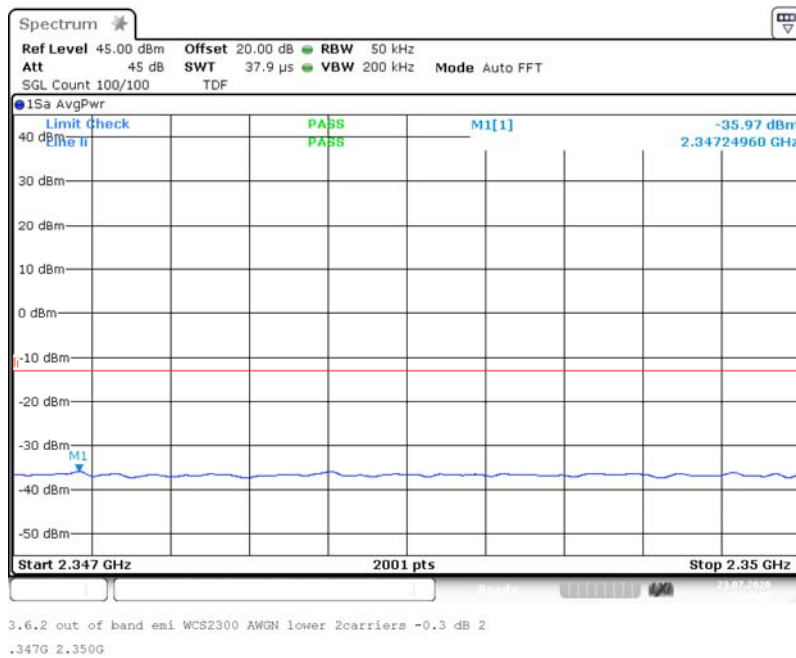

Band: WCS 2300; Frequency: 2.3500 GHz to 2.3600 GHz; Band Edge: lower; Mod: AWGN; Input Power = 3 dB > AGC; Number of signals 2

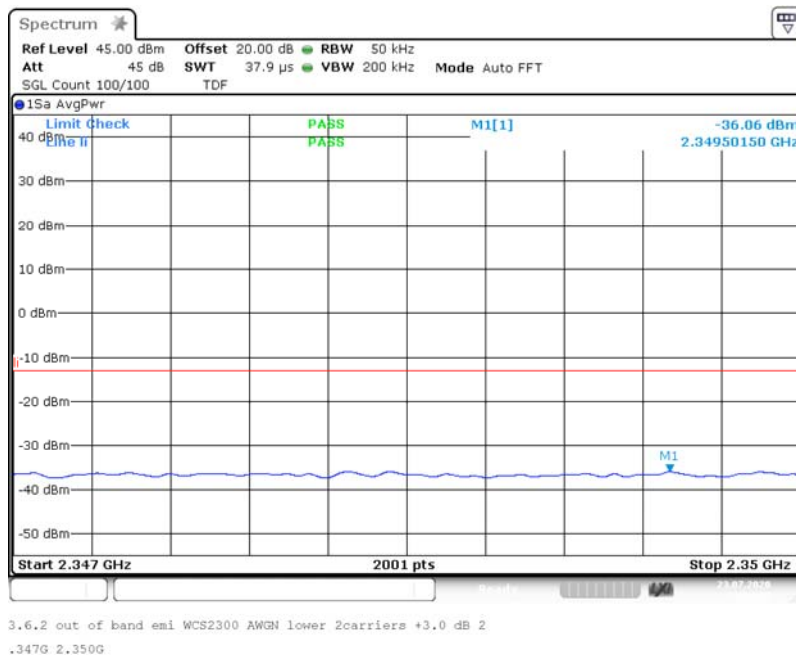



BUREAU
VERITAS

EffectiveECL-TA-20-010-V01.00

TA tests on Andrew CAP MX AC 6/7E/80-85/17E/19/23/25T

Band: WCS 2300; Frequency: 2.3500 GHz to 2.3600 GHz; Band Edge: lower; Mod: GSM; Input Power = 0.3 dB < AGC; Number of signals 2

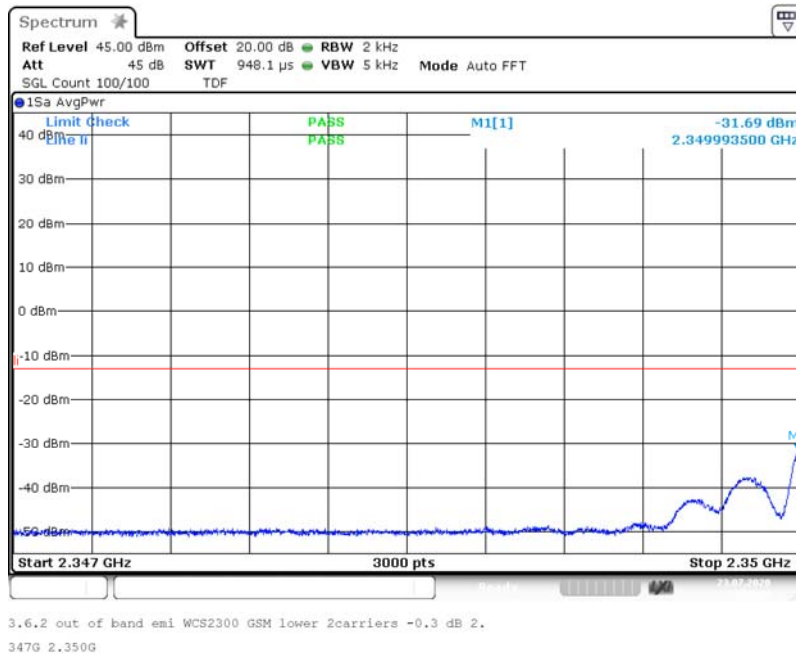

Band: WCS 2300; Frequency: 2.3500 GHz to 2.3600 GHz; Band Edge: lower; Mod: GSM; Input Power = 3 dB > AGC; Number of signals 2

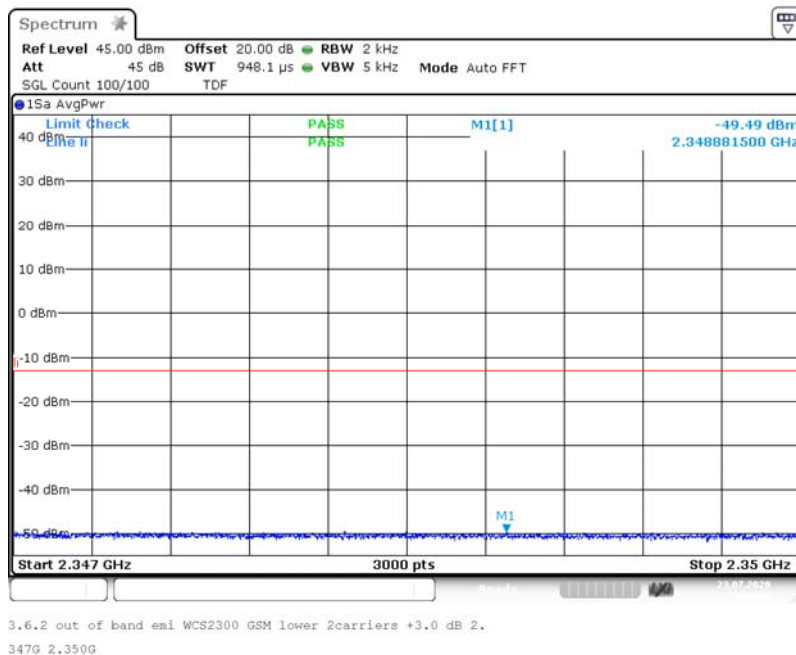



BUREAU
VERITAS

EfectiveECL-TA-20-010-V01.00

TA tests on Andrew CAP MX AC 6/7E/80-
85/17E/19/23/25T

4.5.5 TEST EQUIPMENT USED

- Conducted

Effective ECL-TA-20-010-V01.00

TA tests on Andrew CAP MX AC 6/7E/80-85/17E/19/23/25T

4.6 OUT-OF-BAND REJECTION

Standard FCC Part 27

The test was performed according to:
ANSI C63.26; KDB 935210 D05

Test date: 2020-07-07; 2020-07-23

Environmental conditions: 25 ° C; 40 % r. F. (07-07); 25 °C; 42 % r. F. (07-23)

Test engineer: Thomas Hufnagel

4.6.1 TEST DESCRIPTION

This test case is intended to demonstrate compliance to the out-of-band rejection test case for industrial signal boosters.

The EUT was connected to the test setup according to the following diagram:

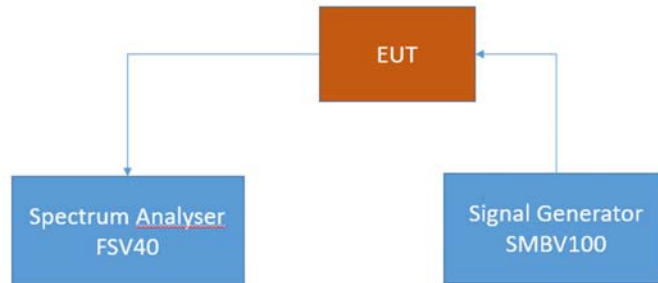

FCC Part 22/24/27/90 Industrial signal booster – Test Setup; Out-of-band rejection

The attenuation of the measuring and stimulus path are known for each measured frequency and are considered.

The Spectrum Analyzer settings can be directly found in the measurement diagrams.

4.6.2 TEST REQUIREMENTS/LIMITS

Abstract RSS-131 from ISED:

RSS-131; 5.2.1 Out-of-band rejection

The gain-versus-frequency response and the 20 dB bandwidth of the zone enhancer shall be reported. The zone enhancer shall reject amplification of other signals outside the passband of the zone enhancer.



EfectiveECL-TA-20-010-V01.00

TA tests on Andrew CAP MX AC 6/7E/80-85/17E/19/23/25T

4.6.3 TEST PROTOCOL

Band 30 WCS 2300, downlink				
Highest Power Frequency [MHz]	Output Power [dBm]	Lower Highest Power -20 dB Frequency [MHz]	Upper Highest Power -20 dB Frequency [MHz]	20 dB Bandwidth [MHz]
2357.60	25.90	2349.6875	2360.3075	10.6200

Remark: Please see next sub-clause for the measurement plot.

4.6.4 MEASUREMENT PLOT (SHOWING THE HIGHEST VALUE, "WORST CASE")

Frequency Band = WCS 2300, Direction = RF downlink

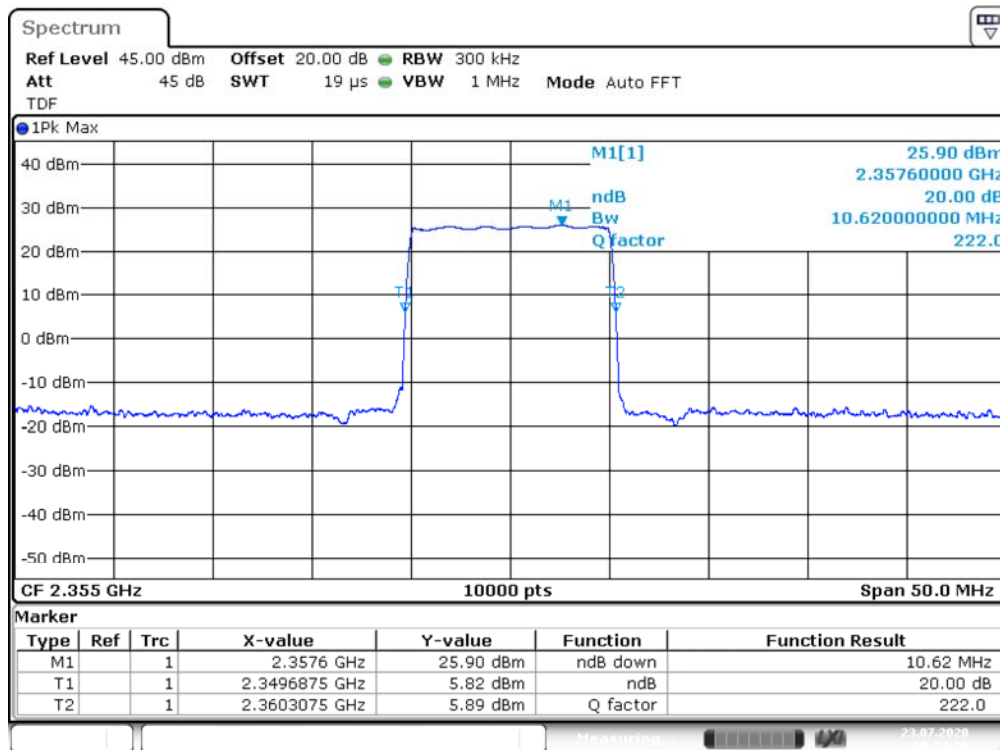

3.3 Out of band rejection WCS2300 2.35500G
 _20dB

4.6.5 TEST EQUIPMENT USED

- Conducted

Effective ECL-TA-20-010-V01.00

TA tests on Andrew CAP MX AC 6/7E/80-85/17E/19/23/25T

4.7 FIELD STRENGTH OF SPURIOUS RADIATION

Standard FCC Part 27, § 24.53

The test was performed according to:
ANSI C63.26

Test date: 2020-09-09

Environmental conditions: 23 ° C; 46 % r. F.

Test engineer: Thomas Hufnagel

4.7.1 TEST DESCRIPTION

This test case is intended to demonstrate compliance to the applicable radiated spurious emission measurements per § 2.1053

The EUT was connected to the test setup according to the following diagram:

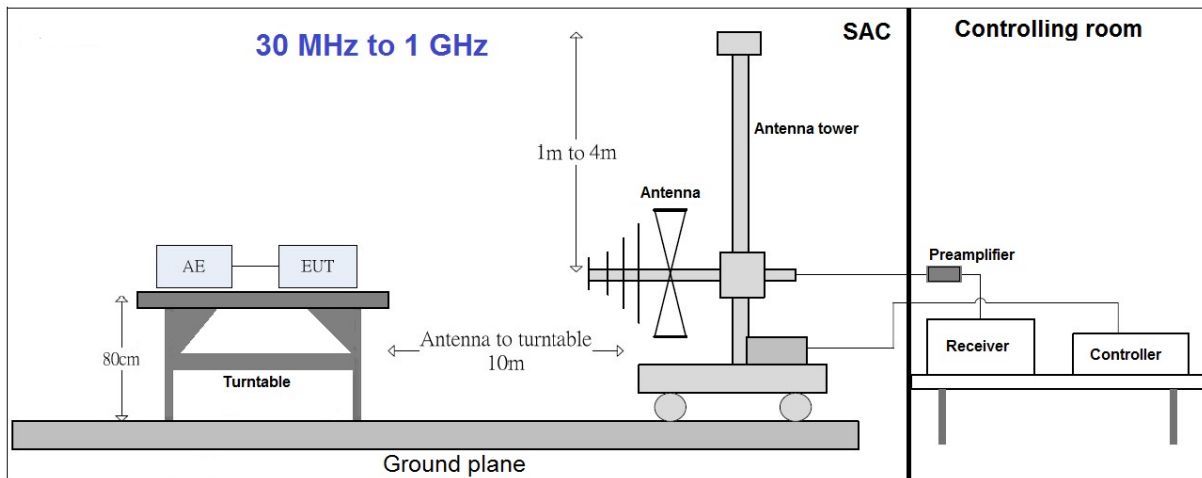

EffectiveECL-TA-20-010-V01.00

TA tests on Andrew CAP MX AC 6/7E/80-85/17E/19/23/25T

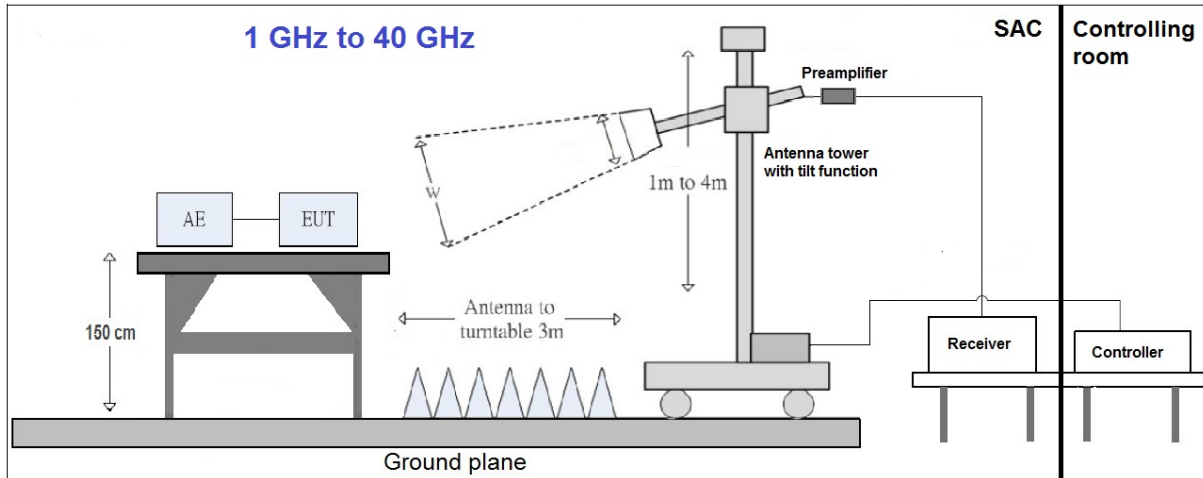

The test set-up was made in accordance to the general provisions of ANSI C63.4 in a typical installation configuration. The Equipment Under Test (EUT) was set up on a non-conductive table 1.5 x 1.5 m² in the semi-anechoic chamber, 0.8 meter above the ground or floor-standing arrangement shall be placed on the horizontal ground reference plane.. The influence of the EUT support table that is used between 30–1000 MHz was evaluated. For the initial measurements, the receiving antenna is varied from 1-4 meter height and is changed in the vertical plane from vertical to horizontal polarization at each frequency. The highest emissions between 30 MHz to 1000 MHz were analyzed in details by operating the spectrum analyzer and/or EMI receiver in quasi-peak mode to determine the precise amplitude of the emissions.

The measurement procedure is implemented into the EMI test software BAT EMC from NEXIO. Exploratory tests are performed at 3 orthogonal axes to determine the worst-case orientation of a body-worn or handheld EUT. The final test on all kind of EUTs is also performed at 3 axes. A pre-check is performed while the EUT is powered by a DC power source. ?

1. Measurement above 30 MHz and up to 1 GHz

Step 1: Preliminary scan

This is a preliminary test to identify the highest amplitudes relative to the limit.

Settings for step 1:

- Antenna distance: 10 m
- Detector: Peak-Maxhold/RMS (FFT-based)
- Frequency range: 30 – 1000 MHz
- Frequency steps: 30 kHz
- IF-Bandwidth: 120 kHz
- Measuring time/Frequency step: 5 ms
- Turntable angle range: -180° to 180°
- Turntable step size: 30°
- Height variation range: 1 – 4 m
- Height variation step size: 1 m
- Polarisation: Horizontal + Vertical

Intention of this step is, to determine the radiated EMI-profile of the EUT. Afterwards the relevant emissions for the final measurement are identified.



Effective ECL-TA-20-010-V01.00

TA tests on Andrew CAP MX AC 6/7E/80-
85/17E/19/23/25T

Step 2: Adjustment measurement

In this step the accuracy of the turntable azimuth and antenna height will be improved. This is necessary to find out the maximum value of every frequency.

For each frequency, which was determined the turntable azimuth and antenna height will be adjusted. The turntable azimuth will slowly vary by $\pm 45^\circ$ around this value. During this action, the value of emission is continuously measured. The turntable azimuth at the highest emission will be recorded and adjusted. In this position, the antenna height will also slowly vary by ± 100 cm around the antenna height determined. During this action, the value of emission is also continuously measured. The antenna height of the highest emission will also be recorded and adjusted.

- Detector: Peak – Maxhold; RMS
- Measured frequencies: in step 1 determined frequencies
- IF – Bandwidth: 120 kHz
- Measuring time: 100 ms
- Turntable angle range: $\pm 30^\circ$ around the determined value
- Antenna Polarisation: max. value determined in step 1

Step 3: Final measurement with QP detector

With the settings determined in step 3, the final measurement will be performed:

EMI receiver settings for step 4:

- Detector: Quasi-Peak (< 1 GHz); RMS; Peak
- Measured frequencies: in step 1 determined frequencies
- IF – Bandwidth: 120 kHz
- Measuring time: 1 s

After the measurement a plot will be generated which contains a diagram with the results of the preliminary scan and a chart with the frequencies and values of the results of the final measurement.

3. Measurement above 1 GHz

The following modifications apply to the measurement procedure for the frequency range above 1 GHz:

Step 1:

The Equipment Under Test (EUT) was set up on a non-conductive support at 1.5 m height in the semi-anechoic chamber. Absorbers are placed around and between the turn table and the antenna tower.

All steps were performed with one height (1.5 m) of the receiving antenna only.

The EUT is turned during the preliminary measurement across the elevation axis, with a step size of 30° .

The turn table step size (azimuth angle) for the preliminary measurement is 15° .

Step 2:

The maximum RFI field strength was determined during the measurement by rotating the turntable (± 180 degrees) and varying the height of the receive antenna ($h = 1 \dots 4$ m) with an additional tilt function of the antenna. The turn table azimuth will slowly vary by $\pm 15^\circ$.

EMI receiver settings (for all steps):

- Detector: Peak, Average
- IF Bandwidth = 1 MHz



Effective ECL-TA-20-010-V01.00

TA tests on Andrew CAP MX AC 6/7E/80-
85/17E/19/23/25T

Step 3:

Spectrum analyser settings for step 3:

- Detector: Peak/Average
- Measured frequencies: in step 1 determined frequencies
- IF – Bandwidth: 1 MHz
- Measuring time: 1 s

4.7.2 TEST REQUIREMENTS/LIMITS

Abstract from FCC Part § 2.1053:

FCC Part 2.1053; Measurement required: Field strength of spurious radiation:

Measurements shall be made to detect spurious emissions that may be radiated directly from the cabinet, control circuits, power leads, or intermediate circuit elements under normal conditions of installation and operation. Curves or equivalent data shall be supplied showing the magnitude of each harmonic and other spurious emission. For this test, single sideband, independent sideband, and controlled carrier transmitters shall be modulated under the conditions specified in paragraph (c) of § 2.1049, as appropriate.

Part 27; Miscellaneous Wireless Communication Services

Subpart C – Technical standards

§27.53 – Emission limits

Abstract § 27.53 FCC:

(a) For operations in the 2305-2320 MHz band and the 2345-2360 MHz band, the power of any emission outside a licensee's frequency band(s) of operation shall be attenuated below the transmitter power P (with averaging performed only during periods of transmission) within the licensed band(s) of operation, in watts, by the following amounts:

(1) For base and fixed stations' operations in the 2305-2320 MHz band and the 2345-2360 MHz band:

(i) By a factor of not less than $43 + 10 \log (P)$ dB on all frequencies between 2305 and 2320 MHz and on all frequencies between 2345 and 2360 MHz that are outside the licensed band(s) of operation, and not less than $75 + 10 \log (P)$ dB on all frequencies between 2320 and 2345 MHz;

(ii) By a factor of not less than $43 + 10 \log (P)$ dB on all frequencies between 2300 and 2305 MHz, $70 + 10 \log (P)$ dB on all frequencies between 2287.5 and 2300 MHz, $72 + 10 \log (P)$ dB on all frequencies between 2285 and 2287.5 MHz, and $75 + 10 \log (P)$ dB below 2285 MHz;

(iii) By a factor of not less than $43 + 10 \log (P)$ dB on all frequencies between 2360 and 2362.5 MHz, $55 + 10 \log (P)$ dB on all frequencies between 2362.5 and 2365 MHz, $70 + 10 \log (P)$ dB on all frequencies between 2365 and 2367.5 MHz, $72 + 10 \log (P)$ dB on all frequencies between 2367.5 and 2370 MHz, and $75 + 10 \log (P)$ dB above 2370 MHz.



**BUREAU
VERITAS**

Effective ECL-TA-20-010-V01.00

TA tests on Andrew CAP MX AC 6/7E/80-
85/17E/19/23/25T

(2) For fixed customer premises equipment (CPE) stations operating in the 2305-2320 MHz band and the 2345-2360 MHz band transmitting with more than 2 watts per 5 megahertz average EIRP:

(i) By a factor of not less than $43 + 10 \log (P)$ dB on all frequencies between 2305 and 2320 MHz and on all frequencies between 2345 and 2360 MHz that are outside the licensed band(s) of operation, and not less than $75 + 10 \log (P)$ dB on all frequencies between 2320 and 2345 MHz;

(ii) By a factor of not less than $43 + 10 \log (P)$ dB on all frequencies between 2300 and 2305 MHz, $70 + 10 \log (P)$ dB on all frequencies between 2287.5 and 2300 MHz, $72 + 10 \log (P)$ dB on all frequencies between 2285 and 2287.5 MHz, and $75 + 10 \log (P)$ dB below 2285 MHz;

(iii) By a factor of not less than $43 + 10 \log (P)$ dB on all frequencies between 2360 and 2362.5 MHz, $55 + 10 \log (P)$ dB on all frequencies between 2362.5 and 2365 MHz, $70 + 10 \log (P)$ dB on all frequencies between 2365 and 2367.5 MHz, $72 + 10 \log (P)$ dB on all frequencies between 2367.5 and 2370 MHz, and $75 + 10 \log (P)$ dB above 2370 MHz.

(3) For fixed CPE stations operating in the 2305-2320 MHz and 2345-2360 MHz bands transmitting with 2 watts per 5 megahertz average EIRP or less:

(i) By a factor of not less than $43 + 10 \log (P)$ dB on all frequencies between 2305 and 2320 MHz and on all frequencies between 2345 and 2360 MHz that are outside the licensed band(s) of operation, not less than $55 + 10 \log (P)$ dB on all frequencies between 2320 and 2324 MHz and between 2341 and 2345 MHz, not less than $61 + 10 \log (P)$ dB on all frequencies between 2324 and 2328 MHz and between 2337 and 2341 MHz, and not less than $67 + 10 \log (P)$ dB on all frequencies between 2328 and 2337 MHz;

(ii) By a factor of not less than $43 + 10 \log (P)$ dB on all frequencies between 2300 and 2305 MHz, $55 + 10 \log (P)$ dB on all frequencies between 2296 and 2300 MHz, $61 + 10 \log (P)$ dB on all frequencies between 2292 and 2296 MHz, $67 + 10 \log (P)$ dB on all frequencies between 2288 and 2292 MHz, and $70 + 10 \log (P)$ dB below 2288 MHz;

(iii) By a factor of not less than $43 + 10 \log (P)$ dB on all frequencies between 2360 and 2365 MHz, and not less than $70 + 10 \log (P)$ dB above 2365 MHz.



Effective ECL-TA-20-010-V01.00

TA tests on Andrew CAP MX AC 6/7E/80-85/17E/19/23/25T

Abstract RSS-199 from ISED:

RSS-195; 5.6 Transmitter unwanted emissions

The transmitter unwanted emissions shall be measured with a resolution bandwidth of 1 MHz. A smaller resolution bandwidth is permitted provided that the measured power is integrated over the full required measurement bandwidth of 1 MHz. However, in the 1 MHz bands immediately adjacent to the edges of the frequency range(s) in which the equipment is allowed to operate, a resolution bandwidth of as close as possible to, without being less than 1% of the occupied bandwidth, shall be employed provided that the measured power is integrated over the full required measurement bandwidth of 1 MHz.

5.6.1 Base Station, Fixed Station and High-Power Fixed Subscriber Equipment

Equipment shall comply with the following unwanted emission limits:

The power of any emission outside the frequency range(s) in which the equipment operates shall be attenuated below the transmitter power, P(dBW), by the amount indicated in Table 1 and graphically represented in Figure 1, where p is the transmitter output power measured in watts.

Table 1 — Unwanted Emissions for Base Station, Fixed Station and High-Power Fixed Subscriber Equipment

Table 1 — Unwanted Emissions for Base Station, Fixed Station and High-Power Fixed Subscriber Equipment

Frequency (MHz)	Attenuation (dB)
<2200	$43 + 10 \log_{10}(p)$
2200 - 2285	$75 + 10 \log_{10}(p)$
2285 - 2287.5	$72 + 10 \log_{10}(p)$
2287.5 - 2300	$70 + 10 \log_{10}(p)$
2300 - 2305	$43 + 10 \log_{10}(p)$
2305 - 2320	$43 + 10 \log_{10}(p)$ ^{Note}
2320 - 2345	$75 + 10 \log_{10}(p)$
2345 - 2360	$43 + 10 \log_{10}(p)$ ^{Note}
2360 - 2362.5	$43 + 10 \log_{10}(p)$
2362.5 - 2365	$55 + 10 \log_{10}(p)$
2365 - 2367.5	$70 + 10 \log_{10}(p)$
2367.5 - 2370	$72 + 10 \log_{10}(p)$
2370 - 2395	$75 + 10 \log_{10}(p)$
>2395	$43 + 10 \log_{10}(p)$

Note: Measured at the edges of the highest and lowest frequency range(s) in which the equipment is designed to operate. See Section 5.2 for the permitted frequency ranges for the various equipment types.



EffectiveECL-TA-20-010-V01.00

TA tests on Andrew CAP MX AC 6/7E/80-85/17E/19/23/25T

4.7.3 TEST PROTOCOL

30 MHz to 1 GHz:

Band 30 WCS 2300, downlink;						
Spurious Freq. [MHz]	Spurious Level [dBm]	Pin (Sum Level) [dBm]	Detector	RBW [kHz]	Limit [dBm]	Margin to Limit [dB]
36.31	-66.0	-2.3	PEAK	120	-13.0	53.0
70.36	-56.0	-2.3	PEAK	120	-13.0	43.0
74.76	-56.3	-2.3	PEAK	120	-13.0	43.3
133.85	-63.4	-2.3	PEAK	120	-13.0	50.4
273.24	-53.7	-2.3	PEAK	120	-13.0	40.7
600.01	-62.5	-2.3	PEAK	120	-13.0	49.5

1 GHz to 18 GHz:

Band 30 WCS 2300, downlink;						
Spurious Freq. [MHz]	Spurious Level [dBm]	Pin (Sum Level) [dBm]	Detector	RBW [kHz]	Limit [dBm]	Margin to Limit [dB]
1699.6	-46.4	-2.3	PEAK	1000	-13.0	33.4
2359.7	-31.6	-2.3	PEAK	1000	-13.0	18.6
3550.3	-39.5	-2.3	PEAK	1000	-13.0	26.5
17760.9	-16.7	-2.3	PEAK	1000	-13.0	3.7
17787.2	-16.7	-2.3	PEAK	1000	-13.0	3.7

18 GHz to 27 GHz:

Band 30 WCS 2300, downlink;						
Spurious Freq. [MHz]	Spurious Level [dBm]	Pin (Sum Level) [dBm]	Detector	RBW [kHz]	Limit [dBm]	Margin to Limit [dB]
20625.0	-52.5	-2.3	PEAK	1000	-13.0	39.5
20625.0	-52.0	-2.3	PEAK	1000	-13.0	39.0

Remarks: Please see next sub-clause for the measurement plot.

Although usually a RMS detector is used for measurements in this cases a PEAK detector was used.

The limits are values for use of a RMS detector, but it is so, that the use of a PEAK detector results in readings with higher measured levels. Because the levels with the higher values with PEAK detector are in tolerance, the limits with a RMS detector are definitely also in tolerance.



BUREAU
VERITAS

EffectiveECL-TA-20-010-V01.00

TA tests on Andrew CAP MX AC 6/7E/80-
85/17E/19/23/25T

4.7.4 MEASUREMENT PLOT (SHOWING THE HIGHEST VALUE, "WORST CASE")

Frequency Band = WCS 2300, Test Frequency = low, Direction = RF downlink

30 MHz - 1 GHz

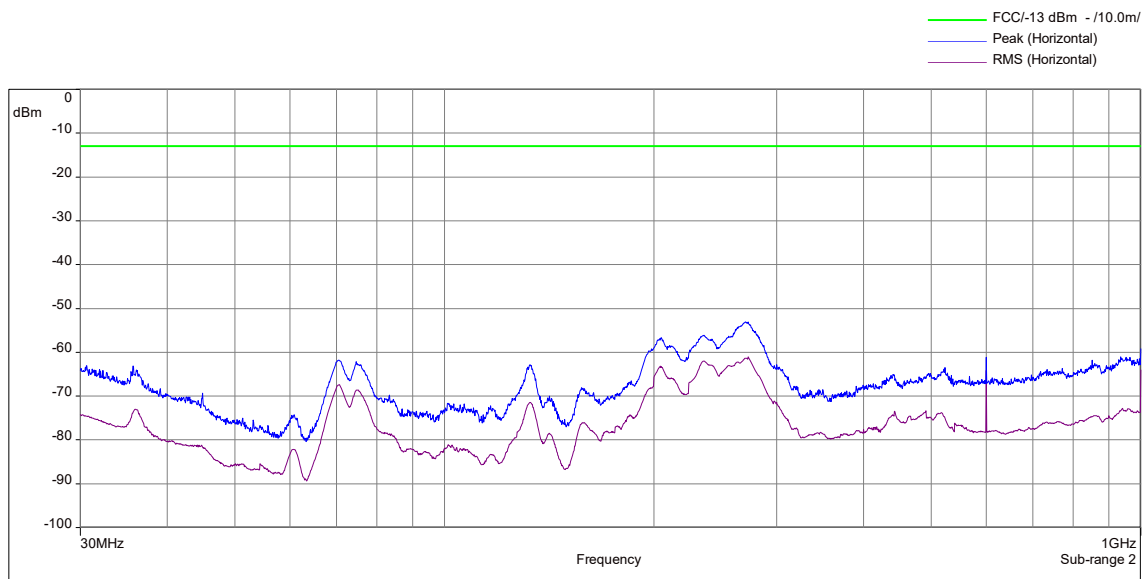
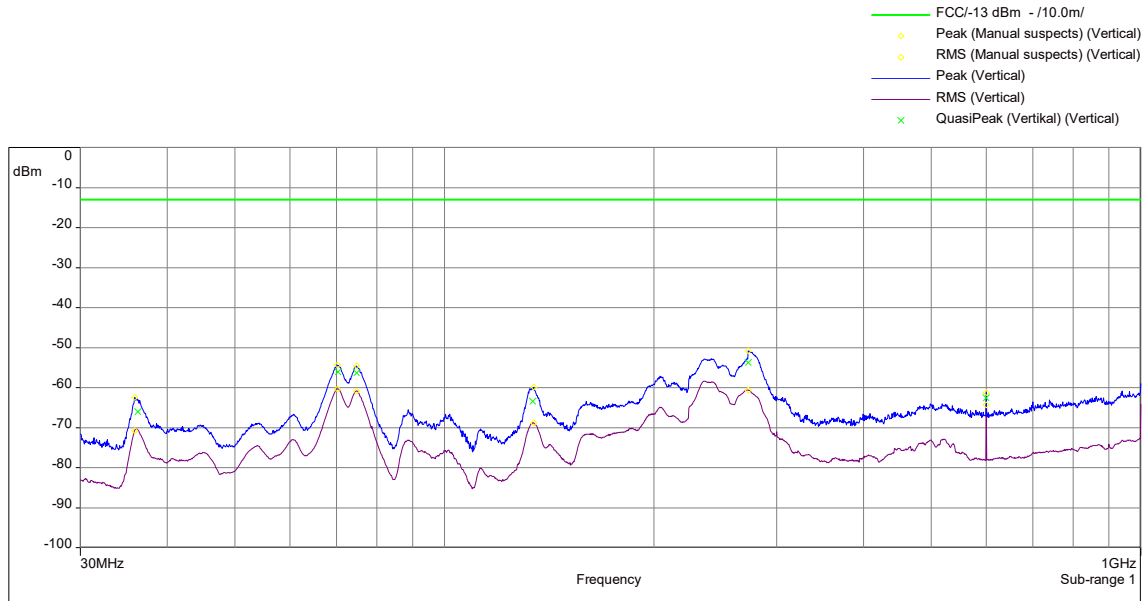



BUREAU
VERITAS

EffectiveECL-TA-20-010-V01.00

TA tests on Andrew CAP MX AC 6/7E/80-
85/17E/19/23/25T

Frequency Band = WCS 2300, Test Frequency = low, Direction = RF downlink

1 GHz - 18 GHz

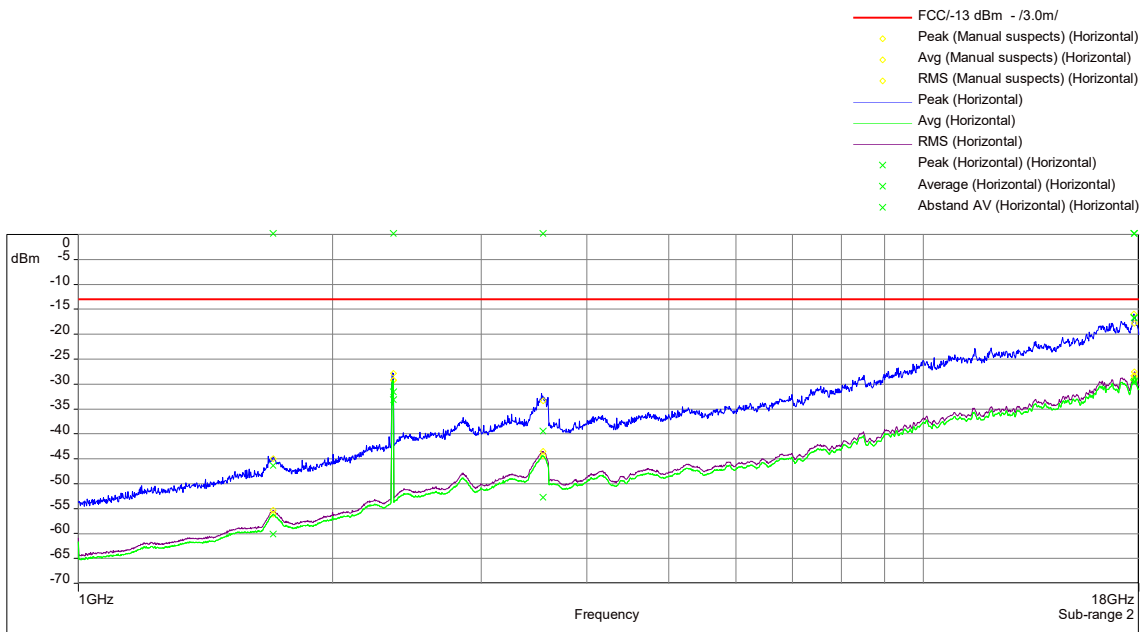
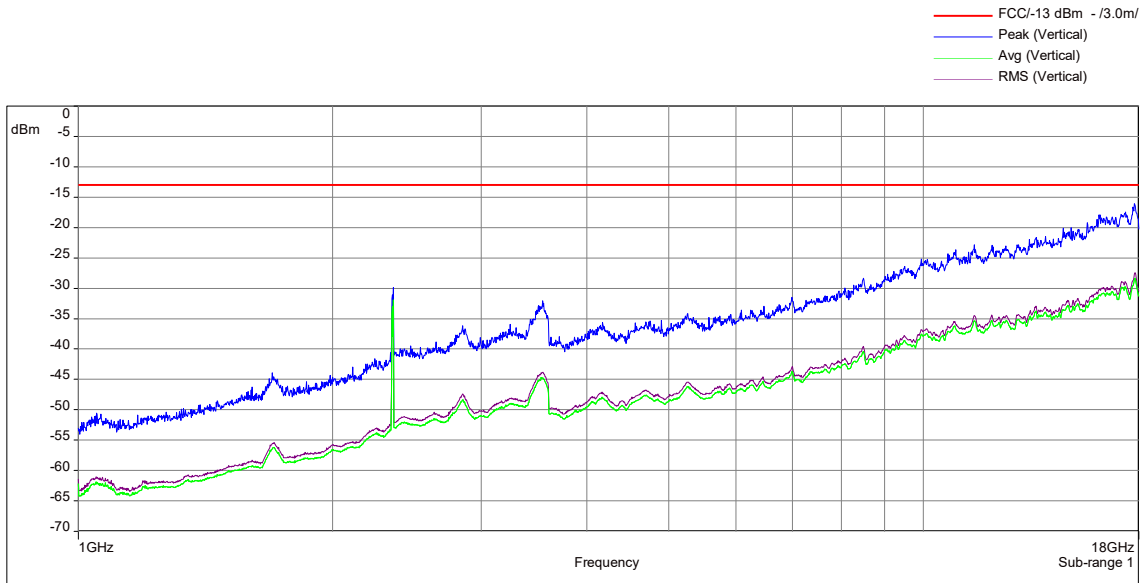



BUREAU
VERITAS

EffectiveECL-TA-20-010-V01.00

TA tests on Andrew CAP MX AC 6/7E/80-
85/17E/19/23/25T

Frequency Band = WCS 2300, Test Frequency = low, Direction = RF downlink

18 GHz - 27 GHz

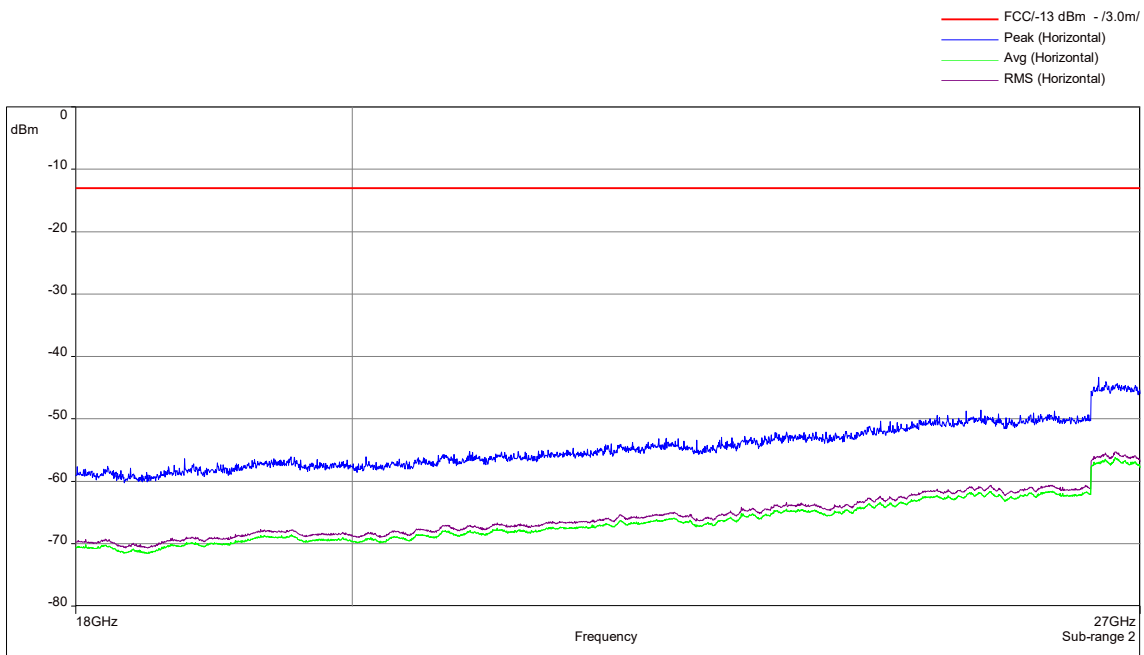
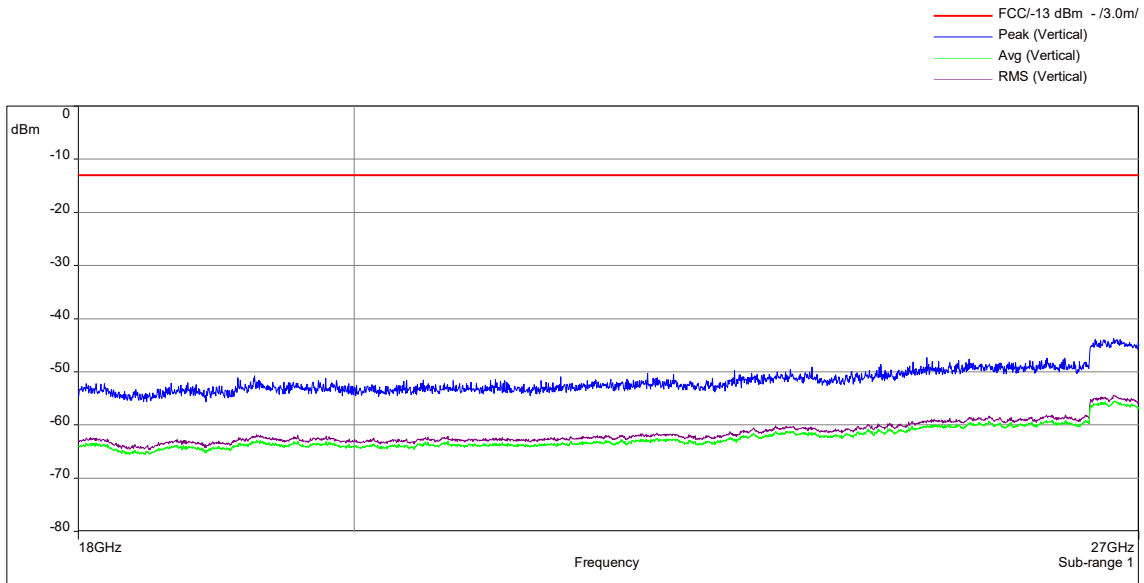



**BUREAU
VERITAS**

EfectiveECL-TA-20-010-V01.00

TA tests on Andrew CAP MX AC 6/7E/80-
85/17E/19/23/25T

4.7.5 FIELD STRENGTH CALCULATIONS

$$\mathbf{FS} = \mathbf{SA} + \mathbf{AF} + \mathbf{CL} + \mathbf{PA}$$

Where as:

- FS** = Field strength
- SA** = EMC test receiver reading
- AF** = Antenna factor
- CL** = Cable loss
- PA** = Preamplifier

4.7.6 TEST EQUIPMENT USED

- Radiated Emissions



**BUREAU
VERITAS**

Effective ECL-TA-20-010-V01.00

TA tests on Andrew CAP MX AC 6/7E/80-
85/17E/19/23/25T

5 TEST EQUIPMENT

1 Conducted

Ref.No.	Type	Description	Manufacturer	Inventory no.	Last Calibration	Calibration Due
1.1	FSV40	Signal Analyzer 10 Hz - 40 GHz	Rohde & Schwarz	E2050	2019-10	2020-10
1.2	SMBV100A	Vector Signal Generator 9 kHz - 6 GHz	Rohde & Schwarz	G2089	2017-08/ 2020-08	2022-08
1.3	SMIQ	Vector Signal Generator 9 kHz - 3.3 GHz	Rohde & Schwarz	G1509	2018-10	2021-10
1.4	SMIQ	Vector Signal Generator 9 kHz - 3.3 GHz	Rohde & Schwarz	G1510	2018-10	2021-10
1.5	ESH3-Z5	Line Impedance Stabilisation Network (LISN) 150 Hz - 30 MHz	Rohde & Schwarz	K794	2019-02	2020-10
1.6	30.3015	ThermoHygro Datalogger	TFA	X 507	2018-08	2021-08
1.7	BAT-EMC	Software	Nexio	V3.17.0.26	---	---

2 Radiated Emissions

Ref.No.	Type	Description	Manufacturer	Inventory no.	Last Calibration	Calibration Due
2.1	ESU40	EMI test receiver 10 Hz - 40 GHz	Rohde & Schwarz	E2025	2018-10	2020-10
2.2	HFH2-Z2	Antenna 9 kHz - 30 MHz	Rohde & Schwarz	K549	2018-10	2020-10
2.3	CBL 6111C	Antenna 30 MHz - 1 GHz	Chase	K1026	2020-01	2021-01
2.4	HL 025	Antenna 1 GHz - 18 GHz	Rohde & Schwarz	K1114	2019-06	2021-06
2.5	MWH-1826/B	Antenna 18 GHz - 26.5 GHz	ARA Inc.	K1042	2018-11	2020-11
2.6	MWH-2640/B	Antenna 26 GHz - 40 GHz	ARA Inc.	K1043	2018-11	2020-11
2.7	AM1431	Pre amplifier 10 kHz - 1 GHz	Miteq	K1721	2019-10	2020-10
2.8	AFS4-00102000	Preamplifier 100 MHz - 20 GHz	Miteq	K817	2019-08	2021-08.
2.9	AFS4-00102000	Preamplifier 100 MHz - 20 GHz	Miteq	K838	2019-10	2020-10
2.10	JS43-1800-4000	Preamplifier 18 GHz - 40 GHz	Miteq	K1104	2019-05	2020-10
2.11	BAT-EMC	Software	Nexio	V3.17.0.26	---	---



Effective ECL-TA-20-010-V01.00

TA tests on Andrew CAP MX AC 6/7E/80-85/17E/19/23/25T

6 ANTENNA FACTORS, CABLE LOSS AND SAMPLE CALCULATIONS

This chapter contains the antenna factors with their corresponding path loss of the used measurement path for all antennas.

6.1 ANTENNA CHASE CBL 6111C (30 MHZ – 1 GHZ)

(d = 10 m)

Frequency	AF Horizontal R&S CBL 6111C	AF Vertikal R&S CBL 6111C	Corr.
30	47.9	38.1	-38.1
50	34.4	26.4	-38.0
100	31.6	32.8	-38.0
150	33.7	33.9	-37.9
200	30.3	32.8	-37.7
250	33.6	36.5	-37.5
300	34.5	36.8	-37.1
350	36.3	37.2	-37.0
400	36.9	38.3	-36.8
450	38.0	39.6	-36.5
500	39.2	40.4	-36.0
550	41.2	42.1	-35.9
600	41.6	41.7	-35.7
650	41.9	42.9	-35.9
700	42.3	43.4	-35.6
750	43.5	43.9	-35.7
800	43.6	44.6	-36.0
850	45.0	45.1	-36.1
900	45.2	45.1	-36.6
950	46.4	46.4	-36.4
1000	45.8	47.0	-36.0

cable loss (antenna - pre-amp)	pre-amp	cable loss (inside chamber)	cable loss (to receiver)
-0,01	-38.3	0.0	0.1
0,28	-38.4	0.3	0.1
0,52	-38.7	0.5	0.2
0,73	-38.8	0.7	0.2
0,95	-38.9	1.0	0.3
1,10	-38.9	1.1	0.3
1,20	-38.6	1.2	0.3
1,29	-38.6	1.3	0.3
1,36	-38.5	1.4	0.3
1,42	-38.2	1.4	0.4
1,48	-37.9	1.5	0.4
1,54	-37.8	1.5	0.4
1,60	-37.7	1.6	0.4
1,64	-38.0	1.6	0.5
1,71	-37.8	1.7	0.5
1,76	-38.0	1.8	0.5
1,80	-38.3	1.8	0.5
1,84	-38.4	1.8	0.5
1,91	-39.0	1.9	0.5
1,93	-38.9	1.9	0.6
1,99	-38.6	2.0	0.6

Sample calculation

$E \text{ (dB } \mu\text{V/m)} = U \text{ (dB } \mu\text{V)} + AF \text{ (dB 1/m)} + Corr. \text{ (dB)}$
 U = Receiver reading
 AF = Antenna factor
 Corr. = sum of single correction factors of used cables, switch unit, distance correction, amplifier (if applicable)
 distance correction = $-20 * LOG (d_{Limit} / d_{used})$
 Linear interpolation will be used for frequencies in between the values in the table.
 Tables show an extract of values.



EfectiveECL-TA-20-010-V01.00

TA tests on Andrew CAP MX AC 6/7E/80-85/17E/19/23/25T

6.2 ANTENNA ROHDE & SCHWARZ HL 025 (1 GHZ – 18 GHZ)

Frequency	AF R&S HL 025	Corr.
MHz	dB (1/m)	dB
1000	33.2	-18.9
2000	39.4	-17.8
3000	42.8	-17.0
4000	45.1	-16.6
5000	46.8	-16.6
6000	48.5	-16.7
7000	50.2	-16.2
8000	50.4	-15.3
9000	51.9	-14.4
10000	53.8	-14.0
11000	54.5	-14.1
12000	55.3	-14.4
13000	55.7	-14.7
14000	56.5	-14.8
15000	56.4	-14.7
16000	57.2	-14.3
17000	57.6	-14.5
18000	57.6	-14.6

pre-amp	cable loss (to receiver)
dB	dB
-20.92	2.01
-20.60	2.78
-20.44	3.42
-20.58	3.99
-21.08	4.46
-21.53	4.87
-21.53	5.35
-20.97	5.66
-20.44	6.05
-20.43	6.45
-20.84	6.69
-21.41	7.04
-22.09	7.36
-22.48	7.66
-22.56	7.90
-22.49	8.20
-22.90	8.45
-23.27	8.71

Sample calculation

$E \text{ (dB } \mu\text{V/m)} = U \text{ (dB } \mu\text{V)} + AF \text{ (dB 1/m)} + Corr. \text{ (dB)}$
 U = Receiver reading
 AF = Antenna factor
 Corr. = sum of single correction factors of used cables, switch unit, distance correction, amplifier (if applicable)
 Linear interpolation will be used for frequencies in between the values in the table.
 Tables show an extract of values.



EffectiveECL-TA-20-010-V01.00

TA tests on Andrew CAP MX AC 6/7E/80-85/17E/19/23/25T

6.3 ANTENNA ARA INC. MWH-1826-B (18 GHZ – 26.5 GHZ) PARTIALLY IN CONJUNCTION WITH PRE-AMPLIFIER MITEQ JS43-1800-4000: THE USE OF THE PRE-AMPLIFIER IS DEPENDENT FROM THE FIELD STRENGTH

Frequency	AF	Corr.
MHz	EMCO 3160-09 dB (1/m)	dB
18000	44.3	-37.5
18500	43.9	-37.6
19000	44.4	-36.9
19500	44.1	-36.1
20000	44.6	-36.3
20500	44.9	-36.1
21000	45.2	-35.9
21500	45.0	-35.7
22000	45.1	-35.3
22500	45.4	-35.0
23000	45.7	-35.6
23500	45.8	-34.3
24000	45.3	-34.8
24500	45.3	-35.0
25000	46.1	-34.3
25500	46.5	-34.2
26000	46.7	-34.8
26500	46.5	-34.4
27000	46.4	-35.1

pre-amp	cable loss (to receiver)
dB	dB
-46.2	8.7
-46.4	8.8
-45.9	9.0
-45.2	9.1
-45.6	9.3
-45.5	9.4
-45.3	9.4
-45.3	9.7
-45.1	9.8
-44.8	9.8
-45.5	9.9
-44.4	10.1
-45.0	10.2
-45.3	10.4
-44.8	10.5
-44.7	10.5
-45.4	10.6
-45.1	10.7
-46.0	10.9

Sample calculation

$E \text{ (dB } \mu\text{V/m)} = U \text{ (dB } \mu\text{V)} + AF \text{ (dB 1/m)} + Corr. \text{ (dB)}$
 U = Receiver reading
 AF = Antenna factor
 Corr. = sum of single correction factors of used cables, switch unit, distance correction, amplifier (if applicable)
 Linear interpolation will be used for frequencies in between the values in the table.
 Table shows an extract of values.



**BUREAU
VERITAS**

Effective ECL-TA-20-010-V01.00

TA tests on Andrew CAP MX AC 6/7E/80-
85/17E/19/23/25T

7 MEASUREMENT UNCERTAINTIES

KDB 935210 D05	ECL
Power measurement	0,68 dB
Measuring AGC threshold level	0,90 dB
Out of band rejection	0,90 dB
Input-versus-output signal comparison	0,91 dB
Mean power output	0,90 dB
Measuring out-of-band/out-of-block (including intermodulation) emissions and spurious emissions	0,90 dB
Out-of-band/out-of-block emissions conducted measurements	0,90 dB
Spurious emissions conducted	2,18 dB
Spurious emissions radiated measurements	5,38 dB
Total frequency uncertainty	2×10^{-7}

Reference :

ECL-MU5.4.6.3-EMC-14-001-V03.00 MU Wireless.xlsx

EfectiveECL-TA-20-010-V01.00

TA tests on Andrew CAP MX AC 6/7E/80-85/17E/19/23/25T

8 PHOTO REPORT

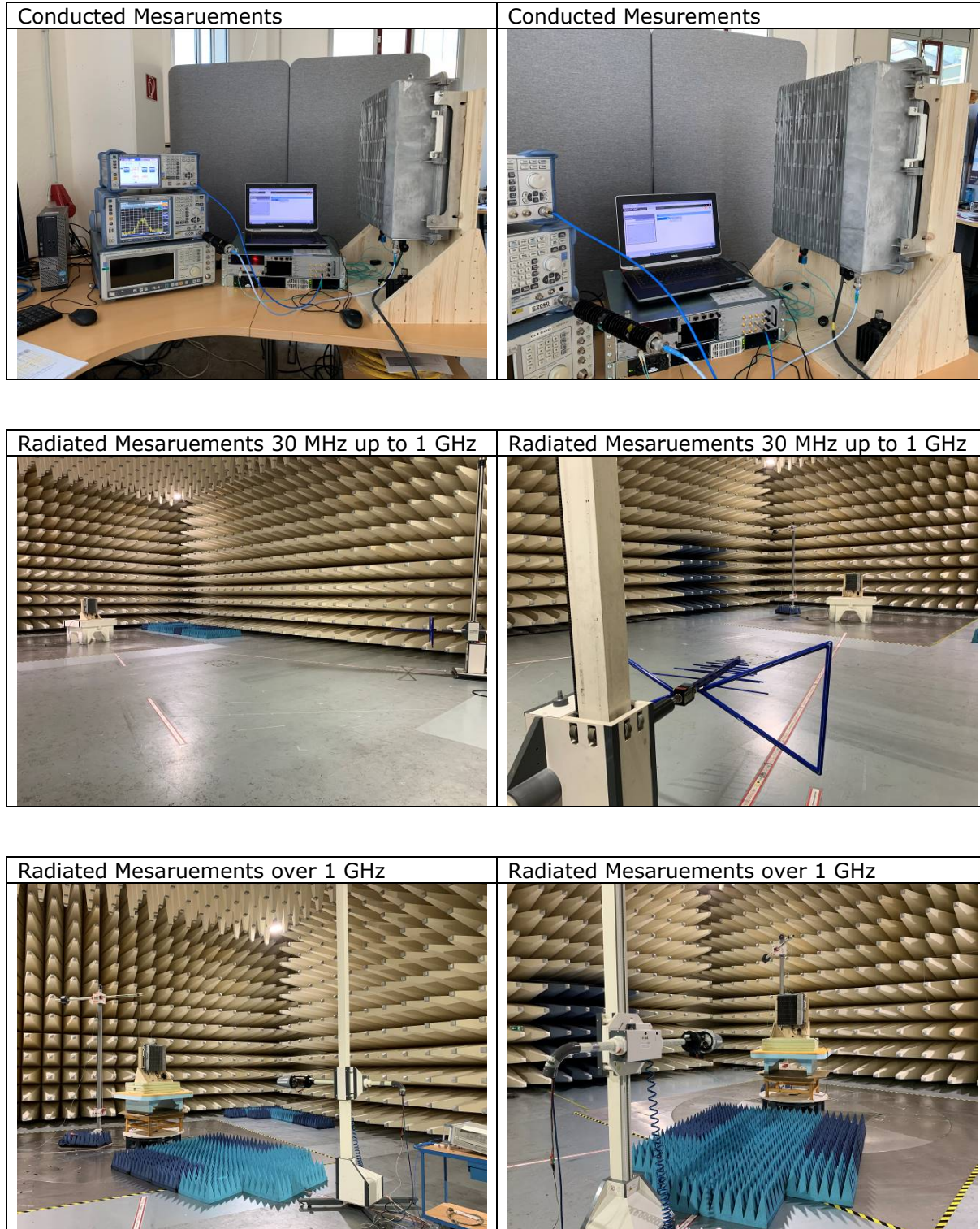



**BUREAU
VERITAS**

EffectiveECL-TA-20-010-V01.00

TA tests on Andrew CAP MX AC 6/7E/80-
85/17E/19/23/25T

Annex A: Accreditation certificate (for information)

The accreditation relates to competences stated on the accreditation certificate. The current certificate is available on the homepage of the DAkkS and can be downloaded under accredited bodies with the processing number:

<https://www.dakks.de/en>



BUREAU
VERITAS

EfectiveECL-TA-20-010-V01.00

TA tests on Andrew CAP MX AC 6/7E/80-
85/17E/19/23/25T

Annex B: Additional information provided by client

None.

***** End of test report *****