



## ECL-TA Test Report No.: 20-002

Designation:	CAP MX AC 6/7E/80-85/17E/19/23/25T
Manufacturer:	Andrew
Serial No(s):	8
ID No.	7830127-0001, Rev.: 00
Test Specification(s):	ANSI 63.26:2015 FCC Rules and Regulations as listed in 47 CFR, Part 20:2019-10-01
Test Plan:	Measurement of Band 13/USA 750, downlink.
<b>Test Result:</b>	<b>Passed</b>

Date of issue:	2020-10-23		Signature:
Version:	01	Technical Reviewer:	
Date of delivery:	2020-07		
Performance date:	2020-07-07. – 2020-09-09	Report Reviewer:	



The test results relates only to the tested item. The sample has been provided by the client.  
Without the written consent of Bureau Veritas Consumer Products Services Germany GmbH excerpts of this report shall not be reproduced.

Bureau Veritas  
Consumer Products Services Germany GmbH  
www.bureauveritas.de/cps  
Phone: +49 (0)40 – 740 41 – 0

Schwerin  
Wilhelm-Hennemann-Str. 8, 19061 Schwerin  
cps-schwerin@de.bureauveritas.com

Tuerkheim  
Businesspark A96, 86842 Tuerkheim  
cps-tuerkheim@de.bureauveritas.com

Managing Director: Sebastian Doose/Stefan Kischka  
Reg.No.: Schwerin HRB 3564

Hamburg  
Oehleckerring 40, 22419 Hamburg  
cps-hamburg@de.bureauveritas.com

Nuremberg  
Thurn-und-Taxis-Str. 18, 90411 Nuremberg  
cps-nuernberg@de.bureauveritas.com



**BUREAU  
VERITAS**

**ECL-TA-20-002-V01.00**

TA tests on Andrew CAP MX AC 6/7E/80-  
85/17E/19/23/25T

---

Commscope

**Client:**

Andrew Wireless System GmbH

Industriering 10

86675 Buchdorf Germany

**Test Laboratory:**

Bureau Veritas Consumer Products Services Germany GmbH

Thurn-und-Taxis-Straße 18

D-90411 Nürnberg

Tel.: +49 40 74041 0

Fax: +49 40 74041-2755

**Versions management:**

V01.00

Initial release



**ECL-TA-20-002-V01.00**

TA tests on Andrew CAP MX AC 6/7E/80-  
85/17E/19/23/25T

Table of Contents

1	APPLIED STANDARDS AND TEST SUMMARY .....	4
1.1	APPLIED STANDARDS .....	4
1.2	FCC-IC CORRELATION TABLE .....	5
1.3	MEASUREMENT SUMMARY/SIGNATURES .....	6
2	ADMINISTRATIVE DATA .....	9
2.1	TESTING LABORATORY .....	9
2.2	APPLICANT DATA .....	9
2.3	MANUFACTURER DATA .....	9
3	TEST OBJECT DATA.....	10
3.1	GENERAL EUT DESCRIPTION .....	10
3.2	EUT MAIN COMPONENTS .....	11
3.3	ANCILLARY EQUIPMENT .....	11
3.4	AUXILIARY EQUIPMENT.....	12
3.5	EUT SETUPS.....	13
3.6	PRODUCT LABELLING.....	14
4	TEST RESULTS .....	15
4.1	EFFECTIVE RADIATED POWER, MEAN OUTPUT POWER AND ZONE ENHANCER GAIN 15	
4.2	PEAK TO AVERAGE RATIO .....	23
4.3	OCCUPIED BANDWIDTH/INPUT-VERSUS-OUTPUT SPECTRUM.....	27
4.4	CONDUCTED SPURIOUS EMISSIONS AT ANTENNA TERMINALS.....	35
4.5	OUT-OF-BAND EMISSION LIMITS .....	43
4.6	OUT-OF-BAND REJECTION .....	54
4.7	FIELD STRENGTH OF SPURIOUS RADIATION.....	56
5	TEST EQUIPMENT .....	65
6	ANTENNA FACTORS, CABLE LOSS AND SAMPLE CALCULATIONS .....	66
6.1	ANTENNA CHASE CBL 6111C (30 MHZ – 1 GHZ) .....	66
6.2	ANTENNA ROHDE & SCHWARZ HL 025 (1 GHZ – 18 GHZ) .....	67
6.3	ANTENNA ARA INC. MWH-1826-B (18 GHZ – 26.5 GHZ) PARTIALLY IN CONJUNCTION WITH PRE-AMPLIFIER MITEQ JS43-1800-4000: THE USE OF THE PRE-AMPLIFIER IS DEPENDENT FROM THE FIELD STRENGTH .....	68
7	MEASUREMENT UNCERTAINTIES.....	69
8	PHOTO REPORT .....	70
	Annex A: Accreditation certificate (for information) .....	71
	Annex B: Additional information provided by client.....	72



**BUREAU  
VERITAS**

## **ECL-TA-20-002-V01.00**

TA tests on Andrew CAP MX AC 6/7E/80-  
85/17E/19/23/25T

---

### **1 APPLIED STANDARDS AND TEST SUMMARY**

#### **1.1 APPLIED STANDARDS**

##### **Type of Authorization**

Certification for an Industrial Signal Booster.

##### **Applicable FCC Rules**

Prepared in accordance with the requirements of FCC Rules and Regulations as listed in 47 CFR Ch.1 Parts 2 and 20, 27. The following subparts are applicable to the results in this test report.

Part 2, Subpart J - Equipment Authorization Procedures, Certification

Part 20, Commercial Mobiles Services

§ 20.21 Signal Boosters

Part 27; Miscellaneous Wireless Communications Services  
Subpart C – Technical standards

§ 27.50 – Power and duty cycle limits

§ 27.53 – Emission limits

§ 27.54 – Frequency stability

The tests were selected and performed with reference to:

- FCC Public Notice 935210 applying "Signal Boosters Basic Certification Requirements" 935210 D02, 2019-15-04.
- FCC Public Notice 935210 applying "Measurement guidance for industrial and non-consumer signal booster, repeater and amplifier devices" 935210 D05, 2019-04-03.
- FCC Public Notice 971168 applying "Measurement guidance for certification of licensed digital transmitters" 971168 D01, 2019-04-09.
- ANSI C63.26: 2015

**ECL-TA-20-002-V01.00**

TA tests on Andrew CAP MX AC 6/7E/80-85/17E/19/23/25T

**Summary Test Results:**

The EUT complies with all performed tests as listed in chapter 1.3 Measurement Summary/Signatures.

1.2 FCC-IC CORRELATION TABLE

**Correlation of measurement requirements for Industrial Signal Booster from FCC and ISED Canada**

Measurement	FCC reference	ISED reference
Effective radiated power, mean output power and zone enhancer gain	§ 2.1046 § 27.50 KDB 935210 D05 v01r04: 3.5	RSS-GEN Issue 5, 6.12 RSS-130 Issue 2, 4.6 SRSP-518, Issue 2, 5.1 RSS-131 Issue 3: 5.2.3
Peak to Average Ratio	§ 27.50	RSS-130 Issue 2, 4.6
Occupied bandwidth Input-versus-output spectrum	§ 2.1049 KDB 935210 D05 v01r04: 3.4	RSS-GEN Issue 5, 6.7 RSS-131 Issue 3: 5.2.2
Conducted spurious Emission at Antenna Terminal	§ 2.1051 § 27.53 KDB 935210 D05 v01r04: 3.6	RSS-GEN Issue 5, 6.13 RSS-130 Issue 1: 4.7
Out-of-band emissions limits	§ 2.1051 § 27.53 KDB 935210 D05 v01r04: 3.6	RSS-GEN Issue 5, 6.13 RSS-130 Issue 2: 4.7
Frequency stability	§ 2.1055 § 27.54	RSS-GEN Issue 5, 6.11 RSS-130 Issue 2: 4.5 RSS-131 Issue 3: 5.2.4
Field strength of spurious radiation	§ 2.1053 § 27.53	RSS-GEN Issue 5, 6.13 RSS-130 Issue 2: 4.7
Out-of-band rejection	KDB 935210 D05 v01r04: 3.3	RSS-131 Issue 3: 5.2.1
All measurements	ANSI 63.26	ANSI 63.26



**BUREAU  
VERITAS**

**ECL-TA-20-002-V01.00**

TA tests on Andrew CAP MX AC 6/7E/80-  
85/17E/19/23/25T

**1.3 MEASUREMENT SUMMARY/SIGNATURES**

**47 CFR CHAPTER I FCC PART 27 Subpart C [Base § 2.1046, § 27.50  
Stations/Repeater]**

Effective Radiated Power, mean output power and zone enhancer gain  
The measurement was performed according to ANSI C63.26, KDB  
935210 D05 v01r04: 3.5

**Final Result**

**OP-Mode**

Frequency Band, Direction, Input Power, Signal Type  
Band 13 USA 750, RF downlink, 0.3 dB < AGC, Narrowband  
Band 13 USA 750, RF downlink, 0.3 dB < AGC, Wideband  
Band 13 USA 750, RF downlink, 3 dB > AGC, Narrowband  
Band 13 USA 750, RF downlink, 3 dB > AGC, Wideband

<b>FCC</b>	<b>IC</b>
Passed	Passed
Passed	Passed
Passed	Passed
Passed	Passed

**47 CFR CHAPTER I FCC PART 27 Subpart C [Base § 27.50  
Stations/Repeater]**

Peak to Average Ratio  
The measurement was performed according to ANSI C63.26

**Final Result**

**OP-Mode**

Frequency Band, Direction, Input Power, Signal Type  
Band 13 USA 750, RF downlink, 0.3 dB < AGC, Narrowband  
Band 13 USA 750, RF downlink, 0.3 dB < AGC, Wideband  
Band 13 USA 750, RF downlink, 3 dB > AGC, Narrowband  
Band 13 USA 750, RF downlink, 3 dB > AGC, Wideband

<b>FCC</b>	<b>IC</b>
Passed	Passed
Passed	Passed
Passed	Passed
Passed	Passed

**47 CFR CHAPTER I FCC PART 27 Subpart C [Base § 2.1049  
Stations/Repeater]**

Occupied Bandwidth/Input-versus-output Spectrum  
The measurement was performed according to ANSI C63.26, KDB  
935210 D05 v01r04: 3.4

**Final Result**

**OP-Mode**

Frequency Band, Direction, Input Power, Signal Type  
Band 13 USA 750, RF downlink, 0.3 dB < AGC, Narrowband  
Band 13 USA 750, RF downlink, 0.3 dB < AGC, Wideband  
Band 13 USA 750, RF downlink, 3 dB > AGC, Narrowband  
Band 13 USA 750, RF downlink, 3 dB > AGC, Wideband

<b>FCC</b>	<b>IC</b>
Passed	Passed
Passed	Passed
Passed	Passed
Passed	Passed



**ECL-TA-20-002-V01.00**

TA tests on Andrew CAP MX AC 6/7E/80-85/17E/19/23/25T

**47 CFR CHAPTER I FCC PART 27 Subpart C [Base § 2.1051, § 27.53 Stations/Repeater]**

Conducted spurious emissions at antenna terminals

The measurement was performed according to ANSI C63.26

**Final Result**

**OP-Mode**

Frequency Band, Direction, Input Power, Signal Type

Band 13 USA 750, RF downlink, 0.3 dB < AGC, Narrowband

Band 13 USA 750, RF downlink, 0.3 dB < AGC, Wideband

Band 13 USA 750, RF downlink, 3 dB > AGC, Narrowband

Band 13 USA 750, RF downlink, 3 dB > AGC, Wideband

**FCC**

**IC**

Passed

Passed

Passed

Passed

Passed

Passed

Passed

Passed

**47 CFR CHAPTER I FCC PART 27 Subpart C [Base § 2.1051, § 27.53 Stations/Repeater]**

Out-of-band emission limits

The measurement was performed according to ANSI C63.26, KDB

935210 D05 v01r04: 3.6

**Final Result**

**OP-Mode**

Band Edge, Frequency Band, Number of signals, Direction, Input Power, Signal Type

Lower, Band 13 USA 750, 1, RF downlink, 0.3 dB < AGC, Narrowband

Lower, Band 13 USA 750, 1, RF downlink, 0.3 dB < AGC, Wideband

Lower, Band 13 USA 750, 1, RF downlink, 3 dB > AGC, Narrowband

Lower, Band 13 USA 750, 1, RF downlink, 3 dB > AGC, Wideband

Lower, Band 13 USA 750, 2, RF downlink, 0.3 dB < AGC, Narrowband

Lower, Band 13 USA 750, 2, RF downlink, 0.3 dB < AGC, Wideband

Lower, Band 13 USA 750, 2, RF downlink, 3 dB > AGC, Narrowband

Lower, Band 13 USA 750, 2, RF downlink, 3 dB > AGC, Wideband

**FCC**

**IC**

Passed

Passed

Passed

Passed

Passed

Passed

Passed

Passed

Passed

Passed

Passed

Passed

Passed

Passed

Passed

Passed

**47 CFR CHAPTER I FCC PART 27 Subpart C [Base § 2.1051, § 27.53 Stations/Repeater]**

Out-of-band emission limits

The measurement was performed according to ANSI C63.26, KDB

935210 D05 v01r04: 3.6

**Final Result**

**OP-Mode**

Band Edge, Frequency Band, Number of signals, Direction, Input Power, Signal Type

Upper, Band 13 USA 750, 1, RF downlink, 0.3 dB < AGC, Narrowband

Upper, Band 13 USA 750, 1, RF downlink, 0.3 dB < AGC, Wideband

Upper, Band 13 USA 750, 1, RF downlink, 3 dB > AGC, Narrowband

Upper, Band 13 USA 750, 1, RF downlink, 3 dB > AGC, Wideband

Upper, Band 13 USA 750, 2, RF downlink, 0.3 dB < AGC, Narrowband

Upper, Band 13 USA 750, 2, RF downlink, 0.3 dB < AGC, Wideband

Upper, Band 13 USA 750, 2, RF downlink, 3 dB > AGC, Narrowband

Upper, Band 13 USA 750, 2, RF downlink, 3 dB > AGC, Wideband

**FCC**

**IC**

Passed

Passed

Passed

Passed

Passed

Passed

Passed

Passed

Passed

Passed

Passed

Passed

Passed

Passed

Passed

Passed



**ECL-TA-20-002-V01.00**

TA tests on Andrew CAP MX AC 6/7E/80-85/17E/19/23/25T

---

**47 CFR CHAPTER I FCC PART 27 Subpart C [Base Stations/Repeater] KDB 935210 D05 v01r04: 3.3**

---

Out-of-band rejection

The measurement was performed according to ANSI C63.26

**Final Result**

**OP-Mode**

Frequency Band, Direction

**Setup**

**FCC**

**IC**

Band 13 USA 750, RF downlink

S01\_AA01

Passed

Passed

---

**47 CFR CHAPTER I FCC PART 27 Subpart C [Base Stations/Repeater] § 2.1053, § 27.53**

---

Field strength of spurious radiation

The measurement was performed according to ANSI C63.26

**Final Result**

**OP-Mode**

Frequency Band, Test Frequency, Direction

**FCC**

**IC**

Band 13 USA 750, high, RF downlink

Passed

Passed

Band 13 USA 750, low, RF downlink

Passed

Passed

Band 13 USA 750, mid, RF downlink

Passed

Passed

The test case frequency stability was not performed, since the EUT is not equipped with signal processing capabilities.





**ECL-TA-20-002-V01.00**

TA tests on Andrew CAP MX AC 6/7E/80-  
85/17E/19/23/25T

---

**2 ADMINISTRATIVE DATA**

**2.1 TESTING LABORATORY**

Bureau Veritas Consumer Products Services Germany GmbH  
Thurn-und-Taxis-Straße 18  
D-90411 Nürnberg  
Tel.: +49 40 74041 0  
Fax: +49 40 74041-2755

**2.2 APPLICANT DATA**

Company Name: Commscope  
Andrew Wireless Systems GmbH

Address: Industriering 10  
86675 Buchdorf  
Germany

Contact Person: Mr. Frank Futter

**2.3 MANUFACTURER DATA**

Company Name: Please see applicant data.

Address:



**ECL-TA-20-002-V01.00**

TA tests on Andrew CAP MX AC 6/7E/80-85/17E/19/23/25T

**3 TEST OBJECT DATA**

**3.1 GENERAL EUT DESCRIPTION**

Kind of Device product description	Cellular Repeater
Product name	Cellular Repeater
Type	
<b>Declared EUT data by the supplier</b>	
General Product Description	The EUT is an industrial signal booster supporting the following: Band 5/CELL 850 Band 13/USA 700E Band 13/USA 750 Band 14/LMR 750 Band 25/PCS 1900 Band 27/CELL 800 Band 30/WCS 2300 Band 41/BRS Band 66/AWS 1700E (partly) Band 70/Band 70 Band 71/USA 600  A RF operation is only supported for the downlink.
Booster Type	Industrial Signal Booster
Voltage Type	AC/50 Hz – 60 Hz
Voltage Level	100 V - 240 V
Maximum Output Donor Port [Uplink]	-
Nominal Output Server Port [Downlink]	All bands: 33 dBm
Nominal Gain [Uplink]	-
Nominal Gain [Downlink]	All bands: 33 dB

**The main components of the EUT are listed and described in chapter 3.2 EUT Main components.**



**ECL-TA-20-002-V01.00**

TA tests on Andrew CAP MX AC 6/7E/80-  
85/17E/19/23/25T

---

**3.2 EUT MAIN COMPONENTS**

<b>Sample Name</b>	<b>FCC-ID</b>	<b>IC-ID</b>
	XS5-CAPMX	2237E-CAPMX
<b>Sample Parameter</b>	<b>Value</b>	
Serial Number	8	
HW Version	7830127-0001 Rev.: 00	
SW Version	2.9.0.292	
Comment	-----	

NOTE: The short description is used to simplify the identification of the EUT in this test report.

**3.3 ANCILLARY EQUIPMENT**

For the purposes of this test report, ancillary equipment is defined as equipment which is used in conjunction with the EUT to provide operational and control features to the EUT. It is necessary to configure the system in a typical fashion, as a customer would normally use it. But nevertheless Ancillary Equipment can influence the test results.

<b>Device</b>	<b>Details (Manufacturer, Type Model, OUT Code)</b>	<b>Description</b>
-	-	-



**ECL-TA-20-002-V01.00**

TA tests on Andrew CAP MX AC 6/7E/80-  
85/17E/19/23/25T

---

### 3.4 AUXILIARY EQUIPMENT

For the purposes of this test report, auxiliary equipment is defined as equipment which is used temporarily to enable operational and control features especially used for the tests of the EUT which is not used during normal operation or equipment that is used during the tests in combination with the EUT but is not subject of this test report. It is necessary to configure the system in a typical fashion, as a customer would normally use it. But nevertheless Auxiliary Equipment can influence the test results.

<b>Device</b>	<b>Details (Manufacturer; Type; S/N)</b>	<b>Description</b>
AUX1	Commscope/General Electric; ION-E PSU Shelf, AC; DM77662	Rack in Conjunction with AUX 2
AUX2	Commscope/General Electric; Power Supply Unit; LBGPE17KZ39047532	Power Supply
AUX3	Commscope; ION-E WCS-2; SZAEAJ1952A0032	Subrack in Conjunction with AUX 4, 5,6, 7 and 8
AUX4	Commscope; ION-E OPT; SZBEAD1951A0011	Optical Card
AUX5	Commscope; ION-E SUI; SZBEAC1746A0015	LAN System Interface
AUX6	Commscope; ION-E RFD; SZBEAP1920A0057	RF Card
AUX7	Commscope; ION-E RFD; SZBEAP1924A0023	RF Card
AUX 8	Commscope; ION-E RFD; SZBEAP1946A0003	RF Card



**ECL-TA-20-002-V01.00**

TA tests on Andrew CAP MX AC 6/7E/80-85/17E/19/23/25T

**3.5 EUT SETUPS**

This chapter describes the combination of EUTs and equipment used for testing. The rationale for selecting the EUTs, ancillary and auxiliary equipment and interconnecting cables, is to test a representative configuration meeting the requirements of the referenced standards.

Setup	Combination of EUTs	Description and Rationale
		Setup for all tests

**OPERATING MODES**

This chapter describes the operating modes of the EUT used for testing.

**3.5.1 TEST CHANNELS**

Band	Direction	Lower Frequency Band Edge [MHz]	Upper Frequency Band Edge [MHz]	Center Frequency [MHz]	Port
13 (USA 750)	Downlink	746.00	756.00	751.00	Donor

**3.5.2 AUTOMATIC GAIN CONTROL LEVELS**

AGC Levels							
Band	Direction	Signal Type	AGC Start Pin [dBm]	AGC Start Pin -0.3 dB [dBm]	AGC Start Pin +3 dB [dBm]	Frequency [MHz]	Frequency
13	Downlink	Narrowband	-2.8	-3.1	0.2	751.00	Mid
13	Downlink	Wideband	-3.0	-3.3	0.0	751.00	
13	Downlink	Narrowband	-3.4	-3.7	-0.4	746.20	Low
13	Downlink	Wideband	-3.2	-3.5	-0.2	748.50	
13	Downlink	Narrowband	-2.8	-3.1	0.2	755.80	High
13	Downlink	Wideband	-2.8	-3.1	0.2	753.50	
13	Downlink	Narrowband	-3.4	-3.7	-0.4	746.20	Max.Power
13	Downlink	Wideband	-3.2	-3.5	-0.2	748.50	

Remark:

If the measured frequency  $f_0$  for the max power has a too low distance to the band edges, because in the tests modulated signals must be used: The next possible frequency to the according band edge is used.

For example for minimum distances to the band edges:

GSM-Signal (narrowband): 0.2 MHz

AWGN-signal (wideband): 2.5 MHz



**BUREAU**  
**VERITAS**

## **ECL-TA-20-002-V01.00**

TA tests on Andrew CAP MX AC 6/7E/80-  
85/17E/19/23/25T

---

### 3.6 PRODUCT LABELLING

#### 3.6.1 FCC ID LABEL

Please refer to the documentation of the applicant.

#### 3.6.2 LOCATION OF THE LABEL ON THE EUT

Please refer to the documentation of the applicant.



## ECL-TA-20-002-V01.00

TA tests on Andrew CAP MX AC 6/7E/80-85/17E/19/23/25T

### 4 TEST RESULTS

#### 4.1 EFFECTIVE RADIATED POWER, MEAN OUTPUT POWER AND ZONE ENHANCER GAIN

Standard FCC Part 27, § 27.50

The test was performed according to:  
ANSI C63.26, KDB 935210 D05 v01r04: 3.5

Test date: 2020-07-21

Environmental conditions: 25 ° C; 40 % r. F.

Test engineer: Thomas Hufnagel

##### 4.1.1 TEST DESCRIPTION

This test case is intended to demonstrate compliance to the signal booster power and gain limits and requirements for industrial signal boosters per FCC § 27.50, RSS-130 with subparts 4.6, 4.6.1 and 4.6.1 and SRSP-518 with subparts 4 and 4.1.

The EUT was connected to the test setup according to the following diagram:

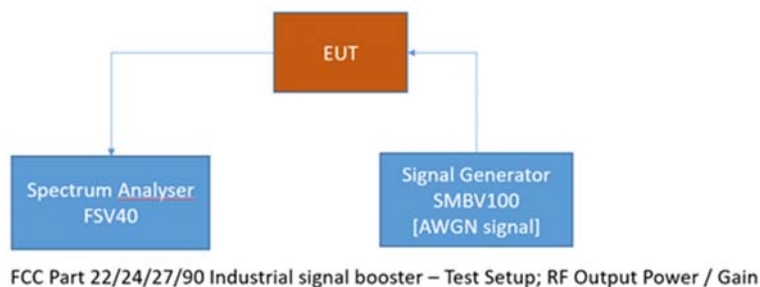

The attenuation of the measuring and stimulus path are known for each measured frequency and are considered.

The Spectrum Analyser settings can be directly found in the measurement diagrams.



## **ECL-TA-20-002-V01.00**

TA tests on Andrew CAP MX AC 6/7E/80-  
85/17E/19/23/25T

---

### 4.1.2 TEST REQUIREMENTS/LIMITS: ABSTRACTS FROM STANDARDS

#### **Part 27; Miscellaneous Wireless Communication Services**

##### **Subpart C – Technical standards**

##### **§ 27.50**

##### **Band 13:**

##### Abstract § 27.50 from FCC:

(b) The following power and antenna height limits apply to transmitters operating in the 746-758 MHz, 775-788 MHz and 805-806 MHz bands:

(1) Fixed and base stations transmitting a signal in the 757-758 and 775-776 MHz bands must not exceed an effective radiated power (ERP) of 1000 watts and an antenna height of 305 m height above average terrain (HAAT), except that antenna heights greater than 305 m HAAT are permitted if power levels are reduced below 1000 watts ERP in accordance with Table 1 of this section.

(2) Fixed and base stations transmitting a signal in the 746-757 MHz and 776-787 MHz bands with an emission bandwidth of 1 MHz or less must not exceed an ERP of 1000 watts and an antenna height of 305 m HAAT, except that antenna heights greater than 305 m HAAT are permitted if power levels are reduced below 1000 watts ERP in accordance with Table 1 of this section.

(3) Fixed and base stations located in a county with population density of 100 or fewer persons per square mile, based upon the most recently available population statistics from the Bureau of the Census, and transmitting a signal in the 746-757 MHz and 776-787 MHz bands with an emission bandwidth of 1 MHz or less must not exceed an ERP of 2000 watts and an antenna height of 305 m HAAT, except that antenna heights greater than 305 m HAAT are permitted if power levels are reduced below 2000 watts ERP in accordance with Table 2 of this section.

(4) Fixed and base stations transmitting a signal in the 746-757 MHz and 776-787 MHz bands with an emission bandwidth greater than 1 MHz must not exceed an ERP of 1000 watts/MHz and an antenna height of 305 m HAAT, except that antenna heights greater than 305 m HAAT are permitted if power levels are reduced below 1000 watts/MHz ERP in accordance with Table 3 of this section.

(5) Fixed and base stations located in a county with population density of 100 or fewer persons per square mile, based upon the most recently available population statistics from the Bureau of the Census, and transmitting a signal in the 746-757 MHz and 776-787 MHz bands with an emission bandwidth greater than 1 MHz must not exceed an ERP of 2000 watts/MHz and an antenna height of 305 m HAAT, except that antenna heights greater than 305 m HAAT are permitted if power levels are reduced below 2000 watts/MHz ERP in accordance with Table 4 of this section.





**BUREAU  
VERITAS**

## **ECL-TA-20-002-V01.00**

TA tests on Andrew CAP MX AC 6/7E/80-  
85/17E/19/23/25T

---

Abstract RSS-130 from ISED:

### **RSS-130; 4.6 Transmitter output power and effective radiated power (e.r.p.)**

The transmitter output power shall be measured in terms of average power.

For base and fixed equipment, refer to SRSP-518 for power limits

#### **4.6.1 General**

The transmitter output power shall be measured in terms of average power. In addition, the peak-to-average power ratio (PAPR) of the transmitter shall not exceed 13 dB for more than 0.1% of the time and shall use a signal corresponding to the highest PAPR during periods of continuous transmission.

#### **4.6.3 Frequency bands 698-756 MHz and 777-787 MHz**

The e.r.p. shall not exceed 30 watts for mobile equipment and outdoor fixed subscriber equipment. The e.r.p. shall not exceed 3 watts for portable equipment and indoor fixed subscriber equipment.

For base and fixed equipment other than fixed subscriber equipment, refer to SRSP-518 for the e.i.r.p. limits.



**ECL-TA-20-002-V01.00**

TA tests on Andrew CAP MX AC 6/7E/80-85/17E/19/23/25T

Abstract SRSP-518 from ISED:

**. Band plans 4**

**15. The block structure for the 700 MHz MBS band is shown in figure 2 and table 2.**

**700 MHz MBS band**

**12. The block structure for the 600 MHz band is shown in figure 1 and table 1. Figure 1: 600 MHz**

Figure 2: 700 MHz MBS band plan

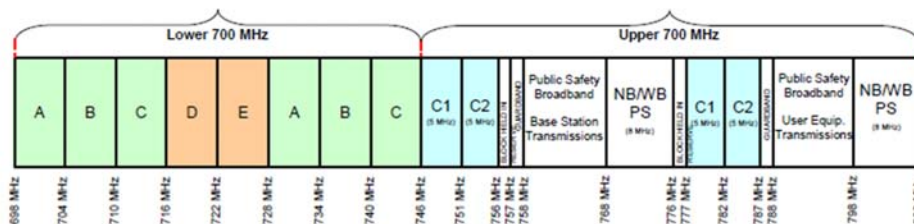

**Table 2: 700 MHz MBS band frequency blocks**

Block	Total spectrum	Uplink	Downlink
Paired Block A	12 MHz	698-704 MHz	728-734 MHz
Paired Block B	12 MHz	704-710 MHz	734-740 MHz
Paired Block C	12 MHz	710-716 MHz	740-746 MHz
Unpaired Block D	6 MHz		716-722 MHz*
Unpaired Block E	6 MHz		722-728 MHz*
Paired Block C1	10 MHz	777-782 MHz	746-751 MHz
Paired Block C2	10 MHz	782-787 MHz	751-756 MHz

\* Downlink preferred

16. For the paired 700 MHz MBS blocks A, B and C, base station transmission is in the frequency range 728-746 MHz. Transmissions from mobile, portable and fixed subscriber equipment are in the frequency range 698-716 MHz.

17. For the paired 700 MHz MBS blocks C1 and C2, base station transmission is in the frequency range 746-756 MHz. Transmissions from mobile, portable and fixed subscriber equipment are in the frequency range 777-787 MHz.

18. For the unpaired 700 MHz MBS blocks D and E, base station transmission is preferred in the frequency range 716-728 MHz.

19. Systems operating in the 700 MHz MBS band using duplexing schemes different than those outlined in paragraphs 16 to 18 may be deployed. Such systems shall not interfere with, nor claim protection from, systems deployed in accordance with paragraphs 16 to 18 and paragraph 13. Furthermore, any possible guardband requirements for systems in the unpaired blocks using different duplexing schemes than the preferred (specified in paragraph 18) shall be taken from the unpaired 700 MHz MBS D and E blocks.



## **ECL-TA-20-002-V01.00**

TA tests on Andrew CAP MX AC 6/7E/80-  
85/17E/19/23/25T

---

### **5.2 Technical Criteria**

20. This section covers technical criteria in regards to e.i.r.p., antenna height and use of multiple-input multiple-output (MIMO) antennas.

#### **5.2.1 Radiated power and antenna height limits for fixed and base stations**

21. For fixed and base stations transmitting in accordance with section 4, the maximum permissible equivalent isotropically radiated power (e.i.r.p.) is 1640 watts and 1640 watts/MHz for a channel bandwidth less than or equal to 1 MHz and greater than 1 MHz, respectively. These e.i.r.p. limits apply for stations with an antenna height above average terrain (HAAT) up to 305 metres.

22. Fixed and base stations located in geographical areas at a distance greater than 26 km from large or medium population centres<sup>3</sup> and transmitting in accordance with section 4, may increase their e.i.r.p. up to a maximum of 3280 watts/MHz (i.e. no more than 3280 watts e.i.r.p. in any 1 MHz band segment), with an antenna HAAT up to 305 metres.

23. Within 26 km of any large or medium population centre, fixed and base stations may operate at increased e.i.r.p. if more than 50% of the population within a particular sector's coverage is located outside these large and medium population centres.

24. Fixed and base stations with increased e.i.r.p. must not be used to provide coverage to large and medium population centres. However, some incidental coverage of these large and medium population centres by stations with increased e.i.r.p. is permitted.

25. This provision also applies for fixed and base stations with a channel bandwidth equal to or less than 1 MHz (i.e. e.i.r.p. may be increased up to a maximum of 3280 watts).

26. For all installations with an antenna HAAT in excess of 305 metres, a corresponding reduction in e.i.r.p. according to the following formula shall be applied:

$$\text{EIRP } 20 \log (\text{HAAT} / 305) \text{ reduction} = 10 \text{ dB}$$



**ECL-TA-20-002-V01.00**

TA tests on Andrew CAP MX AC 6/7E/80-85/17E/19/23/25T

4.1.3 TEST PROTOCOL

<b>Band 13, downlink</b>							
<b>Signal Type</b>	<b>Input Power</b>	<b>Frequency [MHz]</b>	<b>Input Power [dBm]</b>	<b>Maximum Average Output Power [dBm]</b>	<b>Limit Average Output Power [dBm]</b>	<b>Margin to Limit [dB]</b>	<b>Gain [dB]</b>
Wideband	0.3 dB < AGC	748.50	-3,5	31.0	60.0	29.3	34.5
Wideband	3 dB > AGC	748.50	-0,2	31.5	60.0	28.9	31.7
Narrowband	0.3 dB < AGC	746.20	-3,7	30.9	60.0	29.3	34.6
Narrowband	3 dB > AGC	746.20	-0,4	31.3	60.0	29.4	31.7

Remarks: Please see next sub-clause for the measurement plot.



BUREAU  
VERITAS

### ECL-TA-20-002-V01.00

TA tests on Andrew CAP MX AC 6/7E/80-85/17E/19/23/25T

#### 4.1.1.4 MEASUREMENT PLOT (SHOWING THE HIGHEST VALUE, "WORST CASE")

Frequency Band = Band 13, Direction = RF downlink, Input Power = -0.3 dB < AGC, Signal Type = Wideband

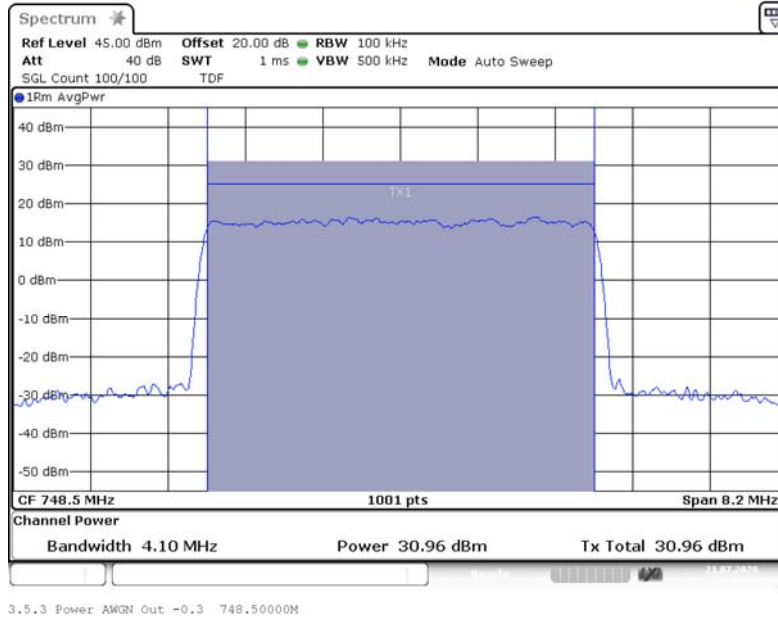

Frequency Band = Band 13, Direction = RF downlink, Input Power = 3 dB > AGC, Signal Type = Wideband

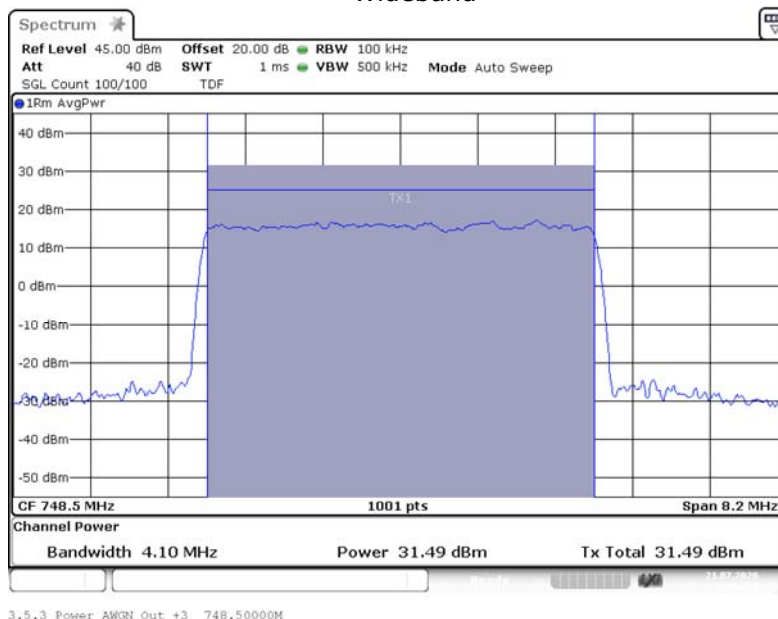



BUREAU  
VERITAS

## ECL-TA-20-002-V01.00

TA tests on Andrew CAP MX AC 6/7E/80-85/17E/19/23/25T

Frequency Band = Band 13, Direction = RF downlink, Input Power = -0.3 dB < AGC, Signal Type = Narrowband

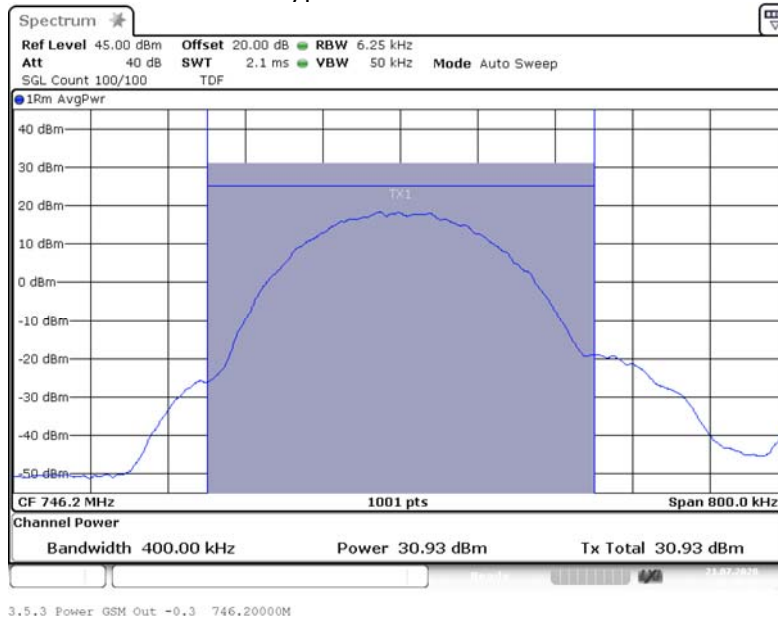

Frequency Band = Band 13, Direction = RF downlink, Input Power = 3 dB > AGC, Signal Type = Narrowband



### 4.1.5 TEST EQUIPMENT USED

- Conducted



## ECL-TA-20-002-V01.00

TA tests on Andrew CAP MX AC 6/7E/80-  
85/17E/19/23/25T

---

### 4.2 PEAK TO AVERAGE RATIO

Standard FCC Part 27, § 27.50

**The test was performed according to:**  
ANSI C63.26

**Test date:** 2020-07-21

**Environmental conditions:** 25 ° C; 40 % r. F.

**Test engineer:** Thomas Hufnagel

#### 4.2.1 TEST DESCRIPTION

This test case is intended to demonstrate compliance to the signal booster power and gain limits and requirements for industrial signal boosters per FCC § 27.50 and RSS-130 with subparts 4.6, 4.6.1 and 4.6.1.

The EUT was connected to the test setup according to the following diagram:

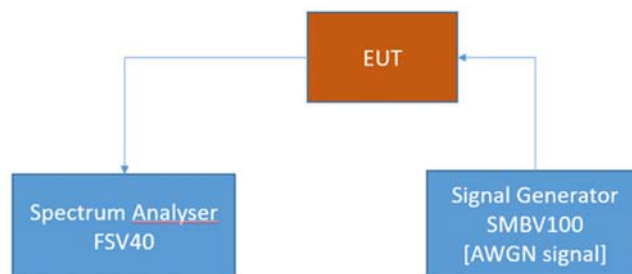

FCC Part 22/24/27/90 Industrial signal booster – Test Setup; RF Output Power / Gain

The attenuation of the measuring and stimulus path are known for each measured frequency and are considered.

The Spectrum Analyzer settings can be directly found in the measurement diagrams.



**ECL-TA-20-002-V01.00**

TA tests on Andrew CAP MX AC 6/7E/80-85/17E/19/23/25T

**4.2.2 TEST REQUIREMENTS/LIMITS**

**Part 27; Miscellaneous Wireless Communication Services**

**Subpart C – Technical standards**

**§ 27.50**

For the band 13 exists no FCC peak-to-average power ratio (PAPR) limit.

Abstract RSS-130 from ISED:

**RSS-130; 4.6 Transmitter output power and effective radiated power (e.r.p.)**

The transmitter output power shall be measured in terms of average power. For base and fixed equipment, refer to SRSP-518 for power limits

**4.6.1 General**

The transmitter output power shall be measured in terms of average power. In addition, the peak-to average power ratio (PAPR) of the transmitter shall not exceed 13 dB for more than 0.1% of the time and shall use a signal corresponding to the highest PAPR during periods of continuous transmission.

**4.2.3 TEST PROTOCOL**

<b>Band 13, downlink</b>						
<b>Signal Type</b>	<b>Input Power</b>	<b>Frequency [MHz]</b>	<b>Input Power [dBm]</b>	<b>PAPR [dB]</b>	<b>Limit PAPR [dB]</b>	<b>Margin to Limit [dB]</b>
Wideband	0.3 dB < AGC	748.50	-3.5	8.8	13.0	4.2
Wideband	3 dB > AGC	751.00	0.0	8.6	13.0	4.4
Narrowband	0.3 dB < AGC	746.20	-3.7	0.4	13.0	12.6
Narrowband	3 dB > AGC	746.20	-0.4	0.4	13.0	12.6

Remark: Please see next sub-clause for the measurement plot.





BUREAU  
VERITAS

### ECL-TA-20-002-V01.00

TA tests on Andrew CAP MX AC 6/7E/80-85/17E/19/23/25T

#### 4.2.4 MEASUREMENT PLOT (SHOWING THE HIGHEST VALUE, "WORST CASE")

Frequency Band = Band 13, Direction = RF downlink, Input Power = -0.3 dB < AGC, Signal Type = Wideband

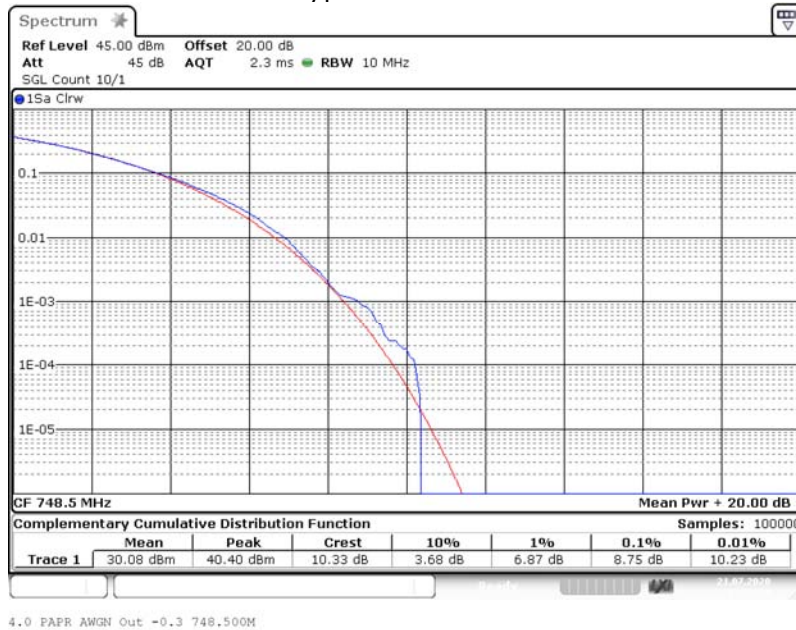

Frequency Band = Band 13, Direction = RF downlink, Input Power = 3 dB > AGC, Signal Type = Wideband

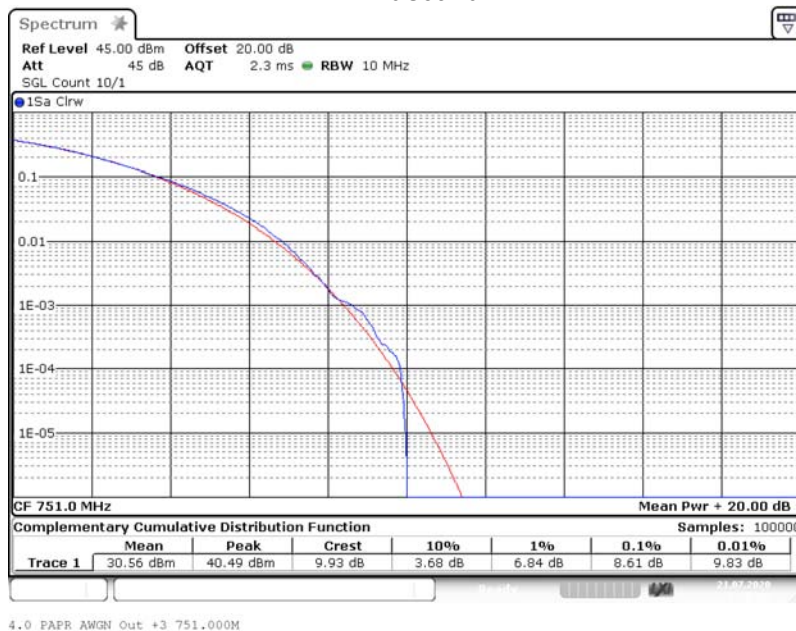



**BUREAU  
VERITAS**

### ECL-TA-20-002-V01.00

TA tests on Andrew CAP MX AC 6/7E/80-85/17E/19/23/25T

Frequency Band = Band 13, Direction = RF downlink, Input Power = -0.3 dB < AGC, Signal Type = Narrowband

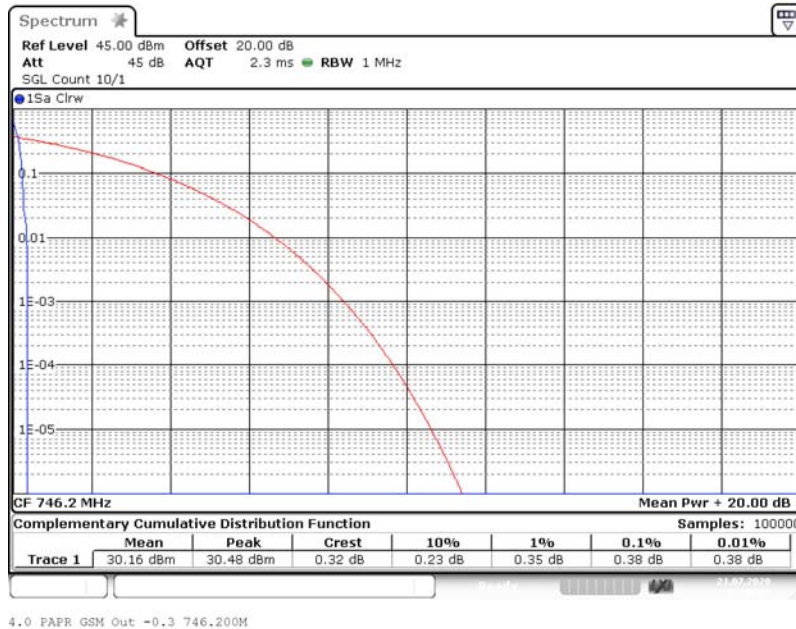

Frequency Band = Band 13, Direction = RF downlink, Input Power = 3 dB > AGC, Signal Type = Narrowband

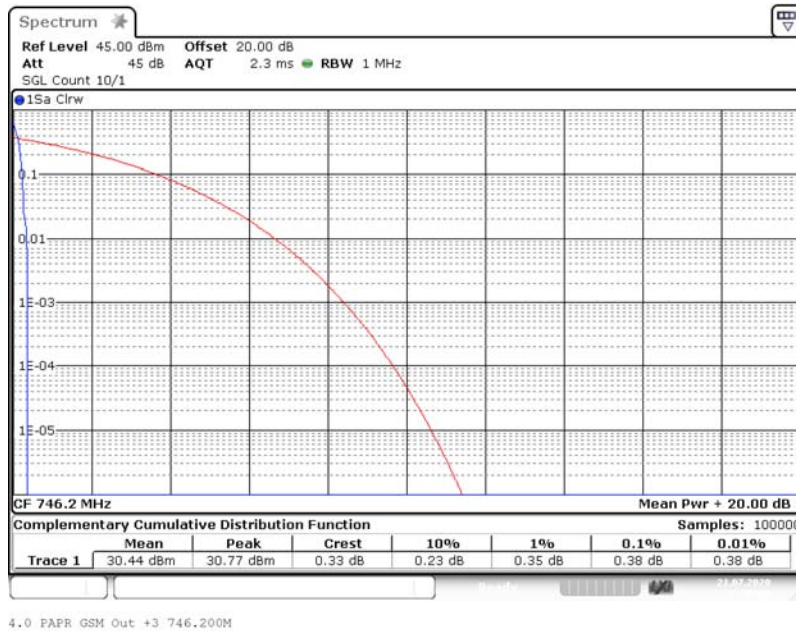

#### 4.2.5 TEST EQUIPMENT USED

- Conducted



BUREAU  
VERITAS

## ECL-TA-20-002-V01.00

TA tests on Andrew CAP MX AC 6/7E/80-85/17E/19/23/25T

### 4.3 OCCUPIED BANDWIDTH/INPUT-VERSUS-OUTPUT SPECTRUM

Standard FCC Part 2.1049; Occupied Bandwidth

The test was performed according to:  
ANSI C63.26, KDB 935210 D05 v01r04: 3.4

Test date: 2020-07-21

Environmental conditions: 25 ° C; 40 % r. F.

Test engineer: Thomas Hufnagel

#### 4.3.1 TEST DESCRIPTION

This test case is intended to demonstrate compliance to the applicable conducted spurious emission limits per FCC § 2.1049, RSS-GEN with subpart 6.7 and RSS-131 with subpart 5.2.2

The EUT was connected to the test setups according to the following diagram:

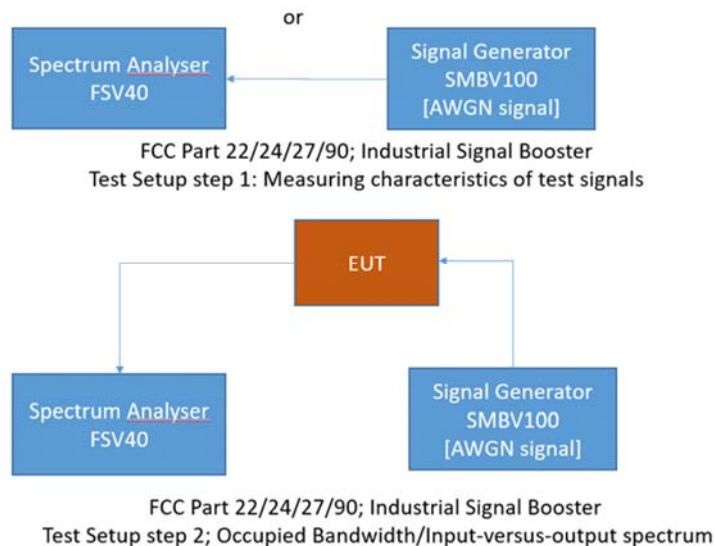

The attenuation of the measuring and stimulus path are known for each measured frequency and are considered.

The Spectrum Analyzer settings can be directly found in the measurement diagrams.



## ECL-TA-20-002-V01.00

TA tests on Andrew CAP MX AC 6/7E/80-  
85/17E/19/23/25T

---

### 4.3.2 TEST REQUIREMENTS/LIMITS

Abstract § 2.1049 from FCC:

#### **FCC Part 2.1049; Occupied Bandwidth:**

The occupied bandwidth, that is the frequency bandwidth such that, below its lower and above its upper frequency limits, the mean powers radiated are each equal to 0.3 percent of the total mean power radiated by a given emission shall be measured under the following conditions as applicable:

(h) Transmitters employing digital modulation techniques—when modulated by an input signal such that its amplitude and symbol rate represent the maximum rated conditions under which the equipment will be operated. The signal shall be applied through any filter networks, pseudo-random generators or other devices required in normal service. Additionally, the occupied bandwidth shall be shown for operation with any devices used for modifying the spectrum when such devices are optional at the discretion of the user.

(i) Transmitters designed for other types of modulation—when modulated by an appropriate signal of sufficient amplitude to be representative of the type of service in which used. A description of the input signal should be supplied.

Abstract RSS-GEN from ISED:

#### **RSS-GEN; 6.7 Occupied Bandwidth**

The occupied bandwidth or the “99% emission bandwidth” is defined as the frequency range between two points, one above and the other below the carrier frequency, within which 99% of the total transmitted power of the fundamental transmitted emission is contained. The occupied bandwidth shall be reported for all equipment in addition to the specified bandwidth required in the applicable RSSs.

In some cases, the “x dB bandwidth” is required, which is defined as the frequency range between two points, one at the lowest frequency below and one at the highest frequency above the carrier frequency, at which the maximum power level of the transmitted emission is attenuated x dB below the maximum in-band power level of the modulated signal, where the two points are on the outskirts of the in-band emission.

The following conditions shall be observed for measuring the occupied bandwidth and x dB bandwidth:

- The transmitter shall be operated at its maximum carrier power measured under normal test conditions.
- The span of the spectrum analyzer shall be set large enough to capture all products of the modulation process, including the emission skirts, around the carrier frequency, but small enough to avoid having other emissions (e.g. on adjacent channels) within the span.



**BUREAU  
VERITAS**

## **ECL-TA-20-002-V01.00**

TA tests on Andrew CAP MX AC 6/7E/80-  
85/17E/19/23/25T

---

- The detector of the spectrum analyzer shall be set to "Sample". However, a peak, or peak hold, may be used in place of the sampling detector since this usually produces a wider bandwidth than the actual bandwidth (worst-case measurement). Use of a peak hold (or "Max Hold") may be necessary to determine the occupied / x dB bandwidth if the device is not transmitting continuously.
- The resolution bandwidth (RBW) shall be in the range of 1% to 5% of the actual occupied / x dB bandwidth and the video bandwidth (VBW) shall not be smaller than three times the RBW value. Video averaging is not permitted.

For the 99% emission bandwidth, the trace data points are recovered and directly summed in linear power level terms. The recovered amplitude data points, beginning at the lowest frequency, are placed in a running sum until 0.5% of the total is reached, and that frequency recorded. The process is repeated for the highest frequency data points (starting at the highest frequency, at the right side of the span, and going down in frequency). This frequency is then recorded. The difference between the two recorded frequencies is the occupied bandwidth (or the 99% emission bandwidth).

Abstract RSS-130 from ISED:

### **RSS-131; 5.2.2 Input-versus-output spectrum**

The spectral growth of the 26 dB bandwidth of the output signal shall be less than 5% of the input signal spectrum.



**ECL-TA-20-002-V01.00**

TA tests on Andrew CAP MX AC 6/7E/80-85/17E/19/23/25T

4.3.3 TEST PROTOCOL

<b>Band 13, downlink</b>							
<b>Signal Type</b>	<b>Input Power</b>	<b>Signal Frequency [MHz]</b>	<b>Occupied Bandwidth SG [kHz]</b>	<b>Occupied Bandwidth Booster [kHz]</b>	<b>Delta Occupied Bandwidth [kHz]</b>	<b>Limit Delta Occupied Bandwidth [kHz]</b>	<b>Margin to Limit [kHz]</b>
Wideband	0.3 dB < AGC	751.00	4337.8	4335.3	2.5	205.0	202.5
Wideband	3 dB > AGC	751.00	4335.3	4334.1	1.2	205.0	203.8
Narrowband	0.3 dB < AGC	751.00	318.9	320.1	1.2	10.0	8.8
Narrowband	3 dB > AGC	751.00	319.4	319.9	0.5	10.0	9.5

Remark: Please see next sub-clause for the measurement plot.



BUREAU  
VERITAS

### ECL-TA-20-002-V01.00

TA tests on Andrew CAP MX AC 6/7E/80-85/17E/19/23/25T

#### 4.3.4 MEASUREMENT PLOT

Frequency Band = Band 13, Direction = RF downlink, Input Power = -0.3 dB < AGC, Signal Type = Wideband

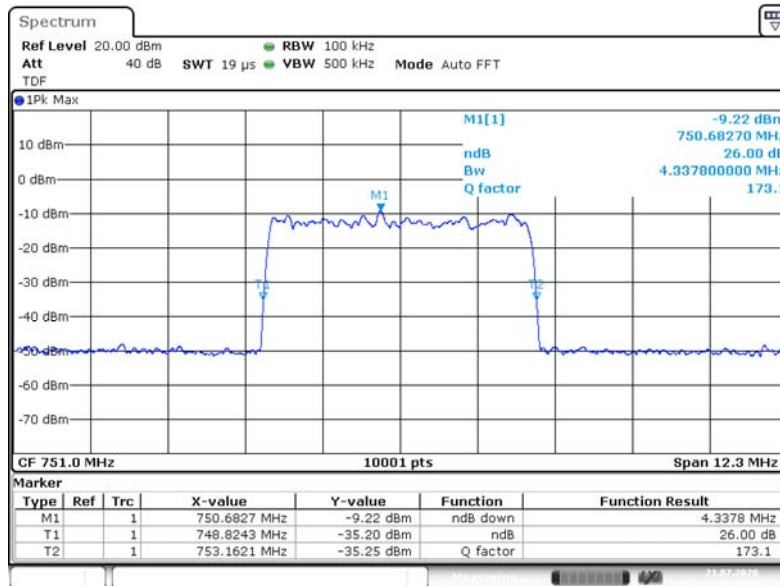

3.4 OCBw AWGN In -0.3 751.0000M \_26dB

Input Signal

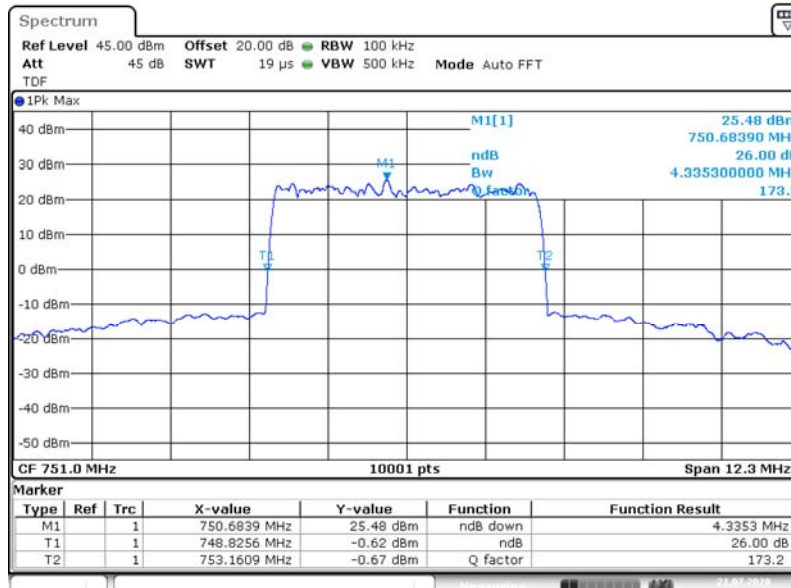

3.4 OCBw AWGN Out -0.3 751.0000M \_26dB

Output Signal



**BUREAU  
VERITAS**

**ECL-TA-20-002-V01.00**

TA tests on Andrew CAP MX AC 6/7E/80-85/17E/19/23/25T

Frequency Band = Band 13, Direction = RF downlink, Input Power = 3 dB > AGC, Signal Type = Wideband

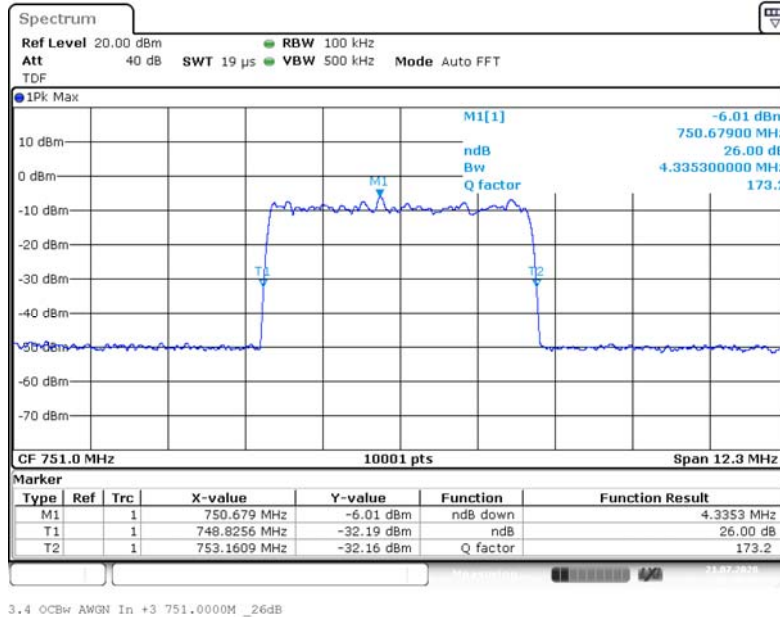

Input Signal

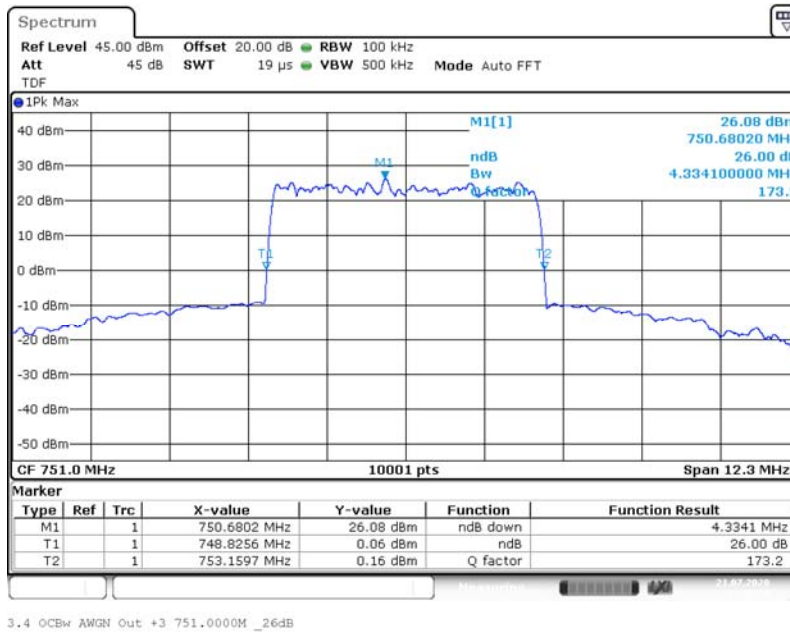

Output Signal





BUREAU  
VERITAS

### ECL-TA-20-002-V01.00

TA tests on Andrew CAP MX AC 6/7E/80-  
85/17E/19/23/25T

Frequency Band = Band 13, Direction = RF downlink, Input Power = -0.33 dB < AGC, Signal Type = Narrowband

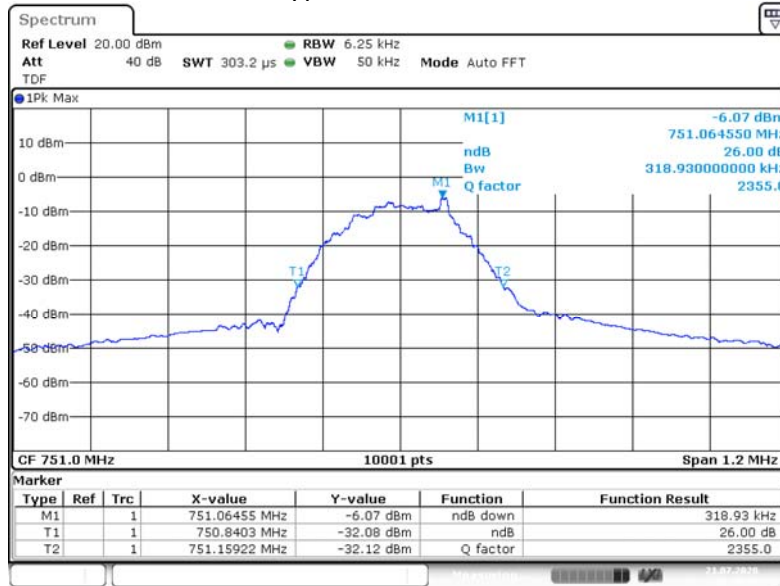

Input Signal

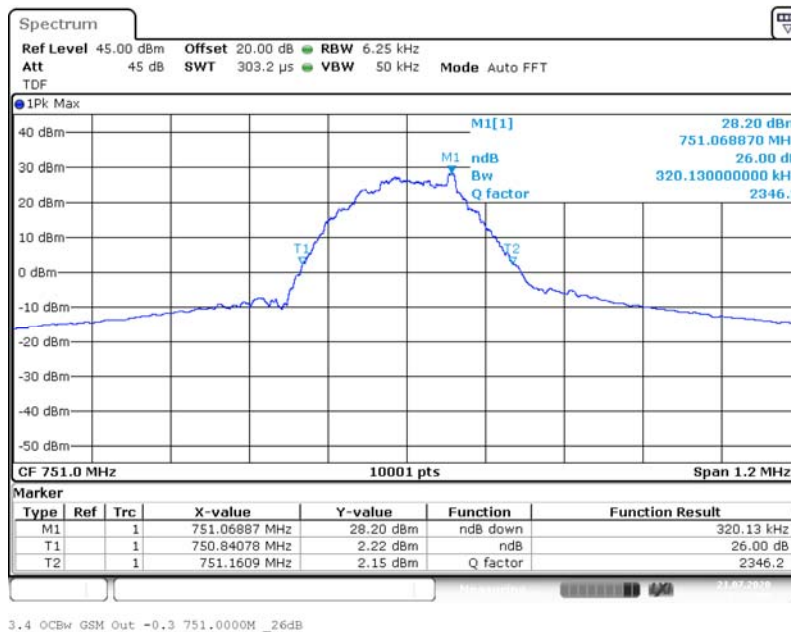

Output Signal



BUREAU VERITAS

### ECL-TA-20-002-V01.00

TA tests on Andrew CAP MX AC 6/7E/80-85/17E/19/23/25T

Frequency Band = Band 13, Direction RF downlink, Input Power = 3 dB > AGC, Signal Type = Narrowband

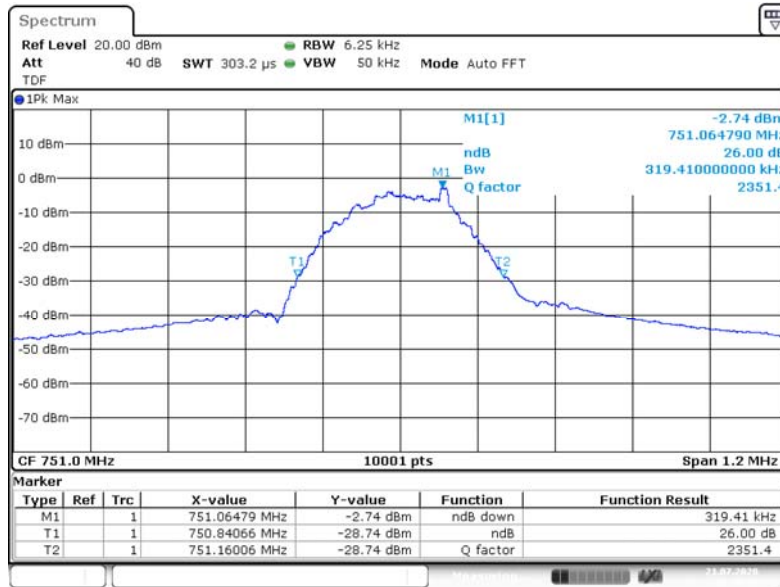

Input Signal

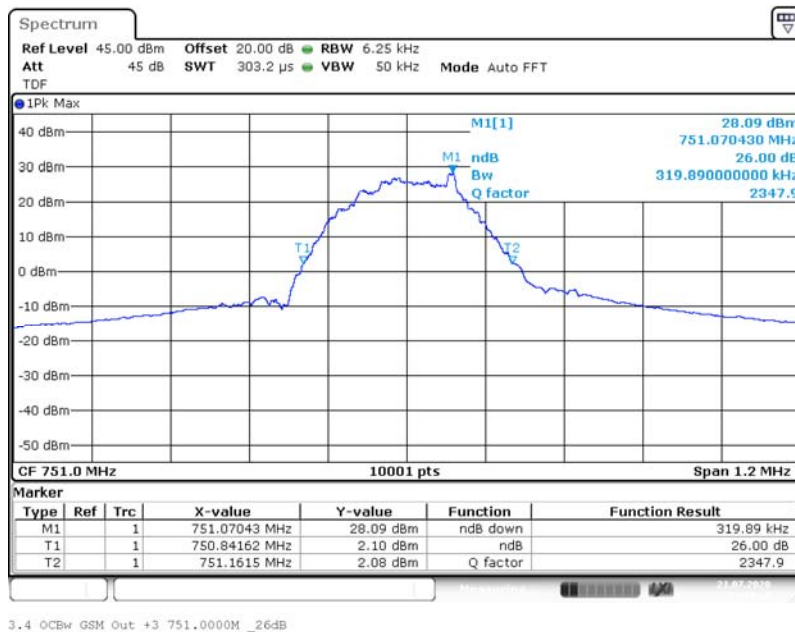

Output Signal

### 4.3.5 TEST EQUIPMENT USED

- Conducted



**ECL-TA-20-002-V01.00**

TA tests on Andrew CAP MX AC 6/7E/80-  
85/17E/19/23/25T

4.4 CONDUCTED SPURIOUS EMISSIONS AT ANTENNA TERMINALS

Standard FCC Part § 2.1051, § 27.53

**The test was performed according to:**  
ANSI C63.26, KDB 935210 D05 v01r04: 3.6

**Test date:** 2020-09-09

**Environmental conditions:** 24 ° C; 43 % r. F.

**Test engineer:** Thomas Hufnagel

4.4.1 TEST DESCRIPTION

This test case is intended to demonstrate compliance to the signal booster power and gain limits and requirements for industrial signal boosters per FCC § 2.1051, FCC § 27.53, RSS-GEN with subpart 6.13 and RSS-130 with subpart 4.7

The EUT was connected to the test setup according to the following diagram:

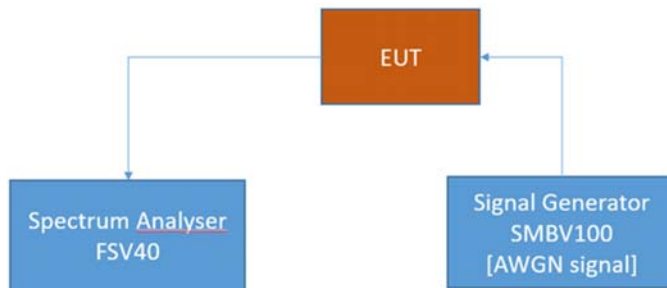

FCC Part 22/24/27/90 Industrial signal booster – Test Setup; RF Output Power / Gain

The attenuation of the measuring and stimulus path are known for each measured frequency and are considered.

The Spectrum Analyser settings can be directly found in the measurement diagrams.

## ECL-TA-20-002-V01.00

TA tests on Andrew CAP MX AC 6/7E/80-  
85/17E/19/23/25T

---

### 4.4.2 TEST REQUIREMENTS/LIMITS

Abstract § 2.1051 from FCC:

FCC Part 2.1051; Measurement required: Spurious emissions at antenna terminal:

The radio frequency voltage or powers generated within the equipment and appearing on a spurious frequency shall be checked at the equipment output terminals when properly loaded with a suitable artificial antenna. Curves or equivalent data shall show the magnitude of each harmonic and other spurious emission that can be detected when the equipment is operated under the conditions specified in § 2.1049 as appropriate. The magnitude of spurious emissions which are attenuated more than 20 dB below the permissible value need not be specified.

Abstract § 27.53 FCC:

Part 27; Miscellaneous Wireless Communication Services

Subpart C – Technical standards

§ 27.53 – Emission limits

Band 13:

(c) For operations in the 746-758 MHz band and the 776-788 MHz band, the power of any emission outside the licensee's frequency band(s) of operation shall be attenuated below the transmitter power (P) within the licensed band(s) of operation, measured in watts, in accordance with the following:

(1) On any frequency outside the 746-758 MHz band, the power of any emission shall be attenuated outside the band below the transmitter power (P) by at least  $43 + 10 \log (P)$  dB.

(5) Compliance with the provisions of paragraphs (c)(1) and (c)(2) of this section is based on the use of measurement instrumentation employing a resolution bandwidth of 100 kHz or greater. However, in the 100 kHz bands immediately outside and adjacent to the frequency block, a resolution bandwidth of at least 30 kHz may be employed.

Abstract RSS-130 4.7 from ISED:

RSS-130; 4.7 Transmitter Unwanted Emissions

4.7.1 General unwanted emissions limits

The unwanted emissions in any 100 kHz bandwidth on any frequency outside the low frequency edge and the high frequency edge of each frequency block range(s), shall be attenuated below the transmitter power, P (dBW), by at least  $43 + 10 \log_{10} p$  (watts), dB. However, in the 100 kHz band immediately outside of the equipment's frequency block range, a resolution bandwidth of 30 kHz may be employed.



**ECL-TA-20-002-V01.00**

TA tests on Andrew CAP MX AC 6/7E/80-85/17E/19/23/25T

**4.4.3 TEST PROTOCOL**

<b>Band 13, USA 750, downlink</b>							
<b>Test Frequency</b>	<b>Signal Type</b>	<b>Spurious Freq. [MHz]</b>	<b>Spurious Level [dBm]</b>	<b>Detector</b>	<b>RBW [kHz]</b>	<b>Limit [dBm]</b>	<b>Margin to Limit [dB]</b>
low	Wideband	0.0194241	-59.7	RMS	1	-33.0	26.7
low	Wideband	0.0674971	-53.1	RMS	10	-23.0	30.1
low	Wideband	118.3656	-45.5	RMS	100	-13.0	32.5
low	Wideband	704.6818	-44.2	RMS	100	-13.0	31.2
low	Wideband	744.8631	-39.3	RMS	10	-23.0	16.3
low	Wideband	756.5822	-44.9	RMS	10	-23.0	21.9
low	Wideband	953.9348	-44.3	RMS	100	-13.0	31.3
low	Wideband	6817.9	-31.3	RMS	100	-13.0	18.3
mid	Wideband	0.095529	-60.8	RMS	1	-33.0	27.8
mid	Wideband	0.0574988	-53.0	RMS	10	-23.0	30.0
mid	Wideband	119.0655	-45.5	RMS	100	-13.0	32.5
mid	Wideband	706.2815	-44.9	RMS	100	-13.0	31.9
mid	Wideband	745.6376	-42.3	RMS	10	-23.0	19.3
mid	Wideband	756.5523	-43.4	RMS	10	-23.0	20.4
mid	Wideband	952.1852	-44.4	RMS	100	-13.0	31.4
mid	Wideband	6931.4	-30.7	RMS	100	-13.0	17.7
high	Wideband	0.0487098	-60.0	RMS	1	-33.0	27.0
high	Wideband	0.072496	-53.5	RMS	10	-23.0	30.5
high	Wideband	117.6657	-45.2	RMS	100	-13.0	32.2
high	Wideband	707.1313	-44.3	RMS	100	-13.0	31.3
high	Wideband	745.3078	-44.8	RMS	10	-23.0	21.8
high	Wideband	756.2474	-38.0	RMS	10	-23.0	15.0
high	Wideband	953.2849	-43.6	RMS	100	-13.0	30.6
high	Wideband	6924.9	-31.3	RMS	100	-13.0	18.3



ECL-TA-20-002-V01.00

TA tests on Andrew CAP MX AC 6/7E/80-85/17E/19/23/25T

Band 13, USA 750, downlink							
Test Frequency	Signal Type	Spurious Freq. [MHz]	Spurious Level [dBm]	Detector	RBW [kHz]	Limit [dBm]	Margin to Limit [dB]
low	Narrowband	0.0148776	-60.8	RMS	1	-33.0	27.8
low	Narrowband	0.0574988	-54.6	RMS	10	-23.0	31.6
low	Narrowband	66.3711	-45.9	RMS	100	-13.0	32.9
low	Narrowband	703.7320	-45.5	RMS	100	-13.0	32.5
low	Narrowband	745.8875	-51.8	RMS	10	-23.0	28.8
low	Narrowband	758.6710	-53.8	RMS	10	-23.0	30.8
low	Narrowband	952.1352	-43.5	RMS	100	-13.0	30.5
low	Narrowband	6864.9	-30.7	RMS	100	-13.0	17.7
mid	Narrowband	0.0090205	-61.3	RMS	1	-33.0	28.3
mid	Narrowband	0.0674971	-55.6	RMS	10	-23.0	32.6
mid	Narrowband	120.6654	-45.5	RMS	100	-13.0	32.5
mid	Narrowband	726.0273	-42.1	RMS	100	-13.0	29.1
mid	Narrowband	738.2668	-50.9	RMS	10	-23.0	27.9
mid	Narrowband	757.2119	-50.9	RMS	10	-23.0	27.9
mid	Narrowband	952.4351	-43.2	RMS	100	-13.0	30.2
mid	Narrowband	6872.4	-30.9	RMS	100	-13.0	17.9
high	Narrowband	0.0137308	-61.4	RMS	1	-33.0	28.4
high	Narrowband	0.1524829	-54.7	RMS	10	-23.0	31.7
high	Narrowband	69.0208	-45.4	RMS	100	-13.0	32.4
high	Narrowband	704.5818	-43.7	RMS	100	-13.0	30.7
high	Narrowband	743.3240	-54.2	RMS	10	-23.0	31.2
high	Narrowband	756.1775	-51.0	RMS	10	-23.0	28.0
high	Narrowband	951.2854	-43.5	RMS	100	-13.0	30.5
high	Narrowband	6847.9	-31.1	RMS	100	-13.0	18.1

Remark: Please see next sub-clause for the measurement plot.

General considerations concerning the measurement plots:

The measuring bandwidth of 100 kHz was chosen according the test requirements except at the band edges: At the band edges reducing of measurement bandwidth was necessary to prevent overlaying the RF-signal over the spurious emissions.

Also outside the downlink frequency band at lower frequencies the measurement bandwidths were reduced to have the possibility to record the spurious emissions at these lower frequencies.

At frequencies where measuring bandwidths were reduced also the border lines were reduced according the given formula:

$$p_{RBWreduced} [dBm] = 10 * \log(RBWreduced [kHz] - 100 kHz) + p_{RBW 100 kHz} [dBm]$$

Hereby "p" are the border lines' values.



BUREAU  
VERITAS

### ECL-TA-20-002-V01.00

TA tests on Andrew CAP MX AC 6/7E/80-  
85/17E/19/23/25T

#### 4.4.4 MEASUREMENT PLOT (SHOWING THE HIGHEST VALUE, "WORST CASE")

Frequency Band = Band 13, Test Frequency = low, Direction = RF downlink, Signal Type = Wideband

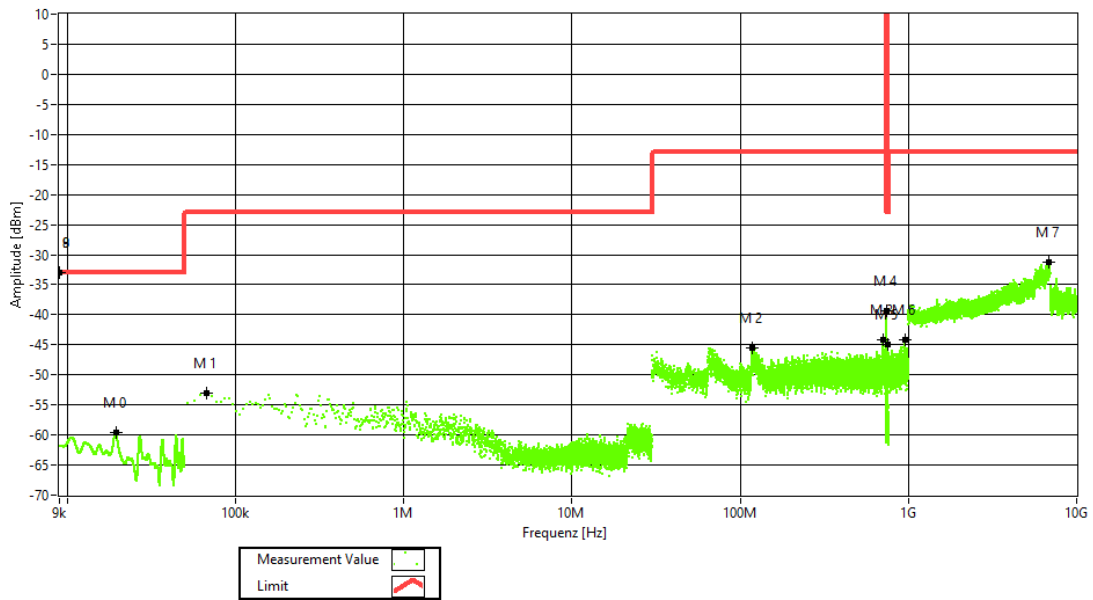

Frequency Band = Band 13, Test Frequency = mid, Direction = RF downlink, Signal Type = Wideband

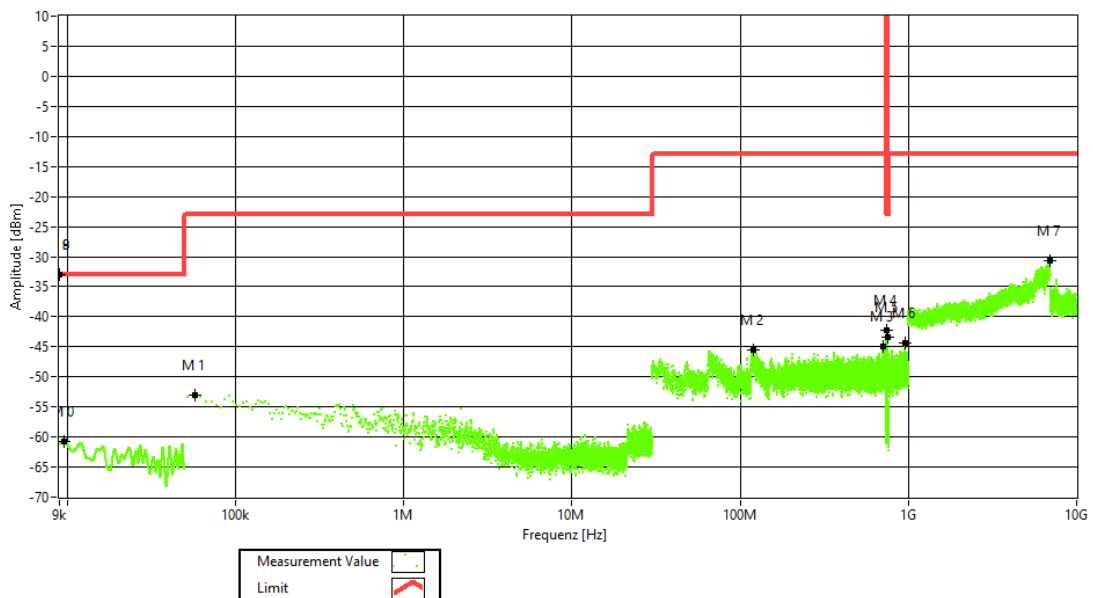



BUREAU  
VERITAS

### ECL-TA-20-002-V01.00

TA tests on Andrew CAP MX AC 6/7E/80-  
85/17E/19/23/25T

Frequency Band = Band 13, Test Frequency = high, Direction = RF downlink, Signal Type = Wideband

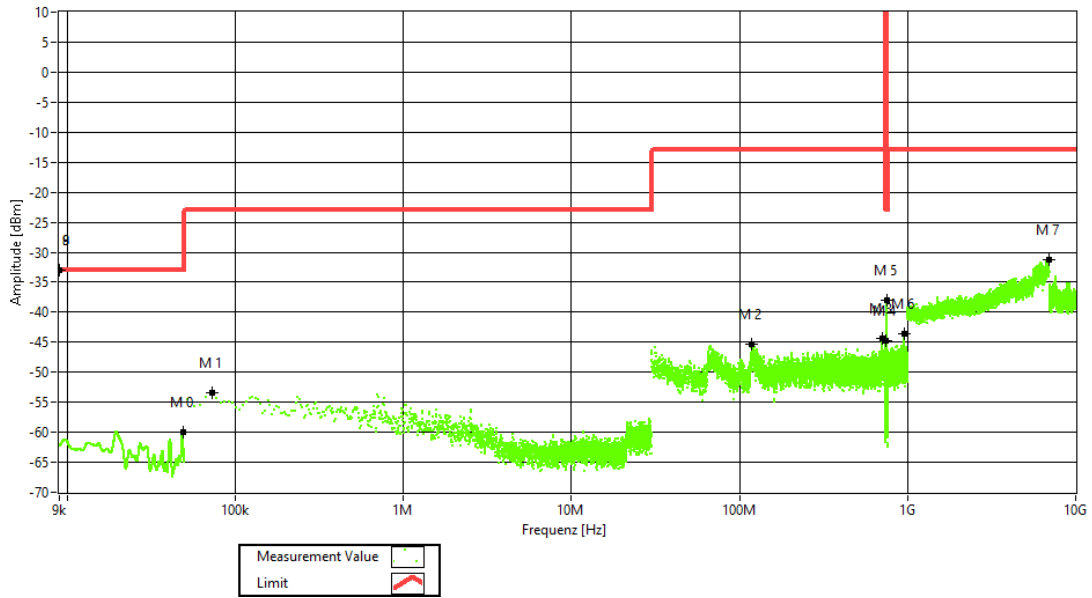





BUREAU  
VERITAS

### ECL-TA-20-002-V01.00

TA tests on Andrew CAP MX AC 6/7E/80-  
85/17E/19/23/25T

Frequency Band = Band 13, Test Frequency = low, Direction = RF downlink, Signal Type = Narrowband

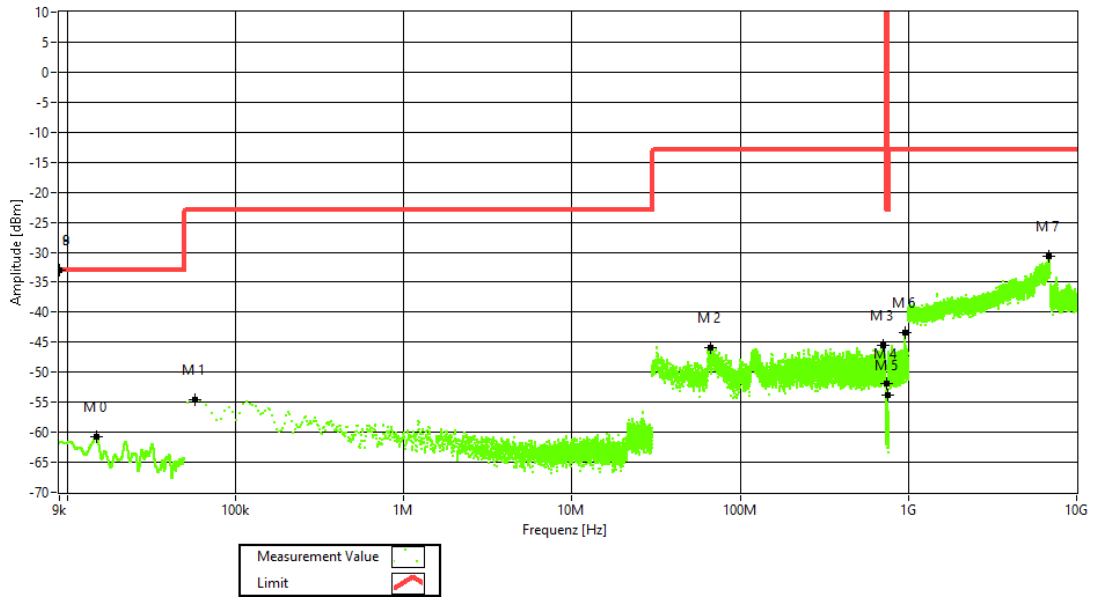

Frequency Band = Band 13, Test Frequency = mid, Direction = RF downlink, Signal Type = Narrowband

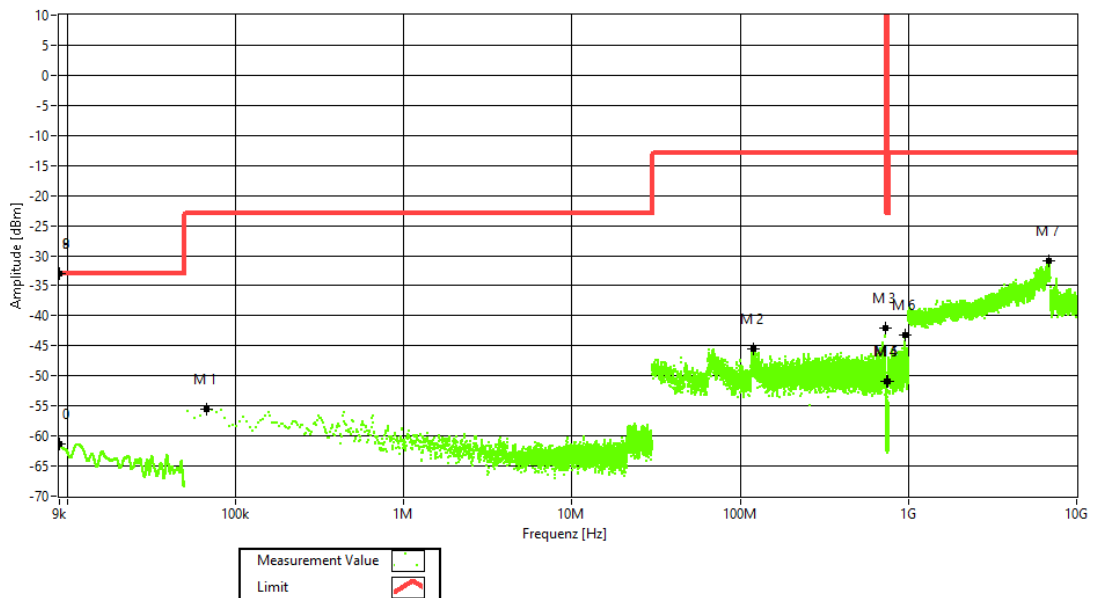



BUREAU  
VERITAS

### ECL-TA-20-002-V01.00

TA tests on Andrew CAP MX AC 6/7E/80-85/17E/19/23/25T

Frequency Band = Band 13, Test Frequency = high, Direction = RF downlink, Signal Type = Narrowband

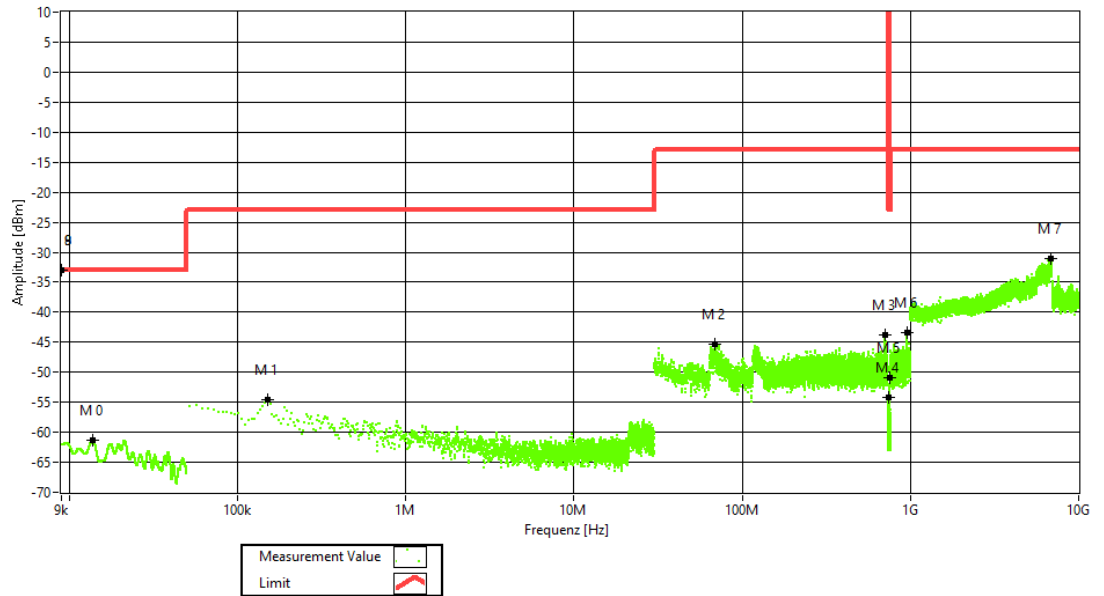

#### 4.4.5 TEST EQUIPMENT USED

- Conducted



## ECL-TA-20-002-V01.00

TA tests on Andrew CAP MX AC 6/7E/80-  
85/17E/19/23/25T

### 4.5 OUT-OF-BAND EMISSION LIMITS

Standard FCC Part § 2.1051, § 27.53

**The test was performed according to:**  
ANSI C63.26, KDB 935210 D05 v01r04: 3.6

**Test date:** 2020-07-21

**Environmental conditions:** 25 ° C; 40 % r. F.

**Test engineer:** Thomas Hufnagel

#### 4.5.1 TEST DESCRIPTION

This test case is intended to demonstrate compliance to the out-of-band emission limit for industrial signal boosters. The limits itself come from the applicable rule part for each operating band per FCC § 2.1051, FCC § 27.53, RSS-GEN with subpart 6.13 and RSS-130 with subpart 4.7.

The EUT was connected to the test setup according to the following diagram:

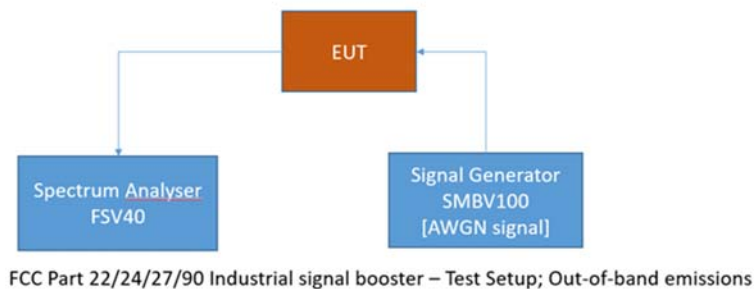

The attenuation of the measuring and stimulus path are known for each measured frequency and are considered.

The Spectrum Analyser settings can be directly found in the measurement diagrams.



## **ECL-TA-20-002-V01.00**

TA tests on Andrew CAP MX AC 6/7E/80-  
85/17E/19/23/25T

---

### 4.5.2 TEST REQUIREMENTS/LIMITS

Abstract § 2.1051 from FCC:

#### **FCC Part 2.1051; Measurement required: Spurious emissions at antenna terminal:**

The radio frequency voltage or powers generated within the equipment and appearing on a spurious frequency shall be checked at the equipment output terminals when properly loaded with a suitable artificial antenna. Curves or equivalent data shall show the magnitude of each harmonic and other spurious emission that can be detected when the equipment is operated under the conditions specified in § 2.1049 as appropriate. The magnitude of spurious emissions which are attenuated more than 20 dB below the permissible value need not be specified.

Abstract § 27.53 FCC:

#### **Part 27; Miscellaneous Wireless Communication Services**

##### **Subpart C – Technical standards**

##### **§ 27.53 – Emission limits**

###### **Band 13:**

(c) For operations in the 746-758 MHz band and the 776-788 MHz band, the power of any emission outside the licensee's frequency band(s) of operation shall be attenuated below the transmitter power (P) within the licensed band(s) of operation, measured in watts, in accordance with the following:

(1) On any frequency outside the 746-758 MHz band, the power of any emission shall be attenuated outside the band below the transmitter power (P) by at least  $43 + 10 \log(P)$  dB.

(5) Compliance with the provisions of paragraphs (c)(1) and (c)(2) of this section is based on the use of measurement instrumentation employing a resolution bandwidth of 100 kHz or greater. However, in the 100 kHz bands immediately outside and adjacent to the frequency block, a resolution bandwidth of at least 30 kHz may be employed.

Abstract RSS-130 4.7 from ISED:

#### **RSS-130; 4.7 Transmitter Unwanted Emissions**

##### **4.7.1 General unwanted emissions limits**

The unwanted emissions in any 100 kHz bandwidth on any frequency outside the low frequency edge and the high frequency edge of each frequency block range(s), shall be attenuated below the transmitter power, P (dBW), by at least  $43 + 10 \log_{10} p$  (watts), dB. However, in the 100 kHz band immediately outside of the equipment's frequency block range, a resolution bandwidth of 30 kHz may be employed.



**ECL-TA-20-002-V01.00**

TA tests on Andrew CAP MX AC 6/7E/80-  
85/17E/19/23/25T

**4.5.3 TEST PROTOCOL**

<b>Band 13, downlink, Number of input signals = 1</b>							
<b>Signal Type</b>	<b>Input Power</b>	<b>Band Edge</b>	<b>Signal Frequency [MHz]</b>	<b>Input Power [dBm]</b>	<b>Maximum Out-of-band Power [dBm]</b>	<b>Limit Out-of-band Power [dBm]</b>	<b>Margin to Limit [dB]</b>
Wideband	-0.3 dB < AGC	upper	753.50	-3.1	-30.8	-13.0	17.8
Wideband	3 dB > AGC	upper	753.50	0.2	-31.1	-13.0	18.1
Narrowband	-0.3 dB < AGC	upper	755.80	-3.1	-30.7	-13.0	17.7
Narrowband	3 dB > AGC	upper	755.80	0.2	-30.6	-13.0	17.6
Wideband	-0.3 dB < AGC	lower	748.50	-3.5	-30.9	-13.0	17.9
Wideband	3 dB > AGC	lower	748.50	0.2	-32.0	-13.0	19.0
Narrowband	-0.3 dB < AGC	lower	746.20	-3.7	-30.8	-13.0	17.8
Narrowband	3 dB > AGC	lower	746.20	0.4	-30.5	-13.0	17.5

<b>Band 13, downlink, Number of input signals = 2</b>								
<b>Signal Type</b>	<b>Input Power</b>	<b>Band Edge</b>	<b>Signal Frequency f1 [MHz]</b>	<b>Signal Frequency f2 [MHz]</b>	<b>Input Power [dBm]</b>	<b>Maximum Out-of-band Power [dBm]</b>	<b>Limit Out-of-band Power [dBm]</b>	<b>Margin to Limit [dB]</b>
WB	-0.3 dB < AGC	upper	753.50	751.00	-3.1	-33.0	-13.0	20.0
WB	3 dB > AGC	upper	753.50	751.00	0.2	-32.1	-13.0	19.1
NB	-0.3 dB < AGC	upper	755.80	755.60	-3.1	-32.1	-13.0	19.1
NB	3 dB > AGC	upper	755.80	755.60	0.2	-50.5	-13.0	37.5
WB	-0.3 dB < AGC	lower	748.50	751.00	-3.5	-32.7	-13.0	19.7
WB	3 dB > AGC	lower	748.50	751.00	0.2	-32.2	-13.0	19.2
NB	-0.3 dB < AGC	lower	746.20	746.40	-3.7	-32.1	-13.0	19.1
NB	3 dB > AGC	lower	746.20	746.40	0.4	-32.9	-13.0	19.9

Remark: Please see next sub-clause for the measurement plot.

Explanations concerning table with two input signals:

“WB” means Wideband.  
“NB” means Narrowband.



BUREAU  
VERITAS

### ECL-TA-20-002-V01.00

TA tests on Andrew CAP MX AC 6/7E/80-85/17E/19/23/25T

#### 4.5.4 MEASUREMENT PLOT (SHOWING THE HIGHEST VALUE, "WORST CASE")

Band Edge = Upper, Frequency Band = Band 13, Number of signals = 1, Direction = RF downlink, Input Power = -0.3 dB < AGC, Signal Type = Wideband

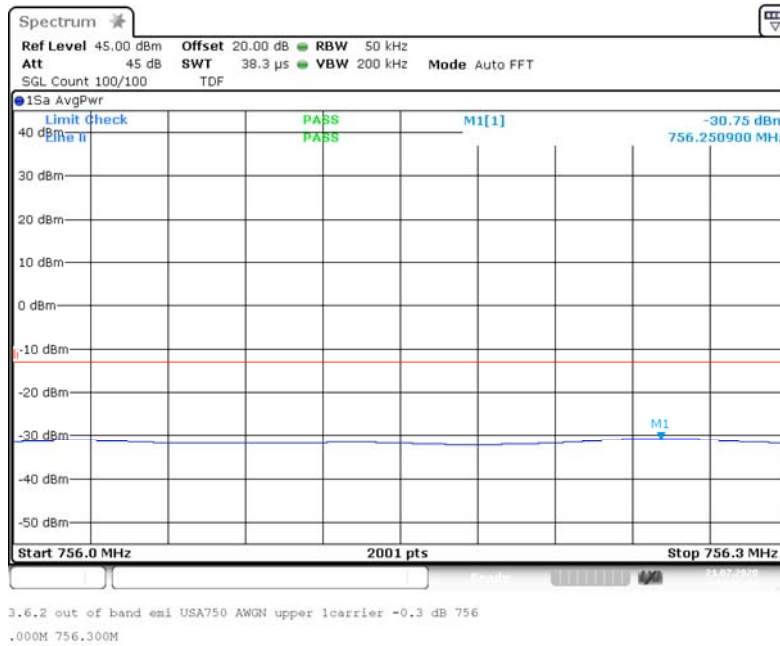

Band Edge = Upper, Frequency Band = Band 13, Number of signals = 1, Direction = RF downlink, Input Power = 3 dB > AGC, Signal Type = Wideband

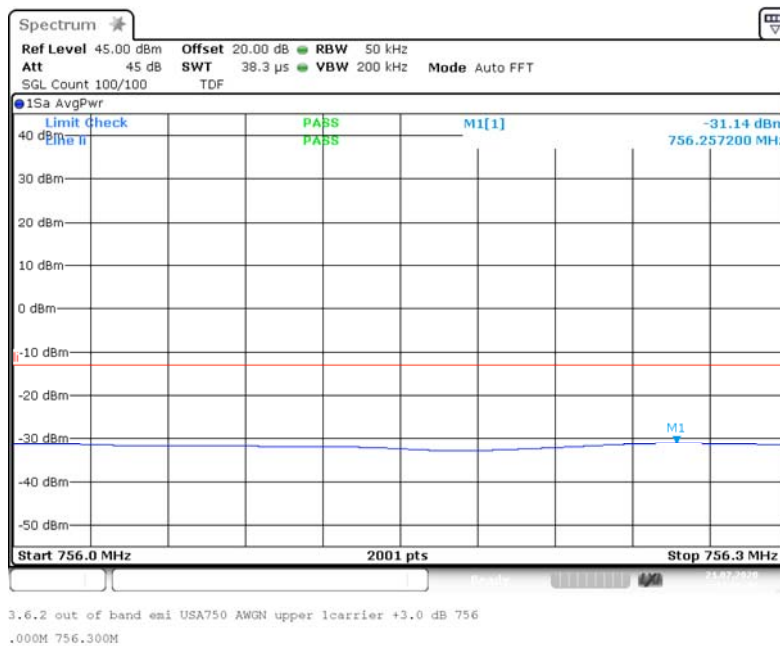



BUREAU  
VERITAS

### ECL-TA-20-002-V01.00

TA tests on Andrew CAP MX AC 6/7E/80-85/17E/19/23/25T

Band Edge = Upper, Frequency Band = Band 13, Number of signals = 1, Direction = RF downlink, Input Power = -0.3 dB < AGC, Signal Type = Narrowband

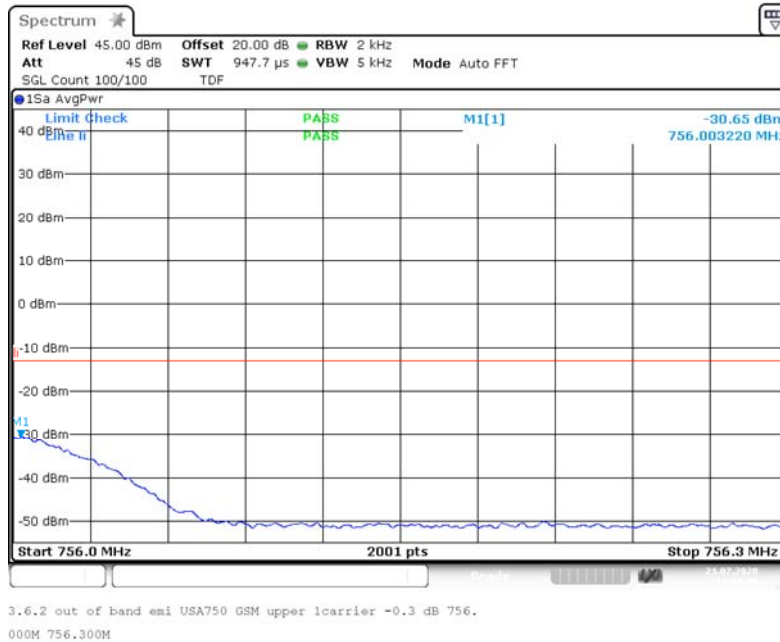

Band Edge = Lower, Frequency Band = Band 13, Number of signals = 1, Direction = RF downlink, Input Power = 3 dB > AGC, Signal Type = Narrowband

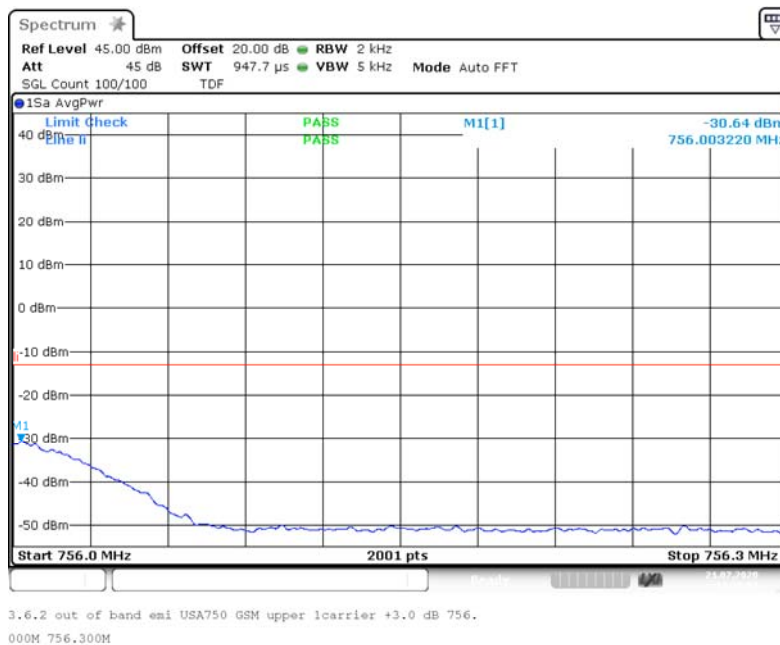



BUREAU  
VERITAS

### ECL-TA-20-002-V01.00

TA tests on Andrew CAP MX AC 6/7E/80-  
85/17E/19/23/25T

Band Edge = Lower, Frequency Band = Band 13, Number of signals = 1, Direction = RF  
downlink, Input Power = -0.3 dB < AGC, Signal Type = Wideband

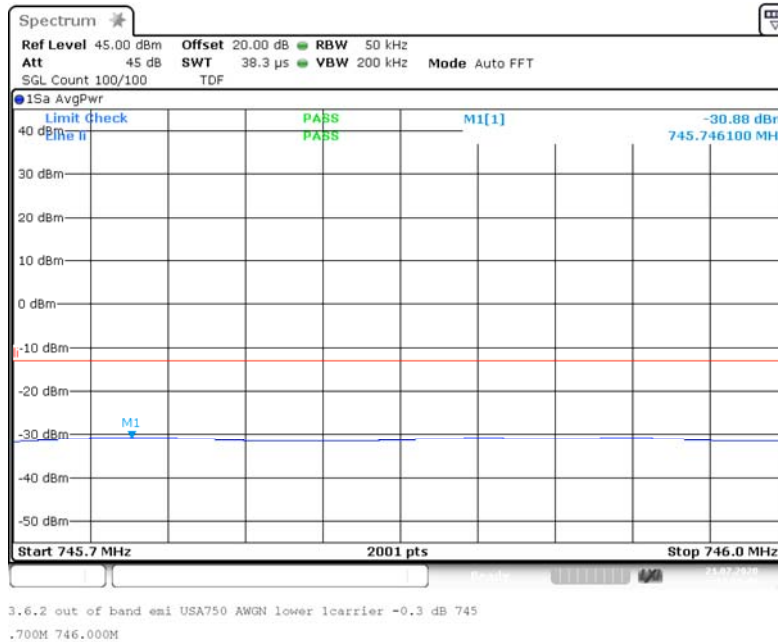

Band Edge = Lower, Frequency Band = Band 13, Number of signals = 1, Direction = RF  
downlink, Input Power = 3 dB > AGC, Signal Type = Wideband

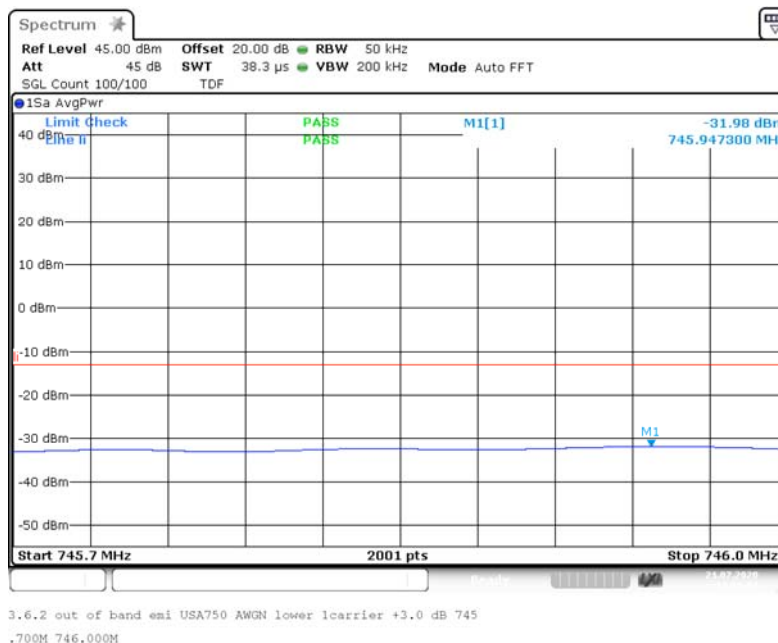





BUREAU  
VERITAS

### ECL-TA-20-002-V01.00

TA tests on Andrew CAP MX AC 6/7E/80-85/17E/19/23/25T

Band Edge = Lower, Frequency Band = Band 13, Number of signals = 1, Direction = RF downlink, Input Power = -0.3 dB < AGC, Signal Type = Narrowband

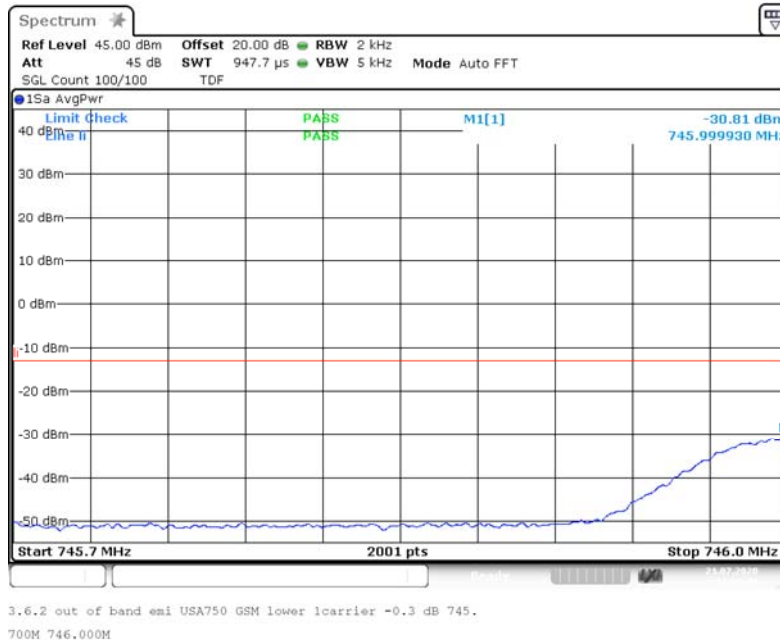

Band Edge = Lower, Frequency Band = Band 13, Number of signals = 1, Direction = RF downlink, Input Power = 3 dB > AGC, Signal Type = Narrowband

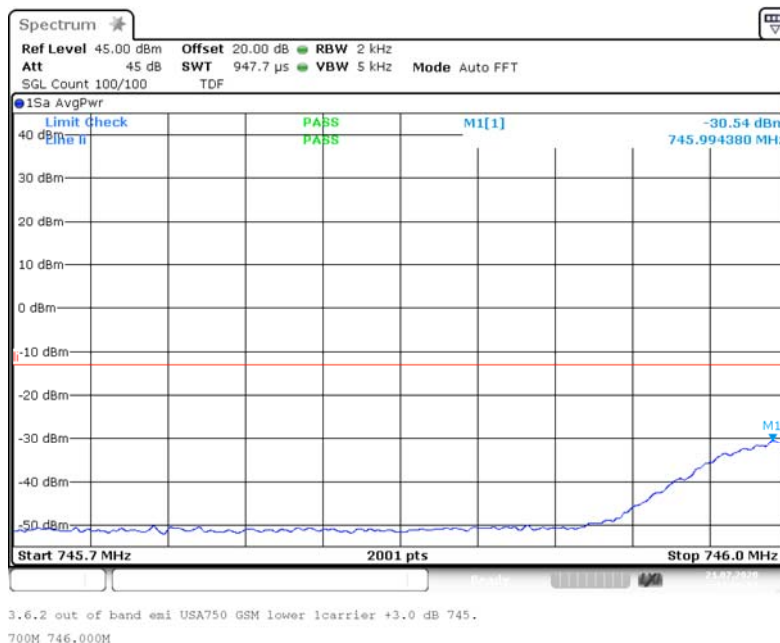



BUREAU  
VERITAS

### ECL-TA-20-002-V01.00

TA tests on Andrew CAP MX AC 6/7E/80-  
85/17E/19/23/25T

Band Edge = Upper, Frequency Band = Band 13, Number of signals = 2, Direction = RF  
downlink, Input Power = -0.3 dB < AGC, Signal Type = Wideband

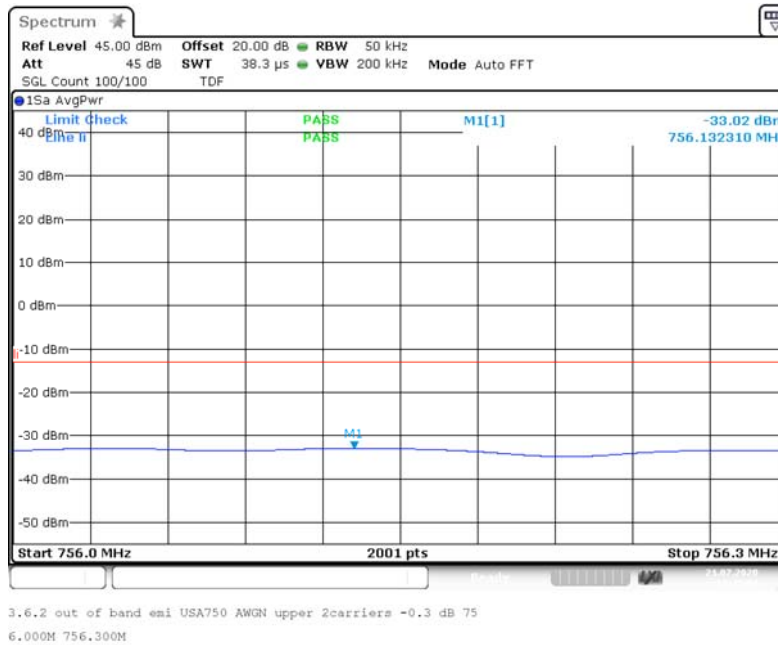

Band Edge = Upper, Frequency Band = Band 13, Number of signals = 2, Direction = RF  
downlink, Input Power = 3 dB > AGC, Signal Type = Wideband

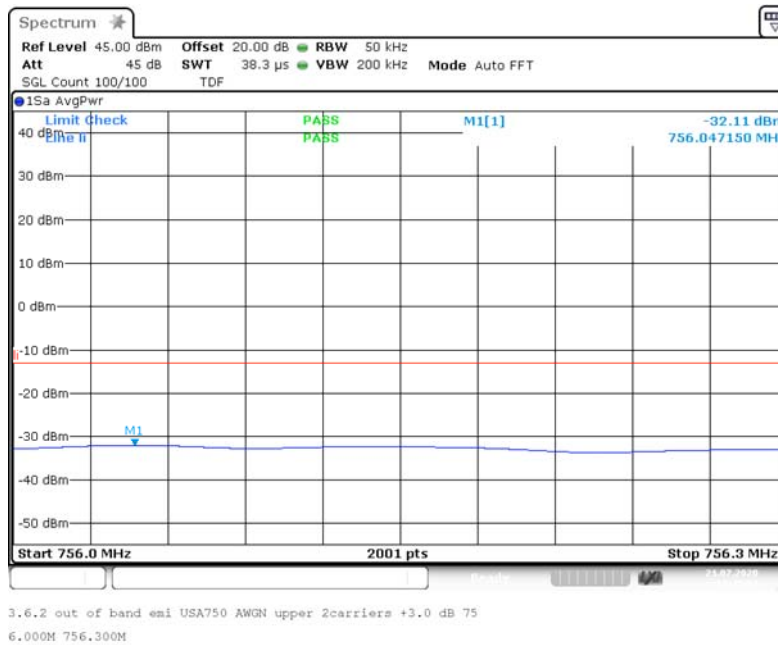



BUREAU  
VERITAS

### ECL-TA-20-002-V01.00

TA tests on Andrew CAP MX AC 6/7E/80-85/17E/19/23/25T

Band Edge = Upper, Frequency Band = Band 13, Number of signals = 2, Direction = RF downlink, Input Power = -0.3 dB < AGC, Signal Type = Narrowband

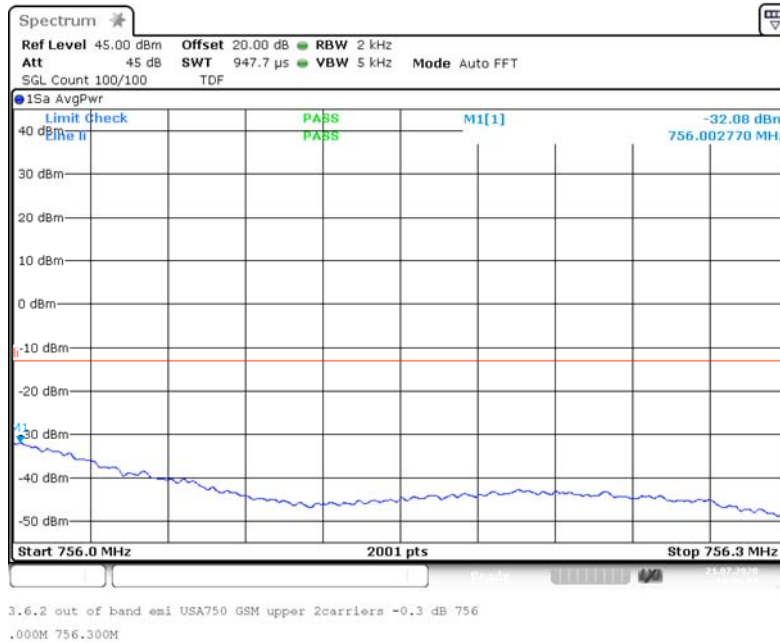

Band Edge = Lower, Frequency Band = Band 13, Number of signals = 2, Direction = RF downlink, Input Power = 3 dB > AGC, Signal Type = Narrowband

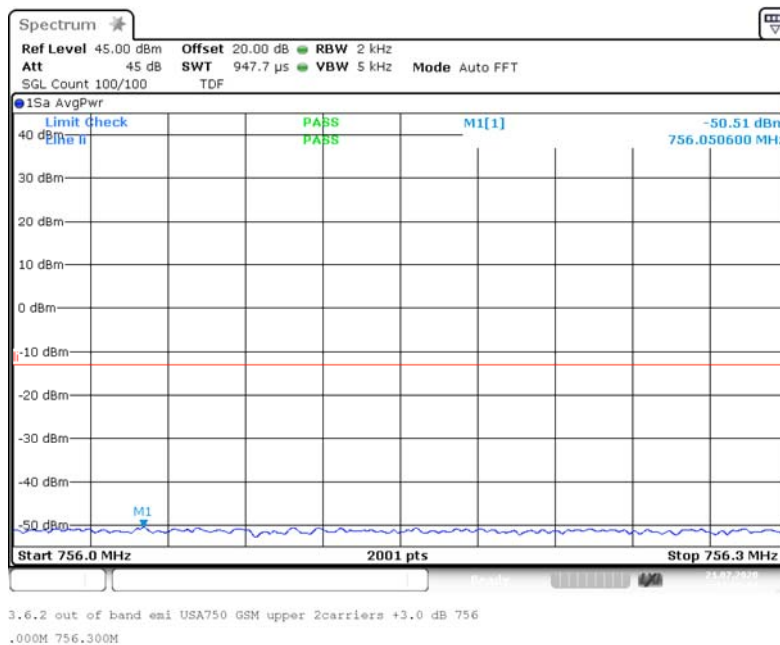



BUREAU  
VERITAS

### ECL-TA-20-002-V01.00

TA tests on Andrew CAP MX AC 6/7E/80-85/17E/19/23/25T

Band Edge = Lower, Frequency Band = Band 13, Number of signals = 2, Direction = RF downlink, Input Power = -0.3 dB < AGC, Signal Type = Wideband

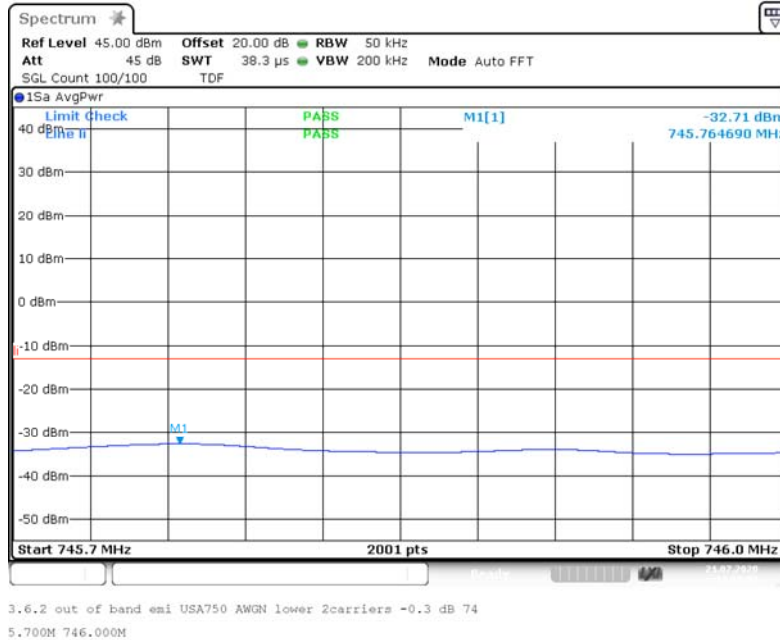

Band Edge = Lower, Frequency Band = Band 13, Number of signals = 2, Direction = RF downlink, Input Power = 3 dB > AGC, Signal Type = Wideband

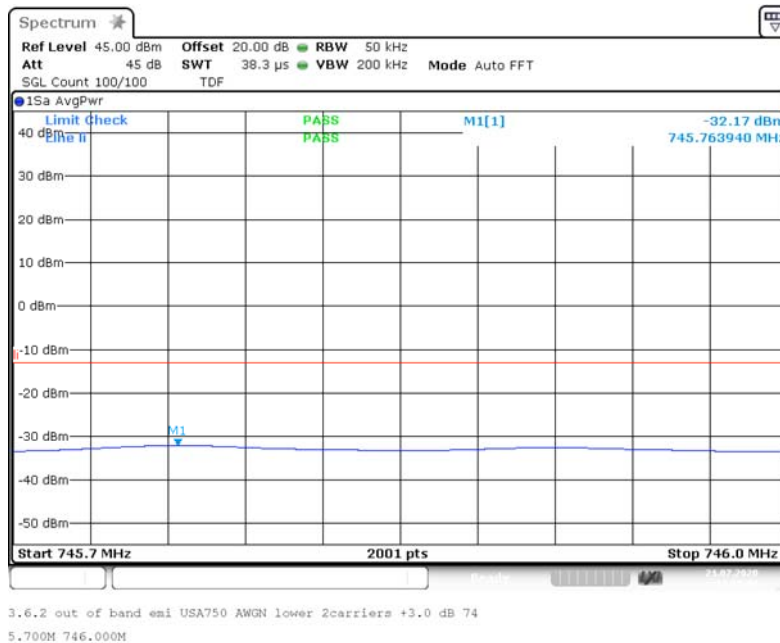



BUREAU  
VERITAS

### ECL-TA-20-002-V01.00

TA tests on Andrew CAP MX AC 6/7E/80-  
85/17E/19/23/25T

Band Edge = Lower, Frequency Band = Band 13, Number of signals = 2, Direction = RF  
downlink, Input Power = -0.3 dB < AGC, Signal Type = Narrowband

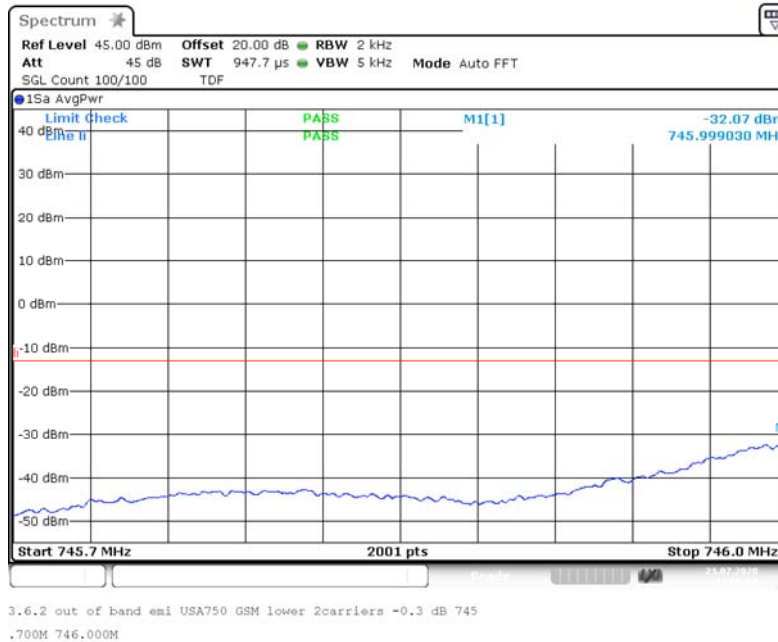

Band Edge = Lower, Frequency Band = Band 13, Number of signals = 2, Direction = RF  
downlink, Input Power = 3 dB > AGC, Signal Type = Narrowband

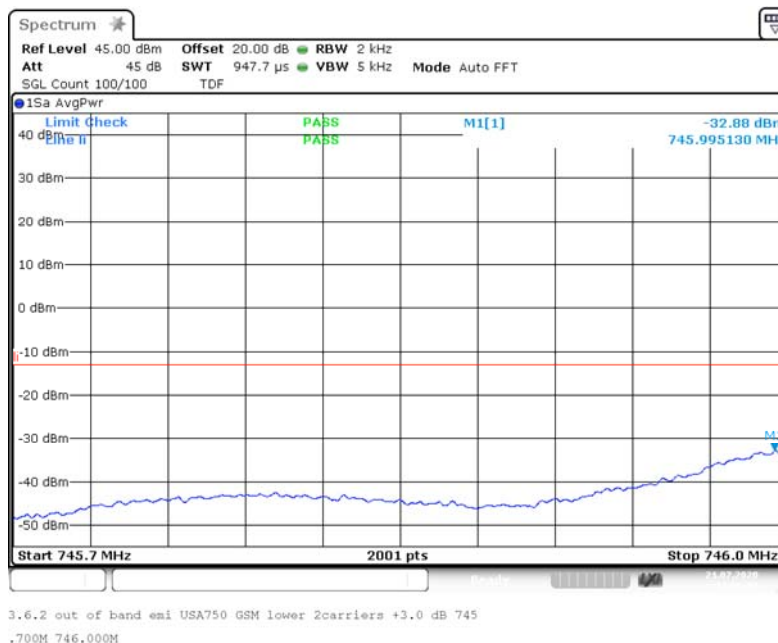

### 4.5.5 TEST EQUIPMENT USED

- Conducted

**ECL-TA-20-002-V01.00**

TA tests on Andrew CAP MX AC 6/7E/80-85/17E/19/23/25T

**4.6 OUT-OF-BAND REJECTION**

Standard FCC Part 27

**The test was performed according to:**  
ANSI C63.26; KDB 935210 D05

**Test date:** 2020-07-21

**Environmental conditions:** 25 ° C; 40 % r. F.

**Test engineer:** Thomas Hufnagel

**4.6.1 TEST DESCRIPTION**

This test case is intended to demonstrate compliance to the out-of-band rejection test case for industrial signal boosters.

The EUT was connected to the test setup according to the following diagram:

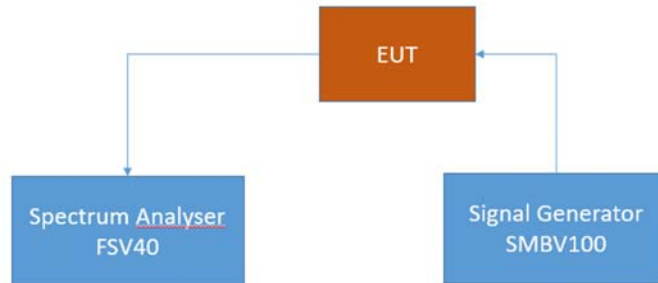

FCC Part 22/24/27/90 Industrial signal booster – Test Setup; Out-of-band rejection

The attenuation of the measuring and stimulus path are known for each measured frequency and are considered.

The Spectrum Analyzer settings can be directly found in the measurement diagrams.

**4.6.2 TEST REQUIREMENTS/LIMITS**

**RSS-131; 5.2.1 Out-of-band rejection**

The gain-versus-frequency response and the 20 dB bandwidth of the zone enhancer shall be reported. The zone enhancer shall reject amplification of other signals outside the passband of the zone enhancer.



**ECL-TA-20-002-V01.00**

TA tests on Andrew CAP MX AC 6/7E/80-85/17E/19/23/25T

**4.6.3 TEST PROTOCOL**

Band 13, downlink				
Highest Power Frequency [MHz]	Output Power [dBm]	Lower Highest Power -20 dB Frequency [MHz]	Upper Highest Power -20 dB Frequency [MHz]	20 dB Bandwidth [MHz]
746.12	24.99	745.6825	756.3025	10.620

Remark: Please see next sub-clause for the measurement plot.

**4.6.4 MEASUREMENT PLOT (SHOWING THE HIGHEST VALUE, "WORST CASE")**

Frequency Band = Band 13, Direction = RF downlink

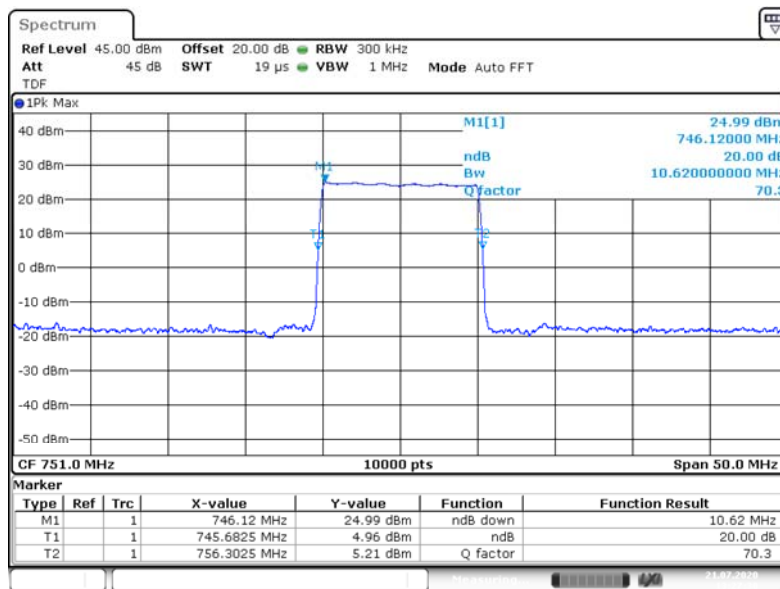

3.3 Out of band rejection USA750 751.00000M  
\_20dB

**4.6.5 TEST EQUIPMENT USED**

- Conducted

## ECL-TA-20-002-V01.00

TA tests on Andrew CAP MX AC 6/7E/80-  
85/17E/19/23/25T

### 4.7 FIELD STRENGTH OF SPURIOUS RADIATION

Standard FCC Part 27, § 24.53

The test was performed according to:  
ANSI C63.26

Test date: 2020-09-09

Environmental conditions: 23 ° C; 46 % r. F.

Test engineer: Thomas Hufnagel

#### 4.7.1 TEST DESCRIPTION

This test case is intended to demonstrate compliance to the applicable radiated spurious emission measurements per § 2.1053

The EUT was connected to the test setup according to the following diagram:

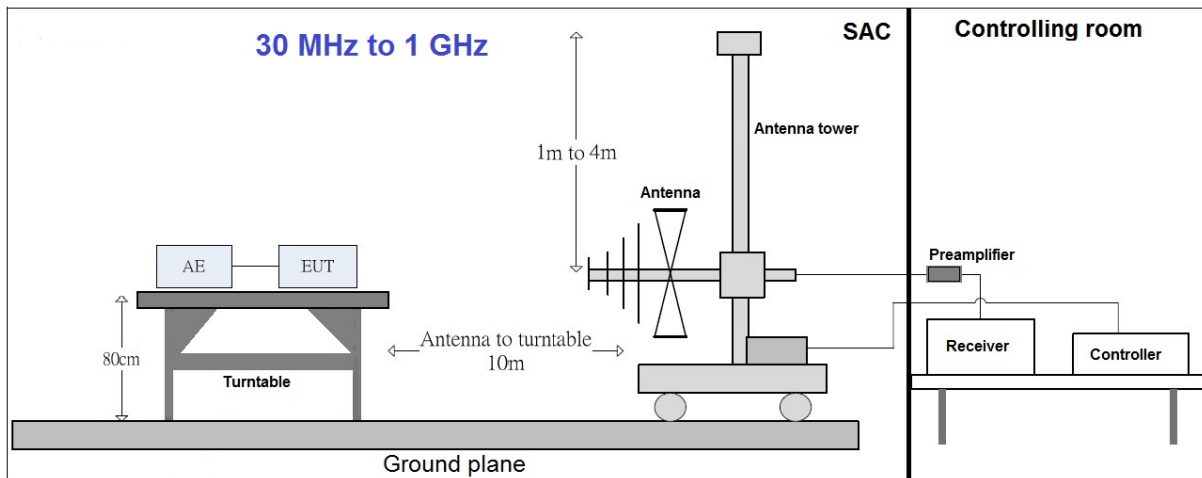



**ECL-TA-20-002-V01.00**

TA tests on Andrew CAP MX AC 6/7E/80-85/17E/19/23/25T

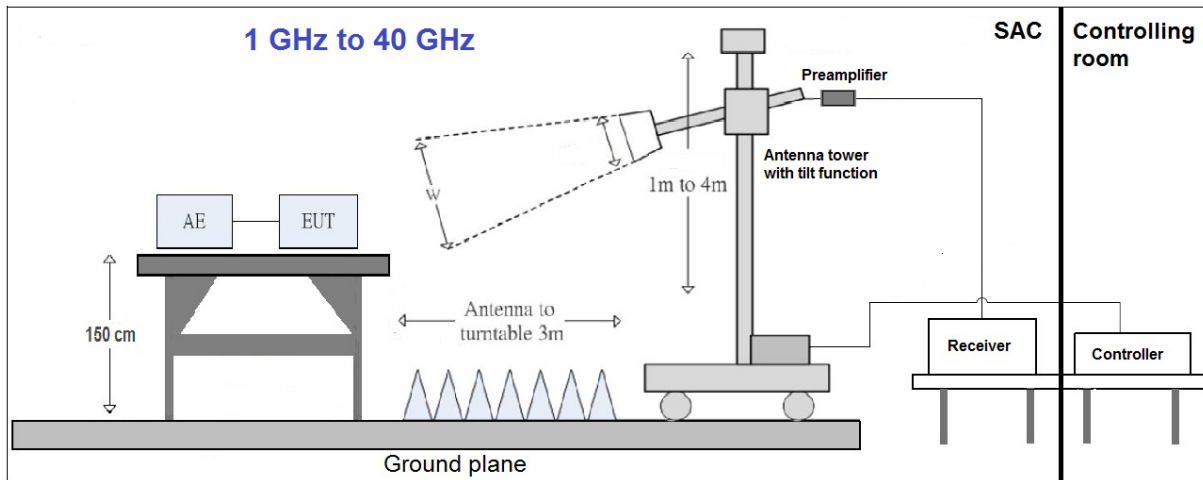

The test set-up was made in accordance to the general provisions of ANSI C63.4 in a typical installation configuration. The Equipment Under Test (EUT) was set up on a non-conductive table 1.5 x 1.5 m<sup>2</sup> in the semi-anechoic chamber, 0.8 meter above the ground or floor-standing arrangement shall be placed on the horizontal ground reference plane.. The influence of the EUT support table that is used between 30–1000 MHz was evaluated. For the initial measurements, the receiving antenna is varied from 1-4 meter height and is changed in the vertical plane from vertical to horizontal polarization at each frequency. The highest emissions between 30 MHz to 1000 MHz were analyzed in details by operating the spectrum analyzer and/or EMI receiver in quasi-peak mode to determine the precise amplitude of the emissions.

The measurement procedure is implemented into the EMI test software BAT EMC from NEXIO. Exploratory tests are performed at 3 orthogonal axes to determine the worst-case orientation of a body-worn or handheld EUT. The final test on all kind of EUTs is also performed at 3 axes. A pre-check is performed while the EUT is powered by a DC power source. ?

**1. Measurement above 30 MHz and up to 1 GHz**

**Step 1: Preliminary scan**

This is a preliminary test to identify the highest amplitudes relative to the limit.

Settings for step 1:

- Antenna distance: 10 m
- Detector: Peak-Maxhold/RMS (FFT-based)
- Frequency range: 30 – 1000 MHz
- Frequency steps: 30 kHz
- IF-Bandwidth: 120 kHz
- Measuring time/Frequency step: 5 ms
- Turntable angle range: -180° to 180°
- Turntable step size: 30°
- Height variation range: 1 – 4 m
- Height variation step size: 1 m
- Polarisation: Horizontal + Vertical

Intention of this step is, to determine the radiated EMI-profile of the EUT. Afterwards the relevant emissions for the final measurement are identified.



## ECL-TA-20-002-V01.00

TA tests on Andrew CAP MX AC 6/7E/80-  
85/17E/19/23/25T

---

### Step 2: Adjustment measurement

In this step the accuracy of the turntable azimuth and antenna height will be improved. This is necessary to find out the maximum value of every frequency.

For each frequency, which was determined the turntable azimuth and antenna height will be adjusted. The turntable azimuth will slowly vary by  $\pm 45^\circ$  around this value. During this action, the value of emission is continuously measured. The turntable azimuth at the highest emission will be recorded and adjusted. In this position, the antenna height will also slowly vary by  $\pm 100$  cm around the antenna height determined. During this action, the value of emission is also continuously measured. The antenna height of the highest emission will also be recorded and adjusted.

- Detector: Peak – Maxhold; RMS
- Measured frequencies: in step 1 determined frequencies
- IF – Bandwidth: 120 kHz
- Measuring time: 100 ms
- Turntable angle range:  $\pm 30^\circ$  around the determined value
- Antenna Polarisation: max. value determined in step 1

### Step 3: Final measurement with QP detector

With the settings determined in step 3, the final measurement will be performed:

EMI receiver settings for step 4:

- Detector: Quasi-Peak (< 1 GHz); RMS; Peak
- Measured frequencies: in step 1 determined frequencies
- IF – Bandwidth: 120 kHz
- Measuring time: 1 s

After the measurement a plot will be generated which contains a diagram with the results of the preliminary scan and a chart with the frequencies and values of the results of the final measurement.

## 3. Measurement above 1 GHz

The following modifications apply to the measurement procedure for the frequency range above 1 GHz:

### Step 1:

The Equipment Under Test (EUT) was set up on a non-conductive support at 1.5 m height in the semi-anechoic chamber. Absorbers are placed around and between the turn table and the antenna tower.

All steps were performed with one height (1.5 m) of the receiving antenna only.

The EUT is turned during the preliminary measurement across the elevation axis, with a step size of  $30^\circ$ .

The turn table step size (azimuth angle) for the preliminary measurement is  $15^\circ$ .

### Step 2:

The maximum RFI field strength was determined during the measurement by rotating the turntable ( $\pm 180$  degrees) and varying the height of the receive antenna ( $h = 1 \dots 4$  m) with an additional tilt function of the antenna. The turn table azimuth will slowly vary by  $\pm 15^\circ$ .

EMI receiver settings (for all steps):

- Detector: Peak, Average
- IF Bandwidth = 1 MHz

## ECL-TA-20-002-V01.00

TA tests on Andrew CAP MX AC 6/7E/80-  
85/17E/19/23/25T

---

### Step 3:

Spectrum analyser settings for step 3:

- Detector: Peak/Average
- Measured frequencies: in step 1 determined frequencies
- IF – Bandwidth: 1 MHz
- Measuring time: 1 s

## 4.7.2 TEST REQUIREMENTS/LIMITS

Abstract from FCC Part § 2.1053:

### **FCC Part 2.1053; Measurement required: Field strength of spurious radiation:**

Measurements shall be made to detect spurious emissions that may be radiated directly from the cabinet, control circuits, power leads, or intermediate circuit elements under normal conditions of installation and operation. Curves or equivalent data shall be supplied showing the magnitude of each harmonic and other spurious emission. For this test, single sideband, independent sideband, and controlled carrier transmitters shall be modulated under the conditions specified in paragraph (c) of § 2.1049, as appropriate.

## **Part 27; Miscellaneous Wireless Communication Services**

### **Subpart C – Technical standards**

Abstract from FCC § 27.53:

### **§ 27.53 – Emission limits**

#### **Band 13**

(c) For operations in the 746-758 MHz band and the 776-788 MHz band, the power of any emission outside the licensee's frequency band(s) of operation shall be attenuated below the transmitter power (P) within the licensed band(s) of operation, measured in watts, in accordance with the following:

(1) On any frequency outside the 746-758 MHz band, the power of any emission shall be attenuated outside the band below the transmitter power (P) by at least  $43 + 10 \log (P)$  dB.

(5) Compliance with the provisions of paragraphs (c)(1) and (c)(2) of this section is based on the use of measurement instrumentation employing a resolution bandwidth of 100 kHz or greater. However, in the 100 kHz bands immediately outside and adjacent to the frequency block, a resolution bandwidth of at least 30 kHz may be employed.

## ECL-TA-20-002-V01.00

TA tests on Andrew CAP MX AC 6/7E/80-  
85/17E/19/23/25T

---

Abstract RSS-130 4.7 from ISED:

### **RSS-130; 4.7 Transmitter Unwanted Emissions**

#### **4.7.1 General unwanted emissions limits**

The unwanted emissions in any 100 kHz bandwidth on any frequency outside the low frequency edge and the high frequency edge of each frequency block range(s), shall be attenuated below the transmitter power, P (dBW), by at least  $43 + 10 \log_{10} p$  (watts), dB. However, in the 100 kHz band immediately outside of the equipment's frequency block range, a resolution bandwidth of 30 kHz may be employed.

#### **4.7.2 Additional unwanted emissions limits**

In addition to the limit outlined in section 4.7.1 above, equipment operating in the frequency bands 746-756 MHz and 777-787 MHz shall also comply with the following restrictions:

- a) The power of any unwanted emissions in any 6.25 kHz bandwidth for all frequencies between 763-775 MHz and 793-806 MHz shall be attenuated below the transmitter power, P (dBW), by at least:
  - (i)  $76 + 10 \log_{10} p$  (watts), dB, for base and fixed equipment, and
  - (ii)  $65 + 10 \log_{10} p$  (watts), dB, for mobile and portable equipment
  
- b) The e.i.r.p. in the band 1559-1610 MHz shall not exceed -70 dBW/MHz for wideband signal and -80 dBW for discrete emission with bandwidth less than 700 Hz.



ECL-TA-20-002-V01.00

TA tests on Andrew CAP MX AC 6/7E/80-85/17E/19/23/25T

4.7.3 TEST PROTOCOL

30 MHz to 1 GHz:

Band 13, downlink;						
Spurious Freq. [MHz]	Spurious Level [dBm]	Pin (Sum Level) [dBm]	Detector	RBW [kHz]	Limit [dBm]	Margin to Limit [dB]
36.25	-66.0	-2.9	PEAK	120	-13.0	53.0
70.16	-56.0	-2.9	PEAK	120	-13.0	43.0
134.39	-64.5	-2.9	PEAK	120	-13.0	51.5
273.33	-53.1	-2.9	PEAK	120	-13.0	40.1
599.98	-63.5	-2.9	PEAK	120	-13.0	50.5
746.21	-55.0	-2.9	PEAK	120	-13.0	42.0

Above 1 GHz:

Band 13, downlink;						
Spurious Freq. [MHz]	Spurious Level [dBm]	Pin (Sum Level) [dBm]	Detector	RBW [kHz]	Limit [dBm]	Margin to Limit [dB]
2844.83	-43.7	-3.1	PEAK	1000	-13.0	30.7
3549.32	-41.4	-3.1	PEAK	1000	-13.0	28.4
8496.2	-29.3	-3.1	PEAK	1000	-13.0	16.3
3571.6	-42.0	-3.1	PEAK	1000	-13.0	29.0
16743.4	-20.8	-3.1	PEAK	1000	-13.0	7.8
17746.3	-20.6	-3.1	PEAK	1000	-13.0	7.6

Remarks: Please see next sub-clause for the measurement plot.

Although usually a RMS detector is used for measurements in this cases a PEAK detector was used.

The limits are values for use of a RMS detector, but it is so, that the use of a PEAK detector results in readings with higher measured levels. Because the levels with the higher values with PEAK detector are in tolerance, the limits with a RMS detector are definitely also in tolerance.



BUREAU  
VERITAS

### ECL-TA-20-002-V01.00

TA tests on Andrew CAP MX AC 6/7E/80-  
85/17E/19/23/25T

#### 4.7.4 MEASUREMENT PLOT (SHOWING THE HIGHEST VALUE, "WORST CASE")

Frequency Band = Band 13, Test Frequency = low, Direction = RF downlink

30 MHz - 1 GHz

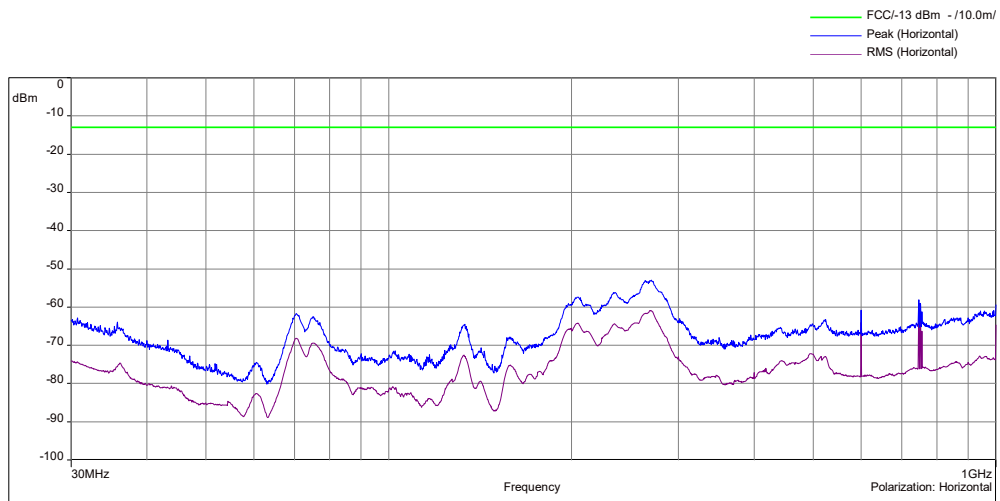
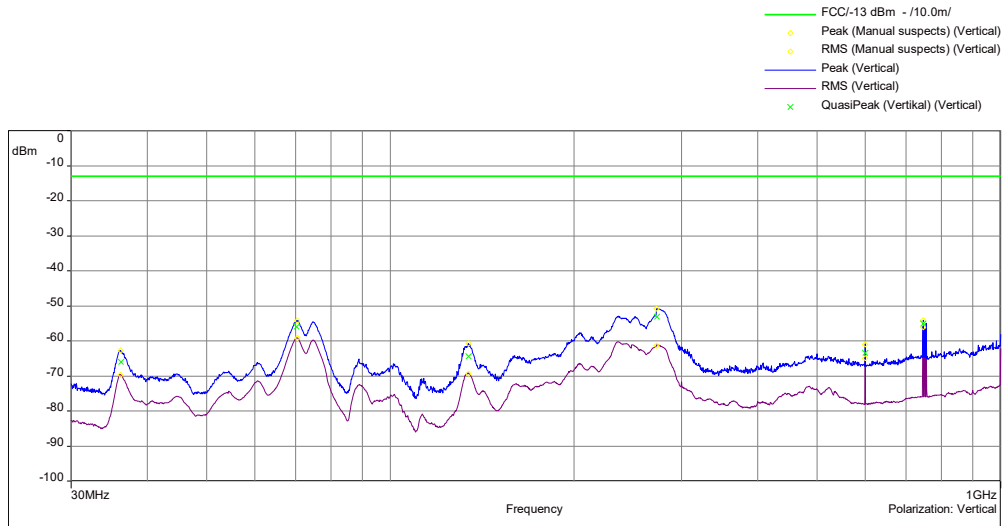



BUREAU  
VERITAS

### ECL-TA-20-002-V01.00

TA tests on Andrew CAP MX AC 6/7E/80-  
85/17E/19/23/25T

### 1 GHz - 18 GHz

- FCC-13 dBm - /3.0m/
- Peak (Manual suspects) (Vertical)
- Avg (Manual suspects) (Vertical)
- RMS (Manual suspects) (Vertical)
- Peak (Vertical)
- Avg (Vertical)
- RMS (Vertical)
- Peak (Vertical) (Vertical)
- Average (Vertical) (Vertical)
- Peak (Vertical) (Vertical)
- RMS (Vertical) (Vertical)

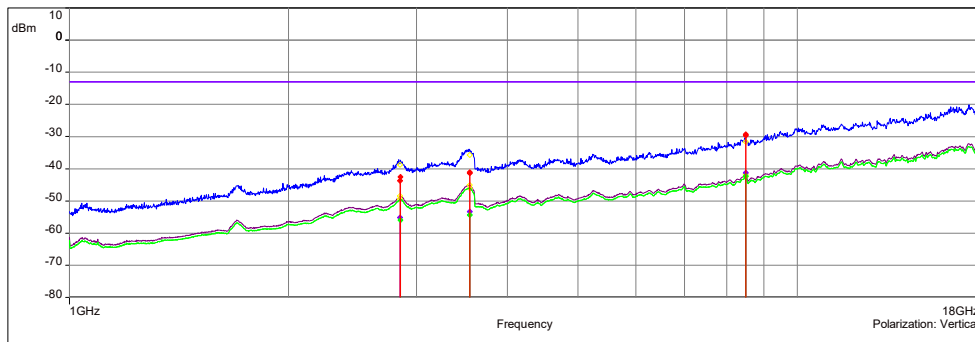

- FCC-13 dBm - /3.0m/
- Peak (Manual suspects) (Horizontal)
- Avg (Manual suspects) (Horizontal)
- RMS (Manual suspects) (Horizontal)
- Peak (Horizontal)
- Avg (Horizontal)
- RMS (Horizontal)
- Peak (Vertical) (Horizontal)
- Average (Vertical) (Horizontal)
- Peak (Vertical) (Horizontal)
- RMS (Vertical) (Horizontal)

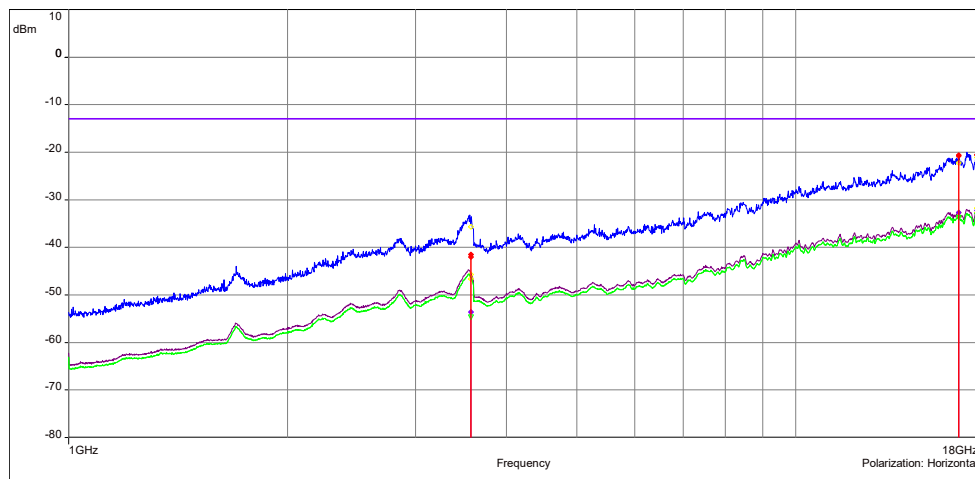



**BUREAU**  
**VERITAS**

## **ECL-TA-20-002-V01.00**

TA tests on Andrew CAP MX AC 6/7E/80-  
85/17E/19/23/25T

---

### 4.7.5 FIELD STRENGTH CALCULATIONS

$$\mathbf{FS} = \mathbf{SA} + \mathbf{AF} + \mathbf{CL} + \mathbf{PA}$$

Where as:

- FS** = Field strength
- SA** = EMC test receiver reading
- AF** = Antenna factor
- CL** = Cable loss
- PA** = Preamplifier

### 4.7.6 TEST EQUIPMENT USED

- Radiated Emissions





## ECL-TA-20-002-V01.00

TA tests on Andrew CAP MX AC 6/7E/80-  
85/17E/19/23/25T

### 5 TEST EQUIPMENT

#### 1 Conducted

Ref.No.	Type	Description	Manufacturer	Inventory no.	Last Calibration	Calibration Due
1.1	FSV40	Signal Analyzer 10 Hz - 40 GHz	Rohde & Schwarz	E2050	2019-10	2020-10
1.2	SMBV100A	Vector Signal Generator 9 kHz - 6 GHz	Rohde & Schwarz	G2089	2017-08/ 2020-08	2022-08
1.3	SMIQ	Vector Signal Generator 9 kHz - 3.3 GHz	Rohde & Schwarz	G1509	2018-10	2021-10
1.4	SMIQ	Vector Signal Generator 9 kHz - 3.3 GHz	Rohde & Schwarz	G1510	2018-10	2021-10
1.5	ESH3-Z5	Line Impedance Stabilisation Network (LISN) 150 Hz - 30 MHz	Rohde & Schwarz	K794	2019-02	2020-10
1.6	30.3015	ThermoHygro Datalogger	TFA	X 507	2018-08	2021-08
1.7	BAT-EMC	Software	Nexio	V3.17.0.26	---	---

#### 2 Radiated Emissions

Ref.No.	Type	Description	Manufacturer	Inventory no.	Last Calibration	Calibration Due
2.1	ESU40	EMI test receiver 10 Hz - 40 GHz	Rohde & Schwarz	E2025	2018-10	2020-10
2.2	HFH2-Z2	Antenna 9 kHz - 30 MHz	Rohde & Schwarz	K549	2018-10	2020-10
2.3	CBL 6111C	Antenna 30 MHz - 1 GHz	Chase	K1026	2020-01	2021-01
2.4	HL 025	Antenna 1 GHz - 18 GHz	Rohde & Schwarz	K1114	2019-06	2021-06
2.5	MWH-1826/B	Antenna 18 GHz - 26.5 GHz	ARA Inc.	K1042	2018-11	2020-11
2.6	MWH-2640/B	Antenna 26 GHz - 40 GHz	ARA Inc.	K1043	2018-11	2020-11
2.7	AM1431	Pre amplifier 10 kHz - 1 GHz	Miteq	K1721	2019-10	2020-10
2.8	AFS4-00102000	Preamplifier 100 MHz - 20 GHz	Miteq	K817	2019-08	2021-08.
2.9	AFS4-00102000	Preamplifier 100 MHz - 20 GHz	Miteq	K838	2019-10	2020-10
2.10	JS43-1800-4000	Preamplifier 18 GHz - 40 GHz	Miteq	K1104	2019-05	2020-10
2.11	BAT-EMC	Software	Nexio	V3.17.0.26	---	---



**ECL-TA-20-002-V01.00**

TA tests on Andrew CAP MX AC 6/7E/80-85/17E/19/23/25T

**6 ANTENNA FACTORS, CABLE LOSS AND SAMPLE CALCULATIONS**

This chapter contains the antenna factors with their corresponding path loss of the used measurement path for all antennas.

**6.1 ANTENNA CHASE CBL 6111C (30 MHZ – 1 GHZ)**

(d = 10 m)

Frequency	AF Horizontal R&S CBL 6111C	AF Vertikal R&S CBL 6111C	Corr.
30	47.9	38.1	-38.1
50	34.4	26.4	-38.0
100	31.6	32.8	-38.0
150	33.7	33.9	-37.9
200	30.3	32.8	-37.7
250	33.6	36.5	-37.5
300	34.5	36.8	-37.1
350	36.3	37.2	-37.0
400	36.9	38.3	-36.8
450	38.0	39.6	-36.5
500	39.2	40.4	-36.0
550	41.2	42.1	-35.9
600	41.6	41.7	-35.7
650	41.9	42.9	-35.9
700	42.3	43.4	-35.6
750	43.5	43.9	-35.7
800	43.6	44.6	-36.0
850	45.0	45.1	-36.1
900	45.2	45.1	-36.6
950	46.4	46.4	-36.4
1000	45.8	47.0	-36.0

cable loss (antenna - pre-amp)	pre-amp	cable loss (inside chamber)	cable loss (to receiver)
-0,01	-38.3	0.0	0.1
0,28	-38.4	0.3	0.1
0,52	-38.7	0.5	0.2
0,73	-38.8	0.7	0.2
0,95	-38.9	1.0	0.3
1,10	-38.9	1.1	0.3
1,20	-38.6	1.2	0.3
1,29	-38.6	1.3	0.3
1,36	-38.5	1.4	0.3
1,42	-38.2	1.4	0.4
1,48	-37.9	1.5	0.4
1,54	-37.8	1.5	0.4
1,60	-37.7	1.6	0.4
1,64	-38.0	1.6	0.5
1,71	-37.8	1.7	0.5
1,76	-38.0	1.8	0.5
1,80	-38.3	1.8	0.5
1,84	-38.4	1.8	0.5
1,91	-39.0	1.9	0.5
1,93	-38.9	1.9	0.6
1,99	-38.6	2.0	0.6

**Sample calculation**

$E \text{ (dB } \mu\text{V/m)} = U \text{ (dB } \mu\text{V)} + AF \text{ (dB 1/m)} + Corr. \text{ (dB)}$   
 U = Receiver reading  
 AF = Antenna factor  
 Corr. = sum of single correction factors of used cables, switch unit, distance correction, amplifier (if applicable)  
 distance correction =  $-20 * LOG (d_{Limit}/ d_{used})$   
 Linear interpolation will be used for frequencies in between the values in the table.  
 Tables show an extract of values.



**ECL-TA-20-002-V01.00**

TA tests on Andrew CAP MX AC 6/7E/80-  
85/17E/19/23/25T

**6.2 ANTENNA ROHDE & SCHWARZ HL 025 (1 GHZ – 18 GHZ)**

Frequency	AF R&S HL 025	Corr.
MHz	dB (1/m)	dB
1000	33.2	-18.9
2000	39.4	-17.8
3000	42.8	-17.0
4000	45.1	-16.6
5000	46.8	-16.6
6000	48.5	-16.7
7000	50.2	-16.2
8000	50.4	-15.3
9000	51.9	-14.4
10000	53.8	-14.0
11000	54.5	-14.1
12000	55.3	-14.4
13000	55.7	-14.7
14000	56.5	-14.8
15000	56.4	-14.7
16000	57.2	-14.3
17000	57.6	-14.5
18000	57.6	-14.6

pre-amp	cable loss (to receiver)
dB	dB
-20.92	2.01
-20.60	2.78
-20.44	3.42
-20.58	3.99
-21.08	4.46
-21.53	4.87
-21.53	5.35
-20.97	5.66
-20.44	6.05
-20.43	6.45
-20.84	6.69
-21.41	7.04
-22.09	7.36
-22.48	7.66
-22.56	7.90
-22.49	8.20
-22.90	8.45
-23.27	8.71

**Sample calculation**

$$E \text{ (dB } \mu\text{V/m)} = U \text{ (dB } \mu\text{V)} + AF \text{ (dB 1/m)} + Corr. \text{ (dB)}$$

U = Receiver reading

AF = Antenna factor

Corr. = sum of single correction factors of used cables, switch unit, distance correction, amplifier (if applicable)

Linear interpolation will be used for frequencies in between the values in the table.

Tables show an extract of values.



**ECL-TA-20-002-V01.00**

TA tests on Andrew CAP MX AC 6/7E/80-85/17E/19/23/25T

**6.3 ANTENNA ARA INC. MWH-1826-B (18 GHZ – 26.5 GHZ) PARTIALLY IN CONJUNCTION WITH PRE-AMPLIFIER MITEQ JS43-1800-4000: THE USE OF THE PRE-AMPLIFIER IS DEPENDENT FROM THE FIELD STRENGTH**

Frequency	AF	Corr.
MHz	EMCO 3160-09 dB (1/m)	dB
18000	44.3	-37.5
18500	43.9	-37.6
19000	44.4	-36.9
19500	44.1	-36.1
20000	44.6	-36.3
20500	44.9	-36.1
21000	45.2	-35.9
21500	45.0	-35.7
22000	45.1	-35.3
22500	45.4	-35.0
23000	45.7	-35.6
23500	45.8	-34.3
24000	45.3	-34.8
24500	45.3	-35.0
25000	46.1	-34.3
25500	46.5	-34.2
26000	46.7	-34.8
26500	46.5	-34.4
27000	46.4	-35.1

pre-amp	cable loss (to receiver)
dB	dB
-46.2	8.7
-46.4	8.8
-45.9	9.0
-45.2	9.1
-45.6	9.3
-45.5	9.4
-45.3	9.4
-45.3	9.7
-45.1	9.8
-44.8	9.8
-45.5	9.9
-44.4	10.1
-45.0	10.2
-45.3	10.4
-44.8	10.5
-44.7	10.5
-45.4	10.6
-45.1	10.7
-46.0	10.9

**Sample calculation**

$E \text{ (dB } \mu\text{V/m)} = U \text{ (dB } \mu\text{V)} + AF \text{ (dB 1/m)} + Corr. \text{ (dB)}$   
 U = Receiver reading  
 AF = Antenna factor  
 Corr. = sum of single correction factors of used cables, switch unit, distance correction, amplifier (if applicable)  
 Linear interpolation will be used for frequencies in between the values in the table.  
 Table shows an extract of values.



**BUREAU  
VERITAS**

## ECL-TA-20-002-V01.00

TA tests on Andrew CAP MX AC 6/7E/80-  
85/17E/19/23/25T

### 7 MEASUREMENT UNCERTAINTIES

<b>KDB 935210 D05</b>	<b>ECL</b>
Power measurement	0,68 dB
Measuring AGC threshold level	0,90 dB
Out of band rejection	0,90 dB
Input-versus-output signal comparison	0,91 dB
Mean power output	0,90 dB
Measuring out-of-band/out-of-block (including intermodulation) emissions and spurious emissions	0,90 dB
Out-of-band/out-of-block emissions conducted measurements	0,90 dB
Spurious emissions conducted	2,18 dB
Spurious emissions radiated measurements	5,38 dB
Total frequency uncertainty	$2 \times 10^{-7}$

reference :

ECL-MU5.4.6.3-EMC-14-001-V03.00 MU Wireless.xlsx

**ECL-TA-20-002-V01.00**

TA tests on Andrew CAP MX AC 6/7E/80-85/17E/19/23/25T

**8 PHOTO REPORT**

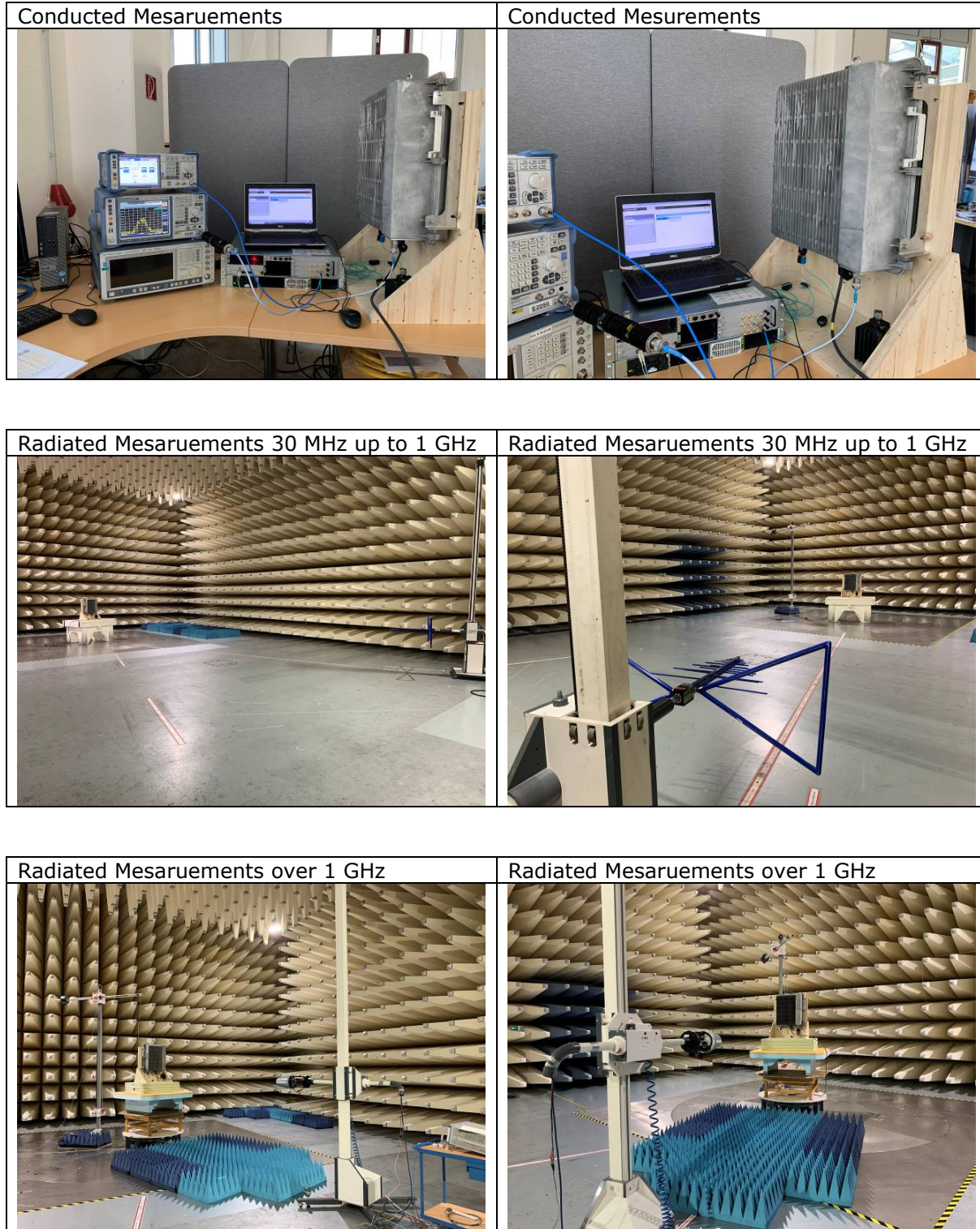



**BUREAU  
VERITAS**

## **ECL-TA-20-002-V01.00**

TA tests on Andrew CAP MX AC 6/7E/80-  
85/17E/19/23/25T

---

### **Annex A: Accreditation certificate (for information)**

The accreditation relates to competences stated on the accreditation certificate. The current certificate is available on the homepage of the DAkkS and can be downloaded under accredited bodies with the processing number:

<https://www.dakks.de/en>



**BUREAU**  
**VERITAS**

**ECL-TA-20-002-V01.00**

TA tests on Andrew CAP MX AC 6/7E/80-  
85/17E/19/23/25T

---

**Annex B: Additional information provided by client**

None.

\*\*\*\*\* End of test report \*\*\*\*\*