



ECL-TA Test Report No.: 20-012

Designation:	CAP MX AC 6/7E/80-85/17E/19/23/25T
Manufacturer:	Andrew
Serial No(s):	8
ID No.	7830127-0001, Rev.: 00
Test Specification(s):	ANSI 63.26:2015 FCC Rules and Regulations as listed in 47 CFR, Part 20:2019-10-01
Test Plan:	Measurement of Band 66 low/AWS 1700E high downlink.
Test Result:	Passed

Date of issue:	2020-10-23		Signature:
Version:	01	Technical Reviewer:	
Date of delivery:	2020-07		
Performance date:	2020-08-20. – 2020-10-22	Report Reviewer:	



The test results relates only to the tested item. The sample has been provided by the client.
Without the written consent of Bureau Veritas Consumer Products Services Germany GmbH excerpts of this report shall not be reproduced.

Bureau Veritas
Consumer Products Services Germany GmbH
www.bureauveritas.de/cps
Phone: +49 (0)40 – 740 41 – 0

Schwerin
Wilhelm-Hennemann-Str. 8, 19061 Schwerin
cps-schwerin@de.bureauveritas.com

Tuerkheim
Businesspark A96, 86842 Tuerkheim
cps-tuerkheim@de.bureauveritas.com

Managing Director: Sebastian Doose/Stefan Kischka

Hamburg
Oehleckerring 40, 22419 Hamburg
cps-hamburg@de.bureauveritas.com

Nuremberg
Thurn-und-Taxis-Str. 18, 90411 Nuremberg
cps-nuernberg@de.bureauveritas.com

Reg.No.: Schwerin HRB 3564



**BUREAU
VERITAS**

EfectiveECL-TA-20-012-V01.00

TA tests on Andrew CAP MX AC 6/7E/80-
85/17E/19/23/25T

Commscope

Client:

Andrew Wireless System GmbH

Industriering 10

86675 Buchdorf Germany

Test Laboratory:

Bureau Veritas Consumer Products Services Germany GmbH

Thurn-und-Taxis-Straße 18

D-90411 Nürnberg

Tel.: +49 40 74041 0

Fax: +49 40 74041-2755

Versions management:

V01.00

Initial release



Effective ECL-TA-20-012-V01.00

TA tests on Andrew CAP MX AC 6/7E/80-
85/17E/19/23/25T

Table of Contents

1	ADMINISTRATIVE DATA	4
1.1	TESTING LABORATORY.....	4
1.2	APPLICANT DATA	4
1.3	MANUFACTURER DATA	4
2	APPLIED STANDARDS AND TEST SUMMARY	5
2.1	APPLIED STANDARDS	5
2.2	FCC-MEASUREMENT REQUIREMENTS.....	6
2.3	MEASUREMENT SUMMARY/SIGNATURES	7
3	TEST OBJECT DATA.....	10
3.1	GENERAL EUT DESCRIPTION	10
3.2	EUT MAIN COMPONENTS	11
3.3	ANCILLARY EQUIPMENT	11
3.4	AUXILIARY EQUIPMENT.....	12
3.5	EUT SETUPS.....	13
3.6	PRODUCT LABELLING.....	14
4	TEST RESULTS	15
4.1	EFFECTIVE RADIATED POWER, MEAN OUTPUT POWER AND ZONE ENHANCER GAIN 15	
4.2	PEAK TO AVERAGE RATIO	21
4.3	OCCUPIED BANDWIDTH/INPUT-VERSUS-OUTPUT SPECTRUM.....	25
4.4	CONDUCTED SPURIOUS EMISSIONS AT ANTENNA TERMINALS.....	31
4.5	OUT-OF-BAND EMISSION LIMITS	40
4.6	OUT-OF-BAND REJECTION	52
4.7	FIELD STRENGTH OF SPURIOUS RADIATION.....	54
5	TEST EQUIPMENT	63
6	ANTENNA FACTORS, CABLE LOSS AND SAMPLE CALCULATIONS	64
6.1	ANTENNA CHASE CBL 6111C (30 MHZ – 1 GHZ)	64
6.2	ANTENNA ROHDE & SCHWARZ HL 025 (1 GHZ – 18 GHZ)	65
6.3	ANTENNA ARA INC. MWH-1826-B (18 GHZ – 26.5 GHZ) PARTIALLY IN CONJUNCTION WITH PRE-AMPLIFIER MITEQ JS43-1800-4000: THE USE OF THE PRE-AMPLIFIER IS DEPENDENT FROM THE FIELD STRENGTH	66
7	MEASUREMENT UNCERTAINTIES.....	67
8	PHOTO REPORT	68
	Annex A: Accreditation certificate (for information)	69
	Annex B: Additional information provided by client.....	70



EffectiveECL-TA-20-012-V01.00

TA tests on Andrew CAP MX AC 6/7E/80-
85/17E/19/23/25T

1 ADMINISTRATIVE DATA

1.1 TESTING LABORATORY

Bureau Veritas Consumer Products Services Germany GmbH
Thurn-und-Taxis-Straße 18
D-90411 Nürnberg
Tel.: +49 40 74041 0
Fax: +49 40 74041-2755

1.2 APPLICANT DATA

Company Name: Commscope
Andrew Wireless Systems GmbH

Address: Industriering 10
86675 Buchdorf
Germany

Contact Person: Mr. Frank Futter

1.3 MANUFACTURER DATA

Company Name: Please see applicant data.

Address:



Effective ECL-TA-20-012-V01.00

TA tests on Andrew CAP MX AC 6/7E/80-
85/17E/19/23/25T

2 APPLIED STANDARDS AND TEST SUMMARY

2.1 APPLIED STANDARDS

Type of Authorization

Certification for an Industrial Signal Booster.

Applicable FCC Rules

Prepared in accordance with the requirements of FCC Rules and Regulations as listed in 47 CFR Ch.1 Parts 2 and 20, 22 and 24. The following subparts are applicable to the results in this test report.

Part 2, Subpart J - Equipment Authorization Procedures, Certification

Part 20, Commercial Mobile Services

§ 20.21 Signal Boosters

Part 27; Miscellaneous Wireless Communications Services

Subpart C – Technical standards

§ 27.50 – Power and antenna height limits

§ 27.54 – Frequency stability

§ 27.53 – Emission limitations for broadband PCS equipment

The tests were selected and performed with reference to:

- FCC Public Notice 935210 applying "Signal Boosters Basic Certification Requirements" 935210 D02, 2019-15-04.
- FCC Public Notice 935210 applying "Measurement guidance for industrial and non-consumer signal booster, repeater and amplifier devices" 935210 D05, 2019-04-03.
- FCC Public Notice 971168 applying "Measurement guidance for certification of licensed digital transmitters" 971168 D01, 2019-04-09.
- ANSI C63.26: 2015



Effective ECL-TA-20-012-V01.00

TA tests on Andrew CAP MX AC 6/7E/80-
85/17E/19/23/25T

Summary Test Results:

The EUT complies with all performed tests as listed in chapter 1.3 Measurement Summary/Signatures.

2.2 FCC-MEASUREMENT REQUIREMENTS

**Table of FCC references for
Industrial Signal Booster**

Measurement	FCC reference
Effective radiated power, mean output power and zone enhancer gain	§ 2.1046 § 27.50 KDB 935210 D05 v01r04: 3.5
Peak to Average Ratio	§ 27.50
Occupied bandwidth Input-versus-output spectrum	§ 2.1049 KDB 935210 D05 v01r04: 3.4
Conducted spurious Emission at Antenna Terminal	§ 2.1051 § 27.53 KDB 935210 D05 v01r04: 3.6
Out-of-band emissions limits	§ 2.1051 § 27.53 KDB 935210 D05 v01r04: 3.6
Frequency stability	§ 2.1055 § 27.54
Field strength of spurious radiation	§ 2.1053 § 27.53
Out-of-band rejection	KDB 935210 D05 v01r04: 3.3
All measurements	ANSI 63.26



**BUREAU
VERITAS**

Effective ECL-TA-20-012-V01.00

TA tests on Andrew CAP MX AC 6/7E/80-
85/17E/19/23/25T

2.3 MEASUREMENT SUMMARY/SIGNATURES

**47 CFR CHAPTER I FCC PART 24 Subpart E [Base § 2.1046, § 27.50
Stations/Repeater]**

Effective Radiated Power, mean output power and zone enhancer gain
The measurement was performed according to ANSI C63.26, KDB
935210 D05 v01r04: 3.5

Final Result

OP-Mode

Frequency Band, Direction, Input Power, Signal Type

Band 66 AWS 1700E high, RF downlink, 0.3 dB < AGC, Narrowband	Passed
Band 66 AWS 1700E high, RF downlink, 0.3 dB < AGC, Wideband	Passed
Band 66 AWS 1700E high, RF downlink, 3 dB > AGC, Narrowband	Passed
Band 66 AWS 1700E high, RF downlink, 3 dB > AGC, Wideband	Passed

**47 CFR CHAPTER I FCC PART 24 Subpart E [Base § 27.50
Stations/Repeater]**

Peak to Average Ratio

The measurement was performed according to ANSI C63.26

Final Result

Band 66 AWS 1700E high, RF downlink, 0.3 dB < AGC, Narrowband	Passed
Band 66 AWS 1700E high, RF downlink, 0.3 dB < AGC, Wideband	Passed
Band 66 AWS 1700E high, RF downlink, 3 dB > AGC, Narrowband	Passed
Band 66 AWS 1700E high, RF downlink, 3 dB > AGC, Wideband	Passed

**47 CFR CHAPTER I FCC PART 24 Subpart E [Base § 2.1049
Stations/Repeater]**

Occupied Bandwidth/Input-versus-output Spectrum

The measurement was performed according to ANSI C63.26, KDB
935210 D05 v01r04: 3.4

Final Result

OP-Mode

Frequency Band, Direction, Input Power, Signal Type

Band 66 AWS 1700E high, RF downlink, 0.3 dB < AGC, Narrowband	Passed
Band 66 AWS 1700E high, RF downlink, 0.3 dB < AGC, Wideband	Passed
Band 66 AWS 1700E high, RF downlink, 3 dB > AGC, Narrowband	Passed
Band 66 AWS 1700E high, RF downlink, 3 dB > AGC, Wideband	Passed



Effective ECL-TA-20-012-V01.00

TA tests on Andrew CAP MX AC 6/7E/80-85/17E/19/23/25T

47 CFR CHAPTER I FCC PART 24 Subpart E [Base § 2.1051, § 27.53 Stations/Repeater]

Conducted spurious emissions at antenna terminals
The measurement was performed according to ANSI C63.26 **Final Result**

OP-Mode

Frequency Band, Direction, Input Power, Signal Type	
Band 66 AWS 1700E high, RF downlink, 0.3 dB < AGC, Narrowband	Passed
Band 66 AWS 1700E high, RF downlink, 0.3 dB < AGC, Wideband	Passed
Band 66 AWS 1700E high, RF downlink, 3 dB > AGC, Narrowband	Passed
Band 66 AWS 1700E high, RF downlink, 3 dB > AGC, Wideband	Passed

47 CFR CHAPTER I FCC PART 24 Subpart E [Base § 2.1051, § 27.53 Stations/Repeater]

Out-of-band emission limits
The measurement was performed according to ANSI C63.26, KDB 935210 D05 v01r04: 3.6 **Final Result**

OP-Mode

Band Edge, Frequency Band, Number of signals, Direction, Input Power, Signal Type	
Band 66 AWS 1700E high, RF downlink, 0.3 dB < AGC, Narrowband	Passed
Band 66 AWS 1700E high, RF downlink, 0.3 dB < AGC, Wideband	Passed
Band 66 AWS 1700E high, RF downlink, 3 dB > AGC, Narrowband	Passed
Band 66 AWS 1700E high, RF downlink, 3 dB > AGC, Wideband	Passed

47 CFR CHAPTER I FCC PART 24 Subpart E [Base § 2.1051, § 27.53 Stations/Repeater]

Out-of-band emission limits
The measurement was performed according to ANSI C63.26, KDB 935210 D05 v01r04: 3.6 **Final Result**

OP-Mode

Band Edge, Frequency Band, Number of signals, Direction, Input Power, Signal Type	
Lower, Band 66 AWS 1700E high, 1, RF downlink, 0.3 dB < AGC, Narrowband	Passed
Lower, Band 66 AWS 1700E high, 1, RF downlink, 0.3 dB < AGC, Wideband	Passed
Lower, Band 66 AWS 1700E high, 1, RF downlink, 3 dB > AGC, Narrowband	Passed
Lower, Band 66 AWS 1700E high, 1, RF downlink, 3 dB > AGC, Wideband	Passed
Lower, Band 66 AWS 1700E high, 2, RF downlink, 0.3 dB < AGC, Narrowband	Passed
Lower, Band 66 AWS 1700E high, 2, RF downlink, 0.3 dB < AGC, Wideband	Passed
Lower, Band 66 AWS 1700E high, 2, RF downlink, 3 dB > AGC, Narrowband	Passed
Lower, Band 66 AWS 1700E high, 2, RF downlink, 3 dB > AGC, Wideband	Passed



Effective ECL-TA-20-012-V01.00

TA tests on Andrew CAP MX AC 6/7E/80-85/17E/19/23/25T

47 CFR CHAPTER I FCC PART 24 Subpart E [Base § 2.1051, § 27.53 Stations/Repeater]

Out-of-band emission limits

The measurement was performed according to ANSI C63.26, KDB 935210 D05 v01r04: 3.6

Final Result

OP-Mode

Band Edge, Frequency Band, Number of signals, Direction, Input Power, Signal Type

Upper, Band 66 AWS 1700E high, 1, RF downlink, 0.3 dB < AGC, Narrowband	Passed
Upper, Band 66 AWS 1700E high, 1, RF downlink, 0.3 dB < AGC, Wideband	Passed
Upper, Band 66 AWS 1700E high, 1, RF downlink, 3 dB > AGC, Narrowband	Passed
Upper, Band 66 AWS 1700E high, 1, RF downlink, 3 dB > AGC, Wideband	Passed
Upper, Band 66 AWS 1700E high, 2, RF downlink, 0.3 dB < AGC, Narrowband	Passed
Upper, Band 66 AWS 1700E high, 2, RF downlink, 0.3 dB < AGC, Wideband	Passed
Upper, Band 66 AWS 1700E high, 2, RF downlink, 3 dB > AGC, Narrowband	Passed
Upper, Band 66 AWS 1700E high, 2, RF downlink, 3 dB > AGC, Wideband	Passed

47 CFR CHAPTER I FCC PART 24 Subpart E [Base KDB 935210 D05 v01r04: 3.3 Stations/Repeater]

Out-of-band rejection

The measurement was performed according to ANSI C63.26; KDB 935210 D05 v01r04: 3.3

Final Result

OP-Mode

Setup

Frequency Band, Direction

Band 66 AWS 1700E high, RF downlink	Passed
-------------------------------------	--------

47 CFR CHAPTER I FCC PART 24 Subpart E [Base § 2.1053, § 27.53 Stations/Repeater]

Field strength of spurious radiation

The measurement was performed according to ANSI C63.26

Final Result

OP-Mode

Frequency Band, Test Frequency, Direction

Band 66 AWS 1700E high, high, RF downlink	Passed
Band 66 AWS 1700E high, low, RF downlink	Passed
Band 66 AWS 1700E high, mid, RF downlink	Passed

The test case frequency stability was not performed, since the EUT is not equipped with signal processing capabilities.



EfectiveECL-TA-20-012-V01.00

TA tests on Andrew CAP MX AC 6/7E/80-85/17E/19/23/25T

3 TEST OBJECT DATA

3.1 GENERAL EUT DESCRIPTION

Kind of Device product description	Cellular Repeater
Product name	Cellular Repeater
Type	
Declared EUT data by the supplier	
General Product Description	The EUT is an industrial signal booster supporting the following: Band 5/CELL 850 Band 5 CELL 850/USA 700E Band 5 CELL 850/USA 750 Band 14/LMR 750 Band 25/PCS 1900 Band 27/CELL 800 Band 30/WCS 2300 Band 41/BRS Band 66/AWS 1700E (partly): 2180 MHz to 2200 MHz, therefore in this report also named "AWS 1700E high" Band 70/Band 70 Band 71/USA 600 A RF operation is only supported for the downlink.
Booster Type	Industrial Signal Booster
Voltage Type	AC/50 Hz – 60 Hz
Voltage Level	100 V - 240 V
Maximum Output Donor Port [Uplink]	-
Nominal Output Server Port [Downlink]	All bands: 33 dBm
Nominal Gain [Uplink]	-
Nominal Gain [Downlink]	All bands: 33 dB

The main components of the EUT are listed and described in chapter 3.2 EUT Main components.



Effective ECL-TA-20-012-V01.00

TA tests on Andrew CAP MX AC 6/7E/80-
85/17E/19/23/25T

3.2 EUT MAIN COMPONENTS

Sample Name	FCC-ID	
	XS5-CAPMX	
Sample Parameter	Value	
Serial Number	8	
HW Version	7830127-0001 Rev.: 00	
SW Version	2.9.0.292	
Comment	-----	

NOTE: The short description is used to simplify the identification of the EUT in this test report.

3.3 ANCILLARY EQUIPMENT

For the purposes of this test report, ancillary equipment is defined as equipment which is used in conjunction with the EUT to provide operational and control features to the EUT. It is necessary to configure the system in a typical fashion, as a customer would normally use it. But nevertheless Ancillary Equipment can influence the test results.

Device	Details (Manufacturer, Type Model, OUT Code)	Description
-	-	-



EfectiveECL-TA-20-012-V01.00

TA tests on Andrew CAP MX AC 6/7E/80-
85/17E/19/23/25T

3.4 AUXILIARY EQUIPMENT

For the purposes of this test report, auxiliary equipment is defined as equipment which is used temporarily to enable operational and control features especially used for the tests of the EUT which is not used during normal operation or equipment that is used during the tests in combination with the EUT but is not subject of this test report. It is necessary to configure the system in a typical fashion, as a customer would normally use it. But nevertheless Auxiliary Equipment can influence the test results.

Device	Details (Manufacturer; Type; S/N)	Description
AUX1	Commscope/General Electric; ION-E PSU Shelf, AC; DM77662	Rack in Conjunction with AUX 2
AUX2	Commscope/General Electric; Power Supply Unit; LBGPE17KZ39047532	Power Supply
AUX3	Commscope; ION-E WCS-2; SZAEAJ1952A0032	Subrack in Conjunction with AUX 4, 5,6, 7 and 8
AUX4	Commscope; ION-E OPT; SZBEAD1951A0011	Optical Card
AUX5	Commscope; ION-E SUI; SZBEAC1746A0015	LAN System Interface
AUX6	Commscope; ION-E RFD; SZBEAP1920A0057	RF Card
AUX7	Commscope; ION-E RFD; SZBEAP1924A0023	RF Card
AUX 8	Commscope; ION-E RFD; SZBEAP1946A0003	RF Card



EffectiveECL-TA-20-012-V01.00

TA tests on Andrew CAP MX AC 6/7E/80-85/17E/19/23/25T

3.5 EUT SETUPS

This chapter describes the combination of EUTs and equipment used for testing. The rationale for selecting the EUTs, ancillary and auxiliary equipment and interconnecting cables, is to test a representative configuration meeting the requirements of the referenced standards.

Setup	Combination of EUTs	Description and Rationale
		Setup for all tests

OPERATING MODES

This chapter describes the operating modes of the EUT used for testing.

3.5.1 TEST CHANNELS

Band	Direction	Lower Frequency Band Edge [MHz]	Upper Frequency Band Edge [MHz]	Center Frequency [MHz]	Port
66, AWS 1700E high	Downlink	2180.00	2200.00	2190.00	Donor

3.5.2 AUTOMATIC GAIN CONTROL LEVELS

AGC Levels							
Band	Direction	Signal Type	AGC Start Pin [dBm]	AGC Start Pin -0.3 dB [dBm]	AGC Start Pin +3 dB [dBm]	Frequency [MHz]	Frequency
66, AWS 1700E high	Downlink	Narrowband	0.8	0.5	3.8	2190.00	Mid
66, AWS 1700E high	Downlink	Wideband	1.2	0.9	4.2	2190.00	
66, AWS 1700E high	Downlink	Narrowband	1.8	1.5	4.8	2180.20	Low
66, AWS 1700E high	Downlink	Wideband	1.6	1.3	4.6	2182.50	
66, AWS 1700E high	Downlink	Narrowband	0.8	0.5	3.8	2199.80	High
66, AWS 1700E high	Downlink	Wideband	1.0	0.7	4.0	2197.50	
66, AWS 1700E high	Downlink	Narrowband	0.8	0.5	3.8	2192.37	Max. Power
66, AWS 1700E high	Downlink	Wideband	1.2	0.9	4.2	2192.37	

Remark:

If the measured frequency f_0 for the max power has a too low distance to the band edges, because in the tests modulated signals must be used: The next possible frequency to the according band edge is used.

For example for minimum distances to the band edges:

GSM-Signal (narrowband): 0.2 MHz

AWGN-signal (wideband): 2.5 MHz



BUREAU
VERITAS

EfectiveECL-TA-20-012-V01.00

TA tests on Andrew CAP MX AC 6/7E/80-
85/17E/19/23/25T

3.6 PRODUCT LABELLING

3.6.1 FCC ID LABEL

Please refer to the documentation of the applicant.

3.6.2 LOCATION OF THE LABEL ON THE EUT

Please refer to the documentation of the applicant.

EffectiveECL-TA-20-012-V01.00

TA tests on Andrew CAP MX AC 6/7E/80-85/17E/19/23/25T

4 TEST RESULTS

4.1 EFFECTIVE RADIATED POWER, MEAN OUTPUT POWER AND ZONE ENHANCER GAIN

Standard FCC PART 24, § 27.50

The test was performed according to:
ANSI C63.26, KDB 935210 D05 v01r04: 3.5

Test date: 2020-10-22

Environmental conditions: 23 ° C; 42 % r. F

Test engineer: Thomas Gerngroß

4.1.1 TEST DESCRIPTION

This test case is intended to demonstrate compliance to the signal booster power and gain limits and requirements for industrial signal boosters per FCC § 27.50

The EUT was connected to the test setup according to the following diagram:

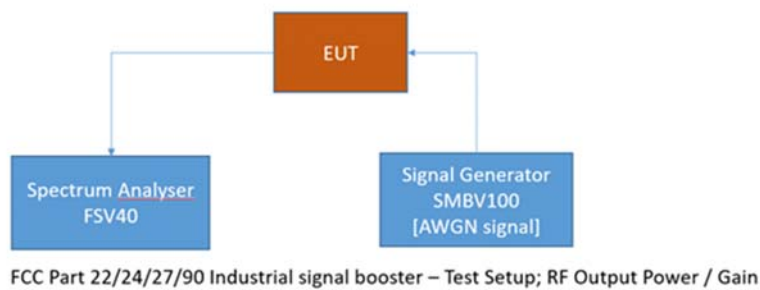

The attenuation of the measuring and stimulus path are known for each measured frequency and are considered.

The Spectrum Analyser settings can be directly found in the measurement diagrams.



BUREAU
VERITAS

EffectiveECL-TA-20-012-V01.00

TA tests on Andrew CAP MX AC 6/7E/80-85/17E/19/23/25T

Band: AWS 1700E high; Frequency: 2.5452 GHz; Band Edge: f0; Mod: AWGN; Output Power 0.3 dB < AGC

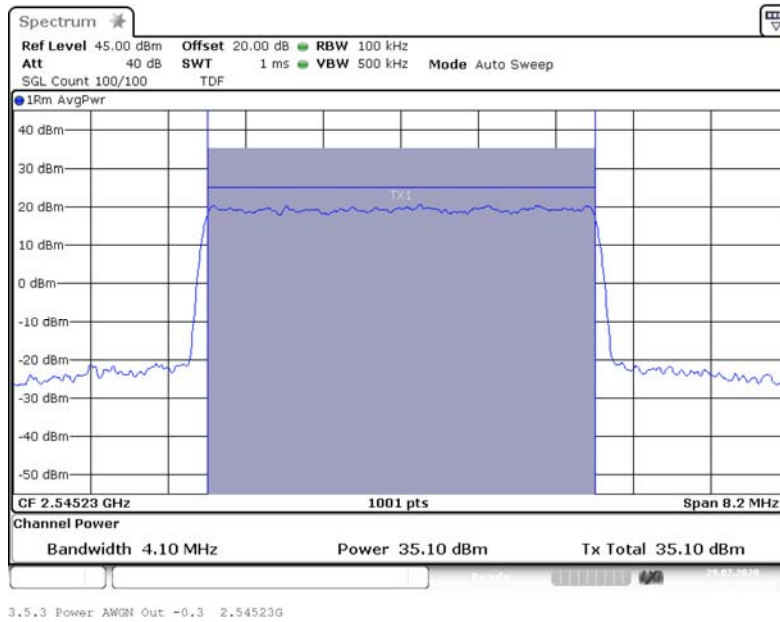

Band: AWS 1700E high; Frequency: 2.5452 GHz; Band Edge: f0; Mod: AWGN; Output Power 3 dB > AGC

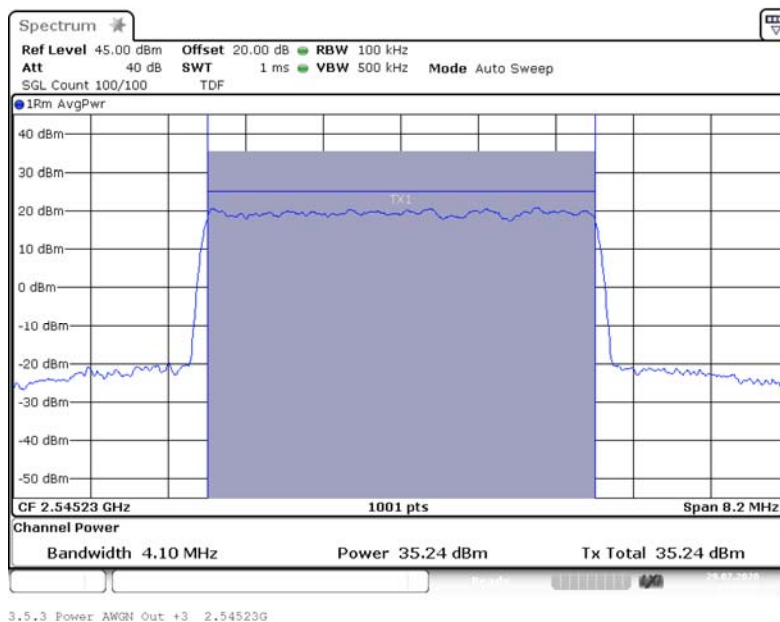



BUREAU
VERITAS

EffectiveECL-TA-20-012-V01.00

TA tests on Andrew CAP MX AC 6/7E/80-85/17E/19/23/25T

Band: AWS 1700E high; Frequency: 2.5452 GHz; Band Edge: f0; Mod: GSM; Output Power 0.3 dB < AGC



Band: AWS 1700E high; Frequency: 2.5452 GHz; Band Edge: f0; Mod: GSM; Output Power 3 dB > AGC





Effective ECL-TA-20-012-V01.00

TA tests on Andrew CAP MX AC 6/7E/80-85/17E/19/23/25T

4.1.2 TEST REQUIREMENTS/LIMITS: ABSTRACTS FROM STANDARDS

Part 27; Miscellaneous Wireless Communication Services

Subpart C – Technical standards

§ 27.50

Abstract § 27.50 from FCC:

(d) The following power and antenna height requirements apply to stations transmitting in the 1695-1710 MHz, 1710-1755 MHz, 1755-1780 MHz, 1915-1920 MHz, 1995-2000 MHz, 2000-2020 MHz, 2110-2155 MHz, 2155-2180 MHz and 2180-2200 MHz bands:

(1) The power of each fixed or base station transmitting in the 1995-2000 MHz, 2110-2155 MHz, 2155-2180 MHz or 2180-2200 MHz band and located in any county with population density of 100 or fewer persons per square mile, based upon the most recently available population statistics from the Bureau of the Census, is limited to:

(i) An equivalent isotropically radiated power (EIRP) of 3280 watts when transmitting with an emission bandwidth of 1 MHz or less;

(ii) An EIRP of 3280 watts/MHz when transmitting with an emission bandwidth greater than 1 MHz.

(2) The power of each fixed or base station transmitting in the 1995-2000 MHz, the 2110-2155 MHz 2155-2180 MHz band, or 2180-2200 MHz band and situated in any geographic location other than that described in paragraph (d)(1) of this section is limited to:

(i) An equivalent isotropically radiated power (EIRP) of 1640 watts when transmitting with an emission bandwidth of 1 MHz or less;

(ii) An EIRP of 1640 watts/MHz when transmitting with an emission bandwidth greater than 1 MHz.

4.1.3 TEST PROTOCOL

Band 66 AWS 1700E high, downlink,							
Signal Type	Input Power	Frequency [MHz]	Input Power [dBm]	Maximum Average Output Power [dBm]	Limit Average Output Power [dBm]	Margin to Limit [dB]	Gain [dB]
Wideband	0.3 dB < AGC	2192.37	-0.1	33.1	62.1	29.0	33.2
Wideband	3 dB > AGC	2192.37	3.2	32.8	62.1	29.4	29.6
Narrowband	0.3 dB < AGC	2192.37	-0.3	33.0	62.1	29.1	33.3
Narrowband	3 dB > AGC	2192.37	3.0	32.8	62.1	29.4	29.8

Remarks: Please see next sub-clause for the measurement plot.



BUREAU
VERITAS

EffectiveECL-TA-20-012-V01.00

TA tests on Andrew CAP MX AC 6/7E/80-85/17E/19/23/25T

4.1.4 MEASUREMENT PLOT

Band: AWS 1700E high; Frequency: 2.19237 GHz; Band Edge: f0; Mod: AWGN; Output Power 0.3 dB < AGC

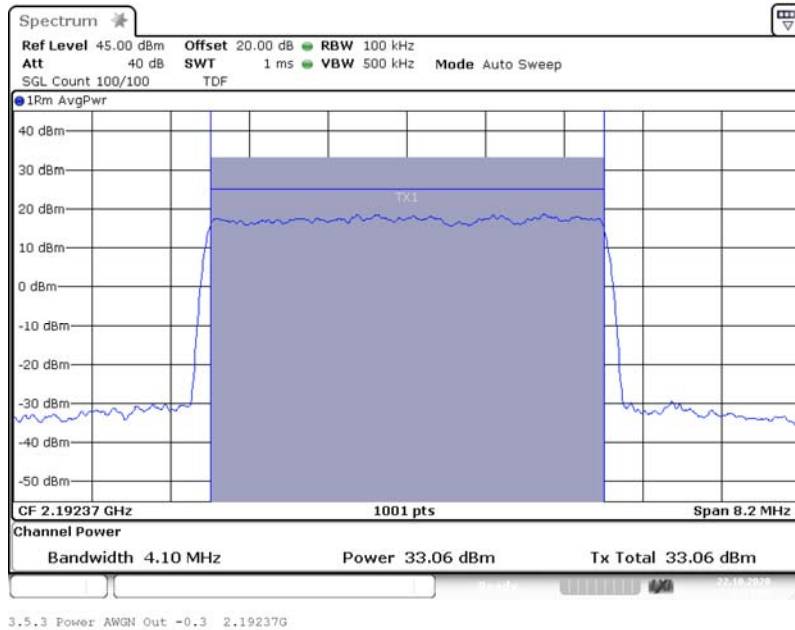

Band: AWS 1700E high; Frequency: 2.19237 GHz; Band Edge: f0; Mod: AWGN; Output Power 3 dB > AGC

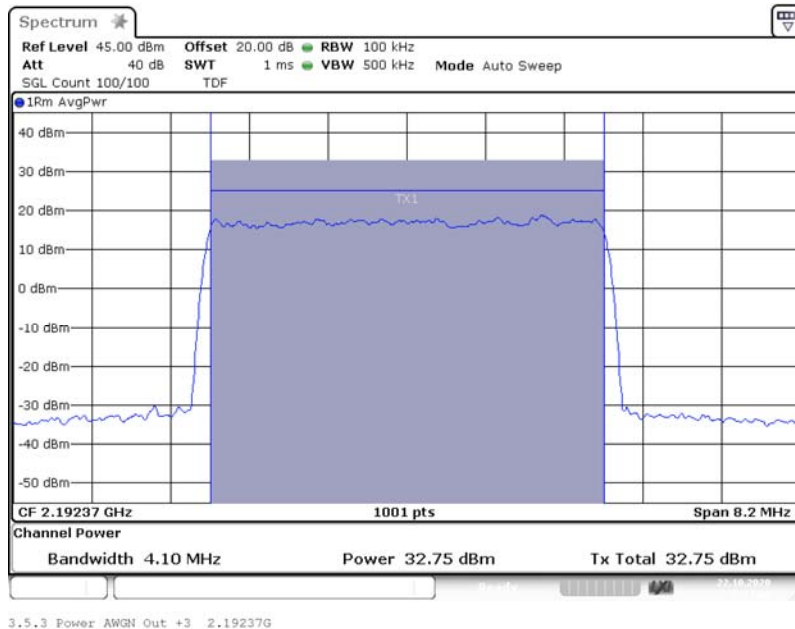



**BUREAU
VERITAS**

EffectiveECL-TA-20-012-V01.00

TA tests on Andrew CAP MX AC 6/7E/80-85/17E/19/23/25T

Band: AWS 1700E high; Frequency: 2.1937 Band: AWS 1700E high; Frequency: 2.1924 GHz; Band Edge: f0; Mod: GSM; Output Power 0.3 dB < AGC



Band: AWS 1700E high; Frequency: 2.19237 GHz; Band Edge: f0; Mod: GSM; Output Power 3 dB > AGC



4.1.5 TEST EQUIPMENT USED

- Conducted



Effective ECL-TA-20-012-V01.00

TA tests on Andrew CAP MX AC 6/7E/80-
85/17E/19/23/25T

4.2 PEAK TO AVERAGE RATIO

Standard FCC PART 24, § 27.50

The test was performed according to:
ANSI C63.26

Test date: 2020-10-22

Environmental conditions: 23 ° C; 42 % r. F.

Test engineer: Thomas Gerngroß

4.2.1 TEST DESCRIPTION

This test case is intended to demonstrate compliance to the signal booster power and gain limits and requirements for industrial signal boosters per FCC § 27.50.

The EUT was connected to the test setup according to the following diagram:

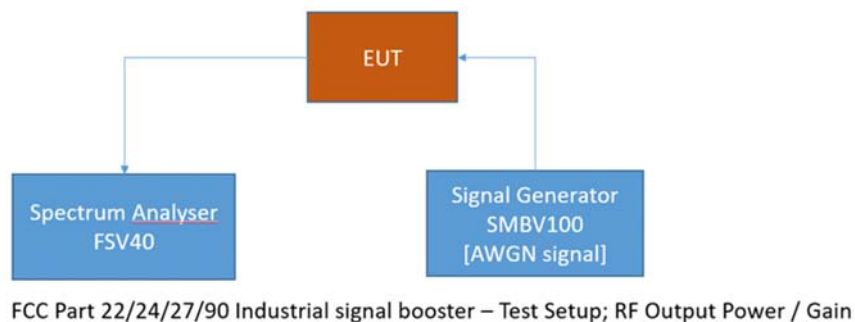

The attenuation of the measuring and stimulus path are known for each measured frequency and are considered.

The Spectrum Analyzer settings can be directly found in the measurement diagrams.



Effective ECL-TA-20-012-V01.00

TA tests on Andrew CAP MX AC 6/7E/80-85/17E/19/23/25T

4.2.2 TEST REQUIREMENTS/LIMITS

Part 27; Miscellaneous Wireless Communication Services

Subpart C – Technical standards

§ 27.50

Abstract § 27.50 from FCC:

(d) The following power and antenna height requirements apply to stations transmitting in the 1695-1710 MHz, 1710-1755 MHz, 1755-1780 MHz, 1915-1920 MHz, 1995-2000 MHz, 2000-2020 MHz, 2110-2155 MHz, 2155-2180 MHz and 2180-2200 MHz bands:

(5) Equipment employed must be authorized in accordance with the provisions of §24.51. Power measurements for transmissions by stations authorized under this section may be made either in accordance with a Commission-approved average power technique or in compliance with paragraph (d)(6) of this section. In measuring transmissions in this band using an average power technique, the peak-to-average ratio (PAR) of the transmission may not exceed 13 dB.

4.2.3 TEST PROTOCOL

Band 66 AWS 1700E high, downlink						
Signal Type	Input Power	Frequency [MHz]	Input Power [dBm]	PAPR [dB]	Limit PAPR [dB]	Margin to Fictive Limit [dB]
Wideband	0.3 dB < AGC	2190.00	0.9	8.8	13.0	4.2
Wideband	3 dB > AGC	2190.00	4.2	8.8	13.0	4.2
Narrowband	0.3 dB < AGC	2192.37	0.5	0.2	13.0	12.8
Narrowband	3 dB > AGC	2192.37	3.8	0.1	13.0	12.9

Remark: Please see next sub-clause for the measurement plot.



BUREAU VERITAS

EffectiveECL-TA-20-012-V01.00

TA tests on Andrew CAP MX AC 6/7E/80-85/17E/19/23/25T

4.2.4 MEASUREMENT PLOT (SHOWING THE HIGHEST VALUE, "WORST CASE")

Band: AWS 1700E high; Frequency: 2.1900 GHz; Band Edge: mid; Mod: AWGN; PAPR 0.3 dB < AGC

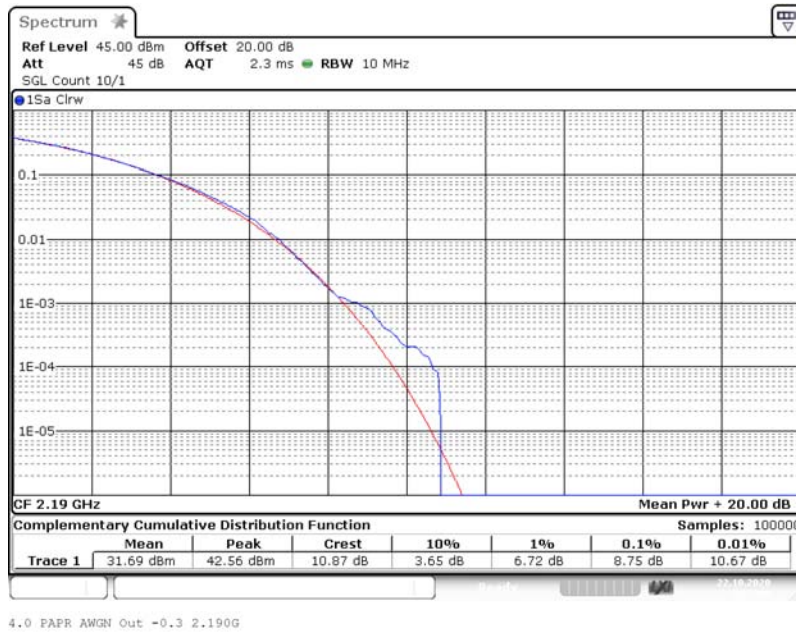

Band: AWS 1700E high; Frequency: 2.1900 GHz; Band Edge: mid; Mod: AWGN; PAPR 3 dB > AGC

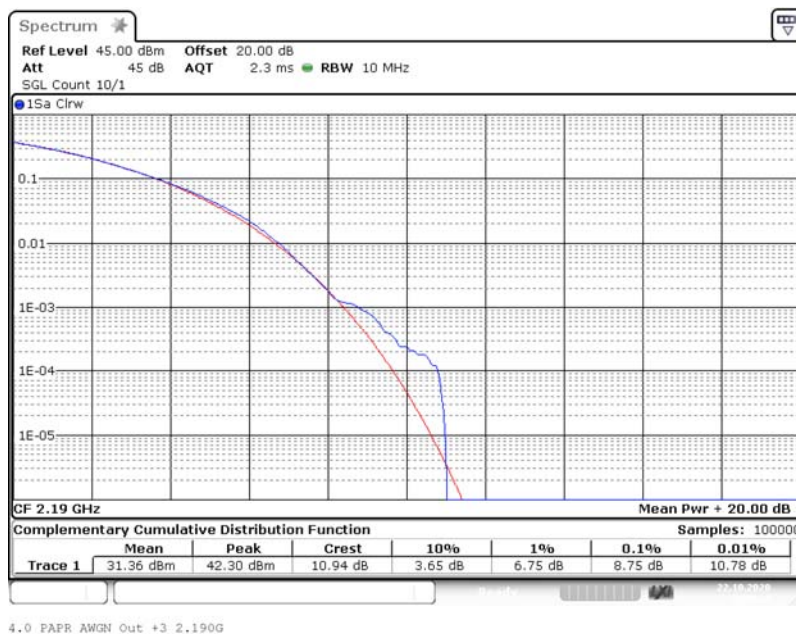



BUREAU VERITAS

EffectiveECL-TA-20-012-V01.00

TA tests on Andrew CAP MX AC 6/7E/80-85/17E/19/23/25T

Band: AWS 1700E high; Frequency: 2.19237 GHz; Band Edge: f0; Mod: GSM; PAPR 0.3 dB < AGC



4.0 PAPR GSM Out -0.3 2.192G

Band: AWS 1700E high; Frequency: 2.19237 GHz; Band Edge: f0; Mod: GSM; PAPR 3 dB > AGC

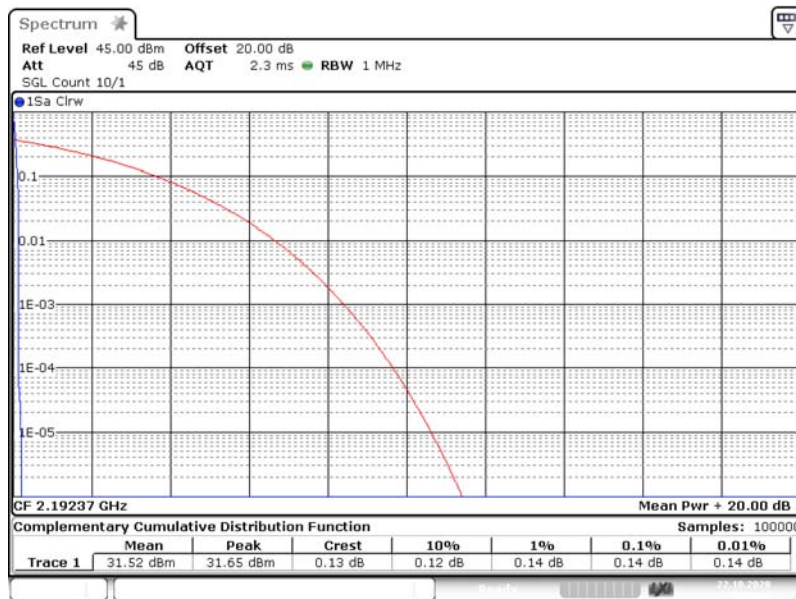

4.0 PAPR GSM Out +3 2.192G

4.2.5 TEST EQUIPMENT USED

- Conducted



BUREAU
VERITAS

Effective ECL-TA-20-012-V01.00

TA tests on Andrew CAP MX AC 6/7E/80-85/17E/19/23/25T

4.3 OCCUPIED BANDWIDTH/INPUT-VERSUS-OUTPUT SPECTRUM

Standard FCC Part 2.1049; Occupied Bandwidth

The test was performed according to:

ANSI C63.26, KDB 935210 D05 v01r04: 3.4

Test date: 2020-10-22

Environmental conditions: 23 ° C; 42 % r. F.

Test engineer: Thomas Gerngroß

4.3.1 TEST DESCRIPTION

This test case is intended to demonstrate compliance to the applicable conducted spurious emission limits per FCC § 2.1049.

The EUT was connected to the test setups according to the following diagram:

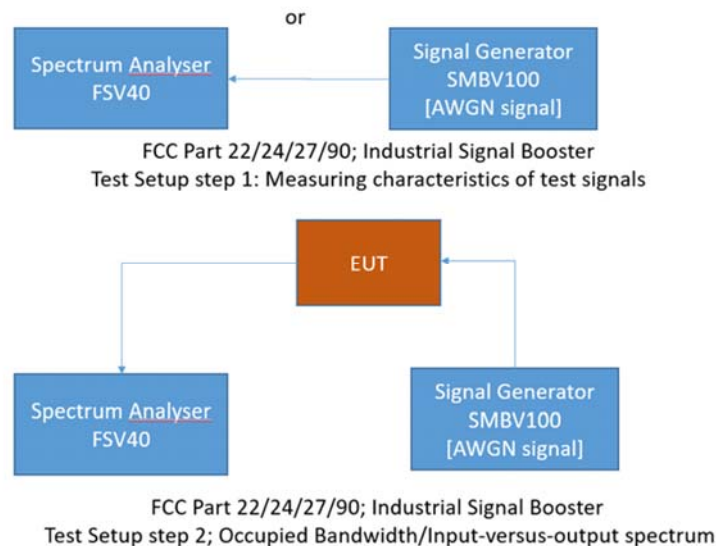

The attenuation of the measuring and stimulus path are known for each measured frequency and are considered.

The Spectrum Analyser settings can be directly found in the measurement diagrams.



Effective ECL-TA-20-012-V01.00

TA tests on Andrew CAP MX AC 6/7E/80-85/17E/19/23/25T

4.3.2 TEST REQUIREMENTS/LIMITS

Abstract § 2.1049 from FCC:

FCC Part 2.1049; Occupied Bandwidth:

The occupied bandwidth, that is the frequency bandwidth such that, below its lower and above its upper frequency limits, the mean powers radiated are each equal to 0.3 percent of the total mean power radiated by a given emission shall be measured under the following conditions as applicable:

(h) Transmitters employing digital modulation techniques—when modulated by an input signal such that its amplitude and symbol rate represent the maximum rated conditions under which the equipment will be operated. The signal shall be applied through any filter networks, pseudo-random generators or other devices required in normal service. Additionally, the occupied bandwidth shall be shown for operation with any devices used for modifying the spectrum when such devices are optional at the discretion of the user.

(i) Transmitters designed for other types of modulation—when modulated by an appropriate signal of sufficient amplitude to be representative of the type of service in which used. A description of the input signal should be supplied.

4.3.3 TEST PROTOCOL

Band 66 AWS 1700E high, downlink							
Signal Type	Input Power	Signal Frequency [MHz]	Occupied Bandwidth SG [kHz]	Occupied Bandwidth Booster [kHz]	Delta Occupied Bandwidth [kHz]	Limit Delta Occupied Bandwidth [kHz]	Margin to Limit [kHz]
Wideband	0.3 dB < AGC	2190.00	4334.1	4335.3	1.2	205.0	203.8
Wideband	3 dB > AGC	2190.00	4334.1	4335.3	1.2	205.0	203.8
Narrowband	0.3 dB < AGC	2190.00	315.0	320.5	5.5	10.0	4.5
Narrowband	3 dB > AGC	2190.00	315.5	316.1	0.6	10.0	9.4

Remark: Please see next sub-clause for the measurement plot.



EffectiveECL-TA-20-012-V01.00

TA tests on Andrew CAP MX AC 6/7E/80-85/17E/19/23/25T

4.3.4 MEASUREMENT PLOT

Band: AWS 1700E high; Frequency: 2.1900 GHz; Band Edge: mid; Mod: AWGN; Input OCBw 0.3 dB < AGC

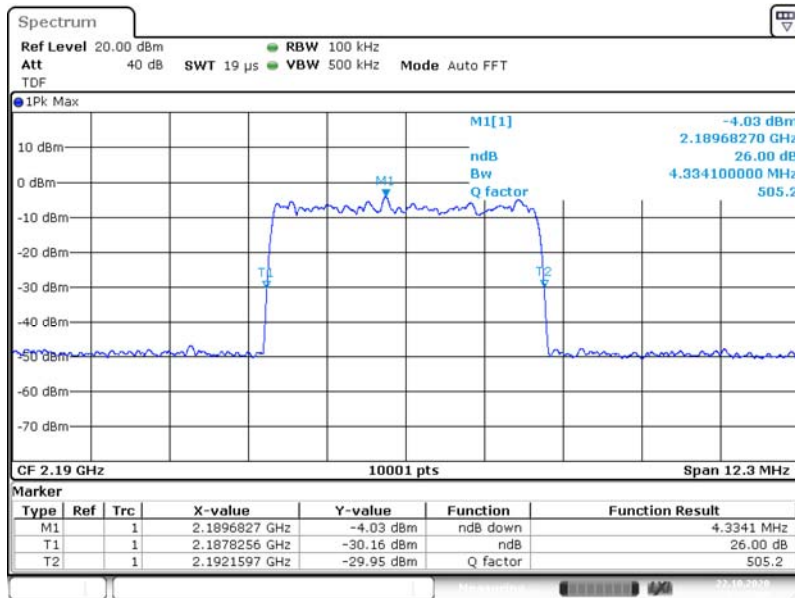

Input Signal

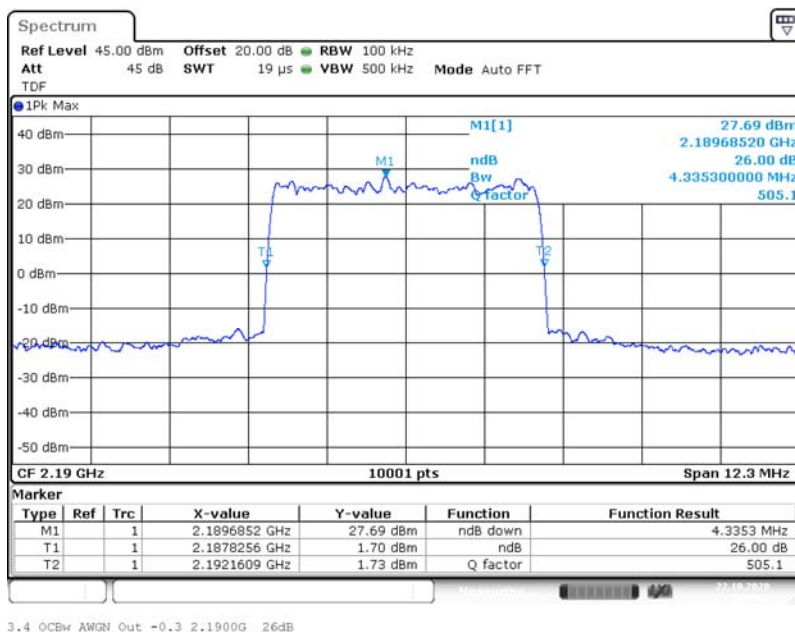

Output Signal



BUREAU
VERITAS

EffectiveECL-TA-20-012-V01.00

TA tests on Andrew CAP MX AC 6/7E/80-85/17E/19/23/25T

Band: AWS 1700E high; Frequency: 2.1900 GHz; Band Edge: mid; Mod: AWGN; Input OCBw 3 dB > AGC

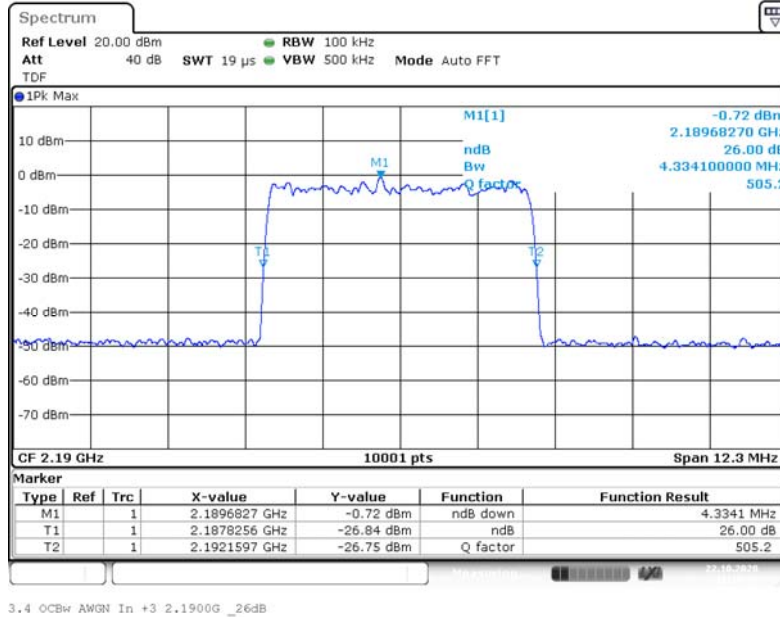

Input Signal

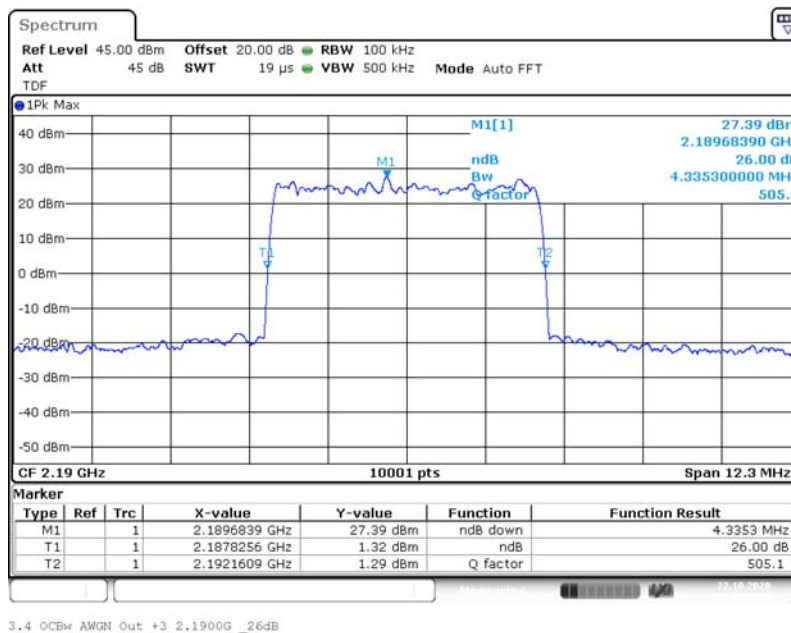

Output Signal



BUREAU VERITAS

EfectiveECL-TA-20-012-V01.00

TA tests on Andrew CAP MX AC 6/7E/80-85/17E/19/23/25T

Band: AWS 1700E high; Frequency: 2.1900 GHz; Band Edge: mid; Mod: GSM; Input OCBw 0.3 dB < AGC

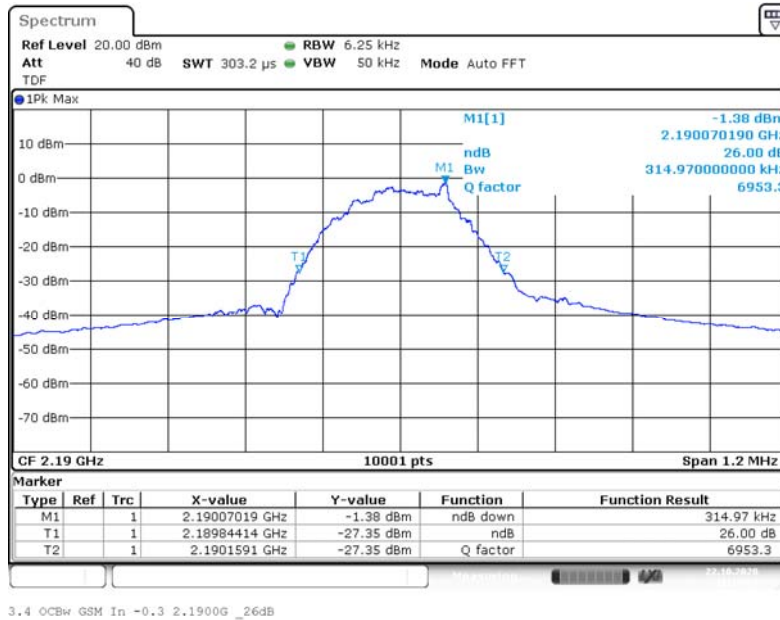

Input Signal

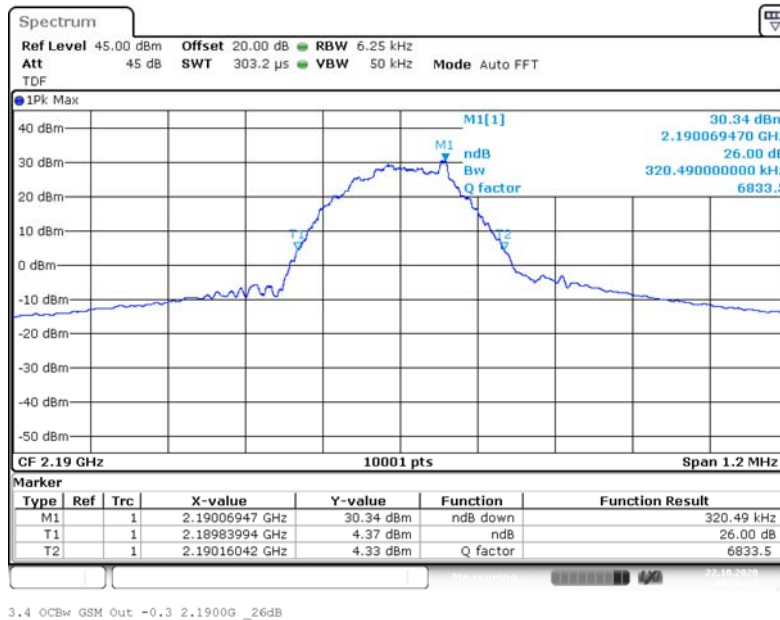

Output Signal



BUREAU VERITAS

EffectiveECL-TA-20-012-V01.00

TA tests on Andrew CAP MX AC 6/7E/80-85/17E/19/23/25T

Band: AWS 1700E high; Frequency: 2.1900 GHz; Band Edge: mid; Mod: GSM; Input OCBw 3 dB > AGC

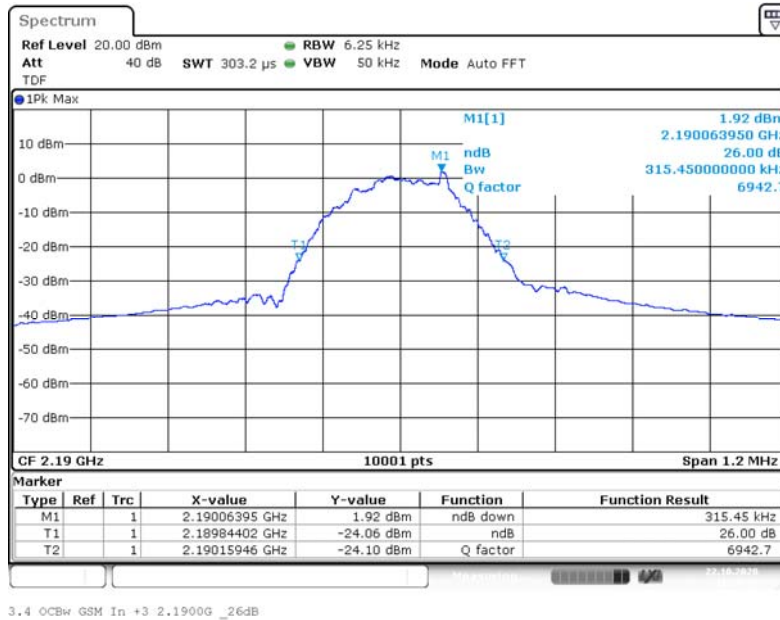

Input Signal

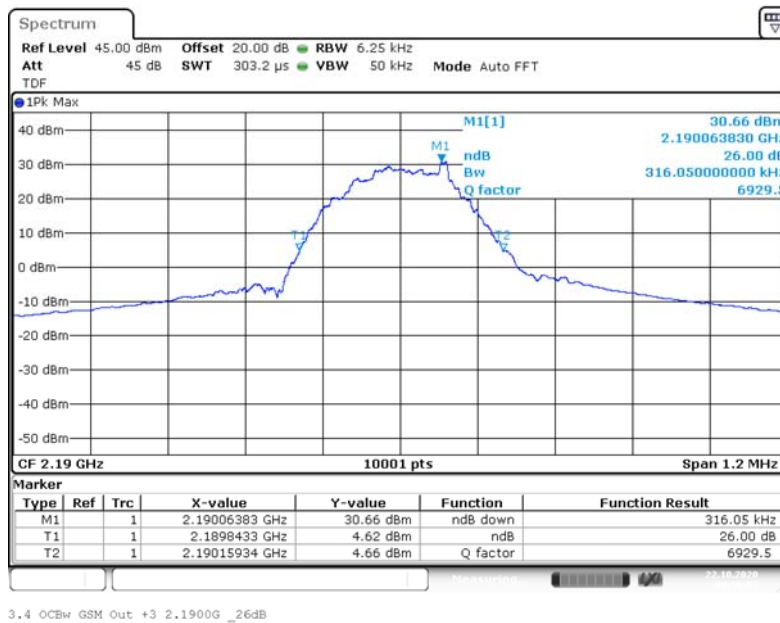

4.3.5 TEST EQUIPMENT USED

- Conducted



**BUREAU
VERITAS**

Effective ECL-TA-20-012-V01.00

TA tests on Andrew CAP MX AC 6/7E/80-
85/17E/19/23/25T

4.4 CONDUCTED SPURIOUS EMISSIONS AT ANTENNA TERMINALS

Standard FCC Part § 2.1051, § 27.53

The test was performed according to:
ANSI C63.26, KDB 935210 D05 v01r04: 3.6

Test date: 2020-09-10

Environmental conditions: 25 ° C; 42 % r. F.

Test engineer: Thomas Hufnagel

4.4.1 TEST DESCRIPTION

This test case is intended to demonstrate compliance to the signal booster power and gain limits and requirements for industrial signal boosters per FCC § 2.1051 and FCC § 27.53

The EUT was connected to the test setup according to the following diagram:

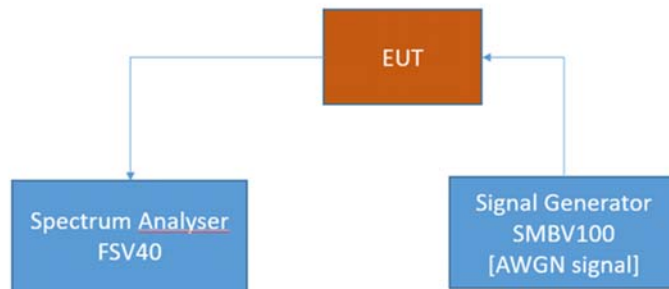

FCC Part 22/24/27/90 Industrial signal booster – Test Setup; RF Output Power / Gain

The attenuation of the measuring and stimulus path are known for each measured frequency and are considered.

The Spectrum Analyzer settings can be directly found in the measurement diagrams.



**BUREAU
VERITAS**

Effective ECL-TA-20-012-V01.00

TA tests on Andrew CAP MX AC 6/7E/80-
85/17E/19/23/25T

4.4.2 TEST REQUIREMENTS/LIMITS

Abstract § 2.1051 from FCC:

FCC Part 2.1051; Measurement required: Spurious emissions at antenna terminal:

The radio frequency voltage or powers generated within the equipment and appearing on a spurious frequency shall be checked at the equipment output terminals when properly loaded with a suitable artificial antenna. Curves or equivalent data shall show the magnitude of each harmonic and other spurious emission that can be detected when the equipment is operated under the conditions specified in § 2.1049 as appropriate. The magnitude of spurious emissions which are attenuated more than 20 dB below the permissible value need not be specified.

Part 27; Miscellaneous Wireless Communication Services

Subpart C – Technical standards

§27.53 – Emission limits

Abstract § 27.53 FCC:

(h) AWS emission limits—(1) General protection levels. Except as otherwise specified below, for operations in the 1695-1710 MHz, 1710-1755 MHz, 1755-1780 MHz, 1915-1920 MHz, 1995-2000 MHz, 2000-2020 MHz, 2110-2155 MHz, 2155-2180 MHz, and 2180-2200 bands, the power of any emission outside a licensee's frequency block shall be attenuated below the transmitter power (P) in watts by at least $43 + 10 \log_{10} (P)$ dB.



EffectiveECL-TA-20-012-V01.00

TA tests on Andrew CAP MX AC 6/7E/80-85/17E/19/23/25T

4.4.3 TEST PROTOCOL

Band 66, AWS 1700E high, downlink							
Test Frequency	Signal Type	Spurious Freq. [MHz]	Spurious Level [dBm]	Detector	RBW [kHz]	Limit [dBm]	Margin to Limit [dB]
low	Wideband	0.0097987	-60.4	RMS	1	-33	27.4
low	Wideband	0.1124896	-54.5	RMS	10	-23	31.5
low	Wideband	120.9653	-45.9	RMS	100	-13	32.9
low	Wideband	850.3996	-35.2	RMS	1000	-13	22.2
low	Wideband	1745.4	-36.6	RMS	1000	-13	23.6
low	Wideband	2178.8	-37.7	RMS	100	-13	24.7
low	Wideband	2206.4	-45.9	RMS	100	-13	32.9
low	Wideband	6859.5	-31.1	RMS	1000	-13	18.1
low	Wideband	19606.8	-30.5	RMS	1000	-13	17.5
low	Wideband	20341.2	-30.0	RMS	1000	-13	17.0
mid	Wideband	0.0090205	-60.9	RMS	1	-33	27.9
mid	Wideband	0.0524996	-54.0	RMS	10	-23	31.0
mid	Wideband	119.7155	-45.4	RMS	100	-13	32.4
mid	Wideband	851.8981	-34.4	RMS	1000	-13	21.4
mid	Wideband	1815.9	-36.7	RMS	1000	-13	23.7
mid	Wideband	2178.3	-46.0	RMS	100	-13	33.0
mid	Wideband	2202.7	-45.6	RMS	100	-13	32.6
mid	Wideband	6835.5	-31.0	RMS	1000	-13	18.0
mid	Wideband	19558.8	-30.4	RMS	1000	-13	17.4
mid	Wideband	20294.7	-30.0	RMS	1000	-13	17.0
high	Wideband	0.0112323	-61.6	RMS	1	-33	28.6
high	Wideband	0.1124896	-54.5	RMS	10	-23	31.5
high	Wideband	68.8709	-45.6	RMS	100	-13	32.6
high	Wideband	856.8931	-35.3	RMS	1000	-13	22.3
high	Wideband	2144.8	-36.5	RMS	1000	-13	23.5
high	Wideband	2171.0	-46.2	RMS	100	-13	33.2
high	Wideband	2201.1	-39.0	RMS	100	-13	26.0
high	Wideband	6878.0	-30.7	RMS	1000	-13	17.7
high	Wideband	19585.3	-30.5	RMS	1000	-13	17.5
high	Wideband	20303.2	-29.9	RMS	1000	-13	16.9



EffectiveECL-TA-20-012-V01.00

TA tests on Andrew CAP MX AC 6/7E/80-85/17E/19/23/25T

Band 66, AWS 1700E high, downlink							
Test Frequency	Signal Type	Spurious Freq. [MHz]	Spurious Level [dBm]	Detector	RBW [kHz]	Limit [dBm]	Margin to Limit [dB]
low	Narrowband	0.0102493	-60.0	RMS	1	-33	27.0
low	Narrowband	0.0524996	-55.0	RMS	10	-23	32.0
low	Narrowband	68.7209	-45.6	RMS	100	-13	32.6
low	Narrowband	851.3986	-33.9	RMS	1000	-13	20.9
low	Narrowband	1769.9	-36.5	RMS	1000	-13	23.5
low	Narrowband	2171.3	-46.5	RMS	100	-13	33.5
low	Narrowband	2203.1	-46.2	RMS	100	-13	33.2
low	Narrowband	6818.5	-30.1	RMS	1000	-13	17.1
low	Narrowband	19549.3	-29.9	RMS	1000	-13	16.9
low	Narrowband	20363.7	-30.0	RMS	1000	-13	17.0
mid	Narrowband	0.0090205	-61.0	RMS	1	-33	28.0
mid	Narrowband	0.1574821	-55.3	RMS	10	-23	32.3
mid	Narrowband	121.5153	-45.6	RMS	100	-13	32.6
mid	Narrowband	853.8961	-34.0	RMS	1000	-13	21.0
mid	Narrowband	2146.8	-36.7	RMS	1000	-13	23.7
mid	Narrowband	2172.6	-45.8	RMS	100	-13	32.8
mid	Narrowband	2202.5	-45.2	RMS	100	-13	32.2
mid	Narrowband	6988.4	-31.1	RMS	1000	-13	18.1
mid	Narrowband	19560.8	-30.5	RMS	1000	-13	17.5
mid	Narrowband	20307.2	-30.0	RMS	1000	-13	17.0
high	Narrowband	0.0090205	-60.2	RMS	1	-33	27.2
high	Narrowband	0.0674971	-55.7	RMS	10	-23	32.7
high	Narrowband	121.1653	-45.3	RMS	100	-13	32.3
high	Narrowband	711.039	-34.9	RMS	1000	-13	21.9
high	Narrowband	2077.3	-36.9	RMS	1000	-13	23.9
high	Narrowband	2172.6	-45.6	RMS	100	-13	32.6
high	Narrowband	2171.2	-46.7	RMS	100	-13	33.7
high	Narrowband	6869.0	-31.0	RMS	1000	-13	18.0
high	Narrowband	19977.8	-30.7	RMS	1000	-13	17.7
high	Narrowband	20337.7	-30.0	RMS	1000	-13	17.0

Remark: Please see next sub-clause for the measurement plot.



BUREAU
VERITAS

Effective ECL-TA-20-012-V01.00

TA tests on Andrew CAP MX AC 6/7E/80-
85/17E/19/23/25T

General considerations concerning the measurement plots:

The measuring bandwidth of 100 kHz was chosen according to the test requirements except at the band edges: At the band edges reducing of measurement bandwidth was necessary to prevent overlaying the RF-signal over the spurious emissions.

Also outside the downlink frequency band at lower frequencies the measurement bandwidths were reduced to have the possibility to record the spurious emissions at these lower frequencies.

At frequencies where measuring bandwidths were reduced also the border lines were reduced according to the given formula:

$$p_{RBW_{reduced}} [dBm] = 10 * \log \left(RBW_{reduced} [kHz] - 100 \text{ kHz} \right) + p_{RBW 100 \text{ kHz}} [dBm]$$

Hereby "p" are the border lines' values.



BUREAU
VERITAS

EffectiveECL-TA-20-012-V01.00

TA tests on Andrew CAP MX AC 6/7E/80-
85/17E/19/23/25T

4.4.4 MEASUREMENT PLOT (SHOWING THE HIGHEST VALUE, "WORST CASE")

Frequency Band = AWS 1700E high, Test Frequency = low, Direction = RF downlink, Signal Type = AWGN

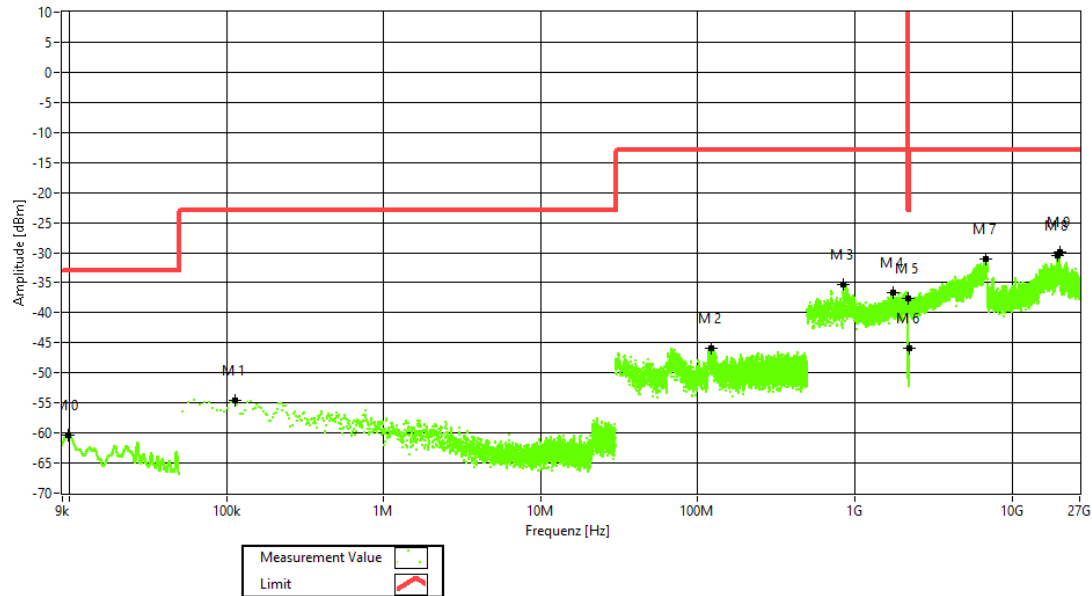

Frequency Band = AWS 1700E high, Test Frequency = mid, Direction = RF downlink, Signal Type = AWGN

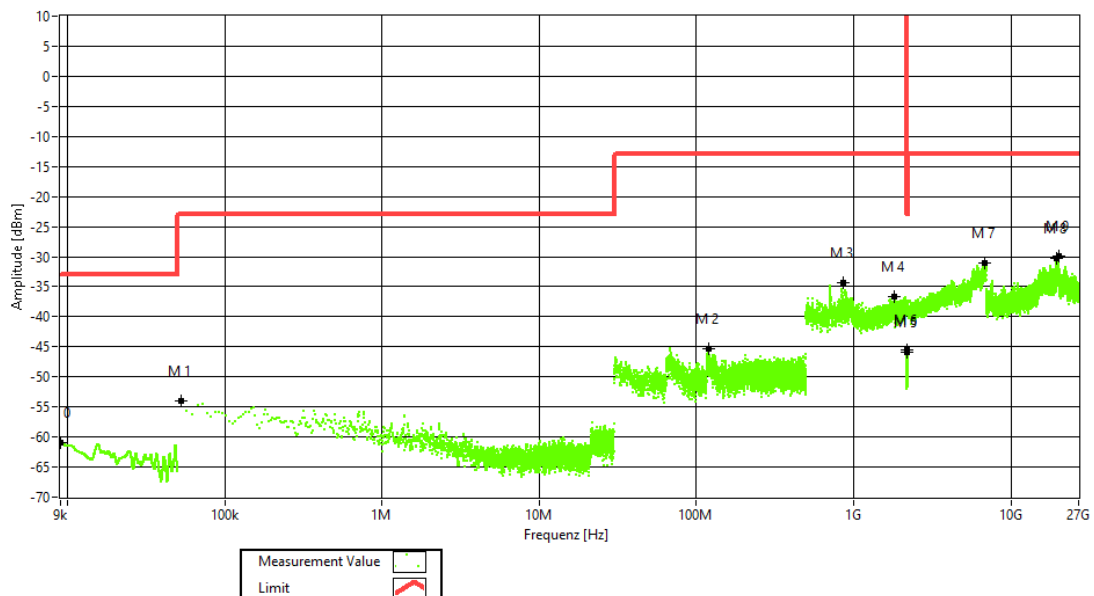



BUREAU
VERITAS

EffectiveECL-TA-20-012-V01.00

TA tests on Andrew CAP MX AC 6/7E/80-
85/17E/19/23/25T

Frequency Band = AWS 1700E high, Test Frequency = high, Direction = RF downlink, Signal
Type = AWGN

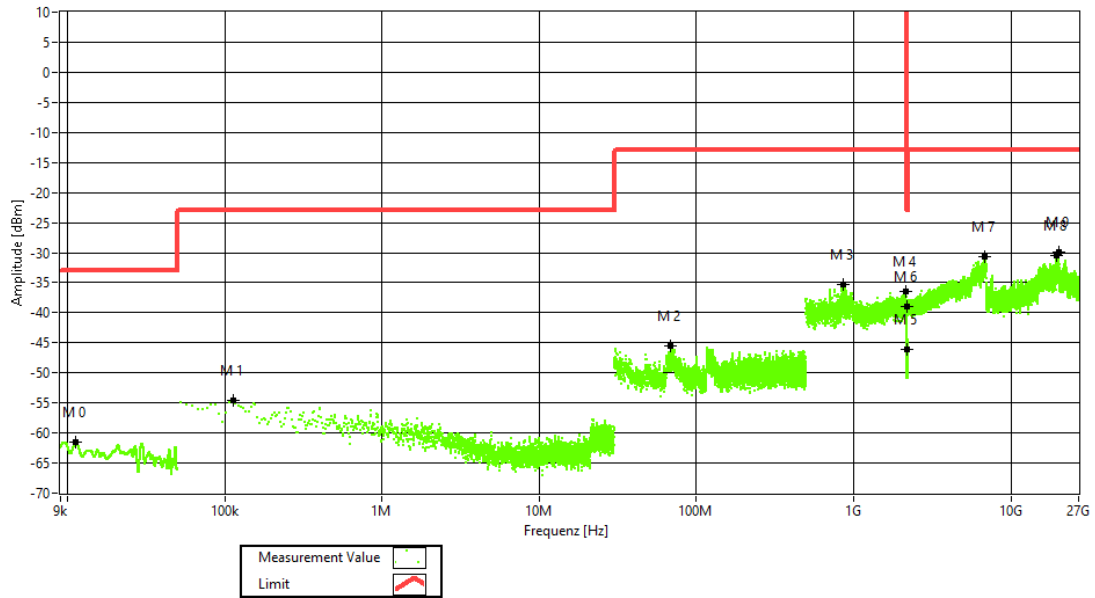



BUREAU
VERITAS

EffectiveECL-TA-20-012-V01.00

TA tests on Andrew CAP MX AC 6/7E/80-
85/17E/19/23/25T

Frequency Band = AWS 1700E high, Test Frequency = low, Direction = RF downlink, Signal Type = GSM

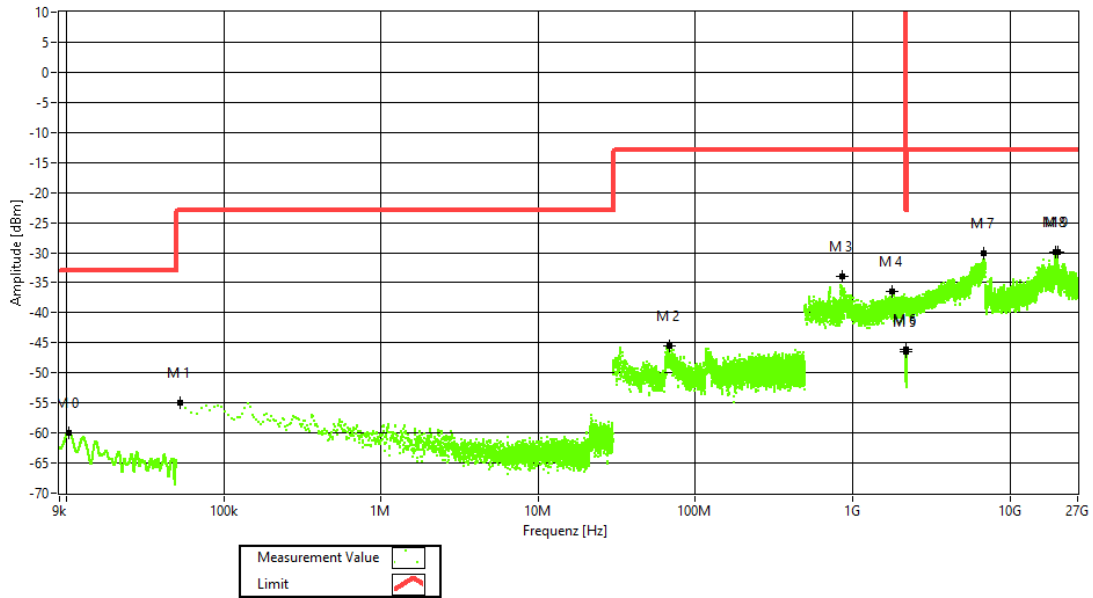

Frequency Band = AWS 1700E high, Test Frequency = mid, Direction = RF downlink, Signal Type = GSM

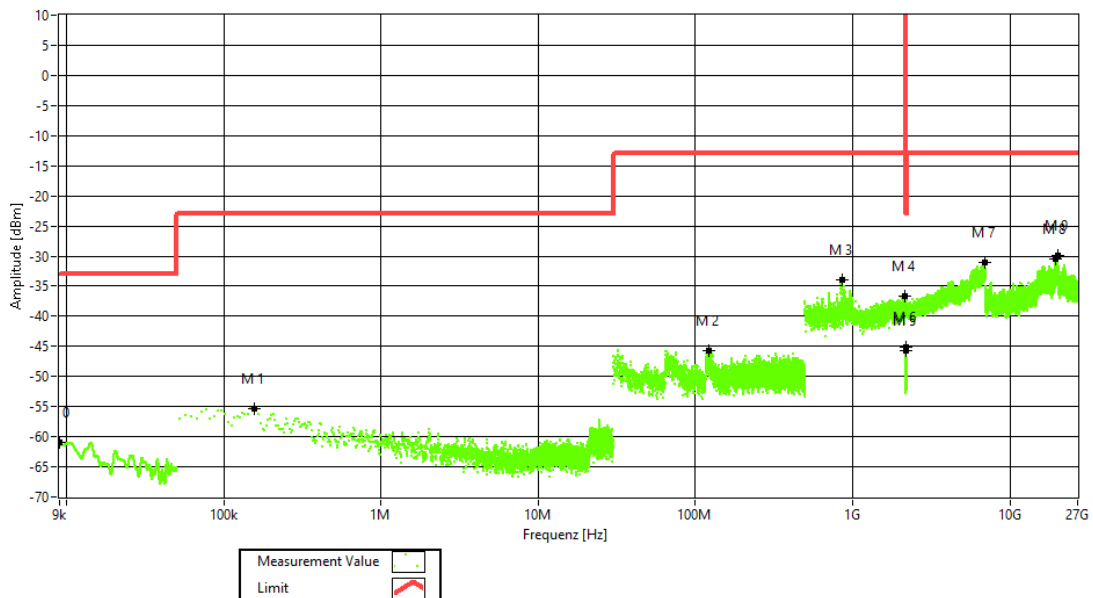



BUREAU
VERITAS

EffectiveECL-TA-20-012-V01.00

TA tests on Andrew CAP MX AC 6/7E/80-
85/17E/19/23/25T

Frequency Band = AWS 1700E high, Test Frequency = high, Direction = RF downlink, Signal
Type = GSM

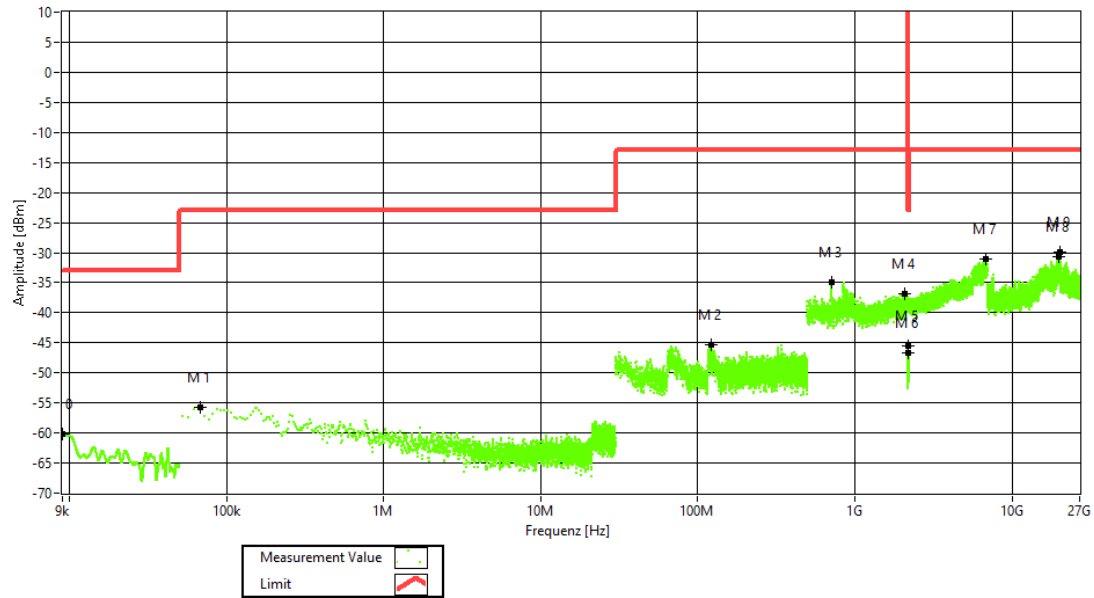

4.4.5 TEST EQUIPMENT USED

- Conducted



Effective ECL-TA-20-012-V01.00

TA tests on Andrew CAP MX AC 6/7E/80-
85/17E/19/23/25T

4.5 OUT-OF-BAND EMISSION LIMITS

Standard FCC Part § 2.1051, § 27.53

The test was performed according to:
ANSI C63.26, KDB 935210 D05 v01r04: 3.6

Test date: 2020-08-20

Environmental conditions: 25 ° C; 42 % r. F.

Test engineer: Thomas Hufnagel

4.5.1 TEST DESCRIPTION

This test case is intended to demonstrate compliance to the out-of-band emission limit for industrial signal boosters. The limits itself come from the applicable rule part for each operating band per FCC § 2.1051 and FCC § 27.53.

The EUT was connected to the test setup according to the following diagram:

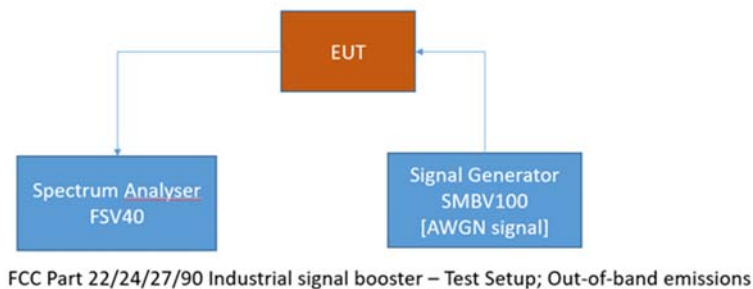

The attenuation of the measuring and stimulus path are known for each measured frequency and are considered.

The Spectrum Analyser settings can be directly found in the measurement diagrams.



Effective ECL-TA-20-012-V01.00

TA tests on Andrew CAP MX AC 6/7E/80-85/17E/19/23/25T

4.5.2 TEST REQUIREMENTS/LIMITS

Abstract § 2.1051 from FCC:

FCC Part 2.1051; Measurement required: Spurious emissions at antenna terminal:

The radio frequency voltage or powers generated within the equipment and appearing on a spurious frequency shall be checked at the equipment output terminals when properly loaded with a suitable artificial antenna. Curves or equivalent data shall show the magnitude of each harmonic and other spurious emission that can be detected when the equipment is operated under the conditions specified in § 2.1049 as appropriate. The magnitude of spurious emissions which are attenuated more than 20 dB below the permissible value need not be specified.

Part 27; Miscellaneous Wireless Communication Services

Subpart C – Technical standards

§27.53 – Emission limits

Abstract § 27.53 FCC:

(h) AWS emission limits—(1) General protection levels. Except as otherwise specified below, for operations in the 1695-1710 MHz, 1710-1755 MHz, 1755-1780 MHz, 1915-1920 MHz, 1995-2000 MHz, 2000-2020 MHz, 2110-2155 MHz, 2155-2180 MHz, and 2180-2200 bands, the power of any emission outside a licensee's frequency block shall be attenuated below the transmitter power (P) in watts by at least $43 + 10 \log_{10} (P)$ dB.



EffectiveECL-TA-20-012-V01.00

TA tests on Andrew CAP MX AC 6/7E/80-85/17E/19/23/25T

4.5.3 TEST PROTOCOL

Band 66 AWS 1700E high, downlink, Number of input signals = 1							
Signal Type	Input Power	Band Edge	Signal Frequency [MHz]	Input Power [dBm]	Maximum Out-of-band Power [dBm]	Limit Out-of-band Power [dBm]	Margin to Limit [dB]
Wideband	-0.3 dB < AGC	upper	2197.50	0.7	-32.9	-13.0	19.9
Wideband	3 dB > AGC	upper	2197.50	4.0	-33.1	-13.0	20.1
Narrowband	-0.3 dB < AGC	upper	2199.80	0.5	-28.9	-13.0	15.9
Narrowband	3 dB > AGC	upper	2199.80	3.8	-29.0	-13.0	16.0
Wideband	-0.3 dB < AGC	lower	2182.50	1.3	-33.1	-13.0	20.1
Wideband	3 dB > AGC	lower	2182.50	4.6	-33.6	-13.0	20.6
Narrowband	-0.3 dB < AGC	lower	2180.20	1.5	-28.3	-13.0	15.3
Narrowband	3 dB > AGC	lower	2180.20	4.8	-29.0	-13.0	16.0

Band 66 AWS 1700E high, downlink, Number of input signals = 2								
Signal Type	Input Power	Band Edge	Signal Frequency f1 [MHz]	Signal Frequency f2 [MHz]	Input Power [dBm]	Maximum Out-of-band Power [dBm]	Limit Out-of-band Power [dBm]	Margin to Limit [dB]
WB	-0.3 dB < AGC	upper	2197.50	2195.00	0.7	-33.8	-13.0	20.8
WB	3 dB > AGC	upper	2197.50	2195.00	4.0	-34.2	-13.0	21.2
NB	-0.3 dB < AGC	upper	2199.80	2199.60	0.5	-31.5	-13.0	18.5
NB	3 dB > AGC	upper	2199.80	2199.60	3.8	-31.5	-13.0	18.5
WB	-0.3 dB < AGC	lower	2182.50	2185.00	1.3	-34.1	-13.0	21.1
WB	3 dB > AGC	lower	2182.50	2185.00	4.6	-34.3	-13.0	21.3
NB	-0.3 dB < AGC	lower	2180.20	2180.40	1.5	-31.0	-13.0	18.0
NB	3 dB > AGC	lower	2180.20	2180.40	4.8	-31.5	-13.0	18.5

Remark: Please see next sub-clause for the measurement plot.

Explanations concerning table with two input signals:

"WB" means Wideband.
 "NB" means Narrowband.



BUREAU
VERITAS

EffectiveECL-TA-20-012-V01.00

TA tests on Andrew CAP MX AC 6/7E/80-
85/17E/19/23/25T

4.5.4 MEASUREMENT PLOT (SHOWING THE HIGHEST VALUE, "WORST CASE")

Band: AWS 1700E high; Frequency: 2.1800 GHz to 2.2000 GHz; Band Edge: upper; Mod: AWGN;
Input Power = 0.3 dB < AGC; Number of signals 1

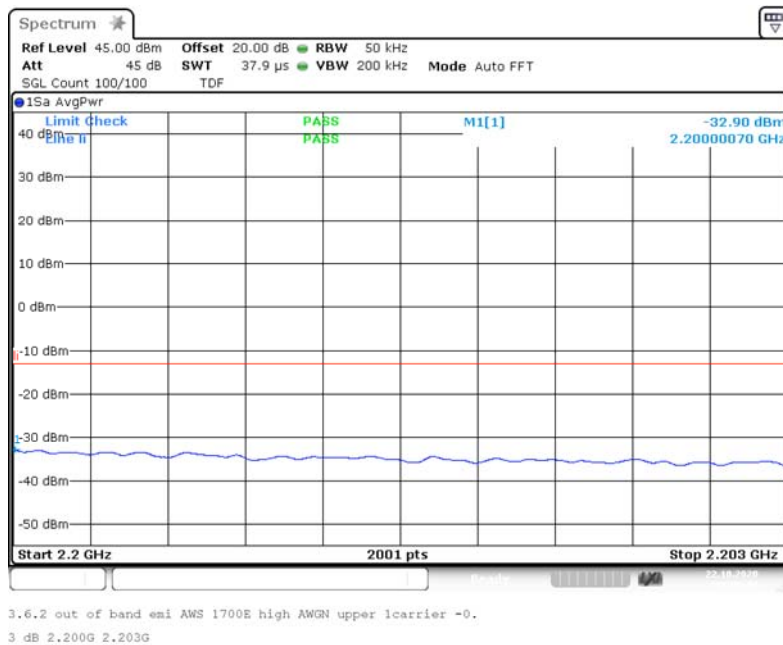

Band: AWS 1700E high; Frequency: 2.1800 GHz to 2.2000 GHz; Band Edge: upper; Mod: AWGN;
Input Power = 3 dB > AGC; Number of signals 1

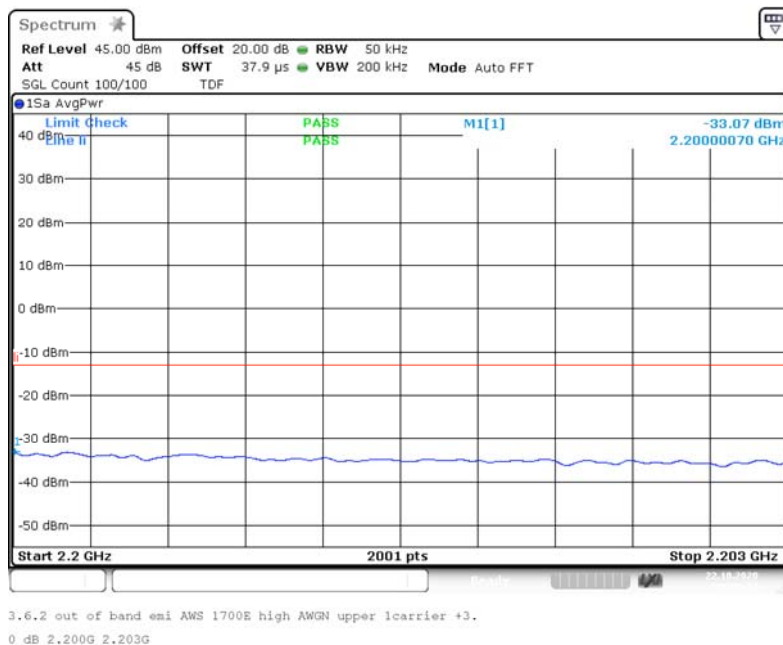



BUREAU
VERITAS

EffectiveECL-TA-20-012-V01.00

TA tests on Andrew CAP MX AC 6/7E/80-85/17E/19/23/25T

Band: AWS 1700E high; Frequency: 2.1800 GHz to 2.2000 GHz; Band Edge: upper; Mod: GSM;
Input Power = 0.3 dB < AGC; Number of signals 1

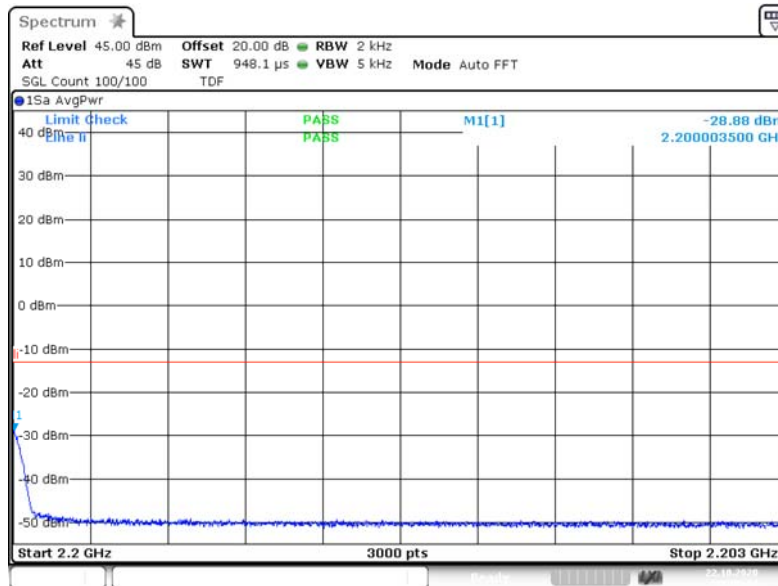

3.6.2 out of band emi AWS 1700E high GSM upper lcarrier -0.3
dB 2.200G 2.203G

Band: AWS 1700E high; Frequency: 2.1800 GHz to 2.2000 GHz; Band Edge: upper; Mod: GSM;
Input Power = 3 dB > AGC; Number of signals 1

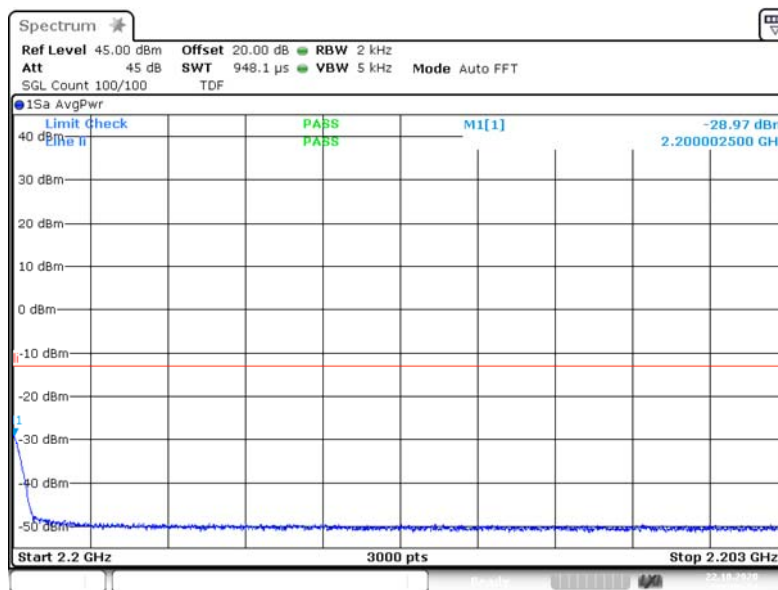

3.6.2 out of band emi AWS 1700E high GSM upper lcarrier +3.0
dB 2.200G 2.203G



BUREAU
VERITAS

EffectiveECL-TA-20-012-V01.00

TA tests on Andrew CAP MX AC 6/7E/80-85/17E/19/23/25T

Band: AWS 1700E high; Frequency: 2.1800 GHz to 2.2000 GHz; Band Edge: lower; Mod: AWGN;
Input Power = 0.3 dB < AGC; Number of signals 1

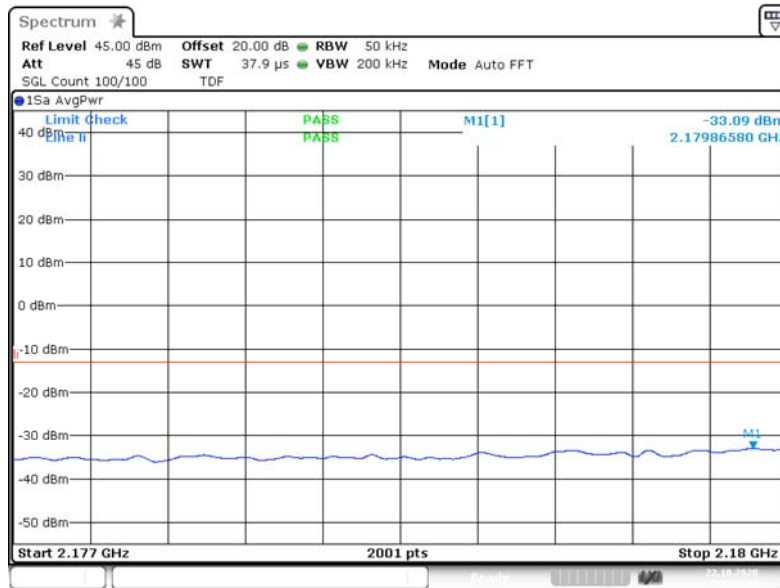

3.6.2 out of band emi AWS 1700E high AWGN lower lcarrier -0.
3 dB 2.177G 2.180G

Band: AWS 1700E high; Frequency: 2.1800 GHz to 2.2000 GHz; Band Edge: lower; Mod: AWGN;
Input Power = 3 dB > AGC; Number of signals 1

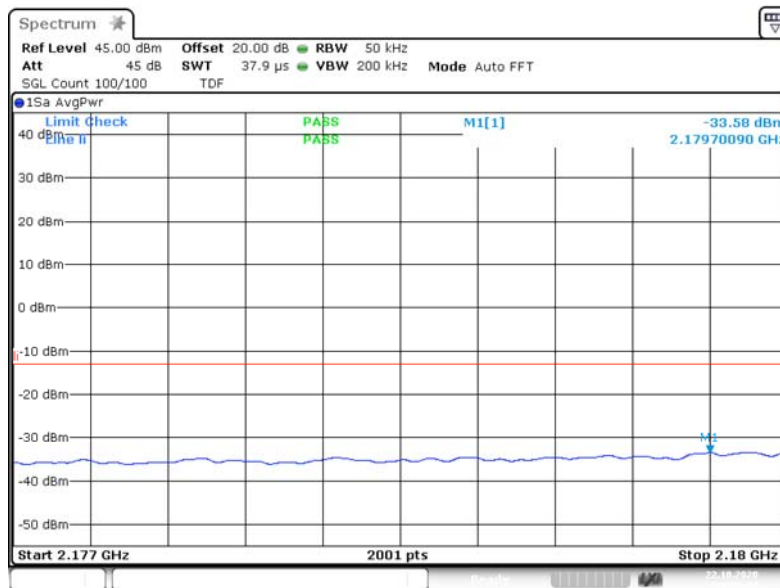

3.6.2 out of band emi AWS 1700E high AWGN lower lcarrier +3.
0 dB 2.177G 2.180G



BUREAU
VERITAS

EffectiveECL-TA-20-012-V01.00

TA tests on Andrew CAP MX AC 6/7E/80-85/17E/19/23/25T

Band: AWS 1700E high; Frequency: 2.1800 GHz to 2.2000 GHz; Band Edge: lower; Mod: GSM;
Input Power = 0.3 dB < AGC; Number of signals 1

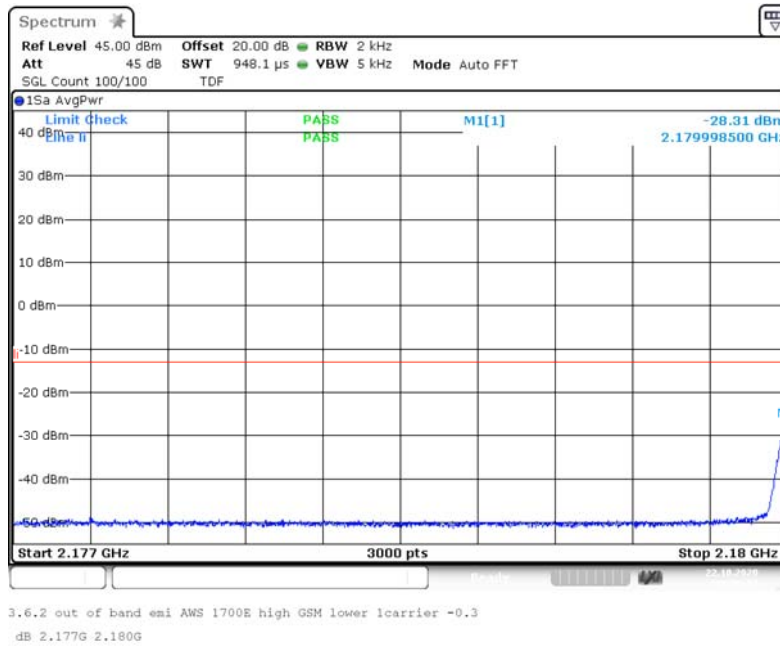

Band: AWS 1700E high; Frequency: 2.1800 GHz to 2.2000 GHz; Band Edge: lower; Mod: GSM;
Input Power = 3 dB > AGC; Number of signals 1

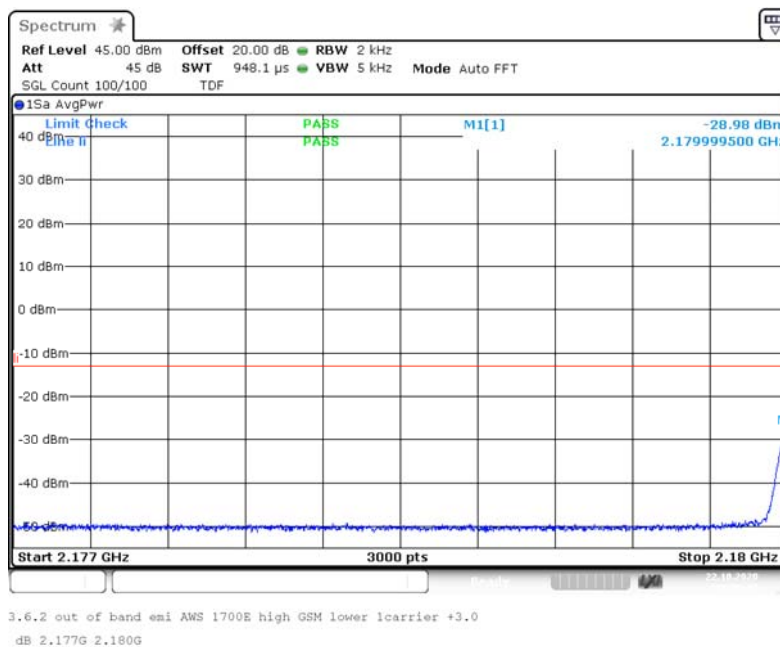



BUREAU
VERITAS

EffectiveECL-TA-20-012-V01.00

TA tests on Andrew CAP MX AC 6/7E/80-85/17E/19/23/25T

Band: AWS 1700E high; Frequency: 2.1800 GHz to 2.2000 GHz; Band Edge: upper; Mod: AWGN;
Input Power = 0.3 dB < AGC; Number of signals 2

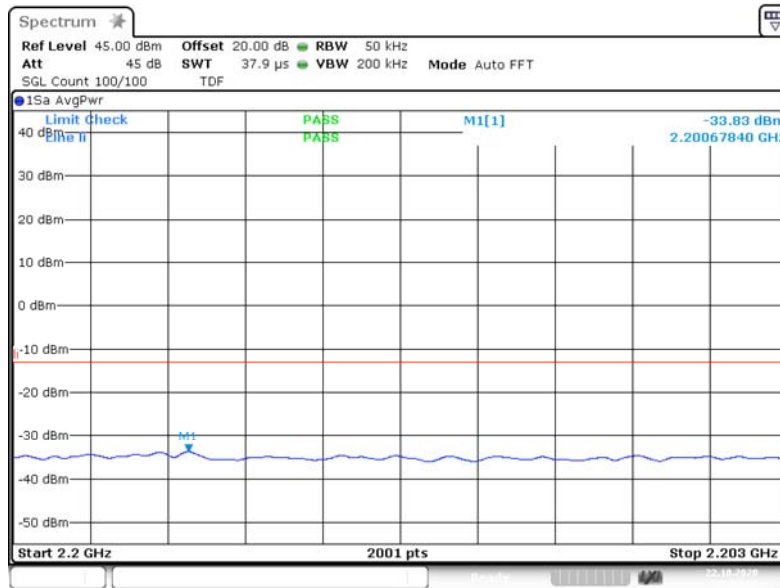

3.6.2 out of band emi AWS 1700E high AWGN upper 2carriers -0
.3 dB 2.200G 2.203G

Band: AWS 1700E high; Frequency: 2.1800 GHz to 2.2000 GHz; Band Edge: upper; Mod: AWGN;
Input Power = 3 dB > AGC; Number of signals 2

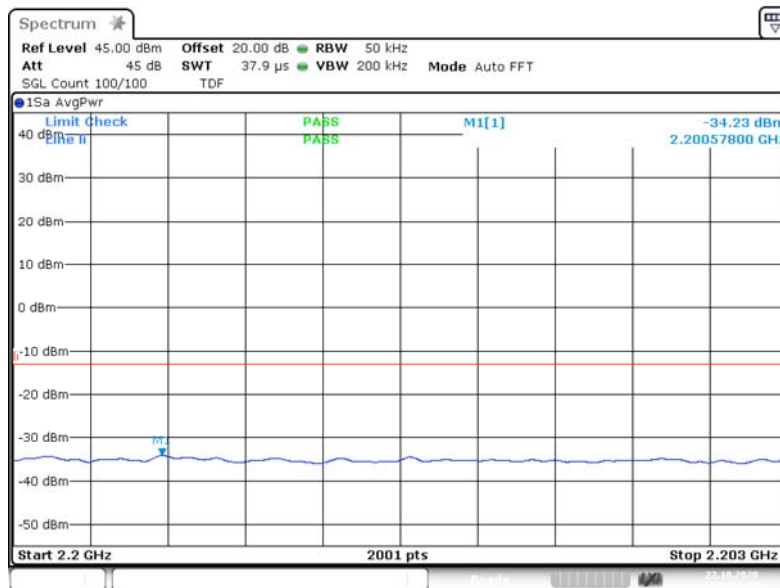

3.6.2 out of band emi AWS 1700E high AWGN upper 2carriers +3
.0 dB 2.200G 2.203G



BUREAU
VERITAS

EfectiveECL-TA-20-012-V01.00

TA tests on Andrew CAP MX AC 6/7E/80-85/17E/19/23/25T

Band: AWS 1700E high; Frequency: 2.1800 GHz to 2.2000 GHz; Band Edge: upper; Mod: GSM;
Input Power = 0.3 dB < AGC; Number of signals 2

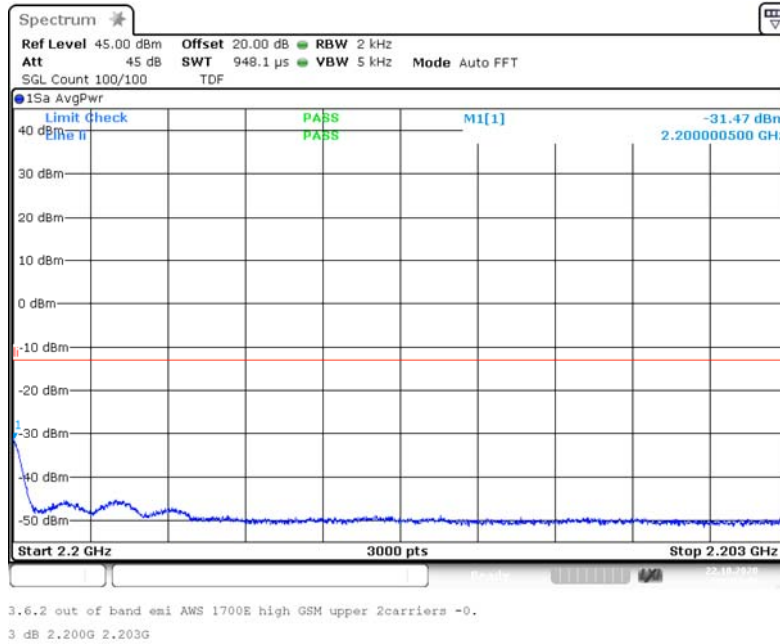

Band: AWS 1700E high; Frequency: 2.1800 GHz to 2.2000 GHz; Band Edge: upper; Mod: GSM;
Input Power = 3 dB > AGC; Number of signals 2

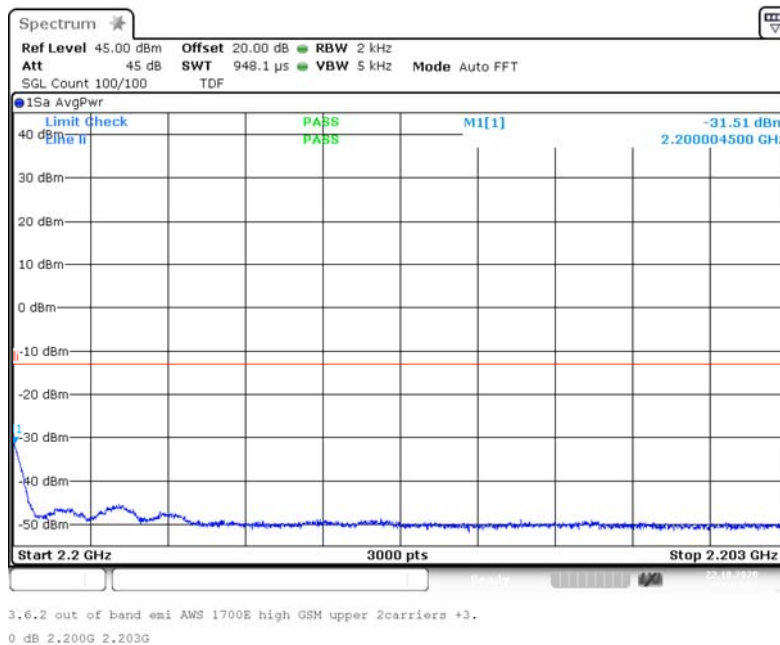



BUREAU
VERITAS

EffectiveECL-TA-20-012-V01.00

TA tests on Andrew CAP MX AC 6/7E/80-85/17E/19/23/25T

Band: AWS 1700E high; Frequency: 2.1800 GHz to 2.2000 GHz; Band Edge: lower; Mod: AWGN;
Input Power = 0.3 dB < AGC; Number of signals 2

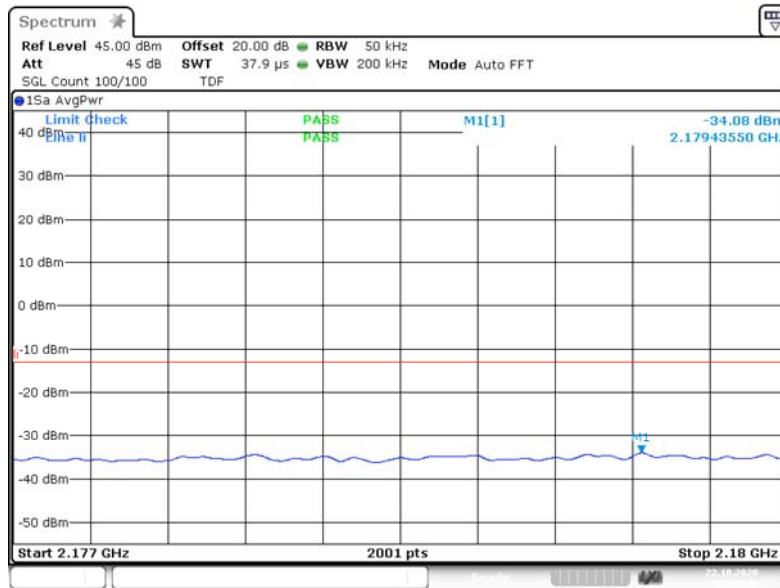

3.6.2 out of band emi AWS 1700E high AWGN lower 2carriers -0
.3 dB 2.177G 2.180G

Band: AWS 1700E high; Frequency: 2.1800 GHz to 2.2000 GHz; Band Edge: lower; Mod: AWGN;
Input Power = 3 dB > AGC; Number of signals 2

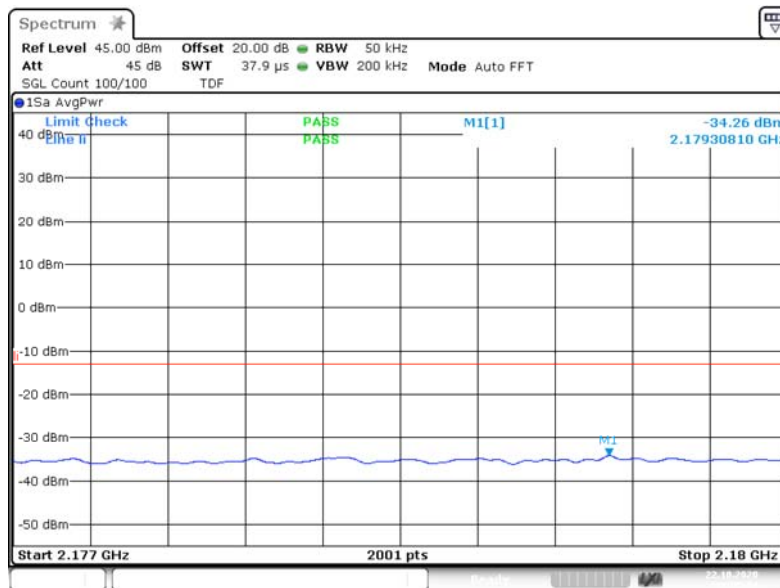

3.6.2 out of band emi AWS 1700E high AWGN lower 2carriers +3
.0 dB 2.177G 2.180G



BUREAU
VERITAS

EffectiveECL-TA-20-012-V01.00

TA tests on Andrew CAP MX AC 6/7E/80-85/17E/19/23/25T

Band: AWS 1700E high; Frequency: 2.1800 GHz to 2.2000 GHz; Band Edge: lower; Mod: GSM;
Input Power = 0.3 dB < AGC; Number of signals 2

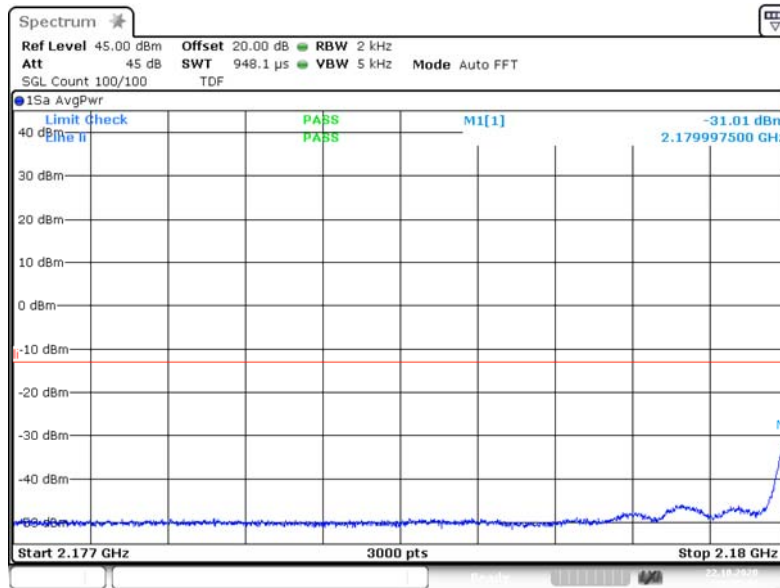

3.6.2 out of band emi AWS 1700E high GSM lower 2carriers -0.
3 dB 2.177G 2.180G

Band: AWS 1700E high; Frequency: 2.1800 GHz to 2.2000 GHz; Band Edge: lower; Mod: GSM;
Input Power = 3 dB > AGC; Number of signals 2

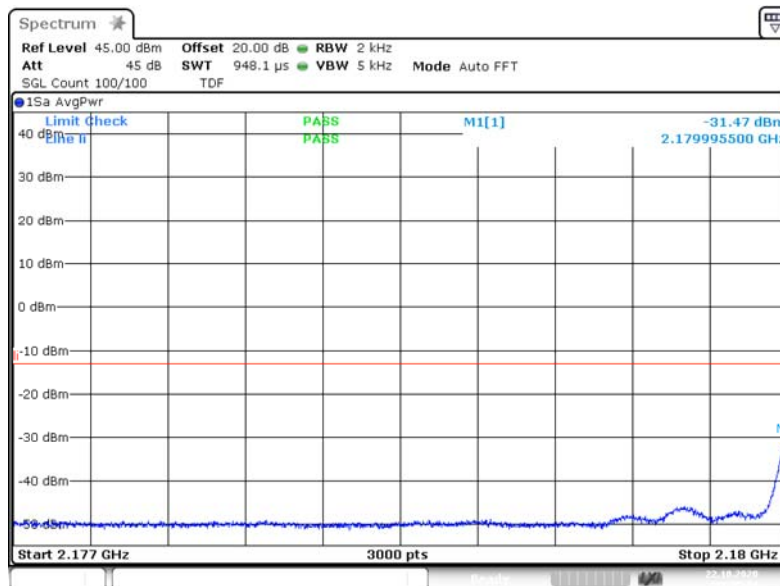

3.6.2 out of band emi AWS 1700E high GSM lower 2carriers +3.
0 dB 2.177G 2.180G



BUREAU
VERITAS

EfectiveECL-TA-20-012-V01.00

TA tests on Andrew CAP MX AC 6/7E/80-
85/17E/19/23/25T

4.5.5 TEST EQUIPMENT USED

- Conducted



Effective ECL-TA-20-012-V01.00

TA tests on Andrew CAP MX AC 6/7E/80-85/17E/19/23/25T

4.6 OUT-OF-BAND REJECTION

Standard FCC Part 27

The test was performed according to:

ANSI C63.26; KDB 935210 D05

Test date: 2020-08-20

Environmental conditions: 25 ° C; 42 % r. F.

Test engineer: Thomas Hufnagel

4.6.1 TEST DESCRIPTION

This test case is intended to demonstrate compliance to the out-of-band rejection test case for industrial signal boosters.

The EUT was connected to the test setup according to the following diagram:

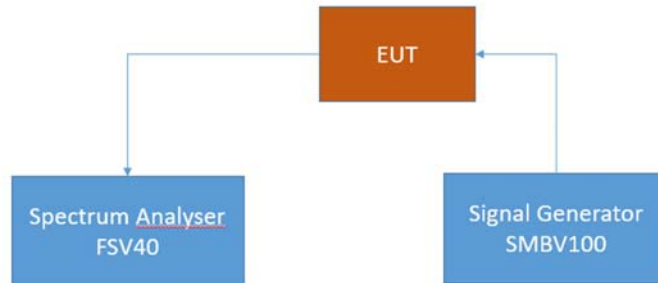

FCC Part 22/24/27/90 Industrial signal booster – Test Setup; Out-of-band rejection

The attenuation of the measuring and stimulus path are known for each measured frequency and are considered.

The Spectrum Analyzer settings can be directly found in the measurement diagrams.

4.6.2 TEST REQUIREMENTS/LIMITS

There are no requirements in the FCC rules.



**BUREAU
VERITAS**

EfectiveECL-TA-20-012-V01.00

TA tests on Andrew CAP MX AC 6/7E/80-85/17E/19/23/25T

4.6.3 TEST PROTOCOL

Band 66 AWS 1700E high, downlink				
Highest Power Frequency [MHz]	Output Power [dBm]	Lower Highest Power -20 dB Frequency [MHz]	Upper Highest Power -20 dB Frequency [MHz]	20 dB Bandwidth [MHz]
2192.37	21.59	2179.4650	2200.5450	21.0800

Remark: Please see next sub-clause for the measurement plot.

4.6.4 MEASUREMENT PLOT (SHOWING THE HIGHEST VALUE, "WORST CASE")

Frequency Band = AWS 1700E high, Direction = RF downlink

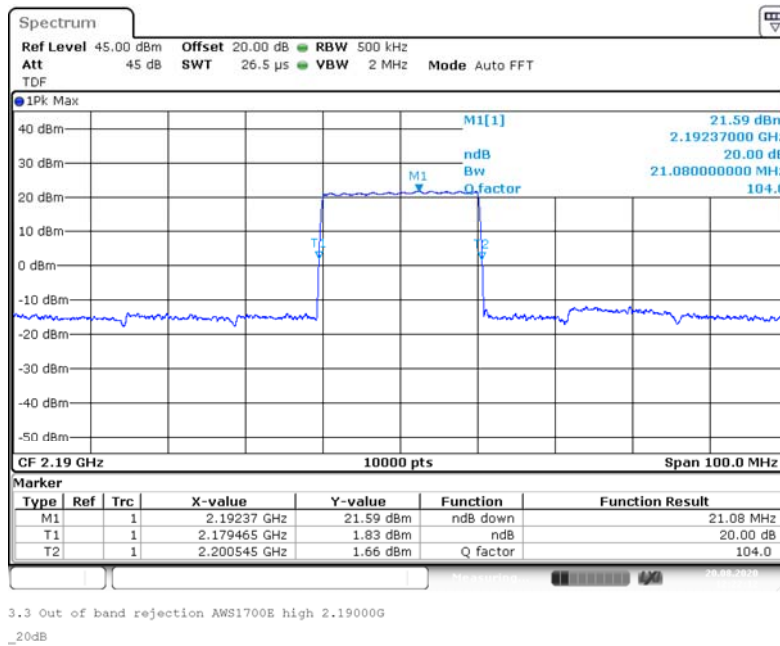

4.6.5 TEST EQUIPMENT USED

- Conducted

EfectiveECL-TA-20-012-V01.00

TA tests on Andrew CAP MX AC 6/7E/80-85/17E/19/23/25T

4.7 FIELD STRENGTH OF SPURIOUS RADIATION

Standard FCC Part 27, § 24.53

The test was performed according to:
ANSI C63.26

Test date: 2020-09-10

Environmental conditions: 23 ° C; 46 % r. F.

Test engineer: Thomas Hufnagel

4.7.1 TEST DESCRIPTION

This test case is intended to demonstrate compliance to the applicable radiated spurious emission measurements per FCC § 2.1053.

The EUT was connected to the test setup according to the following diagram:

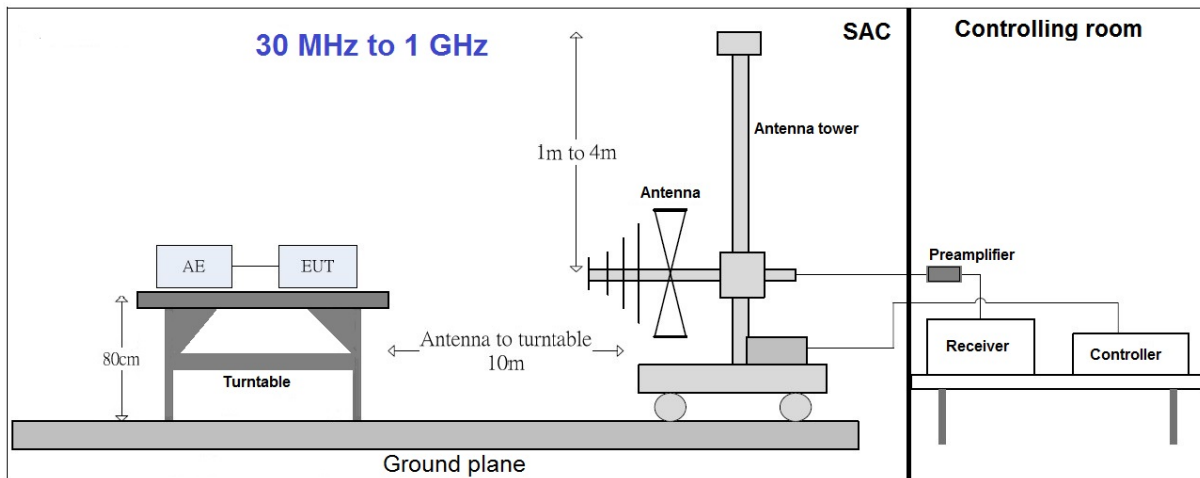

Effective ECL-TA-20-012-V01.00

TA tests on Andrew CAP MX AC 6/7E/80-85/17E/19/23/25T

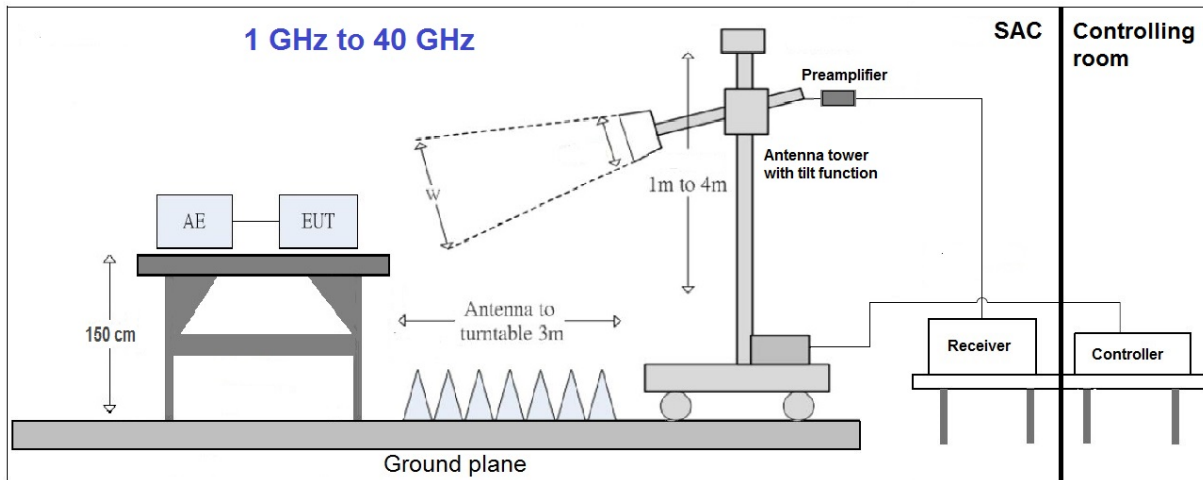

The test set-up was made in accordance to the general provisions of ANSI C63.4 in a typical installation configuration. The Equipment Under Test (EUT) was set up on a non-conductive table 1.5 x 1.5 m² in the semi-anechoic chamber, 0.8 meter above the ground or floor-standing arrangement shall be placed on the horizontal ground reference plane. The influence of the EUT support table that is used between 30–1000 MHz was evaluated. For the initial measurements, the receiving antenna is varied from 1-4 meter height and is changed in the vertical plane from vertical to horizontal polarization at each frequency. The highest emissions between 30 MHz to 1000 MHz were analyzed in details by operating the spectrum analyzer and/or EMI receiver in quasi-peak mode to determine the precise amplitude of the emissions.

The measurement procedure is implemented into the EMI test software BAT EMC from NEXIO. Exploratory tests are performed at 3 orthogonal axes to determine the worst-case orientation of a body-worn or handheld EUT. The final test on all kind of EUTs is also performed at 3 axes. A pre-check is performed while the EUT is powered by a DC power source. ?

1. Measurement above 30 MHz and up to 1 GHz

Step 1: Preliminary scan

This is a preliminary test to identify the highest amplitudes relative to the limit.

Settings for step 1:

- Antenna distance: 10 m
- Detector: Peak-Maxhold/RMS (FFT-based)
- Frequency range: 30 – 1000 MHz
- Frequency steps: 30 kHz
- IF-Bandwidth: 120 kHz
- Measuring time/Frequency step: 5 ms
- Turntable angle range: -180° to 180°
- Turntable step size: 30°
- Height variation range: 1 – 4 m
- Height variation step size: 1 m
- Polarisation: Horizontal + Vertical

Intention of this step is, to determine the radiated EMI-profile of the EUT. Afterwards the relevant emissions for the final measurement are identified.



Effective ECL-TA-20-012-V01.00

TA tests on Andrew CAP MX AC 6/7E/80-
85/17E/19/23/25T

Step 2: Adjustment measurement

In this step the accuracy of the turntable azimuth and antenna height will be improved. This is necessary to find out the maximum value of every frequency.

For each frequency, which was determined the turntable azimuth and antenna height will be adjusted. The turntable azimuth will slowly vary by $\pm 45^\circ$ around this value. During this action, the value of emission is continuously measured. The turntable azimuth at the highest emission will be recorded and adjusted. In this position, the antenna height will also slowly vary by ± 100 cm around the antenna height determined. During this action, the value of emission is also continuously measured. The antenna height of the highest emission will also be recorded and adjusted.

- Detector: Peak – Maxhold; RMS
- Measured frequencies: in step 1 determined frequencies
- IF – Bandwidth: 120 kHz
- Measuring time: 100 ms
- Turntable angle range: $\pm 30^\circ$ around the determined value
- Antenna Polarisation: max. value determined in step 1

Step 3: Final measurement with QP detector

With the settings determined in step 3, the final measurement will be performed:

EMI receiver settings for step 4:

- Detector: Quasi-Peak (< 1 GHz); RMS; Peak
- Measured frequencies: in step 1 determined frequencies
- IF – Bandwidth: 120 kHz
- Measuring time: 1 s

After the measurement a plot will be generated which contains a diagram with the results of the preliminary scan and a chart with the frequencies and values of the results of the final measurement.

3. Measurement above 1 GHz

The following modifications apply to the measurement procedure for the frequency range above 1 GHz:

Step 1:

The Equipment Under Test (EUT) was set up on a non-conductive support at 1.5 m height in the semi-anechoic chamber. Absorbers are placed around and between the turn table and the antenna tower.

All steps were performed with one height (1.5 m) of the receiving antenna only.

The EUT is turned during the preliminary measurement across the elevation axis, with a step size of 30° .

The turn table step size (azimuth angle) for the preliminary measurement is 15° .

Step 2:

The maximum RFI field strength was determined during the measurement by rotating the turntable (± 180 degrees) and varying the height of the receive antenna ($h = 1 \dots 4$ m) with an additional tilt function of the antenna. The turn table azimuth will slowly vary by $\pm 15^\circ$.

EMI receiver settings (for all steps):

- Detector: Peak, Average
- IF Bandwidth = 1 MHz



EfectiveECL-TA-20-012-V01.00

TA tests on Andrew CAP MX AC 6/7E/80-
85/17E/19/23/25T

Step 3:

Spectrum analyser settings for step 3:

- Detector: Peak/Average
- Measured frequencies: in step 1 determined frequencies
- IF – Bandwidth: 1 MHz
- Measuring time: 1 s

4.7.2 TEST REQUIREMENTS/LIMITS

Abstract from FCC Part § 2.1053:

FCC Part 2.1053; Measurement required: Field strength of spurious radiation:

Measurements shall be made to detect spurious emissions that may be radiated directly from the cabinet, control circuits, power leads, or intermediate circuit elements under normal conditions of installation and operation. Curves or equivalent data shall be supplied showing the magnitude of each harmonic and other spurious emission. For this test, single sideband, independent sideband, and controlled carrier transmitters shall be modulated under the conditions specified in paragraph (c) of § 2.1049, as appropriate.

Part 27; Miscellaneous Wireless Communication Services

Subpart C – Technical standards

§27.53 – Emission limits

Abstract § 27.53 FCC:

(h) AWS emission limits—(1) General protection levels. Except as otherwise specified below, for operations in the 1695-1710 MHz, 1710-1755 MHz, 1755-1780 MHz, 1915-1920 MHz, 1995-2000 MHz, 2000-2020 MHz, 2110-2155 MHz, 2155-2180 MHz, and 2180-2200 bands, the power of any emission outside a licensee's frequency block shall be attenuated below the transmitter power (P) in watts by at least $43 + 10 \log_{10} (P)$ dB.



EfectiveECL-TA-20-012-V01.00

TA tests on Andrew CAP MX AC 6/7E/80-85/17E/19/23/25T

4.7.3 TEST PROTOCOL

30 MHz to 1 GHz:

Band 66 AWS 1700E high, downlink;						
Spurious Freq. [MHz]	Spurious Level [dBm]	Pin (Sum Level) [dBm]	Detector	RBW [kHz]	Limit [dBm]	Margin to Limit [dB]
74.65	-55.4	0.8	PEAK	120	-13.0	42.4
236.71	-58.0	0.8	PEAK	120	-13.0	45.0
271.09	-54.6	0.8	PEAK	120	-13.0	41.6
600.01	-63.9	0.8	PEAK	120	-13.0	50.9

1 GHz to 18 GHz:

Band 66 AWS 1700E high, downlink;						
Spurious Freq. [MHz]	Spurious Level [dBm]	Pin (Sum Level) [dBm]	Detector	RBW [kHz]	Limit [dBm]	Margin to Limit [dB]
1699.5	-47.9	0.8	PEAK	1000	-13.0	34.9
1710.3	-48.5	0.8	PEAK	1000	-13.0	35.5
3545.6	-41.1	0.8	PEAK	1000	-13.0	28.1
2199.9	-41.4	0.8	PEAK	1000	-13.0	28.4
3530.5	-41.2	0.8	PEAK	1000	-13.0	28.2
17769.1	-20.2	0.8	PEAK	1000	-13.0	7.2

18 GHz to 27 GHz:

Band 66 AWS 1700E high, downlink;						
Spurious Freq. [MHz]	Spurious Level [dBm]	Pin (Sum Level) [dBm]	Detector	RBW [kHz]	Limit [dBm]	Margin to Limit [dB]
20626.0	-52.6	0.8	PEAK	1000	-13.0	39.6
20624.3	-52.4	0.8	PEAK	1000	-13.0	39.4

Remarks: Please see next sub-clause for the measurement plot.

Although usually a RMS detector is used for measruements in this cases a PEAK detector was used.

The limits are values for use of a RMS detector, but it is so, that the use of a PEAK detector results in readings with higher measured levels. Because the levels with the higher values with PEAK detector are in tolerance, the limits with a RMS detector are definately also in tolerance.



BUREAU
VERITAS

EffectiveECL-TA-20-012-V01.00

TA tests on Andrew CAP MX AC 6/7E/80-
85/17E/19/23/25T

4.7.4 MEASUREMENT PLOT (SHOWING THE HIGHEST VALUE, "WORST CASE")

Frequency Band = AWS 1700E high, Test Frequency = low, Direction = RF downlink

30 MHz - 1 GHz

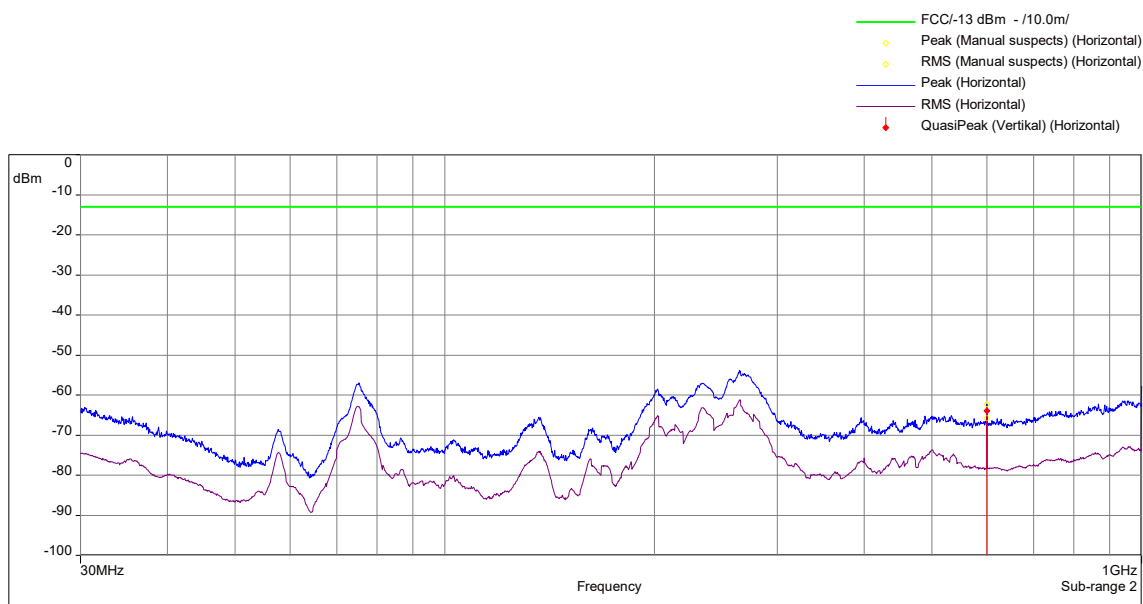
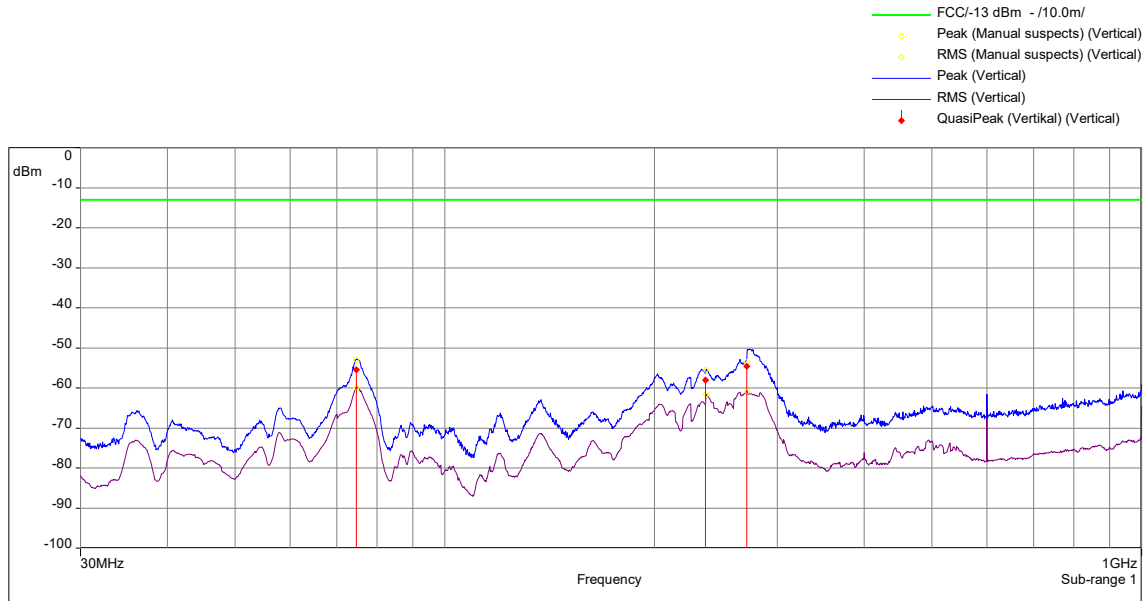



BUREAU
VERITAS

EffectiveECL-TA-20-012-V01.00

TA tests on Andrew CAP MX AC 6/7E/80-
85/17E/19/23/25T

Frequency Band = AWS 1700E high, Test Frequency = low, Direction = RF downlink

1 GHz - 18 GHz

- FCC/-13 dBm - /3.0m/
- Peak (Manual suspects) (Vertical)
- Avg (Manual suspects) (Vertical)
- RMS (Manual suspects) (Vertical)
- Peak (Vertical)
- Avg (Vertical)
- RMS (Vertical)
- Peak (Vertikal) (Vertical)
- RMS (Vertikal) (Vertical)
- Abstand RMS (Vertikal) (Vertical)

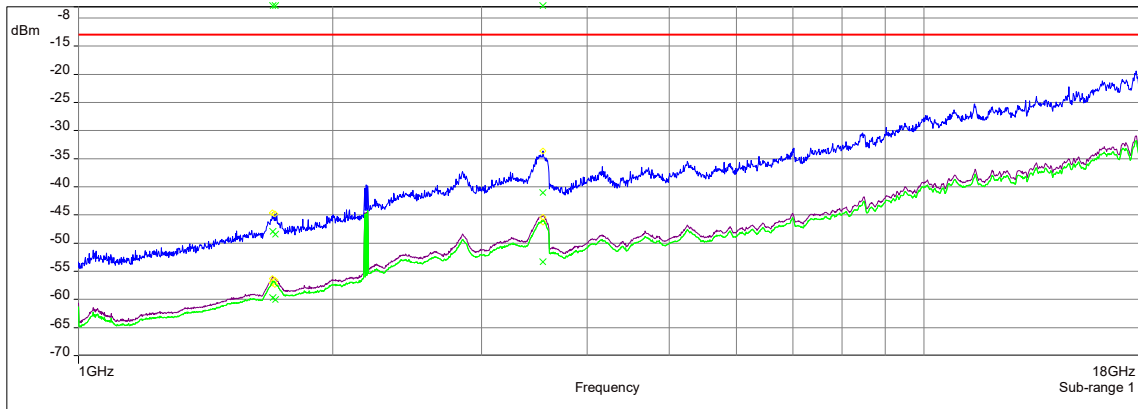

- FCC/-13 dBm - /3.0m/
- Peak (Manual suspects) (Horizontal)
- Avg (Manual suspects) (Horizontal)
- RMS (Manual suspects) (Horizontal)
- Peak (Horizontal)
- Avg (Horizontal)
- RMS (Horizontal)
- Peak (Vertikal) (Horizontal)
- RMS (Vertikal) (Horizontal)
- Abstand RMS (Vertikal) (Horizontal)

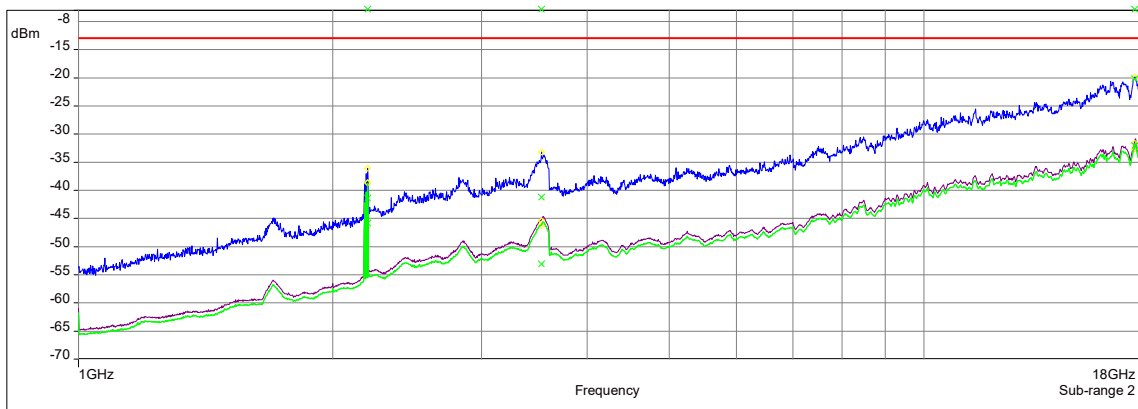



BUREAU
VERITAS

EffectiveECL-TA-20-012-V01.00

TA tests on Andrew CAP MX AC 6/7E/80-
85/17E/19/23/25T

Frequency Band = AWS 1700E high, Test Frequency = low, Direction = RF downlink

18 GHz - 27 GHz

- FCC/-13 dBm - /3.0m/
- Peak (Manual suspects) (Vertical)
- Avg (Manual suspects) (Vertical)
- RMS (Manual suspects) (Vertical)
- Peak (Vertical)
- Avg (Vertical)
- RMS (Vertical)
- Peak (Vertikal) (Vertical)
- RMS (Vertikal) (Vertical)
- Abstand RMS (Vertikal) (Vertical)

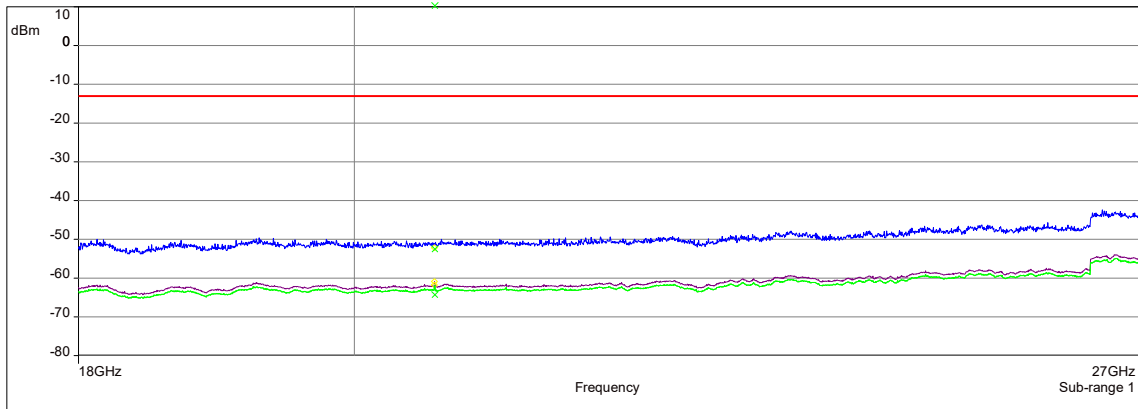

- FCC/-13 dBm - /3.0m/
- Peak (Manual suspects) (Horizontal)
- Avg (Manual suspects) (Horizontal)
- RMS (Manual suspects) (Horizontal)
- Peak (Horizontal)
- Avg (Horizontal)
- RMS (Horizontal)
- Peak (Vertikal) (Horizontal)
- RMS (Vertikal) (Horizontal)
- Abstand RMS (Vertikal) (Horizontal)

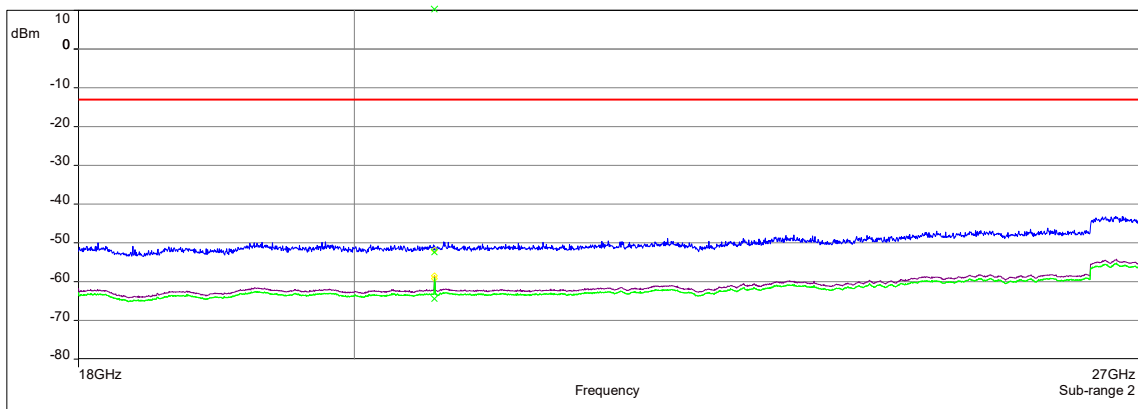



**BUREAU
VERITAS**

EfectiveECL-TA-20-012-V01.00

TA tests on Andrew CAP MX AC 6/7E/80-
85/17E/19/23/25T

4.7.5 FIELD STRENGTH CALCULATIONS

$$\mathbf{FS} = \mathbf{SA} + \mathbf{AF} + \mathbf{CL} + \mathbf{PA}$$

Where as:

- FS** = Field strength
- SA** = EMC test receiver reading
- AF** = Antenna factor
- CL** = Cable loss
- PA** = Preamplifier

4.7.6 TEST EQUIPMENT USED

- Radiated Emissions



Effective ECL-TA-20-012-V01.00

TA tests on Andrew CAP MX AC 6/7E/80-
85/17E/19/23/25T

5 TEST EQUIPMENT

1 Conducted

Ref.No.	Type	Description	Manufacturer	Inventory no.	Last Calibration	Calibration Due
1.1	FSV40	Signal Analyzer 10 Hz - 40 GHz	Rohde & Schwarz	E2050	2019-10	2020-10
1.2	SMBV100A	Vector Signal Generator 9 kHz - 6 GHz	Rohde & Schwarz	G2089	2017-08/ 2020-08	2022-08
1.3	SMIQ	Vector Signal Generator 9 kHz - 3.3 GHz	Rohde & Schwarz	G1509	2018-10	2021-10
1.4	SMIQ	Vector Signal Generator 9 kHz - 3.3 GHz	Rohde & Schwarz	G1510	2018-10	2021-10
1.5	ESH3-Z5	Line Impedance Stabilisation Network (LISN) 150 Hz - 30 MHz	Rohde & Schwarz	K794	2019-02	2020-10
1.6	30.3015	ThermoHygro Datalogger	TFA	X 507	2018-08	2021-08
1.7	BAT-EMC	Software	Nexio	V3.17.0.26	---	---

2 Radiated Emissions

Ref.No.	Type	Description	Manufacturer	Inventory no.	Last Calibration	Calibration Due
2.1	ESU40	EMI test receiver 10 Hz - 40 GHz	Rohde & Schwarz	E2025	2018-10	2020-10
2.2	HFH2-Z2	Antenna 9 kHz - 30 MHz	Rohde & Schwarz	K549	2018-10	2020-10
2.3	CBL 6111C	Antenna 30 MHz - 1 GHz	Chase	K1026	2020-01	2021-01
2.4	HL 025	Antenna 1 GHz - 18 GHz	Rohde & Schwarz	K1114	2019-06	2021-06
2.5	MWH-1826/B	Antenna 18 GHz - 26.5 GHz	ARA Inc.	K1042	2018-11	2020-11
2.6	MWH-2640/B	Antenna 26 GHz - 40 GHz	ARA Inc.	K1043	2018-11	2020-11
2.7	AM1431	Pre amplifier 10 kHz - 1 GHz	Miteq	K1721	2019-10	2020-10
2.8	AFS4-00102000	Pre amplifier 100 MHz - 20 GHz	Miteq	K817	2019-08	2021-08.
2.9	AFS4-00102000	Pre amplifier 100 MHz - 20 GHz	Miteq	K838	2019-10	2020-10
2.10	JS43-1800-4000	Pre amplifier 18 GHz - 40 GHz	Miteq	K1104	2019-05	2020-10
2.11	BAT-EMC	Software	Nexio	V3.17.0.26	---	---



Effective ECL-TA-20-012-V01.00

TA tests on Andrew CAP MX AC 6/7E/80-85/17E/19/23/25T

6 ANTENNA FACTORS, CABLE LOSS AND SAMPLE CALCULATIONS

This chapter contains the antenna factors with their corresponding path loss of the used measurement path for all antennas.

6.1 ANTENNA CHASE CBL 6111C (30 MHZ – 1 GHZ)

(d = 10 m)

Frequency	AF Horizontal R&S CBL 6111C	AF Vertikal R&S CBL 6111C	Corr.
30	47.9	38.1	-38.1
50	34.4	26.4	-38.0
100	31.6	32.8	-38.0
150	33.7	33.9	-37.9
200	30.3	32.8	-37.7
250	33.6	36.5	-37.5
300	34.5	36.8	-37.1
350	36.3	37.2	-37.0
400	36.9	38.3	-36.8
450	38.0	39.6	-36.5
500	39.2	40.4	-36.0
550	41.2	42.1	-35.9
600	41.6	41.7	-35.7
650	41.9	42.9	-35.9
700	42.3	43.4	-35.6
750	43.5	43.9	-35.7
800	43.6	44.6	-36.0
850	45.0	45.1	-36.1
900	45.2	45.1	-36.6
950	46.4	46.4	-36.4
1000	45.8	47.0	-36.0

cable loss (antenna - pre-amp)	pre-amp	cable loss (inside chamber)	cable loss (to receiver)
-0,01	-38.3	0.0	0.1
0,28	-38.4	0.3	0.1
0,52	-38.7	0.5	0.2
0,73	-38.8	0.7	0.2
0,95	-38.9	1.0	0.3
1,10	-38.9	1.1	0.3
1,20	-38.6	1.2	0.3
1,29	-38.6	1.3	0.3
1,36	-38.5	1.4	0.3
1,42	-38.2	1.4	0.4
1,48	-37.9	1.5	0.4
1,54	-37.8	1.5	0.4
1,60	-37.7	1.6	0.4
1,64	-38.0	1.6	0.5
1,71	-37.8	1.7	0.5
1,76	-38.0	1.8	0.5
1,80	-38.3	1.8	0.5
1,84	-38.4	1.8	0.5
1,91	-39.0	1.9	0.5
1,93	-38.9	1.9	0.6
1,99	-38.6	2.0	0.6

Sample calculation

$E \text{ (dB } \mu\text{V/m)} = U \text{ (dB } \mu\text{V)} + AF \text{ (dB 1/m)} + Corr. \text{ (dB)}$
 U = Receiver reading
 AF = Antenna factor
 Corr. = sum of single correction factors of used cables, switch unit, distance correction, amplifier (if applicable)
 distance correction = $-20 * LOG (d_{Limit} / d_{used})$
 Linear interpolation will be used for frequencies in between the values in the table.
 Tables show an extract of values.



EffectiveECL-TA-20-012-V01.00

TA tests on Andrew CAP MX AC 6/7E/80-
85/17E/19/23/25T

6.2 ANTENNA ROHDE & SCHWARZ HL 025 (1 GHZ – 18 GHZ)

Frequency	AF R&S HL 025	Corr.
MHz	dB (1/m)	dB
1000	33.2	-18.9
2000	39.4	-17.8
3000	42.8	-17.0
4000	45.1	-16.6
5000	46.8	-16.6
6000	48.5	-16.7
7000	50.2	-16.2
8000	50.4	-15.3
9000	51.9	-14.4
10000	53.8	-14.0
11000	54.5	-14.1
12000	55.3	-14.4
13000	55.7	-14.7
14000	56.5	-14.8
15000	56.4	-14.7
16000	57.2	-14.3
17000	57.6	-14.5
18000	57.6	-14.6

pre-amp	cable loss (to receiver)
dB	dB
-20.92	2.01
-20.60	2.78
-20.44	3.42
-20.58	3.99
-21.08	4.46
-21.53	4.87
-21.53	5.35
-20.97	5.66
-20.44	6.05
-20.43	6.45
-20.84	6.69
-21.41	7.04
-22.09	7.36
-22.48	7.66
-22.56	7.90
-22.49	8.20
-22.90	8.45
-23.27	8.71

Sample calculation

$E \text{ (dB } \mu\text{V/m)} = U \text{ (dB } \mu\text{V)} + AF \text{ (dB 1/m)} + Corr. \text{ (dB)}$
U = Receiver reading
AF = Antenna factor
Corr. = sum of single correction factors of used cables, switch unit, distance correction, amplifier (if applicable)
Linear interpolation will be used for frequencies in between the values in the table.
Tables show an extract of values.



EffectiveECL-TA-20-012-V01.00

TA tests on Andrew CAP MX AC 6/7E/80-85/17E/19/23/25T

6.3 ANTENNA ARA INC. MWH-1826-B (18 GHZ – 26.5 GHZ) PARTIALLY IN CONJUNCTION WITH PRE-AMPLIFIER MITEQ JS43-1800-4000: THE USE OF THE PRE-AMPLIFIER IS DEPENDENT FROM THE FIELD STRENGTH

Frequency	AF	Corr.
MHz	dB (1/m)	dB
18000	44.3	-37.5
18500	43.9	-37.6
19000	44.4	-36.9
19500	44.1	-36.1
20000	44.6	-36.3
20500	44.9	-36.1
21000	45.2	-35.9
21500	45.0	-35.7
22000	45.1	-35.3
22500	45.4	-35.0
23000	45.7	-35.6
23500	45.8	-34.3
24000	45.3	-34.8
24500	45.3	-35.0
25000	46.1	-34.3
25500	46.5	-34.2
26000	46.7	-34.8
26500	46.5	-34.4
27000	46.4	-35.1

pre-amp	cable loss
dB	(to receiver) dB
-46.2	8.7
-46.4	8.8
-45.9	9.0
-45.2	9.1
-45.6	9.3
-45.5	9.4
-45.3	9.4
-45.3	9.7
-45.1	9.8
-44.8	9.8
-45.5	9.9
-44.4	10.1
-45.0	10.2
-45.3	10.4
-44.8	10.5
-44.7	10.5
-45.4	10.6
-45.1	10.7
-46.0	10.9

Sample calculation

$E \text{ (dB } \mu\text{V/m)} = U \text{ (dB } \mu\text{V)} + AF \text{ (dB 1/m)} + Corr. \text{ (dB)}$
U = Receiver reading
AF = Antenna factor
Corr. = sum of single correction factors of used cables, switch unit, distance correction, amplifier (if applicable)
Linear interpolation will be used for frequencies in between the values in the table.
Table shows an extract of values.



**BUREAU
VERITAS**

Effective ECL-TA-20-012-V01.00

TA tests on Andrew CAP MX AC 6/7E/80-
85/17E/19/23/25T

7 MEASUREMENT UNCERTAINTIES

KDB 935210 D05	ECL
Power measurement	0,68 dB
Measuring AGC threshold level	0,90 dB
Out of band rejection	0,90 dB
Input-versus-output signal comparison	0,91 dB
Mean power output	0,90 dB
Measuring out-of-band/out-of-block (including intermodulation) emissions and spurious emissions	0,90 dB
Out-of-band/out-of-block emissions conducted measurements	0,90 dB
Spurious emissions conducted	2,18 dB
Spurious emissions radiated measurements	5,38 dB
Total frequency uncertainty	2×10^{-7}

Reference :

ECL-MU5.4.6.3-EMC-14-001-V03.00 MU Wireless.xlsx

EffectiveECL-TA-20-012-V01.00

TA tests on Andrew CAP MX AC 6/7E/80-85/17E/19/23/25T

8 PHOTO REPORT

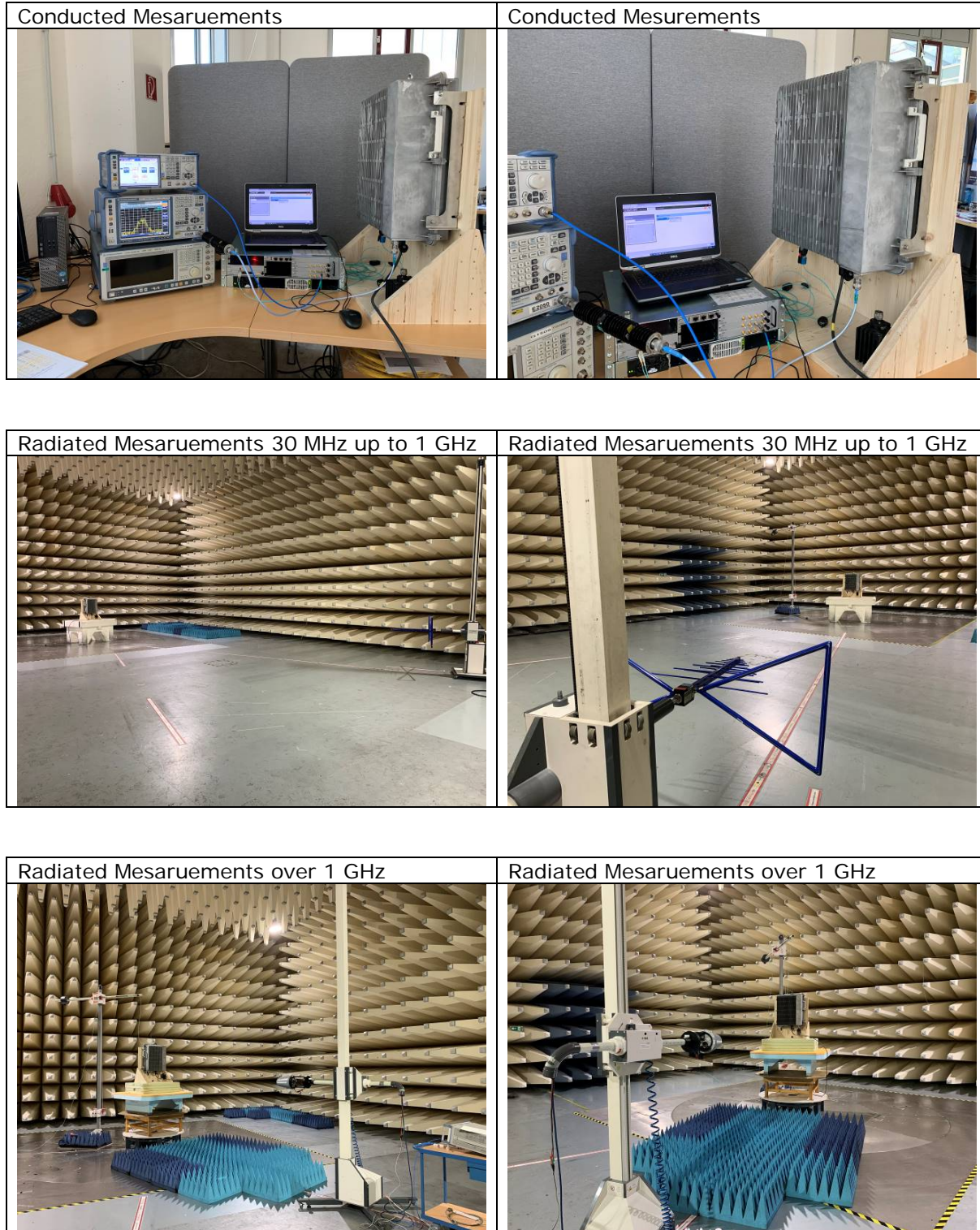



**BUREAU
VERITAS**

EfectiveECL-TA-20-012-V01.00

TA tests on Andrew CAP MX AC 6/7E/80-
85/17E/19/23/25T

Annex A: Accreditation certificate (for information)

The accreditation relates to competences stated on the accreditation certificate. The current certificate is available on the homepage of the DAkkS and can be downloaded under accredited bodies with the processing number:

<https://www.dakks.de/en>



**BUREAU
VERITAS**

EfectiveECL-TA-20-012-V01.00

TA tests on Andrew CAP MX AC 6/7E/80-
85/17E/19/23/25T

Annex B: Additional information provided by client

None.

***** End of test report *****