



ECL-TA Test Report No.: 20-013

Designation:	CAP M 80-85/17E/19/26 F-AC
Manufacturer:	Andrew
Serial No(s):	FICMHA2030001
ID No.	7840984-0001, Rev.: 00
Test Specification(s):	ANSI 63.26:2015 FCC Rules and Regulations as listed in 47 CFR, Part 20:2019-10-01
Test Plan:	Measurement of Band IMT 2600 downlink.
Test Result:	Passed

Date of issue:	2020-11-12		Signature:
Version:	01	Technical Reviewer:	
Date of delivery:	2020-07		
Performance date:	2020-09-14 – 2020-09-30	Report Reviewer:	



Deutsche
Akkreditierungsstelle
D-PL-12024-06-02

The test results relates only to the tested item. The sample has been provided by the client.
Without the written consent of Bureau Veritas Consumer Products Services Germany GmbH excerpts of this report shall not be reproduced.

Bureau Veritas
Consumer Products Services Germany GmbH
www.bureauveritas.de/cps
Phone: +49 (0)40 – 740 41 – 0

Schwerin
Wilhelm-Hennemann-Str. 8, 19061 Schwerin
cps-schwerin@de.bureauveritas.com

Tuerkheim
Businesspark A96, 86842 Tuerkheim
cps-tuerkheim@de.bureauveritas.com

Managing Director: Sebastian Doose/Stefan Kischka
Reg.No.: Schwerin HRB 3564

Hamburg
Oehleckerring 40, 22419 Hamburg
cps-hamburg@de.bureauveritas.com

Nuremberg
Thurn-und-Taxis-Str. 18, 90411 Nuremberg
cps-nuernberg@de.bureauveritas.com



Client: Commscope
Andrew Wireless System GmbH
Industriering 10
86675 Buchdorf Germany

Test Laboratory: Bureau Veritas Consumer Products Services Germany GmbH
Thurn-und-Taxis-Straße 18
D-90411 Nürnberg
Tel.: +49 40 74041 0
Fax: +49 40 74041-2755

Versions management:
V01.00 Initial release



Table of Contents

1	APPLIED STANDARDS AND TEST SUMMARY	4
1.1	APPLIED STANDARDS	4
1.2	FCC-IC CORRELATION TABLE	5
1.3	MEASUREMENT SUMMARY/SIGNATURES	6
2	ADMINISTRATIVE DATA	9
2.1	TESTING LABORATORY	9
2.2	APPLICANT DATA	9
2.3	MANUFACTURER DATA	9
3	TEST OBJECT DATA	10
3.1	GENERAL EUT DESCRIPTION	10
3.2	EUT MAIN COMPONENTS	11
3.3	ANCILLARY EQUIPMENT	11
3.4	AUXILIARY EQUIPMENT	12
3.5	EUT SETUPS	13
3.6	PRODUCT LABELLING	14
4	TEST RESULTS	15
4.1	EFFECTIVE RADIATED POWER; MEAN OUTPUT POWER AND ZONE ENHANCER GAIN 15	
4.2	PEAK TO AVERAGE RATIO	20
4.3	OCCUPIED BANDWIDTH/INPUT-VERSUS-OUTPUT SPECTRUM	25
4.4	CONDUCTED SPURIOUS EMISSIONS AT ANTENNA TERMINALS	32
4.5	OUT-OF-BAND EMISSION LIMITS	42
4.6	OUT-OF-BAND REJECTION	54
4.7	FIELD STRENGTH OF SPURIOUS RADIATION	56
5	TEST EQUIPMENT	66
6	ANTENNA FACTORS, CABLE LOSS AND SAMPLE CALCULATIONS	67
6.1	ANTENNA CHASE CBL 6111C (30 MHZ – 1 GHZ)	67
6.2	ANTENNA ROHDE & SCHWARZ HL 025 (1 GHZ – 18 GHZ)	68
6.3	ANTENNA ARA INC. MWH-1826-B (18 GHZ – 26.5 GHZ) PARTIALLY IN CONJUNCTION WITH PRE-AMPLIFIER MITEQ JS43-1800-4000: THE USE OF THE PRE-AMPLIFIER IS DEPENDENT FROM THE FIELD STRENGTH	69
7	MEASUREMENT UNCERTAINTIES	70
8	PHOTO REPORT	71
	Annex A: Accreditation certificate (for information)	72
	Annex B: Additional information provided by client	73



1 APPLIED STANDARDS AND TEST SUMMARY

1.1 APPLIED STANDARDS

Type of Authorization

Certification for an Industrial Signal Booster.

Applicable FCC Rules

Prepared in accordance with the requirements of FCC Rules and Regulations as listed in 47 CFR Ch.1 Parts 2 and 20, 22 and 27. The following subparts are applicable to the results in this test report.

Part 2, Subpart J - Equipment Authorization Procedures, Certification

Part 20, Commercial Mobile Services

§ 20.21 Signal Boosters

Part 27; Miscellaneous Wireless Communications Services

Subpart C – Technical standards

§ 27.50 – Power and antenna height limits

§ 27.54 – Frequency stability

§ 27.53 – Emission limitations for broadband PCS equipment

The tests were selected and performed with reference to:

- FCC Public Notice 935210 applying “Signal Boosters Basic Certification Requirements” 935210 D02, 2019-15-04.
- FCC Public Notice 935210 applying “Measurement guidance for industrial and non-consumer signal booster, repeater and amplifier devices” 935210 D05, 2019-04-03.
- FCC Public Notice 971168 applying “Measurement guidance for certification of licensed digital transmitters” 971168 D01, 2019-04-09.
- ANSI C63.26: 2015



Summary Test Results:

The EUT complies with all performed tests as listed in chapter 1.3 Measurement Summary/Signatures.

1.2 FCC-IC CORRELATION TABLE

**Correlation of measurement requirements for
 Industrial Signal Booster from FCC and ISED Canada**

Measurement	FCC reference	ISED reference
Effective radiated power, mean output power and zone enhancer gain	§ 2.1046 § 27.50 KDB 935210 D05 v01r04: 3.5	RSS-GEN Issue 5, 6.12 RSS-131 Issue 3: 5.2.3 RSS-199 Issue 3, 4.4 SRSP-517, Issue 7, 5.1.1
Peak to Average Ratio	§ 27.50	RSS-199 Issue 3, 6.4
Occupied bandwidth Input-versus-output spectrum	§ 2.1049 KDB 935210 D05 v01r04: 3.4	RSS-GEN Issue 5, 6.7 RSS-131 Issue 3: 5.2.2
Conducted spurious Emission at Antenna Terminal	§ 2.1051 § 27.53 KDB 935210 D05 v01r04: 3.6	RSS-GEN Issue 5, 6.13 RSS-199 Issue 3, 4.5
Out-of-band emissions limits	§ 2.1051 § 27.53 KDB 935210 D05 v01r04: 3.6	RSS-GEN Issue 5, 6.13 RSS-199 Issue 3, 4.5
Frequency stability	§ 2.1055 § 27.54	RSS-GEN Issue 5, 6.11 RSS-131 Issue 3: 5.2.4 RSS-199 Issue 3, 4.3
Field strength of spurious radiation	§ 2.1053 § 27.53	RSS-GEN Issue 5, 6.13 RSS-199 Issue 3, 4.5
Out-of-band rejection	KDB 935210 D05 v01r04: 3.3	RSS-131 Issue 3: 5.2.1
All measurements	ANSI 63.26	ANSI 63.26



1.3 MEASUREMENT SUMMARY/SIGNATURES

47 CFR CHAPTER I FCC PART 27 Subpart C § 2.1046, § 27.50
[Base Stations/Repeater]

Effective Radiated Power, mean output power and zone enhancer gain
 The measurement was performed according to ANSI C63.26, KDB
 935210 D05 v01r04: 3.5 **Final Result**

OP-Mode	FCC	IC
Frequency Band, Direction, Input Power, Signal Type		
Band IMT 2600, RF downlink, 0.3 dB < AGC, Narrowband	Passed	Passed
Band IMT 2600, RF downlink, 0.3 dB < AGC, Wideband	Passed	Passed
Band IMT 2600, RF downlink, 3 dB > AGC, Narrowband	Passed	Passed
Band IMT 2600, RF downlink, 3 dB > AGC, Wideband	Passed	Passed

47 CFR CHAPTER I FCC PART 27 Subpart C § 27.50
[Base Stations/Repeater]

Peak to Average Ratio
 The measurement was performed according to ANSI C63.26 **Final Result**

Band IMT 2600, RF downlink, 0.3 dB < AGC, Narrowband	Passed	Passed
Band IMT 2600, RF downlink, 0.3 dB < AGC, Wideband	Passed	Passed
Band IMT 2600, RF downlink, 3 dB > AGC, Narrowband	Passed	Passed
Band IMT 2600, RF downlink, 3 dB > AGC, Wideband	Passed	Passed

47 CFR CHAPTER I FCC PART 27 Subpart C § 2.1049
[Base Stations/Repeater]

Occupied Bandwidth/Input-versus-output Spectrum
 The measurement was performed according to ANSI C63.26, KDB
 935210 D05 v01r04: 3.4 **Final Result**

OP-Mode	FCC	IC
Frequency Band, Direction, Input Power, Signal Type		
Band IMT 2600, RF downlink, 0.3 dB < AGC, Narrowband	Passed	Passed
Band IMT 2600, RF downlink, 0.3 dB < AGC, Wideband	Passed	Passed
Band IMT 2600, RF downlink, 3 dB > AGC, Narrowband	Passed	Passed
Band IMT 2600, RF downlink, 3 dB > AGC, Wideband	Passed	Passed



47 CFR CHAPTER I FCC PART 27 Subpart C § 2.1051, § 27.53
[Base Stations/Repeater]

Conducted spurious emissions at antenna terminals
 The measurement was performed according to ANSI C63.26

	Final Result	
OP-Mode	FCC	IC
Frequency Band, Direction, Input Power, Signal Type		
Band IMT 2600, RF downlink, 0.3 dB < AGC, Narrowband	Passed	Passed
Band IMT 2600, RF downlink, 0.3 dB < AGC, Wideband	Passed	Passed
Band IMT 2600, RF downlink, 3 dB > AGC, Narrowband	Passed	Passed
Band IMT 2600, RF downlink, 3 dB > AGC, Wideband	Passed	Passed

47 CFR CHAPTER I FCC PART 27 Subpart C § 2.1051, § 27.53
[Base Stations/Repeater]

Out-of-band emission limits
 The measurement was performed according to ANSI C63.26, KDB 935210 D05 v01r04: 3.6

	Final Result	
OP-Mode	FCC	IC
Band Edge, Frequency Band, Number of signals, Direction, Input Power, Signal Type		
Lower, Band IMT 2600, 1, RF downlink, 0.3 dB < AGC, Narrowband	Passed	Passed
Lower, Band IMT 2600, 1, RF downlink, 0.3 dB < AGC, Wideband	Passed	Passed
Lower, Band IMT 2600, 1, RF downlink, 3 dB > AGC, Narrowband	Passed	Passed
Lower, Band IMT 2600, 1, RF downlink, 3 dB > AGC, Wideband	Passed	Passed
Lower, Band IMT 2600, 2, RF downlink, 0.3 dB < AGC, Narrowband	Passed	Passed
Lower, Band IMT 2600, 2, RF downlink, 0.3 dB < AGC, Wideband	Passed	Passed
Lower, Band IMT 2600, 2, RF downlink, 3 dB > AGC, Narrowband	Passed	Passed
Lower, Band IMT 2600, 2, RF downlink, 3 dB > AGC, Wideband	Passed	Passed
Upper, Band IMT 2600, 1, RF downlink, 0.3 dB < AGC, Narrowband	Passed	Passed
Upper, Band IMT 2600, 1, RF downlink, 0.3 dB < AGC, Wideband	Passed	Passed
Upper, Band IMT 2600, 1, RF downlink, 3 dB > AGC, Narrowband	Passed	Passed
Upper, Band IMT 2600, 1, RF downlink, 3 dB > AGC, Wideband	Passed	Passed
Upper, Band IMT 2600, 2, RF downlink, 0.3 dB < AGC, Narrowband	Passed	Passed
Upper, Band IMT 2600, 2, RF downlink, 0.3 dB < AGC, Wideband	Passed	Passed
Upper, Band IMT 2600, 2, RF downlink, 3 dB > AGC, Narrowband	Passed	Passed
Upper, Band IMT 2600, 2, RF downlink, 3 dB > AGC, Wideband	Passed	Passed



**47 CFR CHAPTER I FCC PART 27 Subpart C
[Base Stations/Repeater]**

KDB 935210 D05 v01r04: 3.3

Out-of-band rejection

The measurement was performed according to ANSI C63.26; KDB 935210 D05 v01r04: 3.3

Final Result

OP-Mode

Frequency Band, Direction

Band IMT 2600, RF downlink

Setup

FCC

IC

Passed

Passed

**47 CFR CHAPTER I FCC PART 27 Subpart C
[Base Stations/Repeater]**

§ 2.1053, § 27.53

Field strength of spurious radiation

The measurement was performed according to ANSI C63.26

Final Result

OP-Mode

Frequency Band, Test Frequency, Direction

Band IMT 2600, high, RF downlink

Band IMT 2600, low, RF downlink

Band IMT 2600, mid, RF downlink

FCC

IC

Passed

Passed

Passed

Passed

Passed

Passed

The test case frequency stability was not performed, since the EUT is not equipped with signal processing capabilities.



2 ADMINISTRATIVE DATA

2.1 TESTING LABORATORY

Bureau Veritas Consumer Products Services Germany GmbH
Thurn-und-Taxis-Straße 18
D-90411 Nürnberg
Tel.: +49 40 74041 0
Fax: +49 40 74041-2755

2.2 APPLICANT DATA

Company Name: Commscope
Andrew Wireless Systems GmbH

Address: Industriering 10
86675 Buchdorf
Germany

Contact Person: Mr. Frank Futter

2.3 MANUFACTURER DATA

Company Name: Please see applicant data.

Address:

3 TEST OBJECT DATA

3.1 GENERAL EUT DESCRIPTION

Kind of Device product description	Cellular Repeater
Product name	Cellular Repeater
Type	
Declared EUT data by the supplier	
General Product Description	<p>The EUT is an industrial signal booster supporting the following:</p> <ul style="list-style-type: none"> Band 5/CELL 850 Band 25/PCS 1900 Band 27/CELL 800 Band 66/AWS 1700E (partly) Band IMT 2600 <p>A RF operation is only supported for the downlink.</p>
Booster Type	Industrial Signal Booster
Voltage Type	AC/50 Hz – 60 Hz
Voltage Level	100 V - 240 V
Maximum Output Donor Port [Uplink]	-
Nominal Output Server Port [Downlink]	<ul style="list-style-type: none"> Band 5/CELL 850: 26 dBm Band 25/PCS 1900: 30 dBm Band 27/CELL 800: 26 dBm Band 66/AWS 2100 (partly): 30 dBm Band IMT 2600: 31 dBm
Nominal Gain [Uplink]	-
Nominal Gain [Downlink]	<ul style="list-style-type: none"> Band 5/CELL 850: 31 dB Band 25/PCS 1900: 35 dB Band 27/CELL 800: 31 dB Band 66/AWS 1700E (partly): 35 dB Band IMT 2600: 36 dB

The main components of the EUT are listed and described in chapter 3.2 EUT Main components.



3.2 EUT MAIN COMPONENTS

Sample Name	FCC-ID	ISED-ID
	XS5-CAPM8171926	2237E-CAPM8171926
Sample Parameter	Value	
Serial Number	FICMHA2030001	
HW Version	7840984-0001 Rev.: 00	
SW Version	2.9.0.229	
Comment	-----	

NOTE: The short description is used to simplify the identification of the EUT in this test report.

3.3 ANCILLARY EQUIPMENT

For the purposes of this test report, ancillary equipment is defined as equipment which is used in conjunction with the EUT to provide operational and control features to the EUT. It is necessary to configure the system in a typical fashion, as a customer would normally use it. But nevertheless Ancillary Equipment can influence the test results.

Device	Details (Manufacturer, Type Model, OUT Code)	Description
-	-	-



3.4 AUXILIARY EQUIPMENT

For the purposes of this test report, auxiliary equipment is defined as equipment which is used temporarily to enable operational and control features especially used for the tests of the EUT which is not used during normal operation or equipment that is used during the tests in combination with the EUT but is not subject of this test report. It is necessary to configure the system in a typical fashion, as a customer would normally use it. But nevertheless Auxiliary Equipment can influence the test results.

Device	Details (Manufacturer; Type; S/N)	Description
AUX1	Commscope/General Electric; ION-E PSU Shelf, AC; n. a.	Rack in Conjunction with AUX 2
AUX2	Commscope/General Electric; Power Supply Unit CAR1212FPBC-Z; DF36545	Power Supply
AUX3	Commscope; ION-E WCS-2; SZAEAJ1914A0054	Subrack in Conjunction with AUX 4, 5,6 and 7
AUX4	Commscope; ION-E OPT; SZBEAD1912A0052	Optical Card
AUX5	Commscope; ION-E SUI; SZBEAC1913A0041	LAN System Interface
AUX6	Commscope; ION-E RFD; SZBEAG1814A0004	RF Card
AUX7	Commscope; ION-E RFD; SZBEAP1912A0087	RF Card

3.5 EUT SETUPS

This chapter describes the combination of EUTs and equipment used for testing. The rationale for selecting the EUTs, ancillary and auxiliary equipment and interconnecting cables, is to test a representative configuration meeting the requirements of the referenced standards.

Setup	Combination of EUTs	Description and Rationale
		Setup for all tests

OPERATING MODES

This chapter describes the operating modes of the EUT used for testing.

3.5.1 TEST CHANNELS

Band	Direction	Lower Frequency Band Edge [MHz]	Upper Frequency Band Edge [MHz]	Center Frequency [MHz]	Port
IMT 2600	Downlink	2620.00	2690.00	2655.00	Donor

3.5.2 AUTOMATIC GAIN CONTROL LEVELS

AGC Levels							
Band	Direction	Signal Type	AGC Start Pin [dBm]	AGC Start Pin -0.3 dB [dBm]	AGC Start Pin +3 dB [dBm]	Frequency [MHz]	Frequency
IMT 2600	Downlink	Narrowband	-2.4	-2.7	0.6	2655.00	Mid
IMT 2600	Downlink	Wideband	-2.4	-2.7	0.6	2655.00	
IMT 2600	Downlink	Narrowband	-1.4	-1.7	1.6	2620.20	Low
IMT 2600	Downlink	Wideband	-1.2	-1.5	1.8	2622.50	
IMT 2600	Downlink	Narrowband	-1.8	-2.1	1.2	2689.80	High
IMT 2600	Downlink	Wideband	-2.0	-2.3	1.0	2687.50	
IMT 2600	Downlink	Narrowband	-2.4	-2.7	0.6	2646.10	Max.Power
IMT 2600	Downlink	Wideband	-2.2	-2.5	0.8	2646.10	

Remark:

If the measured frequency f_0 for the max power has a too low distance to the band edges, because in the tests modulated signals must be used: The next possible frequency to the according band edge is used.

For example for minimum distances to the band edges:

GSM-Signal (narrowband): 0.2 MHz

AWGN-signal (wideband): 2.5 MHz



ECL-TA-20-013-V01.00

TA tests on Andrew CAP M 80-85/17E/19/26 F-AC

3.6 PRODUCT LABELLING

3.6.1 FCC ID LABEL

Please refer to the documentation of the applicant.

3.6.2 LOCATION OF THE LABEL ON THE EUT

Please refer to the documentation of the applicant.

4 TEST RESULTS

4.1 EFFECTIVE RADIATED POWER; MEAN OUTPUT POWER AND ZONE ENHANCER GAIN

Standard FCC PART 27, § 27.50

The test was performed according to:
ANSI C63.26, KDB 935210 D05 v01r04: 3.5

Test date: 2020-09-14

Environmental conditions: 24 ° C; 43 % r. F.

Test engineer: Thomas Hufnagel

4.1.1 TEST DESCRIPTION

This test case is intended to demonstrate compliance to the signal booster power and gain limits and requirements for industrial signal boosters per FCC § 27.50, RSS-199 with subpart 4.4 and SRSP-517 with subpart 5.1.1.

The EUT was connected to the test setup according to the following diagram:

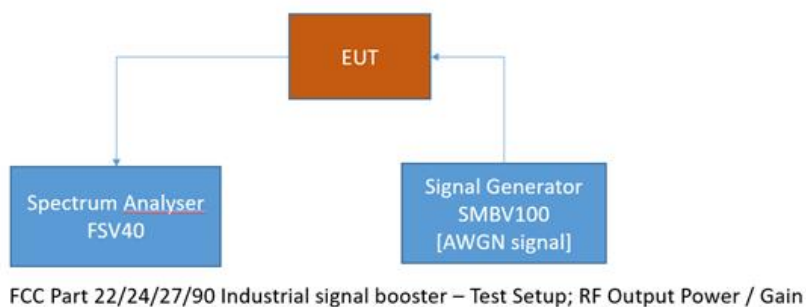

The attenuation of the measuring and stimulus path are known for each measured frequency and are considered.

The Spectrum Analyzer settings can be directly found in the measurement diagrams.



4.1.2 TEST REQUIREMENTS/LIMITS: ABSTRACTS FROM STANDARDS

Part 27; Miscellaneous Wireless Communication Services

Subpart C – Technical standards

§ 27.50

Abstract § 27.50 from FCC:

(h) The following power limits shall apply in the BRS and EBS:

(1) *Main, booster and base stations.* (i) The maximum EIRP of a main, booster or base station shall not exceed $33 \text{ dBW} + 10\log(X/Y) \text{ dBW}$, where X is the actual channel width in MHz and Y is either 6 MHz if prior to transition or the station is in the MBS following transition or 5.5 MHz if the station is in the LBS and UBS following transition, except as provided in paragraph (h)(1)(ii) of this section.

(ii) If a main or booster station sectorizes or otherwise uses one or more transmitting antennas with a non-omnidirectional horizontal plane radiation pattern, the maximum EIRP in dBW in a given direction shall be determined by the following formula: $\text{EIRP} = 33 \text{ dBW} + 10 \log(X/Y) \text{ dBW} + 10 \log(360/\text{beamwidth}) \text{ dBW}$, where X is the actual channel width in MHz, Y is either (i) 6 MHz if prior to transition or the station is in the MBS following transition or (ii) 5.5 MHz if the station is in the LBS and UBS following transition, and beamwidth is the total horizontal plane beamwidth of the individual transmitting antenna for the station or any sector measured at the half-power points.



Abstract RSS-199 from ISED:

RSS-199; 4.4 Transmitter output power and equivalent isotropically radiated power (e.i.r.p.)

The transmitter output power shall be measured in terms of average value.

For base station equipment, refer to SRSP-517 for the maximum permissible e.i.r.p.

Abstract SRSP-517 from ISED:

SRSP-517; 5.1 Radiated Power Limits and Antenna Height Limit

5.1.1 Fixed and Base Stations

Fixed and base stations (except fixed subscriber stations) are limited to a maximum permissible equivalent isotropically radiated power (e.i.r.p.) of 1640 W/MHz (i.e. no more than 1640 W e.i.r.p. in any 1 MHz band segment) with an antenna height above average terrain (HAAT) up to 300 metres. For all installations with antenna HAAT in excess of 300 metres, a corresponding reduction in e.i.r.p. according to Table 2 shall be applied.

Table 2 — Reduction to Maximum Allowable E.I.R.P. for HAAT > 300 m

HAAT (m)	Reduction in maximum e.i.r.p. (dB)
$300 < \text{HAAT} \leq 500$	2
$500 < \text{HAAT} \leq 1000$	5
$1000 < \text{HAAT} \leq 1500$	8
$1500 < \text{HAAT} \leq 2000$	10

4.1.3 TEST PROTOCOL

IMT 2600, downlink,							
Signal Type	Input Power	Frequency [MHz]	Input Power [dBm]	Maximum Average Output Power [dBm]	Limit Average Output Power [dBm]	Margin to Limit [dB]	Gain [dB]
Wideband	0.3 dB < AGC	2646,10	-2.5	31.7	62.1	30.4	34.2
Wideband	3 dB > AGC	2646,10	0.8	30.9	62.1	31.2	30.1
Narrowband	0.3 dB < AGC	2646,10	-2.7	31.8	51.6	19.9	34.5
Narrowband	3 dB > AGC	2646,10	0.6	31.2	51.6	20.4	30.6

Remarks: Please see next sub-clause for the measurement plot.



4.1.4 MEASUREMENT PLOT

Band: IMT2600; Frequency: 2.6461 GHz; Band Edge: f0; Mod: AWGN; Output Power 0.3 dB < AGC

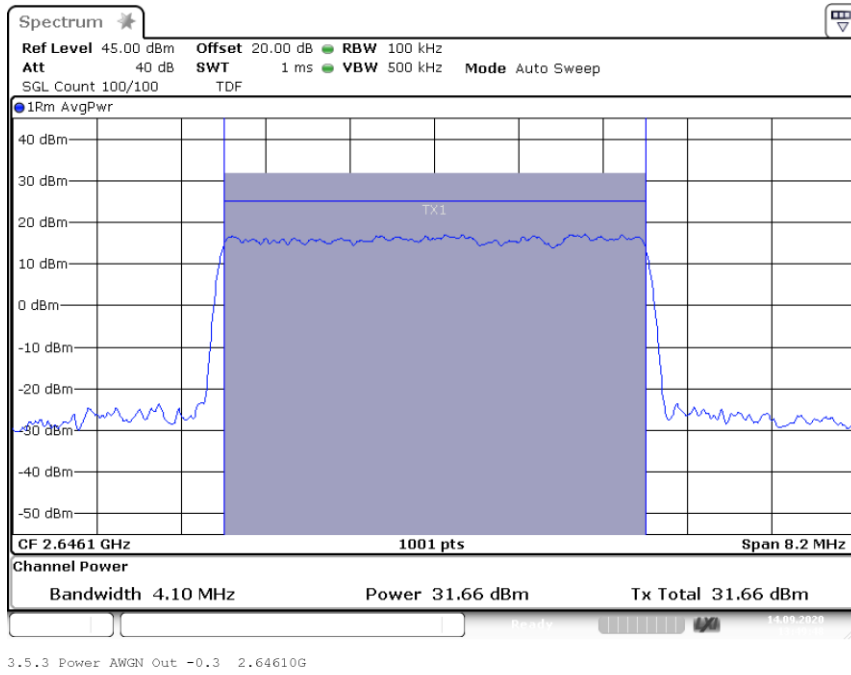

Band: IMT2600; Frequency: 2.6461 GHz; Band Edge: f0; Mod: AWGN; Output Power 3 dB > AGC

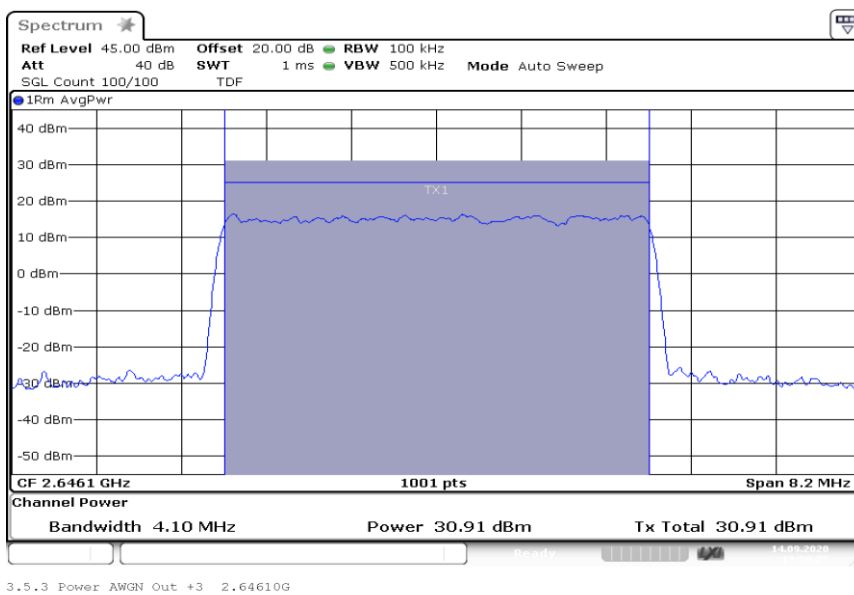



Band: IMT2600; Frequency: 2.6461 GHz; Band Edge: f0; Mod: GSM; Output Power 0.3 dB < AGC

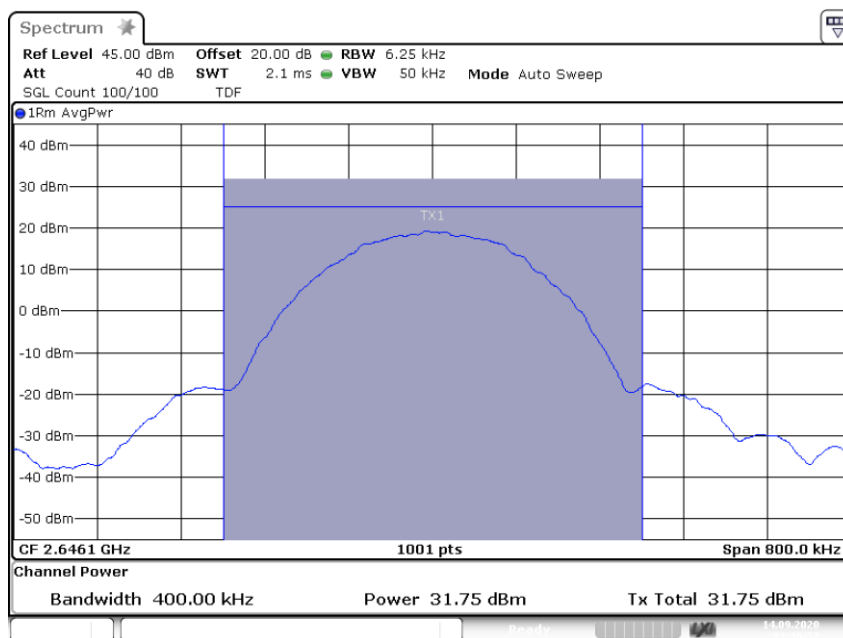

3.5.3 Power GSM Out -0.3 2.64610G

Band: IMT2600; Frequency: 2.6461 GHz; Band Edge: f0; Mod: GSM; Output Power 3 dB > AGC

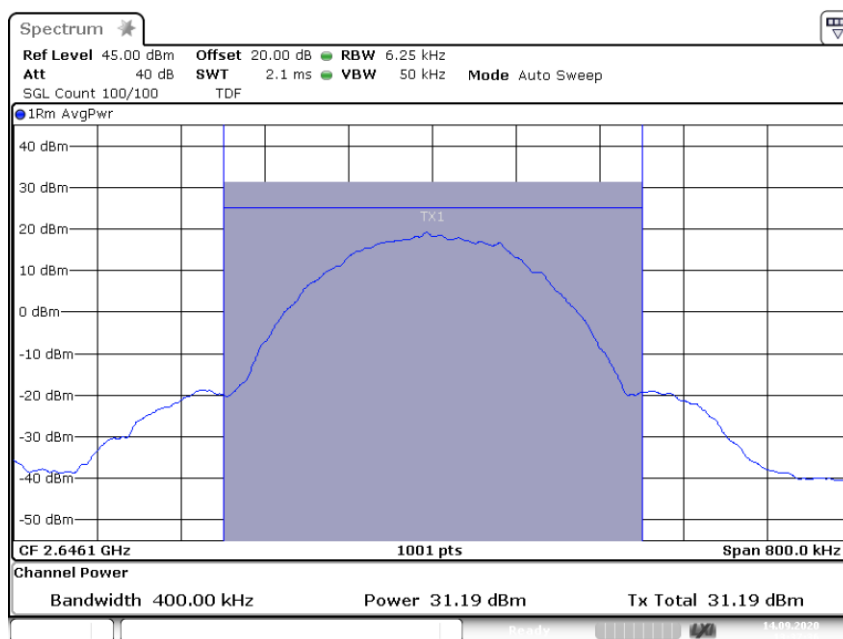

3.5.3 Power GSM Out +3 2.64610G

4.1.5 TEST EQUIPMENT USED

- Conducted

4.2 PEAK TO AVERAGE RATIO

Standard FCC PART 27, § 27.50

The test was performed according to:
ANSI C63.26

Test date: 2020-09-14

Environmental conditions: 24 ° C; 43 % r. F.

Test engineer: Thomas Hufnagel

4.2.1 TEST DESCRIPTION

This test case is intended to demonstrate compliance to the signal booster power and gain limits and requirements for industrial signal boosters per FCC § 27.50 and RSS-199 with subpart 4.4.

The EUT was connected to the test setup according to the following diagram:

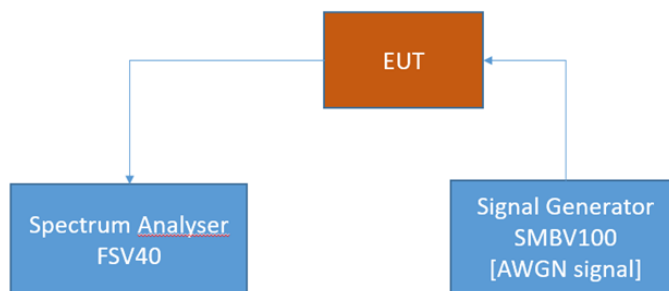

FCC Part 22/24/27/90 Industrial signal booster – Test Setup; RF Output Power / Gain

The attenuation of the measuring and stimulus path are known for each measured frequency and are considered.

The Spectrum Analyzer settings can be directly found in the measurement diagrams.



4.2.2 TEST REQUIREMENTS/LIMITS

Part 27; Miscellaneous Wireless Communication Services

Subpart C – Technical standards

§ 27.50

For the BRS band exists no FCC peak-to-average power ratio (PAPR) limit, therefore the same limit as in RSS-199 is taken.

Abstract RSS-199 from ISED:

RSS-199; 4.4 Transmitter output power and equivalent isotropically radiated power (e.i.r.p.)

In addition, the peak-to-average power ratio (PAPR) of the transmitter shall not exceed 13 dB for more than 0.1% of the time and shall use a signal corresponding to the highest PAPR during periods of continuous transmission.



4.2.3 TEST PROTOCOL

IMT 2600, downlink						
Signal Type	Input Power	Frequency [MHz]	Input Power [dBm]	PAPR [dB]	Limit PAPR [dB]	Margin to Fictive Limit [dB]
Wideband	0.3 dB < AGC	2646.10	-2.5	9.0	13.0	4.0
Wideband	3 dB > AGC	2646.10	0.8	9.1	13.0	3.9
Narrowband	0.3 dB < AGC	2655.00	-2.7	0.2	13.0	12.8
Narrowband	3 dB > AGC	2655.00	0.6	0.2	13.0	12.8

Remark: Please see next sub-clause for the measurement plot.



4.2.4 MEASUREMENT PLOT (SHOWING THE HIGHEST VALUE, "WORST CASE")

Band: IMT2600; Frequency: 2.6461 GHz; Band Edge: f0; Mod: AWGN; PAPR 0.3 dB < AGC

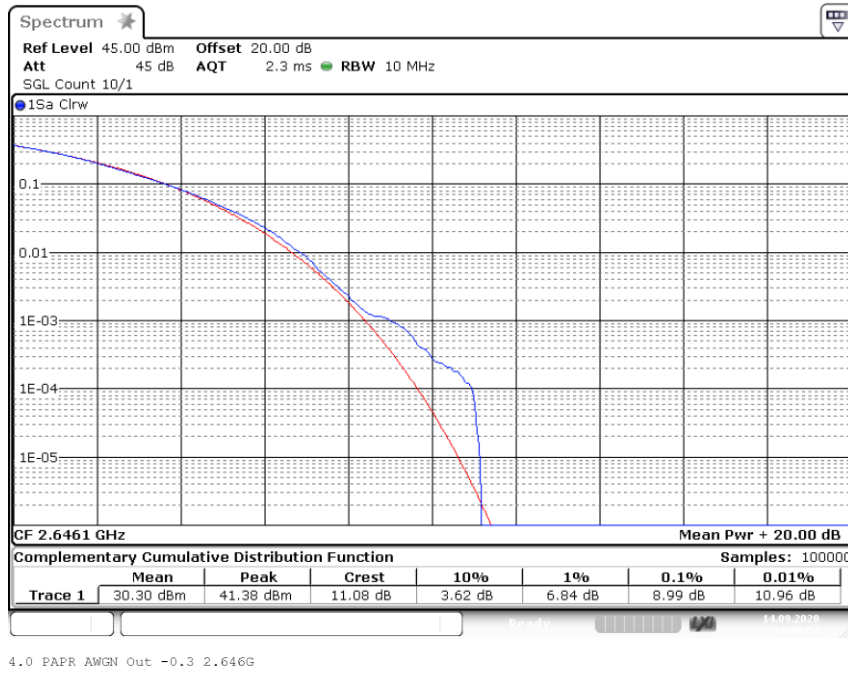

Band: IMT2600; Frequency: 2.6461 GHz; Band Edge: f0; Mod: AWGN; PAPR 3 dB > AGC

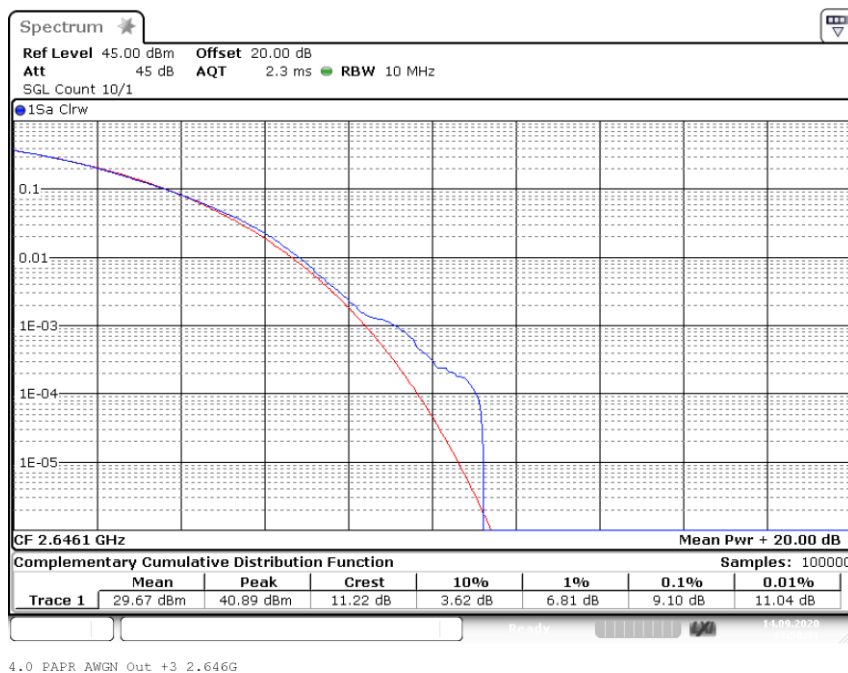



Band: IMT2600; Frequency: 2.6550 GHz; Band Edge: mid; Mod: GSM; PAPR 0.3 dB < AGC

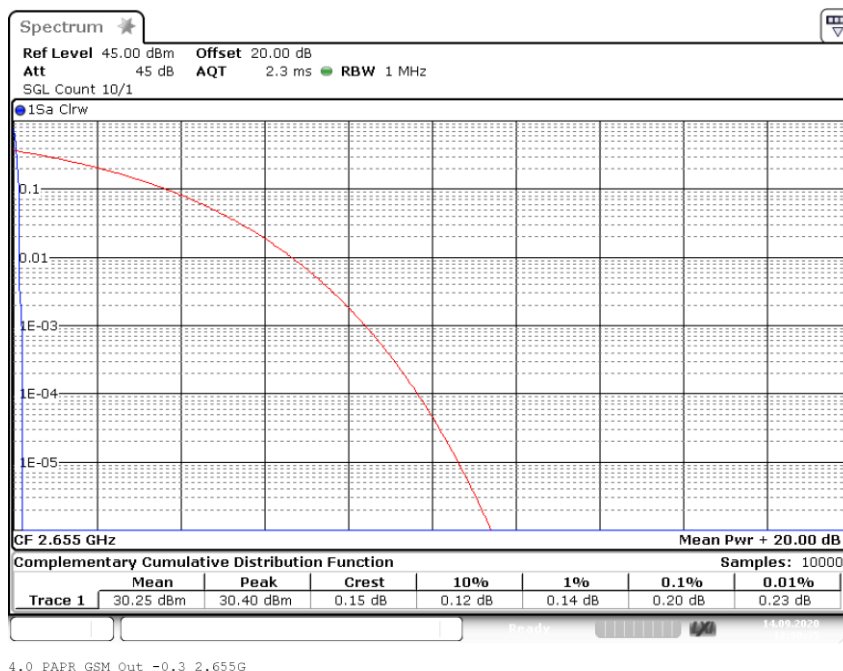

Band: IMT2600; Frequency: 2.6550 GHz; Band Edge: mid; Mod: GSM; PAPR 3 dB > AGC

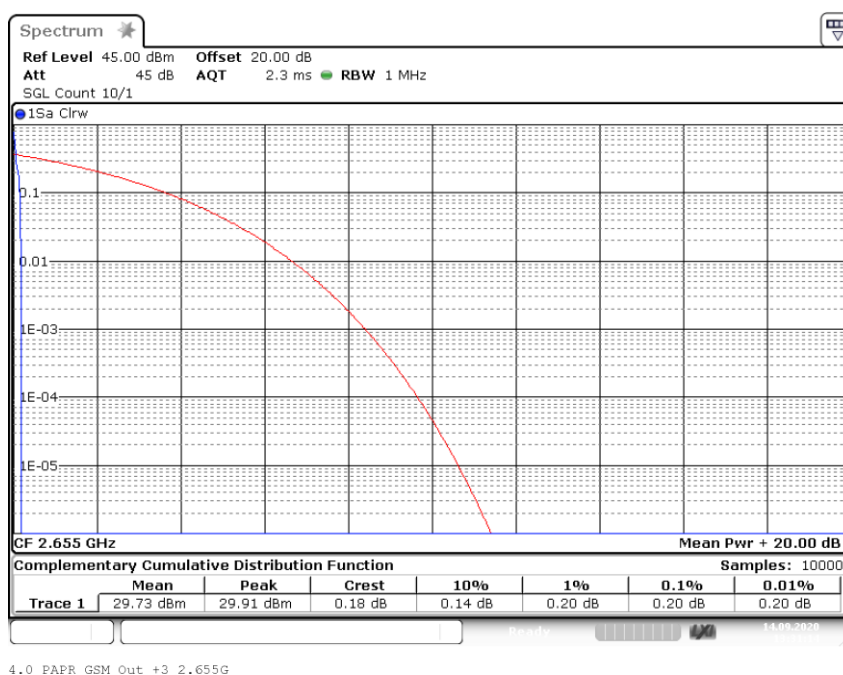

4.2.5 TEST EQUIPMENT USED

- Conducted

4.3 OCCUPIED BANDWIDTH/INPUT-VERSUS-OUTPUT SPECTRUM

Standard FCC Part 2.1049; Occupied Bandwidth

The test was performed according to:
ANSI C63.26, KDB 935210 D05 v01r04: 3.4

Test date: 2020-09-14

Environmental conditions: 24 ° C; 43 % r. F.

Test engineer: Thomas Hufnagel

4.3.1 TEST DESCRIPTION

This test case is intended to demonstrate compliance to the applicable conducted spurious emission limits per FCC § 2.1049, RSS-GEN with subpart 6.7 and RSS-131 with subpart 5.2.2

The EUT was connected to the test setups according to the following diagram:

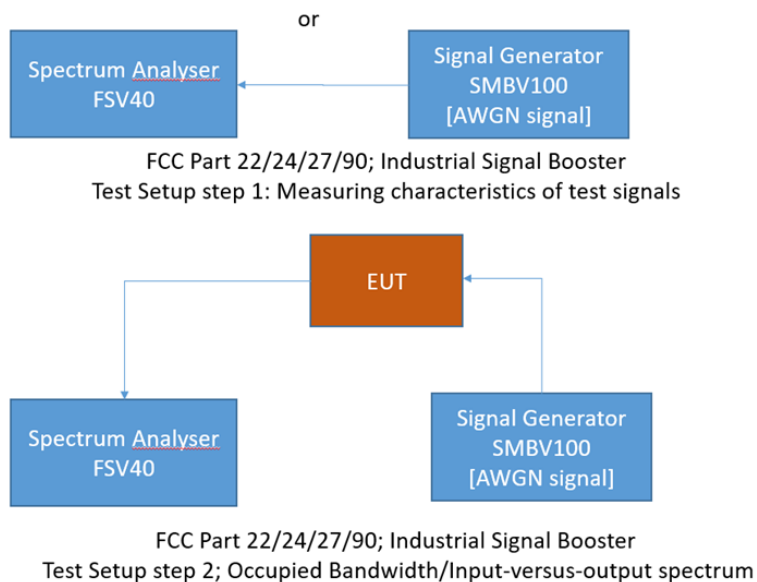

The attenuation of the measuring and stimulus path are known for each measured frequency and are considered.

The Spectrum Analyzer settings can be directly found in the measurement diagrams.



4.3.2 TEST REQUIREMENTS/LIMITS

Abstract § 2.1049 from FCC:

FCC Part 2.1049; Occupied Bandwidth:

The occupied bandwidth, that is the frequency bandwidth such that, below its lower and above its upper frequency limits, the mean powers radiated are each equal to 0.3 percent of the total mean power radiated by a given emission shall be measured under the following conditions as applicable:

(h) Transmitters employing digital modulation techniques—when modulated by an input signal such that its amplitude and symbol rate represent the maximum rated conditions under which the equipment will be operated. The signal shall be applied through any filter networks, pseudo-random generators or other devices required in normal service. Additionally, the occupied bandwidth shall be shown for operation with any devices used for modifying the spectrum when such devices are optional at the discretion of the user.

(i) Transmitters designed for other types of modulation—when modulated by an appropriate signal of sufficient amplitude to be representative of the type of service in which used. A description of the input signal should be supplied.

Abstract RSS-GEN from ISED:

RSS-GEN; 6.7 Occupied Bandwidth

The occupied bandwidth or the “99% emission bandwidth” is defined as the frequency range between two points, one above and the other below the carrier frequency, within which 99% of the total transmitted power of the fundamental transmitted emission is contained. The occupied bandwidth shall be reported for all equipment in addition to the specified bandwidth required in the applicable RSSs.

In some cases, the “x dB bandwidth” is required, which is defined as the frequency range between two points, one at the lowest frequency below and one at the highest frequency above the carrier frequency, at which the maximum power level of the transmitted emission is attenuated x dB below the maximum in-band power level of the modulated signal, where the two points are on the outskirts of the in-band emission.

The following conditions shall be observed for measuring the occupied bandwidth and x dB bandwidth:

- The transmitter shall be operated at its maximum carrier power measured under normal test conditions.
- The span of the spectrum analyzer shall be set large enough to capture all products of the modulation process, including the emission skirts, around the carrier frequency, but small enough to avoid having other emissions (e.g. on adjacent channels) within the span.



- The detector of the spectrum analyzer shall be set to "Sample". However, a peak, or peak hold, may be used in place of the sampling detector since this usually produces a wider bandwidth than the actual bandwidth (worst-case measurement). Use of a peak hold (or "Max Hold") may be necessary to determine the occupied / x dB bandwidth if the device is not transmitting continuously.
- The resolution bandwidth (RBW) shall be in the range of 1% to 5% of the actual occupied / x dB bandwidth and the video bandwidth (VBW) shall not be smaller than three times the RBW value. Video averaging is not permitted.

For the 99% emission bandwidth, the trace data points are recovered and directly summed in linear power level terms. The recovered amplitude data points, beginning at the lowest frequency, are placed in a running sum until 0.5% of the total is reached, and that frequency recorded. The process is repeated for the highest frequency data points (starting at the highest frequency, at the right side of the span, and going down in frequency). This frequency is then recorded. The difference between the two recorded frequencies is the occupied bandwidth (or the 99% emission bandwidth).

Abstract RSS-131 from ISED:

RSS-131; 5.2.2 Input-versus-output spectrum

The spectral growth of the 26 dB bandwidth of the output signal shall be less than 5% of the input signal spectrum.

4.3.3 TEST PROTOCOL

IMT 2600, downlink							
Signal Type	Input Power	Signal Frequency [MHz]	Occupied Bandwidth SG [kHz]	Occupied Bandwidth Booster [kHz]	Delta Occupied Bandwidth [kHz]	Limit Delta Occupied Bandwidth [kHz]	Margin to Limit [kHz]
Wideband	0.3 dB < AGC	2655.00	4336.5	4335.3	1.2	205.0	203.8
Wideband	3 dB > AGC	2655.00	4334.1	4336.5	2.4	205.0	202.6
Narrowband	0.3 dB < AGC	2655.00	315.6	317.1	1.6	10.0	8.4
Narrowband	3 dB > AGC	2655.00	316.7	318.2	1.6	10.0	8.4

Remark: Please see next sub-clause for the measurement plot.



4.3.4 MEASUREMENT PLOT

Band: IMT2600; Frequency: 2.6550 GHz; Band Edge: mid; Mod: AWGN; OCBw 0.3 dB < AGC

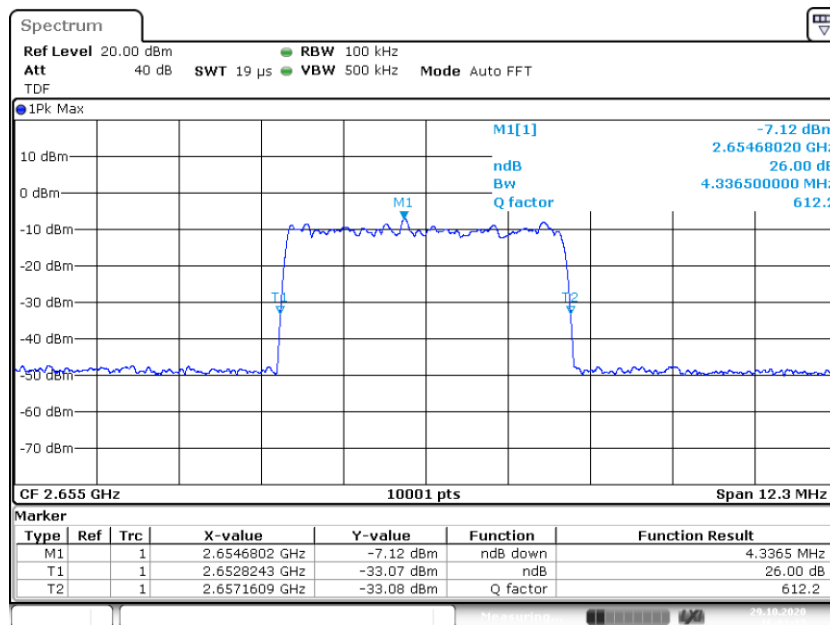

3.4 OCBw AWGN In -0.3 2.6550G _26dB

Input Signal

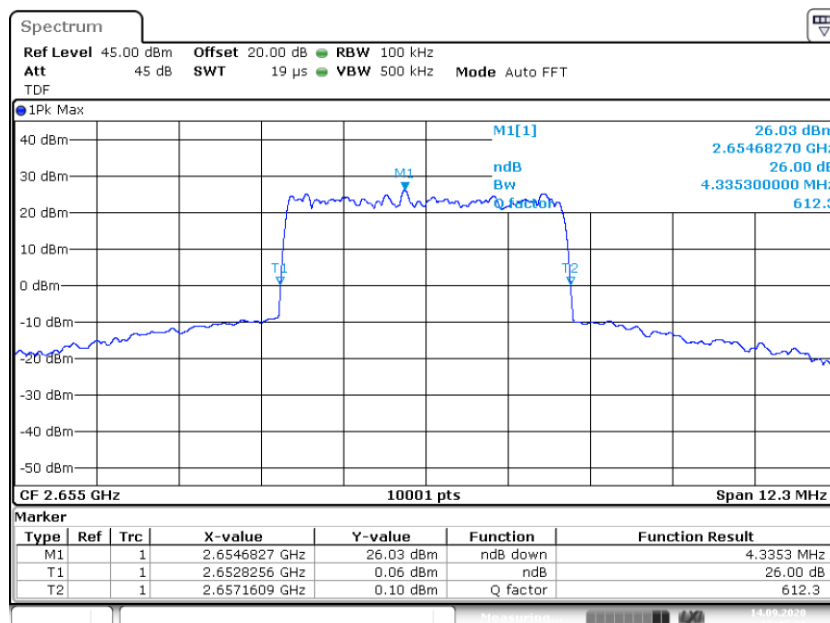

3.4 OCBw AWGN Out -0.3 2.6550G _26dB

Output Signal



Band: IMT2600; Frequency: 2.6550 GHz; Band Edge: mid; Mod: AWGN; OCBw 3 dB > AGC

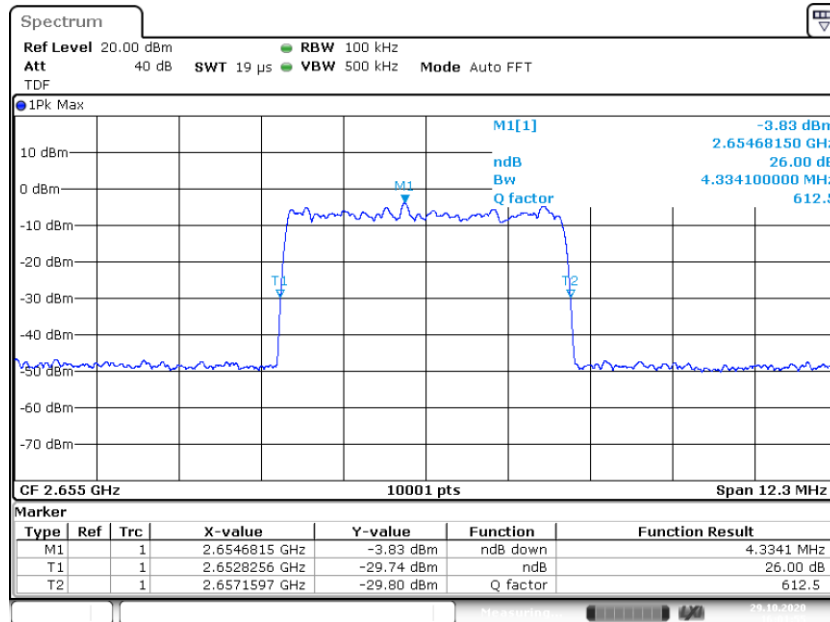

3.4 OCBw AWGN In +3 2.6550G _26dB

Input Signal

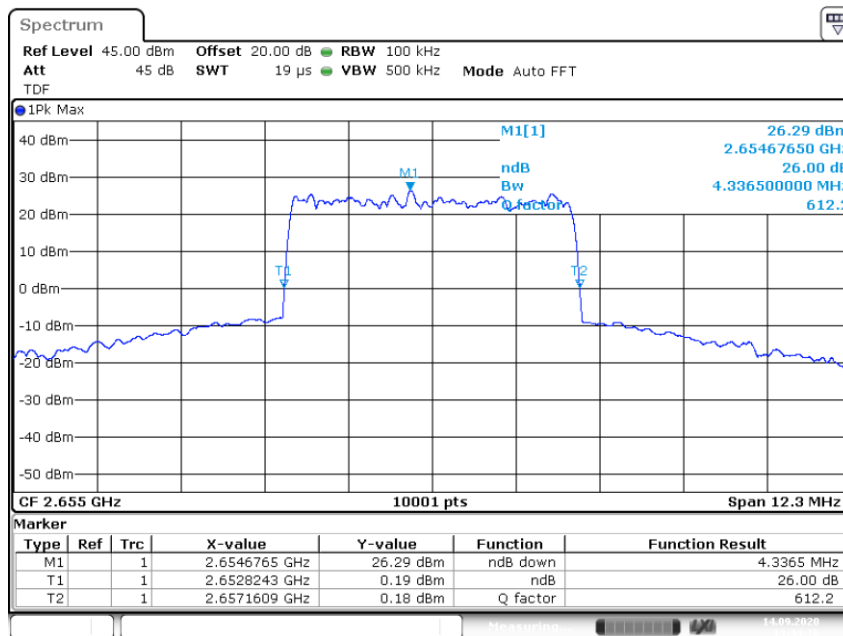

3.4 OCBw AWGN Out +3 2.6550G _26dB

Output Signal



Band: IMT2600; Frequency: 2.6550 GHz; Band Edge: mid; Mod: GSM; OCBw 0.3 dB < AGC

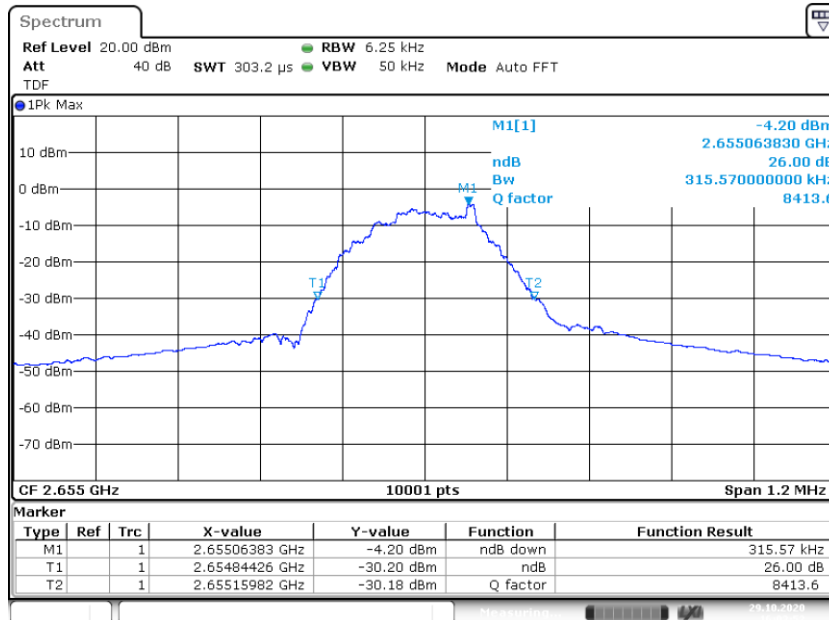

3.4 OCBw GSM In -0.3 2.6550G _26dB

Input Signal

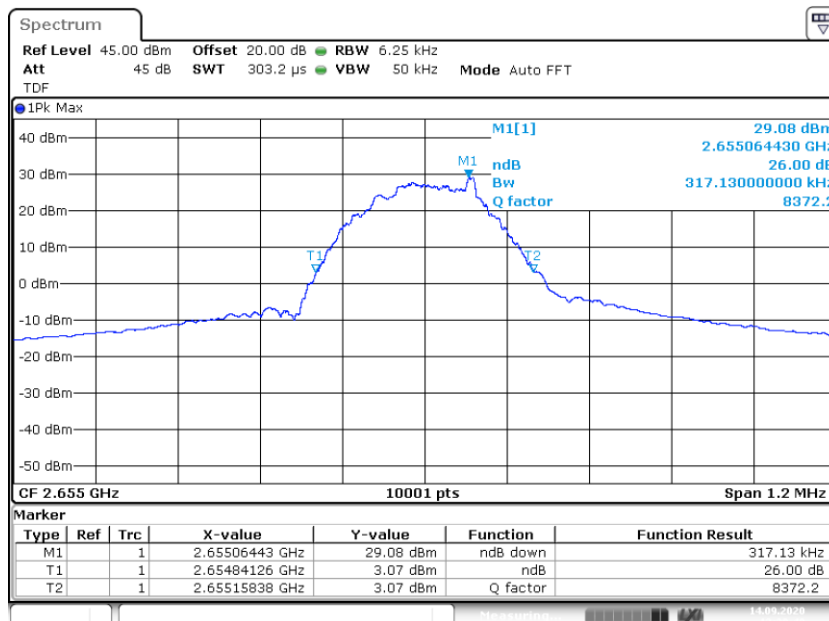

3.4 OCBw GSM Out -0.3 2.6550G _26dB

Output Signal



Band: IMT2600; Frequency: 2.6550 GHz; Band Edge: mid; Mod: GSM; OCBw 3 dB > AGC

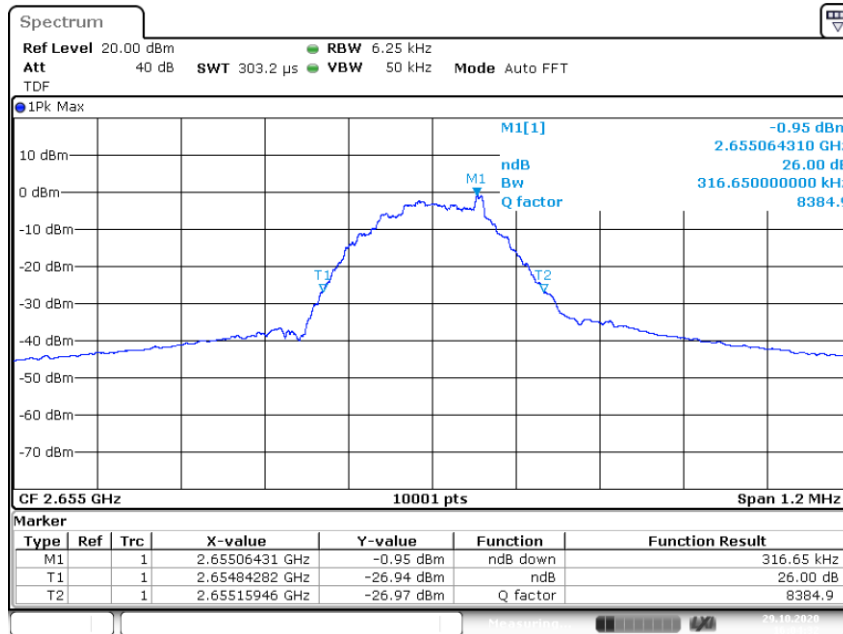

3.4 OCBw GSM In +3 2.6550G _26dB

Input Signal

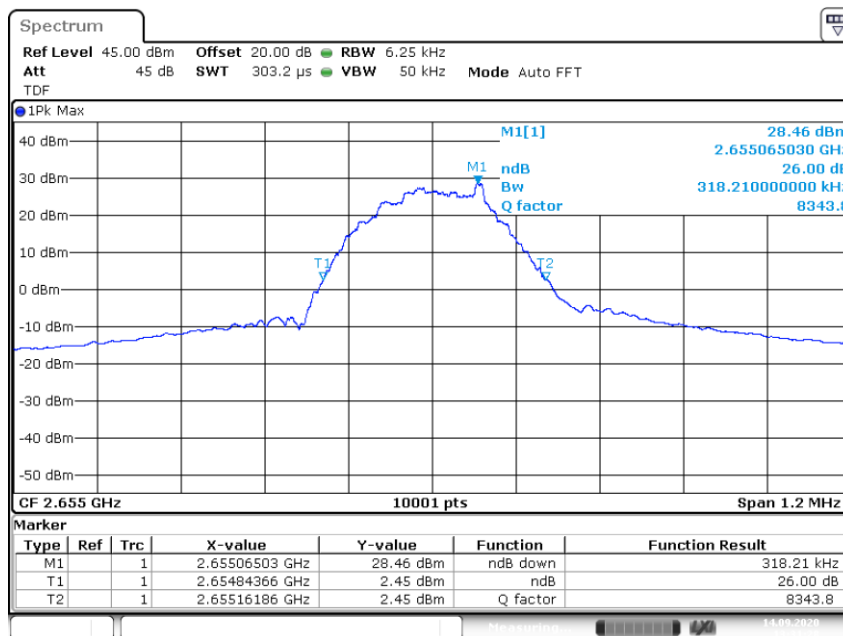

3.4 OCBw GSM Out +3 2.6550G _26dB

4.3.5 TEST EQUIPMENT USED

- Conducted

4.4 CONDUCTED SPURIOUS EMISSIONS AT ANTENNA TERMINALS

Standard FCC Part § 2.1051, § 27.53

The test was performed according to:
ANSI C63.26, KDB 935210 D05 v01r04: 3.6

Test date: 2020-09-17

Environmental conditions: 24 ° C; 43 % r. F.

Test engineer: Thomas Hufnagel

4.4.1 TEST DESCRIPTION

This test case is intended to demonstrate compliance to the signal booster power and gain limits and requirements for industrial signal boosters per FCC § 2.1051, FCC § 27.53, RSS-GEN with subpart 6.13 and RSS-199 with subpart 4.5.

The EUT was connected to the test setup according to the following diagram:

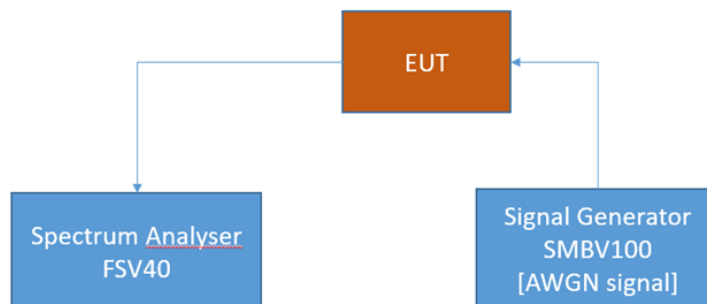

FCC Part 22/24/27/90 Industrial signal booster – Test Setup; RF Output Power / Gain

The attenuation of the measuring and stimulus path are known for each measured frequency and are considered.

The Spectrum Analyzer settings can be directly found in the measurement diagrams.



4.4.2 TEST REQUIREMENTS/LIMITS

Abstract § 2.1051 from FCC:

FCC Part 2.1051; Measurement required: Spurious emissions at antenna terminal:

The radio frequency voltage or powers generated within the equipment and appearing on a spurious frequency shall be checked at the equipment output terminals when properly loaded with a suitable artificial antenna. Curves or equivalent data shall show the magnitude of each harmonic and other spurious emission that can be detected when the equipment is operated under the conditions specified in § 2.1049 as appropriate. The magnitude of spurious emissions which are attenuated more than 20 dB below the permissible value need not be specified.

Part 27; Miscellaneous Wireless Communication Services

Subpart C – Technical standards

§27.53 – Emission limits

Abstract § 27.53 FCC:

(m) For BRS and EBS stations, the power of any emissions outside the licensee's frequency bands of operation shall be attenuated below the transmitter power (P) measured in watts in accordance with the standards below. If a licensee has multiple contiguous channels, out-of-band emissions shall be measured from the upper and lower edges of the contiguous channels.

(1) Prior to the transition, and thereafter, solely within the MBS, for analog operations with an EIRP in excess of -9 dBW, the signal shall be attenuated at the channel edges by at least 38 dB relative to the peak visual carrier, then linearly sloping from that level to at least 60 dB of attenuation at 1 MHz below the lower band edge and 0.5 MHz above the upper band edge, and attenuated at least 60 dB at all other frequencies.

(2) For digital base stations, the attenuation shall be not less than $43 + 10 \log (P)$ dB, unless a documented interference complaint is received from an adjacent channel licensee with an overlapping Geographic Service Area. Mobile Satellite Service licensees operating on frequencies below 2495 MHz may also submit a documented interference complaint against BRS licensees operating on channel BRS No. 1 on the same terms and conditions as adjacent channel BRS or EBS licensees.

Abstract RSS-199 from ISED:**RSS-199; 4.5 Transmitter unwanted emissions**

In the 1 MHz band immediately outside and adjacent to the channel edge, the unwanted emission power shall be measured with a resolution bandwidth of at least 1% of the occupied bandwidth for base station and fixed subscriber equipment, and 2% for mobile subscriber equipment. Beyond the 1 MHz band, a resolution bandwidth of 1 MHz shall be used. A narrower resolution bandwidth can be used, provided that the measured power is integrated over the full required measurement bandwidth of 1 MHz, or 1% or 2% of the occupied bandwidth, as applicable.

Equipment shall comply with the following unwanted emission limits:

(a) for base station and fixed subscriber equipment, the power of any unwanted emissions measured as above shall be attenuated (in dB) below the transmitter power, P (dBW), by at least $43 + 10 \log_{10} p$.

- (i) $40 + 10 \log_{10} p$ from the channel edges to 5 MHz away
- (ii) $43 + 10 \log_{10} p$ between 5 MHz and X MHz from the channel edges, and
- (iii) $55 + 10 \log_{10} p$ at X MHz and beyond from the channel edges.

In addition, the attenuation shall not be less than $43 + 10 \log_{10} p$ on all frequencies between 2490.5 MHz and 2496 MHz, and $55 + 10 \log_{10} p$ at or below 2490.5 MHz. (b) for mobile subscriber equipment, the power of any unwanted emissions measured as above shall be attenuated (in dB) below the transmitter power, P (dBW), by at least:

In (a) and (b), p is the transmitter power measured in watts and X is 6 MHz or the equipment occupied bandwidth, whichever is greater.

4.4.3 TEST PROTOCOL

Band IMT 2600, downlink							
Test Frequency	Signal Type	Spurious Freq. [MHz]	Spurious Level [dBm]	Detector	RBW [kHz]	Limit [dBm]	Margin to Limit [dB]
low	Wideband	0,0094301	-60,5	RMS	1	-33	27,5
low	Wideband	0,0924929	-53,5	RMS	10	-23	30,5
low	Wideband	122,7151	-44,6	RMS	100	-13	31,6
low	Wideband	892,8572	-33,5	RMS	1000	-13	20,5
low	Wideband	2137,4	-30,8	RMS	1000	-13	17,8
low	Wideband	2618,9	-31,3	RMS	100	-13	18,3
low	Wideband	2694,8	-46,7	RMS	100	-13	33,7
low	Wideband	6878,0	-30,8	RMS	1000	-13	17,8
low	Wideband	19544,3	-30,7	RMS	1000	-13	17,7
low	Wideband	20304,2	-30,4	RMS	1000	-13	17,4
mid	Wideband	0,0192602	-60,6	RMS	1	-33	27,6
mid	Wideband	0,0874937	-52,9	RMS	10	-23	29,9
mid	Wideband	65,4212	-45,6	RMS	100	-13	32,6
mid	Wideband	889,8602	-34,6	RMS	1000	-13	21,6
mid	Wideband	2156,4	-31,1	RMS	1000	-13	18,1
mid	Wideband	2616,4	-46,0	RMS	100	-13	33,0
mid	Wideband	2691,1	-46,2	RMS	100	-13	33,2
mid	Wideband	6876,5	-31,1	RMS	1000	-13	18,1
mid	Wideband	19993,2	-30,9	RMS	1000	-13	17,9
mid	Wideband	20321,7	-29,9	RMS	1000	-13	16,9
high	Wideband	0,019506	-61,2	RMS	1	-33	28,2
high	Wideband	0,0524996	-54,6	RMS	10	-23	31,6
high	Wideband	120,4154	-45,2	RMS	100	-13	32,2
high	Wideband	891,3587	-34,3	RMS	1000	-13	21,3
high	Wideband	1939,5	-30,8	RMS	1000	-13	17,8
high	Wideband	2615,5	-46,2	RMS	100	-13	33,2
high	Wideband	2691,0	-31,5	RMS	100	-13	18,5
high	Wideband	6820,5	-31,2	RMS	1000	-13	18,2
high	Wideband	19676,3	-30,7	RMS	1000	-13	17,7
high	Wideband	20273,7	-30,3	RMS	1000	-13	17,3



Band IMT 2600, downlink							
Test Frequency	Signal Type	Spurious Freq. [MHz]	Spurious Level [dBm]	Detector	RBW [kHz]	Limit [dBm]	Margin to Limit [dB]
low	Narrowband	0.0107817	-61.2	RMS	1	-33	28.2
low	Narrowband	0.0924929	-55.2	RMS	10	-23	32.2
low	Narrowband	66.9211	-44.3	RMS	100	-13	31.3
low	Narrowband	891.8581	-32.1	RMS	1000	-13	19.1
low	Narrowband	2135.9	-31.0	RMS	1000	-13	18.0
low	Narrowband	2619.0	-45.6	RMS	100	-13	32.6
low	Narrowband	2697.4	-45.6	RMS	100	-13	32.6
low	Narrowband	6845.5	-30.8	RMS	1000	-13	17.8
low	Narrowband	19987.8	-30.7	RMS	1000	-13	17.7
low	Narrowband	20298.2	-30.1	RMS	1000	-13	17.1
mid	Narrowband	0.0091024	-60.2	RMS	1	-33	27.2
mid	Narrowband	0.1624812	-54.9	RMS	10	-23	31.9
mid	Narrowband	309.8452	-45.5	RMS	100	-13	32.5
mid	Narrowband	890.8591	-34.5	RMS	1000	-13	21.5
mid	Narrowband	2127.4	-31.2	RMS	1000	-13	18.2
mid	Narrowband	2613.1	-46.4	RMS	100	-13	33.4
mid	Narrowband	2692.4	-46.7	RMS	100	-13	33.7
mid	Narrowband	6883.0	-30.9	RMS	1000	-13	17.9
mid	Narrowband	19602.8	-30.8	RMS	1000	-13	17.8
mid	Narrowband	20281.2	-30.2	RMS	1000	-13	17.2
high	Narrowband	0.0090205	-59.9	RMS	1	-33	26.9
high	Narrowband	0.1224879	-55.5	RMS	10	-23	32.5
high	Narrowband	121.7152	-45.7	RMS	100	-13	32.7
high	Narrowband	848.9011	-33.6	RMS	1000	-13	20.6
high	Narrowband	1957.0	-30.6	RMS	1000	-13	17.6
high	Narrowband	2612.8	-45.4	RMS	100	-13	32.4
high	Narrowband	2691.0	-45.5	RMS	100	-13	32.5
high	Narrowband	6963.0	-31.2	RMS	1000	-13	18.2
high	Narrowband	19551.8	-30.7	RMS	1000	-13	17.7
high	Narrowband	20364.7	-30.0	RMS	1000	-13	17.0



Remark: Please see next sub-clause for the measurement plot.

General considerations concerning the measurement plots:

The measuring bandwidth of 100 kHz was chosen according the test requirements except at the band edges: At the band edges reducing of measurement bandwidth was necessary to prevent overlaying the RF-signal over the spurious emissions.

Also outside the downlink frequency band at lower frequencies the measurement bandwidths were reduced to have the possibility to record the spurious emissions at these lower frequencies.

At frequencies where measuring bandwidths were reduced also the border lines were reduced according the given formula:

$$p_{RBWreduced} [dBm] = 10 * \log \left(RBWreduced [kHz] - 100 \text{ kHz} \right) + p_{RBW 100 \text{ kHz}} [dBm]$$

Hereby "p" are the border lines' values.

4.4.4 MEASUREMENT PLOT (SHOWING THE HIGHEST VALUE, "WORST CASE")

Frequency Band = IMT 2600, Test Frequency = low, Direction = RF downlink, Signal Type = AWGN

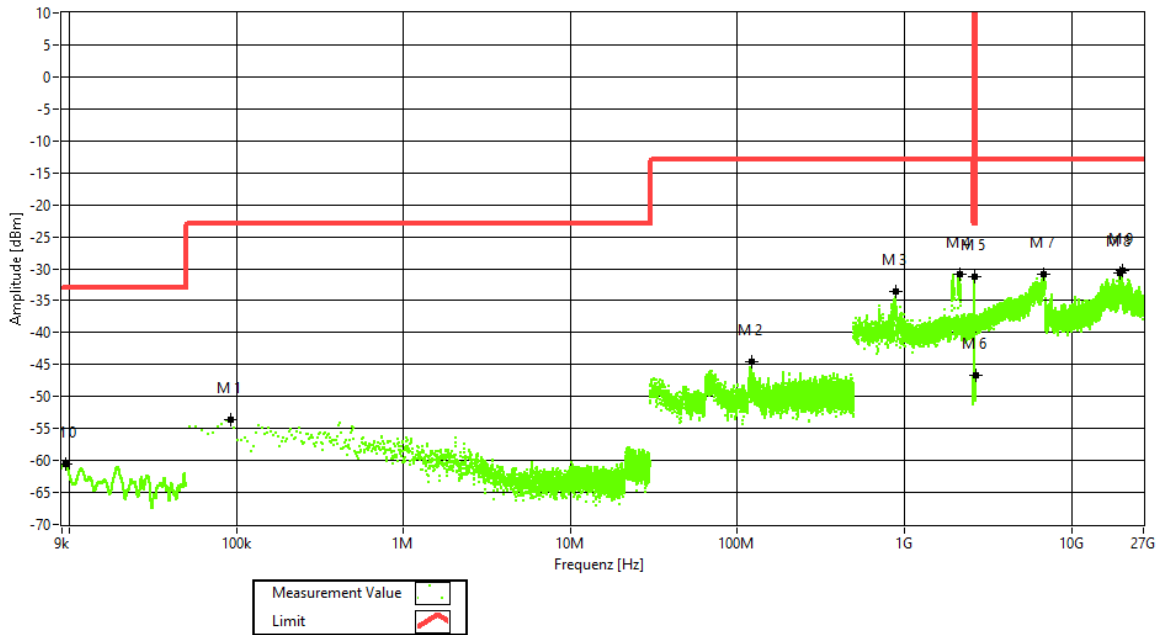

Frequency Band = IMT 2600, Test Frequency = mid, Direction = RF downlink, Signal Type = AWGN

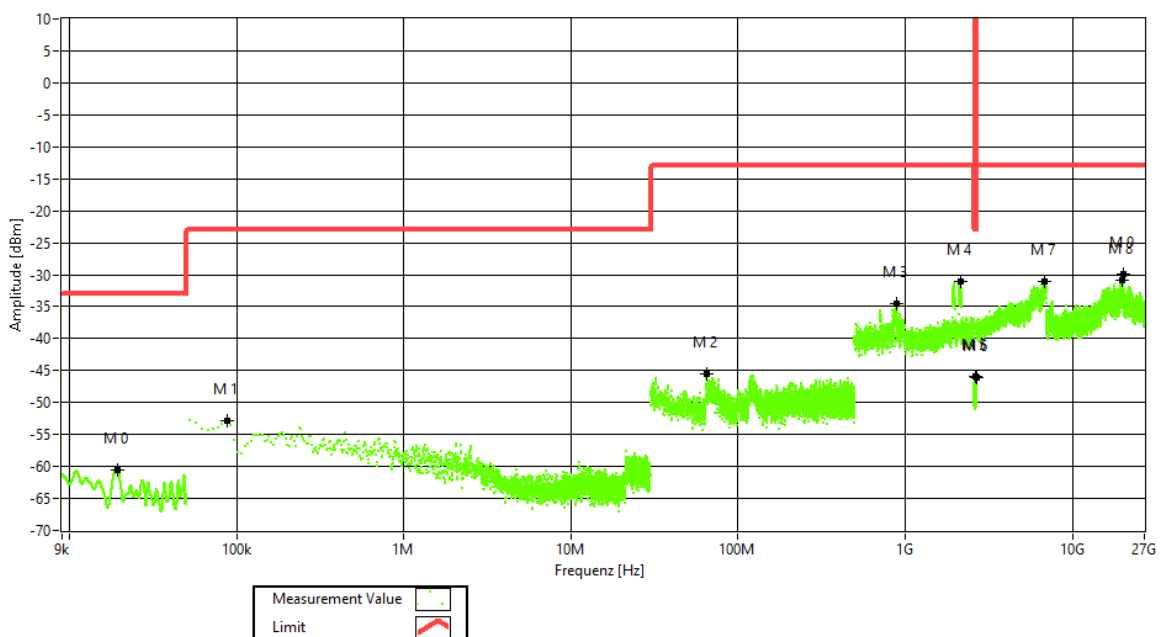



ECL-TA-20-013-V01.00

TA tests on Andrew CAP M 80-85/17E/19/26 F-AC



Frequency Band = IMT 2600, Test Frequency = high, Direction = RF downlink, Signal Type = AWGN

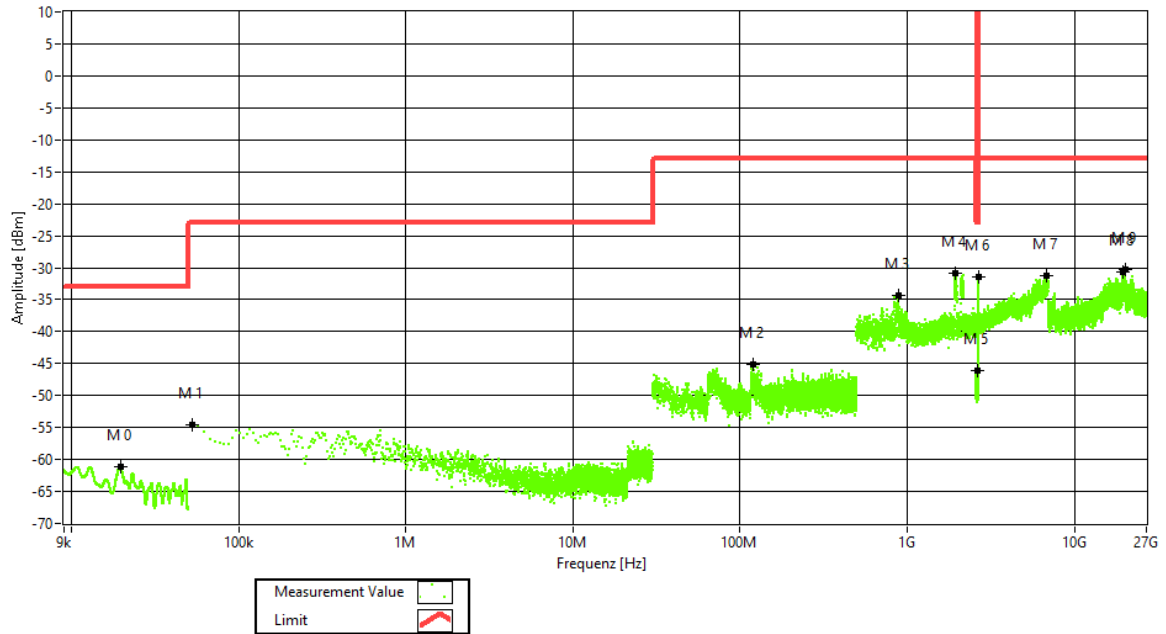

ECL-TA-20-013-V01.00

TA tests on Andrew CAP M 80-85/17E/19/26 F-AC

Frequency Band = IMT 2600, Test Frequency = low, Direction = RF downlink, Signal Type = GSM

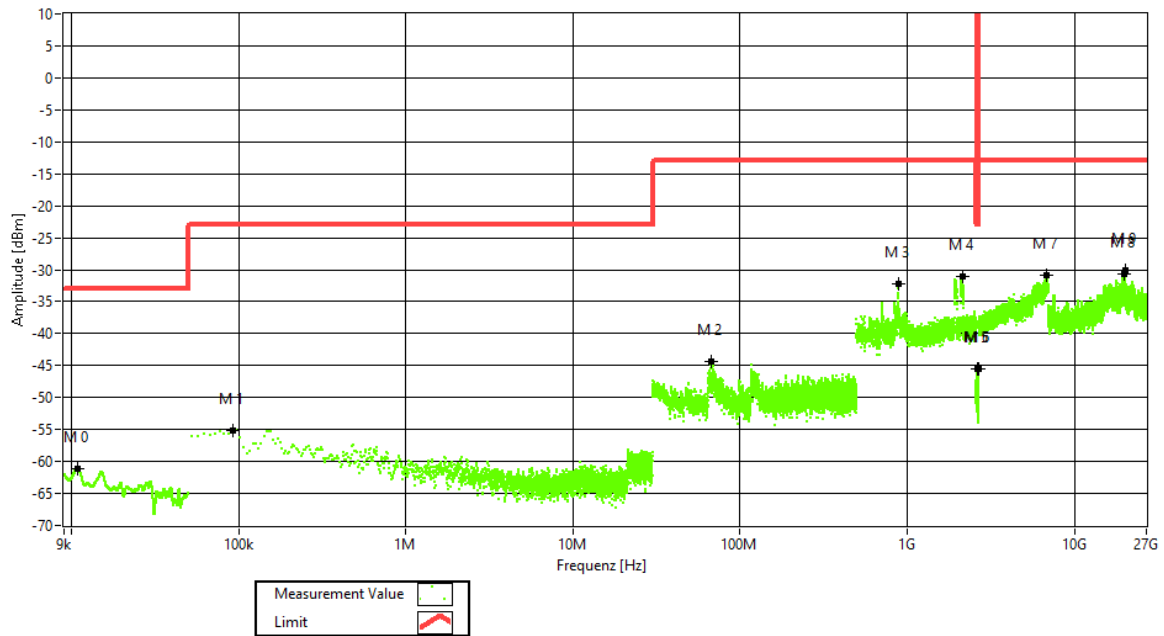

Frequency Band = IMT 2600, Test Frequency = mid, Direction = RF downlink, Signal Type = GSM

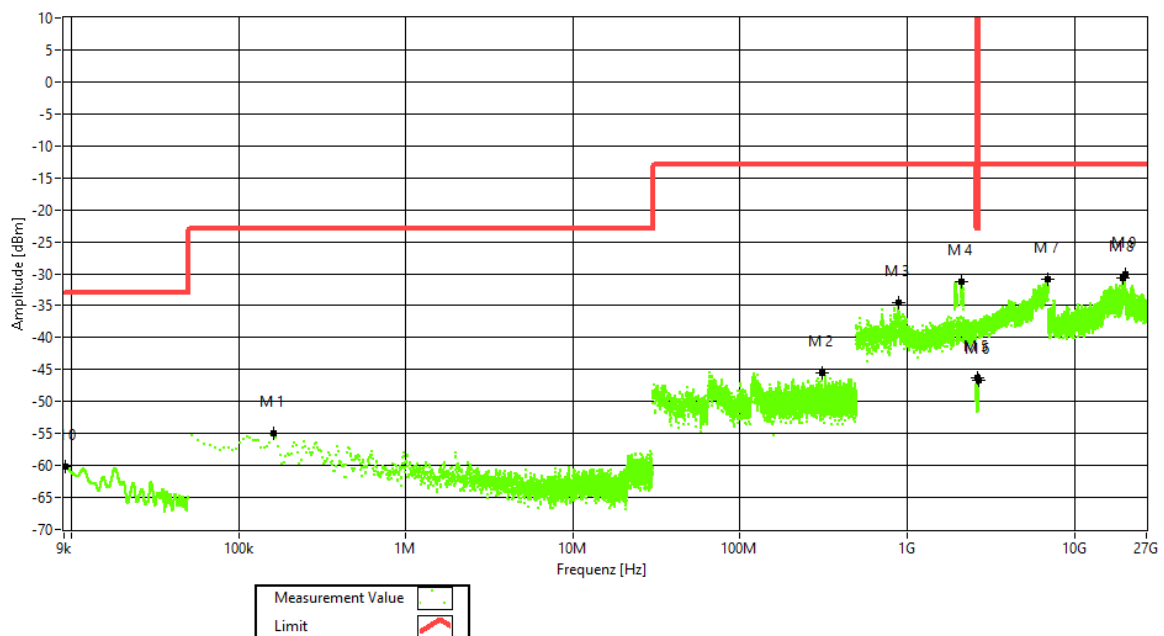



Frequency Band = IMT 2600, Test Frequency = high, Direction = RF downlink, Signal Type = GSM

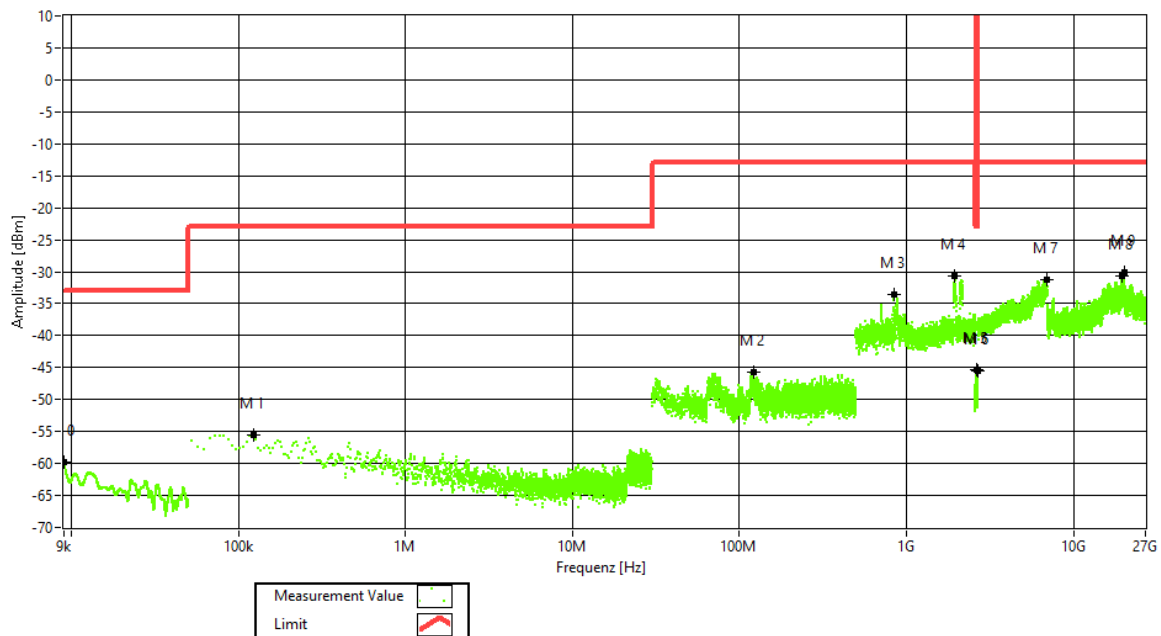

4.4.5 TEST EQUIPMENT USED

- Conducted

4.5 OUT-OF-BAND EMISSION LIMITS

Standard FCC Part § 2.1051, § 27.53

The test was performed according to:
ANSI C63.26, KDB 935210 D05 v01r04: 3.6

Test date: 2020-09-14

Environmental conditions: 24 ° C; 43 % r. F.

Test engineer: Thomas Hufnagel

4.5.1 TEST DESCRIPTION

This test case is intended to demonstrate compliance to the out-of-band emission limit for industrial signal boosters. The limits itself come from the applicable rule part for each operating band per FCC § 2.1051, FCC § 27.53, RSS-GEN with subpart 6.13 and RSS-199 with subpart 4.5.

The EUT was connected to the test setup according to the following diagram:

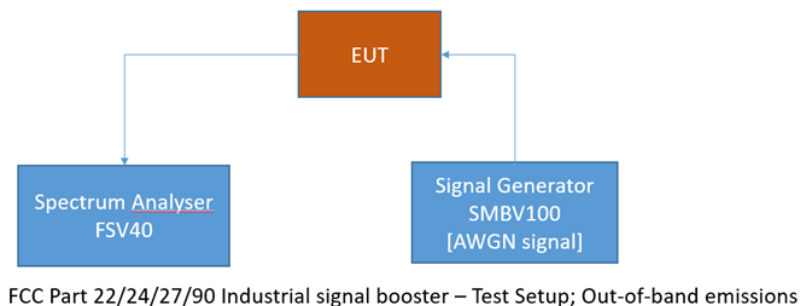

The attenuation of the measuring and stimulus path are known for each measured frequency and are considered.

The Spectrum Analyzer settings can be directly found in the measurement diagrams.



4.5.2 TEST REQUIREMENTS/LIMITS

Abstract § 2.1051 from FCC:

FCC Part 2.1051; Measurement required: Spurious emissions at antenna terminal:

The radio frequency voltage or powers generated within the equipment and appearing on a spurious frequency shall be checked at the equipment output terminals when properly loaded with a suitable artificial antenna. Curves or equivalent data shall show the magnitude of each harmonic and other spurious emission that can be detected when the equipment is operated under the conditions specified in § 2.1049 as appropriate. The magnitude of spurious emissions which are attenuated more than 20 dB below the permissible value need not be specified.

Part 27; Miscellaneous Wireless Communication Services

Subpart C – Technical standards

§27.53 – Emission limits

Abstract § 27.53 FCC:

(m) For BRS and EBS stations, the power of any emissions outside the licensee's frequency bands of operation shall be attenuated below the transmitter power (P) measured in watts in accordance with the standards below. If a licensee has multiple contiguous channels, out-of-band emissions shall be measured from the upper and lower edges of the contiguous channels.

(1) Prior to the transition, and thereafter, solely within the MBS, for analog operations with an EIRP in excess of -9 dBW, the signal shall be attenuated at the channel edges by at least 38 dB relative to the peak visual carrier, then linearly sloping from that level to at least 60 dB of attenuation at 1 MHz below the lower band edge and 0.5 MHz above the upper band edge, and attenuated at least 60 dB at all other frequencies.

(2) For digital base stations, the attenuation shall be not less than $43 + 10 \log (P)$ dB, unless a documented interference complaint is received from an adjacent channel licensee with an overlapping Geographic Service Area. Mobile Satellite Service licensees operating on frequencies below 2495 MHz may also submit a documented interference complaint against BRS licensees operating on channel BRS No. 1 on the same terms and conditions as adjacent channel BRS or EBS licensees.

Abstract RSS-199 from ISED:**RSS-199; 4.5 Transmitter unwanted emissions**

In the 1 MHz band immediately outside and adjacent to the channel edge, the unwanted emission power shall be measured with a resolution bandwidth of at least 1% of the occupied bandwidth for base station and fixed subscriber equipment, and 2% for mobile subscriber equipment. Beyond the 1 MHz band, a resolution bandwidth of 1 MHz shall be used. A narrower resolution bandwidth can be used, provided that the measured power is integrated over the full required measurement bandwidth of 1 MHz, or 1% or 2% of the occupied bandwidth, as applicable.

Equipment shall comply with the following unwanted emission limits:

(a) for base station and fixed subscriber equipment, the power of any unwanted emissions measured as above shall be attenuated (in dB) below the transmitter power, P (dBW), by at least $43 + 10 \log_{10} p$.

- (i) $40 + 10 \log_{10} p$ from the channel edges to 5 MHz away
- (ii) $43 + 10 \log_{10} p$ between 5 MHz and X MHz from the channel edges, and
- (iii) $55 + 10 \log_{10} p$ at X MHz and beyond from the channel edges.

In addition, the attenuation shall not be less than $43 + 10 \log_{10} p$ on all frequencies between 2490.5 MHz and 2496 MHz, and $55 + 10 \log_{10} p$ at or below 2490.5 MHz. (b) for mobile subscriber equipment, the power of any unwanted emissions measured as above shall be attenuated (in dB) below the transmitter power, P (dBW), by at least:

In (a) and (b), p is the transmitter power measured in watts and X is 6 MHz or the equipment occupied bandwidth, whichever is greater.



4.5.3 TEST PROTOCOL

IMT 2600, downlink, Number of input signals = 1							
Signal Type	Input Power	Band Edge	Signal Frequency [MHz]	Input Power [dBm]	Maximum Out-of-band Power [dBm]	Limit Out-of-band Power [dBm]	Margin to Limit [dB]
Wideband	-0.3 dB < AGC	upper	2687.50	-2.3	-31.4	-13.0	18.4
Wideband	3 dB > AGC	upper	2687.50	1.0	-29.2	-13.0	16.2
Narrowband	-0.3 dB < AGC	upper	2689.80	-2.1	-28.7	-13.0	15.7
Narrowband	3 dB > AGC	upper	2689.80	1.2	-29.5	-13.0	16.5
Wideband	-0.3 dB < AGC	lower	2622.50	-1.5	-30.4	-13.0	17.4
Wideband	3 dB > AGC	lower	2622.50	1.8	-29.9	-13.0	16.9
Narrowband	-0.3 dB < AGC	lower	2620.20	-1.7	-21.7	-13.0	8.7
Narrowband	3 dB > AGC	lower	2620.20	1.6	-21.4	-13.0	8.4

IMT 2600, downlink, Number of input signals = 2								
Signal Type	Input Power	Band Edge	Signal Frequency f1 [MHz]	Signal Frequency f2 [MHz]	Input Power [dBm]	Maximum Out-of-band Power [dBm]	Limit Out-of-band Power [dBm]	Margin to Limit [dB]
WB	-0.3 dB < AGC	upper	2687.50	2685.00	-2.3	-33.1	-13.0	20.1
WB	3 dB > AGC	upper	2687.50	2685.00	1.0	-32.8	-13.0	19.8
NB	-0.3 dB < AGC	upper	2689.80	2689.60	-2.1	-30.7	-13.0	17.7
NB	3 dB > AGC	upper	2689.80	2689.60	1.2	-31.3	-13.0	18.3
WB	-0.3 dB < AGC	lower	2622.50	2625.00	-1.5	-31.5	-13.0	18.5
WB	3 dB > AGC	lower	2622.50	2625.00	1.8	-31.6	-13.0	18.6
NB	-0.3 dB < AGC	lower	2620.20	2620.40	-1.7	-26.0	-13.0	13.0
NB	3 dB > AGC	lower	2620.20	2620.40	1.6	-25.7	-13.0	12.7

Remark: Please see next sub-clause for the measurement plot.

Explanations concerning table with two input signals:

"WB" means Wideband.

"NB" means Narrowband.



4.5.4 MEASUREMENT PLOT (SHOWING THE HIGHEST VALUE, "WORST CASE")

Band: IMT2600; Frequency: 2.6200 GHz to 2.6900 GHz; Band Edge: upper; Mod: AWGN; Input Power = 0.3 dB < AGC; Number of signals 1

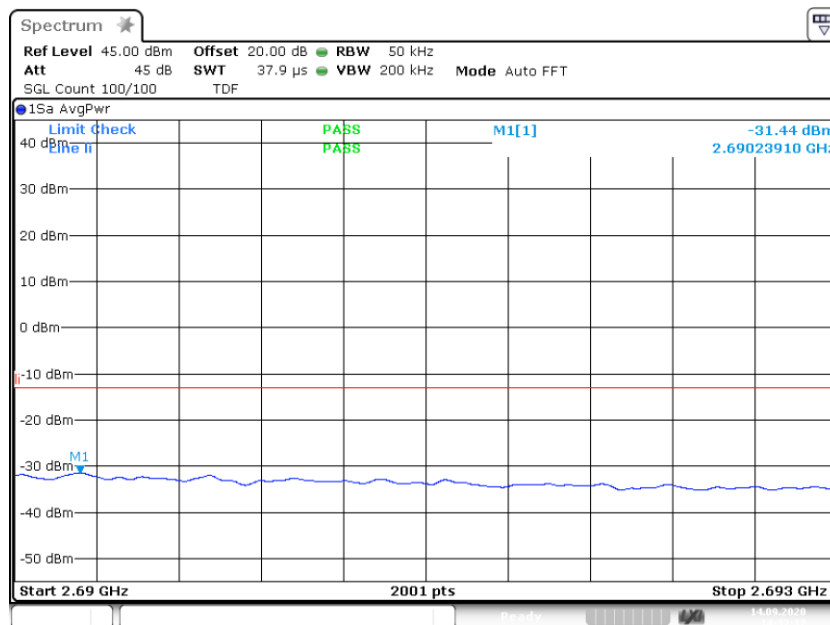

3.6.2 out of band emi IMT2600 AWGN upper lcarrier -0.3 dB 2.
690G 2.693G

Band: IMT2600; Frequency: 2.6200 GHz to 2.6900 GHz; Band Edge: upper; Mod: AWGN; Input Power = 3 dB > AGC; Number of signals 1

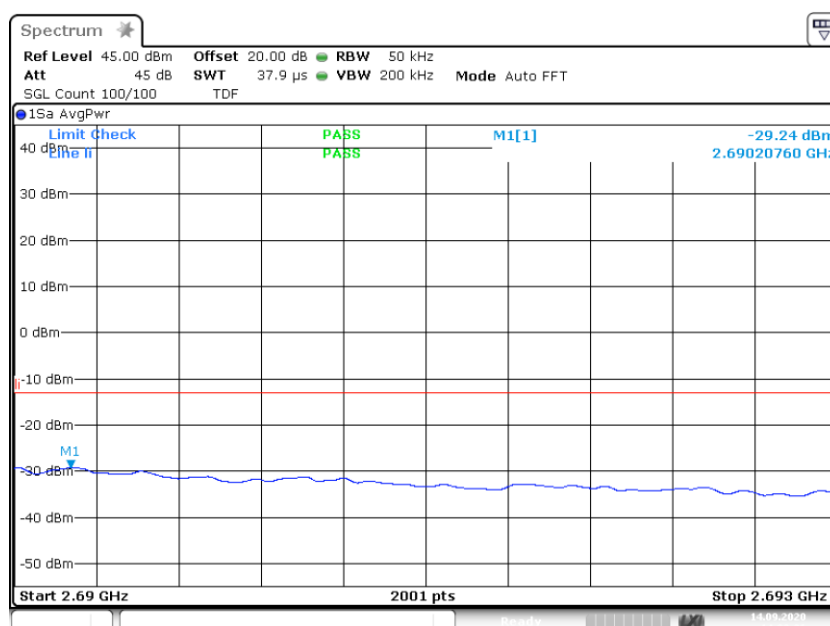

3.6.2 out of band emi IMT2600 AWGN upper lcarrier +3.0 dB 2.
690G 2.693G



Band: IMT2600; Frequency: 2.6200 GHz to 2.6900 GHz; Band Edge: lower; Mod: AWGN; Input Power = 0.3 dB < AGC; Number of signals 1

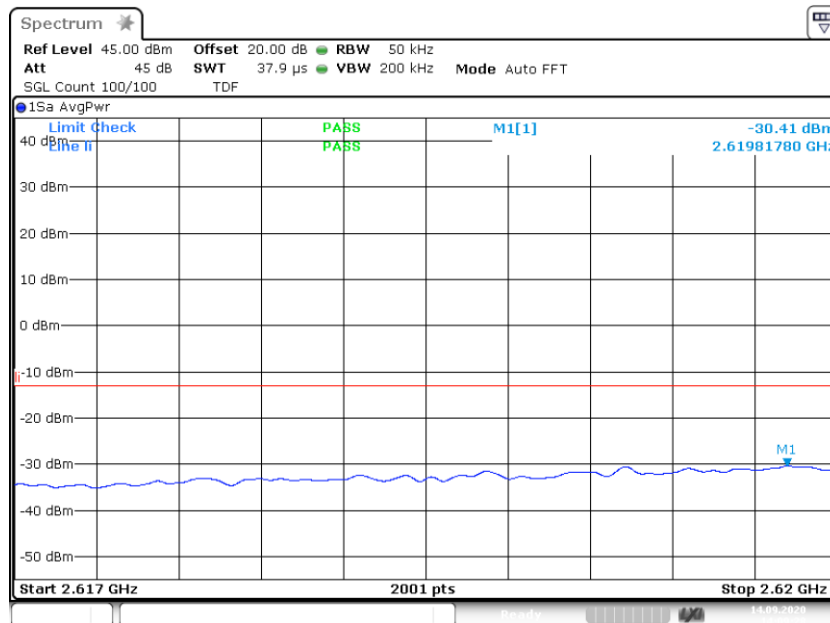

3.6.2 out of band emi IMT2600 AWGN lower 1carrier -0.3 dB 2.
617G 2.620G

Band: IMT2600; Frequency: 2.6200 GHz to 2.6900 GHz; Band Edge: lower; Mod: AWGN; Input Power = 3 dB > AGC; Number of signals 1

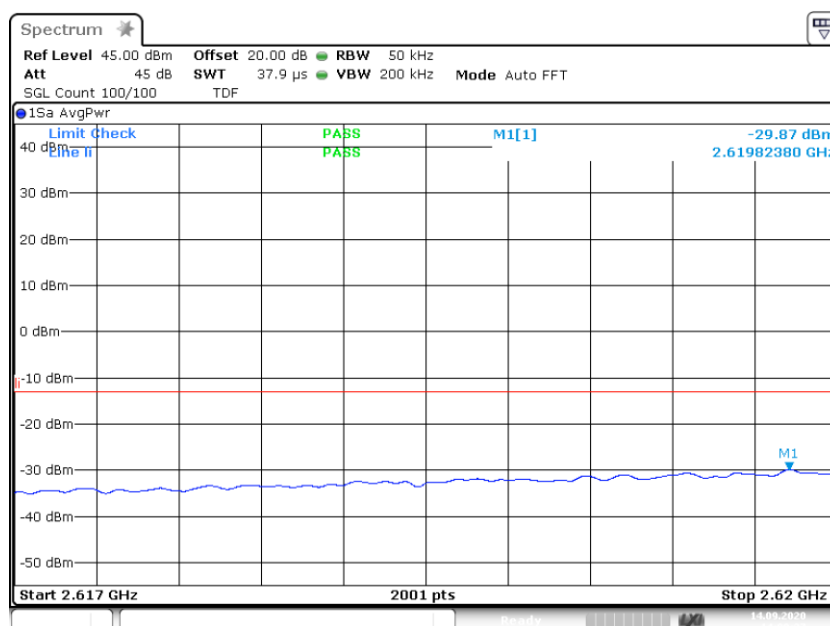

3.6.2 out of band emi IMT2600 AWGN lower 1carrier +3.0 dB 2.
617G 2.620G



ECL-TA-20-013-V01.00

TA tests on Andrew CAP M 80-85/17E/19/26 F-AC

Band: IMT2600; Frequency: 2.6200 GHz to 2.6900 GHz; Band Edge: lower; Mod: GSM; Input Power = 0.3 dB < AGC; Number of signals 1

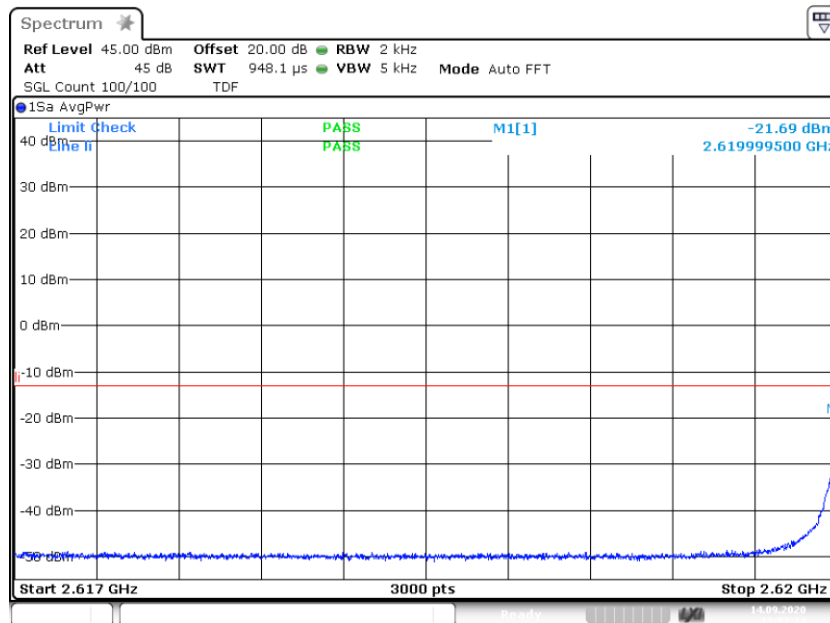

Band: IMT2600; Frequency: 2.6200 GHz to 2.6900 GHz; Band Edge: lower; Mod: GSM; Input Power = 3 dB > AGC; Number of signals 1

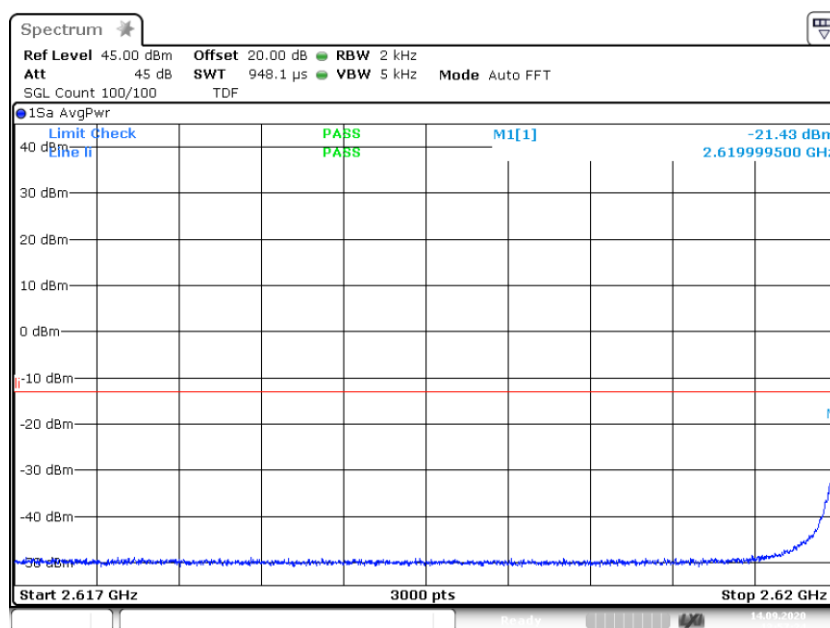



Band: IMT2600; Frequency: 2.6200 GHz to 2.6900 GHz; Band Edge: upper; Mod: AWGN; Input Power = 0.3 dB < AGC; Number of signals 2

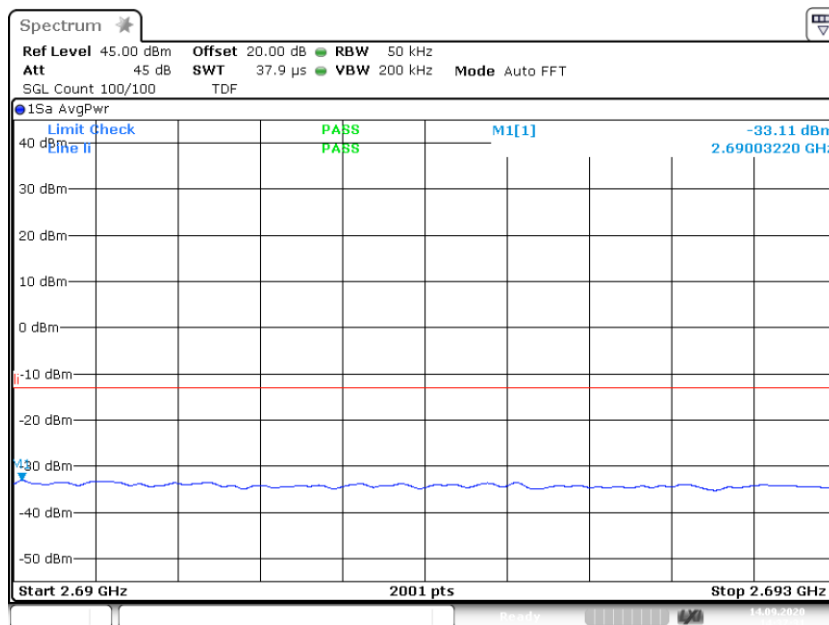

3.6.2 out of band emi IMT2600 AWGN upper 2carriers -0.3 dB 2
.690G 2.693G

Band: IMT2600; Frequency: 2.6200 GHz to 2.6900 GHz; Band Edge: upper; Mod: AWGN; Input Power = 3 dB > AGC; Number of signals 2

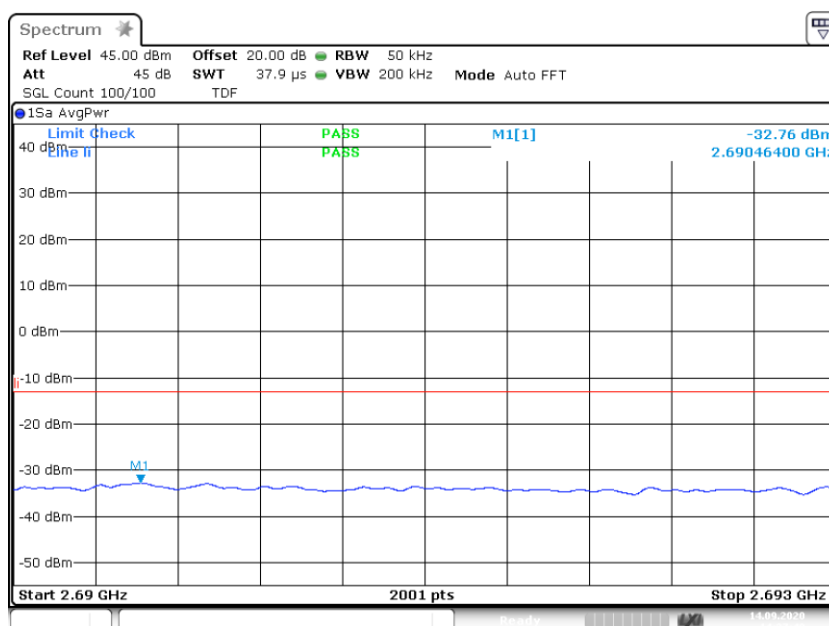

3.6.2 out of band emi IMT2600 AWGN upper 2carriers +3.0 dB 2
.690G 2.693G



Band: IMT2600; Frequency: 2.6200 GHz to 2.6900 GHz; Band Edge: lower; Mod: AWGN; Input Power = 0.3 dB < AGC; Number of signals 2

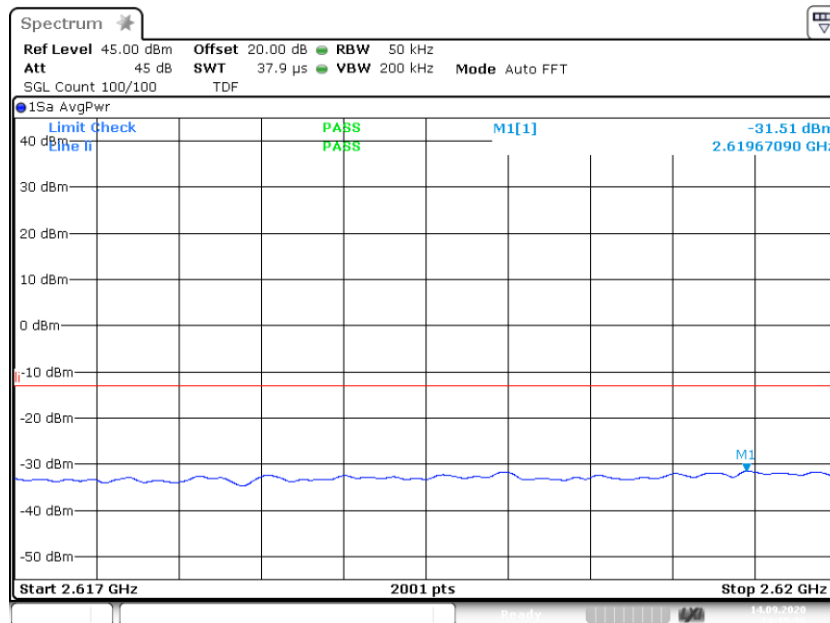

3.6.2 out of band emi IMT2600 AWGN lower 2carriers -0.3 dB 2
.617G 2.620G

Band: IMT2600; Frequency: 2.6200 GHz to 2.6900 GHz; Band Edge: lower; Mod: AWGN; Input Power = 3 dB > AGC; Number of signals 2

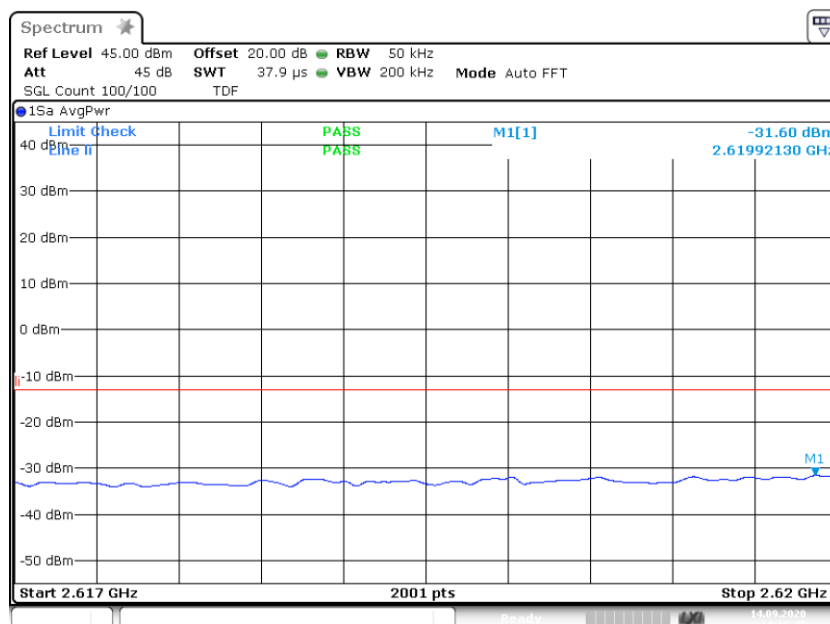

3.6.2 out of band emi IMT2600 AWGN lower 2carriers +3.0 dB 2
.617G 2.620G



Band: IMT2600; Frequency: 2.6200 GHz to 2.6900 GHz; Band Edge: lower; Mod: GSM; Input Power = 0.3 dB < AGC; Number of signals 2

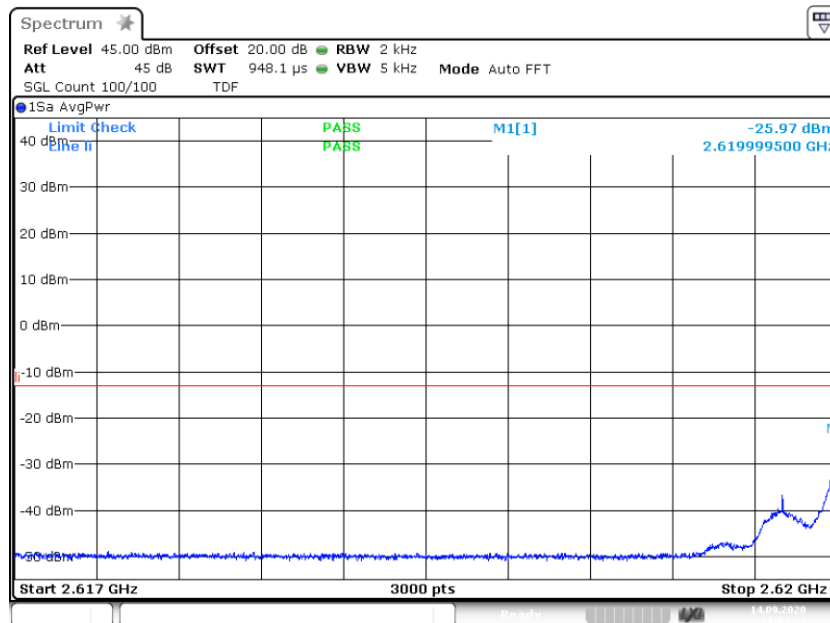

3.6.2 out of band emi IMT2600 GSM lower 2carriers -0.3 dB 2.
617G 2.620G

Band: IMT2600; Frequency: 2.6200 GHz to 2.6900 GHz; Band Edge: lower; Mod: GSM; Input Power = 3 dB > AGC; Number of signals 2

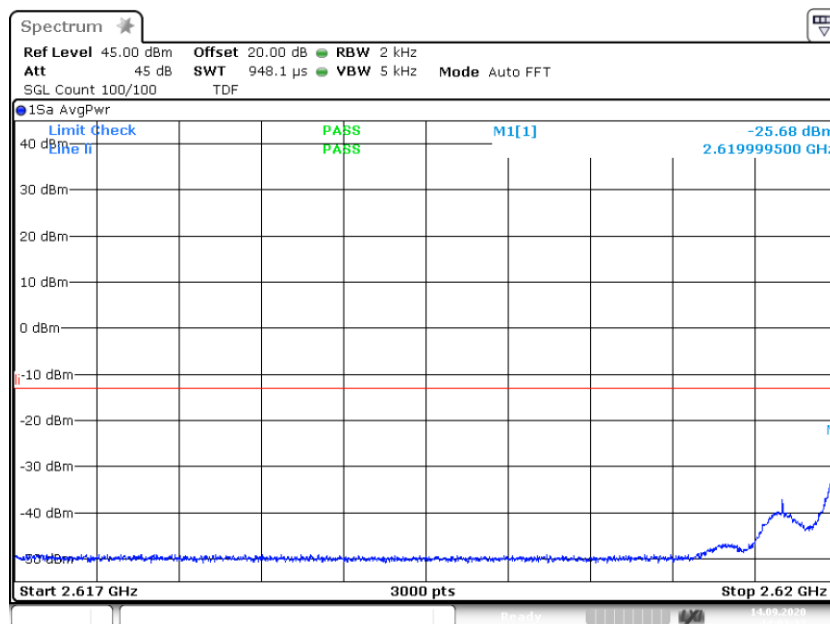

3.6.2 out of band emi IMT2600 GSM lower 2carriers +3.0 dB 2.
617G 2.620G

4.5.5 TEST EQUIPMENT USED

- Conducted

4.6 OUT-OF-BAND REJECTION

Standard KDB 935210 D05

The test was performed according to:
ANSI C63.26; KDB 935210 D05

Test date: 2020-09-14

Environmental conditions: 24 ° C; 43 % r. F.

Test engineer: Thomas Hufnagel

4.6.1 TEST DESCRIPTION

This test case is intended to demonstrate compliance to the out-of-band rejection test case for industrial signal boosters.

The EUT was connected to the test setup according to the following diagram:

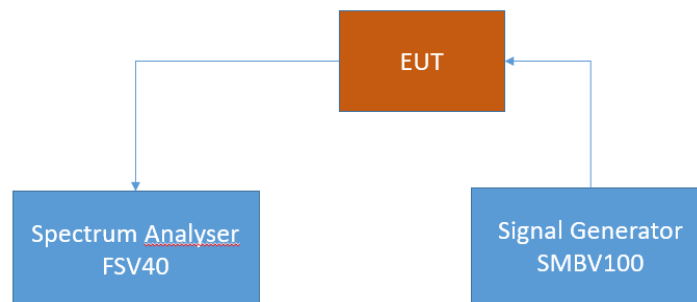

FCC Part 22/24/27/90 Industrial signal booster – Test Setup; Out-of-band rejection

The attenuation of the measuring and stimulus path are known for each measured frequency and are considered.

The Spectrum Analyzer settings can be directly found in the measurement diagrams.

4.6.2 TEST REQUIREMENTS/LIMITS

Abstract RSS-131 from ISED:

RSS-131; 5.2.1 Out-of-band rejection

The gain-versus-frequency response and the 20 dB bandwidth of the zone enhancer shall be reported. The zone enhancer shall reject amplification of other signals outside the passband of the zone enhancer.

4.6.3 TEST PROTOCOL

IMT 2600, downlink				
Highest Power Frequency [MHz]	Output Power [dBm]	Lower Highest Power -20 dB Frequency [MHz]	Upper Highest Power -20 dB Frequency [MHz]	20 dB Bandwidth [MHz]
2646.10	24.84	2617.8130	2692.1880	74.3750

Remark: Please see next sub-clause for the measurement

4.6.4 MEASUREMENT PLOT (SHOWING THE HIGHEST VALUE, "WORST CASE")

Frequency Band = IMT 2600, Direction = RF downlink

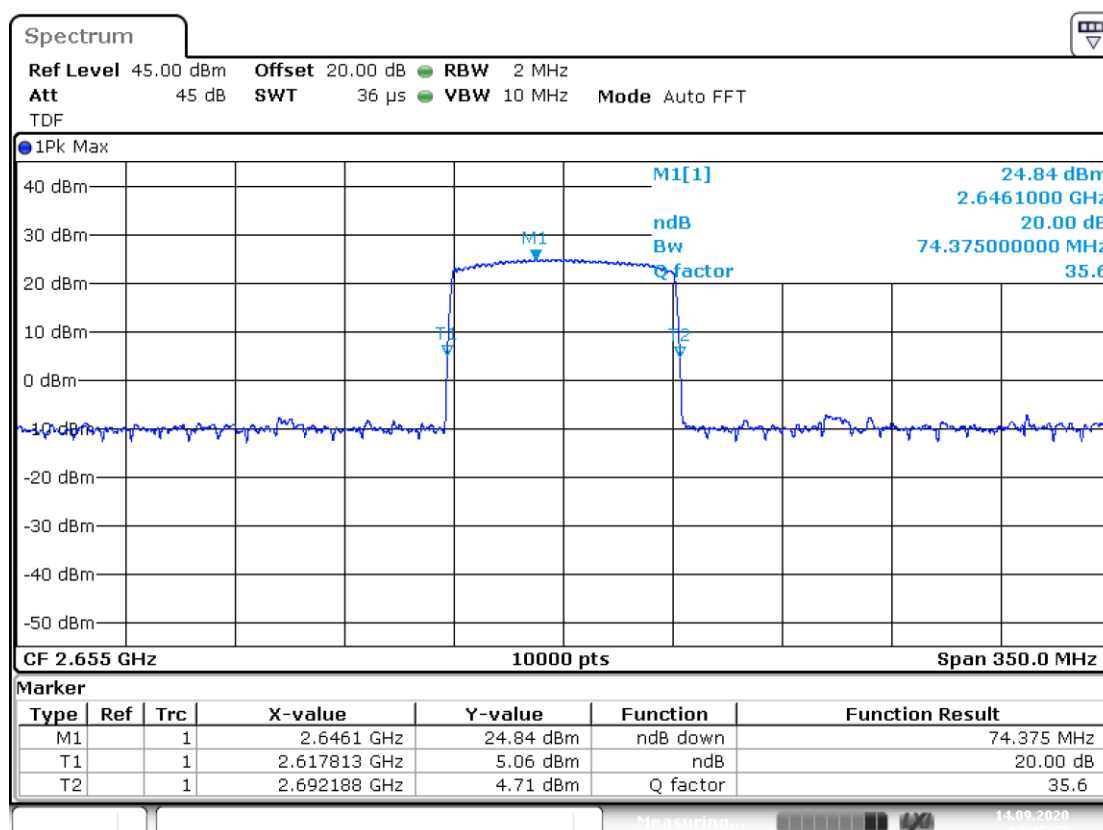

3.3 Out of band rejection IMT2600 2.65500G
 _20dB

4.6.5 TEST EQUIPMENT USED

- Conducted

4.7 FIELD STRENGTH OF SPURIOUS RADIATION

Standard FCC Part 27, § 27.53

The test was performed according to:
ANSI C63.26

Test date: 2020-09-30

Environmental conditions: 23 ° C; 44 % r. F.

Test engineer: Thomas Hufnagel

4.7.1 TEST DESCRIPTION

This test case is intended to demonstrate compliance to the applicable radiated spurious emission measurements per § 2.1053.

The EUT was connected to the test setup according to the following diagram:

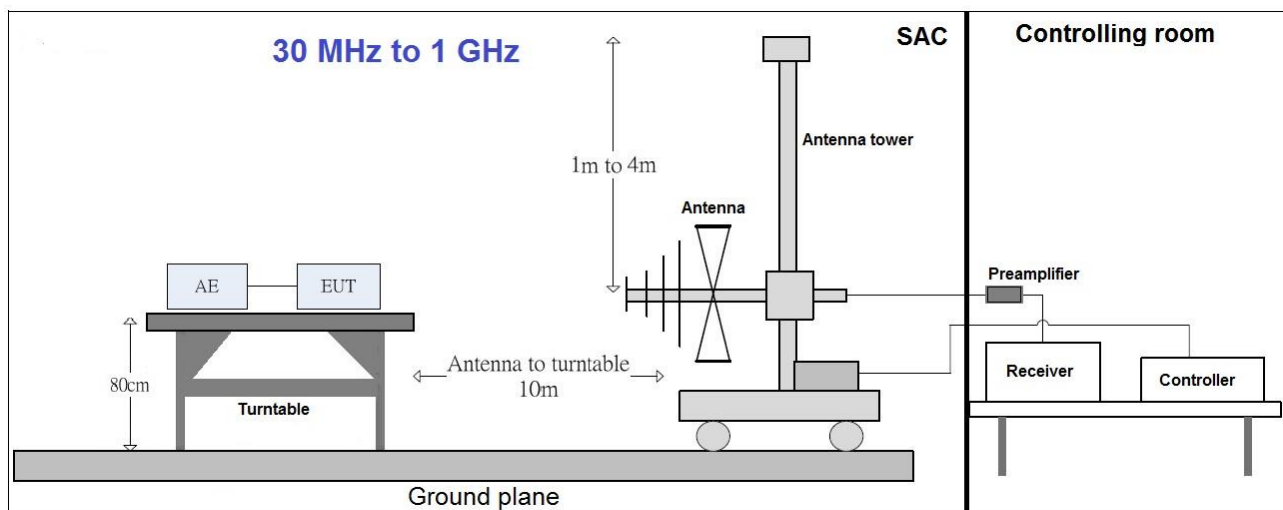

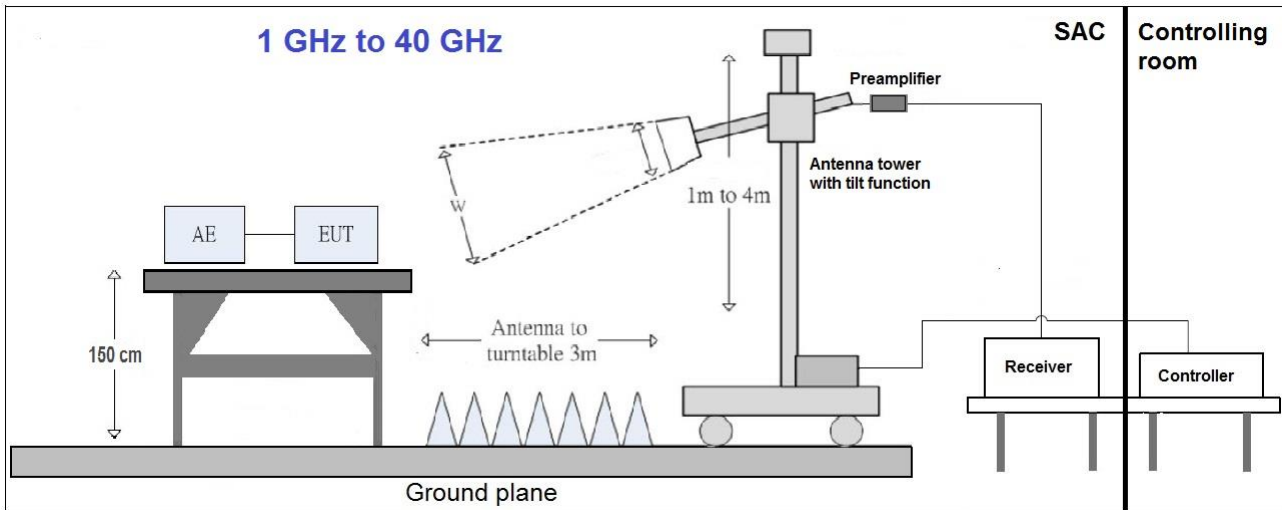

The test set-up was made in accordance to the general provisions of ANSI C63.4 in a typical installation configuration. The Equipment Under Test (EUT) was set up on a non-conductive table 1.5 x 1.5 m² in the semi-anechoic chamber, 0.8 meter above the ground or floor-standing arrangement shall be placed on the horizontal ground reference plane.. The influence of the EUT support table that is used between 30–1000 MHz was evaluated. For the initial measurements, the receiving antenna is varied from 1-4 meter height and is changed in the vertical plane from vertical to horizontal polarization at each frequency. The highest emissions between 30 MHz to 1000 MHz were analyzed in details by operating the spectrum analyzer and/or EMI receiver in quasi-peak mode to determine the precise amplitude of the emissions.

The measurement procedure is implemented into the EMI test software BAT EMC from NEXIO. Exploratory tests are performed at 3 orthogonal axes to determine the worst-case orientation of a body-worn or handheld EUT. The final test on all kind of EUTs is also performed at 3 axes. A pre-check is performed while the EUT is powered by a DC power source. ?

1. Measurement above 30 MHz and up to 1 GHz

Step 1: Preliminary scan

This is a preliminary test to identify the highest amplitudes relative to the limit.

Settings for step 1:

- Antenna distance: 10 m
- Detector: Peak-Maxhold/RMS (FFT-based)
- Frequency range: 30 – 1000 MHz
- Frequency steps: 30 kHz
- IF-Bandwidth: 120 kHz
- Measuring time/Frequency step: 5 ms
- Turntable angle range: -180° to 180°
- Turntable step size: 30°
- Height variation range: 1 – 4 m
- Height variation step size: 1 m
- Polarisation: Horizontal + Vertical

Intention of this step is, to determine the radiated EMI-profile of the EUT. Afterwards the relevant emissions for the final measurement are identified.



Step 2: Adjustment measurement

In this step the accuracy of the turntable azimuth and antenna height will be improved. This is necessary to find out the maximum value of every frequency.

For each frequency, which was determined the turntable azimuth and antenna height will be adjusted. The turntable azimuth will slowly vary by $\pm 45^\circ$ around this value. During this action, the value of emission is continuously measured. The turntable azimuth at the highest emission will be recorded and adjusted. In this position, the antenna height will also slowly vary by ± 100 cm around the antenna height determined. During this action, the value of emission is also continuously measured. The antenna height of the highest emission will also be recorded and adjusted.

- Detector: Peak – Maxhold; RMS
- Measured frequencies: in step 1 determined frequencies
- IF – Bandwidth: 120 kHz
- Measuring time: 100 ms
- Turntable angle range: $\pm 30^\circ$ around the determined value
- Antenna Polarisation: max. value determined in step 1

Step 3: Final measurement with QP detector

With the settings determined in step 3, the final measurement will be performed:

EMI receiver settings for step 4:

- Detector: Quasi-Peak (< 1 GHz); RMS; Peak
- Measured frequencies: in step 1 determined frequencies
- IF – Bandwidth: 120 kHz
- Measuring time: 1 s

After the measurement a plot will be generated which contains a diagram with the results of the preliminary scan and a chart with the frequencies and values of the results of the final measurement.

3. Measurement above 1 GHz

The following modifications apply to the measurement procedure for the frequency range above 1 GHz:

Step 1:

The Equipment Under Test (EUT) was set up on a non-conductive support at 1.5 m height in the semi-anechoic chamber. Absorbers are placed around and between the turn table and the antenna tower.

All steps were performed with one height (1.5 m) of the receiving antenna only.

The EUT is turned during the preliminary measurement across the elevation axis, with a step size of 30° .

The turn table step size (azimuth angle) for the preliminary measurement is 15° .

Step 2:

The maximum RFI field strength was determined during the measurement by rotating the turntable (± 180 degrees) and varying the height of the receive antenna ($h = 1 \dots 4$ m) with a additional tilt function of the antenna. The turn table azimuth will slowly vary by $\pm 15^\circ$.

EMI receiver settings (for all steps):

- Detector: Peak, Average
- IF Bandwidth = 1 MHz

**Step 3:**

Spectrum analyser settings for step 3:

- Detector: Peak/Average
- Measured frequencies: in step 1 determined frequencies
- IF – Bandwidth: 1 MHz
- Measuring time: 1 s

4.7.2 TEST REQUIREMENTS/LIMITS

Abstract from FCC Part § 2.1053:

FCC Part 2.1053; Measurement required: Field strength of spurious radiation:

Measurements shall be made to detect spurious emissions that may be radiated directly from the cabinet, control circuits, power leads, or intermediate circuit elements under normal conditions of installation and operation. Curves or equivalent data shall be supplied showing the magnitude of each harmonic and other spurious emission. For this test, single sideband, independent sideband, and controlled carrier transmitters shall be modulated under the conditions specified in paragraph (c) of § 2.1049, as appropriate.

Part 27; Miscellaneous Wireless Communication Services**Subpart C – Technical standards****§27.53 – Emission limits**

Abstract § 27.53 FCC:

(m) For BRS and EBS stations, the power of any emissions outside the licensee's frequency bands of operation shall be attenuated below the transmitter power (P) measured in watts in accordance with the standards below. If a licensee has multiple contiguous channels, out-of-band emissions shall be measured from the upper and lower edges of the contiguous channels.

(1) Prior to the transition, and thereafter, solely within the MBS, for analog operations with an EIRP in excess of -9 dBW, the signal shall be attenuated at the channel edges by at least 38 dB relative to the peak visual carrier, then linearly sloping from that level to at least 60 dB of attenuation at 1 MHz below the lower band edge and 0.5 MHz above the upper band edge, and attenuated at least 60 dB at all other frequencies.

(2) For digital base stations, the attenuation shall be not less than $43 + 10 \log (P)$ dB, unless a documented interference complaint is received from an adjacent channel licensee with an overlapping Geographic Service Area. Mobile Satellite Service licensees operating on frequencies below 2495 MHz may also submit a documented interference complaint against BRS licensees operating on channel BRS No. 1 on the same terms and conditions as adjacent channel BRS or EBS licensees.

Abstract RSS-199 from ISED:**RSS-199; 4.5 Transmitter unwanted emissions**

In the 1 MHz band immediately outside and adjacent to the channel edge, the unwanted emission power shall be measured with a resolution bandwidth of at least 1% of the occupied bandwidth for base station and fixed subscriber equipment, and 2% for mobile subscriber equipment. Beyond the 1 MHz band, a resolution bandwidth of 1 MHz shall be used. A narrower resolution bandwidth can be used, provided that the measured power is integrated over the full required measurement bandwidth of 1 MHz, or 1% or 2% of the occupied bandwidth, as applicable.

Equipment shall comply with the following unwanted emission limits:

(a) for base station and fixed subscriber equipment, the power of any unwanted emissions measured as above shall be attenuated (in dB) below the transmitter power, P (dBW), by at least $43 + 10 \log_{10} p$.

- (i) $40 + 10 \log_{10} p$ from the channel edges to 5 MHz away
- (ii) $43 + 10 \log_{10} p$ between 5 MHz and X MHz from the channel edges, and
- (iii) $55 + 10 \log_{10} p$ at X MHz and beyond from the channel edges.

In addition, the attenuation shall not be less than $43 + 10 \log_{10} p$ on all frequencies between 2490.5 MHz and 2496 MHz, and $55 + 10 \log_{10} p$ at or below 2490.5 MHz. (b) for mobile subscriber equipment, the power of any unwanted emissions measured as above shall be attenuated (in dB) below the transmitter power, P (dBW), by at least:

In (a) and (b), p is the transmitter power measured in watts and X is 6 MHz or the equipment occupied bandwidth, whichever is greater.

4.7.3 TEST PROTOCOL

30 MHz to 1 GHz:

IMT 2600, downlink;						
Spurious Freq. [MHz]	Spurious Level [dBm]	Pin (Sum Level) [dBm]	Detector	RBW [kHz]	Limit [dBm]	Margin to Limit [dB]
199,57	-80,2	-2.1	PEAK	120	-13.0	67,2
333,52	-71,7	-2.1	PEAK	120	-13.0	58,7
483,37	-67,7	-2.1	PEAK	120	-13.0	54,7
600,04	-68,6	-2.1	PEAK	120	-13.0	55,6
199,99	-73,7	-2.1	PEAK	120	-13.0	60,7
300,01	-72,1	-2.1	PEAK	120	-13.0	59,1
499,99	-65,6	-2.1	PEAK	120	-13.0	52,6
800,02	-65,0	-2.1	PEAK	120	-13.0	52,0

1 GHz to 18 GHz:

IMT 2600, downlink;						
Spurious Freq. [MHz]	Spurious Level [dBm]	Pin (Sum Level) [dBm]	Detector	RBW [kHz]	Limit [dBm]	Margin to Limit [dB]
2654,9	-41,4	-2.1	PEAK	1000	-13.0	28,4
3549,0	-41,8	-2.1	PEAK	1000	-13.0	28,8
17803,4	-20,1	-2.1	PEAK	1000	-13.0	7,1
2654,7	-44,1	-2.1	PEAK	1000	-13.0	31,1
3552,8	-40,9	-2.1	PEAK	1000	-13.0	27,9
17797,6	-19,2	-2.1	PEAK	1000	-13.0	6,2

18 GHz to 27 GHz:

IMT 2600, downlink;						
Spurious Freq. [MHz]	Spurious Level [dBm]	Pin (Sum Level) [dBm]	Detector	RBW [kHz]	Limit [dBm]	Margin to Limit [dB]
None measured.	-----	-2.1	PEAK	1000	-13.0	-----

Remarks: Please see next sub-clause for the measurement plot.

Although usually a RMS detector is used for measurements in this cases a PEAK detector was used.

The limits are values for use of a RMS detector, but it is so, that the use of a PEAK detector results in readings with higher measured levels. Because the levels with the higher values with PEAK detector are in tolerance, the limits with a RMS detector are definitely also in tolerance.



4.7.4 MEASUREMENT PLOT (SHOWING THE HIGHEST VALUE, "WORST CASE")

Frequency Band = IMT 2600, Test Frequency = low, Direction = RF downlink

30 MHz - 1 GHz

- FCC/-13 dBm - /10.0m/
- ◇ Peak (Manual suspects) (Vertical)
- ◇ RMS (Manual suspects) (Vertical)
- Peak (Vertical)
- RMS (Vertical)
- × QuasiPeak (Vertical) (Vertical)

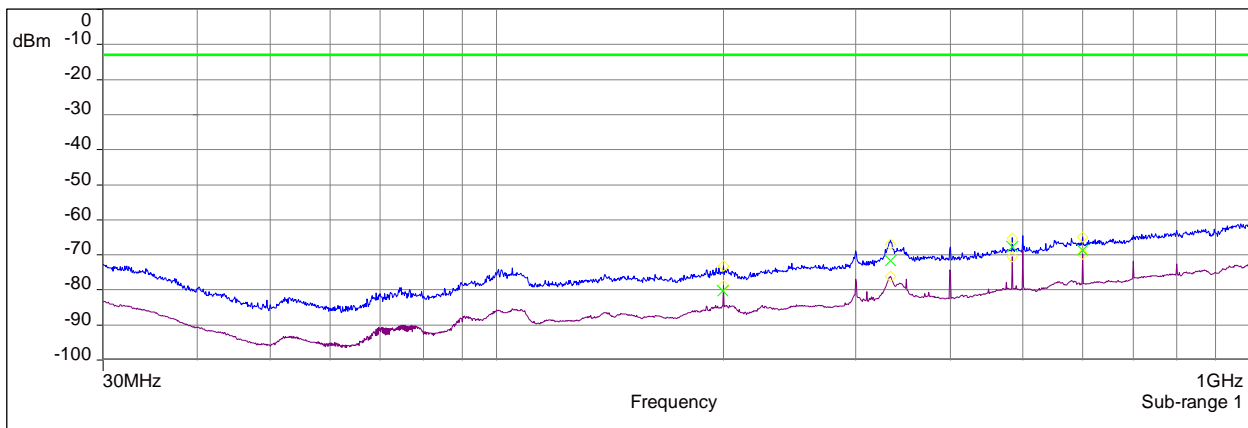

- FCC/-13 dBm - /10.0m/
- ◇ Peak (Manual suspects) (Vertical)
- ◇ RMS (Manual suspects) (Vertical)
- Peak (Vertical)
- RMS (Vertical)
- × QuasiPeak (Vertical) (Vertical)

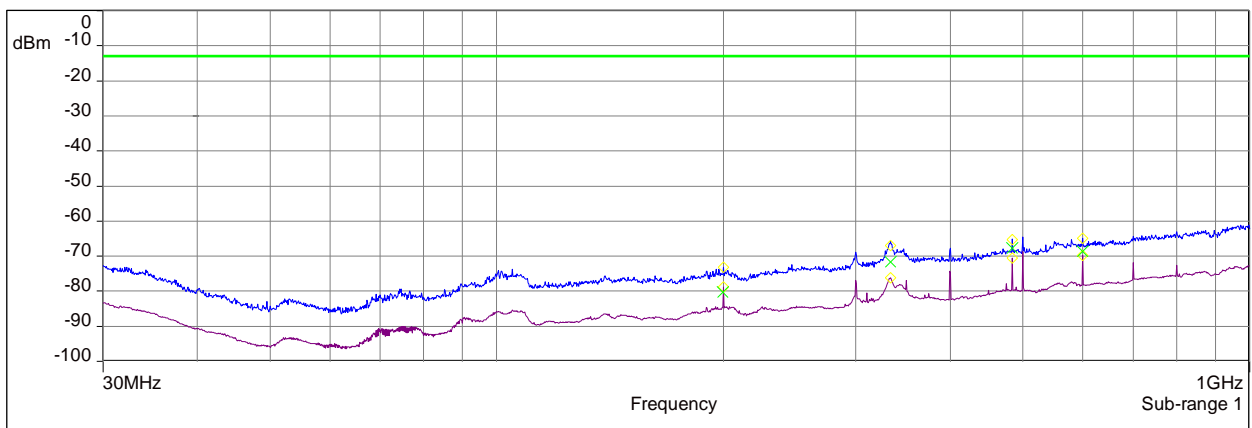



Frequency Band = IMT 2600, Test Frequency = low, Direction = RF downlink

1 GHz - 18 GHz

- FCC/-13 dBm - /3.0m/
- ◇ Peak (Manual suspects) (Vertical)
- ◇ Avg (Manual suspects) (Vertical)
- ◇ RMS (Manual suspects) (Vertical)
- Peak (Vertical)
- Avg (Vertical)
- RMS (Vertical)
- × Peak (Vertikal) (Vertical)
- × RMS (Vertikal) (Vertical)
- × Abstand RMS (Vertikal) (Vertical)

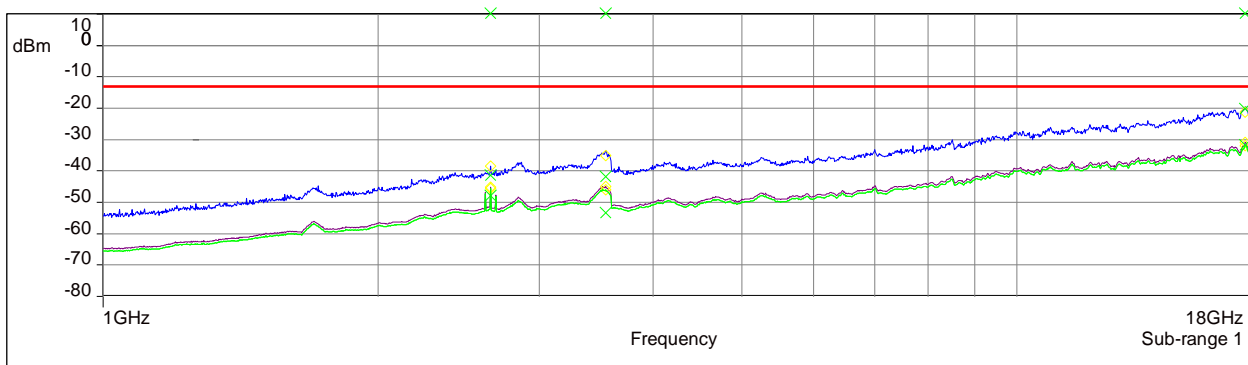

- FCC/-13 dBm - /3.0m/
- ◇ Peak (Manual suspects) (Horizontal)
- ◇ Avg (Manual suspects) (Horizontal)
- ◇ RMS (Manual suspects) (Horizontal)
- Peak (Horizontal)
- Avg (Horizontal)
- RMS (Horizontal)
- × Peak (Vertikal) (Horizontal)
- × RMS (Vertikal) (Horizontal)
- × Abstand RMS (Vertikal) (Horizontal)

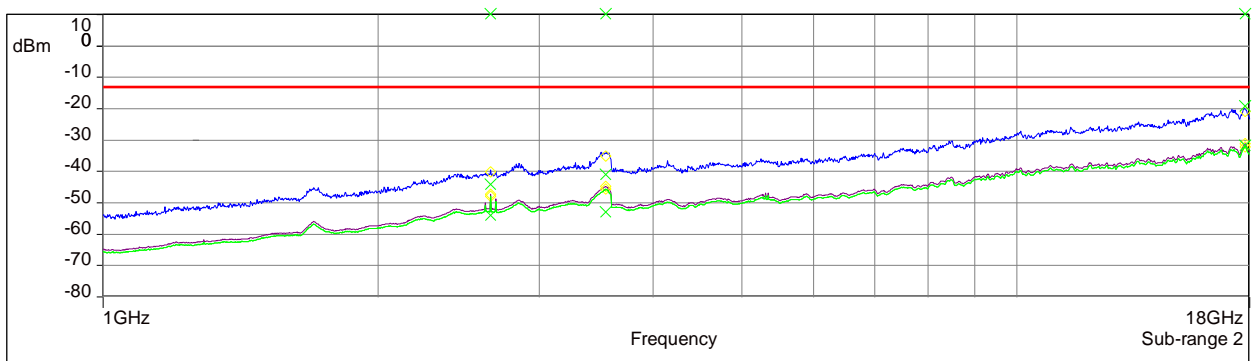



Frequency Band = IMT 2600, Test Frequency = low, Direction = RF downlink

18 GHz - 27 GHz

- FCC/-13 dBm - /3.0m/
- Peak (Vertical)
- Avg (Vertical)
- RMS (Vertical)

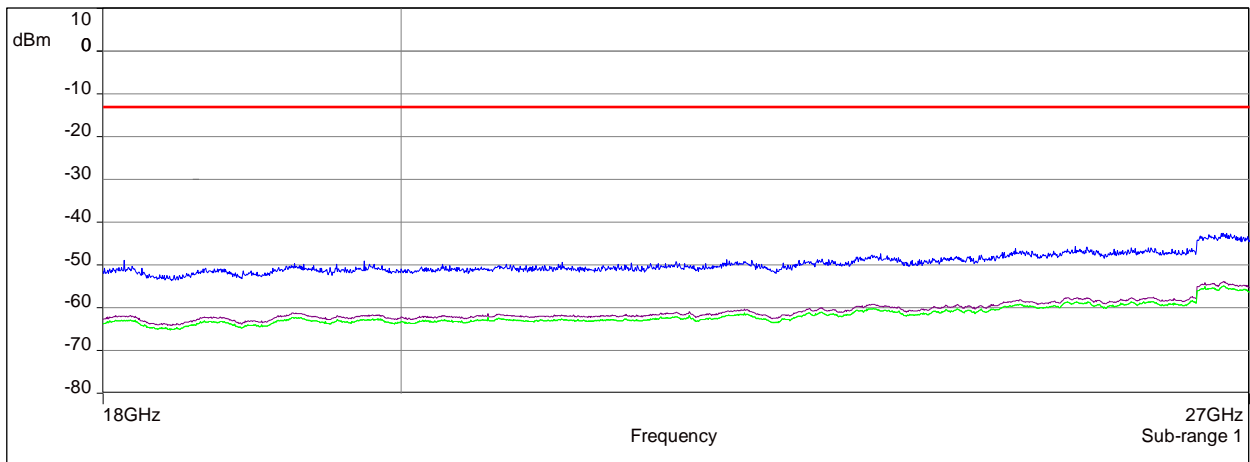

- FCC/-13 dBm - /3.0m/
- Peak (Horizontal)
- Avg (Horizontal)
- RMS (Horizontal)

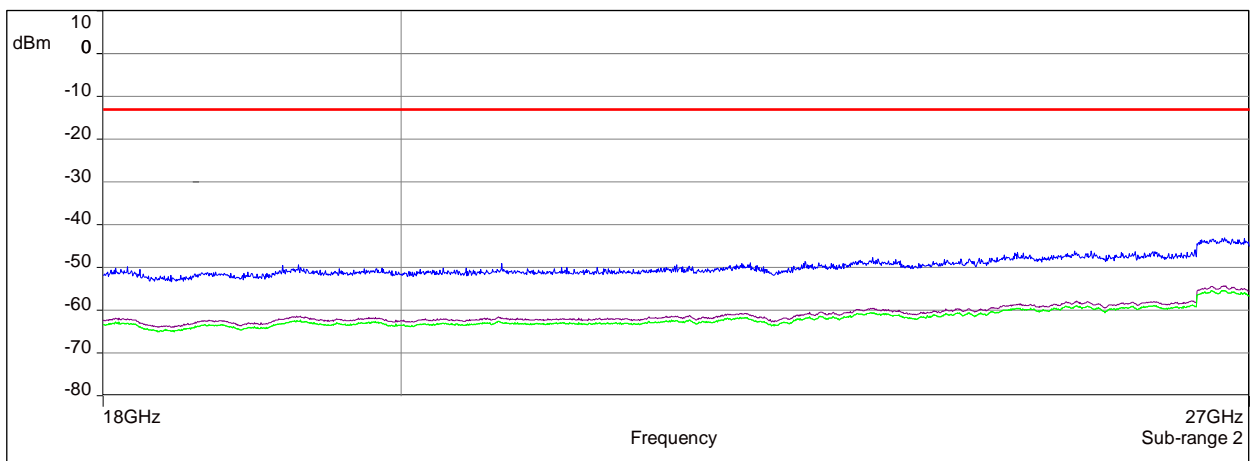



4.7.5 FIELD STRENGTH CALCULATIONS

$$\mathbf{FS} = \mathbf{SA} + \mathbf{AF} + \mathbf{CL} + \mathbf{PA}$$

Where as:

- FS** = Field strength
- SA** = EMC test receiver reading
- AF** = Antenna factor
- CL** = Cable loss
- PA** = Preamplifier

4.7.6 TEST EQUIPMENT USED

- Radiated Emissions



5 TEST EQUIPMENT

1 Conducted

Ref.No.	Type	Description	Manufacturer	Inventory no.	Last Calibration	Calibration Due
1.1	FSV40	Signal Analyzer 10 Hz - 40 GHz	Rohde & Schwarz	E2050	2019-10	2020-10
1.2	SMBV100A	Vector Signal Generator 9 kHz - 6 GHz	Rohde & Schwarz	G2089	2017-08/ 2020-08	2022-08
1.3	SMIQ	Vector Signal Generator 9 kHz - 3.3 GHz	Rohde & Schwarz	G1509	2018-10	2021-10
1.4	SMIQ	Vector Signal Generator 9 kHz - 3.3 GHz	Rohde & Schwarz	G1510	2018-10	2021-10
1.5	ESH3-Z5	Line Impedance Stabilisation Network (LISN) 150 Hz - 30 MHz	Rohde & Schwarz	K794	2019-02	2020-10
1.6	30.3015	ThermoHygro Datalogger	TFA	X 507	2018-08	2021-08
1.7	BAT-EMC	Software	Nexio	V3.17.0.26	---	---

2 Radiated Emissions

Ref.No.	Type	Description	Manufacturer	Inventory no.	Last Calibration	Calibration Due
2.1	ESU40	EMI test receiver 10 Hz - 40 GHz	Rohde & Schwarz	E2025	2018-10	2021-01
2.2	HFH2-Z2	Antenna 9 kHz - 30 MHz	Rohde & Schwarz	K549	2018-10	2021-01
2.3	CBL 6111C	Antenna 30 MHz - 1 GHz	Chase	K1026	2020-01	2021-01
2.4	HL 025	Antenna 1 GHz - 18 GHz	Rohde & Schwarz	K1114	2019-06	2021-06
2.5	MWH-1826/B	Antenna 18 GHz - 26.5 GHz	ARA Inc.	K1042	2018-11	2020-11
2.6	MWH-2640/B	Antenna 26 GHz - 40 GHz	ARA Inc.	K1043	2018-11	2020-11
2.7	AM1431	Pre amplifier 10 kHz - 1 GHz	Miteq	K1721	2019-10	2021-01
2.8	AFS4-00102000	Preamplifier 100 MHz - 20 GHz	Miteq	K817	2019-08	2021-08.
2.9	AFS4-00102000	Preamplifier 100 MHz - 20 GHz	Miteq	K838	2019-10	2021-01
2.10	JS43-1800-4000	Preamplifier 18 GHz - 40 GHz	Miteq	K1104	2019-05	2021-01
2.11	BAT-EMC	Software	Nexio	V3.17.0.26	---	---



6 ANTENNA FACTORS, CABLE LOSS AND SAMPLE CALCULATIONS

This chapter contains the antenna factors with their corresponding path loss of the used measurement path for all antennas.

6.1 ANTENNA CHASE CBL 6111C (30 MHZ – 1 GHZ)

(d = 10 m)

Frequency	AF Horizontal R&S CBL 6111C	AF Vertikal R&S CBL 6111C	Corr.
30	47.9	38.1	-38.1
50	34.4	26.4	-38.0
100	31.6	32.8	-38.0
150	33.7	33.9	-37.9
200	30.3	32.8	-37.7
250	33.6	36.5	-37.5
300	34.5	36.8	-37.1
350	36.3	37.2	-37.0
400	36.9	38.3	-36.8
450	38.0	39.6	-36.5
500	39.2	40.4	-36.0
550	41.2	42.1	-35.9
600	41.6	41.7	-35.7
650	41.9	42.9	-35.9
700	42.3	43.4	-35.6
750	43.5	43.9	-35.7
800	43.6	44.6	-36.0
850	45.0	45.1	-36.1
900	45.2	45.1	-36.6
950	46.4	46.4	-36.4
1000	45.8	47.0	-36.0

cable loss (antenna - pre-amp)	pre-amp	cable loss (inside chamber)	cable loss (to receiver)
-0,01	-38.3	0.0	0.1
0,28	-38.4	0.3	0.1
0,52	-38.7	0.5	0.2
0,73	-38.8	0.7	0.2
0,95	-38.9	1.0	0.3
1,10	-38.9	1.1	0.3
1,20	-38.6	1.2	0.3
1,29	-38.6	1.3	0.3
1,36	-38.5	1.4	0.3
1,42	-38.2	1.4	0.4
1,48	-37.9	1.5	0.4
1,54	-37.8	1.5	0.4
1,60	-37.7	1.6	0.4
1,64	-38.0	1.6	0.5
1,71	-37.8	1.7	0.5
1,76	-38.0	1.8	0.5
1,80	-38.3	1.8	0.5
1,84	-38.4	1.8	0.5
1,91	-39.0	1.9	0.5
1,93	-38.9	1.9	0.6
1,99	-38.6	2.0	0.6

Sample calculation

$$E \text{ (dB } \mu\text{V/m)} = U \text{ (dB } \mu\text{V)} + AF \text{ (dB 1/m)} + \text{Corr. (dB)}$$

U = Receiver reading

AF = Antenna factor

Corr. = sum of single correction factors of used cables, switch unit, distance correction, amplifier (if applicable)

distance correction = $-20 * \text{LOG} (d_{\text{Limit}} / d_{\text{used}})$

Linear interpolation will be used for frequencies in between the values in the table.

Tables show an extract of values.



6.2 ANTENNA ROHDE & SCHWARZ HL 025 (1 GHZ – 18 GHZ)

Frequency	AF R&S HL 025	Corr.
MHz	dB (1/m)	dB
1000	33.2	-18.9
2000	39.4	-17.8
3000	42.8	-17.0
4000	45.1	-16.6
5000	46.8	-16.6
6000	48.5	-16.7
7000	50.2	-16.2
8000	50.4	-15.3
9000	51.9	-14.4
10000	53.8	-14.0
11000	54.5	-14.1
12000	55.3	-14.4
13000	55.7	-14.7
14000	56.5	-14.8
15000	56.4	-14.7
16000	57.2	-14.3
17000	57.6	-14.5
18000	57.6	-14.6

pre-amp	cable loss (to receiver)
dB	dB
-20.92	2.01
-20.60	2.78
-20.44	3.42
-20.58	3.99
-21.08	4.46
-21.53	4.87
-21.53	5.35
-20.97	5.66
-20.44	6.05
-20.43	6.45
-20.84	6.69
-21.41	7.04
-22.09	7.36
-22.48	7.66
-22.56	7.90
-22.49	8.20
-22.90	8.45
-23.27	8.71

Sample calculation

$$E \text{ (dB } \mu\text{V/m)} = U \text{ (dB } \mu\text{V)} + AF \text{ (dB 1/m)} + Corr. \text{ (dB)}$$

U = Receiver reading

AF = Antenna factor

Corr. = sum of single correction factors of used cables, switch unit, distance correction, amplifier (if applicable)

Linear interpolation will be used for frequencies in between the values in the table.

Tables show an extract of values.



6.3 ANTENNA ARA INC. MWH-1826-B (18 GHZ – 26.5 GHZ) PARTIALLY IN CONJUNCTION WITH PRE-AMPLIFIER MITEQ JS43-1800-4000: THE USE OF THE PRE-AMPLIFIER IS DEPENDENT FROM THE FIELD STRENGTH

Frequency	AF EMCO 3160-09	Corr.
MHz	dB (1/m)	dB
18000	44.3	-37.5
18500	43.9	-37.6
19000	44.4	-36.9
19500	44.1	-36.1
20000	44.6	-36.3
20500	44.9	-36.1
21000	45.2	-35.9
21500	45.0	-35.7
22000	45.1	-35.3
22500	45.4	-35.0
23000	45.7	-35.6
23500	45.8	-34.3
24000	45.3	-34.8
24500	45.3	-35.0
25000	46.1	-34.3
25500	46.5	-34.2
26000	46.7	-34.8
26500	46.5	-34.4
27000	46.4	-35.1

pre-amp	cable loss (to receiver)
dB	dB
-46.2	8.7
-46.4	8.8
-45.9	9.0
-45.2	9.1
-45.6	9.3
-45.5	9.4
-45.3	9.4
-45.3	9.7
-45.1	9.8
-44.8	9.8
-45.5	9.9
-44.4	10.1
-45.0	10.2
-45.3	10.4
-44.8	10.5
-44.7	10.5
-45.4	10.6
-45.1	10.7
-46.0	10.9

Sample calculation

$E \text{ (dB } \mu\text{V/m)} = U \text{ (dB } \mu\text{V)} + AF \text{ (dB 1/m)} + Corr. \text{ (dB)}$
 U = Receiver reading
 AF = Antenna factor
 Corr. = sum of single correction factors of used cables, switch unit, distance correction, amplifier (if applicable)
 Linear interpolation will be used for frequencies in between the values in the table.
 Table shows an extract of values.



7 MEASUREMENT UNCERTAINTIES

KDB 935210 D05	ECL
Power measurement	0,68 dB
Measuring AGC threshold level	0,90 dB
Out of band rejection	0,90 dB
Input-versus-output signal comparison	0,91 dB
Mean power output	0,90 dB
Measuring out-of-band/out-of-block (including intermodulation) emissions and spurious emissions	0,90 dB
Out-of-band/out-of-block emissions conducted measurements	0,90 dB
Spurious emissions conducted	2,18 dB
Spurious emissions radiated measurements	5,38 dB
Total frequency uncertainty	2×10^{-7}

Reference :

ECL-MU5.4.6.3-EMC-14-001-V03.00 MU Wireless.xlsx

8 PHOTO REPORT

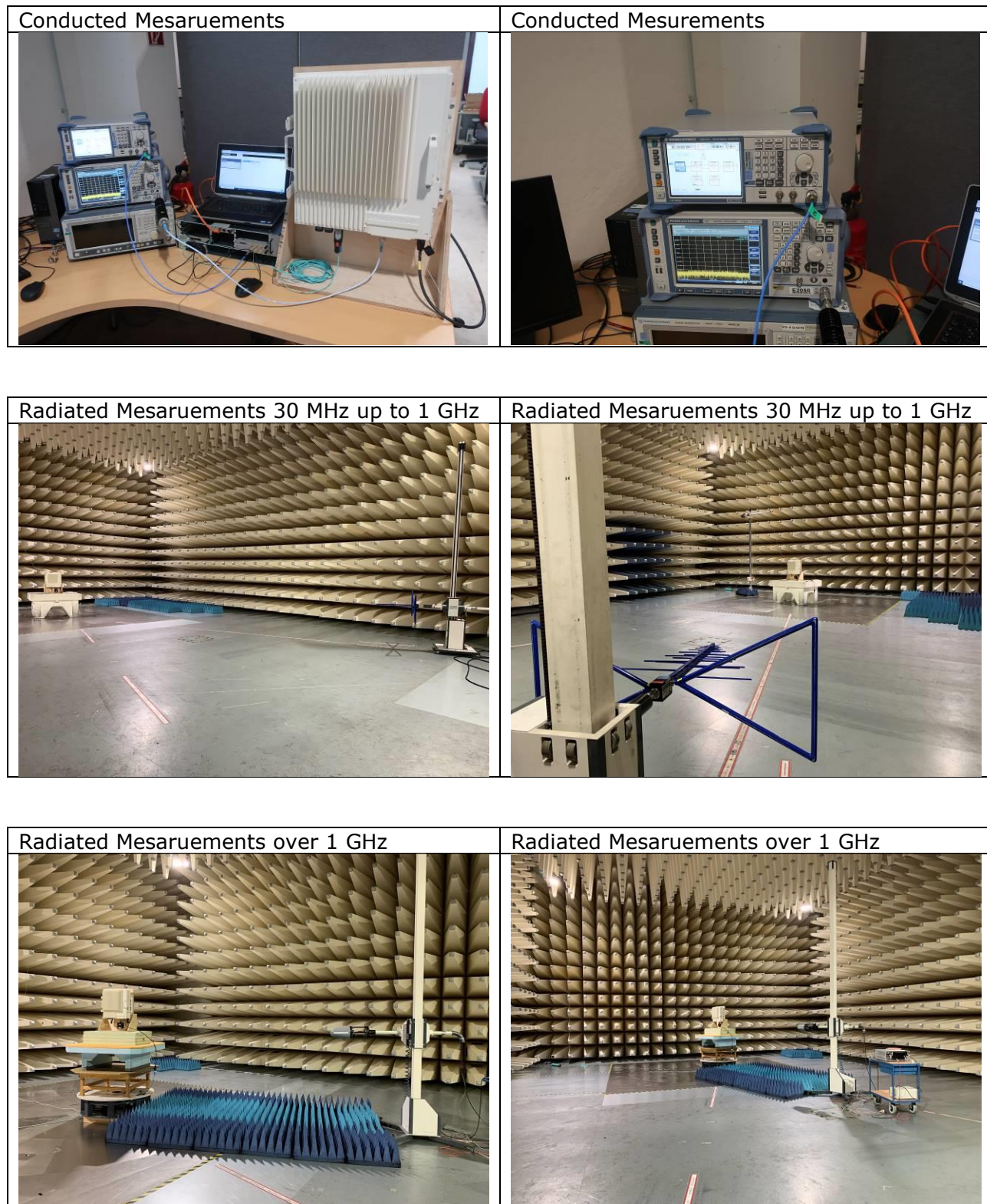



Annex A: Accreditation certificate (for information)

The accreditation relates to competences stated on the accreditation certificate. The current certificate is available on the homepage of the DAkkS and can be downloaded under accredited bodies with the processing number:

<https://www.dakks.de/en>



Annex B: Additional information provided by client

None.

***** End of test report *****