

Test Site:  
FCC Test Site No.: 96997



BUREAU  
VERITAS

## ECL-EMC Test Report No.: 17-143

**Equipment under test:** ION-E OAPL 17E/17E/23/23 C-PE-F1  
2300MHz Path  
**FCC ID:** XS5-OAPL17E23  
**IC ID:**  
**Type of test:** FCC 47 CFR Part 27 Subpart H, F: 2017  
Miscellaneous Wireless Communication Services

**Measurement Procedures:** 47 CFR Parts 2: 2017 (*Frequency Allocations and Radio Treaty Matters; General Rules and Regulations*),  
Part 27: 2017 (*Miscellaneous Wireless Communication Services*),  
ANSI/TIA-603-D:2010, *Land Mobile FM or PM Communications Equipment Measurement and Performance Standards*

**Test result:** **Passed**

Date of issue:	06.07.17	Signature:	
Issue-No.:	01	Author:	
Date of delivery:	04.05.17	Checked:	
Test dates:	21.03. – 05.05.17		
Pages:	52		



**Manufacturer:** ANDREW Wireless Systems GmbH  
Industriering 10

D-86675 Buchdorf

Tel.: +49 (0)9099 69 0

Fax: +49 (0)9099 69 140

**Test Location:** Bureau Veritas Consumer Products Services  
Germany GmbH

European Compliance Laboratory (ECL)

Thurn-und-Taxis-Straße 18

D-90411 Nürnberg

Tel.: +49 40 74041 0

Fax: +49 40 74041-2755

**General:**

The purpose of this report is to show compliance to the FCC regulations for devices operating under Part 27 of the Code of Federal Regulations title 47.

This report informs about the results of the EMC tests, it only refers to the equipment under test. No part of this report may be reproduced in any form, without written permission.



**Table of contents**

1 TEST RESULTS SUMMARY .....5

2 EQUIPMENT UNDER TEST (E.U.T.) .....6

2.1 DESCRIPTION .....6

2.1.1 DOWNLINK .....6

2.1.2 UPLINK .....6

2.1.3 DESCRIPTION OF EUT .....7

2.1.4 BLOCK DIAGRAM OF MEASUREMENT REFERENCE POINTS .....8

2.1.5 LEVELS @ REFERENCE POINTS (DL) .....8

3 TEST SITE (ANDREW BUCHDORF) .....9

3.1 TEST ENVIRONMENT .....9

3.2 TEST EQUIPMENT .....9

3.3 INPUT AND OUTPUT LOSSES .....10

3.4 MEASUREMENT UNCERTAINTY .....10

4 TEST SITE (BUREAU VERITAS CONSUMER PRODUCTS SERVICES) .....10

5 RF POWER OUT: §27.50, §2.1046 .....11

5.1 LIMIT .....11

5.2 TEST METHOD .....11

5.3 TEST RESULTS .....12

5.3.1 DOWNLINK .....12

5.3.1.1 LTE; 5 MHz signal .....14

5.3.1.2 LTE; 10 MHz signal .....15

5.3.2 UPLINK .....16

5.4 SUMMARY TEST RESULT .....16

6 OCCUPIED BANDWIDTH: §2.1049 .....17

6.1 LIMIT .....17

6.2 TEST METHOD .....17

6.3 TEST RESULTS .....17

6.3.1 DOWNLINK .....17

6.3.1.1 LTE; 5 MHz signal; OBW 99% .....19

6.3.1.2 LTE; 5 MHz signal; OBW 26dB .....20

6.3.1.3 LTE; 10 MHz signal; OBW 99% .....21

6.3.1.4 LTE; 10 MHz signal; OBW 26dB .....22

6.3.2 UPLINK .....23

6.4 SUMMARY TEST RESULT .....23

7 SPURIOUS EMISSIONS AT ANTENNA TERMINALS: §27.53, §2.1051 .....24

7.1 LIMIT .....24

7.2 TEST METHOD .....25

7.3 TEST RESULTS .....25

7.3.1 DOWNLINK .....25

7.3.1.1 LTE; 2 x 5 MHz signal .....26

7.3.1.2 LTE; 10 MHz signal .....30



7.3.2	UPLINK .....	33
7.4	SUMMARY TEST RESULT .....	33
8	INTERMODULATION: §27.53, §2.1051.....	34
8.1	LIMIT.....	34
8.2	TEST METHOD .....	35
8.3	TEST RESULTS .....	35
8.3.1	DOWNLINK .....	35
8.3.1.1	LTE; 2 x 5 MHz signal.....	36
8.3.1.2	LTE; 10 MHz signal .....	37
8.3.2	UPLINK .....	37
8.4	SUMMARY TEST RESULT .....	37
9	OUT OF BAND REJECTION .....	38
9.1	LIMIT.....	38
9.2	TEST METHOD .....	38
9.3	TEST RESULTS .....	38
9.3.1	DOWNLINK .....	39
9.3.2	UPLINK .....	39
9.4	SUMMARY TEST RESULT .....	39
10	RADIATED SPURIOUS EMISSIONS AT THE ECL (BV): §27.53, §2.1053, RSS-GEN, RSS-131	40
10.1	METHOD OF MEASUREMENT .....	43
10.2	LIMIT .....	44
10.3	RECEIVER SETTINGS.....	45
10.4	CLIMATIC VALUES IN THE LAB.....	45
10.5	TEST RESULTS.....	46
10.5.1	30 MHz TO 1 GHz DOWNLINK (BOTTOM – MIDDLE – TOP) .....	46
10.5.2	30 MHz TO 1 GHz DOWNLINK (MIDDLE OF BOTH PATHS) .....	47
10.5.3	1 GHz TO 18 GHz DOWNLINK (BOTTOM – MIDDLE – TOP) .....	48
10.5.4	1 GHz TO 18 GHz DOWNLINK (MIDDLE OF BOTH PATHS).....	49
10.5.5	18 GHz TO 26.5 GHz DOWNLINK (BOTTOM – MIDDLE – TOP) .....	50
10.5.6	18 GHz TO 26.5 GHz DOWNLINK (MIDDLE OF BOTH PATHS).....	51
11	HISTORY .....	52



# 1 Test Results Summary

Name of Test	FCC Para. No.	FCC Method	FCC Spec.	Result
RF Power Output	27.50(d)	2.1046	1640 Watts/MHz	Complies
Occupied Bandwidth	KDB 935210 D02 v03r02	2.1049	Input/Output	Complies
Spurious Emissions at Antenna Terminals	27.53(h)	2.1051	-13dBm	Complies
Field Strength of Spurious Emissions	27.53(m)	2.1053 TIA/EA-603	-13dBm E.I.R.P	Complies
Intermodulation	KDB 935210 D02 v03r02	KDB 935210 D02 v03r02	KDB 935210 D02 v03r02	Complies
Frequency Stability	27.54	2.1055	Must stay in band	NA
Out of Band Rejection	KDB 935210 D02 v03r02	KDB 935210 D03 v04	KDB 935210 D03 v04	Complies

Frequency stability is given by: The system gets an electrical analog signal from the BSS which is converted into an analog optical signal, transmitted by the optical links and then reconverted in the Remote Unit into an analog electrical signal. During this process happens no frequency change/modification, so input and output have same frequency what can be seen under clause "Occupied Bandwidth".



## 2 Equipment under test (E.U.T.)

### 2.1 Description

Kind of equipment	ION-E OAPL 17E/17E/23/23 (Remote Unit)
Andrew Ident. Number	7770203-0001
Serial no.(SN)	M002E1-R7506E2
Revision	00
Software version and ID	n. a.
Type of modulation and Designator	LTE (G7D) <input checked="" type="checkbox"/>
Frequency Translation	F1-F1 <input checked="" type="checkbox"/>
	F1-F2 <input type="checkbox"/>
	N/A <input type="checkbox"/>
Band Selection	Software <input checked="" type="checkbox"/>
	Duplexer <input checked="" type="checkbox"/>
	Full band <input type="checkbox"/>

#### 2.1.1 Downlink

Pass band	2350 MHz – 2360 MHz
Max. composite output power based on one carrier per path (rated)	20 dBm = 0.1 W
MIMO max. composite output power based on one carrier per path (rated)	23 dBm = 0.2 W
System Gain**	25 dB @ Pout BTS of 20 dBm

\*\*see 2.1.5

#### 2.1.2 Uplink

Pass band	2305 MHz – 2315 MHz
Maximum rated output power	n. a.
System Gain**	n. a.

\*\*see 2.1.5

Note: The EUT does not transmit over the air in the uplink direction.



### 2.1.3 Description of EUT

CommScope's ION-E OAPL 17E/17E/23/23 is a multi-band, multi-operator Remote Unit. It is used in conjunction with a Master Unit (CAN) with poe. This system transports up to four frequency bands simultaneously, providing a cost-effective solution for distributing capacity from one or more base stations. The ION-E OAPL system can use for MIMO application in all RF paths.

This Test Report describes only the approval of the 2300 MHz Path.

The ION-E OAPL 17E/17E/23/23 Repeater system consists of one (or two in MIMO operation) 1700/2100 AWS-E MHz path and one 2300 MHz path with the intended use of simultaneous transmission.

The antenna(s) used with device must be fixed-mounted on permanent structures.

**2.1.4 Block diagram of measurement reference points**

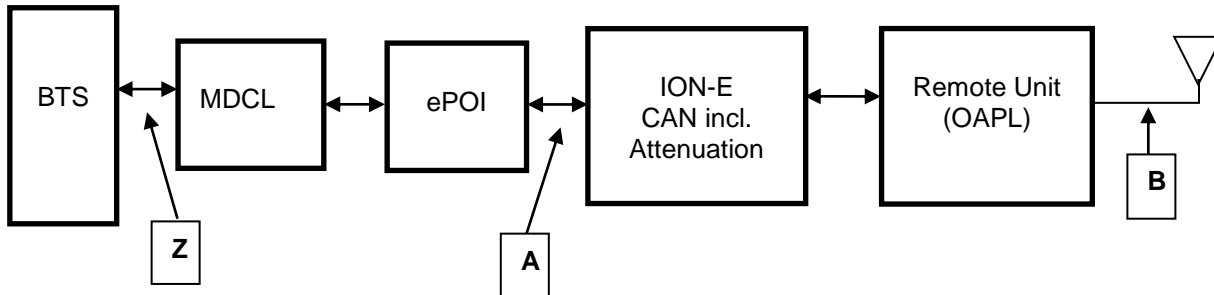

figure 2.1.4-#1 Block diagram of measurement reference points

Remote Unit (OAPL) is the DUT

- MU            Master Unit = ePOI and CAN
- RU            Remote Unit = OAPL
- OAPL        Optimized Access Point Low Power
- CAN         Central Area Node
- CAN att     Attenuation of Central Access Node
- MDCL       Minimum Donor Coupling Loss

Reference point A, CAN UL output, DL input  
 Reference point B, Remote Unit DL output, UL input  
 Reference point Z, BTS DL input, BTS UL output

**2.1.5 Levels @ reference points (DL)**

System optimized for BTS power	MDCL + ePOI Attenuation	Maximum rated input power at the CAN	RU (OAPL) Gain	Maximum rated output power at OAPL Antenna port
Z		A	A to B	B
<b>+33 dBm</b> <i>@ 1 carrier</i>	<b>39 dB</b>	<b>-6 dBm</b>	<b>26 dB</b>	<b>+20 dBm</b> <i>@ 1 carrier</i>
<b>System Gain</b> <b>Z to B</b>	<b>-13 dB</b>			
<b>2x (+33 dBm)</b>	<b>42 dB</b>	<b>-9 dBm / carrier</b> <i>@ 2 carrier</i>	<b>26 dB</b>	<b>+17 dBm / carrier</b> <i>@ 2 carrier</i>
<b>System Gain</b> <b>Z to B</b>	<b>-16 dB</b>			
<b>+43 dBm</b>	<b>49 dB</b>	<b>-6 dBm</b>	<b>26 dB</b>	<b>+20 dBm</b> <i>@ 1 carrier</i>
<b>System Gain</b> <b>Z to B</b>	<b>-13 dB</b>			

table 2.1.5-#1 Equipment under test (E.U.T.) Description Levels @ reference points (DL)



### 3 Test site (Andrew Buchdorf)

#### 3.1 Test environment

All tests were performed under the following environmental conditions:

Condition	Minimum value	Maximum value
Barometric pressure	86 kPa	106 kPa
Temperature	15°C	30°C
Relative Humidity	20 %	75 %
Power supply range	±5% of rated voltages	

#### 3.2 Test equipment

ANDREW Inv. No.	Test equipment	Type	Manufacturer	Serial No.	Next Calibration Date
9126	Spectrum Analyzer	FSV 30	R&S	101237	08/2017
9069	Generator	SMBV100A	R&S	256275	08/2017
9046	Generator	SMBV100A	R&S	255090	05/2017
8542	Power Meter	E4418A	Agilent	GB38273230	01/2018
8544	Power Sensor	E8481H	Agilent	3318A19208	01/2018
7583	RF-Cable	Testpro 4.2	Radiall	---	CIU
7584	RF-Cable	Testpro 4.2	Radiall	---	CIU
7585	RF-Cable	Testpro 4.2	Radiall	---	CIU
7586	RF-Cable	Testpro 4.2	Radiall	---	CIU
7537	RF-Cable	Testpro 4.2 + Projack	Radiall	---	CIU
7542	RF-Cable	Testpro 4.2 + Projack	Radiall	---	CIU
7	Notch-Filter	WRCT20 2350-2360	Wainwright	1	CIU
7406	Matrix		COMMSCOPE	---	weekly

CIU = Calibrate in use



### 3.3 Input and output losses

All recorded power levels should be referenced to the input and output connectors of the repeater, unless explicitly stated otherwise.

The test equipment used in this test has to be calibrated, so that the functionality is also checked.

All cables, attenuators, splitter, isolator, circulator and combiner etc. must be measured before testing and used for compensation during testing.

### 3.4 Measurement uncertainty

The extended measurement uncertainty corresponds to the measurement results from the standard measurement uncertainty multiplied by the coverage factor  $k=2$ . The true value is located in the corresponding interval with a probability of 95 %.

## 4 Test site (Bureau Veritas Consumer Products Services)

FCC Test site:

IC OATS:

See relevant dates under section 10 of this test report.

## 5 RF Power Out: §27.50, §2.1046

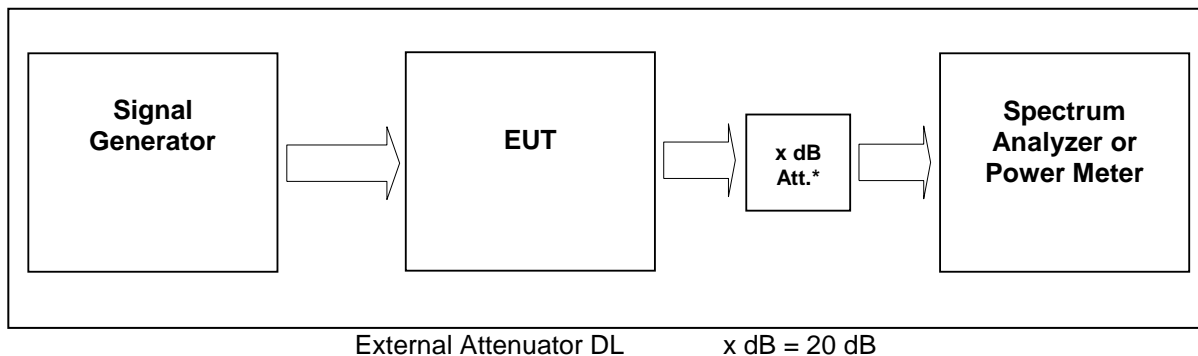

figure 5-#1 Test setup: RF Power Out: §27.50, §2.1046

Measurement uncertainty	± 0,32 dB
Test equipment used	9046, 9126, 7406, 7157, 7158, 7289, 7290, 7385

### 5.1 Limit

Minimum standard:  
Para. No.27.50(a)

(a) The following power limits and related requirements apply to stations transmitting in the 2305-2320 MHz band or the 2345-2360 MHz band.

(1) *Base and fixed stations.* (i) For base and fixed stations transmitting in the 2305-2315 MHz band or the 2350-2360 MHz band:

(A) The average equivalent isotropically radiated power (EIRP) must not exceed 2,000 watts within any 5 megahertz of authorized bandwidth and must not exceed 400 watts within any 1 megahertz of authorized bandwidth.

(B) The peak-to-average power ratio (PAPR) of the transmitter output power must not exceed 13 dB. The PAPR measurements should be made using either an instrument with complementary cumulative distribution function (CCDF) capabilities to determine that PAPR will not exceed 13 dB for more than 0.1 percent of the time or other Commission approved procedure. The measurement must be performed using a signal corresponding to the highest PAPR expected during periods of continuous transmission.

(ii) For base and fixed stations transmitting in the 2315-2320 MHz band or the 2345-2350 MHz band, the peak EIRP must not exceed 2,000 watts.

### 5.2 Test method

§ 2.1046 Measurements required: RF power output.

(a) For transmitters other than single sideband, independent sideband and controlled carrier radiotelephone, power output shall be measured at the RF output terminals when the transmitter is adjusted in accordance with the tune-up procedure to give the values of current and voltage on the circuit elements specified in § 2.1033(c)(8). The electrical characteristics of the radio frequency load attached to the output terminals when this test is made shall be stated.



(c) For measurements conducted pursuant to paragraphs (a) and (b) of this section, all calculations and methods used by the applicant for determining carrier power or peak envelope power, as appropriate, on the basis of measured power in the radio frequency load attached to the transmitter output terminals shall be shown. Under the test conditions specified, no components of the emission spectrum shall exceed the limits specified in the applicable rule parts as necessary for meeting occupied bandwidth or emission limitations

### 5.3 Test Results

Detector RMS.

Test signal LTE:

Signal waveform according to Test Model 1.1, E-TM1.1, clause 6.1.1.1-1, table 6.1.1.1-1 of standard specification 3GPP TS 36.141 V9.3.0 (2010-03).

#### 5.3.1 Downlink

Modulation	Measured at	F / MHz	RBW VBW Span	Crest (dB)	RF Power (dBm)	RF Power (W)	MIMO RF Power (W)	Plot -
LTE 5 MHz	Middle	2355 MHz	100kHz 300kHz 20MHz	9.45	20.0	0.1	0.2	5.3.1.1 #1
LTE 10 MHz	Middle	2355 MHz	100kHz 300kHz 20MHz	9.77	20.0	0.1	0.2	5.3.1.2 #1
Maximum output power = 20 dBm = 0.1 W								
Limit Maximum output power (eirp) = 2000 W / 5MHz ( 400 W / 1MHz)								

table 5.3.1-#1 RF Power Out: §27.50, §2.1046 Test Results Downlink

The max RF Power out is 20 dBm, so the maximum antenna gain (x) can be calculated as follow:

**Limit = 2000W (eirp) = 63 dBm**

Info: eirp = erp \* 1.64

$63 \text{ dBm} > 20 \text{ dBm} + x \rightarrow x = 63 \text{ dBm} - 20 \text{ dBm} = \underline{43 \text{ dBd}}$

$x \text{ dBi} = 43 \text{ dBd} + 2.15 = \underline{45.15 \text{ dBi}}$

=> The antenna that will be used for the complete system have to have a gain lower than 45.15 dBi, relative to a dipol.



**MIMO:**

The MIMO max RF Power out is 23 dBm, so the maximum antenna gain (x) can be calculated as follow:

**Limit = 2000W (eirp) = 63 dBm**

Info: eirp = erp \* 1.64

$63 \text{ dBm} > 23 \text{ dBm} + x \text{ -----} \rightarrow x = 63 \text{ dBm} - 23 \text{ dBm} = \underline{40 \text{ dBd}}$

$x \text{ dBi} = 40 \text{ dBd} + 2.15 = \underline{42.15 \text{ dBi}}$

=> The antenna that will be used for the complete system have to have a gain lower than 42.15 dBi, relative to a dipol.

Modulation	Pin / dBm (Ref. point A)
LTE 5 MHz signal	-5.0
LTE 10 MHz signal	-5.0

table 5.3.1-#2 RF Power Out: §27.50, §2.1046 Test Results Downlink Input power



5.3.1.1 LTE; 5 MHz signal

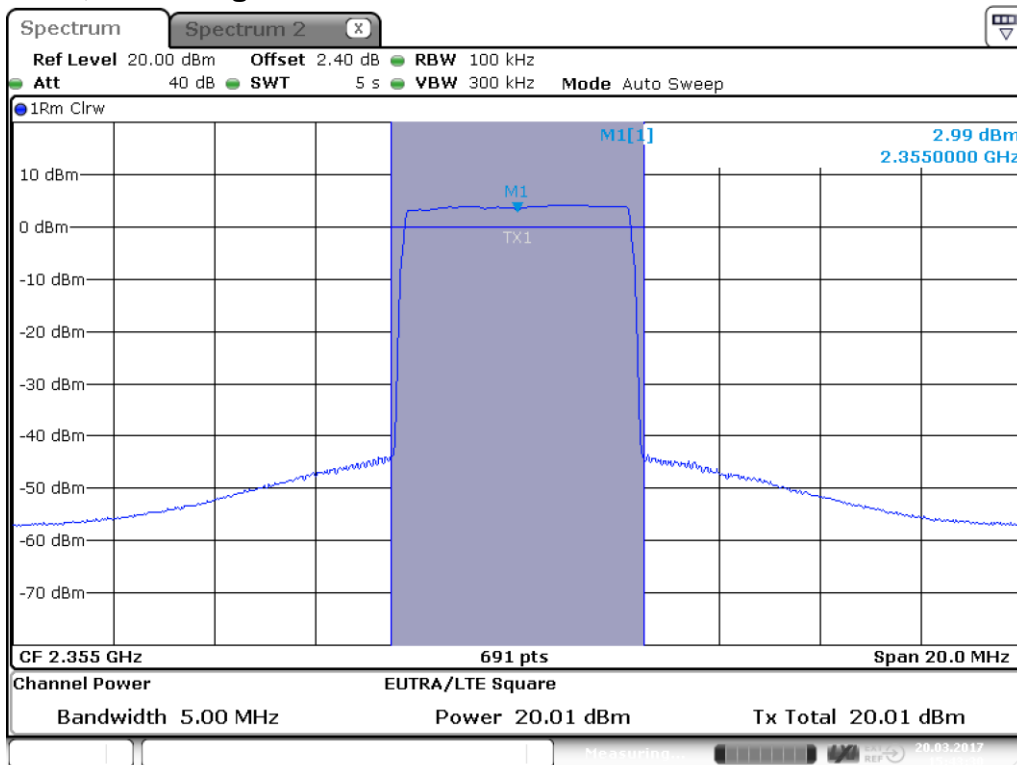

Date: 20.MAR.2017 15:43:30

plot 5.3.1.1-#1 RF Power Out: §27.50, §2.1046; Downlink; LTE; 5 MHz signal Middle

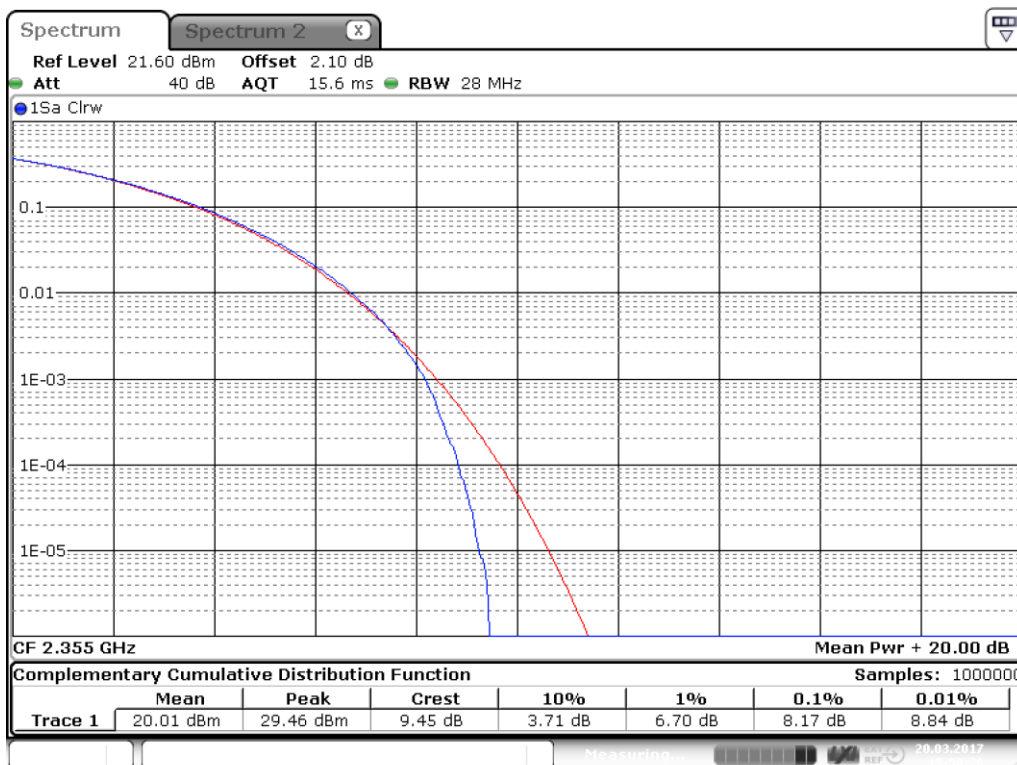

Date: 20.MAR.2017 15:58:27

plot 5.3.1.1-#2 RF Power Out: §27.50, §2.1046; Downlink; LTE; 5 MHz signal Middle; CCDF



5.3.1.2 LTE; 10 MHz signal

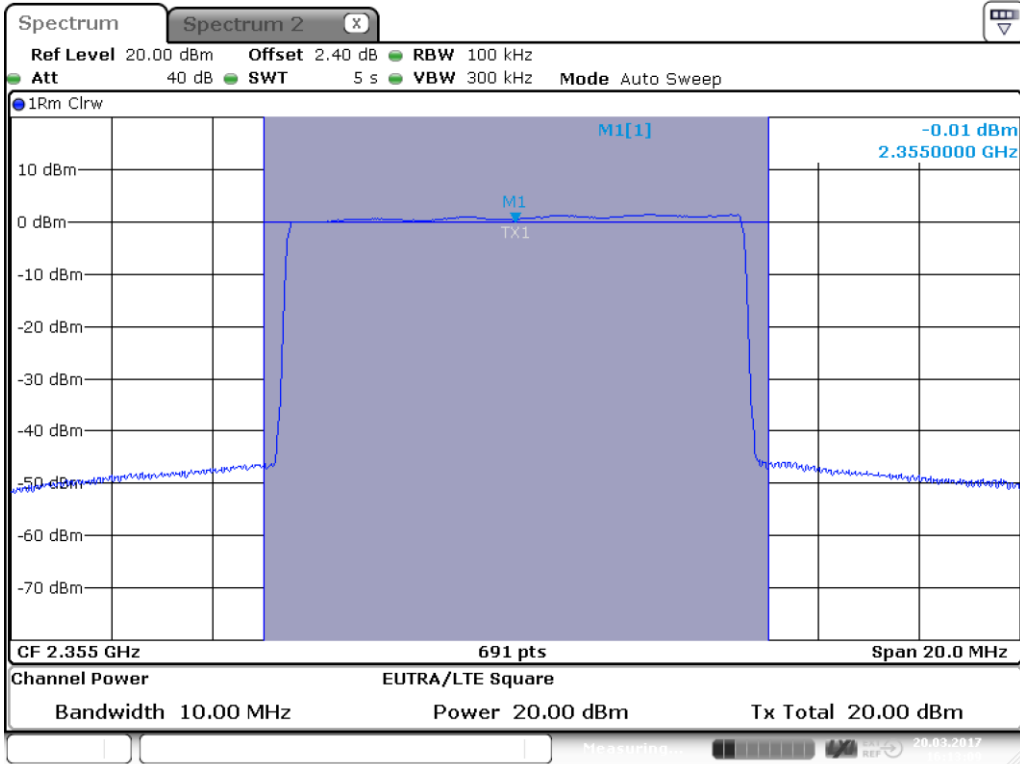

Date: 20.MAR.2017 16:13:10

plot 5.3.1.2-#1 RF Power Out: §27.50, §2.1046; Downlink; LTE; 10 MHz signal Middle

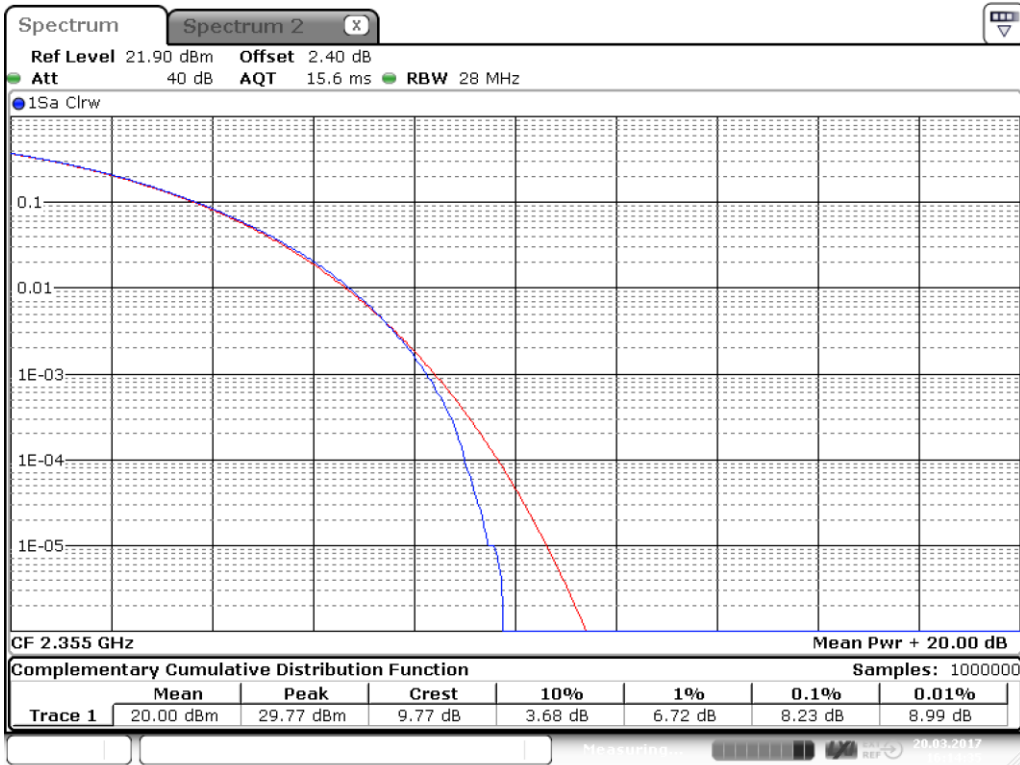

Date: 20.MAR.2017 16:14:35

plot 5.3.1.2-#2 RF Power Out: §27.50, §2.1046; Downlink; LTE; 10 MHz signal Middle; CCDF



### 5.3.2 Uplink

n.a.

Note: The EUT does not transmit over the air in the uplink direction.

### 5.4 Summary test result

Test result	complies, according the plots above
Tested by:	F. Bengesser
Date:	20.03.2017





## 6 Occupied Bandwidth: §2.1049

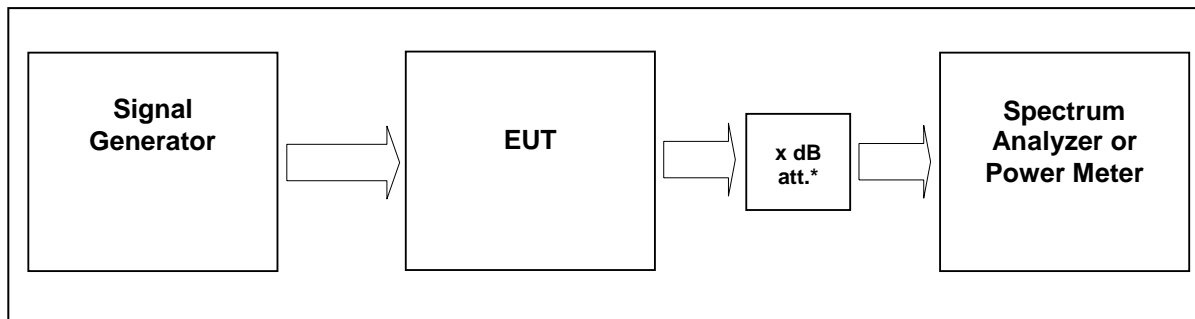

External Attenuator DL      x dB = 20 dB  
 figure 6-#1 Test setup: Occupied Bandwidth: §2.1049

Measurement uncertainty	± 0,33 dB
Test equipment used	9046, 9126, 7406, 7157, 7158, 7289, 7290, 7385

### 6.1 Limit

The spectral shape of the output should look similar to input for all modulations.

### 6.2 Test method

Para. No.2.1049

The occupied bandwidth, that is the frequency bandwidth such that, below its lower and above its upper frequency limits, the mean powers radiated are each equal to 0.5 percent of the total mean power radiated by a given emission shall be measured under the following conditions as applicable:

### 6.3 Test results

#### 6.3.1 Downlink

Detector PK.

Modulation	Measured at	F / MHz	RBW VBW Span	Occupied Bandwidth / MHz	Plot #
LTE 5 MHz	Middle	2355	100 kHz 200 kHz 15 MHz	4.47	6.3.1.1 #1, #2
LTE 10 MHz	Middle	2355	200 kHz 300 kHz 30 MHz	8.94	6.3.1.3 #1, #2



Modulation	Measured at	F / MHz	RBW VBW Span	26dB Bandwidth / MHz	Plot #
LTE 5 MHz	Middle	2355	100 kHz 200 kHz 15 MHz	4.82	6.3.1.2 #1, #2
LTE 10 MHz	Middle	2355	200 kHz 300 kHz 30 MHz	9.38	6.3.1.4 #1, #2

table 6.3-#1 Occupied Bandwidth: §2.1049 Test results



6.3.1.1 LTE; 5 MHz signal; OBW 99%

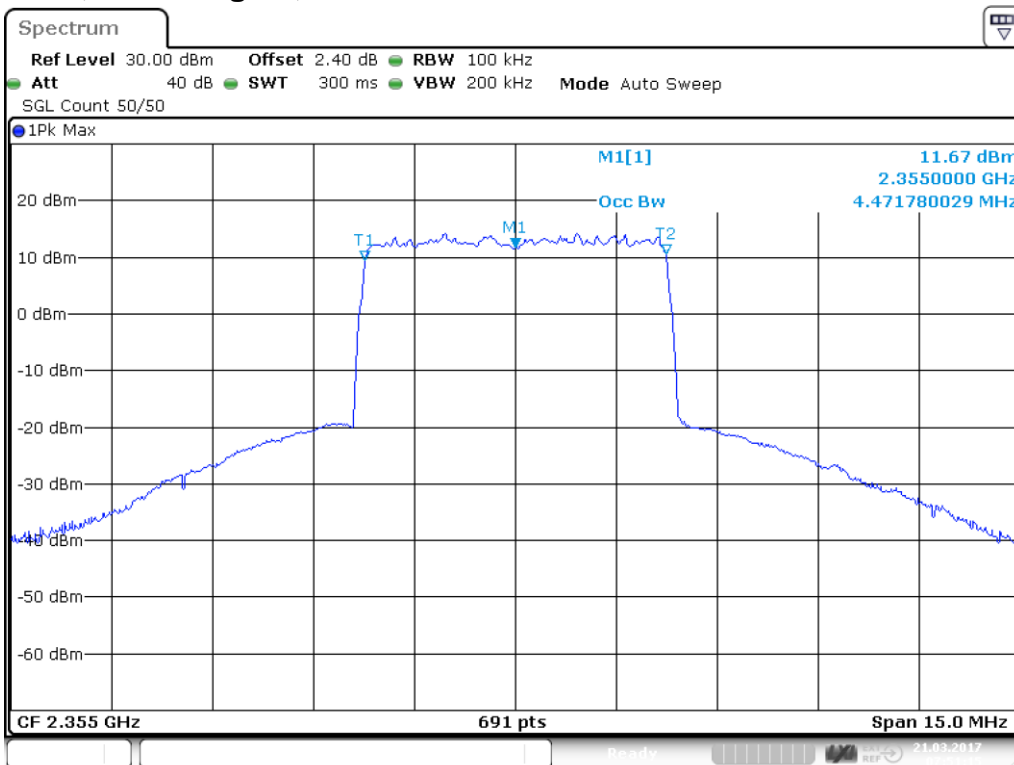

plot 6.3.1.1-#1 Occupied Bandwidth: \$2.1049; Test results; Downlink; LTE; 5 MHz signal; OBW 99% Output

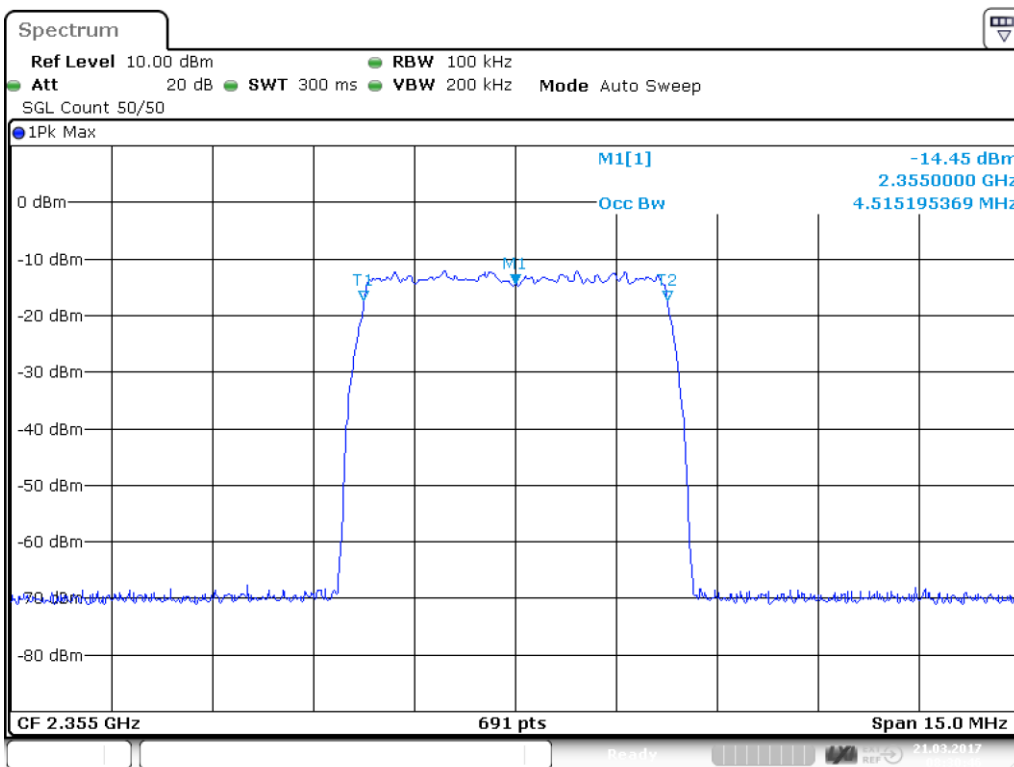

plot 6.3.1.1-#2 Occupied Bandwidth: \$2.1049; Test results; Downlink; LTE; 5 MHz signal; OBW 99% Input



6.3.1.2 LTE; 5 MHz signal; OBW 26dB

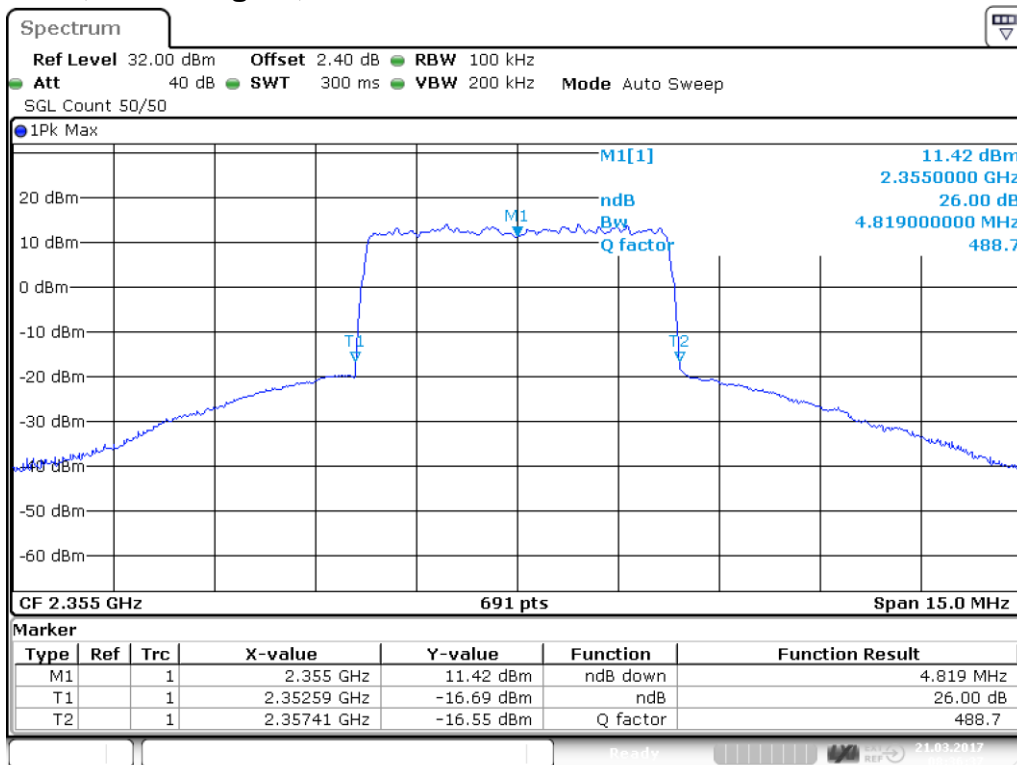

Date: 21.MAR.2017 08:36:37

plot 6.3.1.2-#1 Occupied Bandwidth: §2.1049; Test results; Downlink; LTE; 5 MHz signal; OBW 26dB Output

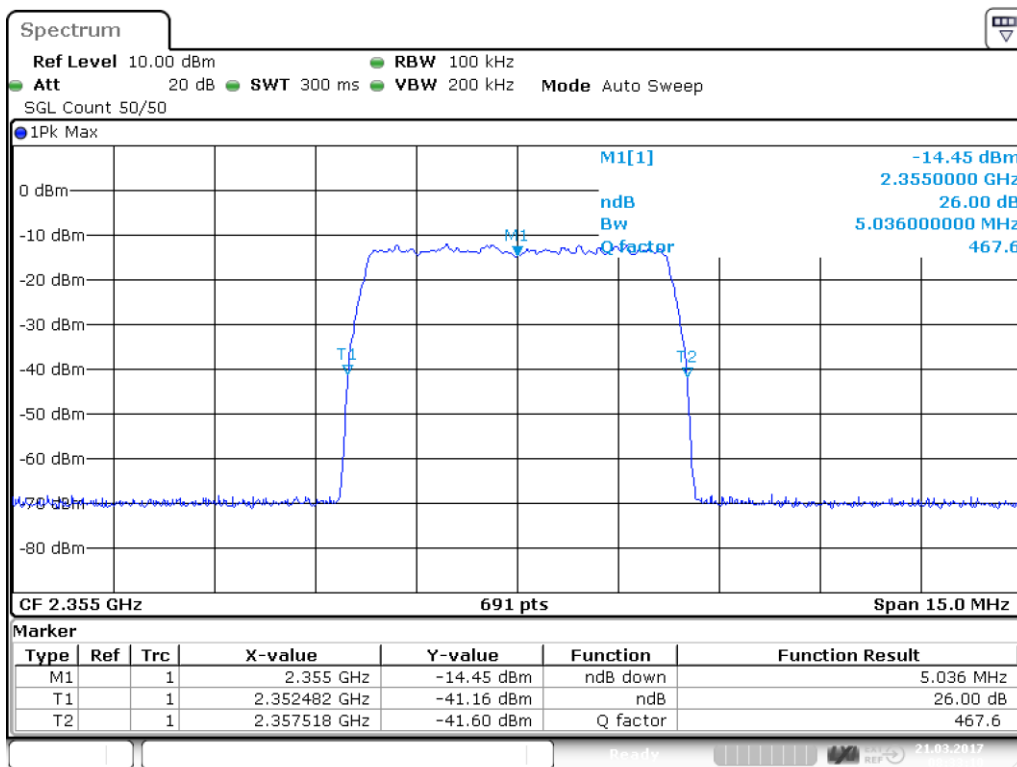

Date: 21.MAR.2017 08:33:10

plot 6.3.1.2-#2 Occupied Bandwidth: §2.1049; Test results; Downlink; LTE; 5 MHz signal; OBW 26dB Input



6.3.1.3 LTE; 10 MHz signal; OBW 99%

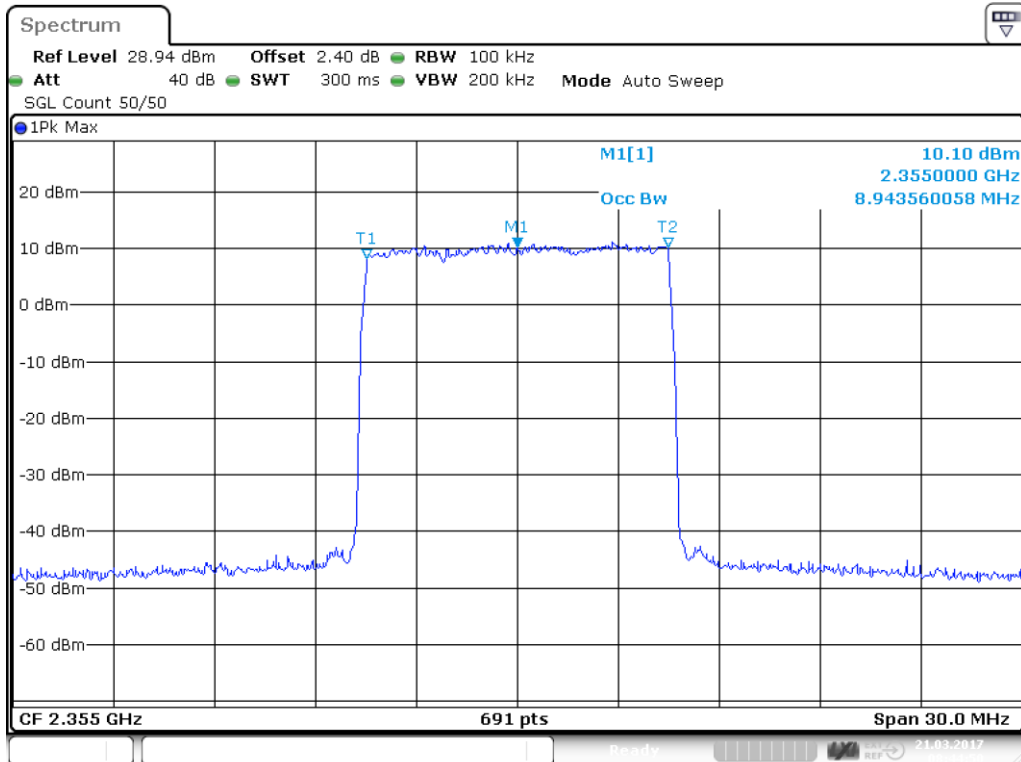

Date: 21.MAR.2017 08:44:50

plot 6.3.1.3-#1 Occupied Bandwidth: §2.1049; Test results; Downlink; LTE; 10 MHz signal; OBW 99% Output

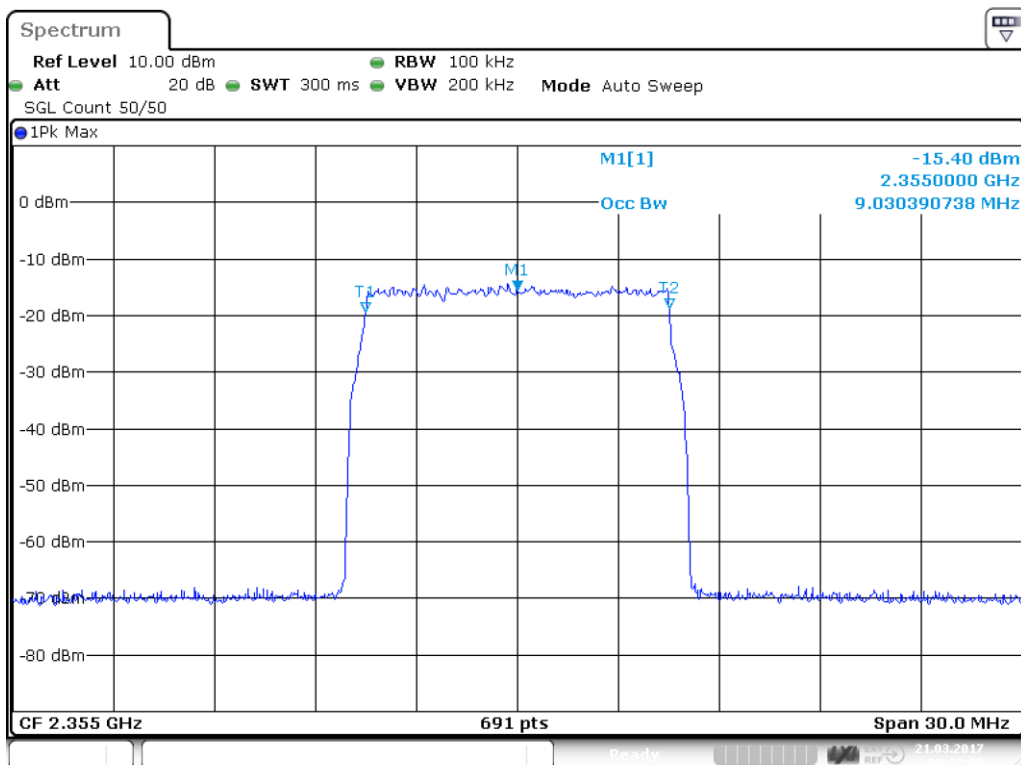

Date: 21.MAR.2017 08:22:00

plot 6.3.1.3-#2 Occupied Bandwidth: §2.1049; Test results; Downlink; LTE; 10 MHz signal; OBW 99% Input



6.3.1.4 LTE; 10 MHz signal; OBW 26dB

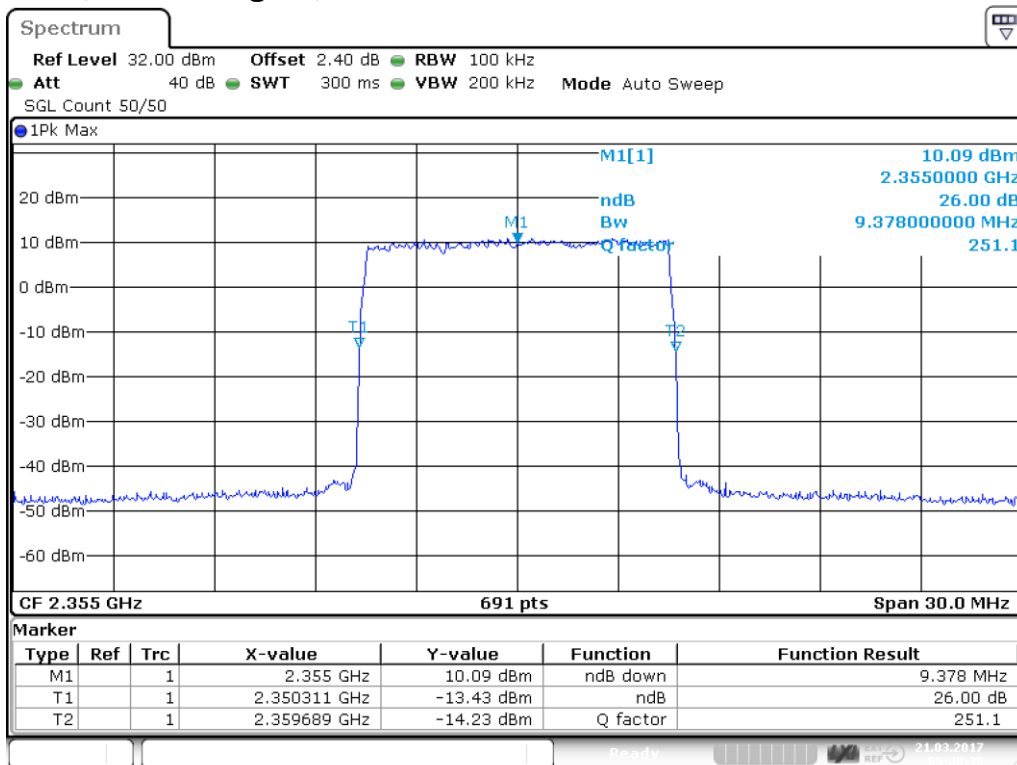

Date: 21.MAR.2017 08:40:35

plot 6.3.1.4-#1 Occupied Bandwidth: §2.1049; Test results; Downlink; LTE; 10 MHz signal; OBW 26dB Output

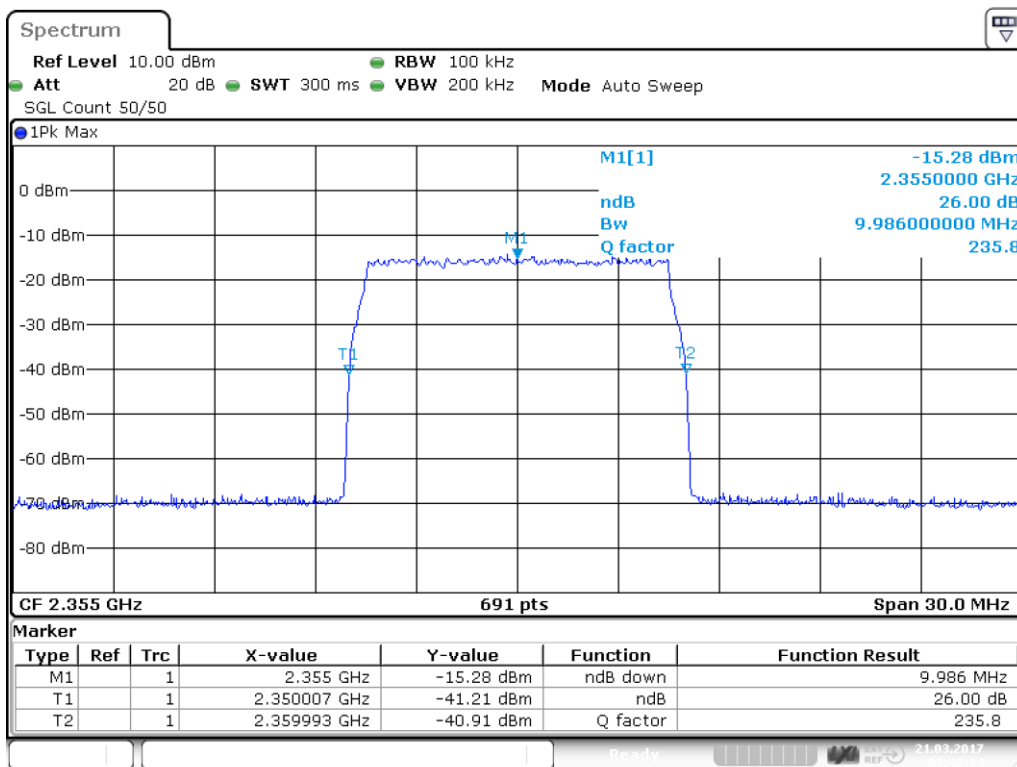

Date: 21.MAR.2017 08:42:14

plot 6.3.1.4-#2 Occupied Bandwidth: §2.1049; Test results; Downlink; LTE; 10 MHz signal; OBW 26dB Input



### 6.3.2 Uplink

n.a.

Note: The EUT does not transmit over the air in the uplink direction.

### 6.4 Summary test result

Test result	complies, according the plots above
Tested by:	F. Bengesser
Date:	21.03.2017

## 7 Spurious Emissions at Antenna Terminals: §27.53, §2.1051

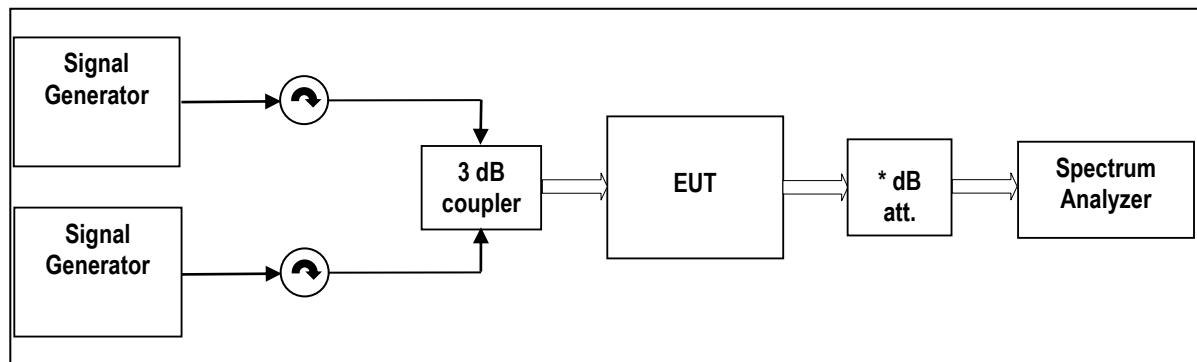

External Attenuator DL x dB = 20 dB  
 figure 7-#1 Test setup: Spurious Emissions at Antenna Terminals: §27.53, §2.1051

Measurement uncertainty	± 0,41 dB ± 0,47 dB ± 0.94 dB ± 1.2 dB	9 kHz to 3,6 GHz 3,6 GHz to 7 GHz 7 GHz to 13,6 GHz 13,6 GHz to 30 GHz
Test equipment used	9069, 9046, 9126, 7406, 7157, 7158, 7289, 7290, 7531, 7385	

### 7.1 Limit

(a) For operations in the 2305-2320 MHz band and the 2345-2360 MHz band, the power of any emission outside a licensee's frequency band(s) of operation shall be attenuated below the transmitter power P (with averaging performed only during periods of transmission) within the licensed band(s) of operation, in watts, by the following amounts:

(1) For base and fixed stations' operations in the 2305-2320 MHz band and the 2345-2360 MHz band:

(i) By a factor of not less than  $43 + 10 \log (P)$  dB on all frequencies between 2305 and 2320 MHz and on all frequencies between 2345 and 2360 MHz that are outside the licensed band(s) of operation, and not less than  $75 + 10 \log (P)$  dB on all frequencies between 2320 and 2345 MHz;

(ii) By a factor of not less than  $43 + 10 \log (P)$  dB on all frequencies between 2300 and 2305 MHz,  $70 + 10 \log (P)$  dB on all frequencies between 2287.5 and 2300 MHz,  $72 + 10 \log (P)$  dB on all frequencies between 2285 and 2287.5 MHz, and  $75 + 10 \log (P)$  dB below 2285 MHz;

(iii) By a factor of not less than  $43 + 10 \log (P)$  dB on all frequencies between 2360 and 2362.5 MHz,  $55 + 10 \log (P)$  dB on all frequencies between 2362.5 and 2365 MHz,  $70 + 10 \log (P)$  dB on all frequencies between 2365 and 2367.5 MHz,  $72 + 10 \log (P)$  dB on all frequencies between 2367.5 and 2370 MHz, and  $75 + 10 \log (P)$  dB above 2370 MHz.

(2) For fixed customer premises equipment (CPE) stations operating in the 2305-2320 MHz band and the 2345-2360 MHz band transmitting with more than 2 watts per 5 megahertz average EIRP:

(i) By a factor of not less than  $43 + 10 \log (P)$  dB on all frequencies between 2305 and 2320 MHz and on all frequencies between 2345 and 2360 MHz that are outside the licensed band(s) of operation, and not less than  $75 + 10 \log (P)$  dB on all frequencies between 2320 and 2345 MHz;





(ii) By a factor of not less than  $43 + 10 \log (P)$  dB on all frequencies between 2300 and 2305 MHz,  $70 + 10 \log (P)$  dB on all frequencies between 2287.5 and 2300 MHz,  $72 + 10 \log (P)$  dB on all frequencies between 2285 and 2287.5 MHz, and  $75 + 10 \log (P)$  dB below 2285 MHz;

(iii) By a factor of not less than  $43 + 10 \log (P)$  dB on all frequencies between 2360 and 2362.5 MHz,  $55 + 10 \log (P)$  dB on all frequencies between 2362.5 and 2365 MHz,  $70 + 10 \log (P)$  dB on all frequencies between 2365 and 2367.5 MHz,  $72 + 10 \log (P)$  dB on all frequencies between 2367.5 and 2370 MHz, and  $75 + 10 \log (P)$  dB above 2370 MHz.

If the DUT used in MIMO configuration according to KDB 662911, the summed emission (MIMO Max. Level) is calculated (Max. Level) of the output port plus  $10 \log (N_{ANT})$ . With  $(N_{ANT}=2)$  the MIMO Max. Level (dBm) equals Max. Level (dBm) plus 3dB.

### 7.2 Test method

Para. No 2.1051 Measurements required: Spurious emissions at antenna terminals. The radio frequency voltage or powers generated within the equipment and appearing on a spurious frequency shall be checked at the equipment output terminals when properly loaded with a suitable artificial antenna. Curves or equivalent data shall show the magnitude of each harmonic and other spurious emission that can be detected when the equipment is operated under the conditions specified in § 2.1049 as appropriate. The magnitude of spurious emissions which are attenuated more than 20 dB below the permissible value need not be specified.

[39 FR 5919, Feb. 15, 1974. Redesignated and amended at 63 FR 36599, July 7, 1998]

Measurements compliant with PAR 9.1 / 8.9 dB.

### 7.3 Test results

#### 7.3.1 Downlink

Detector: RMS.

Modulation	Carrier(s) F / MHz	Limit pass/fail	Limit with MIMO pass/fail	Plot -
2 x LTE 5 MHz	2352.5 2357.5	pass	pass	7.3.1.1 1 - 6
LTE 10 MHz	2355	pass	pass	7.3.1.2 1 - 6

table 7.3-#1 Spurious Emissions at Antenna Terminals: §27.53, §2.1051 Test results



### 7.3.1.1 LTE; 2 x 5 MHz signal

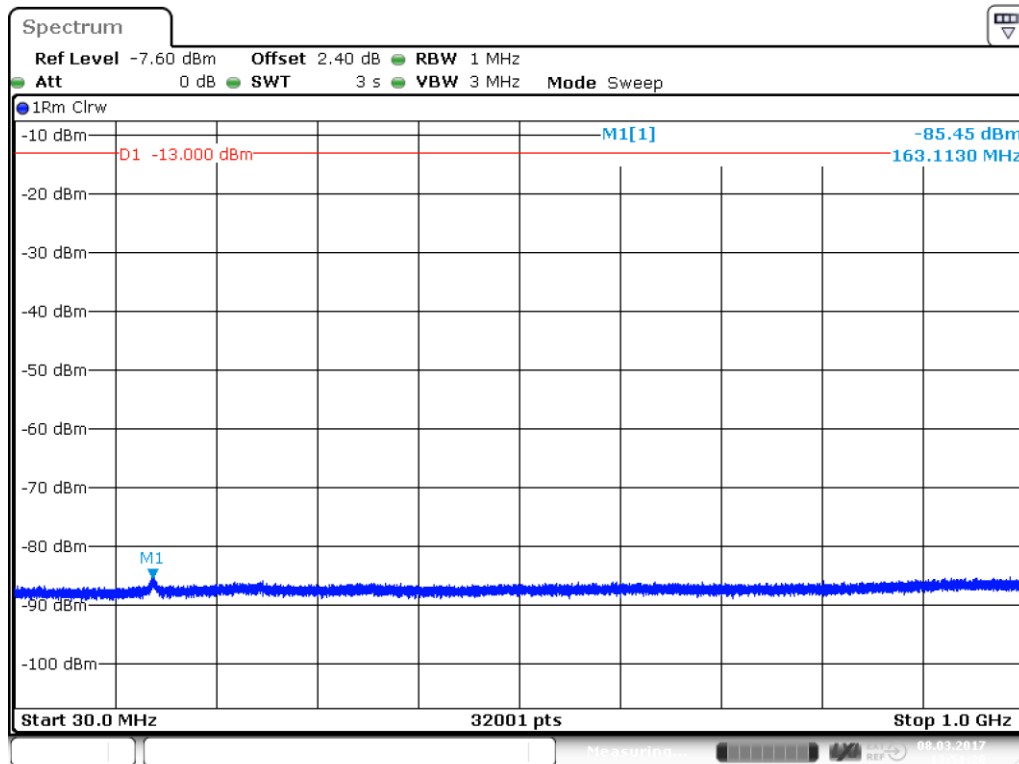

Date: 8.MAR.2017 13:51:21

plot 7.3.1.1-#1 Spurious Emissions at Antenna Terminals: §27.53, §2.1051; Test results; Downlink; LTE; 2 x 5 MHz signal; 30 MHz – 1 GHz

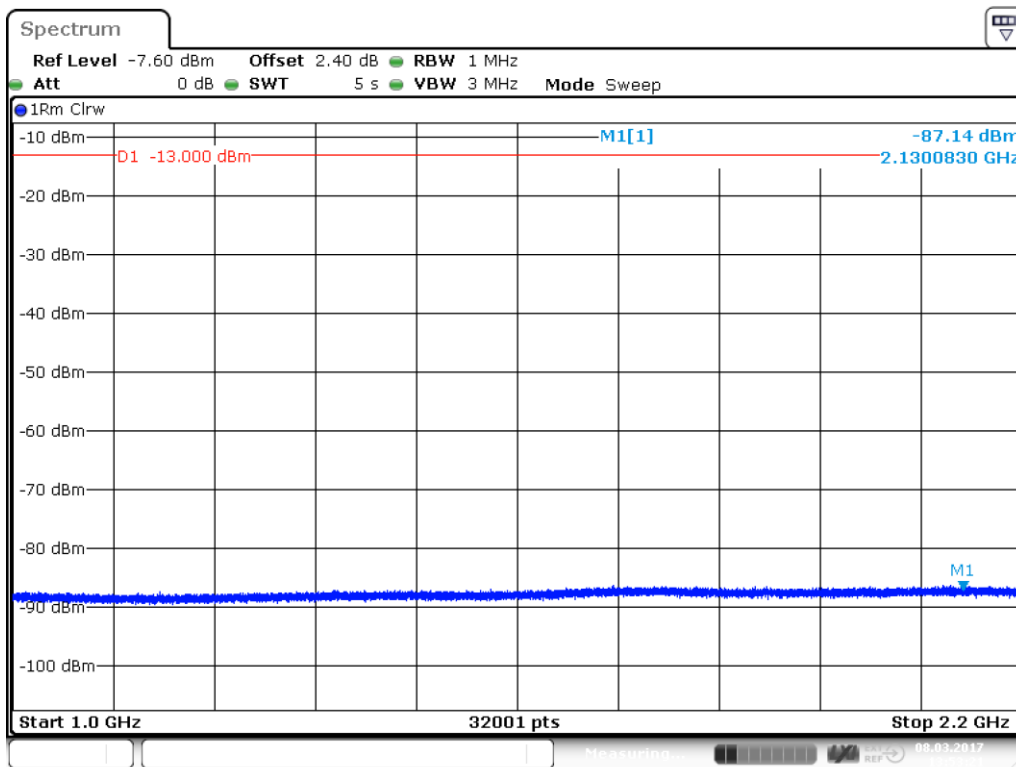

Date: 8.MAR.2017 13:53:21

plot 7.3.1.1-#2 Spurious Emissions at Antenna Terminals: §27.53, §2.1051; Test results; Downlink; LTE; 2 x 5 MHz signal; 1 GHz – 2.2 GHz

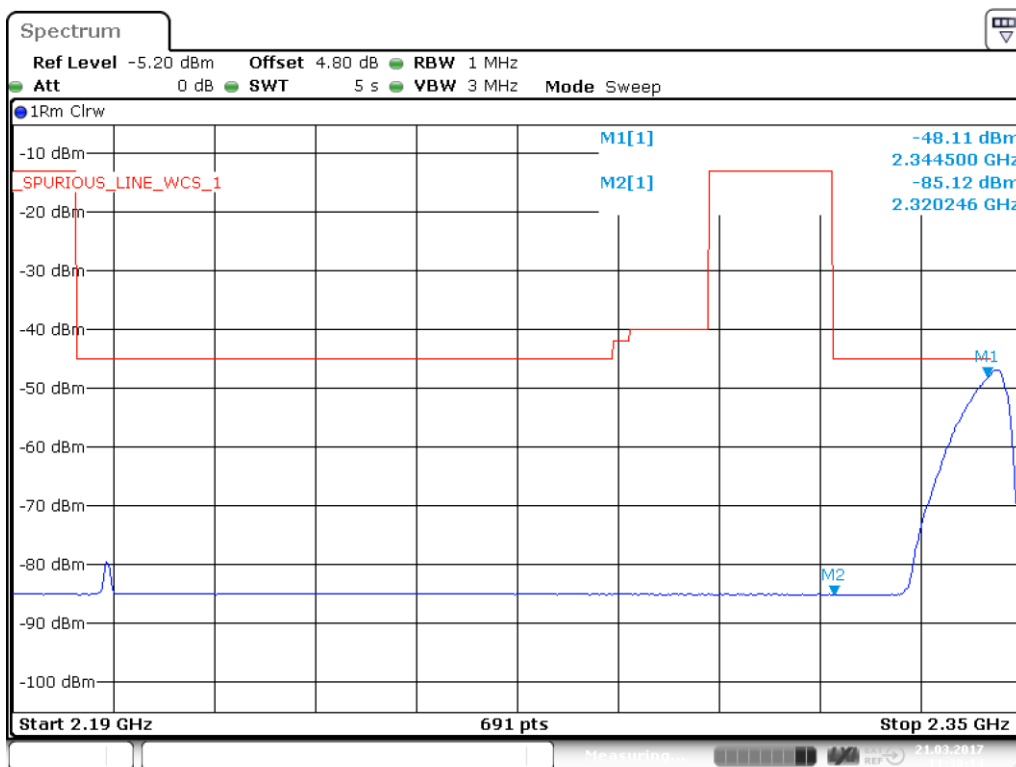

Date: 21.MAR.2017 11:38:14

plot 7.3.1.1-#3 Spurious Emissions at Antenna Terminals: §27.53, §2.1051; Test results; Downlink; LTE; 2 x 5 MHz signal; 2.19 GHz – 2.35 GHz; carrier notched

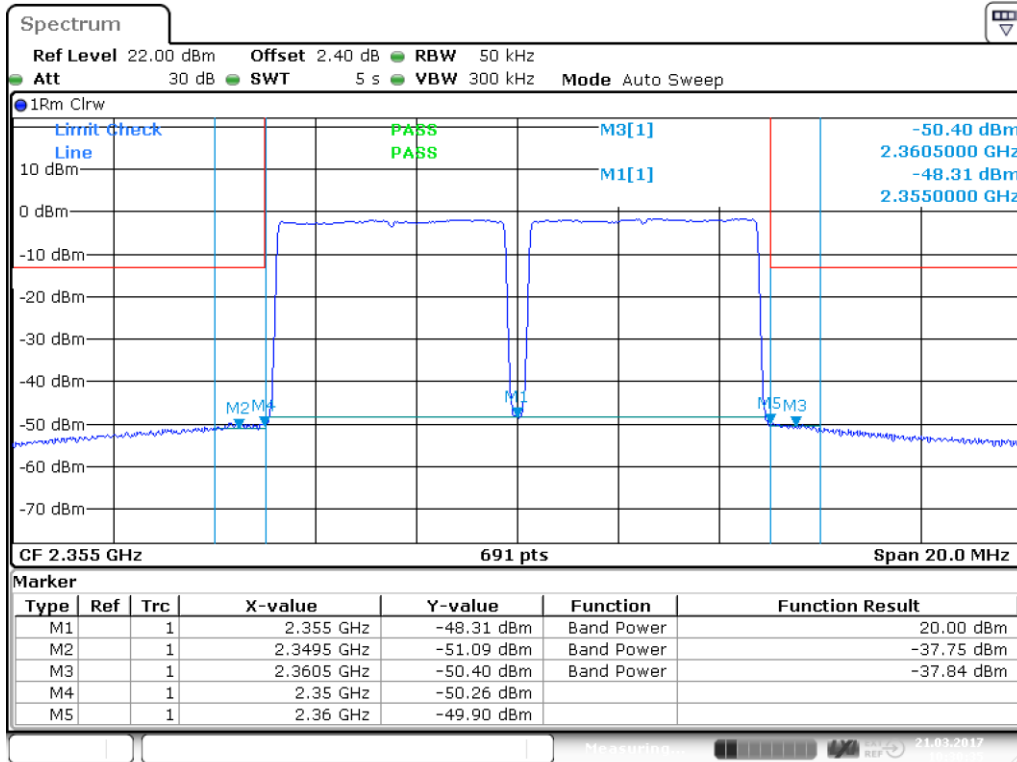

Date: 21.MAR.2017 10:30:35

plot 7.3.1.1-#4 Spurious Emissions at Antenna Terminals: §27.53, §2.1051; Test results; Downlink; LTE; 2 x 5 MHz signal; 2.345 GHz – 2.365 GHz

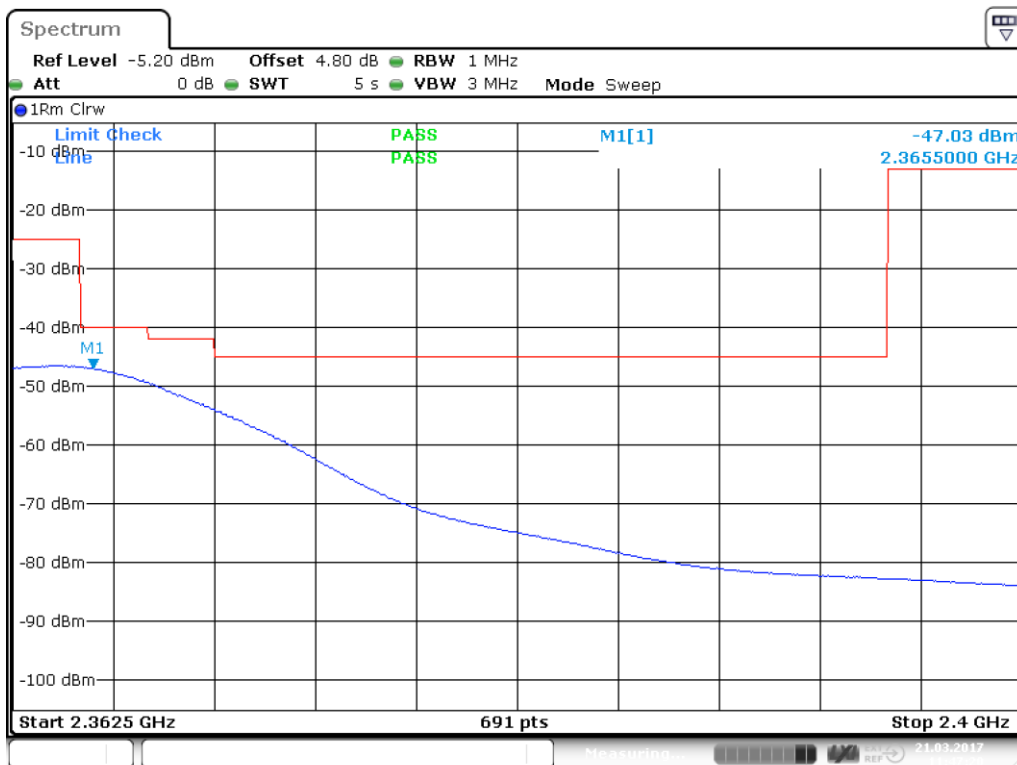

Date: 21.MAR.2017 11:47:20

plot 7.3.1.1-#5 Spurious Emissions at Antenna Terminals: §27.53, §2.1051; Test results; Downlink; LTE; 2 x 5 MHz signal; 2.3625 GHz – 2.4 GHz; carrier notched

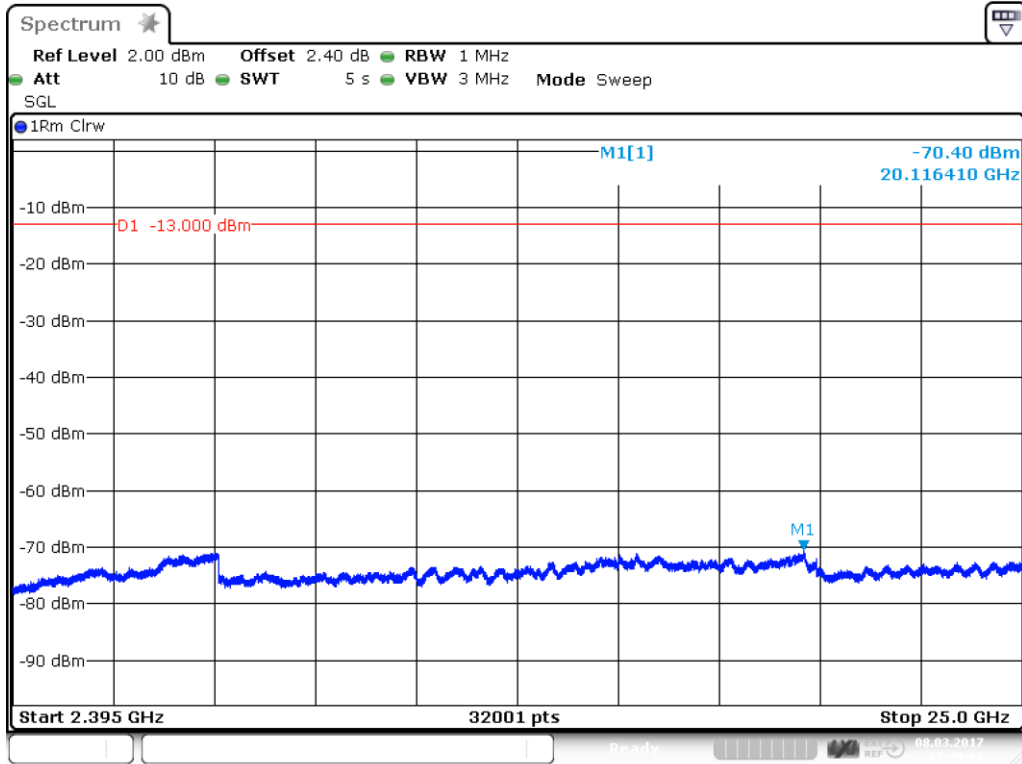

Date: 8.MAR.2017 13:49:07

plot 7.3.1.1-#6 Spurious Emissions at Antenna Terminals: §27.53, §2.1051; Test results; Downlink; LTE; 2 x 5 MHz signal; 2.395 GHz – 25 GHz



### 7.3.1.2 LTE; 10 MHz signal

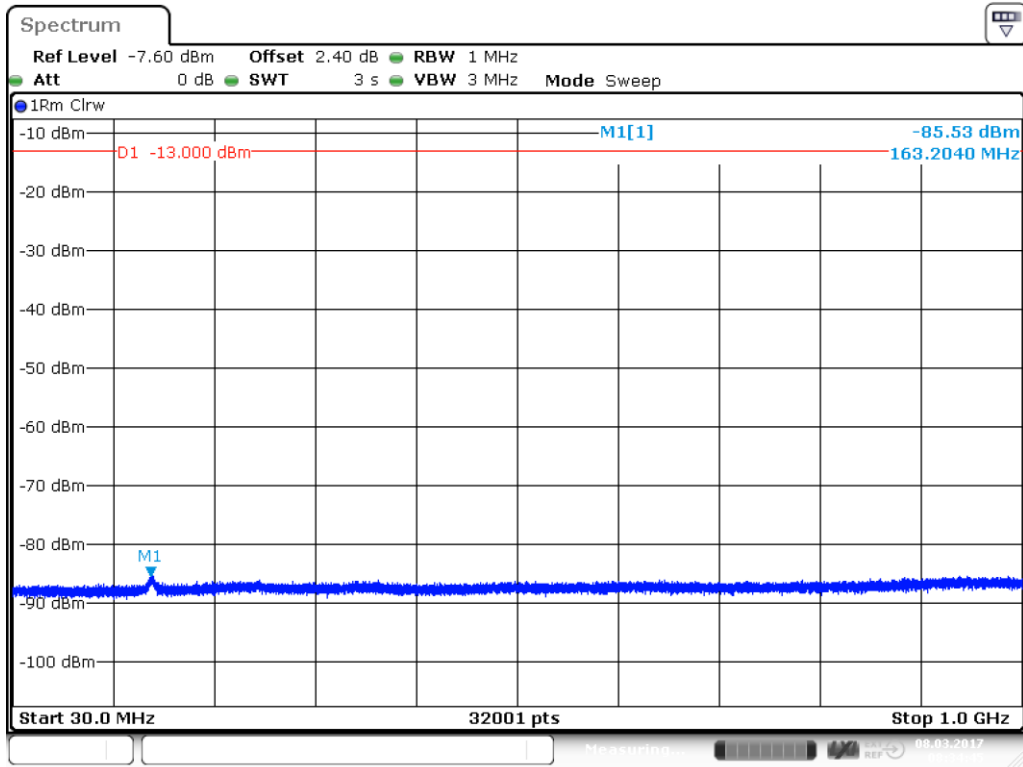

Date: 8.MAR.2017 08:34:45

plot 7.3.1.2-#1 Spurious Emissions at Antenna Terminals: §27.53, §2.1051; Test results; Downlink; LTE; 10 MHz signal; 30 MHz – 1 GHz

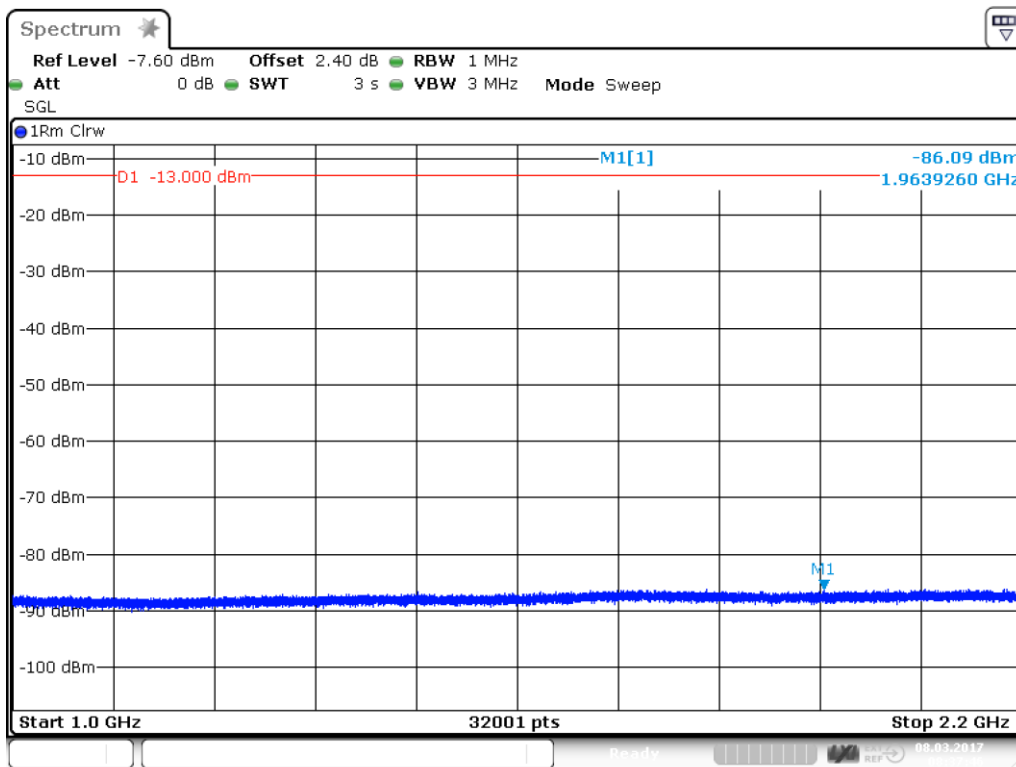

plot 7.3.1.2-#2 Spurious Emissions at Antenna Terminals: §27.53, §2.1051; Test results; Downlink; LTE; 10 MHz signal; 1 GHz – 2.2 GHz

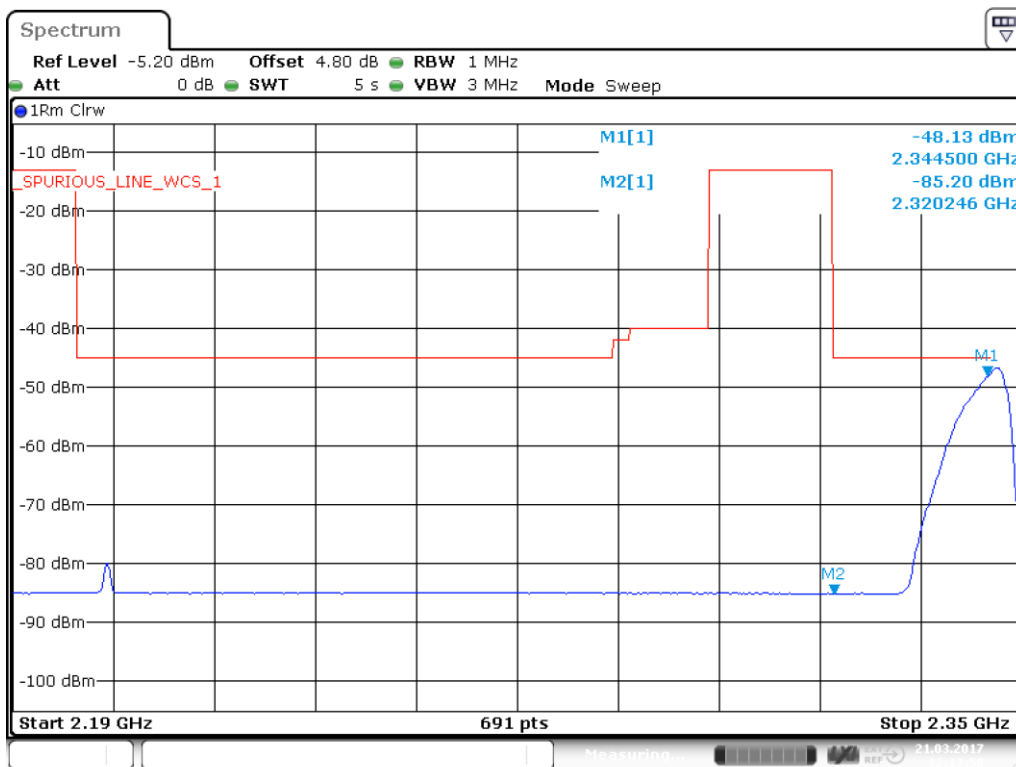

plot 7.3.1.2-#3 Spurious Emissions at Antenna Terminals: §27.53, §2.1051; Test results; Downlink; LTE; 10 MHz signal; 2.19 GHz – 2.35 GHz; carrier notched

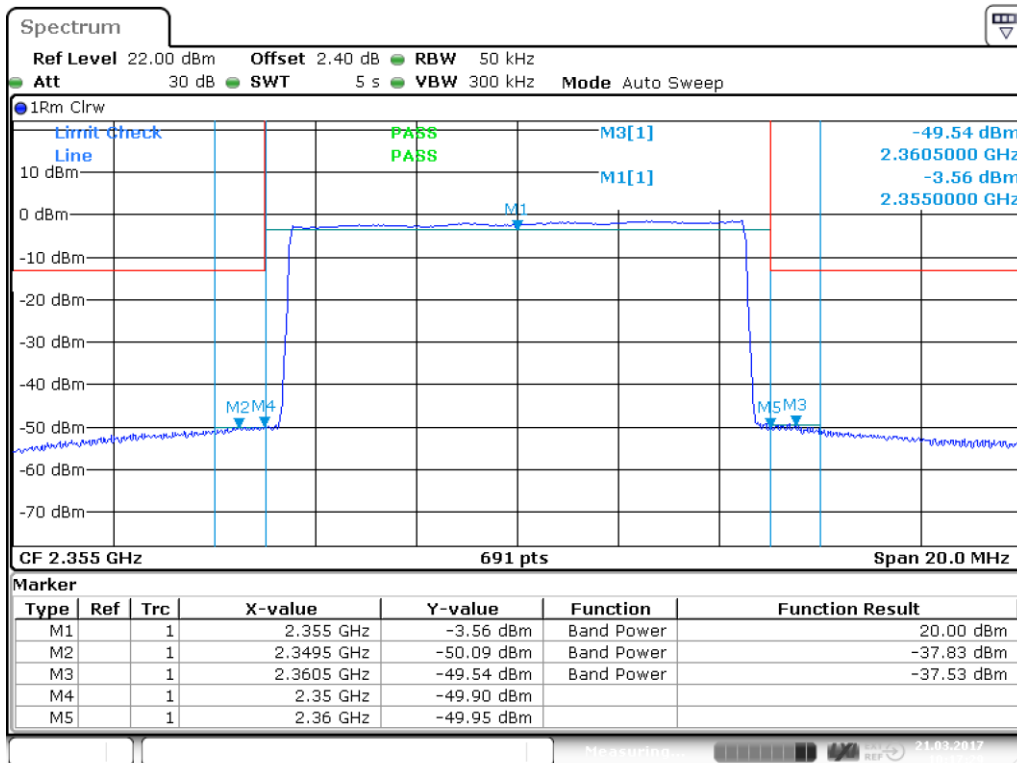

Date: 21.MAR.2017 10:17:29

plot 7.3.1.2-#4 Spurious Emissions at Antenna Terminals: §27.53, §2.1051; Test results; Downlink; LTE; 10 MHz signal; 2.345 GHz – 2.365 GHz;

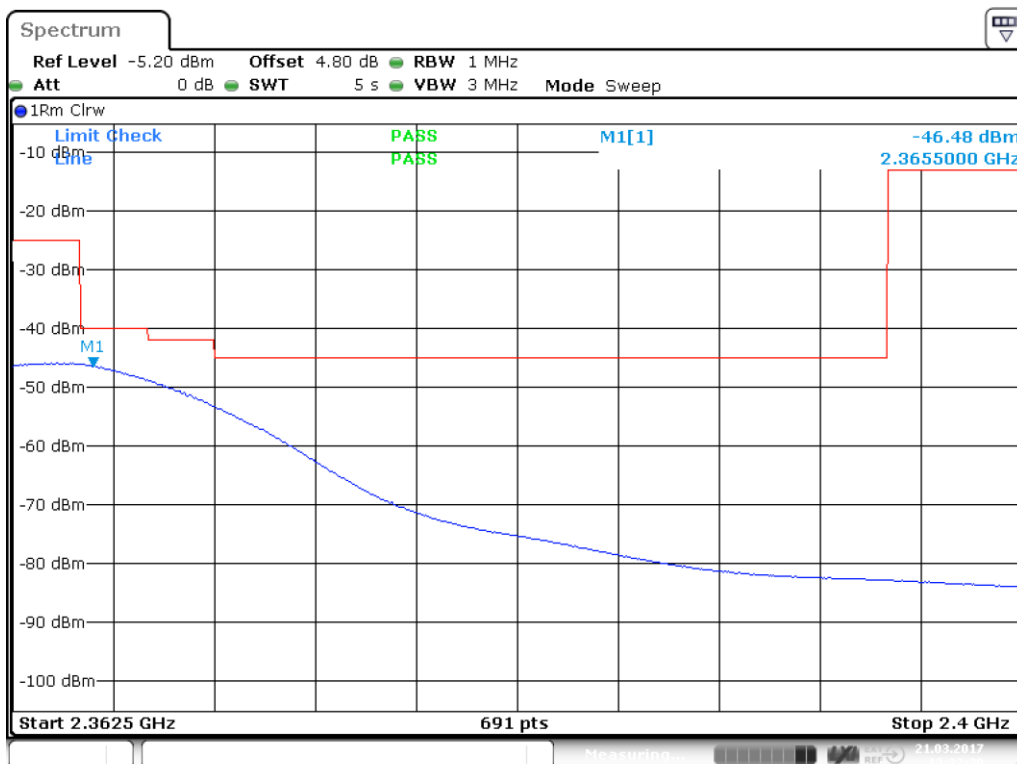

Date: 21.MAR.2017 13:32:30

plot 7.3.1.2-#5 Spurious Emissions at Antenna Terminals: §27.53, §2.1051; Test results; Downlink; LTE; 10 MHz signal; 2.3625 GHz – 2.4 GHz; carrier notched



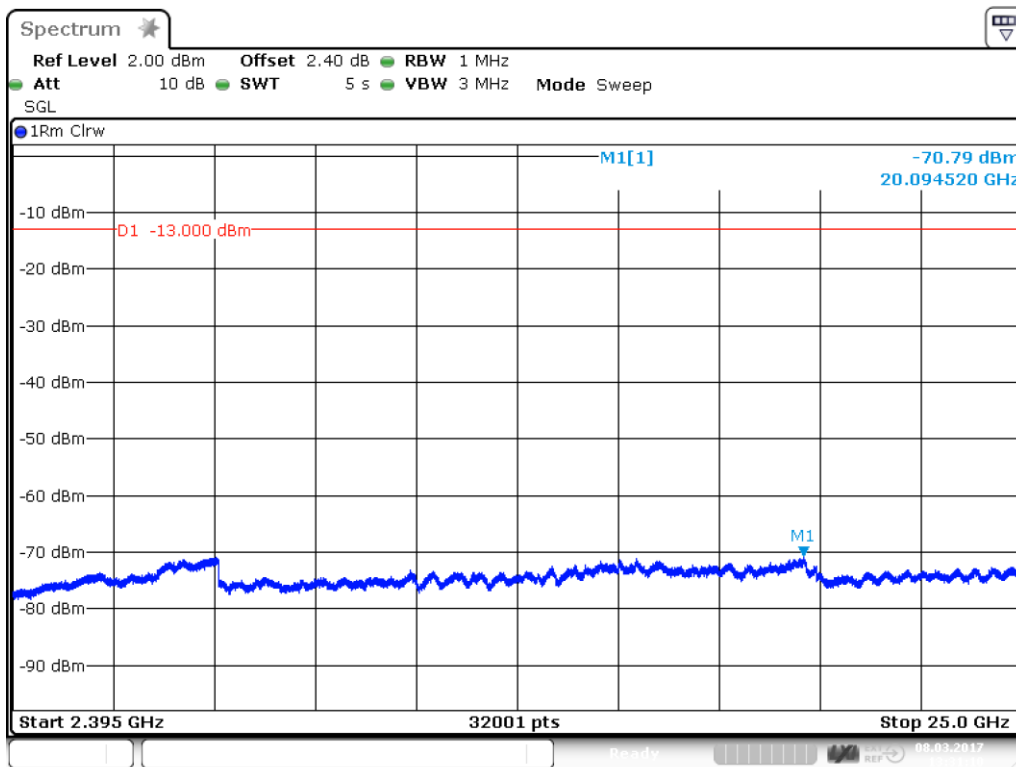

Date: 8.MAR.2017 13:31:11

plot 7.3.1.2-#6 Spurious Emissions at Antenna Terminals: §27.53, §2.1051; Test results; Downlink; LTE; 10 MHz signal; 2.395 GHz – 25 GHz

### 7.3.2 Uplink

n.a.

Note: The EUT does not transmit over the air in the uplink direction.

### 7.4 Summary test result

Test result	complies, according the plots above
Tested by:	F. Bengesser
Date:	08.03.2017 / 21.03.2017

## 8 Intermodulation: §27.53, §2.1051

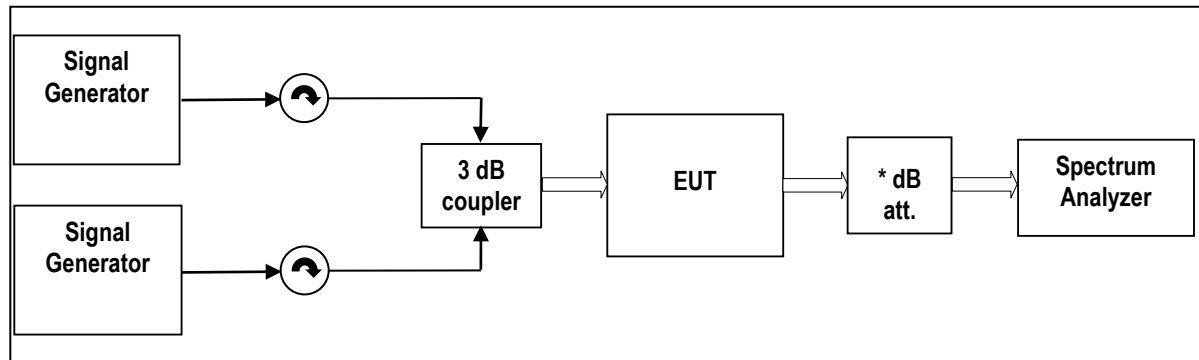

External Attenuator DL x dB = 20 dB  
figure 8-#1 Test setup: Intermodulation: §27.53, §2.1051

Measurement uncertainty	± 0,41 dB ± 0,47 dB ± 0.94 dB ± 1.2 dB	9 kHz to 3,6 GHz 3,6 GHz to 7 GHz 7 GHz to 13,6 GHz 13,6 GHz to 30 GHz
Test equipment used	9069, 9046, 9126, 7406, 7157, 7158, 7289, 7290, 7385	

### 8.1 Limit

(a) For operations in the 2305-2320 MHz band and the 2345-2360 MHz band, the power of any emission outside a licensee's frequency band(s) of operation shall be attenuated below the transmitter power P (with averaging performed only during periods of transmission) within the licensed band(s) of operation, in watts, by the following amounts:

(1) For base and fixed stations' operations in the 2305-2320 MHz band and the 2345-2360 MHz band:

(i) By a factor of not less than  $43 + 10 \log (P)$  dB on all frequencies between 2305 and 2320 MHz and on all frequencies between 2345 and 2360 MHz that are outside the licensed band(s) of operation, and not less than  $75 + 10 \log (P)$  dB on all frequencies between 2320 and 2345 MHz;

(ii) By a factor of not less than  $43 + 10 \log (P)$  dB on all frequencies between 2300 and 2305 MHz,  $70 + 10 \log (P)$  dB on all frequencies between 2287.5 and 2300 MHz,  $72 + 10 \log (P)$  dB on all frequencies between 2285 and 2287.5 MHz, and  $75 + 10 \log (P)$  dB below 2285 MHz;

(iii) By a factor of not less than  $43 + 10 \log (P)$  dB on all frequencies between 2360 and 2362.5 MHz,  $55 + 10 \log (P)$  dB on all frequencies between 2362.5 and 2365 MHz,  $70 + 10 \log (P)$  dB on all frequencies between 2365 and 2367.5 MHz,  $72 + 10 \log (P)$  dB on all frequencies between 2367.5 and 2370 MHz, and  $75 + 10 \log (P)$  dB above 2370 MHz.

(2) For fixed customer premises equipment (CPE) stations operating in the 2305-2320 MHz band and the 2345-2360 MHz band transmitting with more than 2 watts per 5 megahertz average EIRP:

(i) By a factor of not less than  $43 + 10 \log (P)$  dB on all frequencies between 2305 and 2320 MHz and on all frequencies between 2345 and 2360 MHz that are outside the licensed band(s) of operation, and not less than  $75 + 10 \log (P)$  dB on all frequencies between 2320 and 2345 MHz;



(ii) By a factor of not less than  $43 + 10 \log (P)$  dB on all frequencies between 2300 and 2305 MHz,  $70 + 10 \log (P)$  dB on all frequencies between 2287.5 and 2300 MHz,  $72 + 10 \log (P)$  dB on all frequencies between 2285 and 2287.5 MHz, and  $75 + 10 \log (P)$  dB below 2285 MHz;

(iii) By a factor of not less than  $43 + 10 \log (P)$  dB on all frequencies between 2360 and 2362.5 MHz,  $55 + 10 \log (P)$  dB on all frequencies between 2362.5 and 2365 MHz,  $70 + 10 \log (P)$  dB on all frequencies between 2365 and 2367.5 MHz,  $72 + 10 \log (P)$  dB on all frequencies between 2367.5 and 2370 MHz, and  $75 + 10 \log (P)$  dB above 2370 MHz.

If the DUT used in MIMO configuration according to KDB 662911, the summed emission (MIMO Max. Level) is calculated (Max. Level) of the output port plus  $10 \log (N_{ANT})$ . With  $(N_{ANT} = 2)$  the MIMO Max. Level (dBm) equals Max. Level (dBm) plus 3dB.

## 8.2 Test method

Para. No 2.1051 Measurements required: Spurious emissions at antenna terminals.

The radio frequency voltage or powers generated within the equipment and appearing on a spurious frequency shall be checked at the equipment output terminals when properly loaded with a suitable artificial antenna. Curves or equivalent data shall show the magnitude of each harmonic and other spurious emission that can be detected when the equipment is operated under the conditions specified in § 2.1049 as appropriate. The magnitude of spurious emissions which are attenuated more than 20 dB below the permissible value need not be specified.

[39 FR 5919, Feb. 15, 1974. Redesignated and amended at 63 FR 36599, July 7, 1998]

## 8.3 Test results

### 8.3.1 Downlink

Detector: RMS.

Modulation	Carrier(s) F / MHz	Limit pass/fail	Limit with MIMO pass/fail	Plot -
2 x LTE 5 MHz	2352.5 2357.5	pass	pass	8.3.1.1 1
LTE 10 MHz	2355	pass	pass	8.3.1.2 1

table 8.3-#1 Intermodulation: §27.53, §2.1051 Test results



8.3.1.1 LTE; 2 x 5 MHz signal

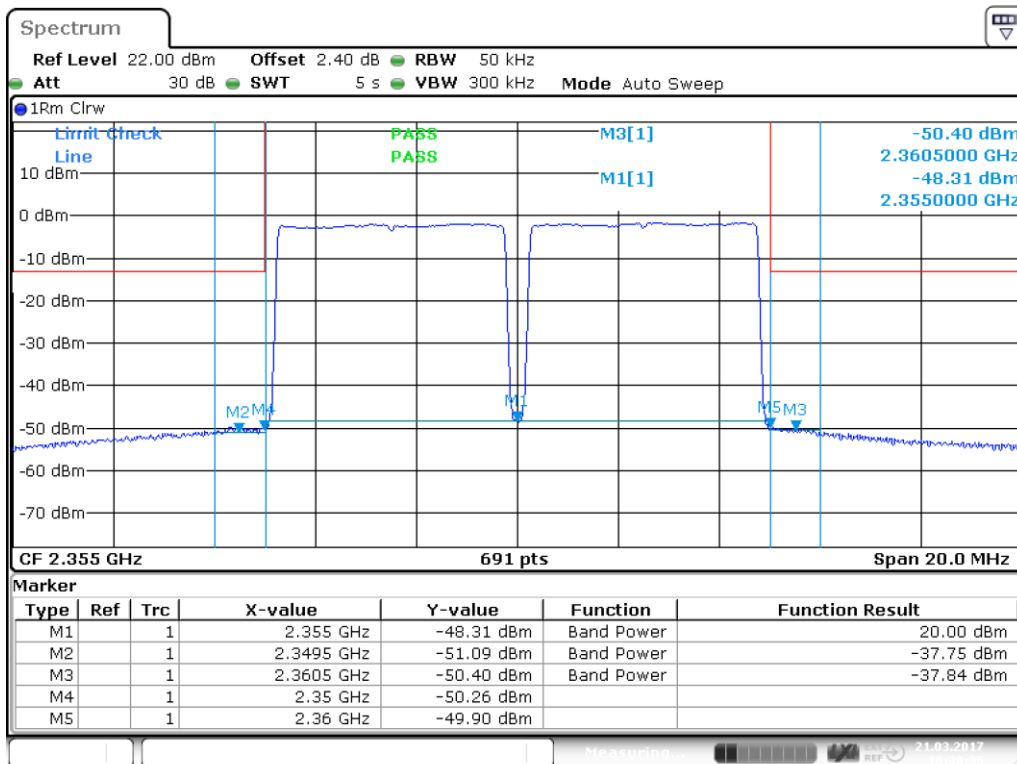

Date: 21.MAR.2017 10:30:35

plot 8.3.1.1-#1 Intermodulation: §27.53, §2.1051; Test results; Downlink; LTE; 2 x 5 MHz signal; 2.345 GHz – 2.365 GHz

### 8.3.1.2 LTE; 10 MHz signal

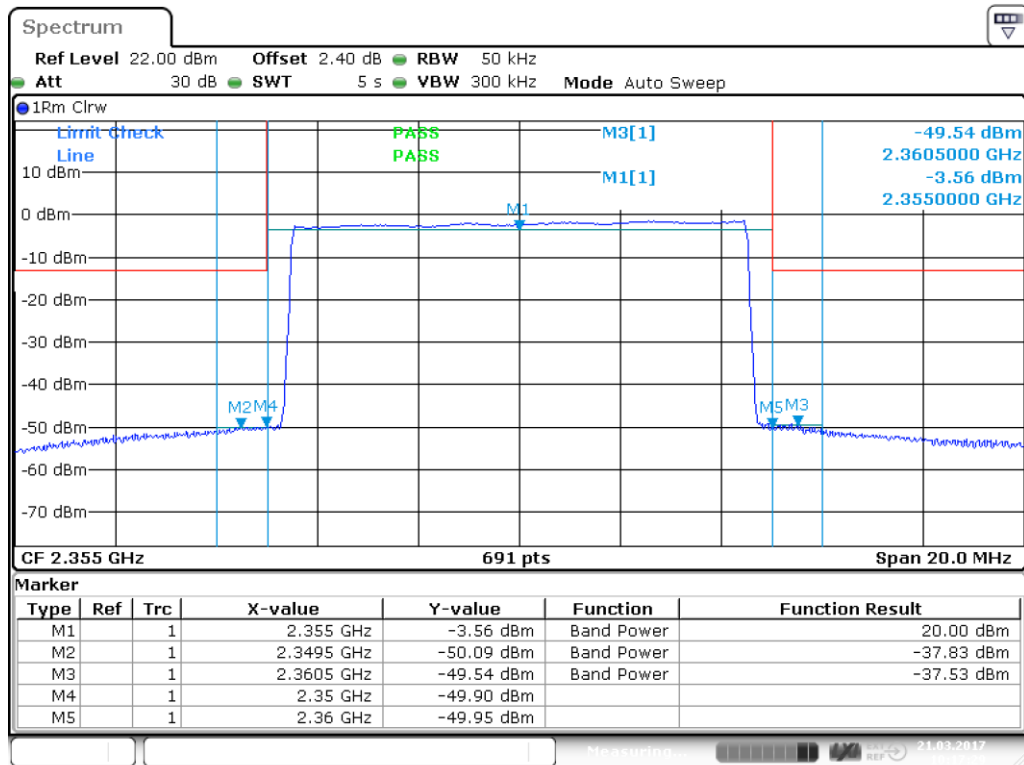

Date: 21.MAR.2017 10:17:29

plot 8.3.1.2-#1 Intermodulation: §27.53, §2.1051; Test results; Downlink; LTE; 10 MHz signal; 2.345 GHz – 2.365 GHz;

### 8.3.2 Uplink

n.a.

Note: The EUT does not transmit over the air in the uplink direction.

### 8.4 Summary test result

Test result	complies, according the plots above
Tested by:	F. Bengesser
Date:	21.03.2017

## 9 Out of Band Rejection

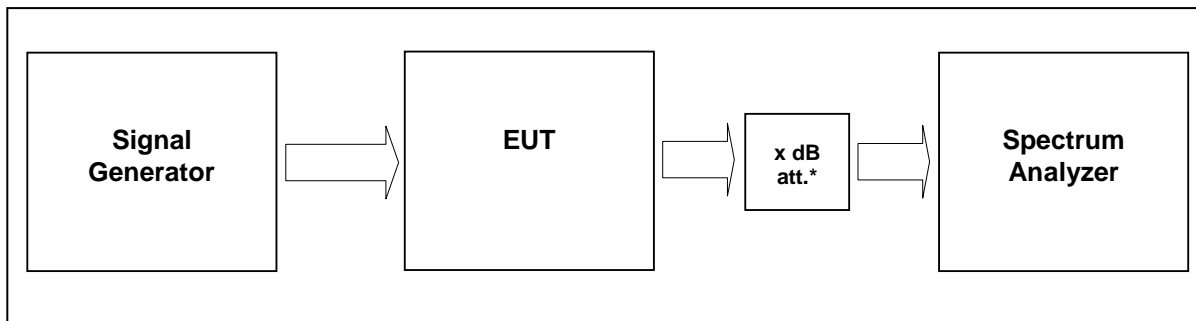

External Attenuator DL      x dB = 20 dB  
 figure 9-#1 Test setup: Out of Band Rejection

Measurement uncertainty	± 0,38 dB
Test equipment used	9069, 9046, 9126, 7406, 7157, 7158, 7289, 7290, 7385

### 9.1 Limit

KDB 935210 D02 v02

Test for rejection of out of band signals. Filter frequency response plots are acceptable.

### 9.2 Test method

935210 D03 v02

7.1 Authorized frequency band verification test

### 9.3 Test results

Detector Peak max hold



### 9.3.1 Downlink

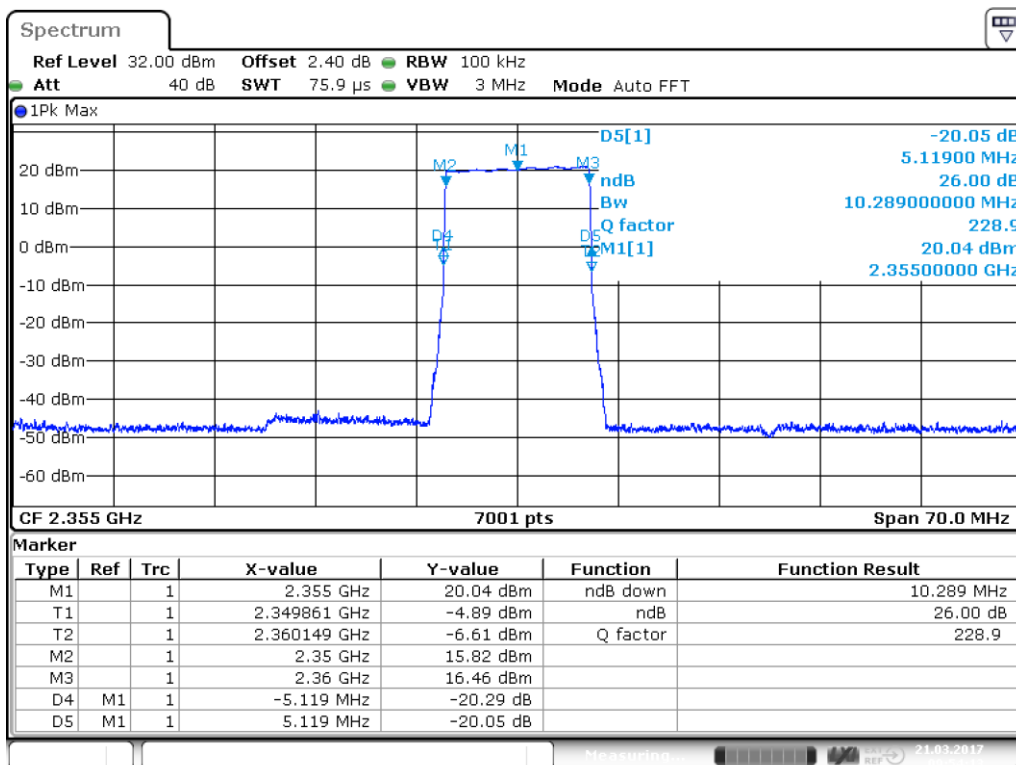

Date: 21.MAR.2017 09:54:13

plot 9.3.1-#1 Out of Band Rejection; Test results; Downlink;

### 9.3.2 Uplink

n.a.

Note: The EUT does not transmit over the air in the uplink direction.

### 9.4 Summary test result

Test result	complies, according the plots above
Tested by:	F. Bengesser
Date:	21.03.2017

### 10 Radiated Spurious Emissions at the ECL (BV): §27.53, §2.1053, RSS-Gen, RSS-131

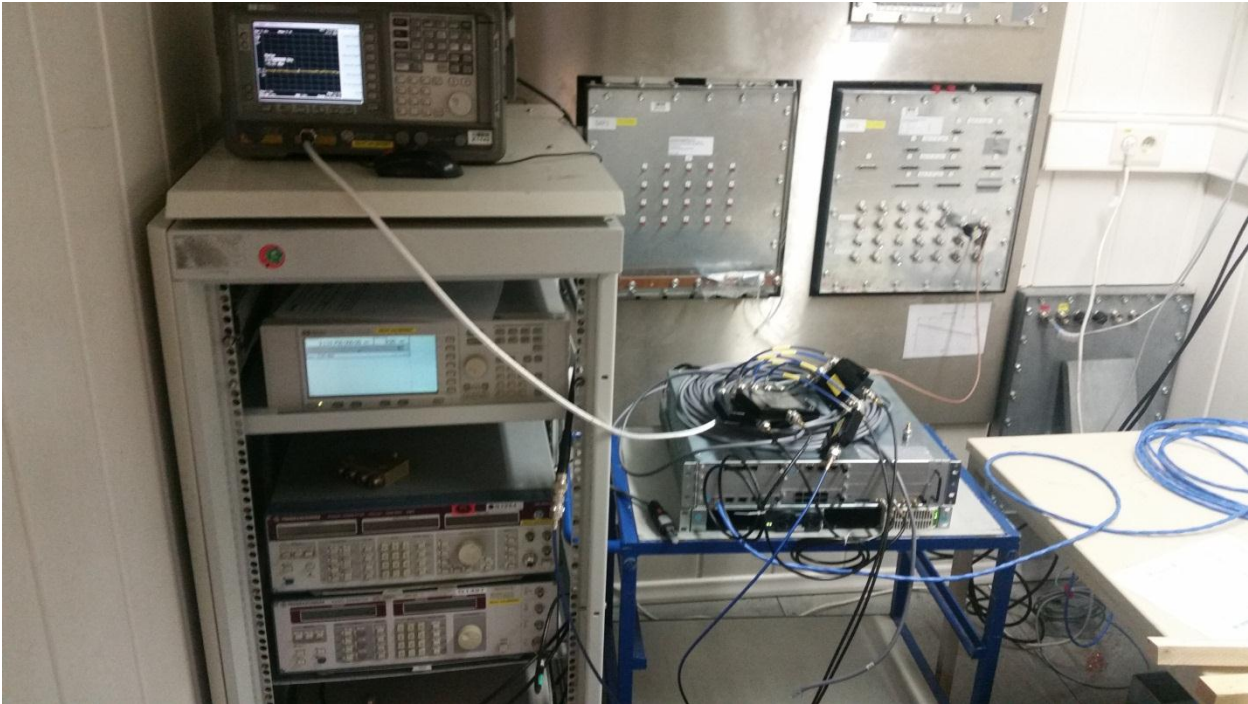

picture 8.1: auxiliary equipment



picture 8.2: Test setup: Field Strength Emission <1 GHz @10m in the SAC





picture 8.3: Test setup: Field Strength Emission 1 - 18 GHz @3m in the SAC



picture 8.4: Test setup: Field Strength Emission 18 – 26,5 GHz @3m in the SAC

**Remark: The worst results were measured during the MIMO configuration (both antenna ports were active) and were reported at chapter 10.4 Test results.**



This clause specifies requirements for the measurement of radiated emission.

Frequency range	Distance: EUT <-> antenna / location	Limit	Test method
30 MHz – 26,5 GHz	3 metres / FAC	FCC 47 CFR Part 27.53 IC RSS-131 sec. 4.4	TIA/EIA-603-C:2004

**Test equipment used:**

Designation	Type	Manufacturer	Invent.-no.	Cal.-date	due Cal.- date	used
EMI test receiver	ESU40	Rohde & Schwarz	E2025	18.10.2016	18.10.2017	X
Antenna	CBL 6111	Chase	K1026	26.05.2017	26.05.2018	X
Antenna	HL 025	R&S	K1114	24.05.2017	24.05.2018	X
Preamplifier	AFS4-00102000	Miteq	K838	10.05.2017	10.05.2018	X
RF Cable	Sucoflex 100	Suhner	K1760	04.08.2015	04.08.2017	X
Antenna	JXTXLB-42-25- C-KF	A-Info	K1175	09.03.2015	09.03.2018	X

The REMI version 2.135 has been used to maximize radiated emission from the EUT with regards to ANSI C63.4:2009.

**Test set-up:**

Test location: FAC  
 Both, the Fully Anechoic Chamber (FAC) and the Semi Anechoic Chamber (SAC) fulfil the requirements of ANSI C63.4 and CISPR 16-1-4 with regards to NSA and SVSWR.

Test Voltage: 110 V / 60 Hz  
 Type of EUT: Wall mounted

**Measurement uncertainty:**

Measurement uncertainty expanded (95% or K=2)	± 4,7 dB for ANSI C63.4 measurement ± 0,5 dB for TIA-603 measurement
--	---

## 10.1 Method of Measurement

### Measurement procedure. TIA-603-C

The antenna substitution method is used to determine the equivalent radiated power at spurious frequencies. The spurious emissions are measured at a distance of 3 meters. The EUT is then replaced with a reference substitution antenna with a known gain referenced to a dipole. This antenna is fed with a signal at the spurious frequency. The level of the signal is adjusted to repeat the previously measured level. The resulting eirp is the signal level fed to the reference antenna corrected for gain referenced to an isotropic dipole (see Figure 7.2).

From KDB (AMPLIFIER, BOOSTER, AND REPEATER REMINDER SHEET):

Radiated spurs (enclosure) – Use of CW signal (low, mid, and high freq.) is acceptable rather than all modulations.

The maximum RFI field strength was determined during the measurement by rotating the turntable ( $\pm 180$  degrees) as like defined in ANSI C63.4. A measurement receiver has been used with a RBW 120 kHz up to 1 GHz and 1 MHz above 1 GHz. Steps width during the measurement was half the RBW.

Both, the Fully Anechoic Chamber (FAC) and the Semi Anechoic Chamber (SAC) fulfil the requirements of ANSI C63.4 and CISPR 16-1-4 with regards to NSA and SVSWR.

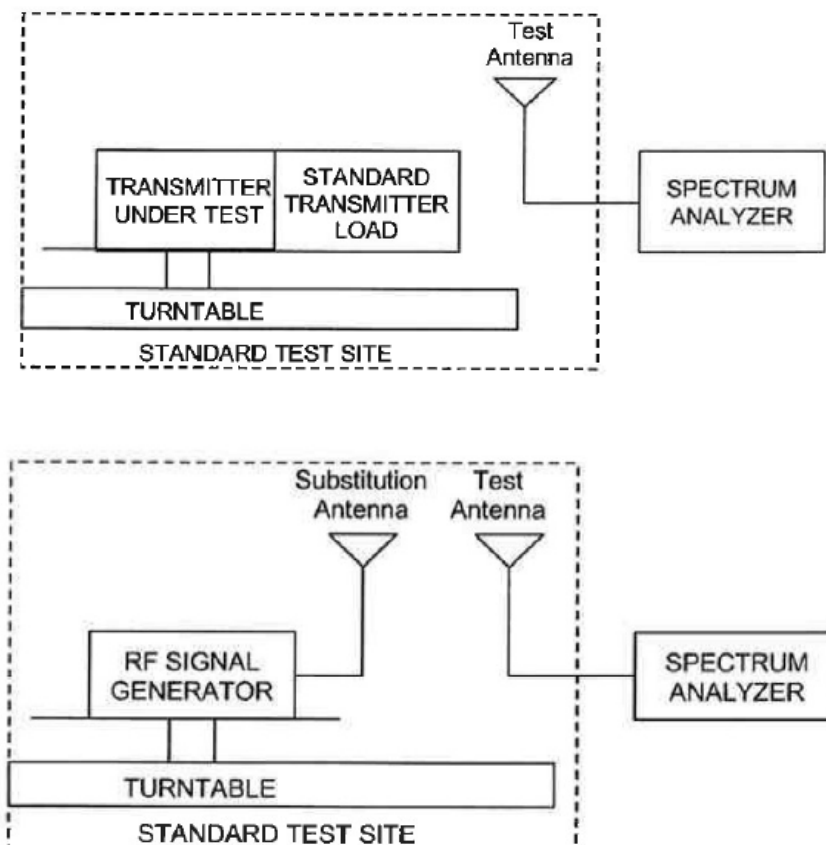

Figure #8.3 Substitution methods TIA/EIA-603-C



## 10.2 Limit

(a) For operations in the 2305-2320 MHz band and the 2345-2360 MHz band, the power of any emission outside a licensee's frequency band(s) of operation shall be attenuated below the transmitter power  $P$  (with averaging performed only during periods of transmission) within the licensed band(s) of operation, in watts, by the following amounts:

(1) For base and fixed stations' operations in the 2305-2320 MHz band and the 2345-2360 MHz band:

(i) By a factor of not less than  $43 + 10 \log (P)$  dB on all frequencies between 2305 and 2320 MHz and on all frequencies between 2345 and 2360 MHz that are outside the licensed band(s) of operation, and not less than  $75 + 10 \log (P)$  dB on all frequencies between 2320 and 2345 MHz;

(ii) By a factor of not less than  $43 + 10 \log (P)$  dB on all frequencies between 2300 and 2305 MHz,  $70 + 10 \log (P)$  dB on all frequencies between 2287.5 and 2300 MHz,  $72 + 10 \log (P)$  dB on all frequencies between 2285 and 2287.5 MHz, and  $75 + 10 \log (P)$  dB below 2285 MHz;

(iii) By a factor of not less than  $43 + 10 \log (P)$  dB on all frequencies between 2360 and 2362.5 MHz,  $55 + 10 \log (P)$  dB on all frequencies between 2362.5 and 2365 MHz,  $70 + 10 \log (P)$  dB on all frequencies between 2365 and 2367.5 MHz,  $72 + 10 \log (P)$  dB on all frequencies between 2367.5 and 2370 MHz, and  $75 + 10 \log (P)$  dB above 2370 MHz.

(2) For fixed customer premises equipment (CPE) stations operating in the 2305-2320 MHz band and the 2345-2360 MHz band transmitting with more than 2 watts per 5 megahertz average EIRP:

(i) By a factor of not less than  $43 + 10 \log (P)$  dB on all frequencies between 2305 and 2320 MHz and on all frequencies between 2345 and 2360 MHz that are outside the licensed band(s) of operation, and not less than  $75 + 10 \log (P)$  dB on all frequencies between 2320 and 2345 MHz;

(ii) By a factor of not less than  $43 + 10 \log (P)$  dB on all frequencies between 2300 and 2305 MHz,  $70 + 10 \log (P)$  dB on all frequencies between 2287.5 and 2300 MHz,  $72 + 10 \log (P)$  dB on all frequencies between 2285 and 2287.5 MHz, and  $75 + 10 \log (P)$  dB below 2285 MHz;

(iii) By a factor of not less than  $43 + 10 \log (P)$  dB on all frequencies between 2360 and 2362.5 MHz,  $55 + 10 \log (P)$  dB on all frequencies between 2362.5 and 2365 MHz,  $70 + 10 \log (P)$  dB on all frequencies between 2365 and 2367.5 MHz,  $72 + 10 \log (P)$  dB on all frequencies between 2367.5 and 2370 MHz, and  $75 + 10 \log (P)$  dB above 2370 MHz.

If the DUT used in MIMO configuration according to KDB 662911, the summed emission (MIMO Max. Level) is calculated (Max. Level) of the output port plus  $10 \log (N_{ANT})$ . With  $(N_{ANT} = 2)$  the MIMO Max. Level (dBm) equals Max. Level (dBm) plus 3dB.



### 10.3 Receiver Settings

	up to 1 GHz	above 1 GHz
Measurement bandwidth	120 kHz	1 MHz
Step width	60 kHz	500 kHz
Dwell time	20ms	
Detector	Peak	Average

### 10.4 Climatic values in the lab

Temperature	20°C
Relative Humidity	45%
Air-pressure	1014 hPa



### 10.5 Test results

#### 10.5.1 30 MHz to 1 GHz Downlink (Bottom – Middle – Top)

Bottom: 2350.7 MHz; Middle: 2355 MHz; Top: 2359.3 MHz (Operation: maximum power and MIMO)

Vertikal

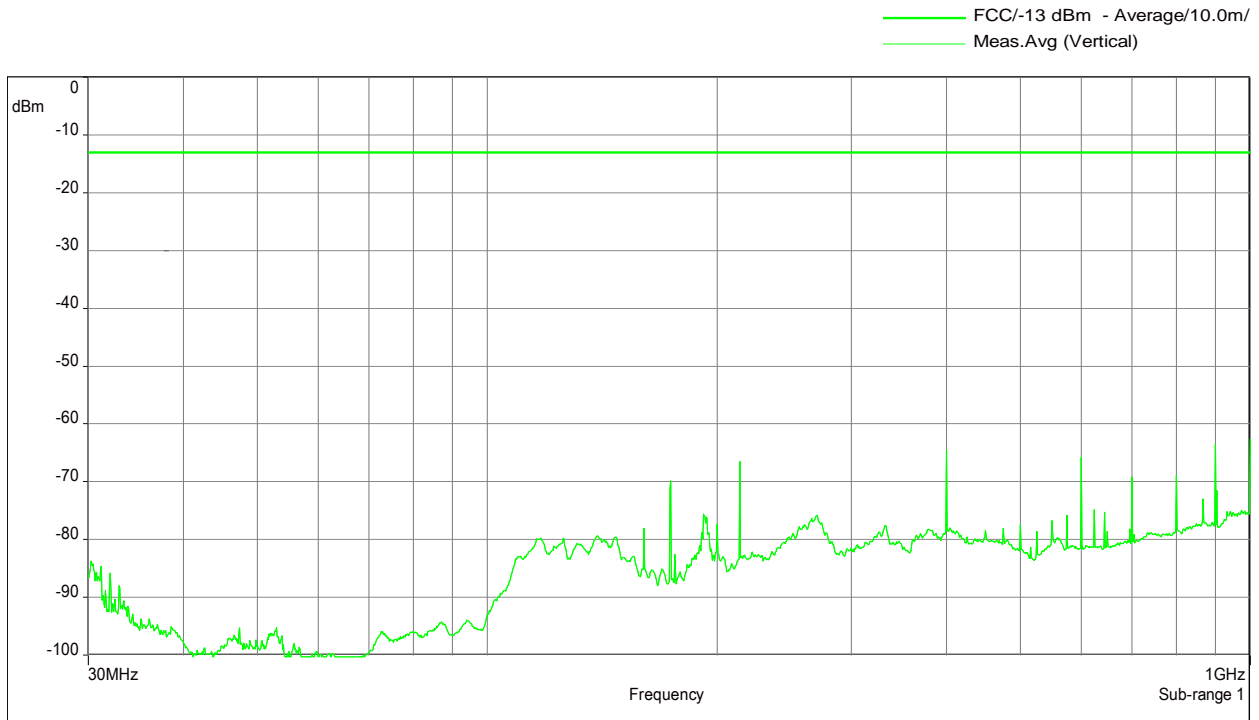

Horizontal

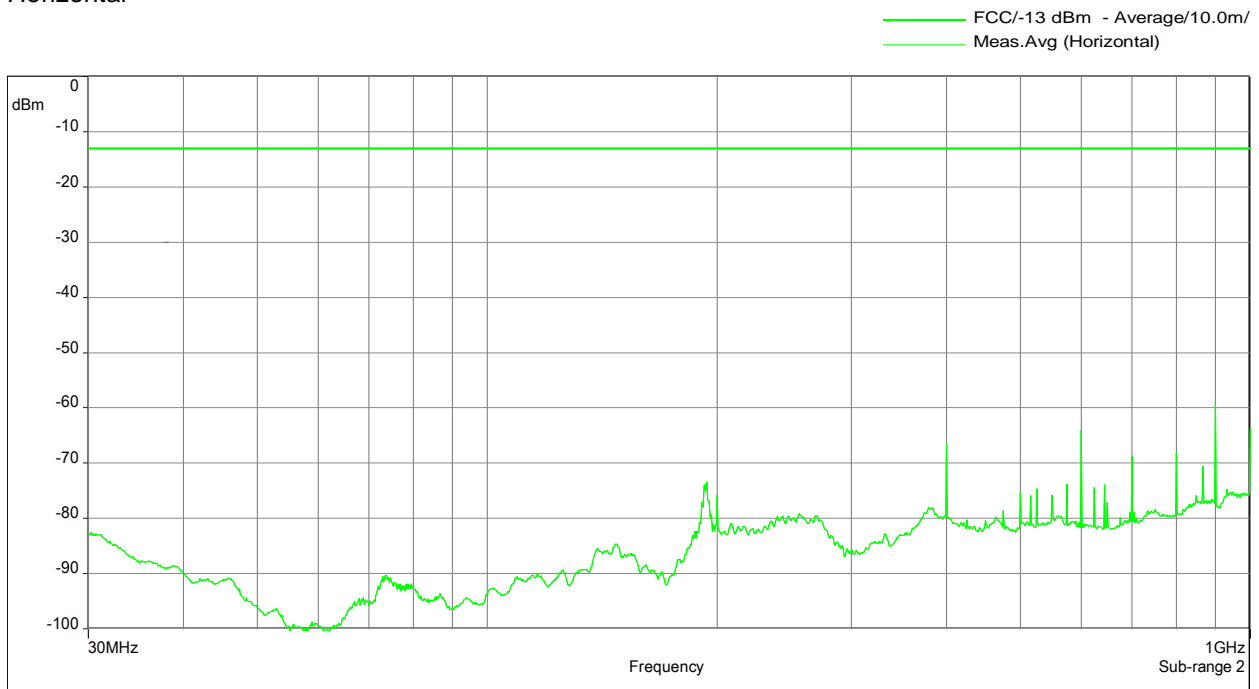

The RF output power is terminated.



### 10.5.2 30 MHz to 1 GHz Downlink (Middle of both paths)

F1: 2145 MHz; F2: 2355 MHz (Operation: maximum power and MIMO)

Vertikal

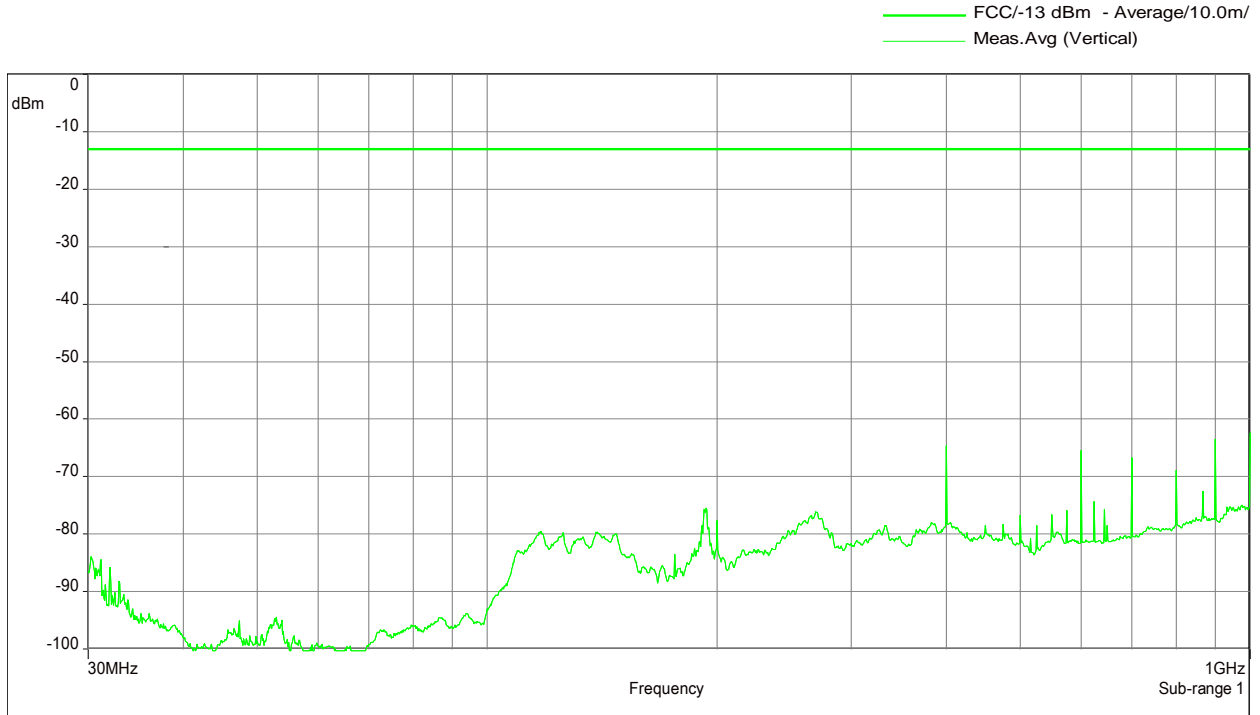

Horizontal

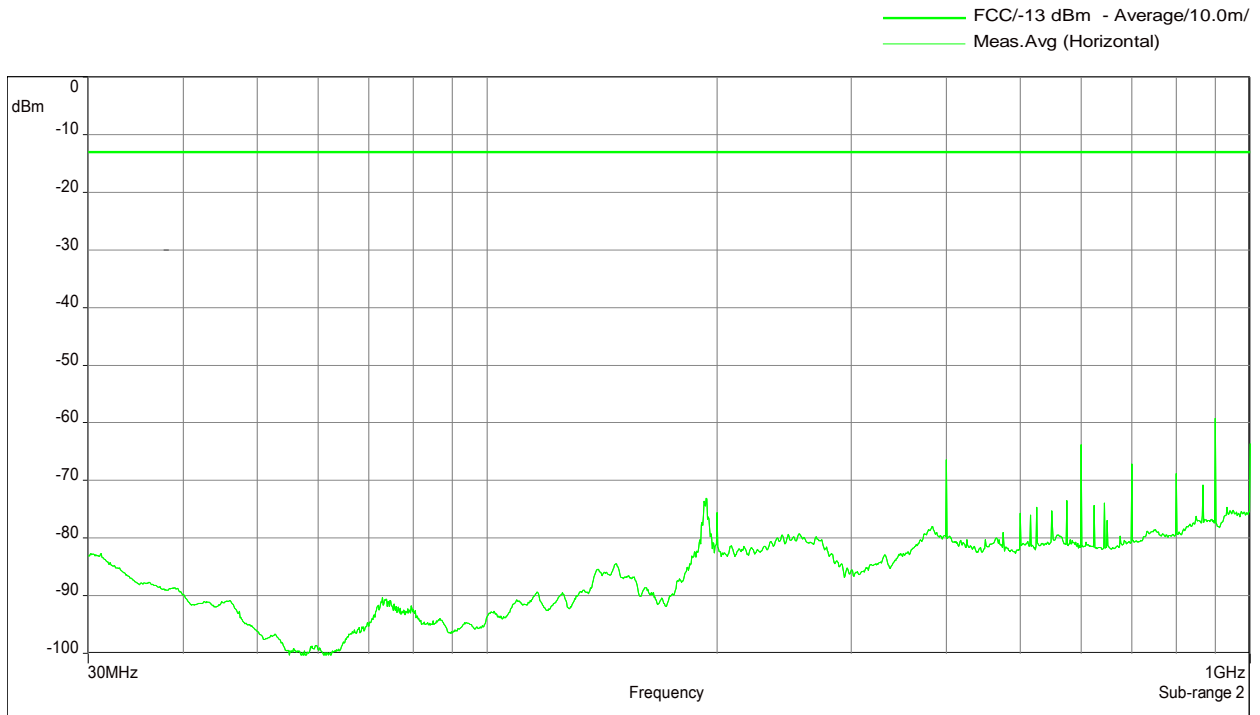

The RF output power is terminated.



### 10.5.3 1 GHz to 18 GHz Downlink (Bottom – Middle – Top)

Bottom: 2350.7 MHz; Middle: 2355 MHz; Top: 2359.3 MHz (Operation: maximum power and MIMO)

Vertikal

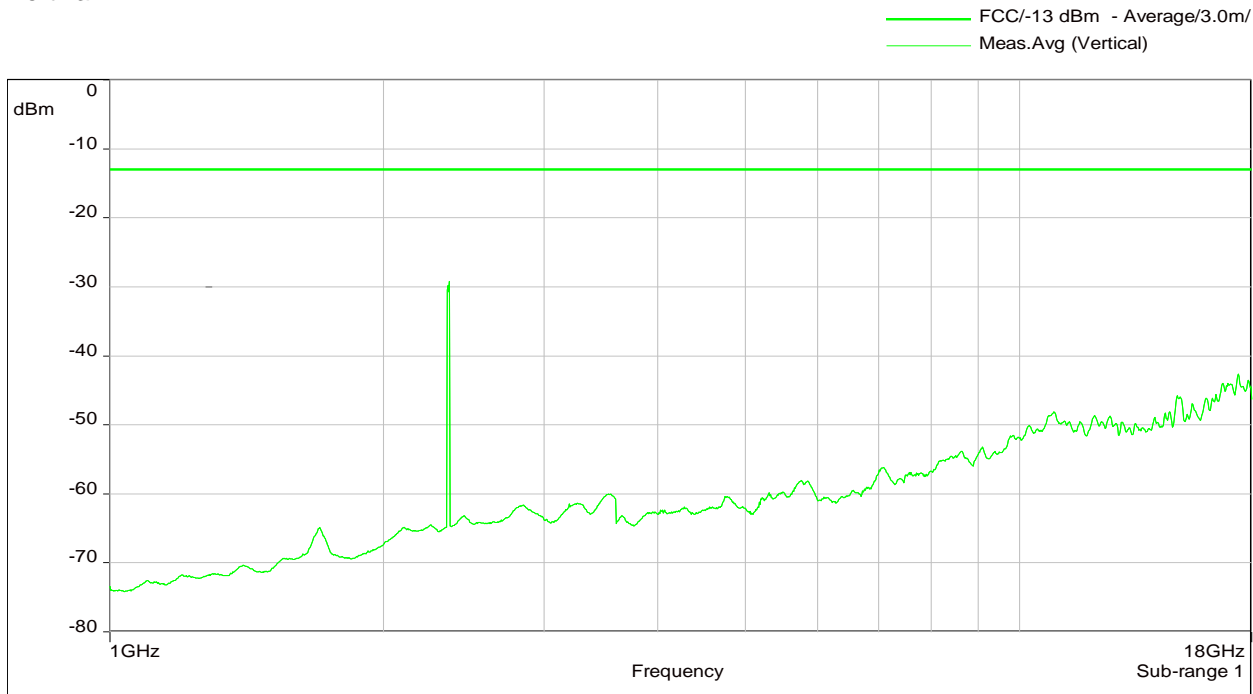

Horizontal

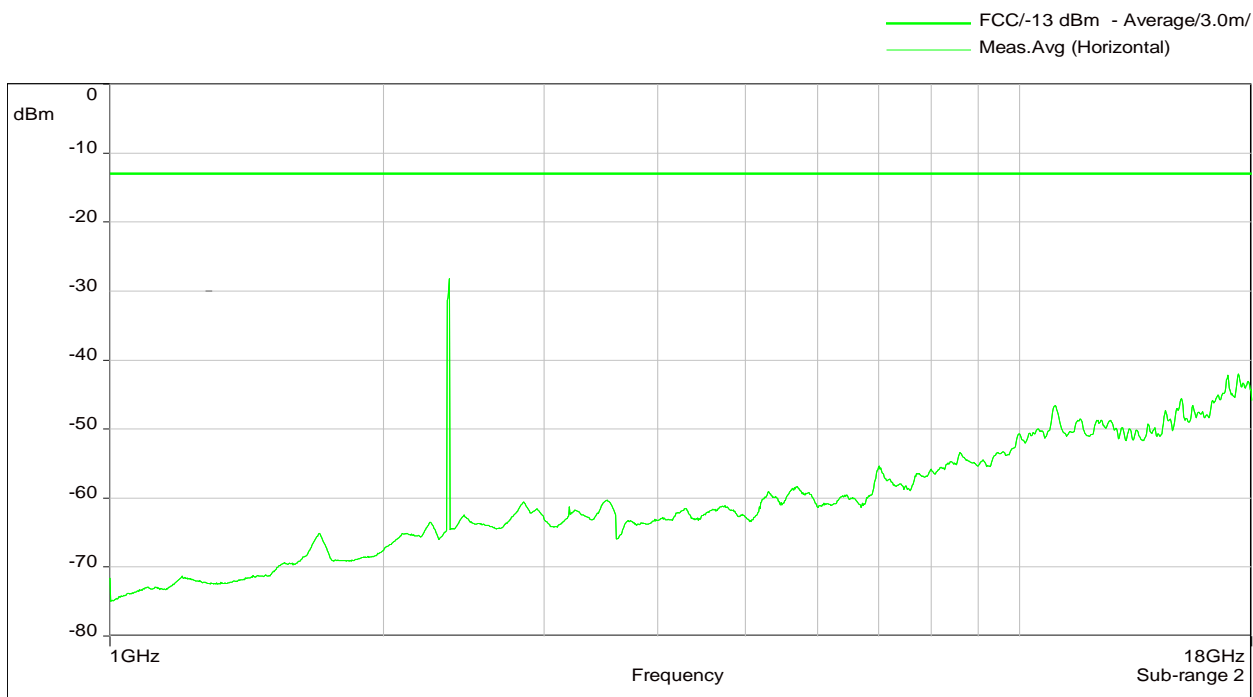

The RF output power is terminated.





### 10.5.4 1 GHz to 18 GHz Downlink (Middle of both paths)

F1: 2145 MHz; F2: 2355 MHz (Operation: maximum power and MIMO)

Vertikal

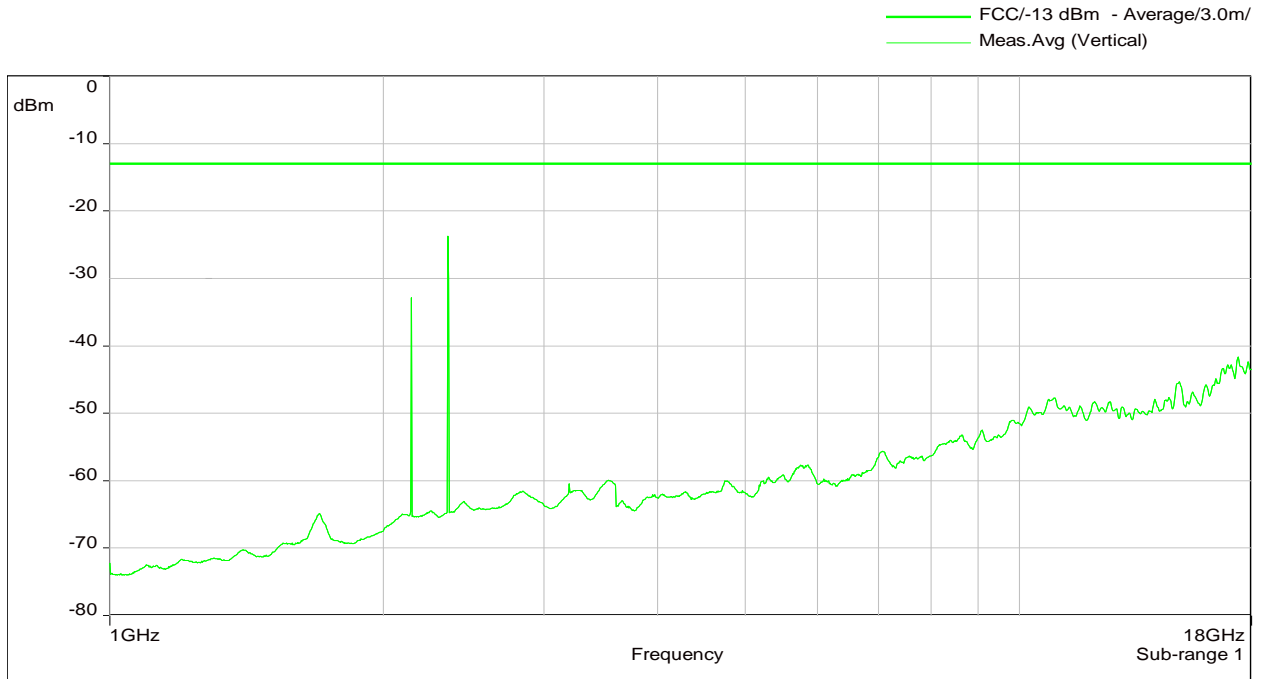

Horizontal

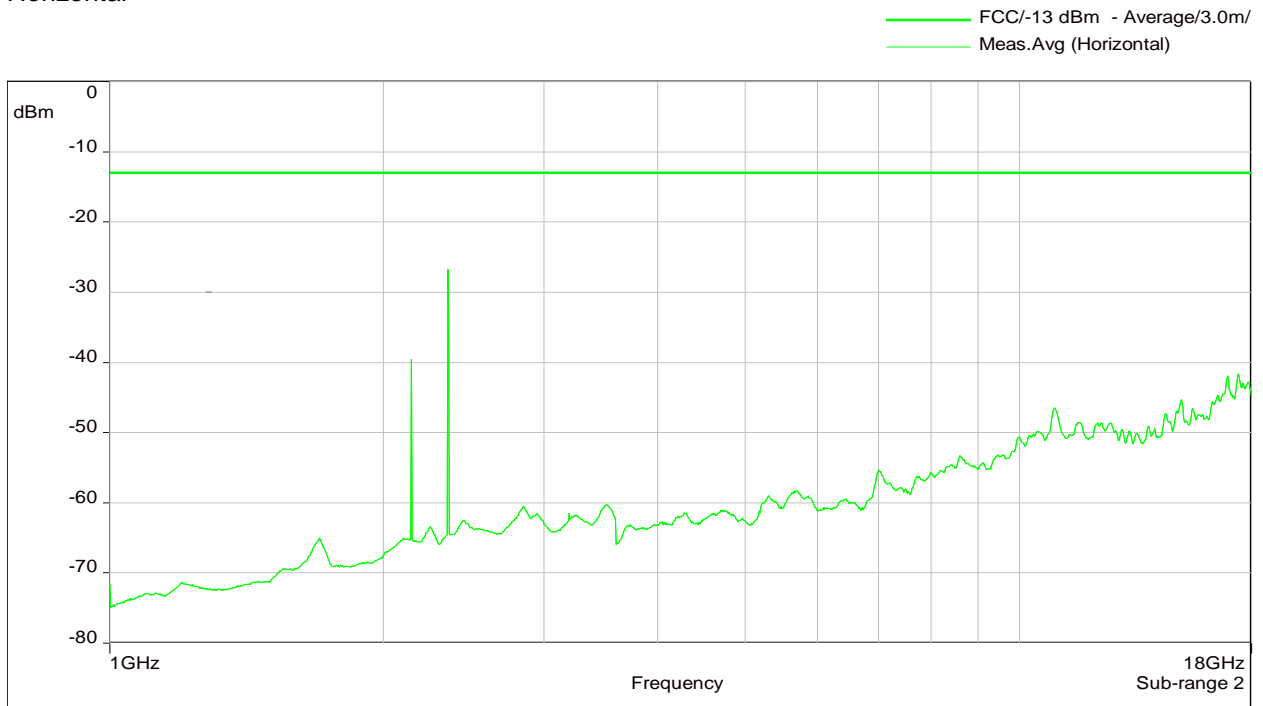

The RF output power is terminated.



### 10.5.5 18 GHz to 26.5 GHz Downlink (Bottom – Middle – Top)

Bottom: 2350 MHz; Middle: 2355 MHz; Top: 2360 MHz (Operation: maximum power and MIMO)

Vertikal

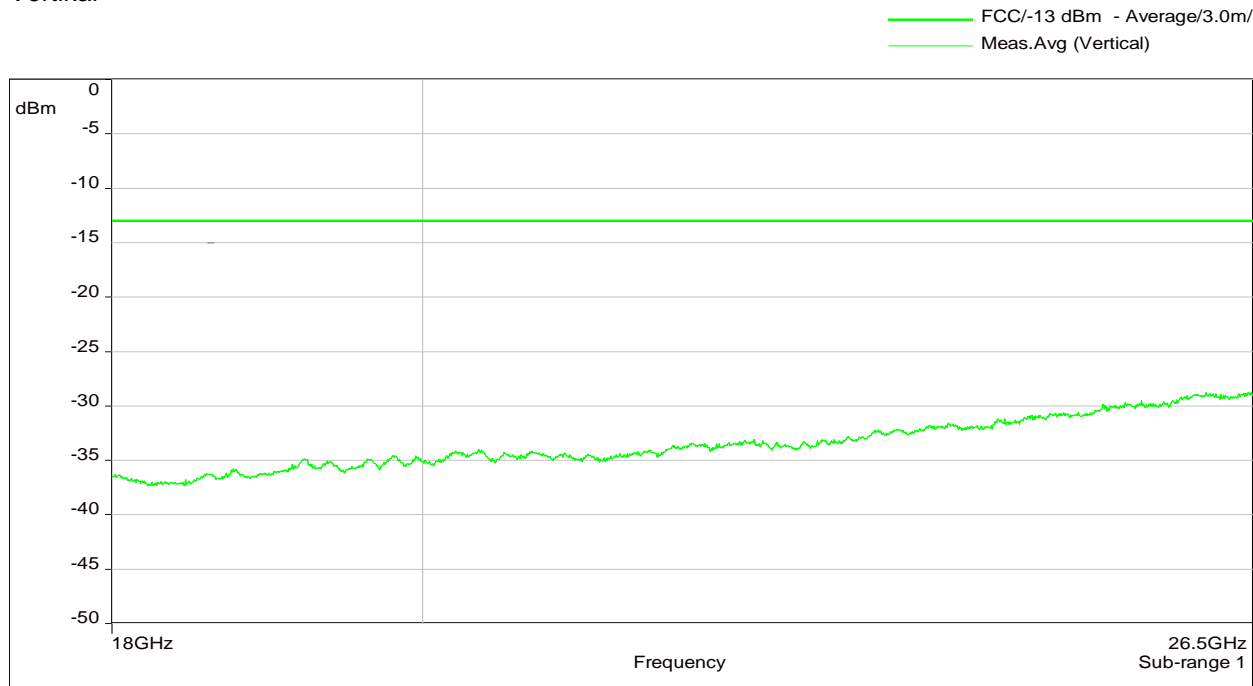

Horizontal

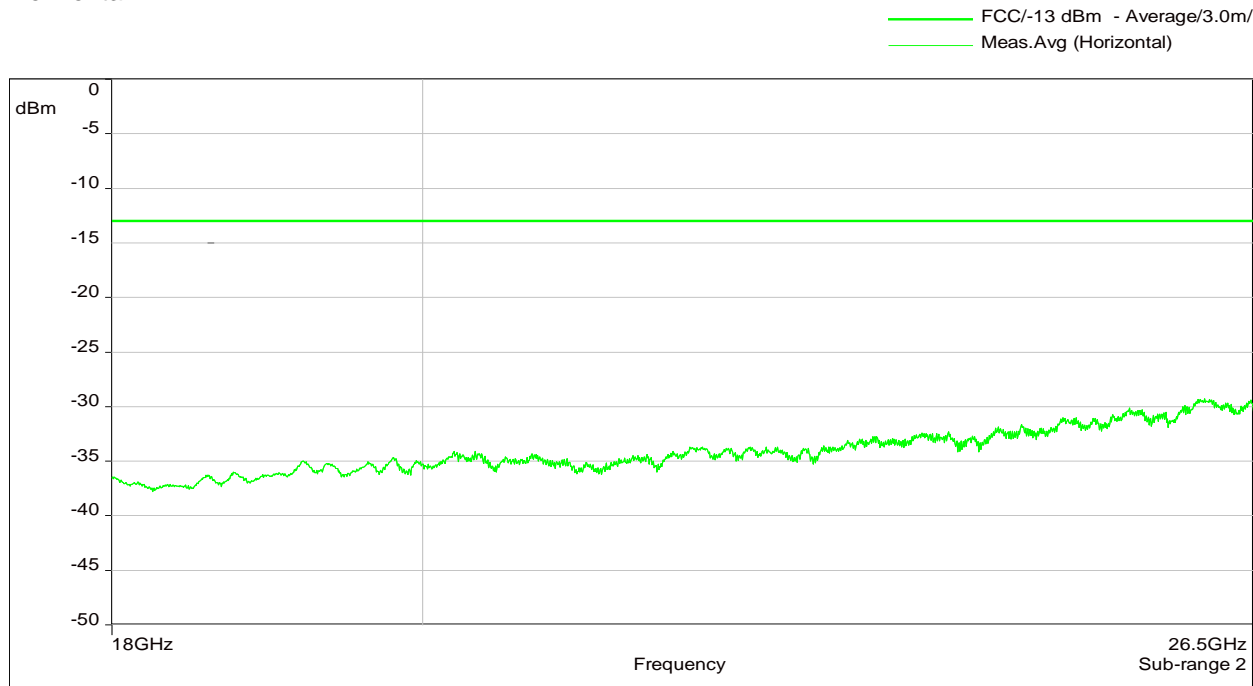

The RF output power is terminated.



### 10.5.6 18 GHz to 26.5 GHz Downlink (Middle of both paths)

F1: 2145 MHz; F2: 2355 MHz (Operation: maximum power and MIMO)

Vertikal

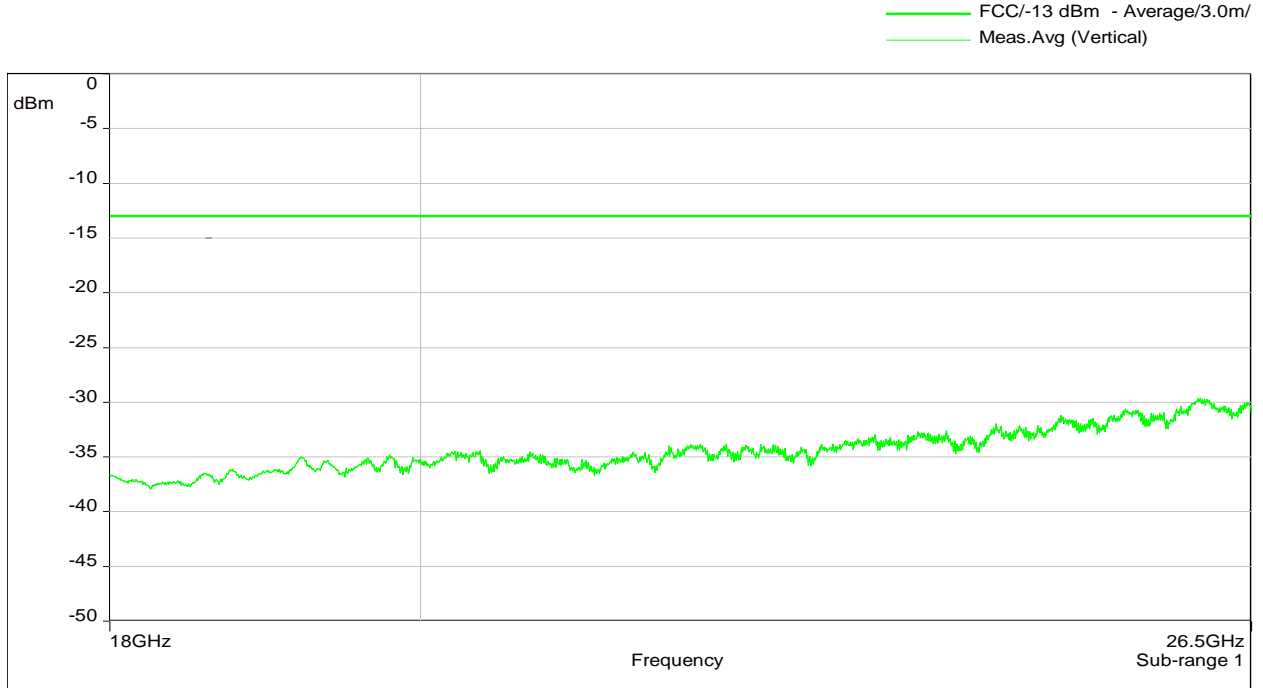

Horizontal

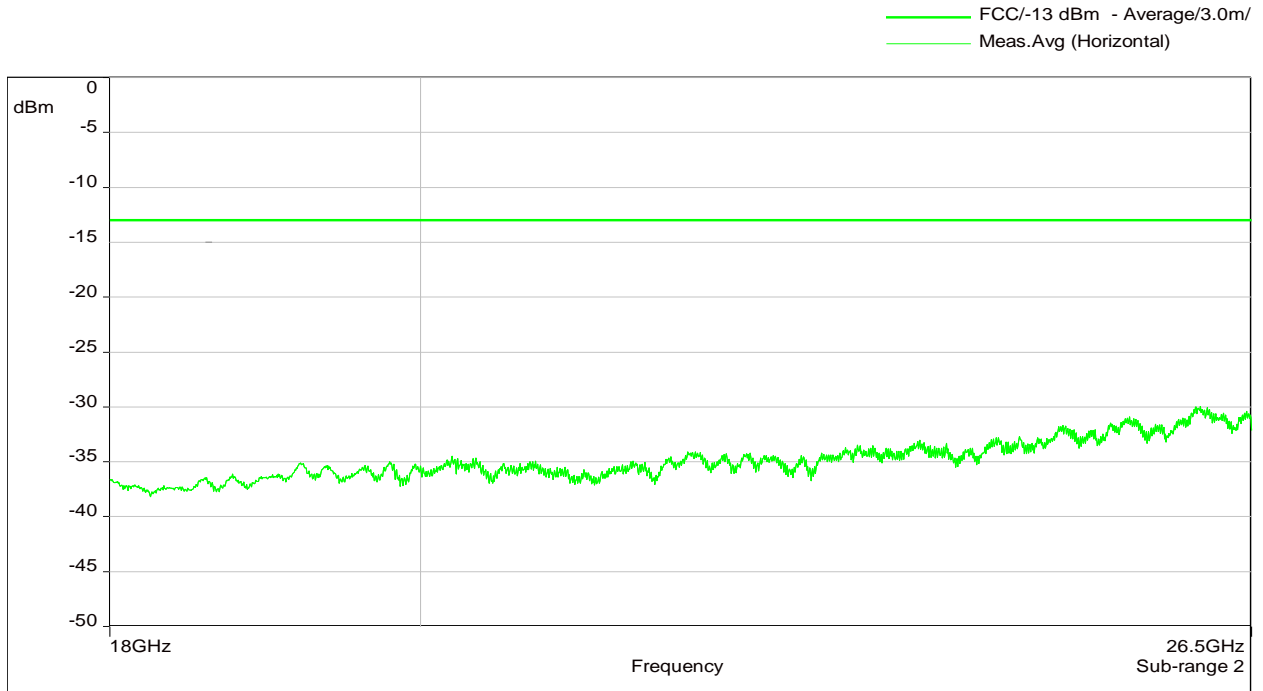

The RF output power is terminated.

Za / 05.05.2017

**The radiated spurious emission measurements have been passed!**



## 11 History

Revision	Modification	Date	Name
01.00	Initial report	05.07.2017	Tom Zahlmann

**\*\*\*\*\* End of test report \*\*\*\*\***