



# ECL-EMC Test Report No.: 17-142

**Equipment under test:** ION-E CAP L 17E/17E/23/23 C-PE-F1  
1700MHz Path  
**FCC ID:** XS5-CAPL17E23

**Type of test:** **FCC 47 CFR Part 27 Subpart C: 2017**  
Miscellaneous Wireless Communication Services

**Measurement Procedures:** 47 CFR Parts 2 (*Frequency Allocations and Radio Treaty Matters; General Rules and Regulations*),  
Part 27:2017 (*Miscellaneous Wireless Communication Services*),  
ANSI/TIA-603-D (2010), *Land Mobile FM or PM Communications Equipment Measurement and Performance Standards*

**Test result:** **Passed**

Date of issue:	25.07.17		Signature:
Issue-No.:	02	Author:	
Date of delivery:	04.05.17	Checked:	
Test dates:	21.03. – 05.05.17		
Pages:	46		



**Manufacturer:** ANDREW Wireless Systems GmbH  
Industriering 10

D-86675 Buchdorf

Tel.: +49 (0)9099 69 0

Fax: +49 (0)9099 69 140

**Test Location:** Bureau Veritas Consumer Products Services  
Germany GmbH  
European Compliance Laboratory (ECL)  
Thurn-und-Taxis-Straße 18

D-90411 Nürnberg

Tel.: +49 40 74041 0

Fax: +49 40 74041-2755

**General:**

The purpose of this report is to show compliance to the FCC regulations for devices operating under Part N°27 of the Code of Federal Regulations title 47.

This report informs about the results of the EMC tests, it only refers to the equipment under test. No part of this report may be reproduced in any form, without written permission.



## Table of contents

1	TEST RESULTS SUMMARY.....	5
2	EQUIPMENT UNDER TEST (E.U.T.).....	6
2.1	DESCRIPTION.....	6
2.1.1	DOWNLINK.....	6
2.1.2	UPLINK.....	6
2.1.3	DESCRIPTION OF EUT .....	7
2.1.4	BLOCK DIAGRAM OF MEASUREMENT REFERENCE POINTS.....	8
2.1.5	LEVELS @ REFERENCE POINTS (DL).....	8
3	TEST SITE (ANDREW BUCHDORF).....	9
3.1	TEST ENVIRONMENT .....	9
3.2	TEST EQUIPMENT .....	9
3.3	INPUT AND OUTPUT LOSSES .....	10
3.4	MEASUREMENT UNCERTAINTY .....	10
4	TEST SITE (BUREAU VERITAS CONSUMER PRODUCTS SERVICES).....	10
5	RF POWER OUT: §27.50, §2.1046.....	11
5.1	LIMIT .....	11
5.2	TEST METHOD.....	11
5.3	TEST RESULTS .....	12
5.3.1	DOWNLINK.....	12
5.3.1.1	W-CDMA .....	14
5.3.1.2	LTE.....	14
5.3.2	UPLINK.....	15
5.4	SUMMARY TEST RESULT .....	15
6	OCCUPIED BANDWIDTH: §2.1049 .....	16
6.1	LIMIT .....	16
6.2	TEST METHOD.....	16
6.3	TEST RESULTS .....	16
6.3.1	DOWNLINK.....	16
6.3.1.1	W-CDMA .....	18
6.3.1.2	LTE.....	19
6.3.2	26DB BANDWIDTH .....	20
6.3.2.1	W-CDMA .....	20
6.3.2.2	LTE.....	21
6.3.3	UPLINK.....	23
6.4	SUMMARY TEST RESULT .....	23
7	SPURIOUS EMISSIONS AT ANTENNA TERMINALS: §27.53, §2.1051 .....	24
7.1	LIMIT .....	24
7.2	TEST METHOD.....	24
7.3	TEST RESULTS .....	25
7.3.1	DOWNLINK.....	25
7.3.1.1	W-CDMA .....	26



---

7.3.1.2	LTE .....	27
7.3.2	UPLINK .....	27
7.4	SUMMARY TEST RESULT .....	27
8	INTERMODULATION: §27.53, §2.1051 .....	28
8.1	LIMIT .....	28
8.2	TEST METHOD .....	28
8.3	TEST RESULTS .....	29
8.3.1	DOWNLINK .....	29
8.3.1.1	WCDMA .....	30
8.3.1.2	LTE .....	31
8.3.2	UPLINK .....	32
8.4	SUMMARY TEST RESULT .....	32
9	OUT OF BAND REJECTION .....	33
9.1	LIMIT .....	33
9.2	TEST METHOD .....	33
9.3	TEST RESULTS .....	33
9.3.1	DOWNLINK .....	34
9.3.2	UPLINK .....	34
9.4	SUMMARY TEST RESULT .....	34
10	FIELD STRENGTH OF SPURIOUS EMISSIONS: §27.53, §2.1053 .....	35
10.1	METHOD OF MEASUREMENT .....	38
10.2	LIMIT §27.53 (H) .....	39
10.3	CLIMATIC VALUES IN THE LAB .....	39
10.4	TEST RESULTS .....	40
10.4.1	30 MHZ TO 1 GHZ DOWNLINK (BOTTOM – MIDDLE – TOP) .....	40
10.4.2	30 MHZ TO 1 GHZ DOWNLINK (MIDDLE OF BOTH PATHS) .....	41
10.4.3	1 GHZ – 18 GHZ DOWNLINK (BOTTOM – MIDDLE – TOP) .....	42
10.4.4	1 GHZ – 18 GHZ DOWNLINK (MIDDLE OF BOTH PATHS) .....	43
10.4.5	18 GHZ – 26 GHZ DOWNLINK (BOTTOM – MIDDLE – TOP) .....	44
10.4.6	18 GHZ – 26 GHZ DOWNLINK (MIDDLE OF BOTH PATHS) .....	45
11	HISTORY .....	46



## 1 Test Results Summary

Name of Test	FCC Para. No.	FCC Method	FCC Spec.	Result
RF Power Output	27.50(d)	2.1046	1640 Watts/MHz	Complies
Occupied Bandwidth	KDB 935210 D02 v03r02	2.1049	Input/Output	Complies
Spurious Emissions at Antenna Terminals	27.53(h)	2.1051	-13dBm	Complies
Field Strength of Spurious Emissions	27.53(m)	2.1053 TIA/EA-603	-13dBm E.I.R.P	Complies
Intermodulation	KDB 935210 D02 v03r02	KDB 935210 D02 v03r02	KDB 935210 D02 v03r02	Complies
Frequency Stability	27.54	2.1055	Must stay in band	NA
Out of Band Rejection	KDB 935210 D02 v03r02	KDB 935210 D03 v04	KDB 935210 D03 v04	Complies

Frequency stability is given by: The system gets an electrical analog signal from the BSS which is converted into an analog optical signal, transmitted by the optical links and then reconverted in the Remote Unit into an analog electrical signal. During this process happens no frequency change/modification, so input and output have same frequency what can be seen under clause "Occupied Bandwidth".



## 2 Equipment under test (E.U.T.)

### 2.1 Description

Kind of equipment	ION-E CAP L 17E/17E/23/23 (Remote Unit)	
Andrew Ident. Number	7770203-0001	
Serial no.(SN)	M002E1-R7506E2	
Revision	00	
Software version and ID	n. a.	
Type of modulation and Designator	W-CDMA (F9W)	<input checked="" type="checkbox"/>
	LTE (G7D)	<input checked="" type="checkbox"/>
Frequency Translation	F1-F1	<input checked="" type="checkbox"/>
	F1-F2	<input type="checkbox"/>
	N/A	<input type="checkbox"/>
Band Selection	Software	<input checked="" type="checkbox"/>
	Duplexer	<input checked="" type="checkbox"/>
	Full band	<input type="checkbox"/>

#### 2.1.1 Downlink

Pass band	2110 MHz – 2180 MHz
Max. composite output power based on one carrier per path (rated)	21 dBm = 0.13 W
MIMO max. composite output power based on one carrier per path (rated)	24 dBm = 0.26 W
System Gain*	26 dB @ Pout BTS of 21 dBm

\*see 2.1.5

#### 2.1.2 Uplink

Pass band	1710 MHz – 1780 MHz
Maximum rated output power	n. a.
System Gain*	n.a.

\*see 2.1.5

Note: The EUT does not transmit over the air in the uplink direction.

### 2.1.3 Description of EUT

CommScope's ION-E CAP L 17E/17E/23/23 is a multi-band, multi-operator Remote Unit. It is used in conjunction with a Master Unit (CAN) with poe. This system transports up to four frequency bands simultaneously, providing a cost-effective solution for distributing capacity from one or more base stations. The ION-E CAP L system can be used for MIMO application in all RF paths.

This Test Report describes only the approval of the 1700/2100 MHz Path.  
The ION-E CAP L 17E/17E/23/23 Repeater system consists of one (or two in MIMO operation) 1700/2100 AWS-E MHz path and one/two 2300 MHz path with the intended use of simultaneous transmission.

The antenna(s) used with device must be fixed-mounted on permanent structures.

**2.1.4 Block diagram of measurement reference points**

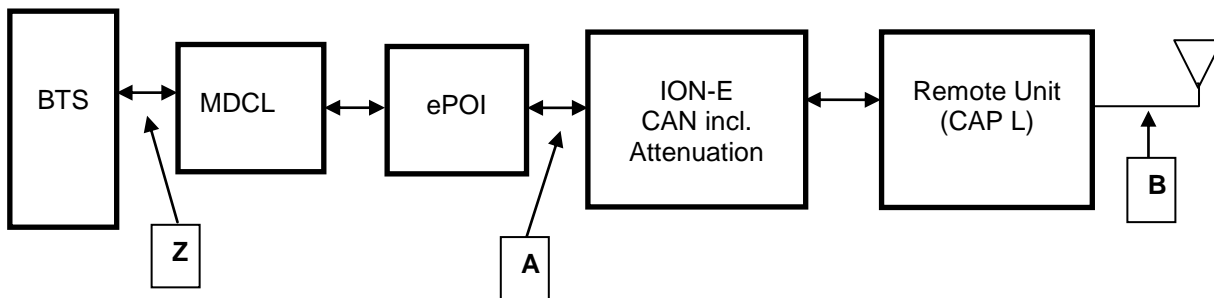

figure 2.1.4-#1 Block diagram of measurement reference points

Remote Unit (CAP L) is the DUT

- MU Master Unit = ePOI and CAN
- RU Remote Unit = CAP L
- CAP L Carrier Access Point Low Power
- CAN Central Area Node
- CAN att Attenuation of Central Access Node
- MDCL Minimum Donor Coupling Loss

Reference point A, CAN UL output, DL input  
 Reference point B, Remote Unit DL output, UL input  
 Reference point Z, BTS DL input, BTS UL output

**2.1.5 Levels @ reference points (DL)**

System optimized for BTS power <b>Z</b>	MDCL + ePOI Attenuation	Maximum rated input power at the CAN <b>A</b>	RU (CAP L) Gain <b>A to B</b>	Maximum rated output power at CAP L Antenna port <b>B</b>
<b>+33 dBm @ 1 carrier</b>	<b>38 dB</b>	<b>-5 dBm</b>	<b>26 dB</b>	<b>+21 dBm @ 1 carrier</b>
<b>System Gain Z to B</b>	<b>-12 dB</b>			
<b>2x (+33 dBm)</b>	<b>41 dB</b>	<b>-8 dBm / carrier @ 2 carrier</b>	<b>26 dB</b>	<b>+18 dBm / carrier @ 2 carrier</b>
<b>System Gain Z to B</b>	<b>-15 dB</b>			
<b>+43 dBm</b>	<b>48 dB</b>	<b>-5 dBm</b>	<b>26 dB</b>	<b>+21 dBm @ 1 carrier</b>
<b>System Gain Z to B</b>	<b>-12 dB</b>			

table 2.1.5-#1 Equipment under test (E.U.T.) Description Levels @ reference points (DL)





### 3 Test site (Andrew Buchdorf)

#### 3.1 Test environment

All tests were performed under the following environmental conditions:

Condition	Minimum value	Maximum value
Barometric pressure	86 kPa	106 kPa
Temperature	15°C	30°C
Relative Humidity	20 %	75 %
Power supply range	±5% of rated voltages	

#### 3.2 Test equipment

ANDREW Inv. No.	Test equipment	Type	Manufacturer	Serial No.	Next Calibration Date
9126	Spectrum Analyzer	FSV 30	R&S	101237	08/2017
9069	Generator	SMBV100A	R&S	256275	08/2017
9046	Generator	SMBV100A	R&S	255090	05/2017
8542	Power Meter	E4418A	Agilent	GB38273230	01/2018
8544	Power Sensor	E8481H	Agilent	3318A19208	01/2018
7583	RF-Cable	Testpro 4.2	Radiall	---	CIU
7584	RF-Cable	Testpro 4.2	Radiall	---	CIU
7585	RF-Cable	Testpro 4.2	Radiall	---	CIU
7586	RF-Cable	Testpro 4.2	Radiall	---	CIU
7537	RF-Cable	Testpro 4.2 + Projack	Radiall	---	CIU
7542	RF-Cable	Testpro 4.2 + Projack	Radiall	---	CIU
7531	Notch-Filter	WRCTG12 2110-2180	Wainwright	1	CIU
7406	Matrix		COMMSCOPE	---	weekly

CIU = Calibrate in use



### 3.3 Input and output losses

All recorded power levels should be referenced to the input and output connectors of the repeater, unless explicitly stated otherwise.

The test equipment used in this test has to be calibrated, so that the functionality is also checked.

All cables, attenuators, splitter, isolator, circulator and combiner etc. must be measured before testing and used for compensation during testing.

### 3.4 Measurement uncertainty

The extended measurement uncertainty corresponds to the measurement results from the standard measurement uncertainty multiplied by the coverage factor  $k=2$ . The true value is located in the corresponding interval with a probability of 95 %.

## 4 Test site (Bureau Veritas Consumer Products Services)

FCC Test site: 96997

See relevant dates under section 10 of this test report.



## 5 RF Power Out: §27.50, §2.1046

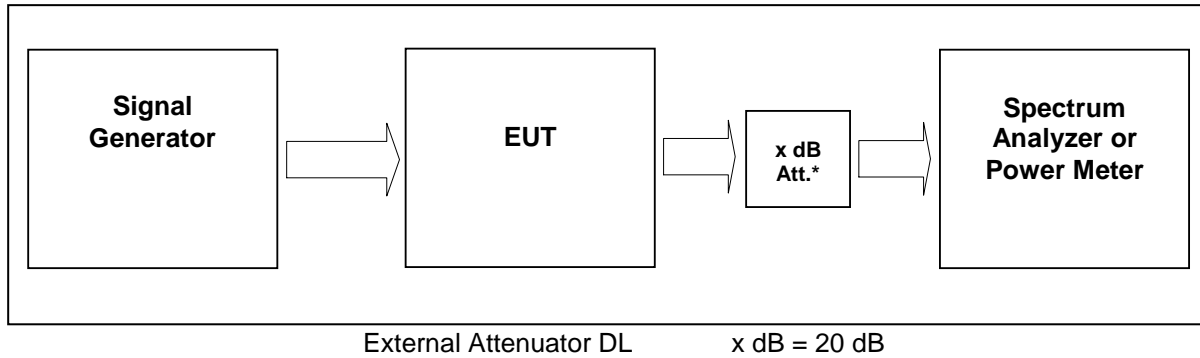

figure 5-#1 Test setup: RF Power Out: §27.50, §2.1046

Measurement uncertainty	± 0,32 dB
Test equipment used	9046, 9126, 7406, 7157, 7158, 7289, 7290, 7385

### 5.1 Limit

Minimum standard:

Para. No.27.50(d)

(d) The following power and antenna height requirements apply to stations transmitting in the 1695-1710 MHz, 1710-1755 MHz, 1755-1780 MHz, 1915-1920 MHz, 1995-2000 MHz, 2000-2020 MHz, 2110-2155 MHz, 2155-2180 MHz and 2180-2200 MHz bands:

(2) The power of each fixed or base station transmitting in the 1995-2000 MHz, the 2110-2155 MHz 2155-2180 MHz band, or 2180-2200 MHz band and situated in any geographic location other than that described in paragraph (d)(1) of this section is limited to:

- (i) An equivalent isotropically radiated power (EIRP) of 1640 watts when transmitting with an emission bandwidth of 1 MHz or less;
- (ii) An EIRP of 1640 watts/MHz when transmitting with an emission bandwidth greater than 1 MHz.

### 5.2 Test method

§ 2.1046 Measurements required: RF power output.

(a) For transmitters other than single sideband, independent sideband and controlled carrier radiotelephone, power output shall be measured at the RF output terminals when the transmitter is adjusted in accordance with the tune-up procedure to give the values of current and voltage on the circuit elements specified in § 2.1033(c)(8). The electrical characteristics of the radio frequency load attached to the output terminals when this test is made shall be stated.

(c) For measurements conducted pursuant to paragraphs (a) and (b) of this section, all calculations and methods used by the applicant for determining carrier power or peak envelope power, as appropriate, on the basis of measured power in the radio frequency load attached to the transmitter output terminals shall be shown. Under the test conditions specified, no components of the emission spectrum shall exceed the limits specified in the applicable rule parts as necessary for meeting occupied bandwidth or emission limitations



### 5.3 Test results

Detector RMS.

#### Test signal WCDMA

Signal waveform according to Test Model 1 of standard specification 3GPP TS25.141. Signal modulated with a combination of PCCPCH, SCCPCH and Dedicated Physical Channels specified as test model 1 64 DPCH.

#### Test signal LTE:

Signal waveform according to Test Model 1.1, E-TM1.1, clause 6.1.1.1-1, table 6.1.1.1-1 of standard specification 3GPP TS 36.141 V9.3.0 (2010-03).

#### 5.3.1 Downlink

Modulation	Measured at	Path	RBW VBW Span	RF Power (dBm)	RF Power (W)	MIMO* RF Power (W)	Plot -
WCDMA	Middle	2145 MHz	10MHz 10MHz 50MHz	21.0	0.13	0.25	5.3.1.1 #1
LTE	Middle	2145 MHz	3MHz 10MHz 15MHz	21.0	0.13	0.25	5.3.1.2 #1
Maximum output power = 21 dBm = 0.13 W							
Limit Maximum output power (erp) = 1000 W							

table 5.3.1-#1 RF Power Out: §27.50, §2.1046 Test results Downlink

#### SISO:

The max RF Power out is 21 dBm, so the maximum antenna gain (x) can be calculated as follow:

**Limit = 1000W (erp) = 60 dBm**

Info: 1000W (erp) = 1640W (eirp)

$60 \text{ dBm} > 21 \text{ dBm} + x \rightarrow x = 60 \text{ dBm} - 21 \text{ dBm} = \underline{39 \text{ dBd}}$

$x \text{ dBi} = 39 \text{ dBd} + 2.15 = \underline{41.15 \text{ dBi}}$

=> The antenna that will be used for the complete system have to have a gain lower than 41.15 dBi, relative to a dipol.



**MIMO:**

If the DUT used in MIMO configuration according to KDB 662911, the MIMO Max RF Power is the sum of the RF power from the SISO path and MIMO path.

$$\text{MIMO Max RF Power} = \text{SISO path RF Power} + \text{MIMO path RF Power}$$

$$\text{MIMO Max RF Power} = 0.13 \text{ W} + 0.13 \text{ W} = 0.26 \text{ W} = 24 \text{ dBm}$$

The MIMO max RF Power out is 24 dBm, so the maximum antenna gain (x) can be calculated as follow:

$$\text{Limit} = 1000\text{W (erp)} = \mathbf{60 \text{ dBm}}$$

$$\text{Info: } 1000\text{W (erp)} = 1640\text{W (eirp)}$$

$$60 \text{ dBm} > 24 \text{ dBm} + x \text{ -----> } x = 60 \text{ dBm} - 24 \text{ dBm} = \mathbf{36 \text{ dBd}}$$

$$x \text{ dBi} = 36 \text{ dBd} + 2.15 = \mathbf{38.15 \text{ dBi}}$$

=> The antenna that will be used for the complete system have to have a gain lower than 38.15 dBi, relative to a dipol.

Modulation	Pin / dBm (Ref. point B)
WCDMA	-5.1
LTE	-5.0

table 5.3.1-#2 RF Power Out: §27.50, §2.1046 Test results Downlink Input power



### 5.3.1.1 W-CDMA

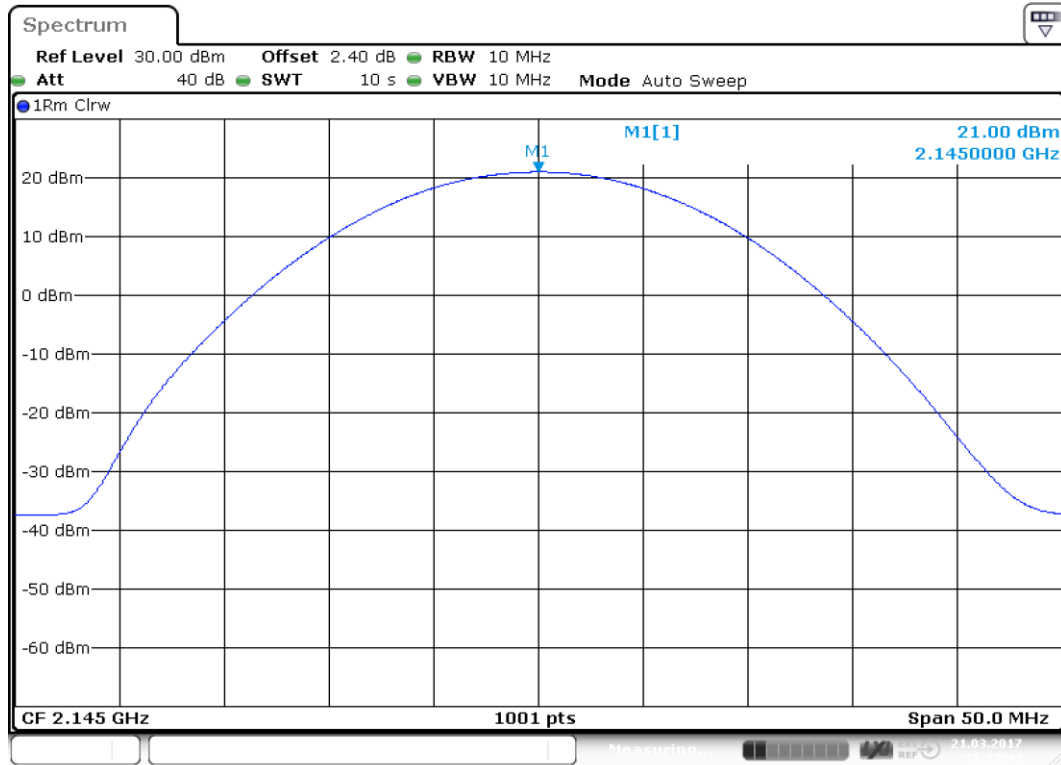

Date: 21.MAR.2017 15:38:44

plot 5.3.1.1-#1 RF Power Out: §27.50, §2.1046; Test results; Downlink; W-CDMA Middle

### 5.3.1.2 LTE

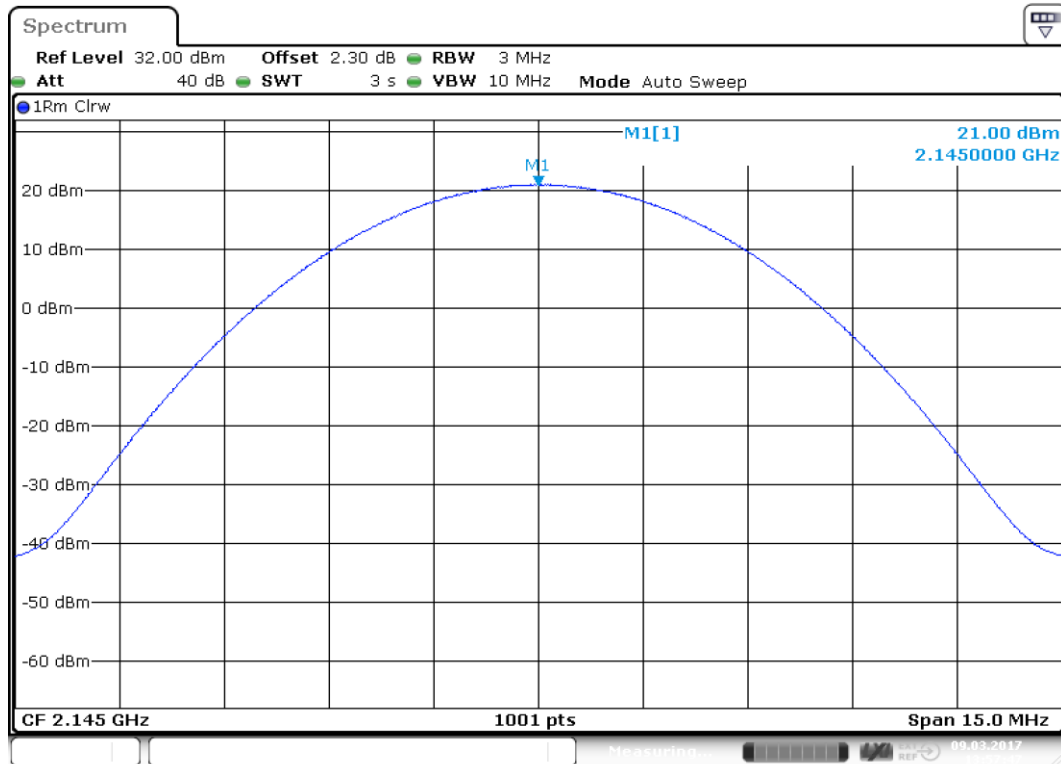

Date: 9.MAR.2017 13:57:48

plot 5.3.1.2-#1 RF Power Out: §27.50, §2.1046; Test results; Downlink; LTE Middle

### 5.3.2 Uplink

n.a.

Note: The EUT does not transmit over the air in the uplink direction.

### 5.4 Summary test result

Test result	complies, according the plots above
Tested by:	F. Bengesser
Date:	09.03.2017 / 21.03.2017



## 6 Occupied Bandwidth: §2.1049

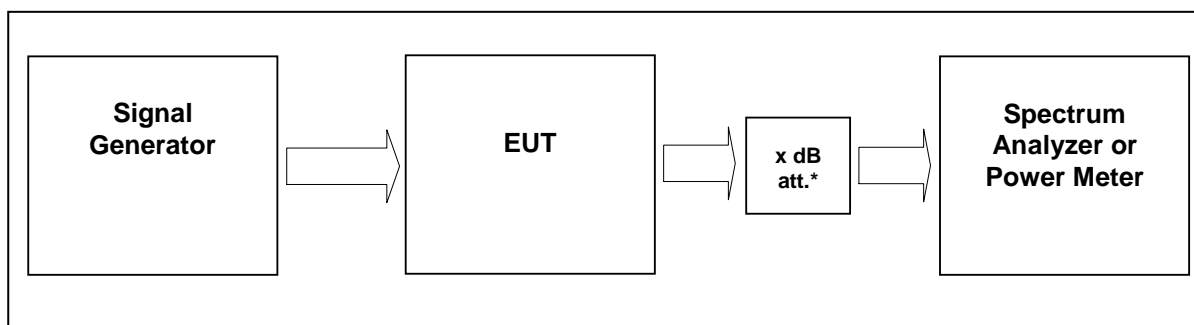

External Attenuator DL      x dB = 20 dB  
figure 6-#1 Test setup: Occupied Bandwidth: §2.1049

Measurement uncertainty	± 0,33 dB
Test equipment used	9046, 9126, 7406, 7157, 7158, 7289, 7290, 7385

### 6.1 Limit

The spectral shape of the output should look similar to input for all modulations.

### 6.2 Test method

Para. No.2.1049

The occupied bandwidth, that is the frequency bandwidth such that, below its lower and above its upper frequency limits, the mean powers radiated are each equal to 0.5 percent of the total mean power radiated by a given emission shall be measured under the following conditions as applicable:

(h) Transmitters employing digital modulation techniques—when modulated by an input signal such that its amplitude and symbol rate represent the maximum rated conditions under which the equipment will be operated. The signal shall be applied through any filter networks, pseudo-random generators or other devices required in normal service. Additionally, the occupied bandwidth shall be shown for operation with any devices used for modifying the spectrum when such devices are optional at the discretion of the user.

### 6.3 Test results

#### 6.3.1 Downlink

Detector PK.

Modulation	Measured at	Fcenter / MHz	RBW VBW Span	Occupied Bandwidth / MHz	Plot #
WCDMA	Middle	2145	100kHz 1MHz 10MHz	4.04	6.3.1.1 #1, #2
LTE	Middle	2145	30 kHz 300 kHz 5 MHz	1.14	6.3.1.2 #1,#2





Modulation	Measured at	Fcenter / MHz	RBW VBW Span	26dB Bandwidth / MHz	Plot #
WCDMA	Middle	2145	100kHz 1MHz 10MHz	4.40	6.3.2.1 #1, #2
LTE	Middle	2145	30 kHz 300 kHz 5 MHz	1.32	6.3.2.2 #1,#2

table 6.3-#1 Occupied Bandwidth: §2.1049 Test results Downlink



### 6.3.1.1 W-CDMA

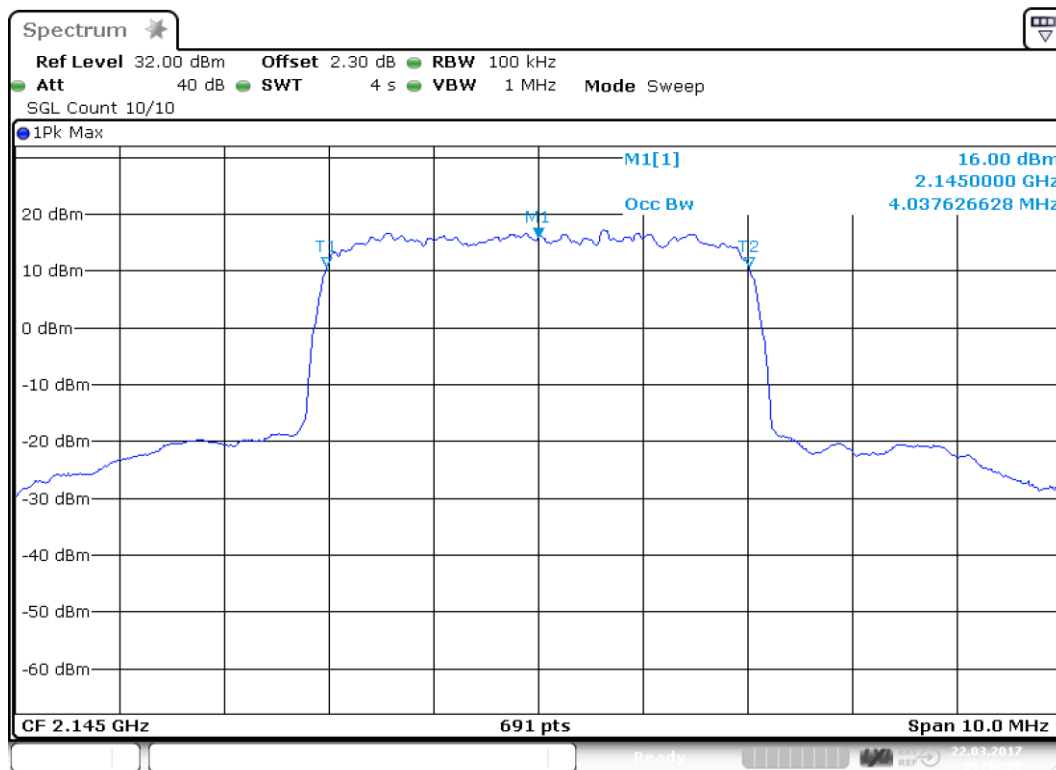

Date: 22.MAR.2017 06:45:21

plot 6.3.1.1-#1 Occupied Bandwidth: §2.1049; Test results; Downlink; W-CDMA Output

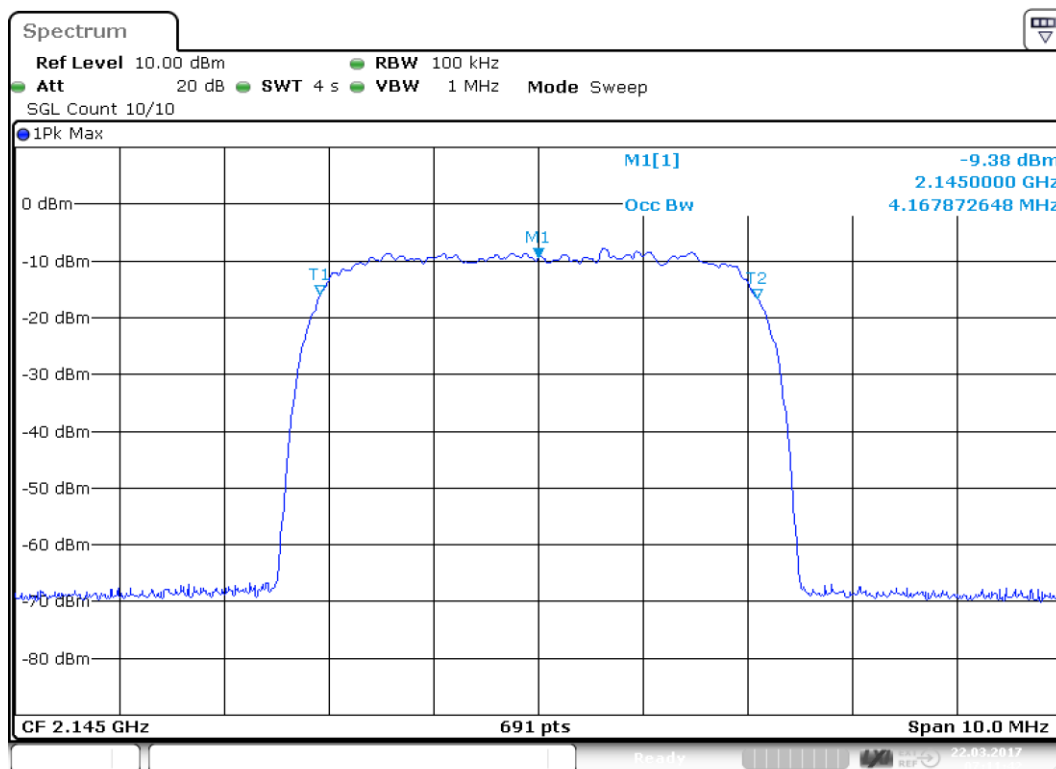

Date: 22.MAR.2017 07:11:43

plot 6.3.1.1-#2 Occupied Bandwidth: §2.1049; Test results; Downlink; W-CDMA Input



6.3.1.2 LTE

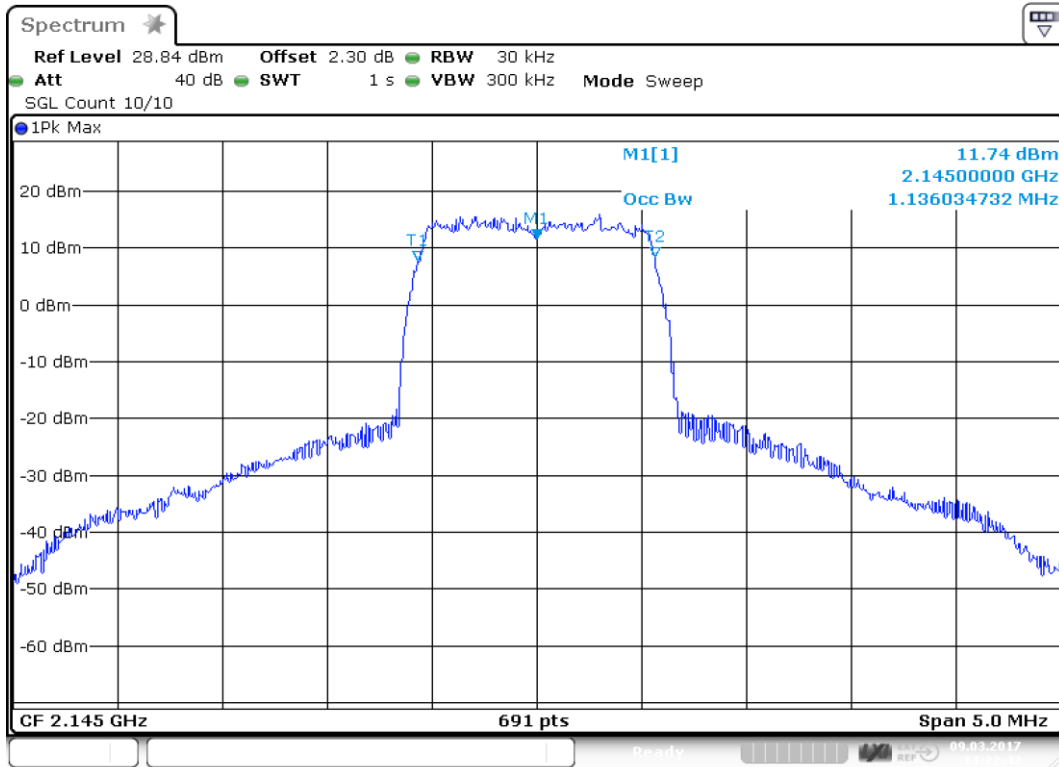

Date: 9.MAR.2017 14:22:43

plot 6.3.1.2-#1 Occupied Bandwidth: §2.1049; Test results; Downlink; LTE Output

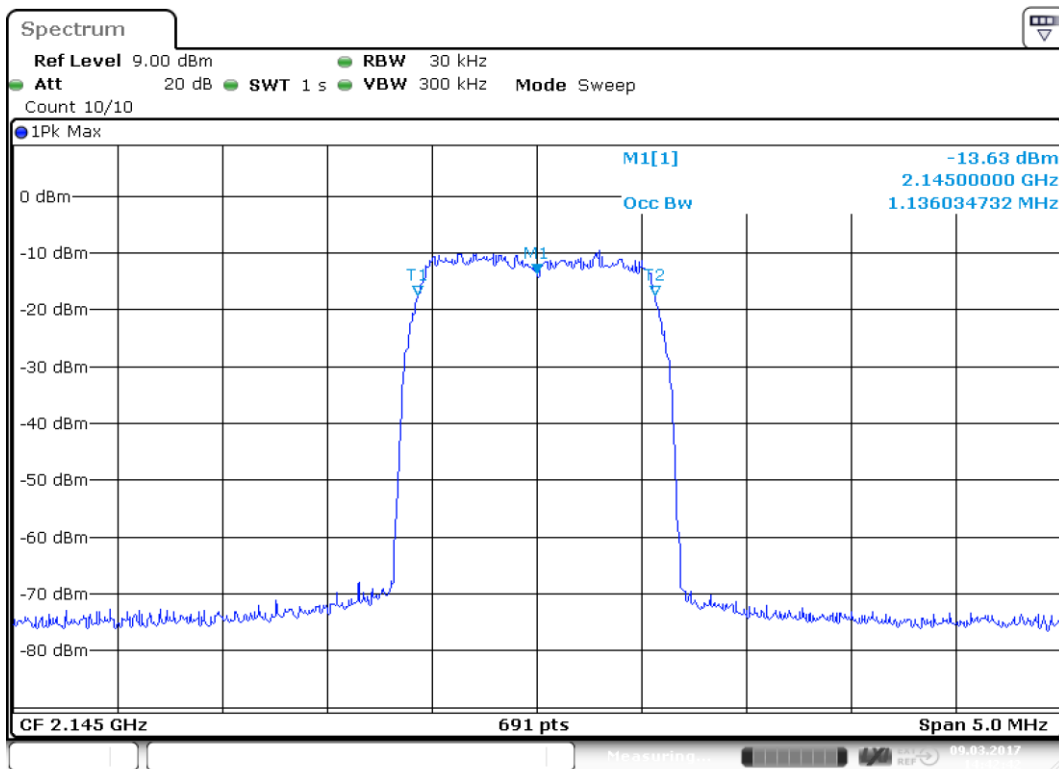

Date: 9.MAR.2017 14:42:43

plot 6.3.1.2-#2 Occupied Bandwidth: §2.1049; Test results; Downlink; LTE Input



### 6.3.2 26dB Bandwidth

#### 6.3.2.1 W-CDMA

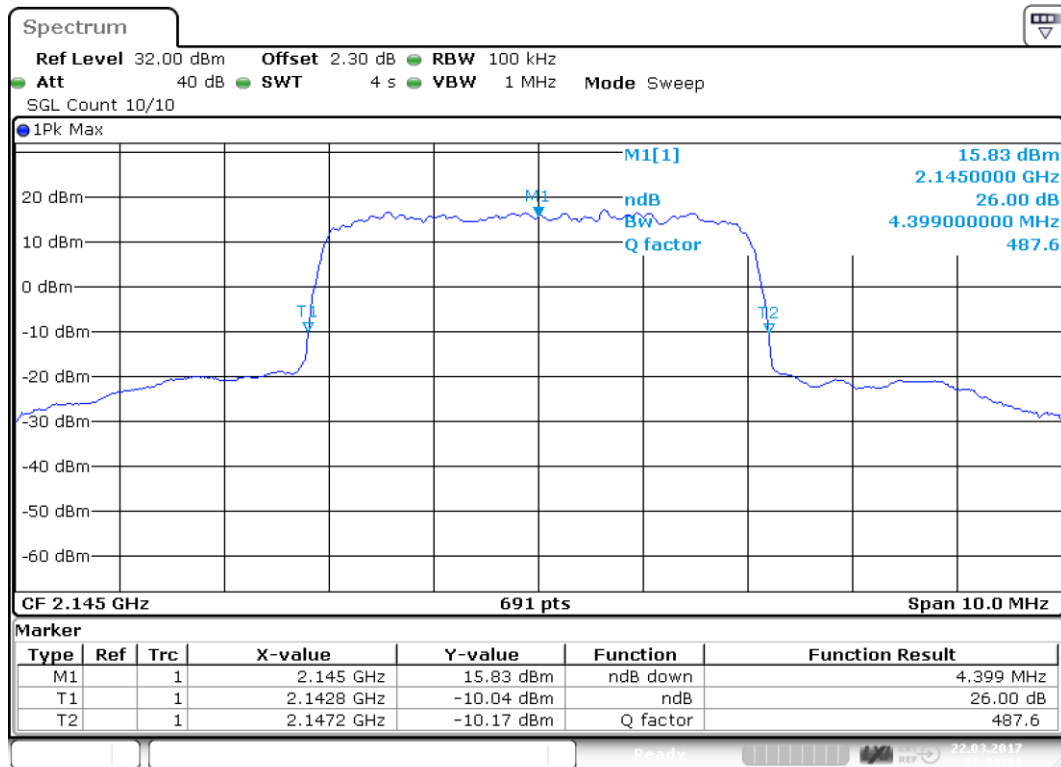

Date: 22.MAR.2017 07:21:32

plot 6.3.2.1-#1 Occupied Bandwidth: §2.1049; Test results; 26dB Bandwidth; W-CDMA Output

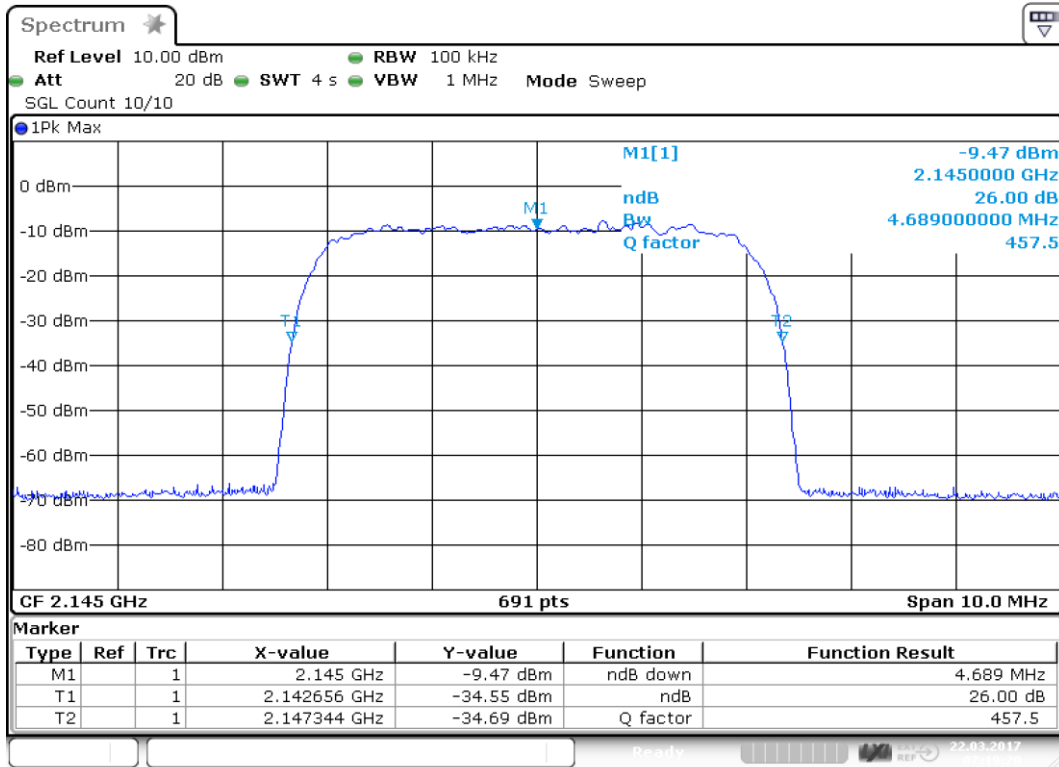

Date: 22.MAR.2017 07:19:21

6.3.2.2 LTE  
 plot 6.3.2.1-#2 Occupied Bandwidth: \$2.1049; Test results; 26dB Bandwidth; W-CDMA Input

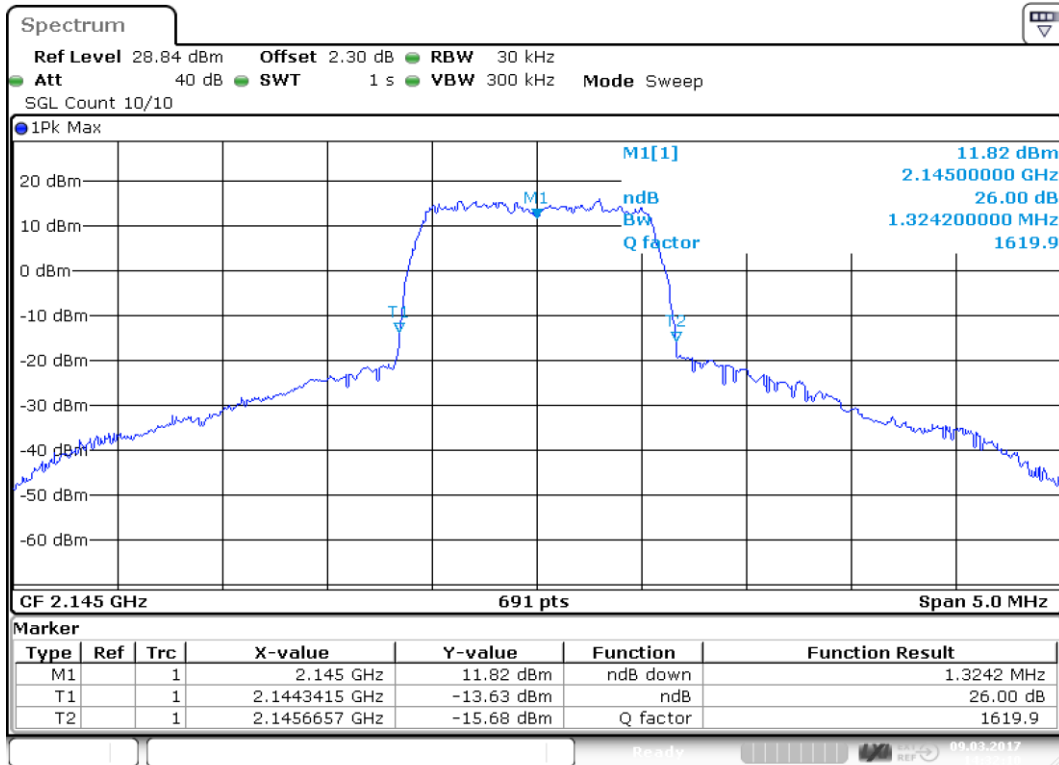

Date: 9.MAR.2017 14:32:11

plot 6.3.2.2-#1 Occupied Bandwidth: \$2.1049; Test results; 26dB Bandwidth; LTE Output

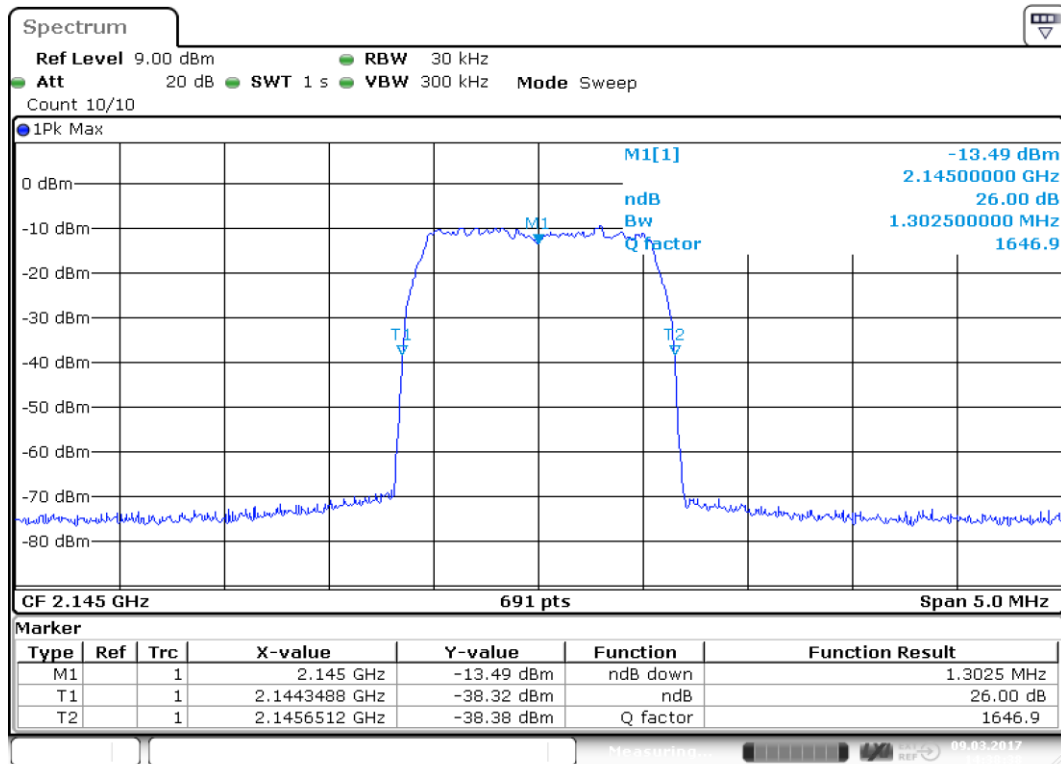

Date: 9.MAR.2017 14:38:39

plot 6.3.2.2-#2 Occupied Bandwidth: §2.1049; Test results; 26dB Bandwidth; LTE Input



---

### 6.3.3 Uplink

n.a.

Note: The EUT does not transmit over the air in the uplink direction.

### 6.4 Summary test result

Test result	complies, according the plots above
Tested by:	F. Bengesser
Date:	09.03.2017 / 22.03.2017



## 7 Spurious Emissions at Antenna Terminals: §27.53, §2.1051

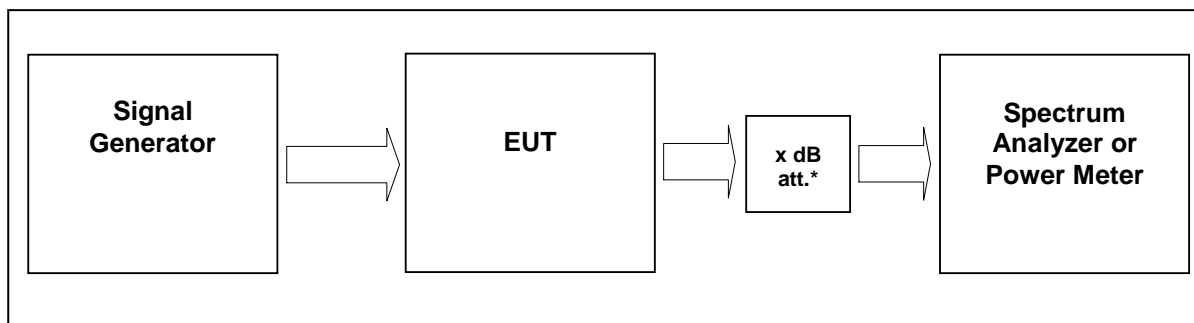

External Attenuator DL x dB = 20 dB  
figure 7-#1 Test setup: Spurious Emissions at Antenna Terminals: §27.53, §2.1051

Measurement uncertainty	± 0,41 dB ± 0,47 dB ± 0.94 dB ± 1.2 dB	9 kHz to 3,6 GHz 3,6 GHz to 7 GHz 7 GHz to 13,6 GHz 13,6 GHz to 30 GHz
Test equipment used	9069, 9046, 9126, 7406, 7157, 7158, 7289, 7290, 7531, 7385	

### 7.1 Limit

Minimum standard:

Para. No.27.53(h)

(h) *AWS emission limits*

(1) *General protection levels.* Except as otherwise specified below, for operations in the 1695-1710 MHz, 1710-1755 MHz, 1755-1780 MHz, 1915-1920 MHz, 1995-2000 MHz, 2000-2020 MHz, 2110-2155 MHz, 2155-2180 MHz, and 2180-2200 bands, the power of any emission outside a licensee's frequency block shall be attenuated below the transmitter power (P) in watts by at least  $33 + 10 \log_{10}(P)$  dB.

(3) *Measurement procedure.* (i) Compliance with this provision is based on the use of measurement instrumentation employing a resolution bandwidth of 1 megahertz or greater. However, in the 1 megahertz bands immediately outside and adjacent to the licensee's frequency block, a resolution bandwidth of at least one percent of the emission bandwidth of the fundamental emission of the transmitter may be employed. The emission bandwidth is defined as the width of the signal between two points, one below the carrier center frequency and one above the carrier center frequency, outside of which all emissions are attenuated at least 26 dB below the transmitter power.

(ii) When measuring the emission limits, the nominal carrier frequency shall be adjusted as close to the licensee's frequency block edges, both upper and lower, as the design permits.

(iii) The measurements of emission power can be expressed in peak or average values, provided they are expressed in the same parameters as the transmitter power.

### 7.2 Test method

Para. No 2.1051 Measurements required: Spurious emissions at antenna terminals.

The radio frequency voltage or powers generated within the equipment and appearing on a spurious frequency shall be checked at the equipment output terminals when properly loaded with a suitable artificial antenna. Curves or equivalent data shall show the magnitude of each harmonic and other spurious emission that can be detected when the equipment is operated under the conditions specified in § 2.1049 as appropriate. The magnitude of spurious emissions which are attenuated more than 20 dB below the permissible value need not be specified.

[39 FR 5919, Feb. 15, 1974. Redesignated and amended at 63 FR 36599, July 7, 1998]





**7.3 Test results**

**7.3.1 Downlink**

Detector: RMS.

Modulation	Carrier	RBW VBW Span	Max. level (dBm)	MIMO Max. level (dBm)	Plot -
WCDMA	2145 MHz	1MHz 3MHz 30MHz – 23GHz	-35.3	-32.3	7.3.1.1 #1
LTE	2145 MHz	1MHz 3MHz 30MHz – 23GHz	-35.5	-32.5	7.3.1.2 #1

table 7.3-#1 Spurious Emissions at Antenna Terminals: §27.53, §2.1051 Test results

If the DUT used in MIMO configuration according to KDB 662911, the summed emission (MIMO Max. Level) is calculated (Max. Level) of the output port plus  $10 \log(N_{ANT})$ . With ( $N_{ANT} = 2$ ) the MIMO Max. Level (dBm) equals Max. Level (dBm) plus 3dB.



### 7.3.1.1 W-CDMA

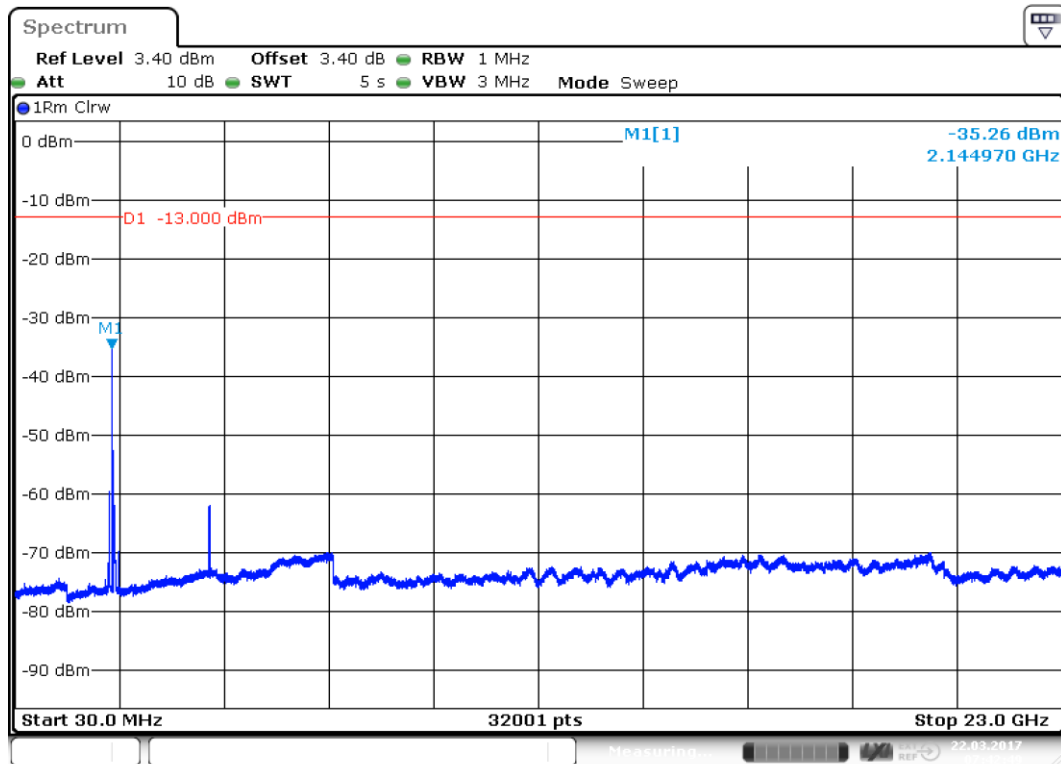

Date: 22.MAR.2017 07:42:49

plot 7.3.1.1-#1 Spurious Emissions at Antenna Terminals: §27.53, §2.1051; Test results; Downlink; W-CDMA; carrier (2145MHz) notched



**7.3.1.2 LTE**

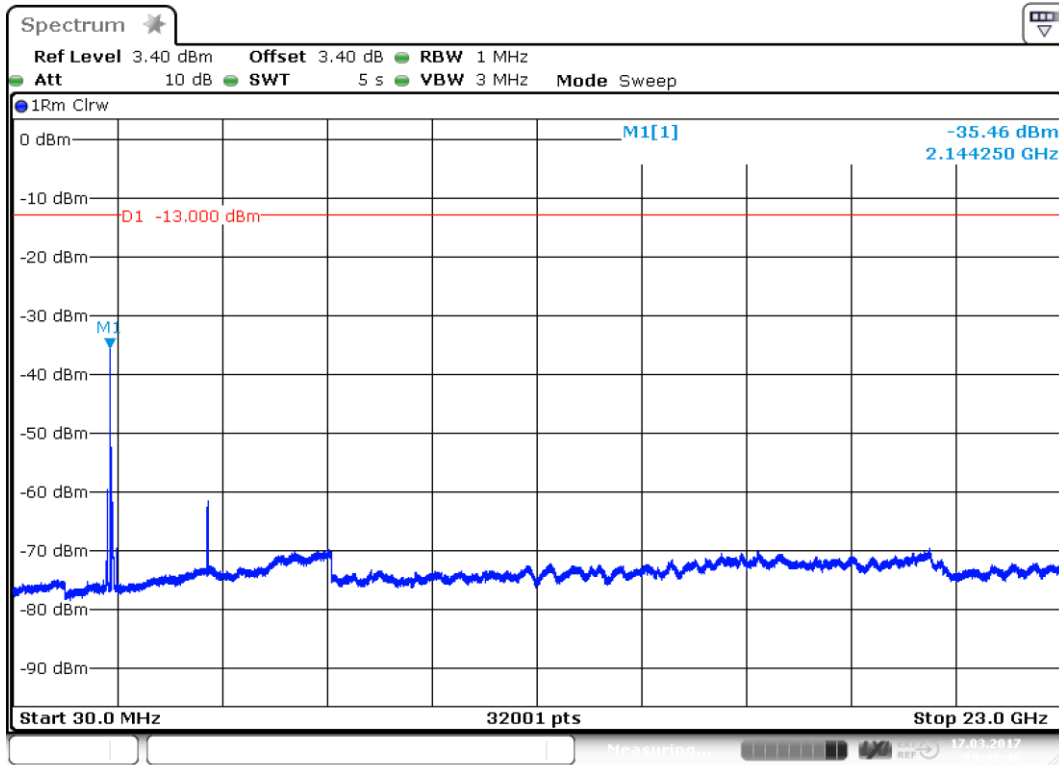

Date: 17.MAR.2017 09:41:46

plot 7.3.1.2-#1 Spurious Emissions at Antenna Terminals: §27.53, §2.1051; Test results; Downlink; LTE; carrier (2145MHz) notched

**7.3.2 Uplink**

n.a.

Note: The EUT does not transmit over the air in the uplink direction.

**7.4 Summary test result**

Test result	complies, according the plots above
Tested by:	F. Bengesser
Date:	17.03.2017 / 22.03.2017



## 8 Intermodulation: §27.53, §2.1051

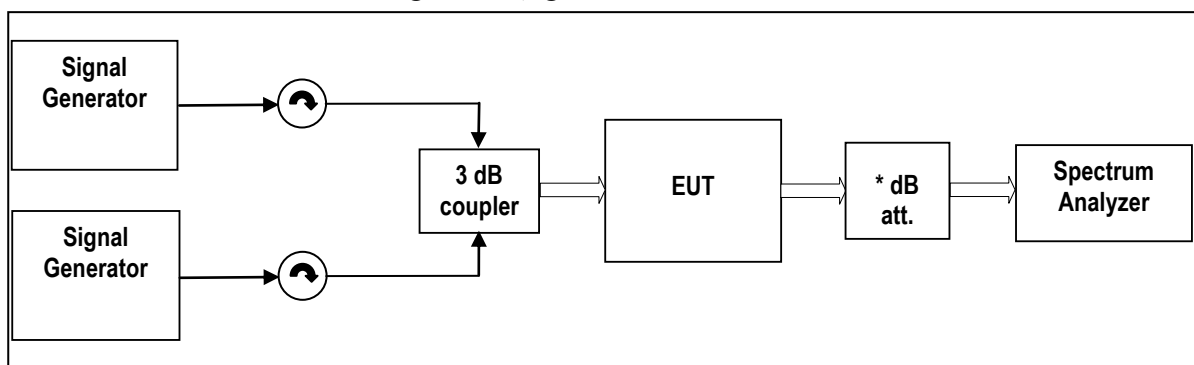

External Attenuator DL                      x dB = 20 dB  
figure 8-#1 Test setup: Intermodulation: §27.53, §2.1051

Measurement uncertainty	± 0,41 dB ± 0,47 dB ± 0.94 dB ± 1.2 dB	9 kHz to 3,6 GHz 3,6 GHz to 7 GHz 7 GHz to 13,6 GHz 13,6 GHz to 30 GHz
Test equipment used	9069, 9046, 9126, 7406, 7157, 7158, 7289, 7290, 7385	

### 8.1 Limit

Minimum standard:

Para. No.27.53(h)

(h) *AWS emission limits*

(1) *General protection levels.* Except as otherwise specified below, for operations in the 1695-1710 MHz, 1710-1755 MHz, 1755-1780 MHz, 1915-1920 MHz, 1995-2000 MHz, 2000-2020 MHz, 2110-2155 MHz, 2155-2180 MHz, and 2180-2200 bands, the power of any emission outside a licensee's frequency block shall be attenuated below the transmitter power (P) in watts by at least  $33 + 10 \log_{10}(P)$  dB.

(3) *Measurement procedure.* (i) Compliance with this provision is based on the use of measurement instrumentation employing a resolution bandwidth of 1 megahertz or greater. However, in the 1 megahertz bands immediately outside and adjacent to the licensee's frequency block, a resolution bandwidth of at least one percent of the emission bandwidth of the fundamental emission of the transmitter may be employed. The emission bandwidth is defined as the width of the signal between two points, one below the carrier center frequency and one above the carrier center frequency, outside of which all emissions are attenuated at least 26 dB below the transmitter power.

(ii) When measuring the emission limits, the nominal carrier frequency shall be adjusted as close to the licensee's frequency block edges, both upper and lower, as the design permits.

(iii) The measurements of emission power can be expressed in peak or average values, provided they are expressed in the same parameters as the transmitter power.

### 8.2 Test method

Para. No 2.1051 Measurements required: Spurious emissions at antenna terminals.

The radio frequency voltage or powers generated within the equipment and appearing on a spurious frequency shall be checked at the equipment output terminals when properly loaded with a suitable artificial antenna. Curves or equivalent data shall show the magnitude of each harmonic and other spurious emission that can be detected when the equipment is operated under the conditions specified in § 2.1049 as appropriate. The magnitude of spurious emissions which are attenuated more than 20 dB below the permissible value need not be specified.

[39 FR 5919, Feb. 15, 1974. Redesignated and amended at 63 FR 36599, July 7, 1998]



**8.3 Test results**

**8.3.1 Downlink**

Detector: RMS.

Modulation	Measured at Band Edge	Carriers	RBW VBW Span	Max. level (dBm)	MIMO Max. level (dBm)	Plot -
WCDMA	Lower Edge	2112,6 MHz 2117,6 MHz	100kHz 1MHz 15MHz	-45.4	-42.4	8.3.1.1 #1
	Upper Edge	2172,4 MHz 2177.4 MHz				#2
LTE	Lower Edge	2110,7 MHz 2112,1 MHz	30kHz 300kHz 6MHz	-43.5	-40.5	8.3.1.2 #1
	Upper Edge	2177,9 MHz 2179,3 MHz				#2

table 8.3-#1 Intermodulation: §27.53, §2.1051 Test results

If the DUT used in MIMO configuration according to KDB 662911, the summed emission (MIMO Max. Level) is calculated (Max. Level) of the output port plus  $10 \log(N_{ANT})$ . With ( $N_{ANT} = 2$ ) the MIMO Max. Level (dBm) equals Max. Level (dBm) plus 3dB.



### 8.3.1.1 WCDMA

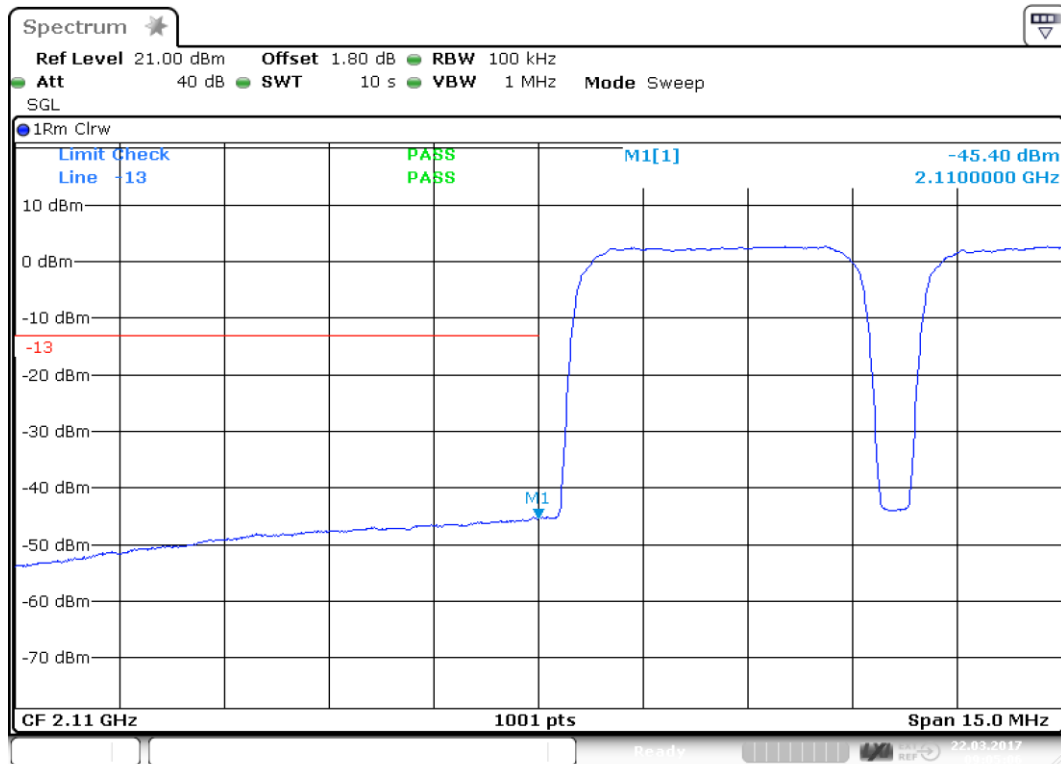

Date: 22.MAR.2017 09:05:07

plot 8.3.1.1-#1 Intermodulation: §27.53, §2.1051; Test results; Downlink; WCDMA Lower Band Edge

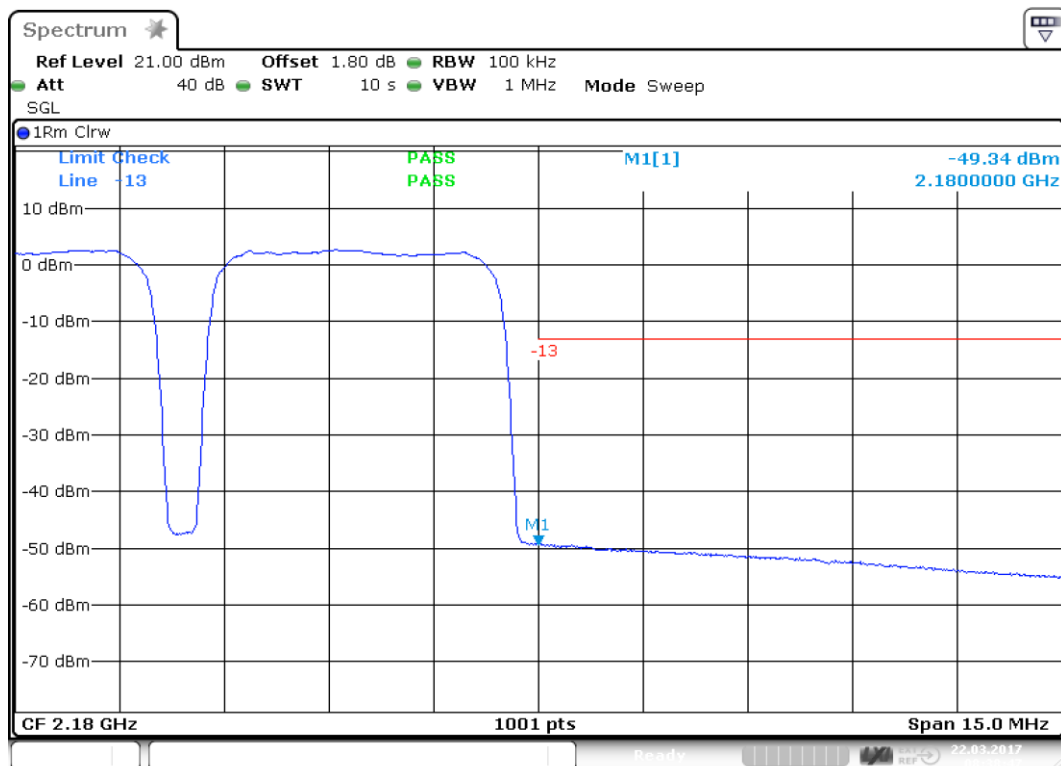

Date: 22.MAR.2017 08:38:48

plot 8.3.1.1-#2 Intermodulation: §27.53, §2.1051; Test results; Downlink; WCDMA Upper Band Edge



8.3.1.2 LTE

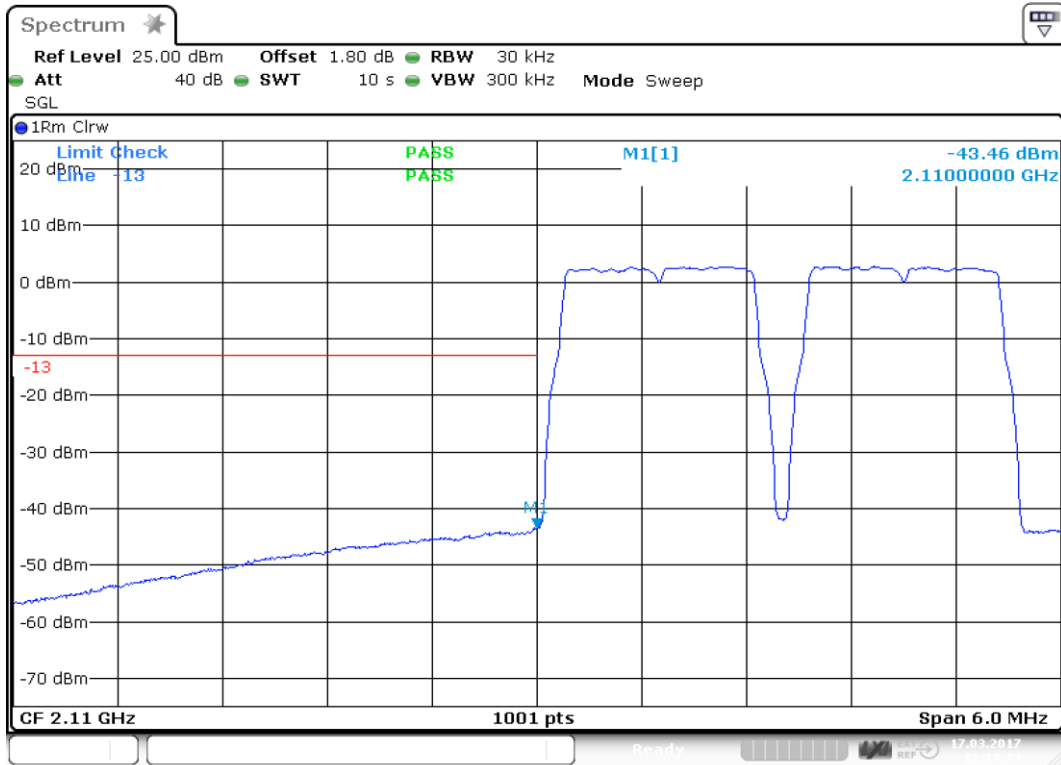

Date: 17.MAR.2017 12:13:23

plot 8.3.1.2-#1 Intermodulation: §27.53, §2.1051; Test results; Downlink; LTE Lower Band Edge

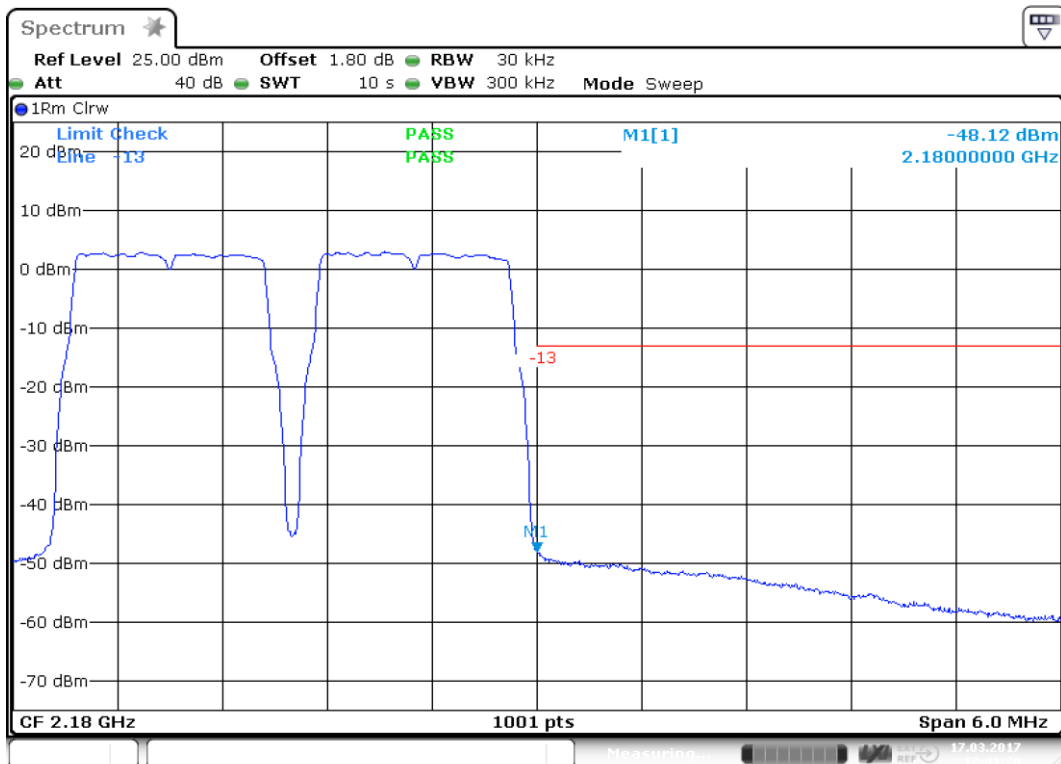

Date: 17.MAR.2017 12:41:20

plot 8.3.1.2-#2 Intermodulation: §27.53, §2.1051; Test results; Downlink; LTE Upper Band Edge



### 8.3.2 Uplink

n.a.

Note: The EUT does not transmit over the air in the uplink direction.

### 8.4 Summary test result

Test result	complies, according the plots above
Tested by:	F. Bengesser
Date:	17.03.2017 / 22.03.2017



## 9 Out of Band Rejection

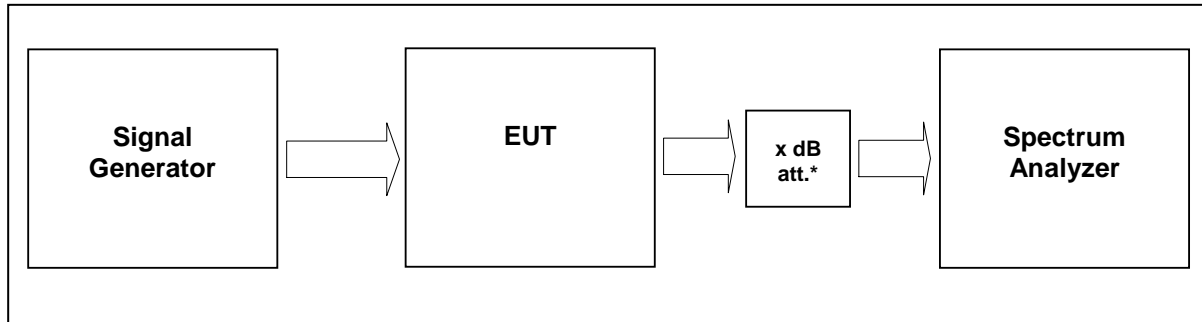

External Attenuator DL x dB = 20 dB  
figure 9-#1 Test setup: Out of Band Rejection

Measurement uncertainty	± 0,38 dB
Test equipment used	9046, 9126, 7406, 7157, 7158, 7289, 7290, 7385

### 9.1 Limit

KDB 935210 D02 v03

Test for rejection of out of band signals. Filter frequency response plots are acceptable.

### 9.2 Test method

935210 D03 v03

7.1 Authorized frequency band verification test

### 9.3 Test results

Detector Peak max hold



### 9.3.1 Downlink

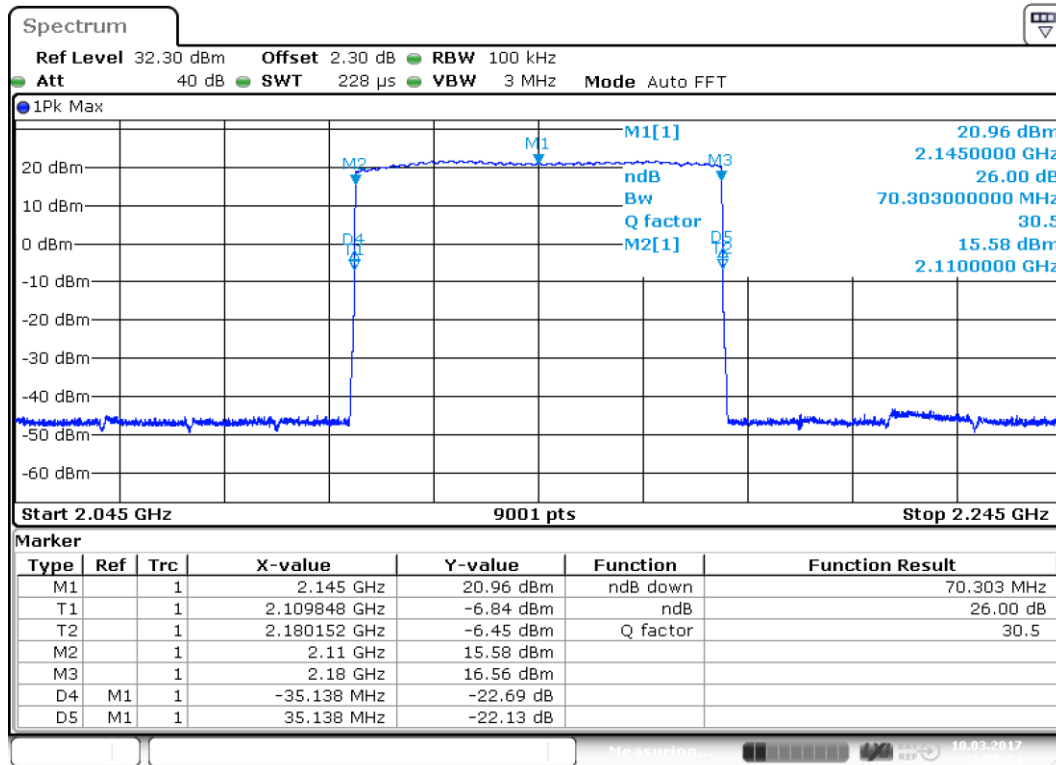

Date: 10.MAR.2017 12:06:53

plot 9.3.1-#1 Out of Band Rejection; Test results; Downlink;

### 9.3.2 Uplink

n.a.

Note: The EUT does not transmit over the air in the uplink direction.

### 9.4 Summary test result

Test result	complies, according the plots above
Tested by:	F. Bengesserr
Date:	10.03.2017

## 10 Field Strength of Spurious Emissions: §27.53, §2.1053

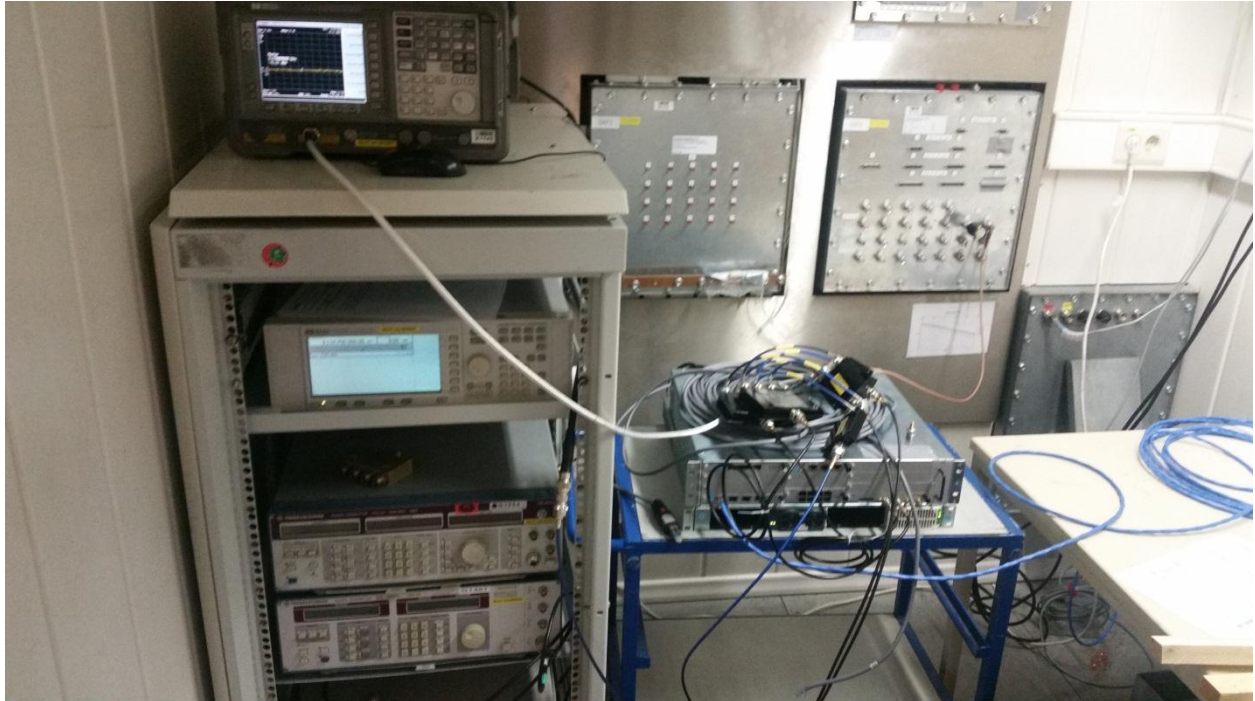

picture 8.1: auxiliary equipment



picture 8.2: Test setup: Field Strength Emission <1 GHz @10m in the SAC



picture 8.3: Test setup: Field Strength Emission 1 - 18 GHz @3m in the SAC



picture 8.4: Test setup: Field Strength Emission 18 - 26,5 GHz @3m in the SAC

**Remark: The worst results were measured during the MIMO configuration (both antenna ports were active) and were reported at chapter 10.4 Test results.**



This clause specifies requirements for the measurement of radiated emission.

Frequency range	Distance: EUT <-> antenna / location	Limit	Test method
30 MHz – 26,5 GHz	3 metres / FAC	FCC 47 CFR Part 27.53 IC RSS-131 sec. 4.4	TIA/EIA-603-C:2004

**Test equipment used:**

Designation	Type	Manufacturer	Invent.-no.	Cal.-date	due Cal.- date	used
EMI test receiver	ESU40	Rohde & Schwarz	E2025	18.10.2016	18.10.2017	X
Antenna	CBL 6111	Chase	K1026	26.05.2017	26.05.2018	X
Antenna	HL 025	R&S	K1114	24.05.2017	24.05.2018	X
Preamplifier	AFS4-00102000	Miteq	K838	10.05.2017	10.05.2018	X
RF Cable	Sucoflex 100	Suhner	K1760	04.08.2015	04.08.2017	X
Antenna	JXTXLB-42-25- C-KF	A-Info	K1175	09.03.2015	09.03.2018	X

The REMI version 2.135 has been used to maximize radiated emission from the EUT with regards to ANSI C63.4:2009.

**Test set-up:**

Test location: FAC  
 Both, the Fully Anechoic Chamber (FAC) and the Semi Anechoic Chamber (SAC) fulfil the requirements of ANSI C63.4 and CISPR 16-1-4 with regards to NSA and SVSWR.

Test Voltage: 110 V / 60 Hz  
 Type of EUT: Wall mounted

**Measurement uncertainty:**

Measurement uncertainty expanded (95% or K=2)	± 4,7 dB for ANSI C63.4 measurement ± 0,5 dB for TIA-603 measurement
--	---

### 10.1 Method of Measurement

**Measurement procedure. TIA-603-C**

The antenna substitution method is used to determine the equivalent radiated power at spurious frequencies. The spurious emissions are measured at a distance of 3 meters. The EUT is then replaced with a reference substitution antenna with a known gain referenced to a dipole. This antenna is fed with a signal at the spurious frequency. The level of the signal is adjusted to repeat the previously measured level. The resulting eirp is the signal level fed to the reference antenna corrected for gain referenced to an isotropic dipole (see Figure 7.2).

From KDB (AMPLIFIER, BOOSTER, AND REPEATER REMINDER SHEET):

Radiated spurs (enclosure) – Use of CW signal (low, mid. and high freq.) is acceptable rather than all modulations.

The maximum RFI field strength was determined during the measurement by rotating the turntable ( $\pm 180$  degrees) and varying the height of the receive antenna ( $h = 1 \dots 4$  m) as like defined in ANSI C63.4. A measurement receiver has been used with a RBW 120 kHz up to 1 GHz and 1 MHz above 1 GHz. Steps with during pre measurement was half the RBW.

Both, the Fully Anechoic Chamber (FAC) and the Semi Anechoic Chamber (SAC) fulfil the requirements of ANSI C63.4 and CISPR 16-1-4 with regards to NSA and SVSWR.

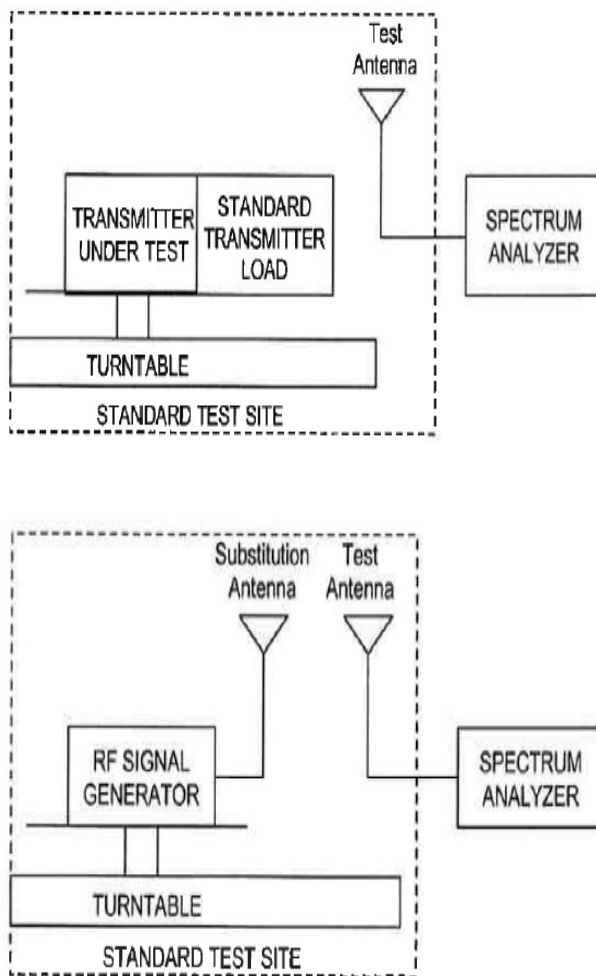

Figure #7.2 Substitution methods TIA/EIA-603-C

## 10.2 Limit §27.53 (h)

Minimum standard:

Para. No.27.53(h)

(h) For operations in the 1710–1755 MHz and 2110–2155 MHz bands, the power of any emission outside a licensee's frequency block shall be attenuated below the transmitter power (P) by at least  $43 + 10 \log_{10}(P)$  dB.

(1) Compliance with this provision is based on the use of measurement instrumentation employing a resolution bandwidth of 1 megahertz or greater. However, in the 1 megahertz bands immediately outside and adjacent to the licensee's frequency block, a resolution bandwidth of at least one percent of the emission bandwidth of the fundamental emission of the transmitter may be employed. The emission bandwidth is defined as the width of the signal between two points, one below the carrier center frequency and one above the carrier center frequency, outside of which all emissions are attenuated at least 26 dB below the transmitter power.

(2) When measuring the emission limits, the nominal carrier frequency shall be adjusted as close to the licensee's frequency block edges, both upper and lower, as the design permits.

(3) The measurements of emission power can be expressed in peak or average values, provided they are expressed in the same parameters as the transmitter power.

The Emission limit is -13dBm.

## 10.3 Climatic values in the lab

Temperature: 21°  
Relative Humidity: 45%  
Air-pressure: 1004 hPa



### 10.4 Test results

#### 10.4.1 30 MHz to 1 GHz Downlink (Bottom – Middle – Top)

B/M/T: 2110.7 MHz / 2145 MHz / 2179.3 MHz (Operation: maximum power and MIMO)

Vertikal

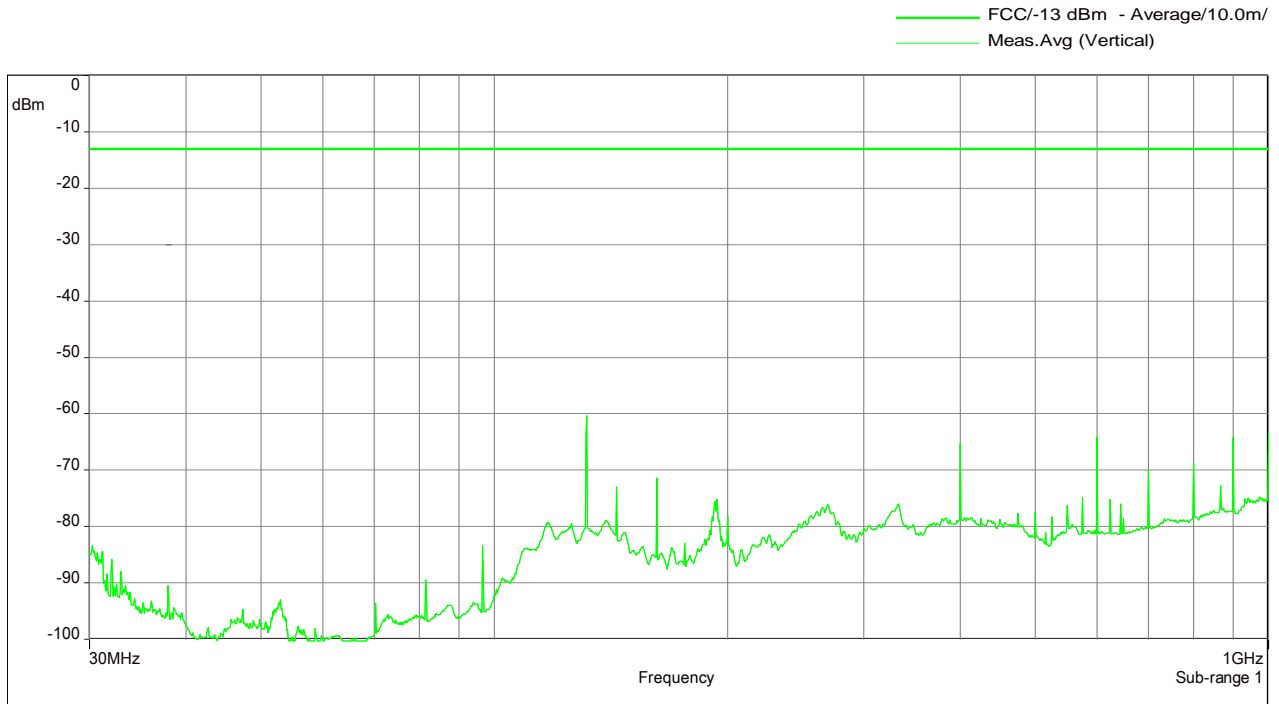

Horizontal

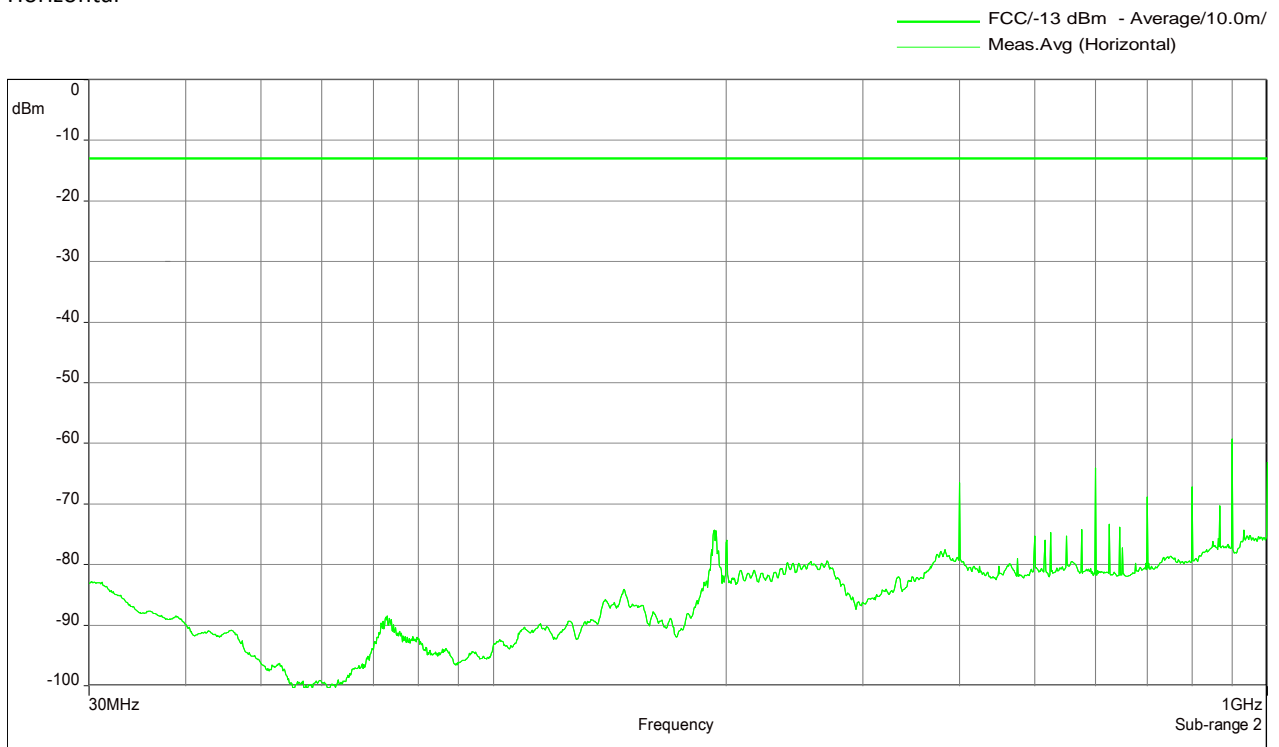

The RF output power is terminated.





### 10.4.2 30 MHz to 1 GHz Downlink (Middle of both paths)

F1: 2145 MHz; F2: 2355 MHz (Operation: maximum power and MIMO)

Vertical

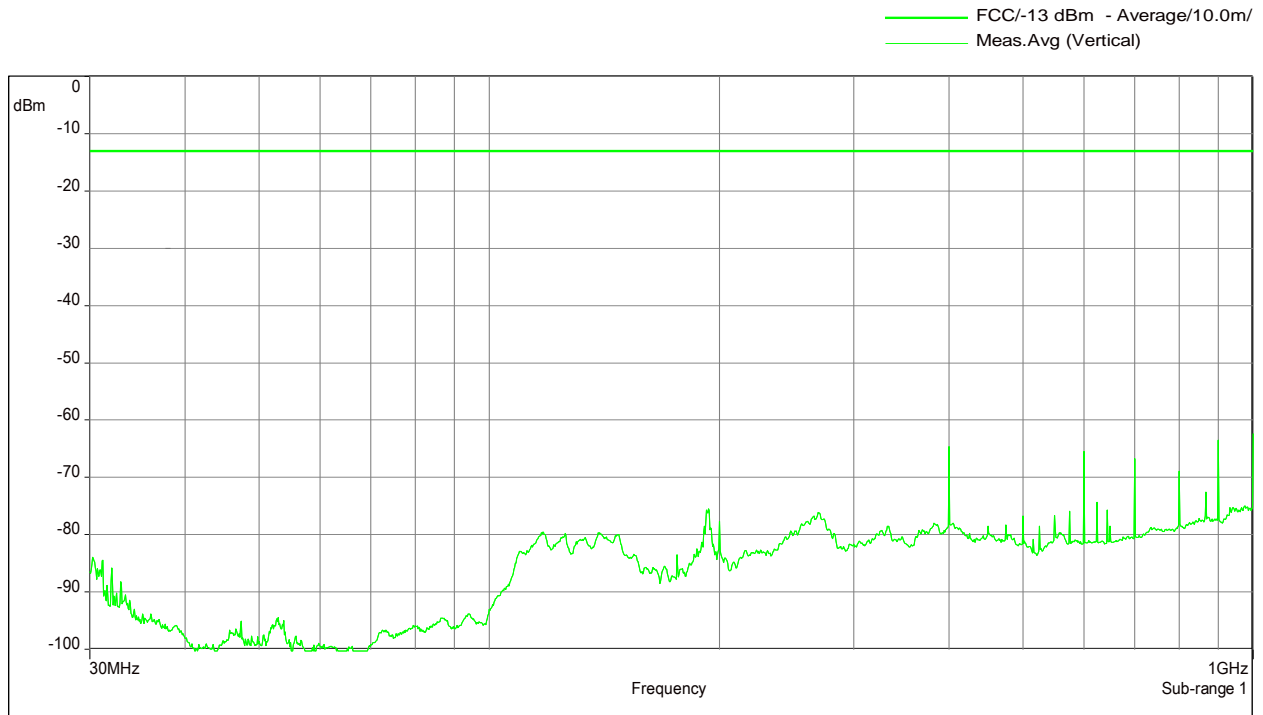

Horizontal

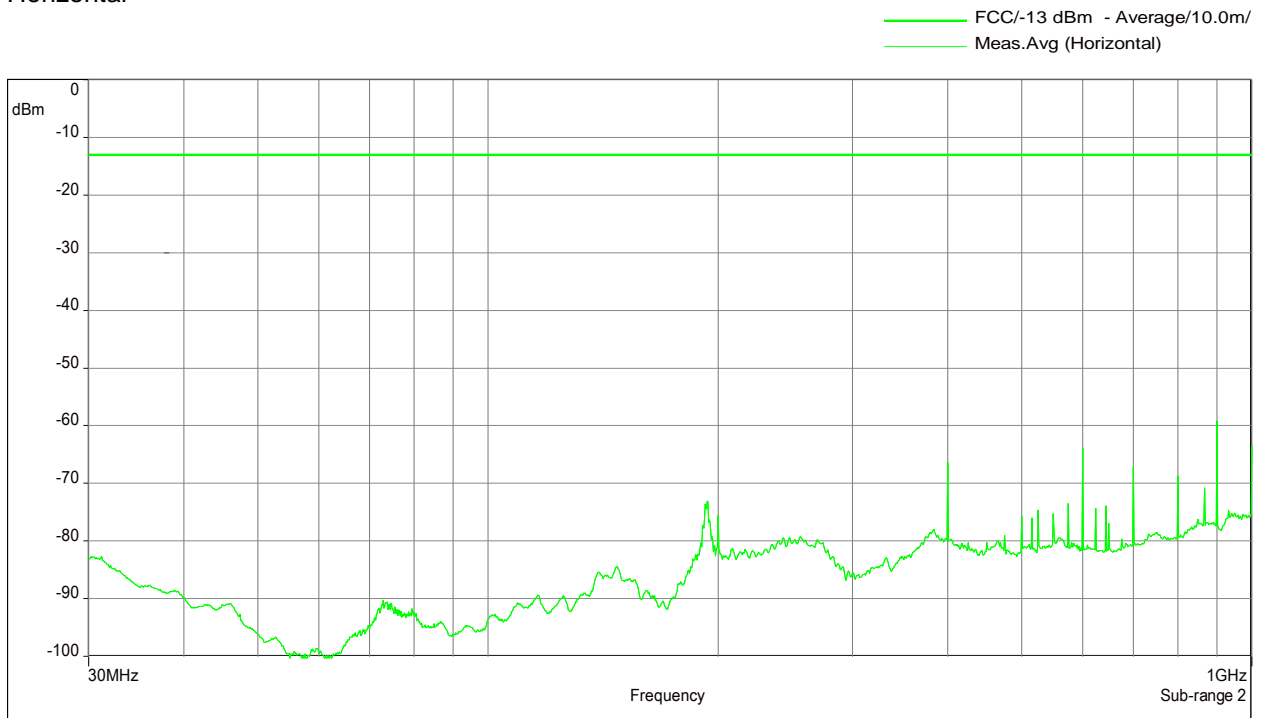

The RF output power is terminated.



### 10.4.3 1 GHz – 18 GHz Downlink (Bottom – Middle – Top)

B/M/T: 2110.7 MHz / 2145 MHz / 2179.3 MHz (Operation: maximum power and MIMO)

Vertikal

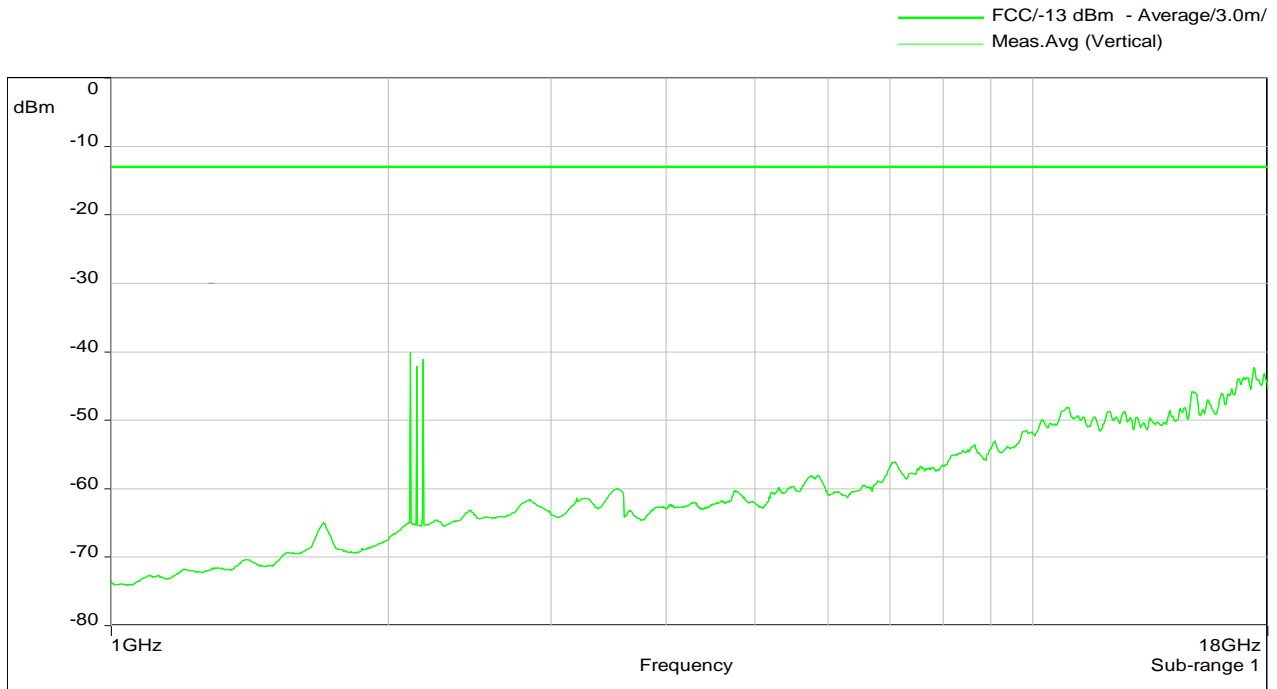

Horizontal

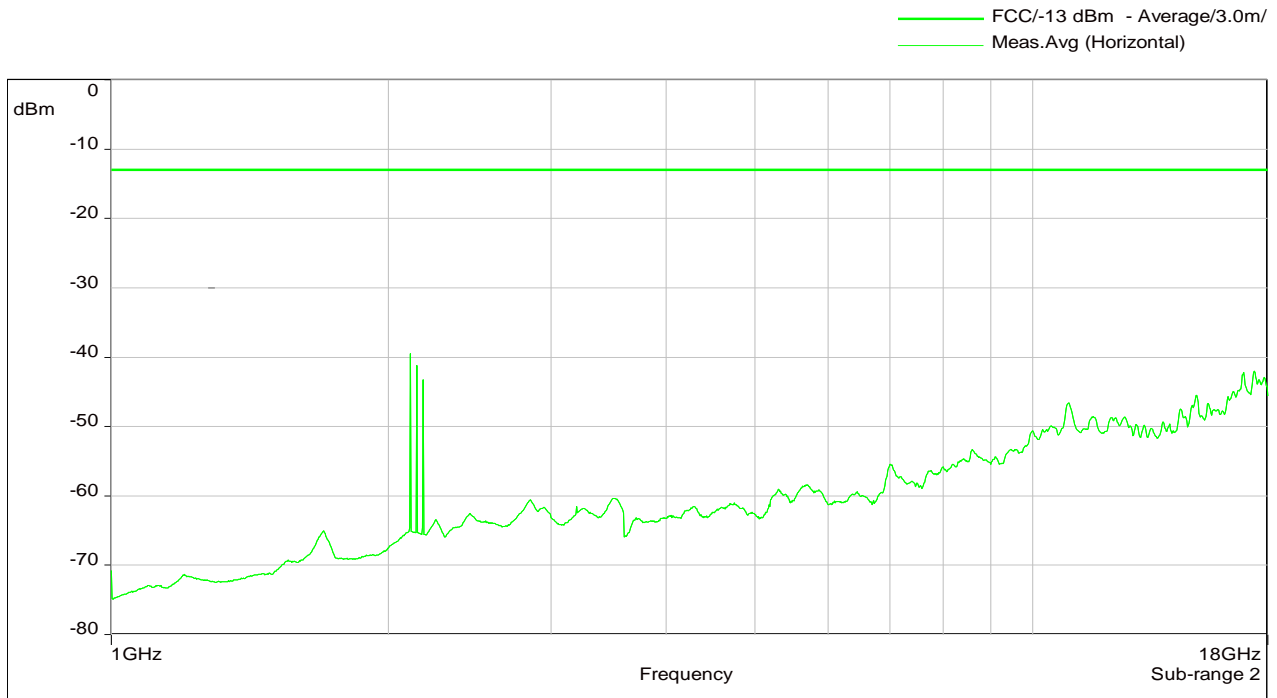

The RF output power is terminated.



### 10.4.4 1 GHz – 18 GHz Downlink (Middle of both paths)

F1: 2145 MHz; F2: 2355 MHz (Operation: maximum power and MIMO)

Vertikal

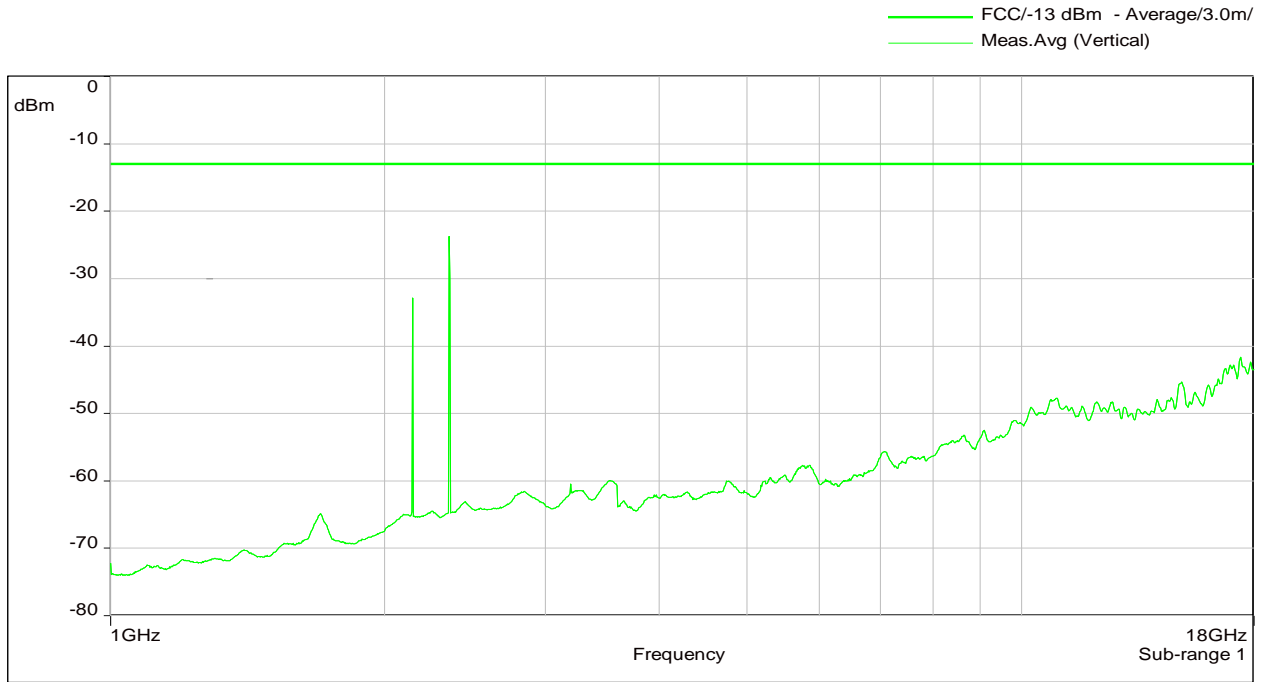

Horizontal

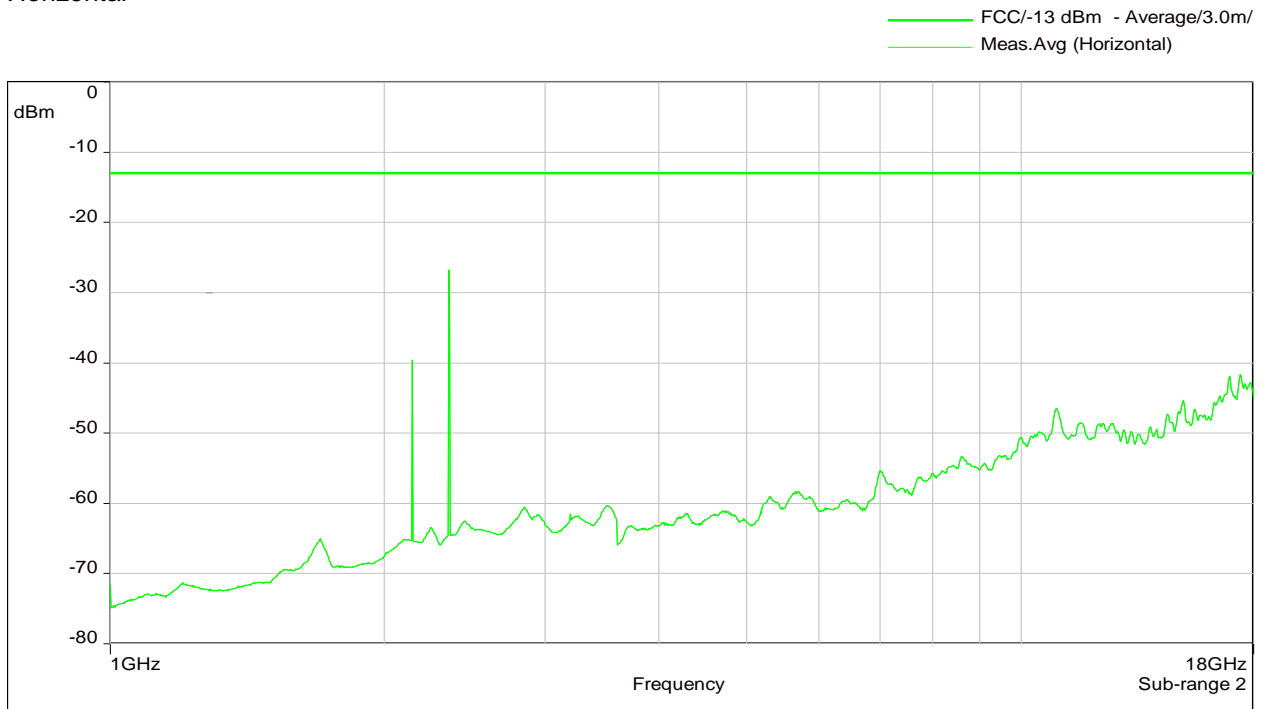

The RF output power is terminated.



### 10.4.5 18 GHz – 26 GHz Downlink (Bottom – Middle – Top)

B/M/T: 2110.7 MHz / 2145 MHz / 2179.3 MHz (Operation: maximum power and MIMO)

Vertikal

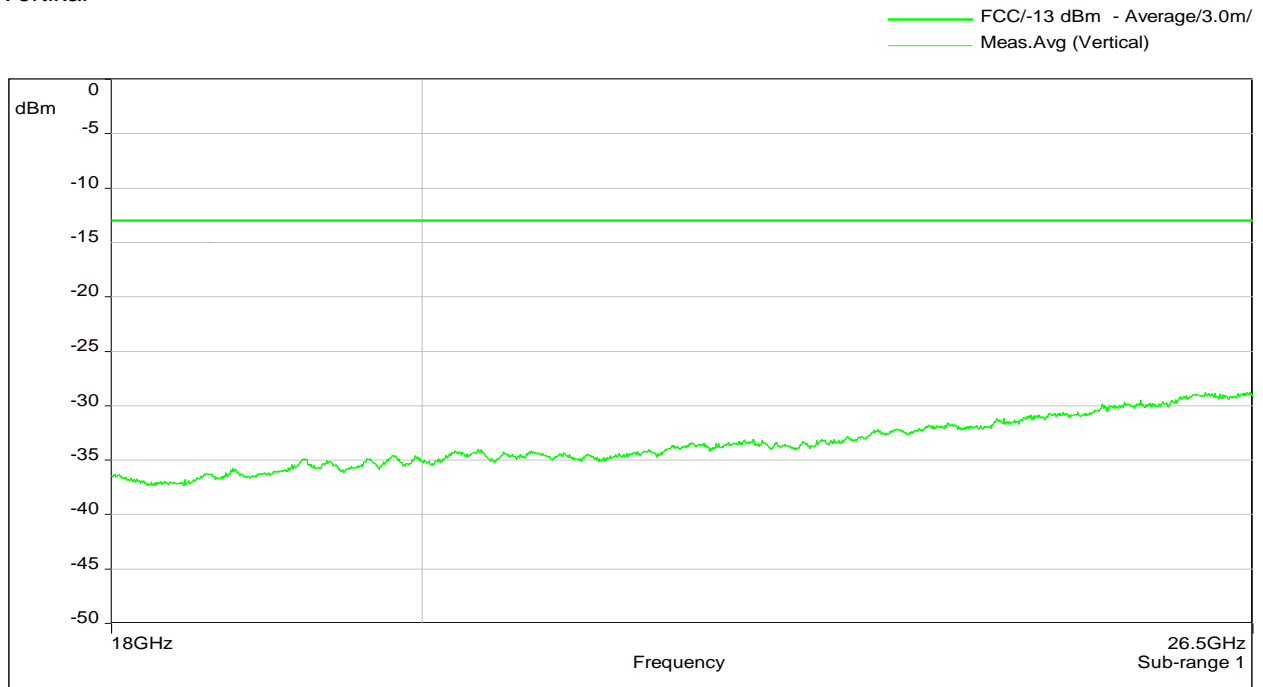

Horizontal

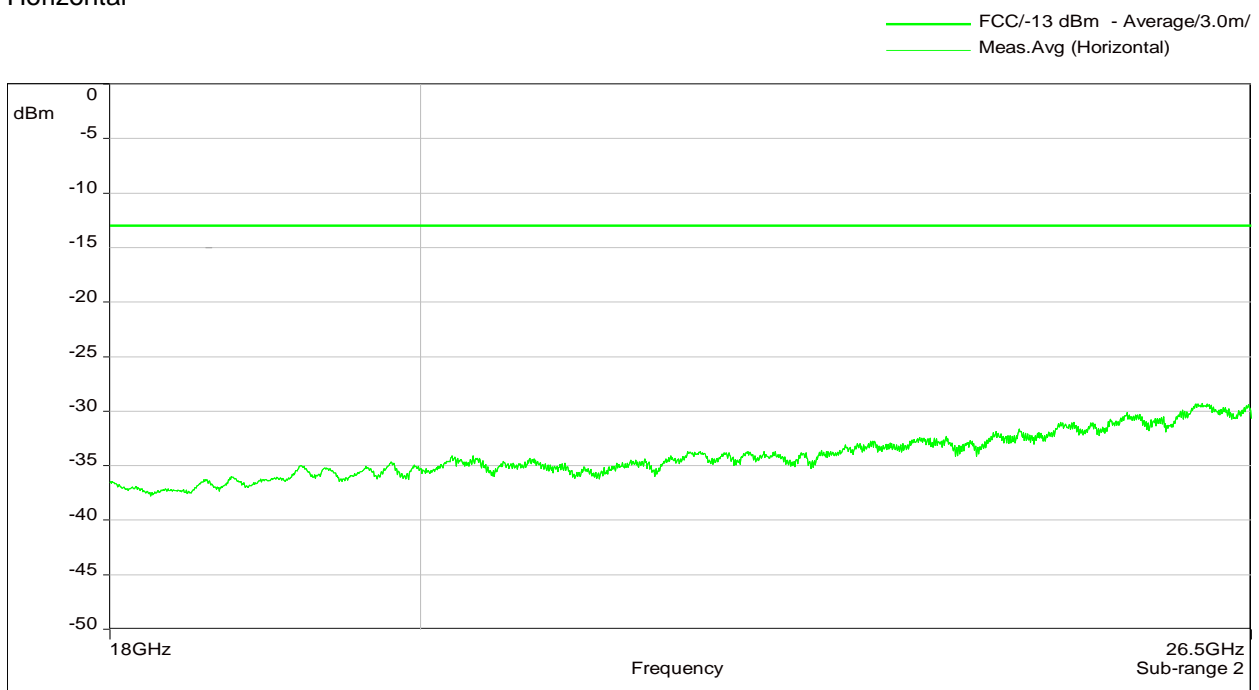

The RF output power is terminated.



### 10.4.6 18 GHz – 26 GHz Downlink (Middle of both paths)

F1: 2145 MHz; F2: 2355 MHz (Operation: maximum power and MIMO)

Vertikal

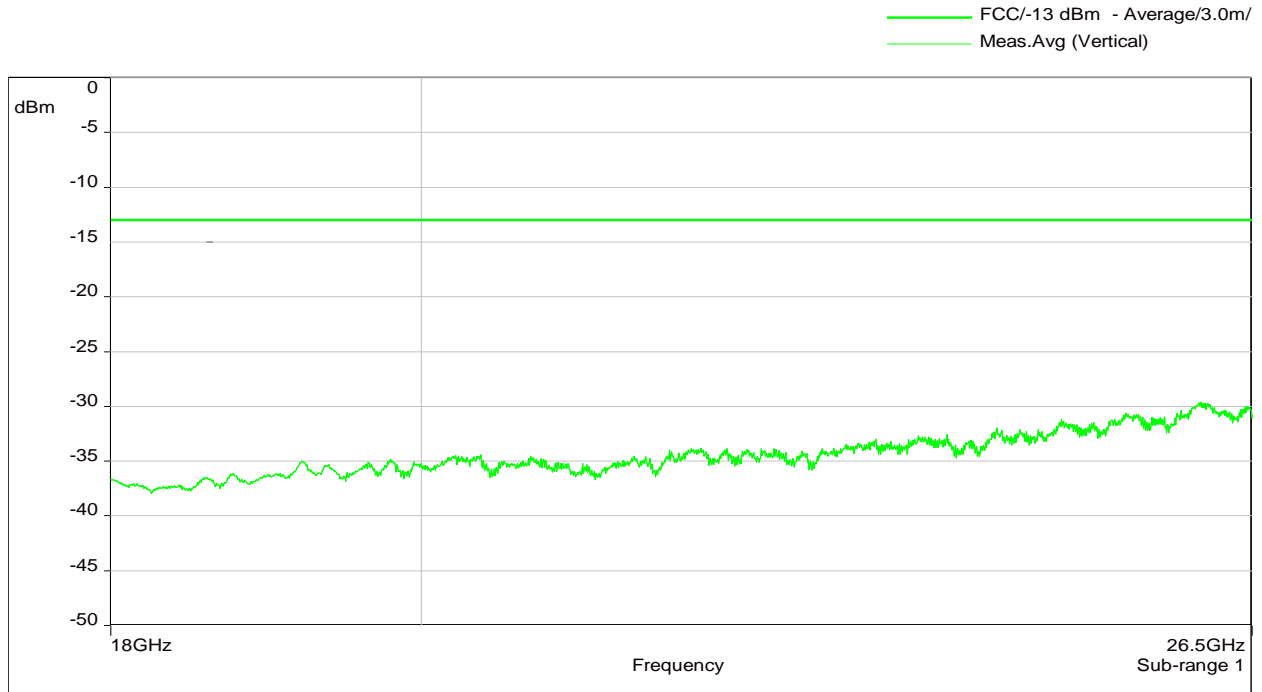

Horizontal

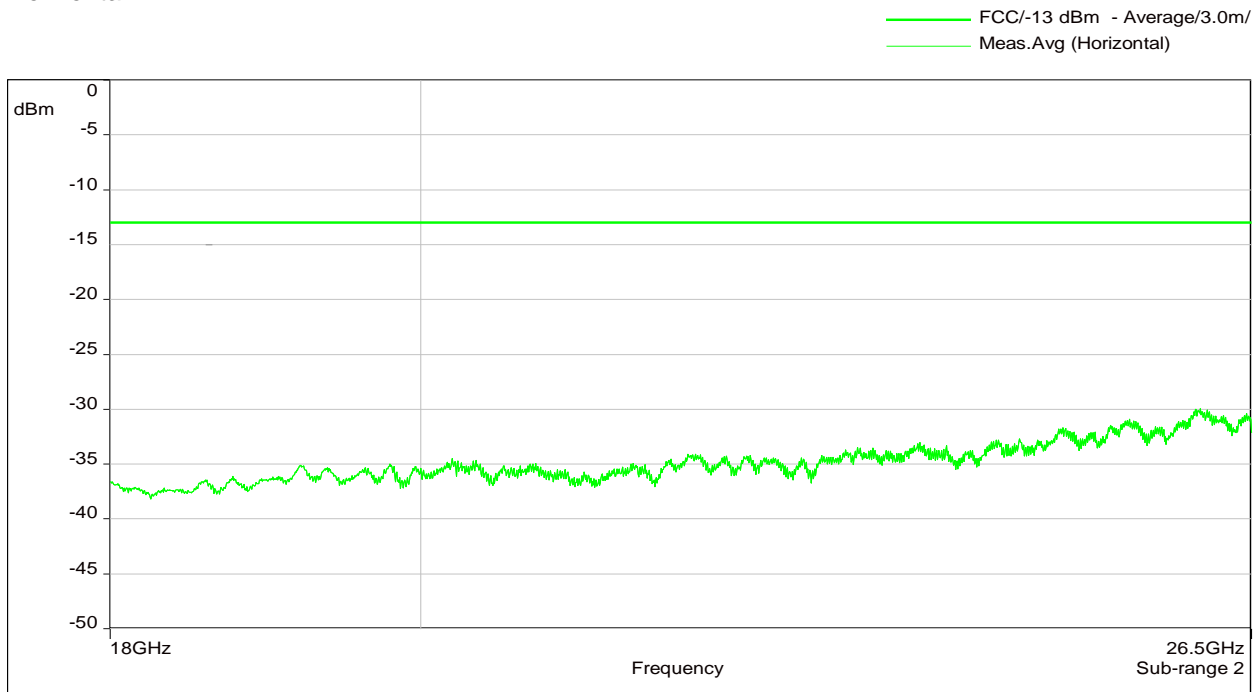

The RF output power is terminated.

Za / 05.05.2017

**The radiated spurious emission measurements have been passed!**



## 11 History

Revision	Modification	Date	Name
01.00	Initial Test report	05.07.2017	Tom Zahlmann
02.00	Name of the EUT an FCC-IC corrected	25.07.2017	Tom Zahlmann

**\*\*\*\*\* End of test report \*\*\*\*\***