



CERTIFICATION TEST REPORT

Report Number. : 11981280-E3V1

Applicant : FITBIT INC.
199 FREMONT ST, 14TH FLOOR
SAN FRANCISCO,
CA 94105, U.S.A

Model : FB505

FCC ID : XRAFB505

IC : 8542A-FB505

EUT Description : SMART WATCH

Test Standard(s) : FCC 47 CFR PART 15 SUBPART C
INDUSTRY CANADA RSS-247 ISSUE 2
INDUSTRY CANADA RSS-GEN ISSUE 4

Date Of Issue:
February 05, 2018

Prepared by:
UL Verification Services Inc.
47173 Benicia Street
Fremont, CA 94538, U.S.A.
TEL: (510) 771-1000
FAX: (510) 661-0888



Revision History

<u>Rev.</u>	<u>Issue Date</u>	<u>Revisions</u>	<u>Revised By</u>
V1	2/5/2018	Initial Issue	--

TABLE OF CONTENTS

1. ATTESTATION OF TEST RESULTS	5
2. TEST METHODOLOGY	7
3. FACILITIES AND ACCREDITATION	7
4. CALIBRATION AND UNCERTAINTY	7
4.1. <i>MEASURING INSTRUMENT CALIBRATION</i>	7
4.2. <i>SAMPLE CALCULATION</i>	7
4.3. <i>MEASUREMENT UNCERTAINTY</i>	8
5. EQUIPMENT UNDER TEST	9
5.1. <i>DESCRIPTION OF EUT</i>	9
5.2. <i>MAXIMUM OUTPUT POWER</i>	9
5.3. <i>DESCRIPTION OF AVAILABLE ANTENNAS</i>	9
5.4. <i>SOFTWARE AND FIRMWARE</i>	9
5.5. <i>WORST-CASE CONFIGURATION AND MODE</i>	10
5.6. <i>DESCRIPTION OF TEST SETUP</i>	11
6. TEST AND MEASUREMENT EQUIPMENT	14
7. MEASUREMENT METHODS	15
8. ANTENNA PORT TEST RESULTS	16
8.1. <i>ON TIME AND DUTY CYCLE</i>	16
8.2. <i>11b MODE IN THE 2.4GHz BAND</i>	17
8.2.1. <i>6 dB BANDWIDTH</i>	17
8.2.2. <i>99% BANDWIDTH</i>	21
8.2.3. <i>OUTPUT POWER</i>	25
8.2.4. <i>POWER SPECTRAL DENSITY</i>	27
8.2.5. <i>CONDUCTED BANDEDGE AND SPURIOUS EMISSIONS</i>	31
8.3. <i>11g MODE IN THE 2.4GHz BAND</i>	37
8.3.1. <i>6 dB BANDWIDTH</i>	37
8.3.2. <i>99% BANDWIDTH</i>	42
8.3.3. <i>OUTPUT POWER</i>	47
8.3.4. <i>POWER SPECTRAL DENSITY</i>	49
8.3.5. <i>CONDUCTED BANDEDGE AND SPURIOUS EMISSIONS</i>	54
8.4. <i>11n HT20 MODE IN THE 2.4GHz BAND</i>	63
8.4.1. <i>6 dB BANDWIDTH</i>	63
8.4.2. <i>99% BANDWIDTH</i>	68
8.4.3. <i>OUTPUT POWER</i>	73
8.4.4. <i>POWER SPECTRAL DENSITY</i>	75
8.4.5. <i>CONDUCTED BANDEDGE AND SPURIOUS EMISSIONS</i>	80

9. RADIATED TEST RESULTS 89

9.1. *LIMITS AND PROCEDURE 89*

9.2. *TRANSMITTER ABOVE 1 GHz 90*

9.2.1. 802.11b MODE IN THE 2.4 GHz BAND..... 90

9.2.2. 802.11g MODE IN THE 2.4 GHz BAND..... 104

9.2.3. 802.11n HT20 MODE IN THE 2.4 GHz BAND..... 122

9.3. *WORST-CASE BELOW 30MHz..... 140*

9.4. *WORST-CASE 30MHz TO 1GHz..... 142*

9.5. *WORST-CASE ABOVE 18GHz..... 144*

10. AC POWER LINE CONDUCTED EMISSIONS 146

10.1. *EUT POWERED BY AC/DC ADAPTER VIA USB CABLE 147*

11. SETUP PHOTOS..... 149

1. ATTESTATION OF TEST RESULTS

COMPANY NAME: FITBIT INC.
199 FREMONT ST, 14TH FLOOR
SAN FRANCISCO,
CA 94105, U.S.A

EUT DESCRIPTION: SMART WATCH

MODEL: FB505

SERIAL NUMBER: B2-H1-213 (RADIATED)
B2-A1-1367P (CONDUCTED)

DATE TESTED: DECEMBER 22, 2017 – FEBRUARY 05, 2018

APPLICABLE STANDARDS	
STANDARD	TEST RESULTS
CFR 47 Part 15 Subpart C	Complies
INDUSTRY CANADA RSS-247 Issue 2	Complies
INDUSTRY CANADA RSS-GEN Issue 4	Complies

UL Verification Services Inc. tested the above equipment in accordance with the requirements set forth in the above standards. All indications of Pass/Fail in this report are opinions expressed by UL Verification Services Inc. based on interpretations and/or observations of test results. Measurement Uncertainties were not taken into account and are published for informational purposes only. The test results show that the equipment tested is capable of demonstrating compliance with the requirements as documented in this report.

Note: The results documented in this report apply only to the tested sample, under the conditions and modes of operation as described herein. This document may not be altered or revised in any way unless done so by UL Verification Services Inc. and all revisions are duly noted in the revisions section. Any alteration of this document not carried out by UL Verification Services Inc. will constitute fraud and shall nullify the document. This report must not be used by the client to claim product certification, approval, or endorsement by NVLAP, NIST, any agency of the Federal Government, or any agency of U.S. government.

Approved & Released For
UL Verification Services Inc. By:



FRANCISCO DE ANDA
OPERATIONS LEAD
UL Verification Services Inc.

Prepared By:



ERIC YU
TEST ENGINEER
UL Verification Services Inc.

Reviewed By:



TINA CHU
SENIOR PROJECT ENGINEER
UL Verification Services Inc.

2. TEST METHODOLOGY

The tests documented in this report were performed in accordance with FCC CFR 47 Part 2, FCC CFR 47 Part 15, KDB 558074 D01 v04, ANSI C63.10-2013, RSS-GEN Issue 4, and RSS-247 Issue 2.

3. FACILITIES AND ACCREDITATION

The test sites and measurement facilities used to collect data are located at 47173 and 47266 Benicia Street, Fremont, California, USA. Line conducted emissions are measured only at the 47173 address. The following table identifies which facilities were utilized for radiated emission measurements documented in this report. Specific facilities are also identified in the test results sections.

47173 Benicia Street	47266 Benicia Street
<input checked="" type="checkbox"/> Chamber A (IC:2324B-1)	<input type="checkbox"/> Chamber D (IC:22541-1)
<input checked="" type="checkbox"/> Chamber B (IC:2324B-2)	<input type="checkbox"/> Chamber E (IC:22541-2)
<input checked="" type="checkbox"/> Chamber C (IC:2324B-3)	<input checked="" type="checkbox"/> Chamber F (IC:22541-3)
	<input type="checkbox"/> Chamber G (IC:22541-4)
	<input type="checkbox"/> Chamber H (IC:22541-5)

The above test sites and facilities are covered under FCC Test Firm Registration # 208313.

UL Verification Services Inc. is accredited by NVLAP, Laboratory Code 200065-0. The full scope of accreditation can be viewed at <http://ts.nist.gov/standards/scopes/2000650.htm>.

4. CALIBRATION AND UNCERTAINTY

4.1. MEASURING INSTRUMENT CALIBRATION

The measuring equipment utilized to perform the tests documented in this report has been calibrated in accordance with the manufacturer's recommendations, and is traceable to recognized national standards.

4.2. SAMPLE CALCULATION

Where relevant, the following sample calculation is provided:

$$\begin{aligned} \text{Field Strength (dBuV/m)} &= \text{Measured Voltage (dBuV)} + \text{Antenna Factor (dB/m)} + \\ &\text{Cable Loss (dB)} - \text{Preamp Gain (dB)} \\ 36.5 \text{ dBuV} + 18.7 \text{ dB/m} + 0.6 \text{ dB} - 26.9 \text{ dB} &= 28.9 \text{ dBuV/m} \end{aligned}$$

4.3. MEASUREMENT UNCERTAINTY

Where relevant, the following measurement uncertainty levels have been estimated for tests performed on the apparatus:

Parameter	Uncertainty
Conducted Disturbance, 9KHz to 0.15 MHz	3.84 dB
Conducted Disturbance, 0.15 to 30 MHz	3.65 dB
Radiated Disturbance, 9KHz to 30 MHz	3.15 dB
Radiated Disturbance, 30 to 1000 MHz	5.36 dB
Radiated Disturbance, 1000 to 18000 MHz	4.32 dB
Radiated Disturbance, 18000 to 26000 MHz	4.45 dB
Radiated Disturbance, 26000 to 40000 MHz	5.24 dB
Occupied Channel Bandwidth	±0.39 %

Uncertainty figures are valid to a confidence level of 95%.

5. EQUIPMENT UNDER TEST

5.1. DESCRIPTION OF EUT

The equipment under test is a Smart Watch.

5.2. MAXIMUM OUTPUT POWER

The transmitter has a maximum average conducted output power as follows:

Frequency Range (MHz)	Mode	Output Power (dBm)	Output Power (mW)
2412-2472	802.11b	17.64	58.08
	802.11g	18.98	79.07
	802.11n HT20	18.90	77.62

5.3. DESCRIPTION OF AVAILABLE ANTENNAS

Frequency Band (GHz)	Antenna Peak Gain (dBi)
2.4	-11.30

5.4. SOFTWARE AND FIRMWARE

The test utility software used during testing was Tera Term Ver 4.93.
The firmware installed in the EUT during testing was Version 32.3.125.8.

5.5. WORST-CASE CONFIGURATION AND MODE

EUT has 1 type of plastic wristband and 3 types of metallic bands: Mesh, Link and Tri-Link. The worst-case configuration was investigated with wristbands with and without a charger and it was determined that EUT with plastic wristband and with a charger was the worst-case; therefore, all final radiated testing was performed with this configuration.

Radiated bandedge were performed with EUT set to transmit at the channels output power.

Radiated harmonics and spurious emissions from 1 GHz to 18GHz were performed with EUT set to transmit at the Low/Middle/High channel with highest output power.

Radiated emission below 1GHz, above 18GHz, and power line conducted emission were performed with the EUT set to transmit at the channel with highest output power as worst-case scenario.

The fundamental of the EUT was investigated in three orthogonal orientations X/Y/Z, it was determined that Z-Portrait orientation was worst-case orientation. Therefore, all final radiated testing was performed with the EUT in Z-Portrait orientation.

Worst-case data rates as provided by the client were:

802.11b mode: 1 Mbps
802.11g mode: 6 Mbps
802.11n HT20 mode: MCS0

BT and Wifi bands do not transmit simultaneously.

5.6. DESCRIPTION OF TEST SETUP

SUPPORT EQUIPMENT

Support Equipment List				
Description	Manufacturer	Model	Serial Number	FCC ID
Laptop AC/DC Adapter	Lenovo	ADLX45DLCC2A	11S36200283ZZ10051KU2U	NA
Laptop	Lenovo	ThinkPad X1 Carbon	R9-OG4NPM 15/06	NA
AC/DC Adapter	Homespot	S005AYU0500100	N/A	NA

I/O CABLES (CONDUCTED TEST)

I/O Cable List						
Cable No	Port	# of identical ports	Connector Type	Cable Type	Cable Length (m)	Remarks
1	AC	1	AC	Unshielded	1	AC Mains to AC/DC Adapter
2	DC	1	DC	Unshielded	1.5	AC/DC Adapter to Laptop
3	USB	1	USB	Unshielded	1	Laptop to EUT
4	Antenna	1	SMA	Unshielded	0.2	To spectrum analyzer

I/O CABLES (AC POWER CONDUCTED TEST AND RADIATED TEST)

I/O Cable List						
Cable No	Port	# of identical ports	Connector Type	Cable Type	Cable Length (m)	Remarks
1	USB	1	USB	Unshielded	1	Charger to AC/DC adapter

TEST SETUP-CONDUCTED TEST

The EUT was placed in charger and powered by host laptop. Test software exercised the EUT.

SETUP DIAGRAM

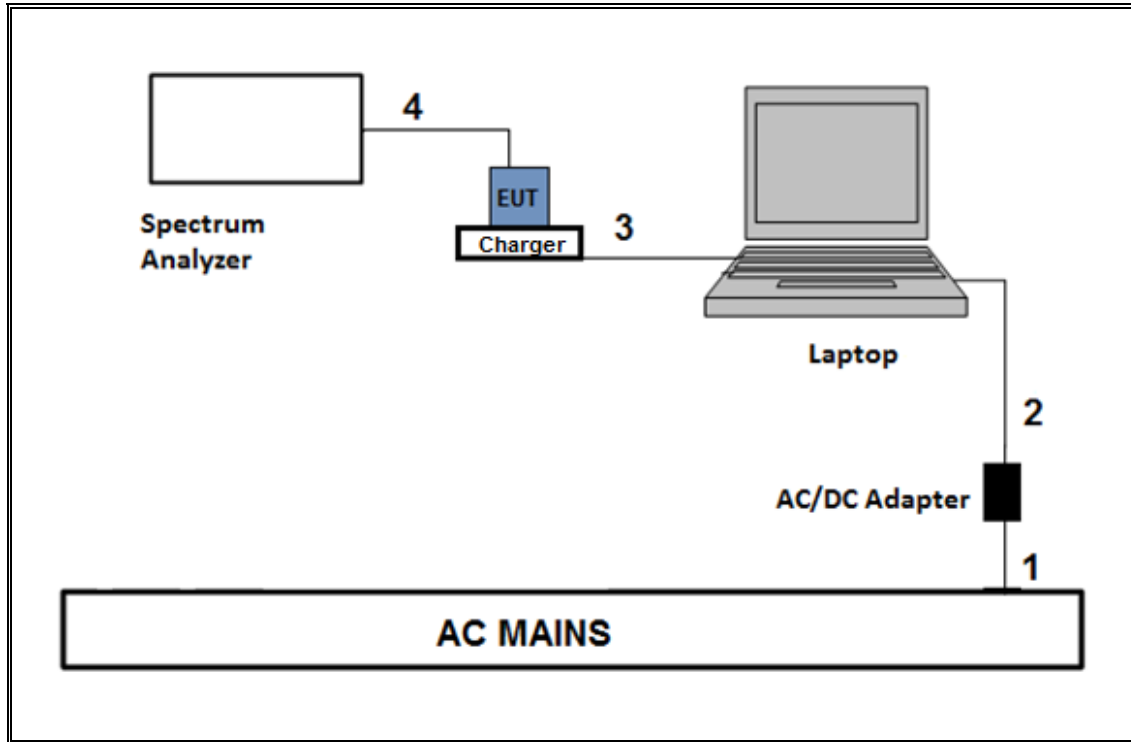

TEST SETUP- AC LINE CONDUCTED TEST AND RADIATED TEST

The EUT was placed in charger and powered by an AC/DC adapter. Test software exercised the EUT.

SETUP DIAGRAM

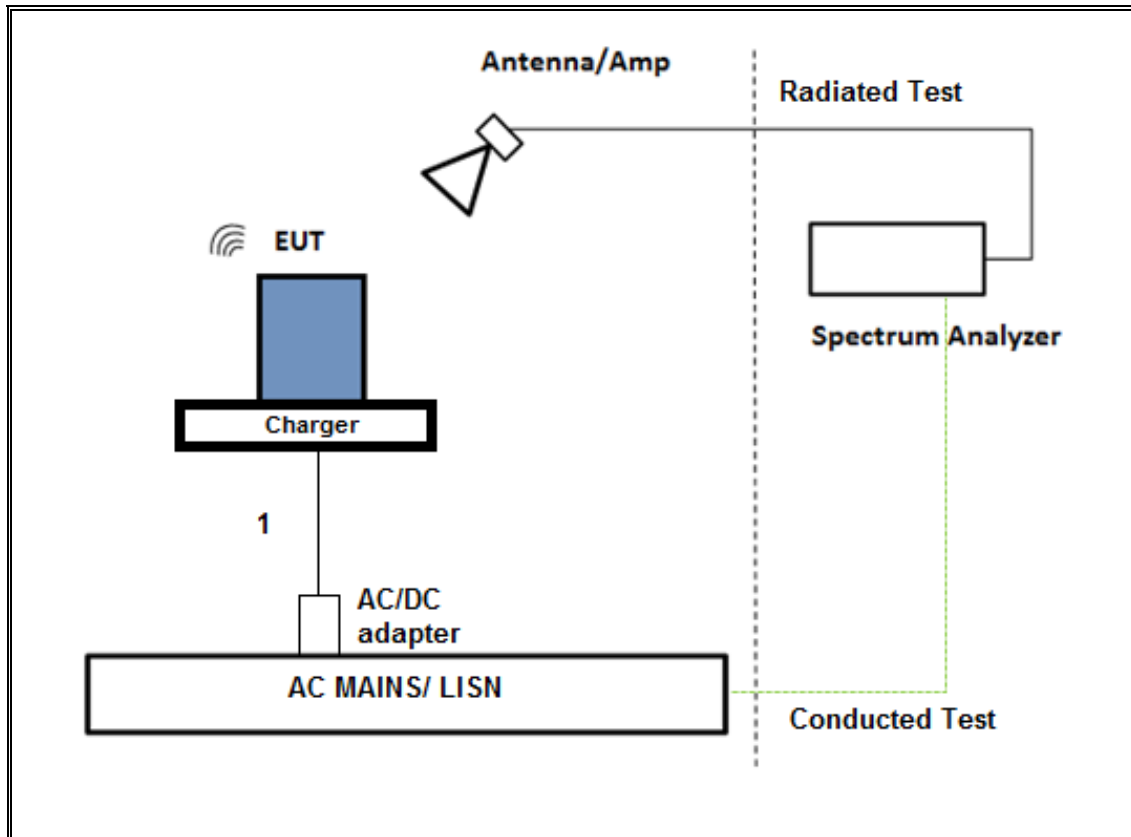

6. TEST AND MEASUREMENT EQUIPMENT

The following test and measurement equipment was utilized for the tests documented in this report:

TEST EQUIPMENT LIST				
Description	Manufacturer	Model	Asset	Cal Due
Antenna, Horn 1-18GHz	ETS Lindgren	3117	T862	06/09/2018
Amplifier, 1 to 18GHz	Miteq	AFS42-00101800-25-S-42	T1165	11/25/2018
Antenna, Active Loop 9KHz to 30MHz	EMCO	6502	T35	3/09/2018
Amplifier, 10KHz to 1GHz, 32dB	SONOMA INSTRUMENT	310N	T300	12/11/2018
Spectrum Analyzer, PXA 3Hz to 44GHz	Keysight	N9030A	T1466	04/11/2018
Antenna, Horn 1-18GHz	ETS Lindgren	3117	T863	06/09/2018
Amplifier, 1 to 18GHz	Miteq	AFS42-00101800-25-S-42	T493	12/16/2018
Spectrum Analyzer, PXA 3Hz to 44GHz	Keysight	N9030A	T907	01/23/2018
Antenna, Broadband Hybrid, 30MHz to 2000MHz	Sunol Sciences	JB1	T243	11/02/2018
Amplifier, 30kHz-1000MHz	Keysight	8447D	T15	08/14/2018
Spectrum Analyzer, PXA, 3Hz to 44GHz	Keysight	N9030A	T905	1/11/2018
Antenna, Horn 1-18GHz	ETS-Lindgren	3117	T119	03/28/2018
Amplifier, 1 - 18GHz	Miteq	AFS42-00101800-25-S-42	T742	12/04/2018
Spectrum Analyzer, PXA, 3Hz to 44GHz	Keysight	N9030A	T340	12/15/2018
Spectrum Analyzer, PSA, 3Hz to 44GHz	Keysight	E4446A	T146	07/18/2018
Antenna Horn, 18 to 26GHz	ARA	MWH-1826	T89	01/04/2018
Amplifier, 1 to 26.5GHz 23.5dB gain Minimum	Keysight	8449B	T404	07/23/2018
Spectrum Analyzer, PXA, 3Hz to 44GHz	Keysight	N9030A-544	T1113	12/21/2018
Power Meter, P-series single channel	Keysight	N1912A	T1245	05/12/2018
Power Sensor	Keysight	N1921A	T413	06/22/2018
AC Line Conducted				
EMI Test Receiver 9KHz-7GHz	Rohde & Schwarz	ESC17	T1124	11/07/2018
LISN for Conducted Emissions CISPR-16	Fischer	50/250-25-2-01	T1310	06/15/2018
Power Cable, Line Conducted Emissions	UL	PG1	T861	08/31/2018
UL AUTOMATION SOFTWARE				
Radiated Software	UL	UL EMC	Ver 9.5, Dec 01, 2016	
Conducted Software	UL	UL EMC	Ver 7.7, Dec 14, 2017	
AC Line Conducted Software	UL	UL EMC	Ver 9.5, May 26, 2015	

NOTES:

1. Equipment listed above that calibrated during the testing period was set for test after the calibration.
2. Equipment listed above that has a calibration due date during the testing period, the testing is completed before equipment expiration date.

7. MEASUREMENT METHODS

On Time and Duty Cycle: KDB 558074 D01 v04, Section 6.

6 dB BW: KDB 558074 D01 v04, Section 8.1.

99% BW: ANSI C63.10-2013, Section 6.9.3.

Output Power: KDB 558074 D01 v04, Section 9.2.3.2.

Power Spectral Density: KDB 558074 D01 v04, Section 10.3.

Out-of-band emissions in non-restricted bands: KDB 558074 D01 v04, Section 11.0.

Out-of-band emissions in restricted bands: KDB 558074 D01 v04, Section 12.1.

Band-edge: KDB 558074 D01 v04, Section 12.1.

AC Power-line conducted emissions: ANSI C63.10-2013, Section 6.2.

8. ANTENNA PORT TEST RESULTS

8.1. ON TIME AND DUTY CYCLE

LIMITS

None; for reporting purposes only.

ON TIME AND DUTY CYCLE RESULTS

Mode	ON Time B (msec)	Period (msec)	Duty Cycle x (linear)	Duty Cycle (%)	Duty Cycle Correction Factor (dB)	1/B Minimum VBW (kHz)
802.11b	1.913	1.948	0.982	98.20%	0.00	0.010
802.11g	1.913	1.942	0.985	98.51%	0.00	0.010
802.11n HT20	1.913	1.942	0.985	98.51%	0.00	0.010

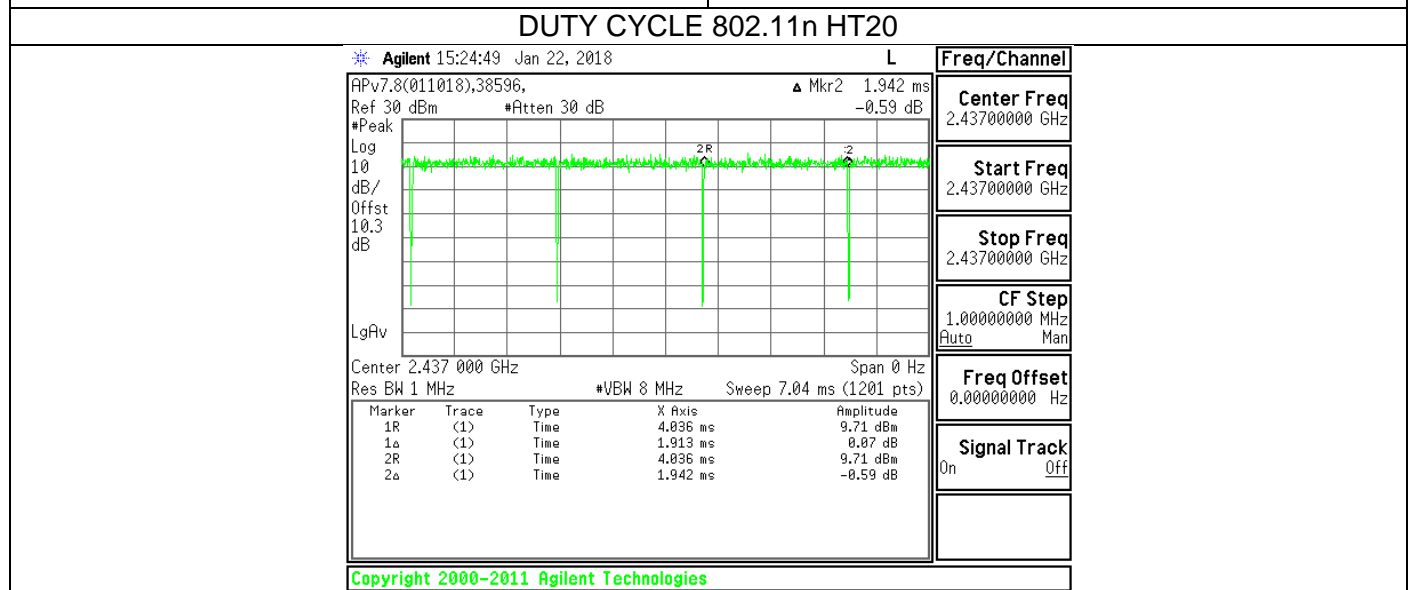
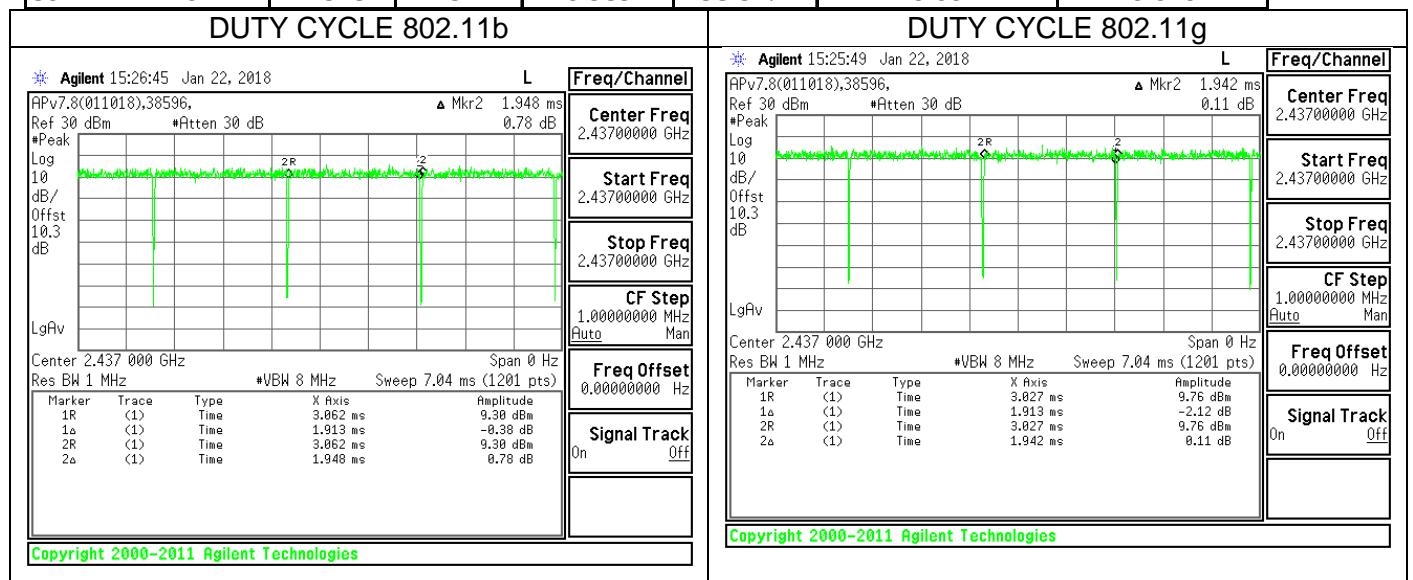

8.2. 11b MODE IN THE 2.4GHz BAND

8.2.1. 6 dB BANDWIDTH

LIMITS

FCC §15.247 (a) (2)

IC RSS-247 (5.2) (a)

The minimum 6 dB bandwidth shall be at least 500 kHz.

RESULTS

Channel	Frequency (MHz)	6 dB BW (MHz)	Minimum Limit (MHz)
CH1	2412	8.52	0.5
CH6	2437	9.04	0.5
CH11	2462	9.08	0.5
CH12	2467	9.56	0.5
CH13	2472	9.56	0.5

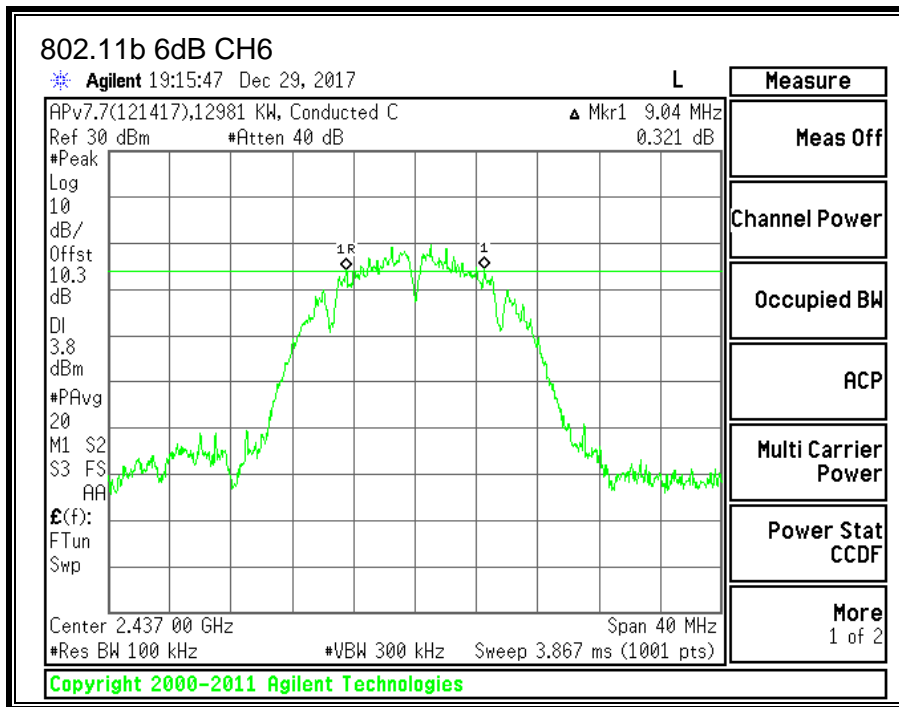
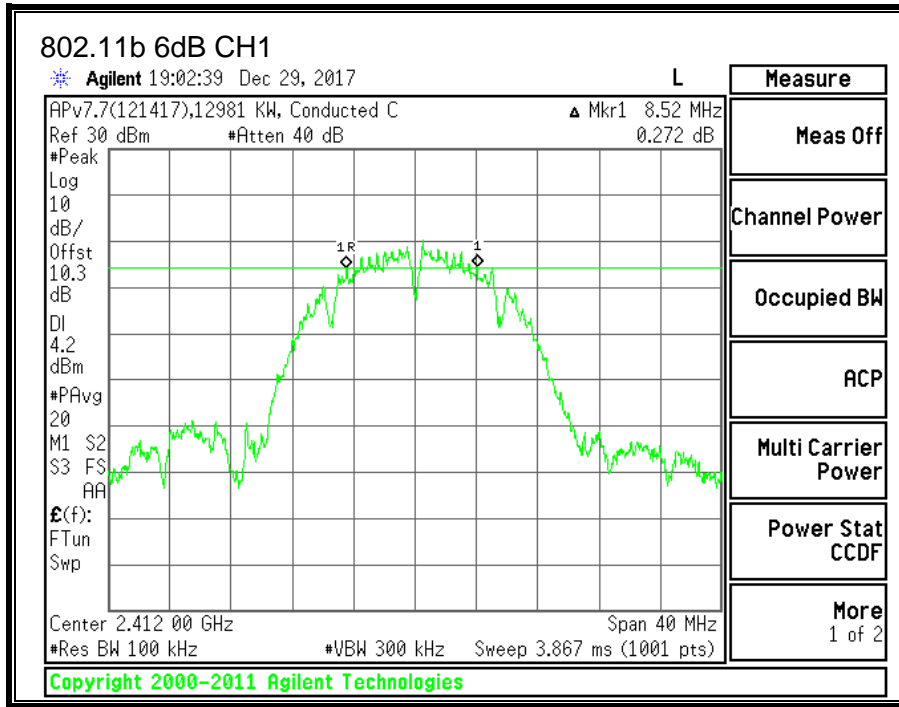

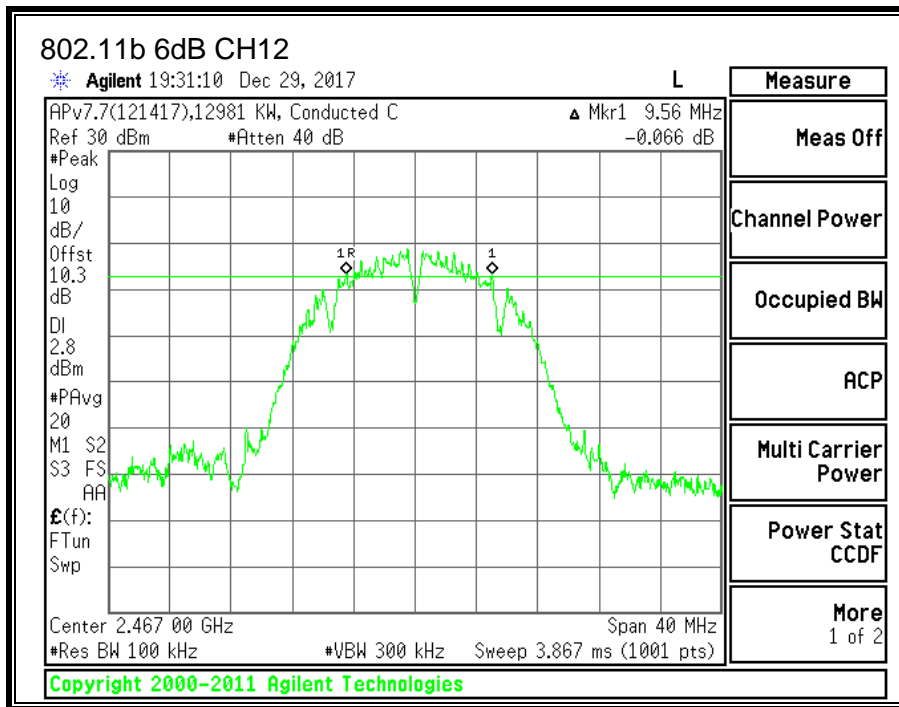
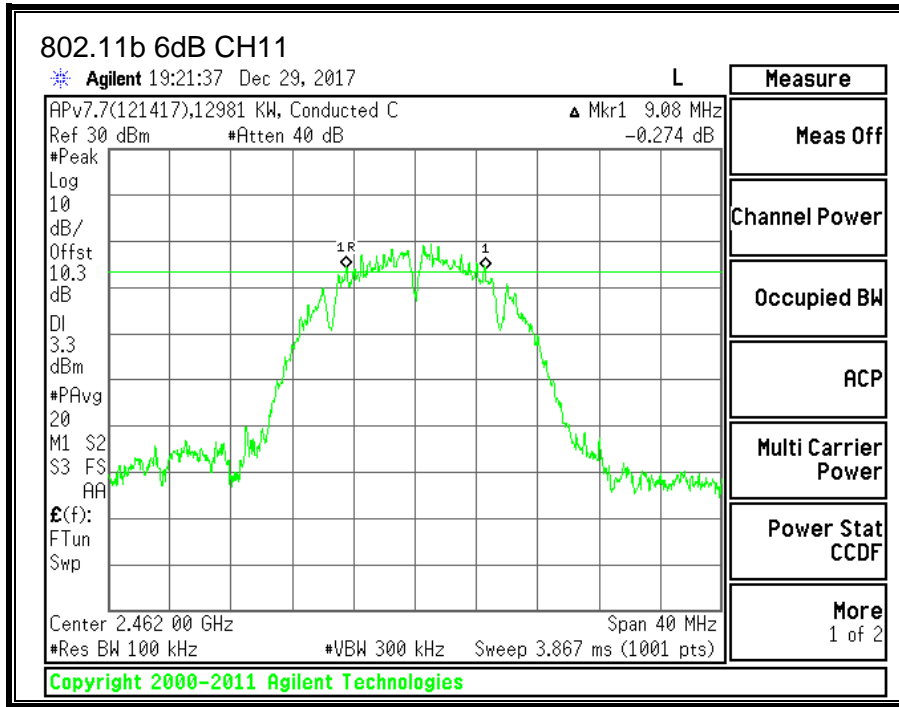

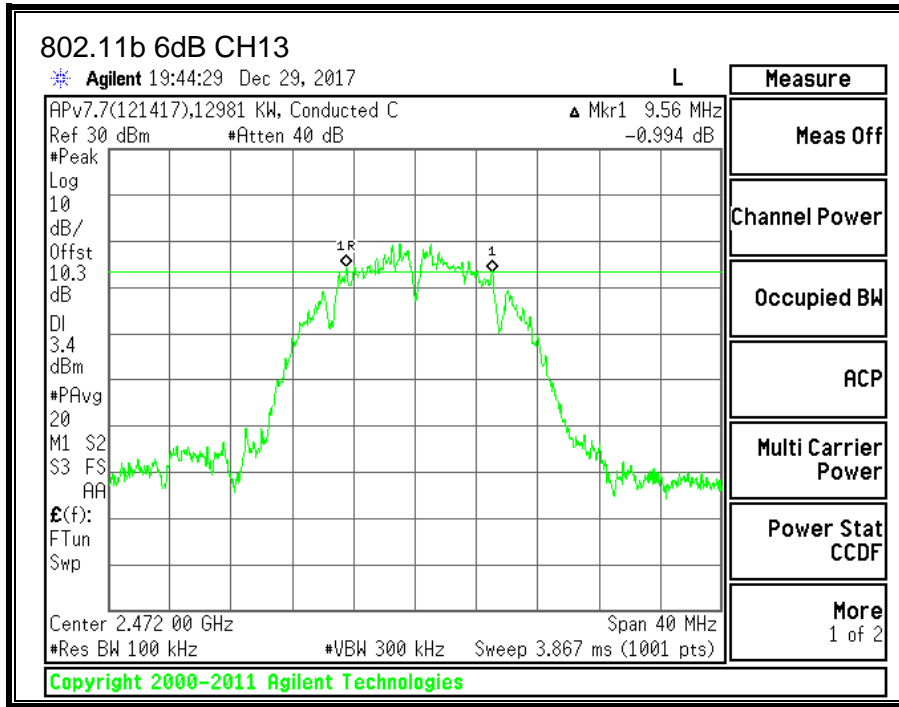

8.2.2. 99% BANDWIDTH

LIMITS

None; for reporting purposes only.

RESULTS

Channel	Frequency (MHz)	99% Bandwidth (MHz)
CH1	2412	14.3398
CH6	2437	14.3480
CH11	2462	14.1091
CH12	2467	13.9928
CH13	2472	14.4833

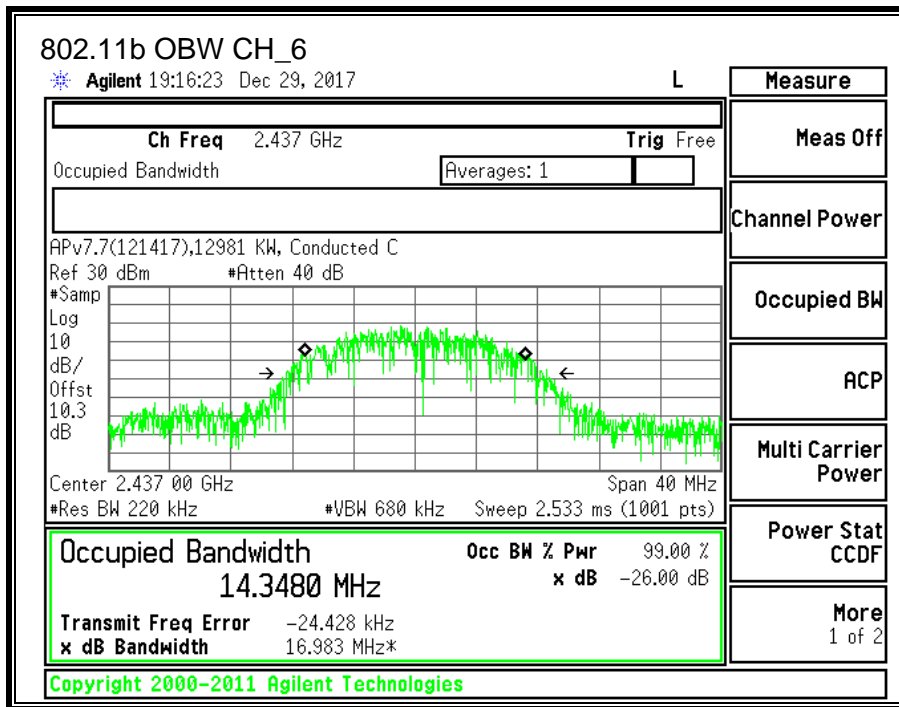
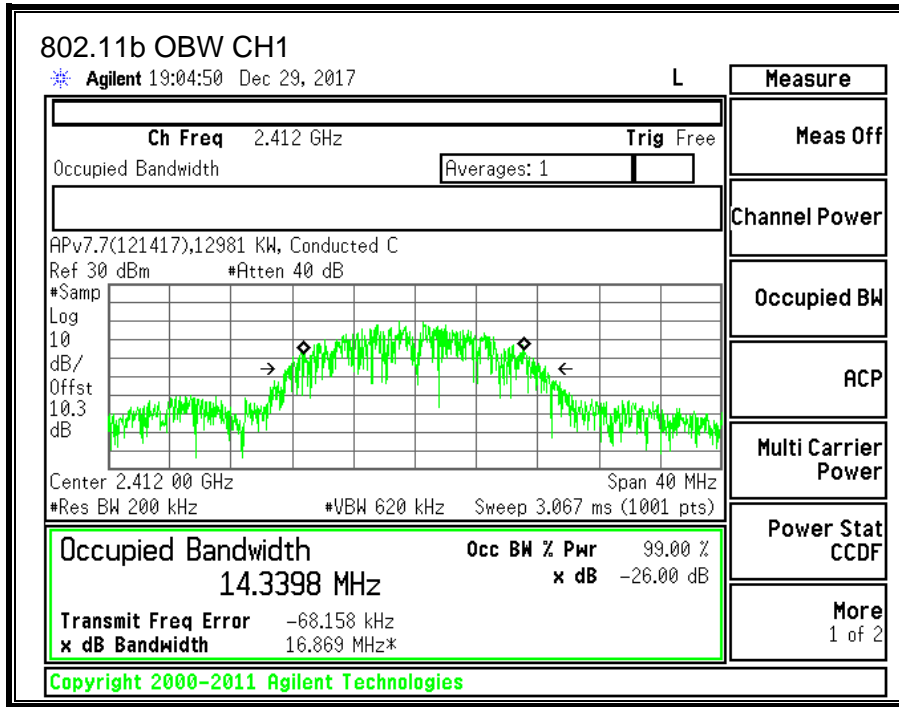

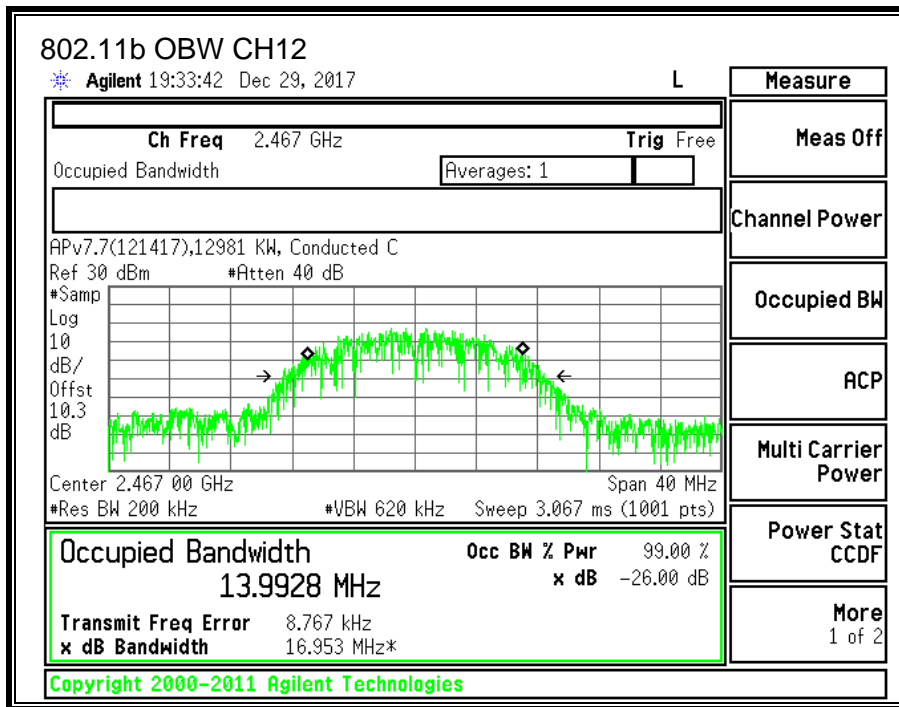
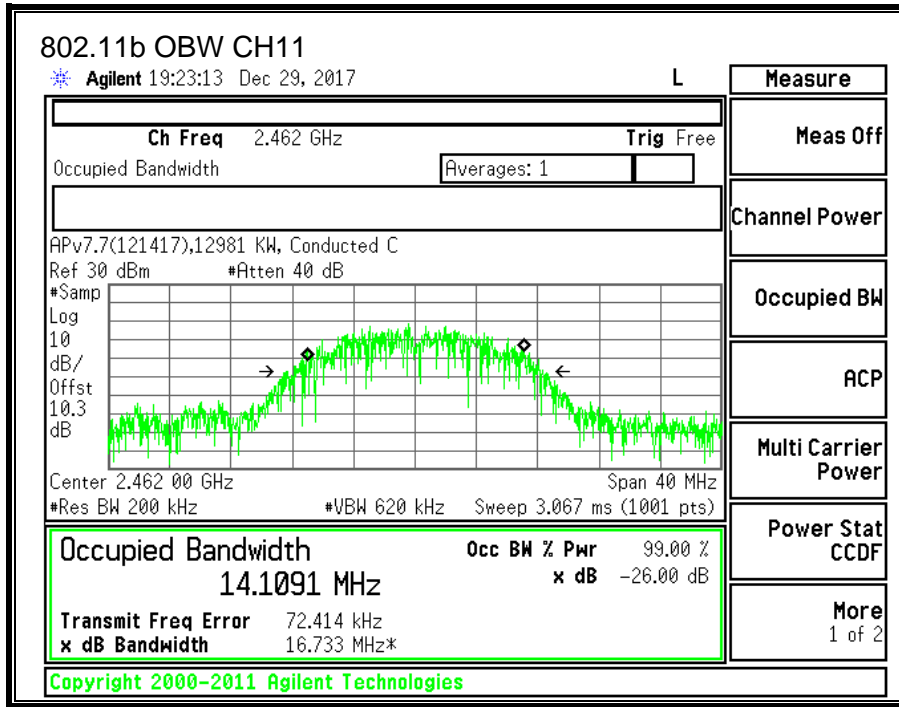

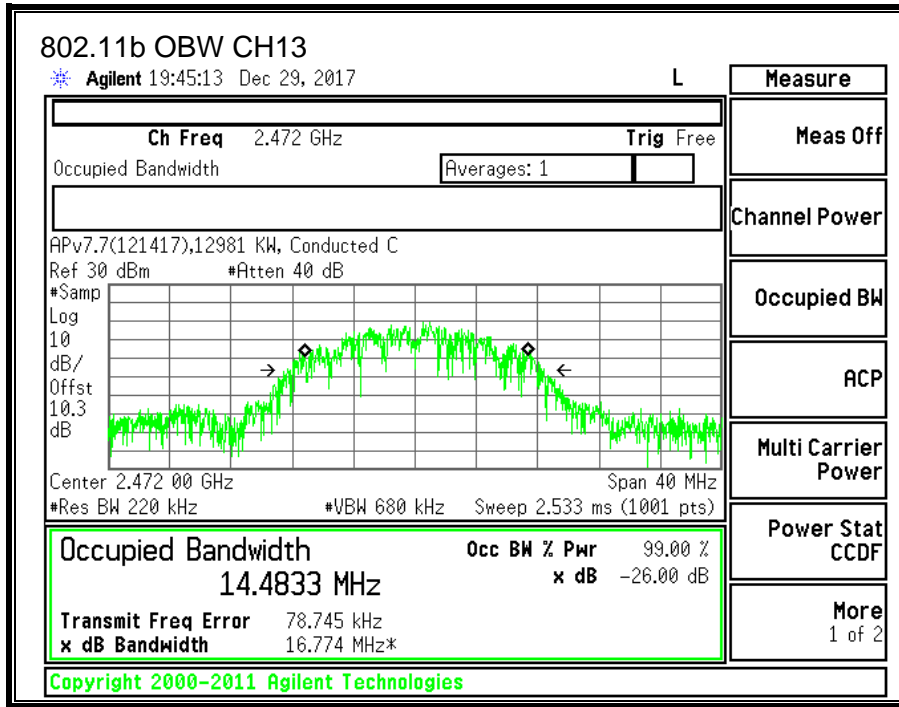

8.2.3. OUTPUT POWER

LIMITS

FCC §15.247

IC RSS-247 (5.4) (d)

The maximum antenna gain is less than or equal to 6 dBi, therefore the limit is 30 dBm.

DIRECTIONAL ANTENNA GAIN

There is only one transmitter output therefore the directional gain is equal to the antenna gain.

RESULTS

ID:	10629	Date:	02/01/18
------------	-------	--------------	----------

Limits

Channel	Frequency (MHz)	Directional Gain (dBi)	FCC Power Limit (dBm)	IC Power Limit (dBm)	IC EIRP Limit (dBm)	Max Power (dBm)
CH1	2412	-11.30	30.00	30	36	30.00
CH6	2437	-11.30	30.00	30	36	30.00
CH11	2462	-11.30	30.00	30	36	30.00
CH12	2467	-11.30	30.00	30	36	30.00
CH13	2472	-11.30	30.00	30	36	30.00

Results

Channel	Frequency (MHz)	Measured Power (dBm)	Power Limit (dBm)	Margin (dB)
CH1	2412	17.64	30.00	-12.36
CH6	2437	17.64	30.00	-12.36
CH11	2462	17.5	30.00	-12.50
CH12	2467	17.51	30.00	-12.49
CH13	2472	13.47	30.00	-16.53

8.2.4. POWER SPECTRAL DENSITY

LIMITS

FCC §15.247

IC RSS-247 (5.2) (b)

The power spectral density conducted from the transmitter to the antenna shall not be greater than 8 dBm in any 3 kHz band during any time interval of continuous transmission.

RESULTS

Duty Cycle CF (dB)	0.00	Included in Calculations of Corr'd PSD
---------------------------	------	---

PSD Results

Channel	Frequency (MHz)	Measured (dBm)	Corr'd PSD (dBm)	Limit (dBm)	Margin (dB)
CH1	2412	-4.062	-4.062	8.0	-12.06
CH6	2437	-4.070	-4.070	8.0	-12.07
CH11	2462	-4.184	-4.184	8.0	-12.18
CH12	2467	-3.916	-3.916	8.0	-11.92
CH13	2472	-7.822	-7.822	8.0	-15.82

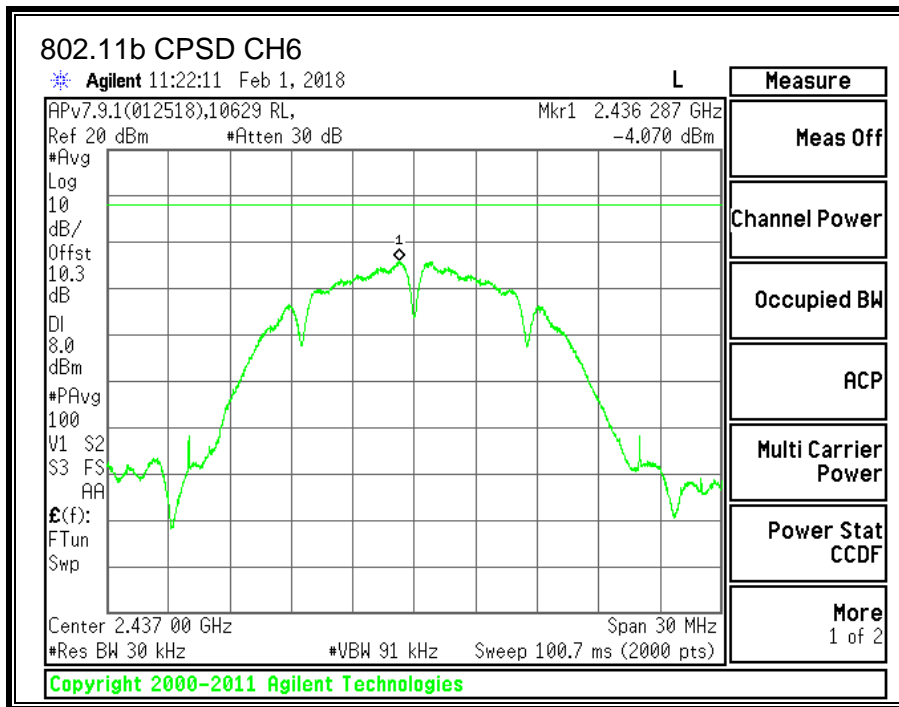
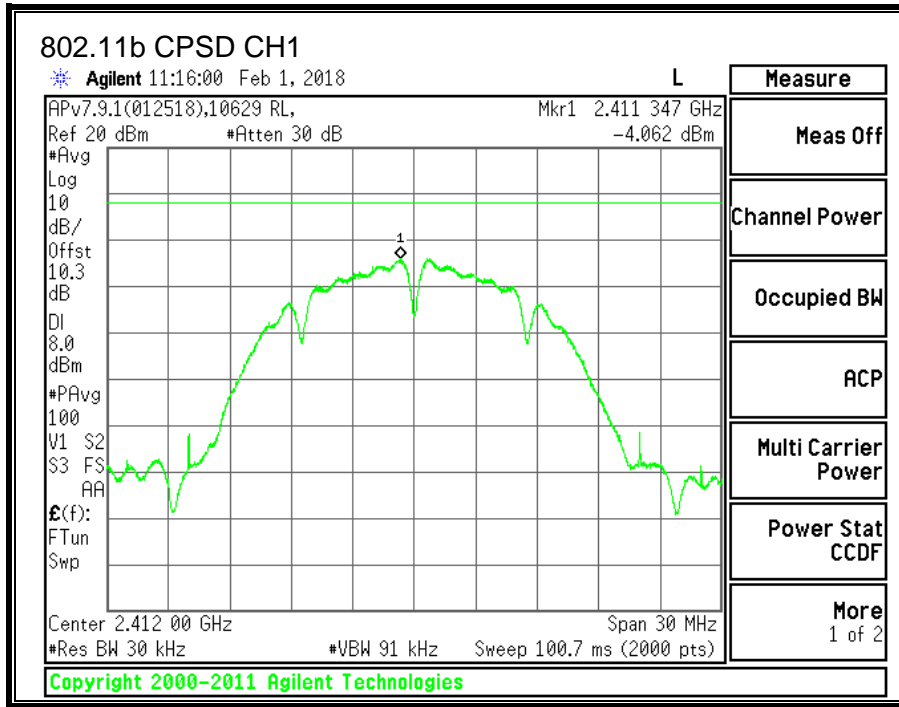

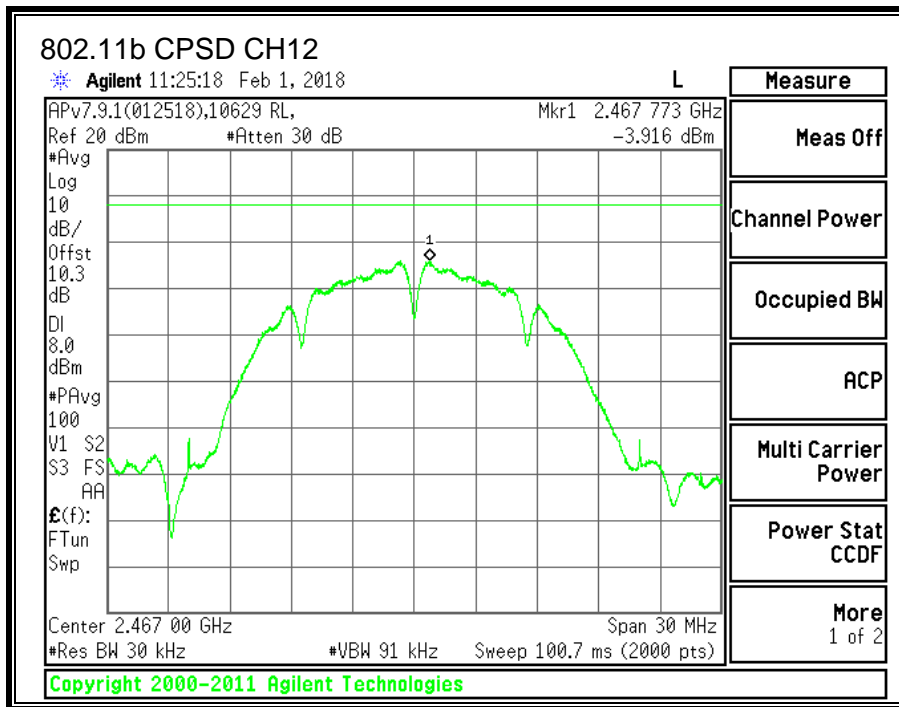
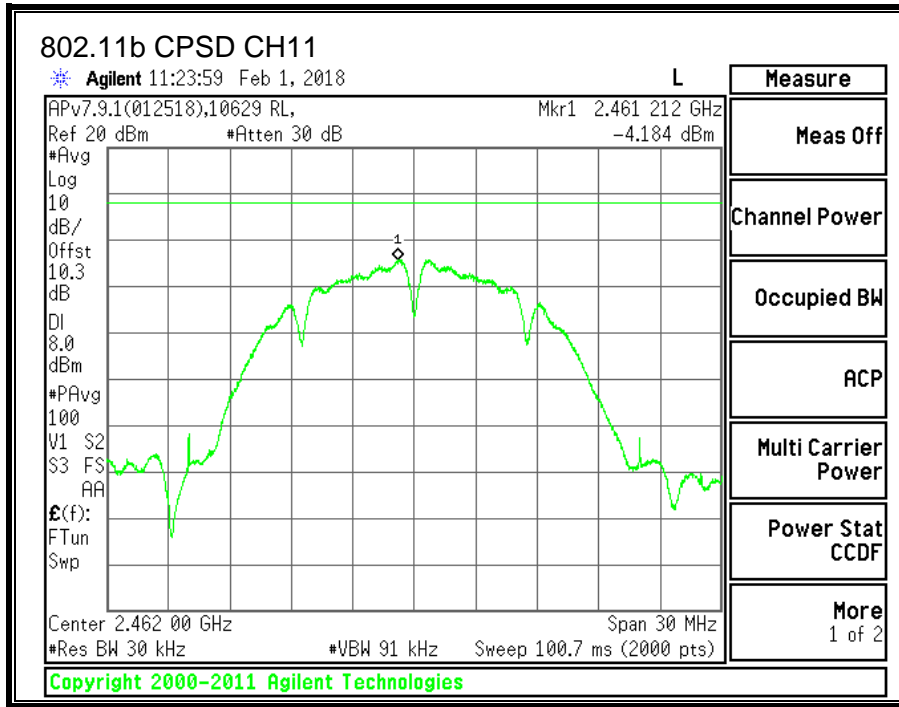

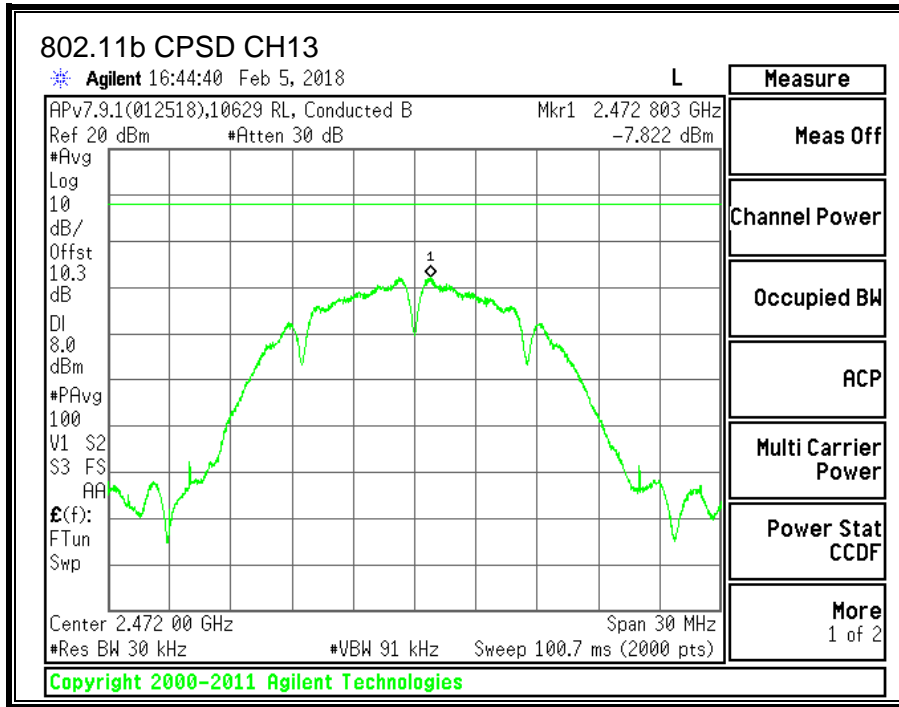

8.2.5. CONDUCTED BANDEDGE AND SPURIOUS EMISSIONS

LIMITS

FCC §15.247 (d)

IC RSS-247 (5.5)

In any 100 kHz bandwidth outside the frequency band in which the spread spectrum or digitally modulated intentional radiator is operating, the radio frequency power that is produced by the intentional radiator shall be at least 20 dB below that in the 100 kHz bandwidth within the band that contains the highest level of the desired power, based on either an RF conducted or a radiated measurement, provided the transmitter demonstrates compliance with the peak conducted power limits. If the transmitter complies with the conducted power limits based on the use of RMS averaging over a time interval, as permitted under paragraph (b)(3) of this section, the attenuation required under this paragraph shall be 30 dB instead of 20 dB. Attenuation below the general limits specified in §15.209(a) is not required.

RESULTS

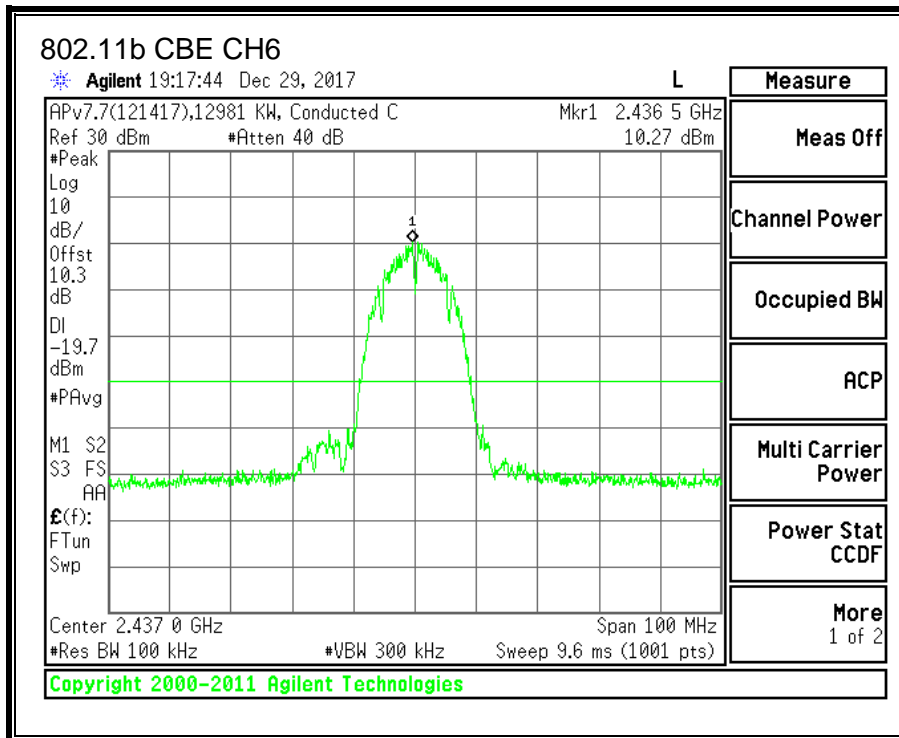
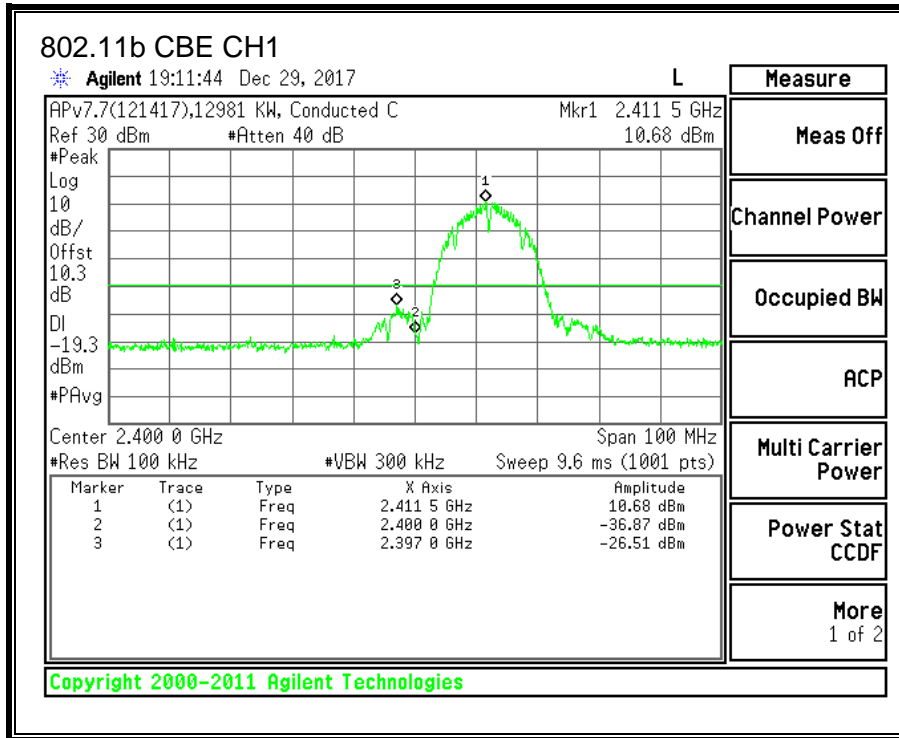

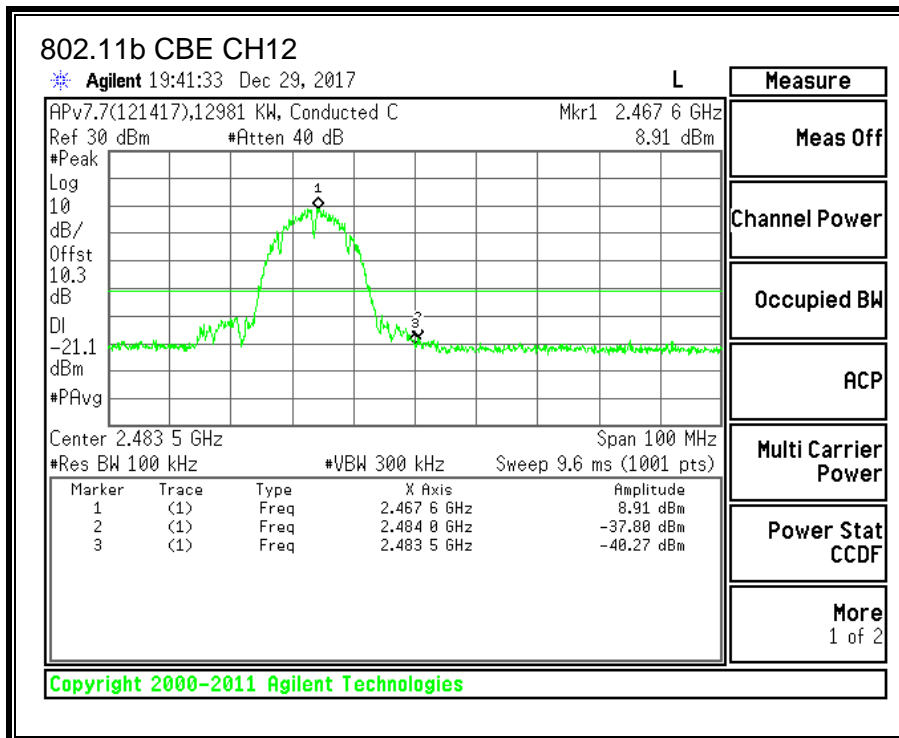
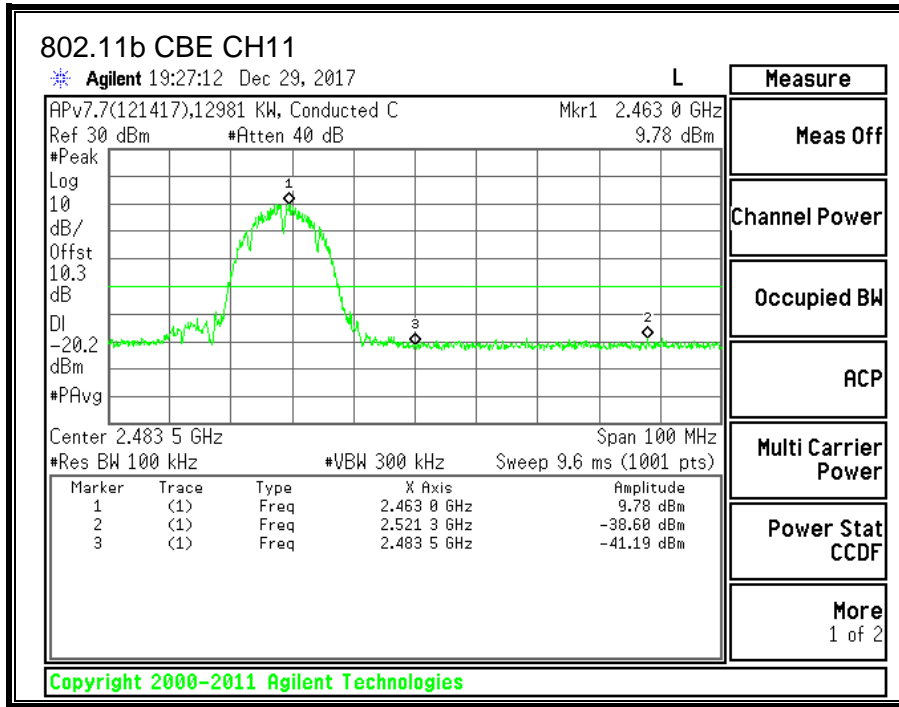

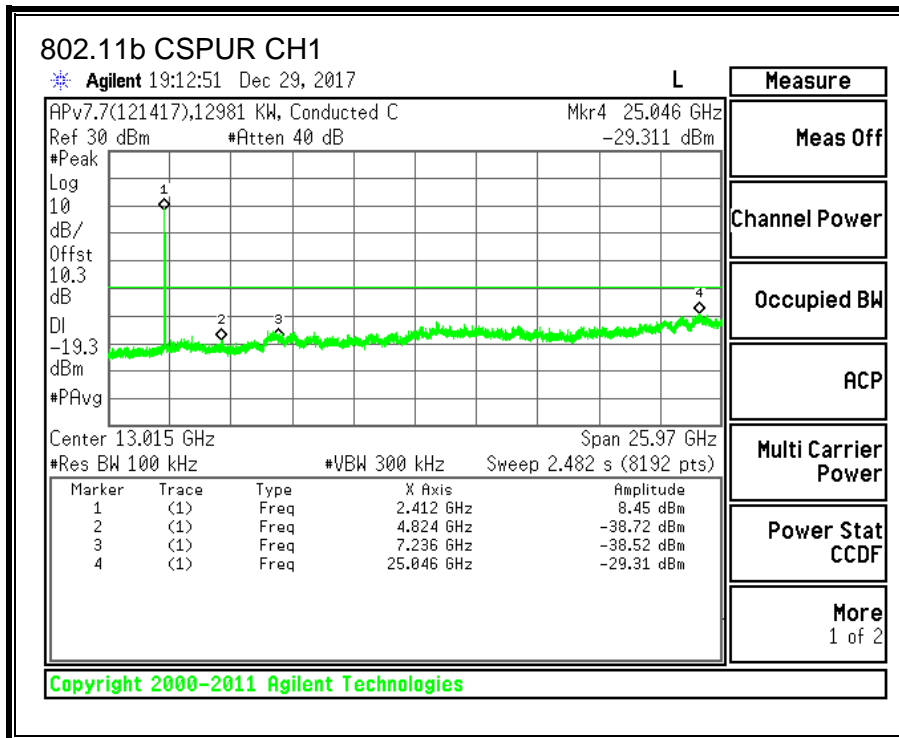
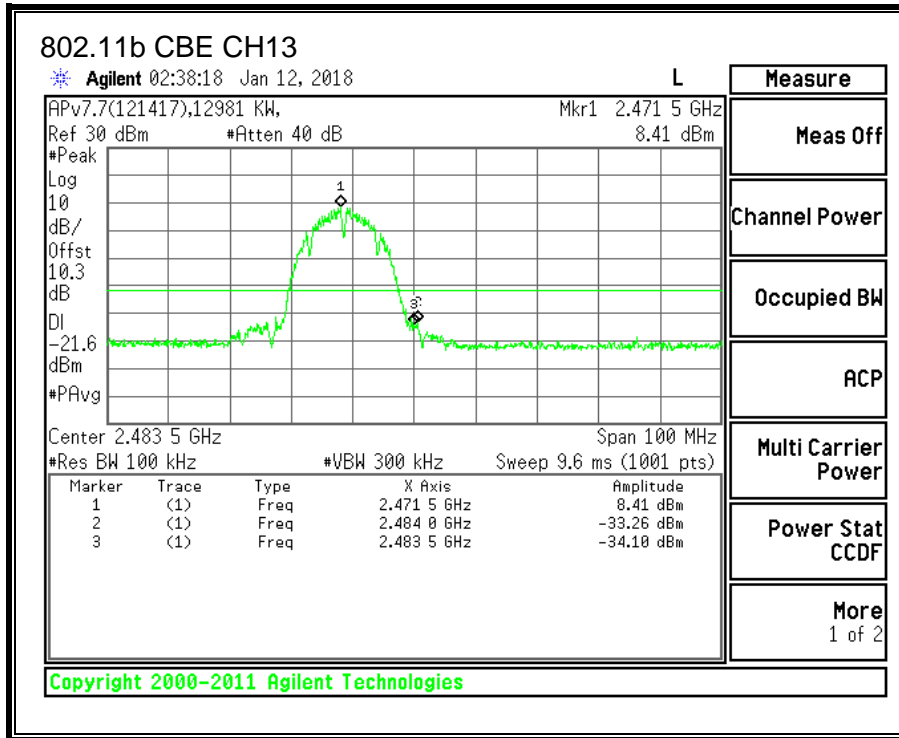

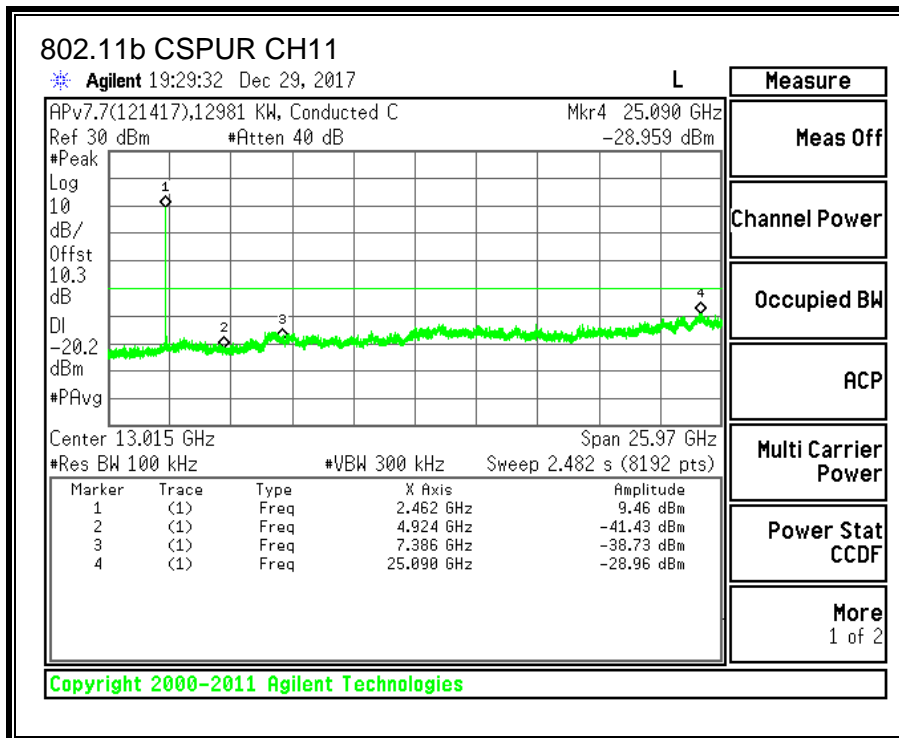
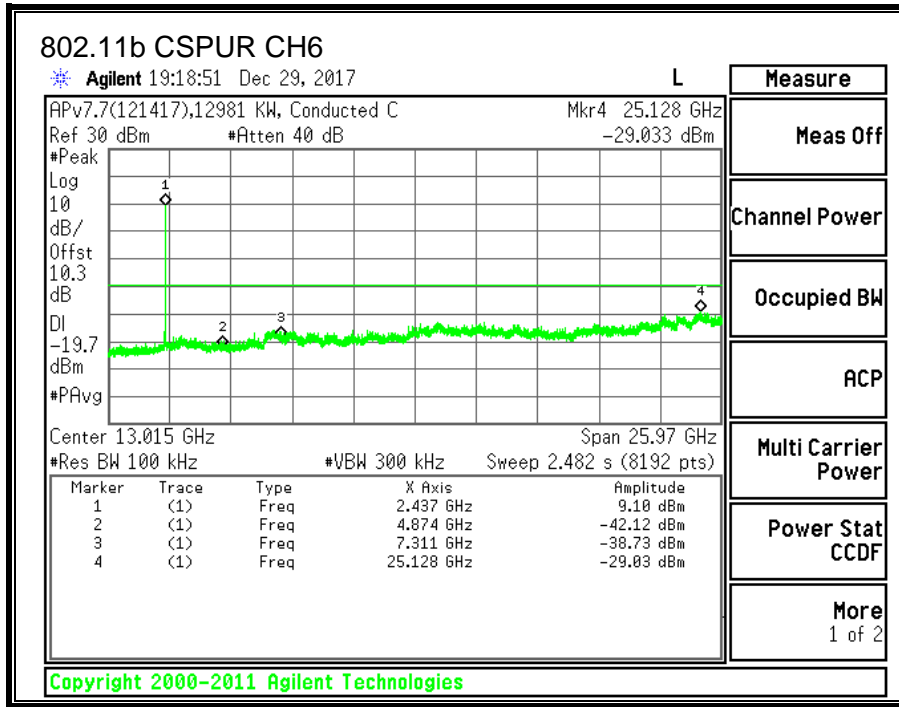

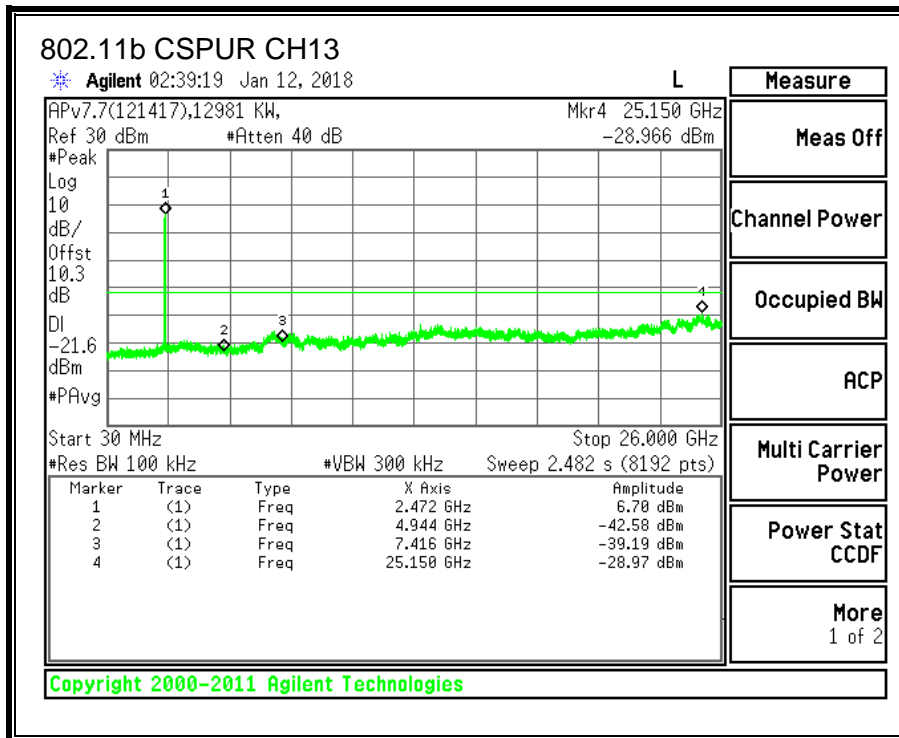
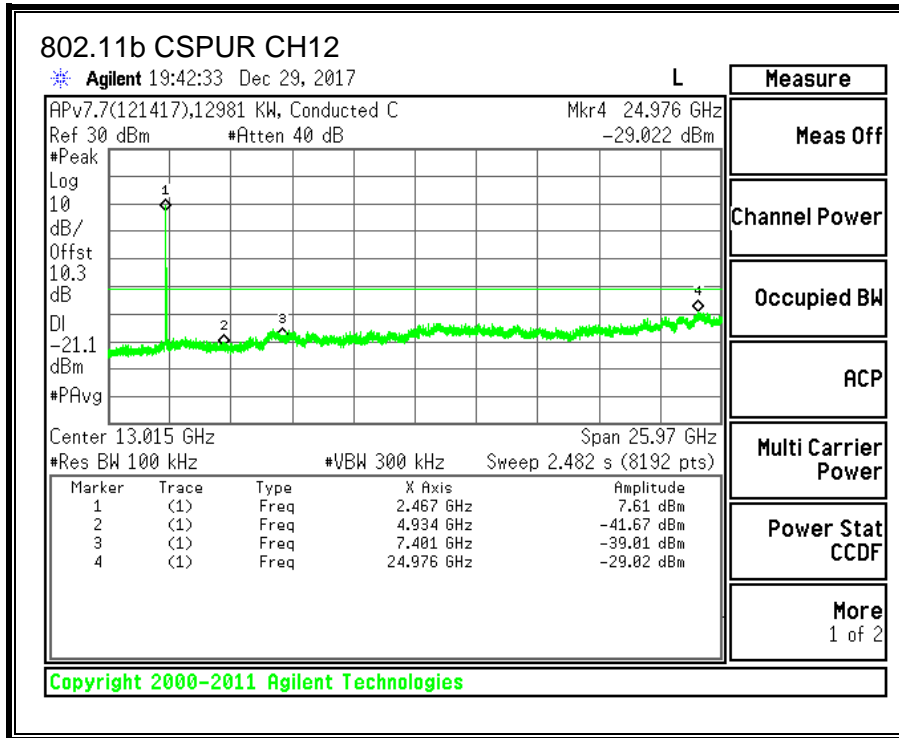

8.3. 11g MODE IN THE 2.4GHz BAND

8.3.1. 6 dB BANDWIDTH

LIMITS

FCC §15.247 (a) (2)

IC RSS-247 (5.2) (a)

The minimum 6 dB bandwidth shall be at least 500 kHz.

RESULTS

Channel	Frequency (MHz)	6 dB BW (MHz)	Minimum Limit (MHz)
CH1	2412	15.44	0.5
CH2	2417	15.36	0.5
CH6	2437	15.76	0.5
CH10	2457	14.24	0.5
CH11	2462	15.52	0.5
CH12	2467	15.68	0.5
CH13	2472	15.12	0.5

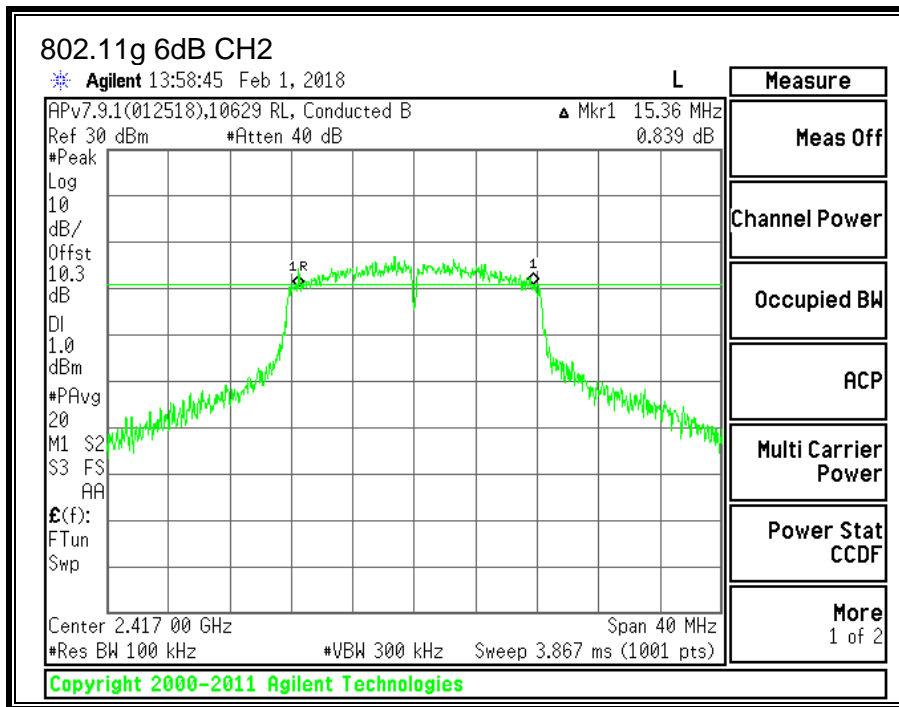
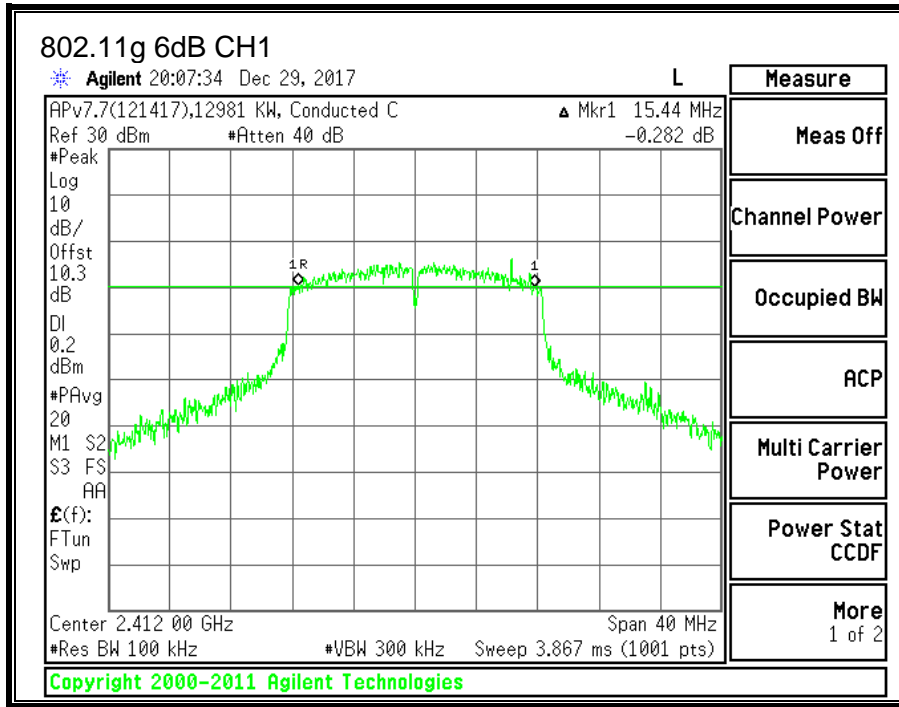

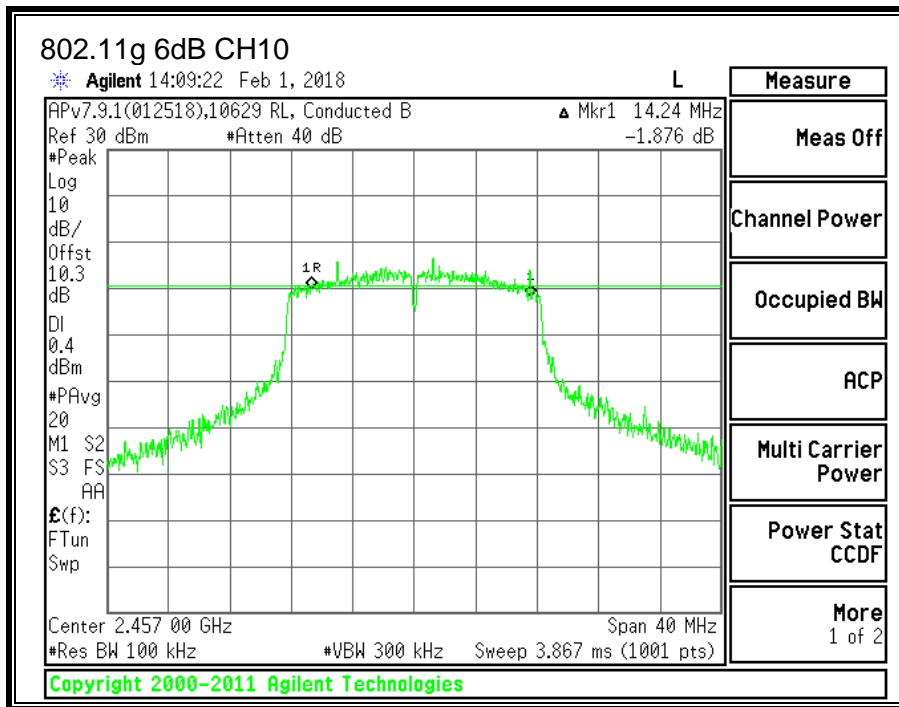
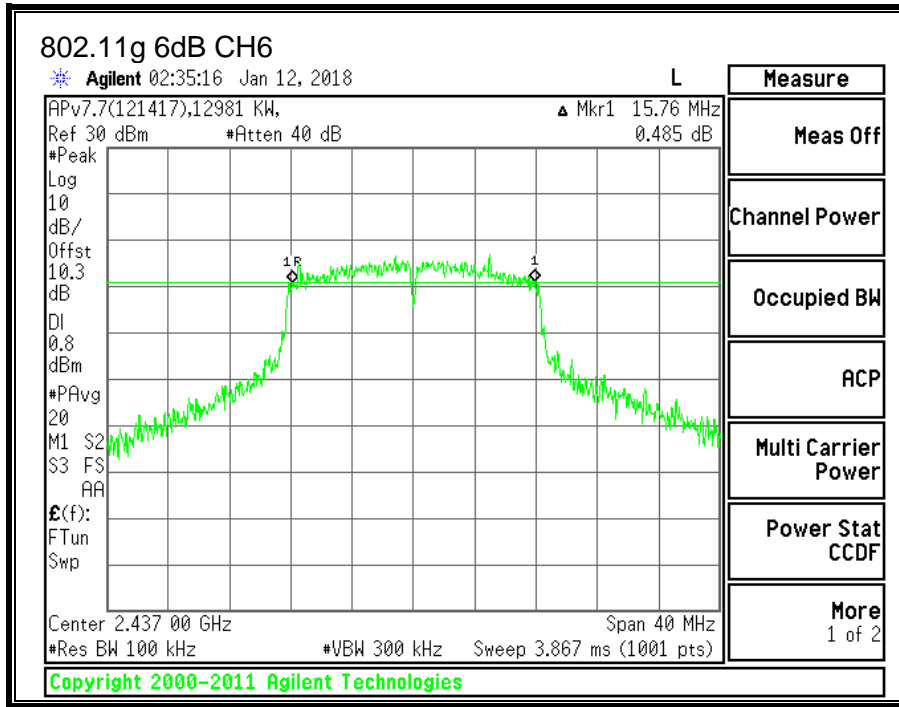

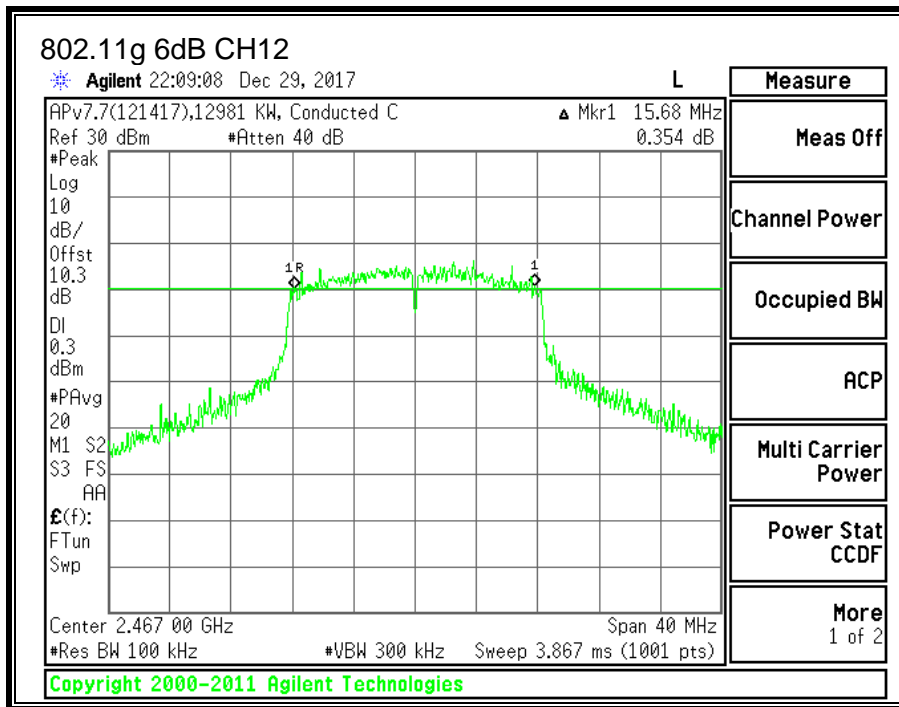
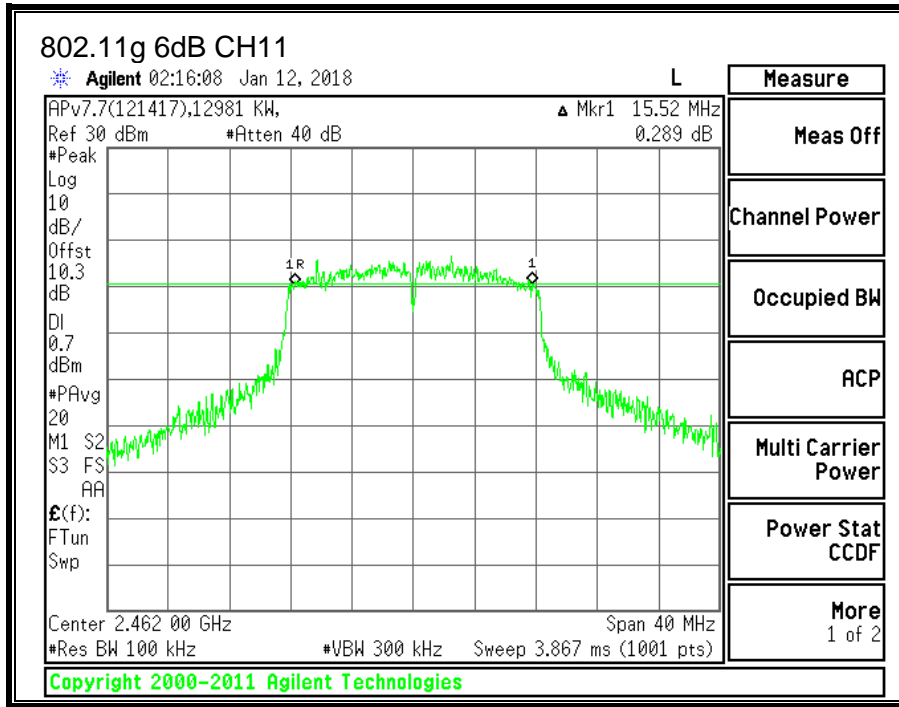

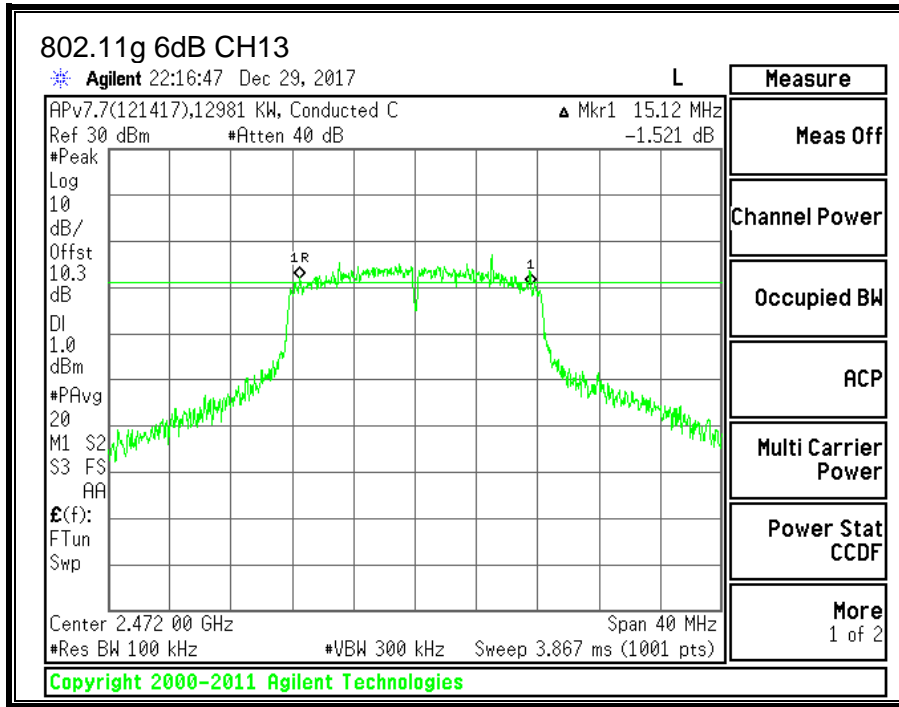

8.3.2. 99% BANDWIDTH

LIMITS

None; for reporting purposes only.

RESULTS

Channel	Frequency (MHz)	99% Bandwidth (MHz)
CH1	2412	16.3651
CH2	2417	16.4441
CH6	2437	16.3629
CH10	2457	16.2950
CH11	2462	14.1331
CH12	2467	16.3441
CH13	2472	16.3657

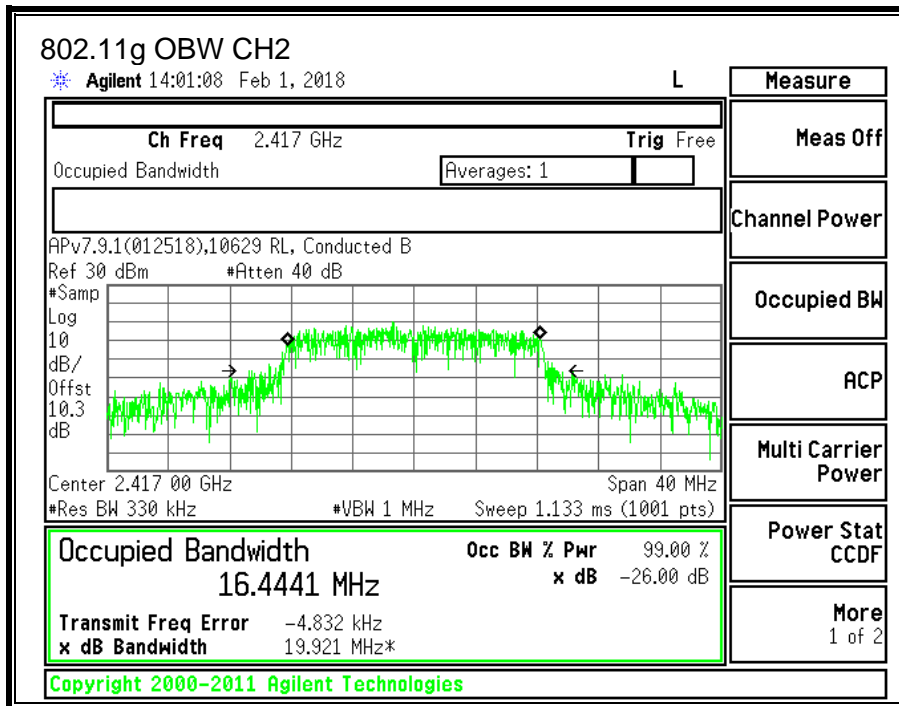
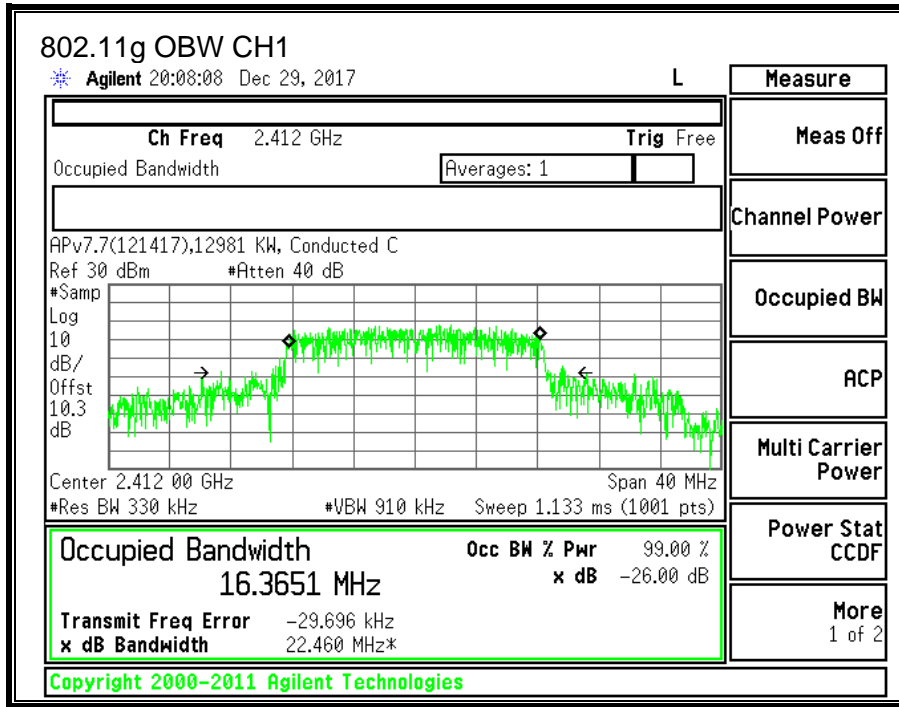

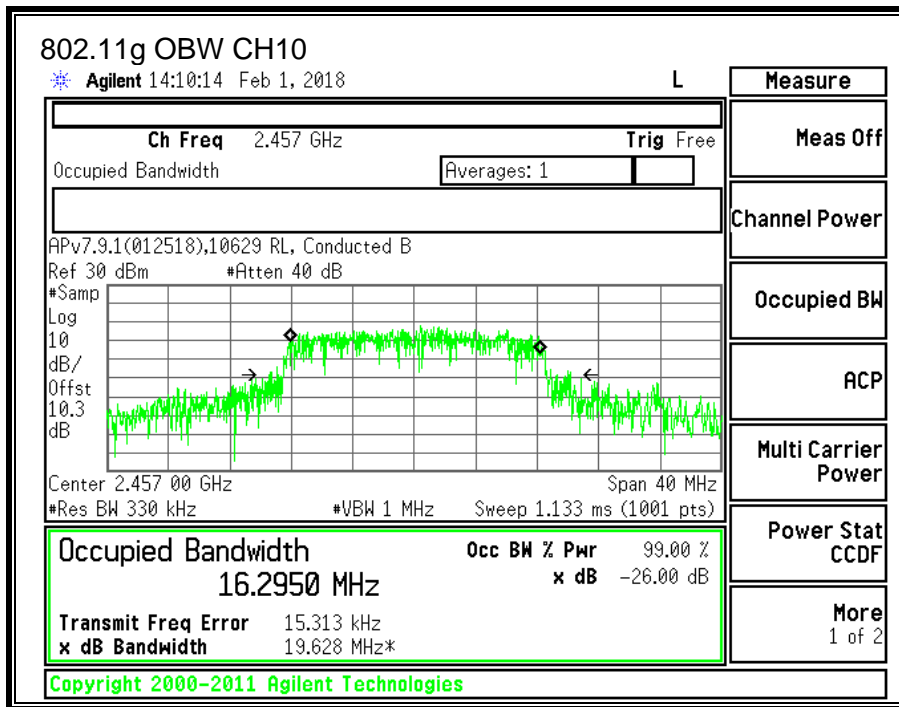
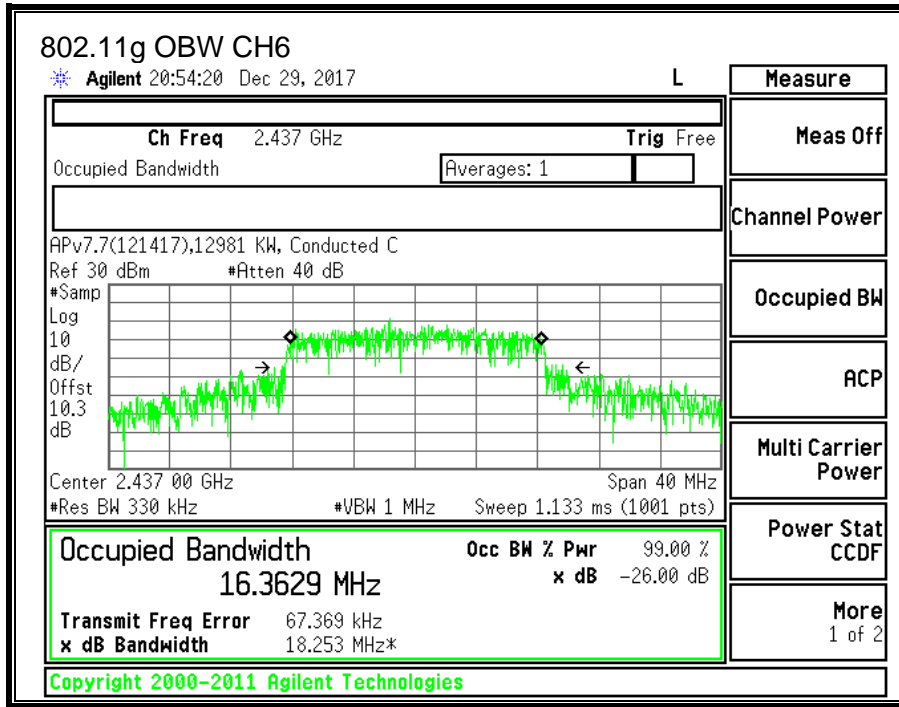

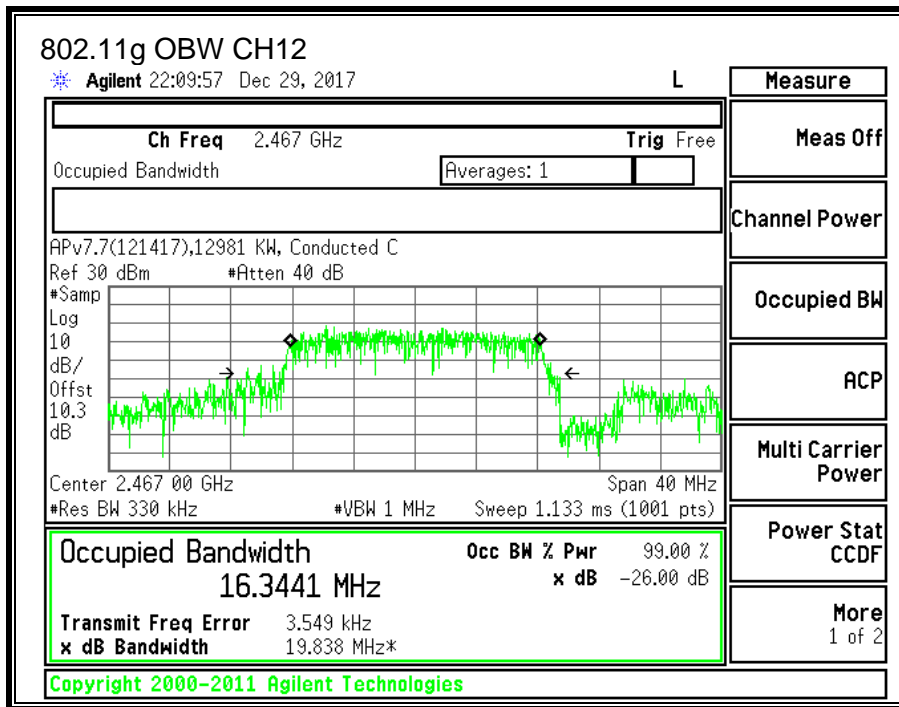
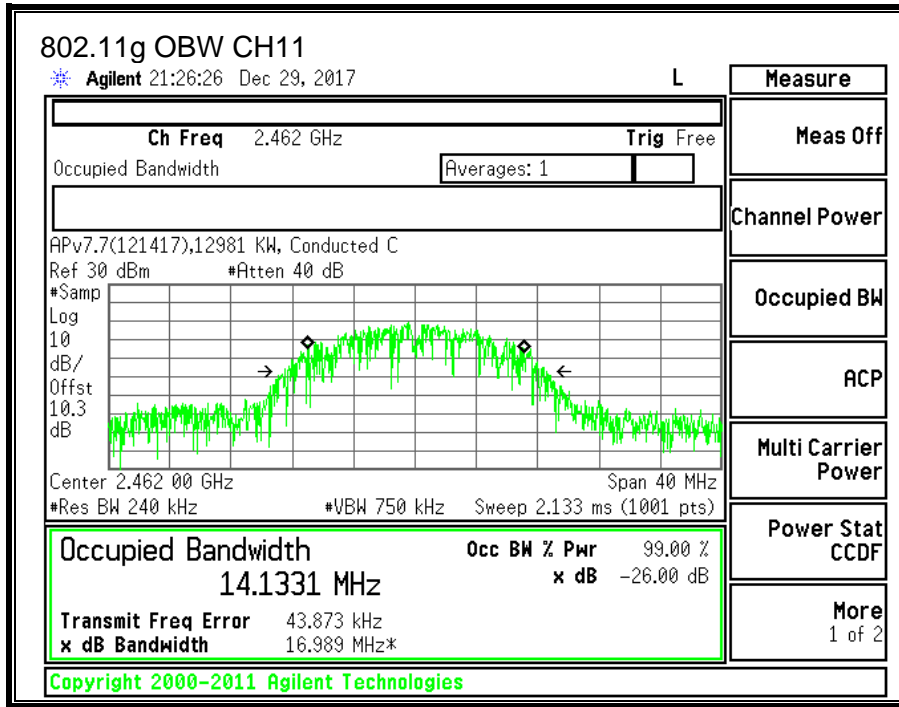

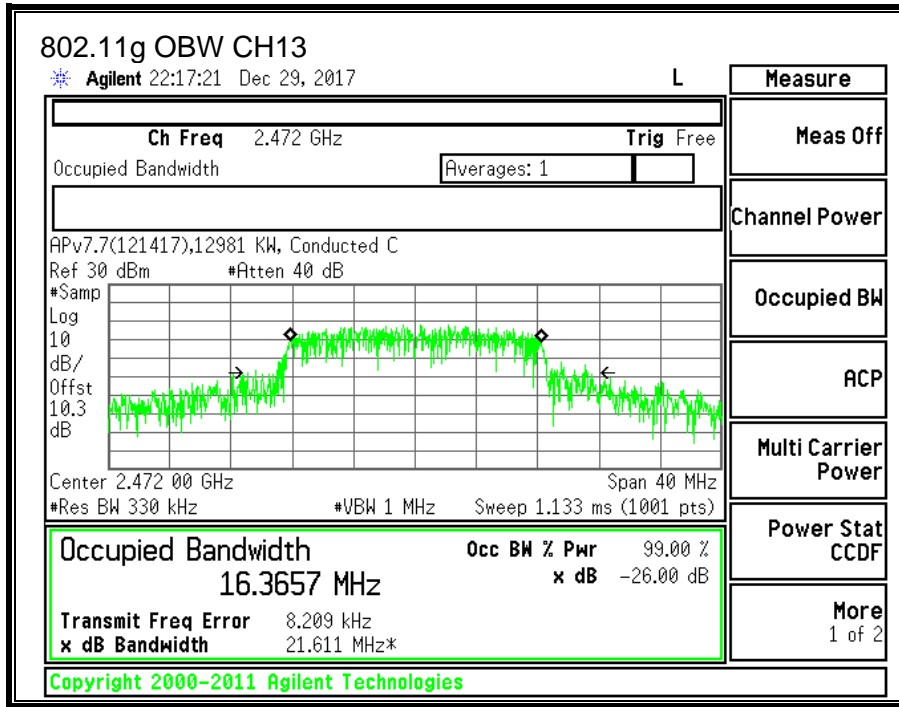

8.3.3. OUTPUT POWER

LIMITS

FCC §15.247

IC RSS-247 (5.4) (d)

The maximum antenna gain is less than or equal to 6 dBi, therefore the limit is 30 dBm.

DIRECTIONAL ANTENNA GAIN

There is only one transmitter output therefore the directional gain is equal to the antenna gain.

RESULTS

ID:	10629	Date:	02/01/18
------------	-------	--------------	----------

Limits

Channel	Frequency (MHz)	Directional Gain (dBi)	FCC Power Limit (dBm)	IC Power Limit (dBm)	IC EIRP Limit (dBm)	Max Power (dBm)
CH1	2412	-11.30	30.00	30	36	30.00
CH2	2417	-11.30	30.00	30	36	30.00
CH6	2437	-11.30	30.00	30	36	30.00
CH10	2457	-11.30	30.00	30	36	30.00
CH11	2462	-11.30	30.00	30	36	30.00
CH12	2467	-11.30	30.00	30	36	30.00
CH13	2472	-11.30	30.00	30	36	30.00

Results

Channel	Frequency (MHz)	Measured Power (dBm)	Power Limit (dBm)	Margin (dB)
CH1	2412	16.9	30.00	-13.10
CH2	2417	18.97	30.00	-11.03
CH6	2437	18.98	30.00	-11.02
CH10	2457	17.9	30.00	-12.10

8.3.4. POWER SPECTRAL DENSITY

LIMITS

FCC §15.247

IC RSS-247 (5.2) (b)

The power spectral density conducted from the transmitter to the antenna shall not be greater than 8 dBm in any 3 kHz band during any time interval of continuous transmission.

RESULTS

Duty Cycle CF (dB)	0.00	Included in Calculations of Corr'd PSD
---------------------------	------	---

PSD Results

Channel	Frequency (MHz)	Measured (dBm)	Corr'd PSD (dBm)	Limit (dBm)	Margin (dB)
CH1	2412	-6.693	-6.693	8.0	-14.69
CH2	2417	-4.651	-4.651	8.0	-12.65
CH6	2437	-4.896	-4.896	8.0	-12.90
CH10	2457	-6.210	-6.210	8.0	-14.21
CH11	2462	-6.798	-6.798	8.0	-14.80
CH12	2467	-9.009	-9.009	8.0	-17.01
CH13	2472	-22.547	-22.547	8.0	-30.55

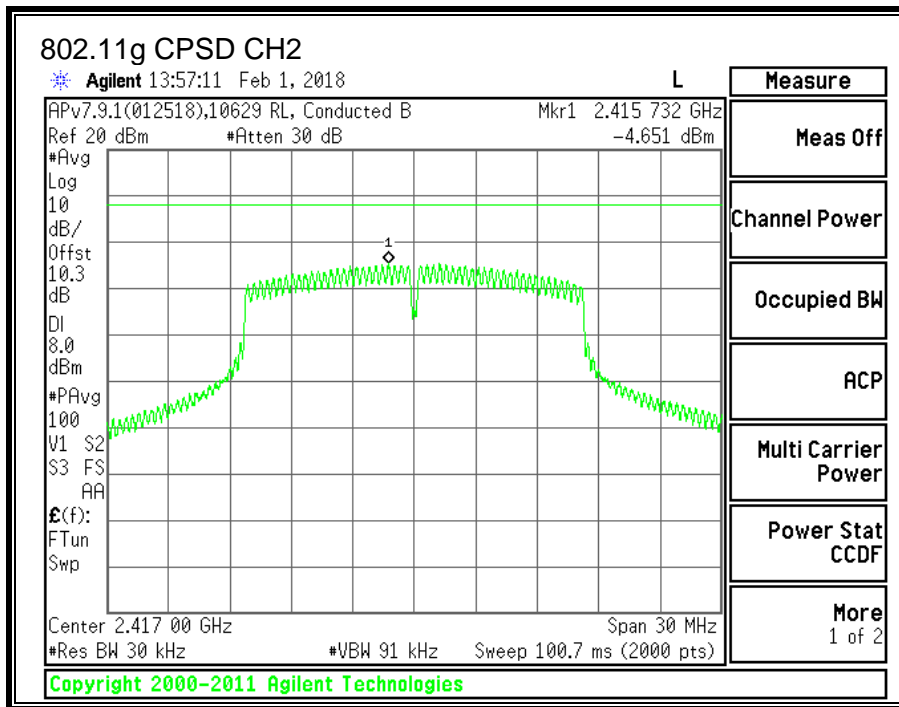
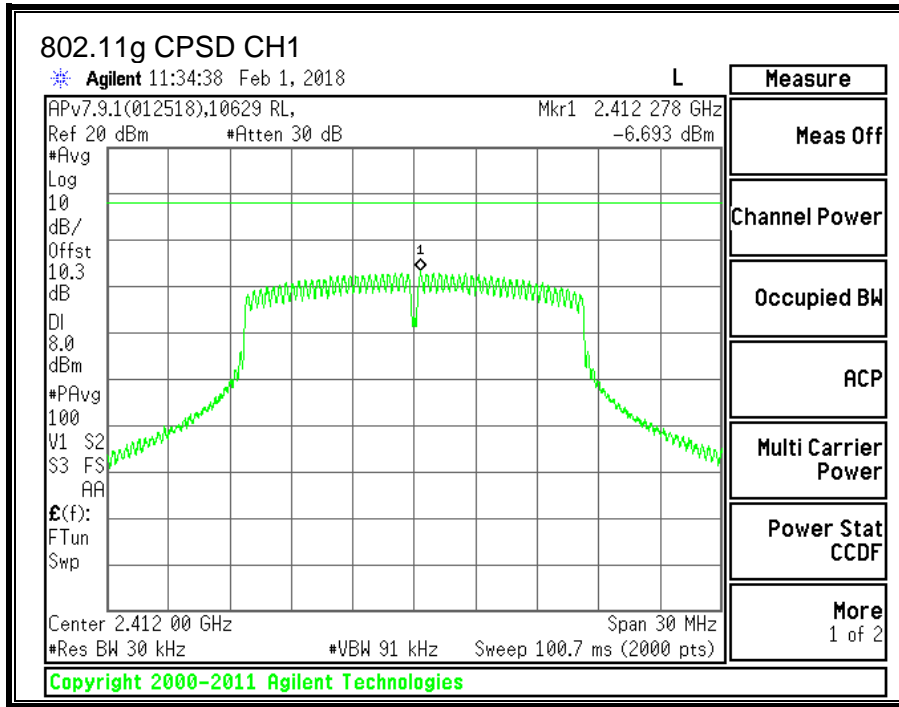

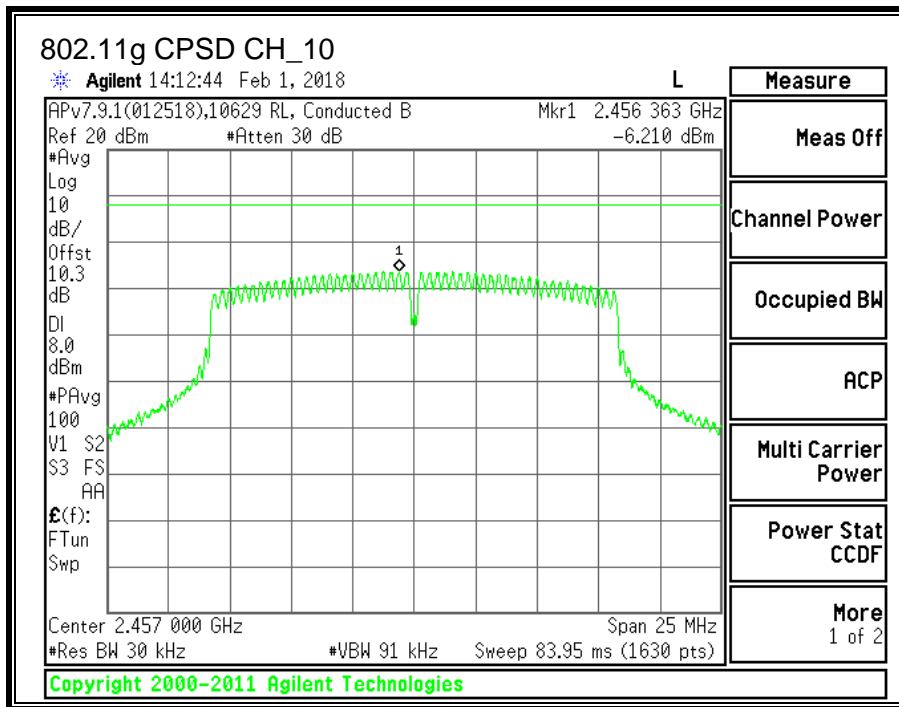
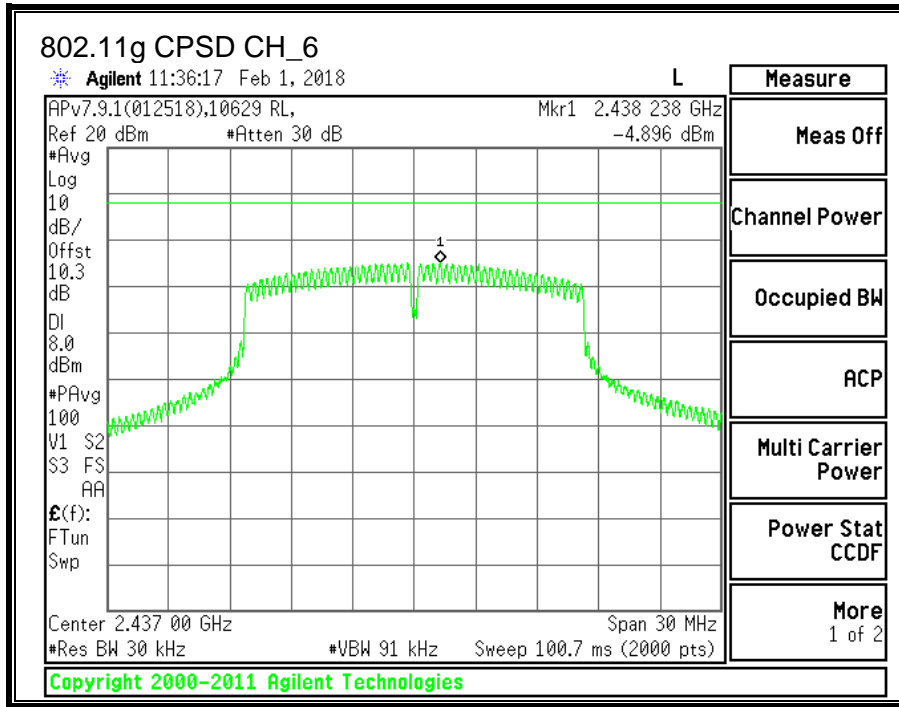

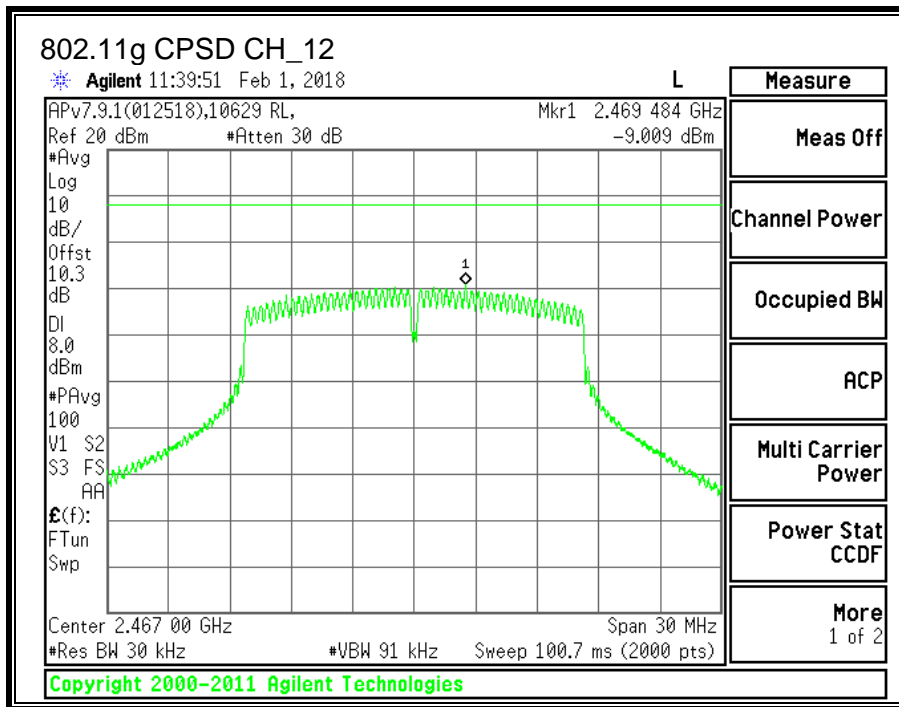
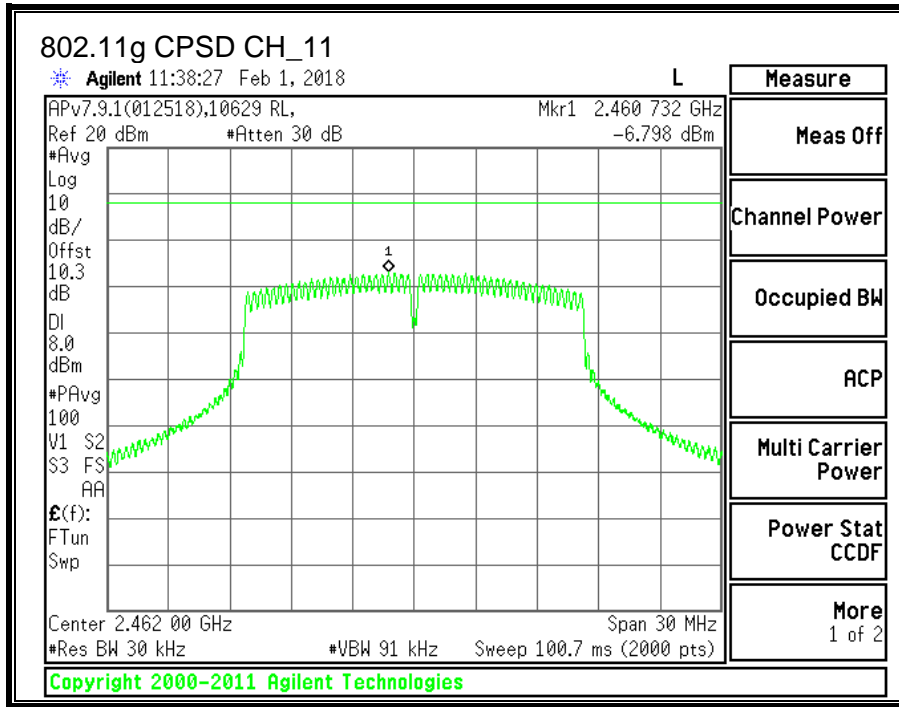

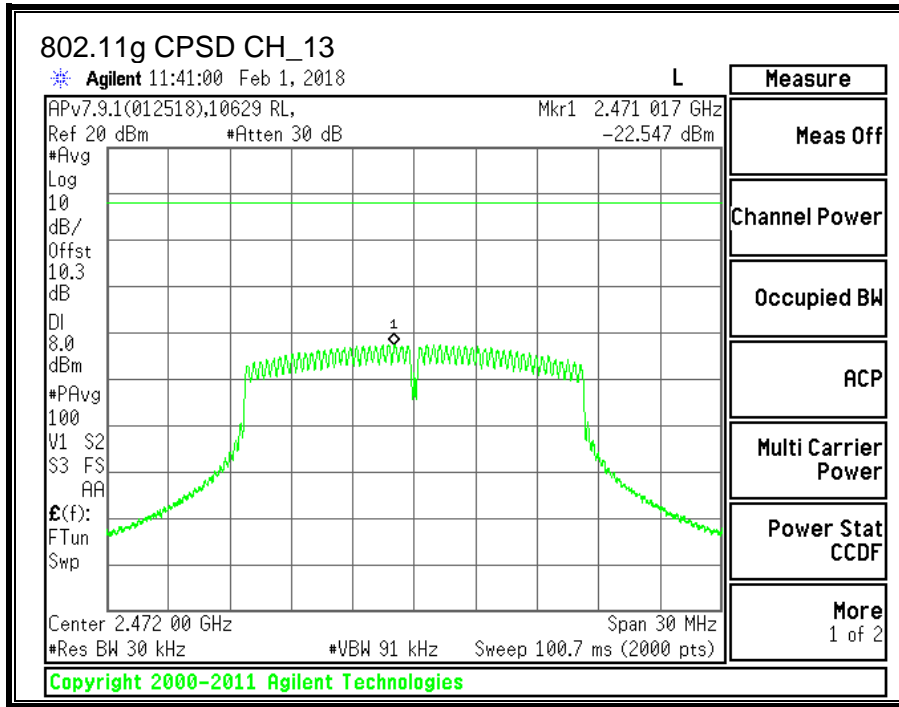

8.3.5. CONDUCTED BANDEDGE AND SPURIOUS EMISSIONS

LIMITS

FCC §15.247 (d)

IC RSS-247 (5.5)

In any 100 kHz bandwidth outside the frequency band in which the spread spectrum or digitally modulated intentional radiator is operating, the radio frequency power that is produced by the intentional radiator shall be at least 20 dB below that in the 100 kHz bandwidth within the band that contains the highest level of the desired power, based on either an RF conducted or a radiated measurement, provided the transmitter demonstrates compliance with the peak conducted power limits. If the transmitter complies with the conducted power limits based on the use of RMS averaging over a time interval, as permitted under paragraph (b)(3) of this section, the attenuation required under this paragraph shall be 30 dB instead of 20 dB. Attenuation below the general limits specified in §15.209(a) is not required.

RESULTS

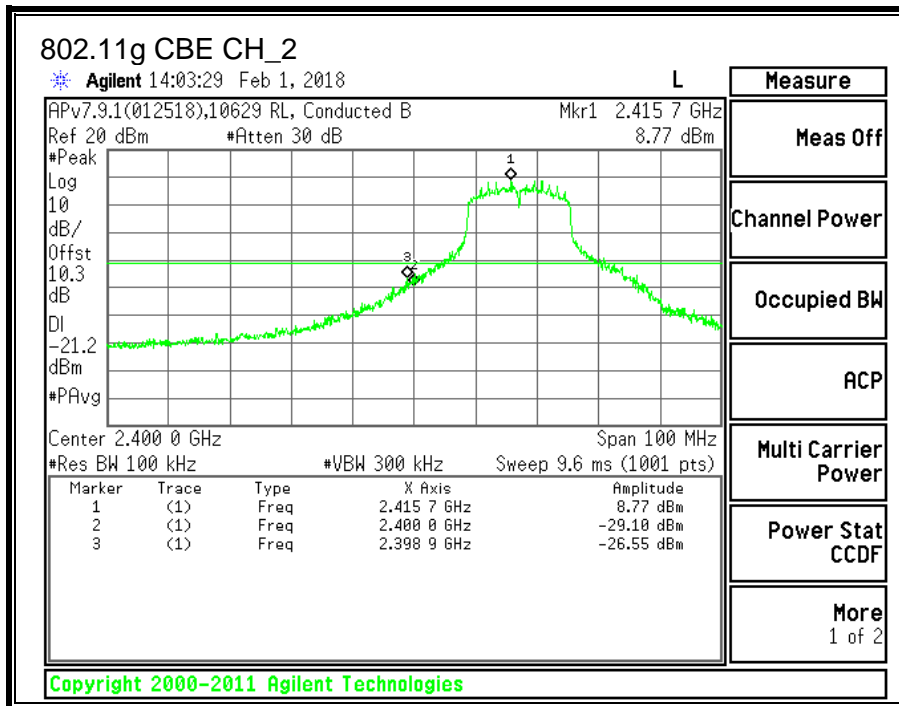
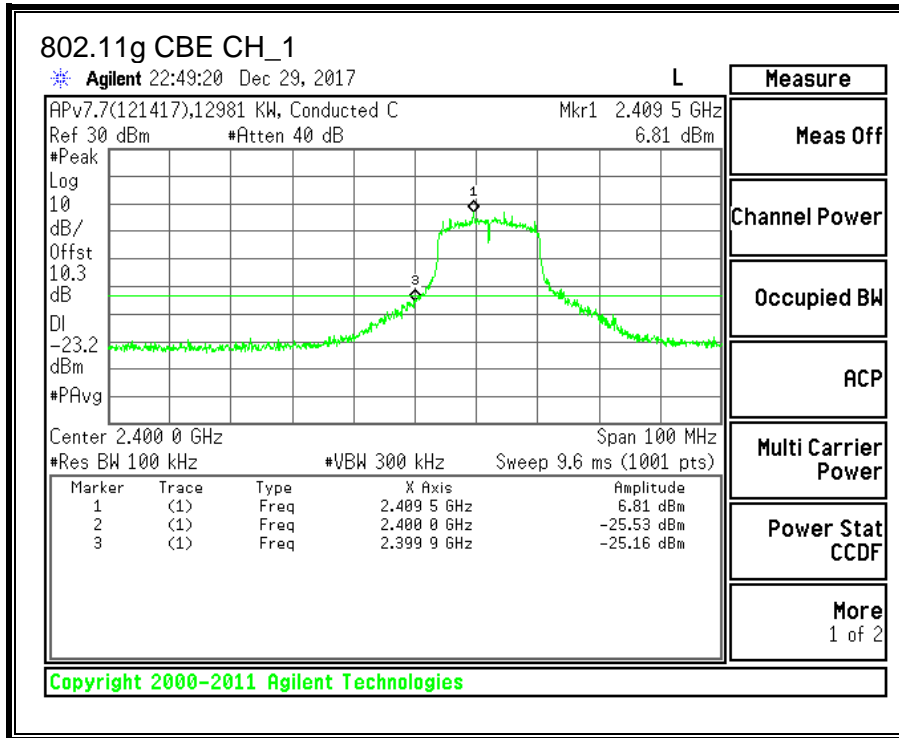

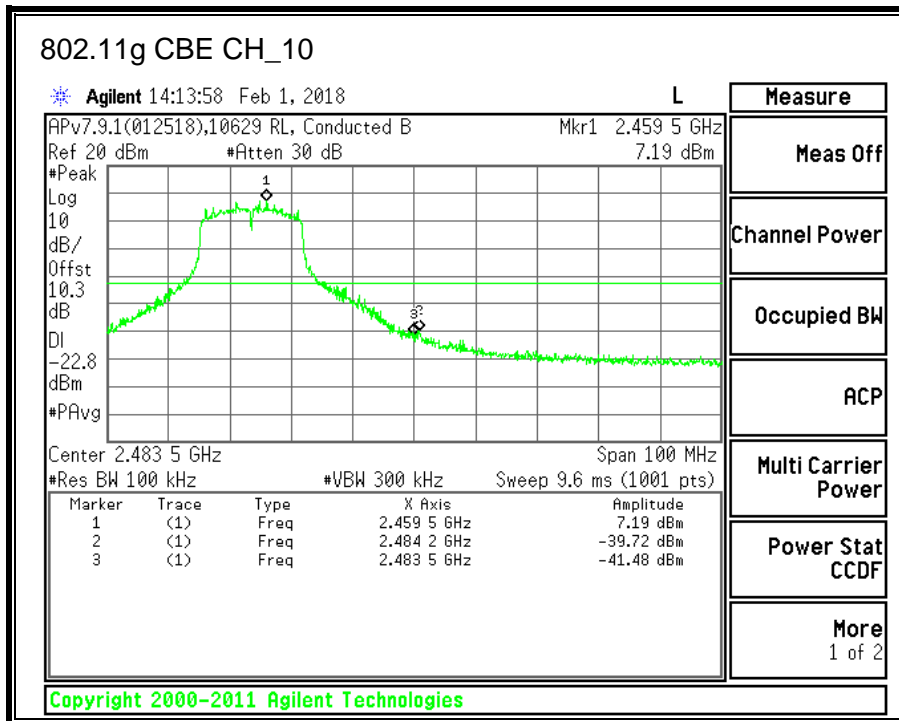
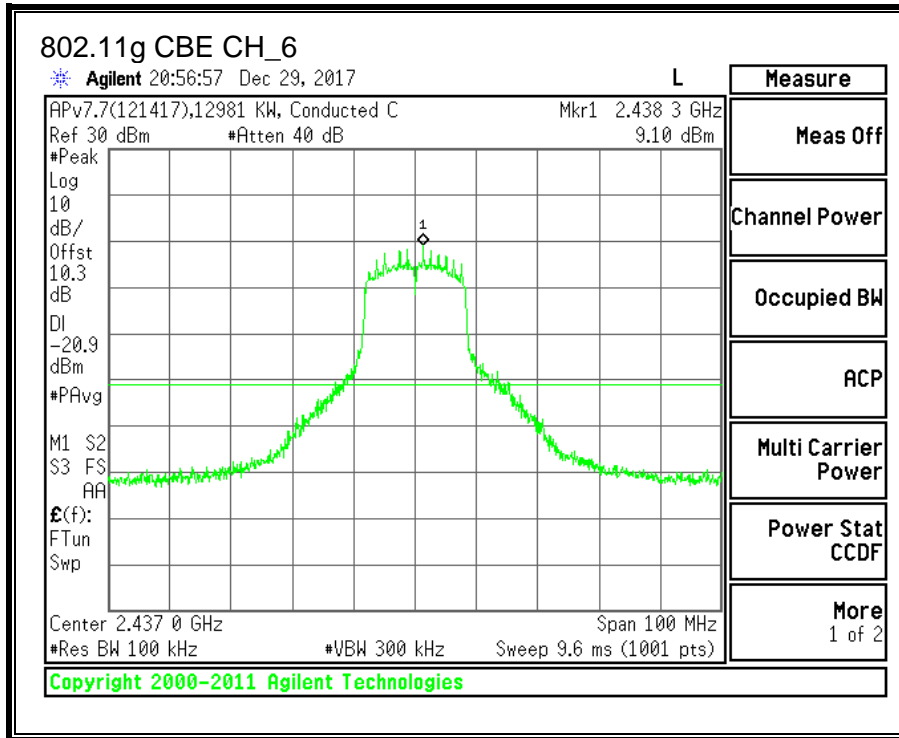

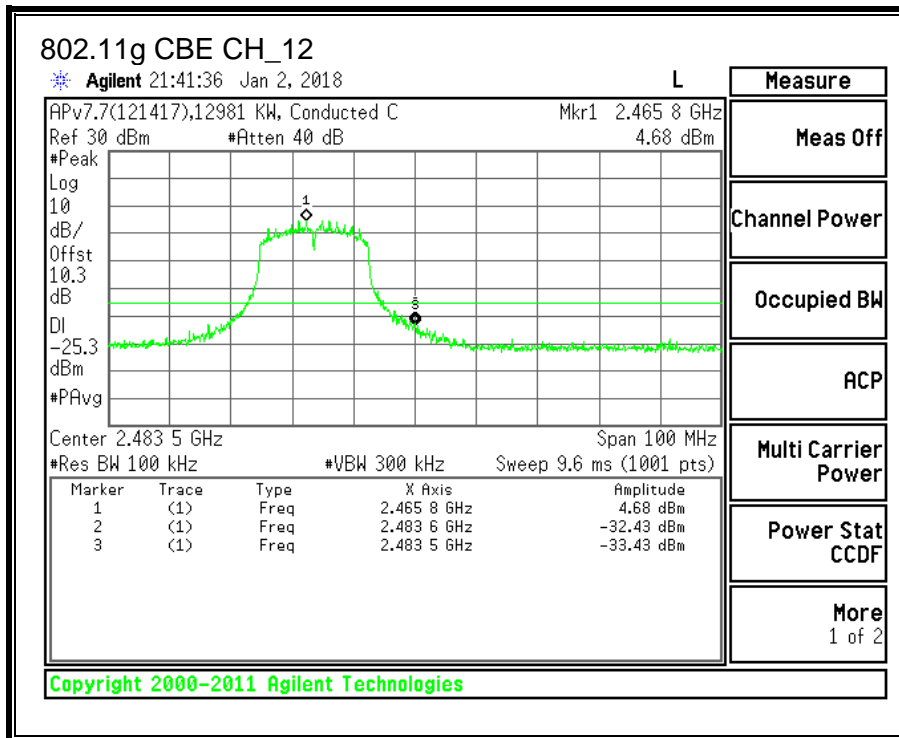
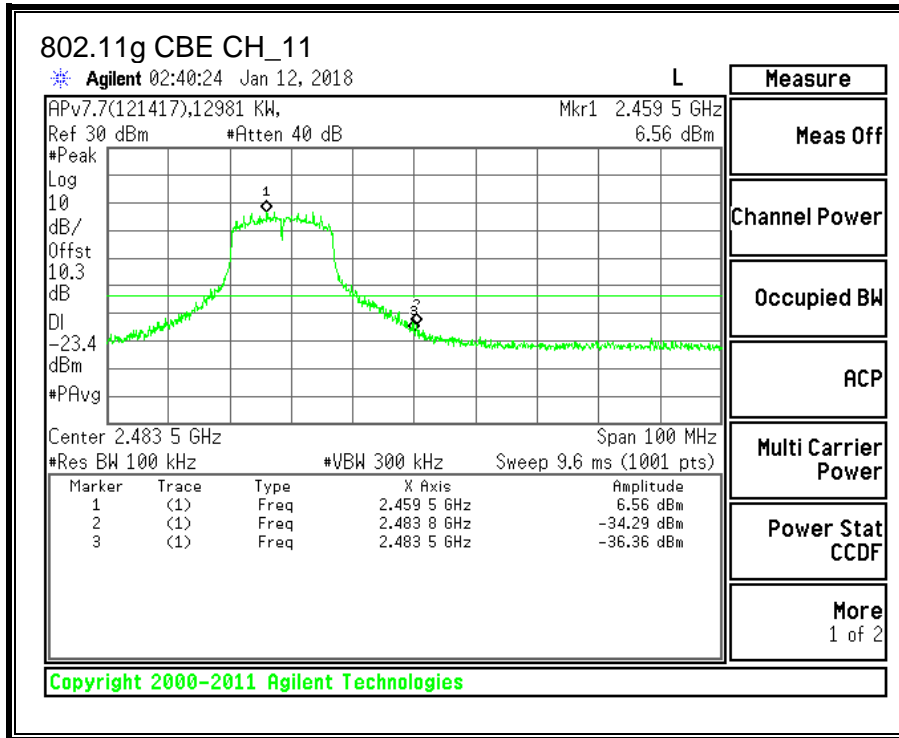

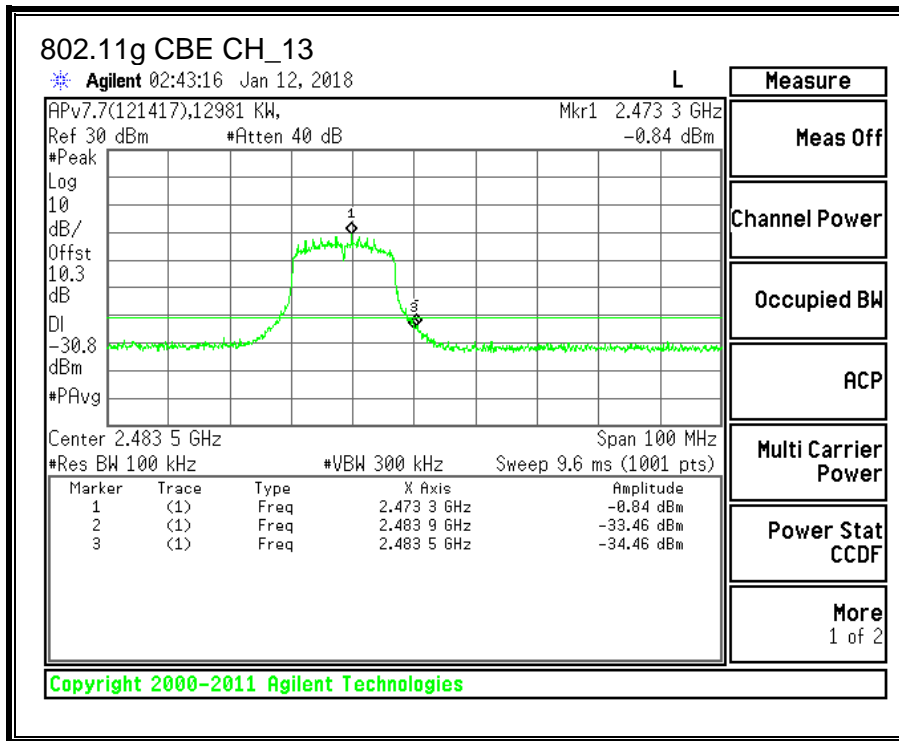

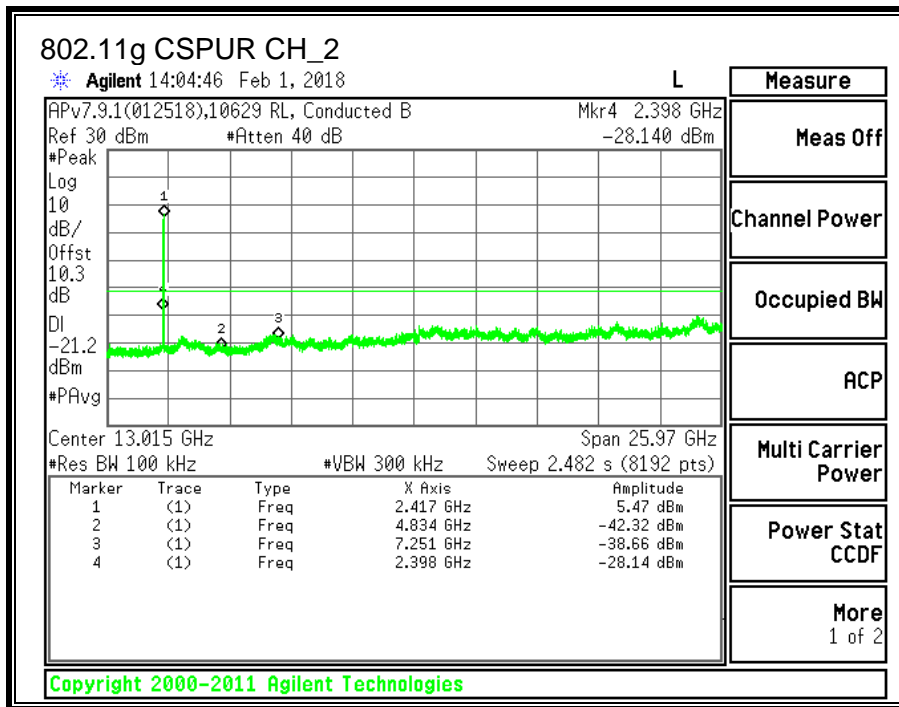
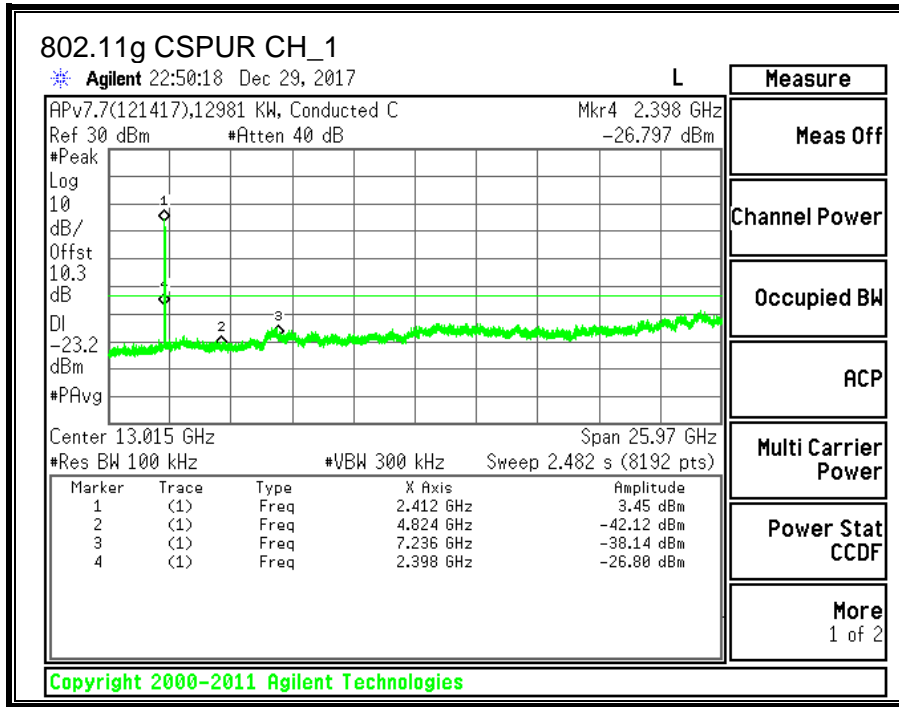

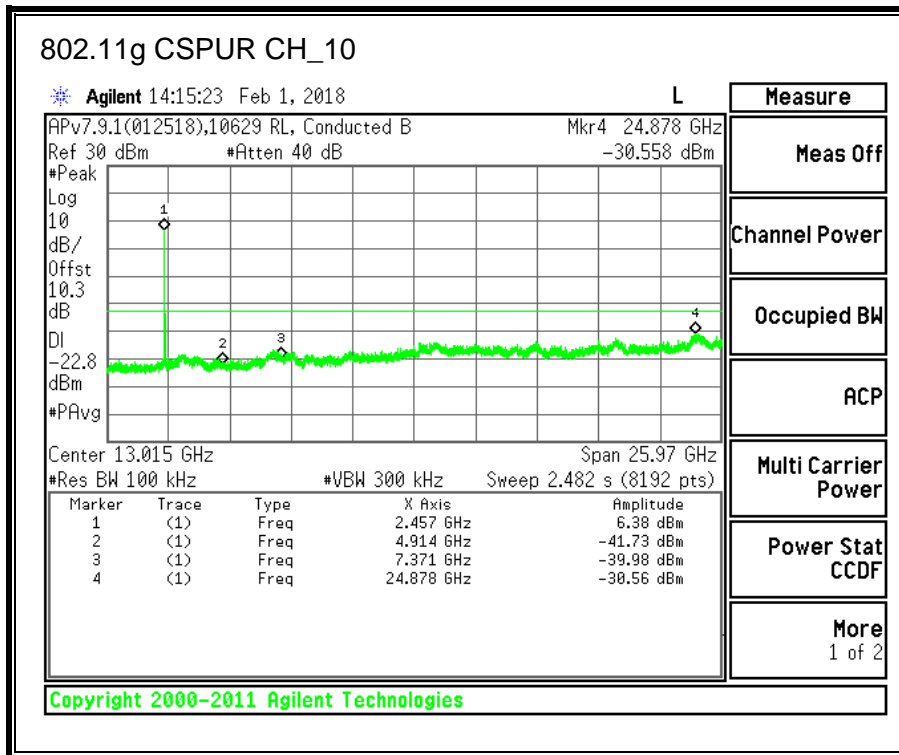
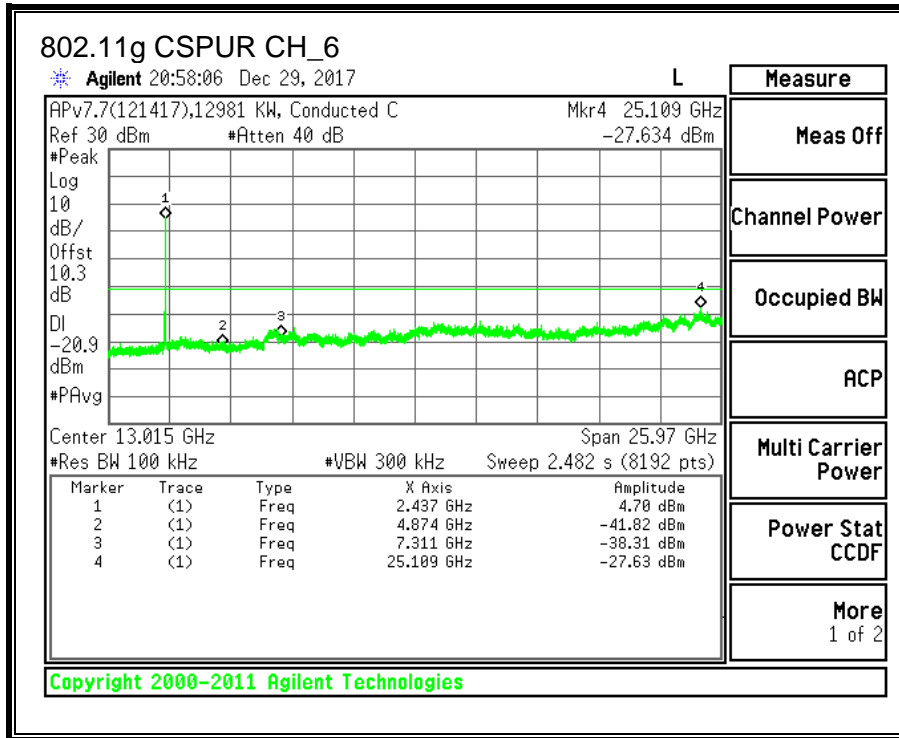

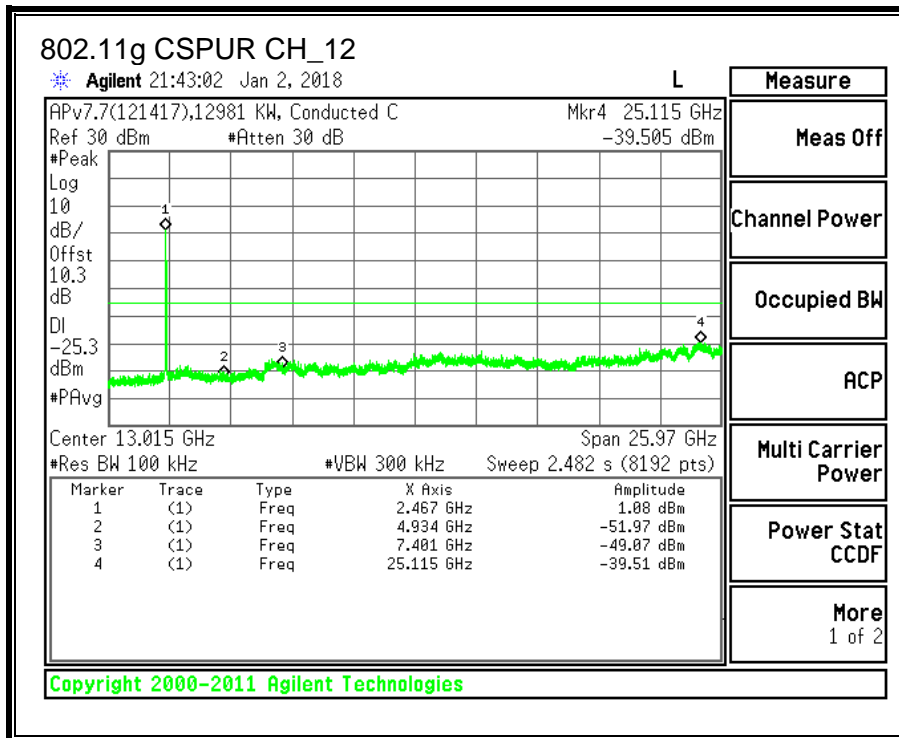
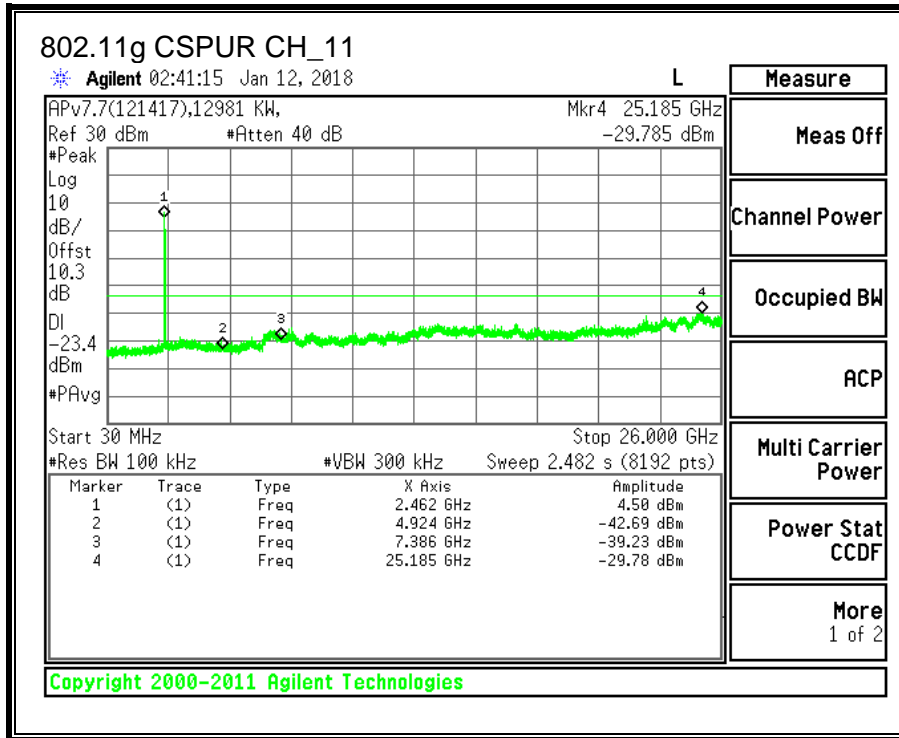

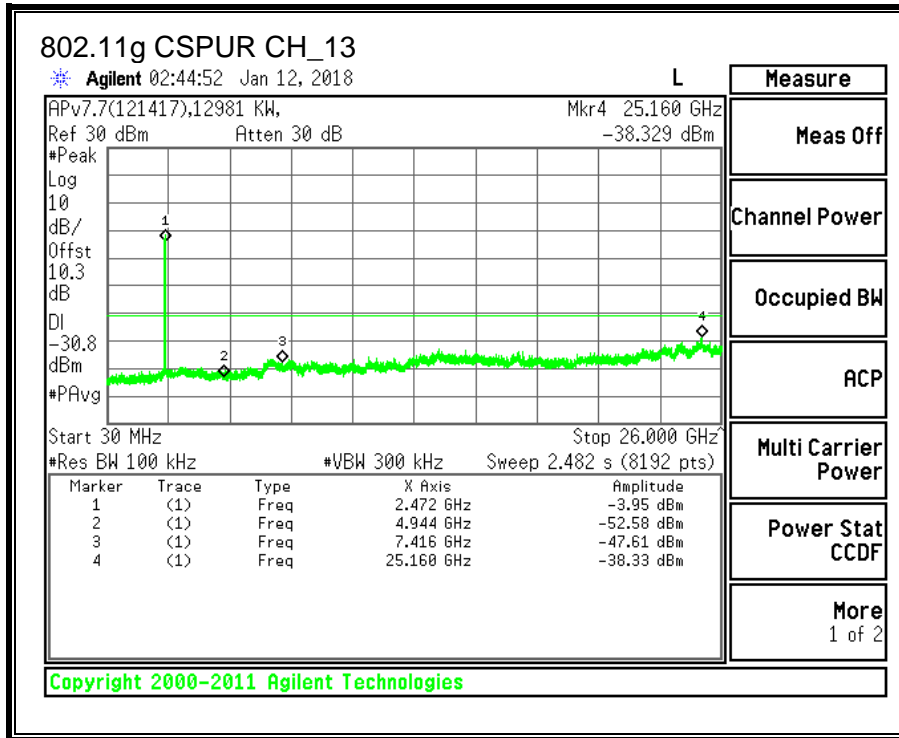

8.4. 11n HT20 MODE IN THE 2.4GHz BAND

8.4.1. 6 dB BANDWIDTH

LIMITS

FCC §15.247 (a) (2)

IC RSS-247 (5.2) (a)

The minimum 6 dB bandwidth shall be at least 500 kHz.

RESULTS

Channel	Frequency (MHz)	6 dB BW (MHz)	Minimum Limit (MHz)
CH1	2412	13.88	0.5
CH2	2417	14.84	0.5
CH6	2437	14.28	0.5
CH10	2457	16.04	0.5
CH11	2462	14.16	0.5
CH12	2467	16.52	0.5
CH13	2472	15.04	0.5

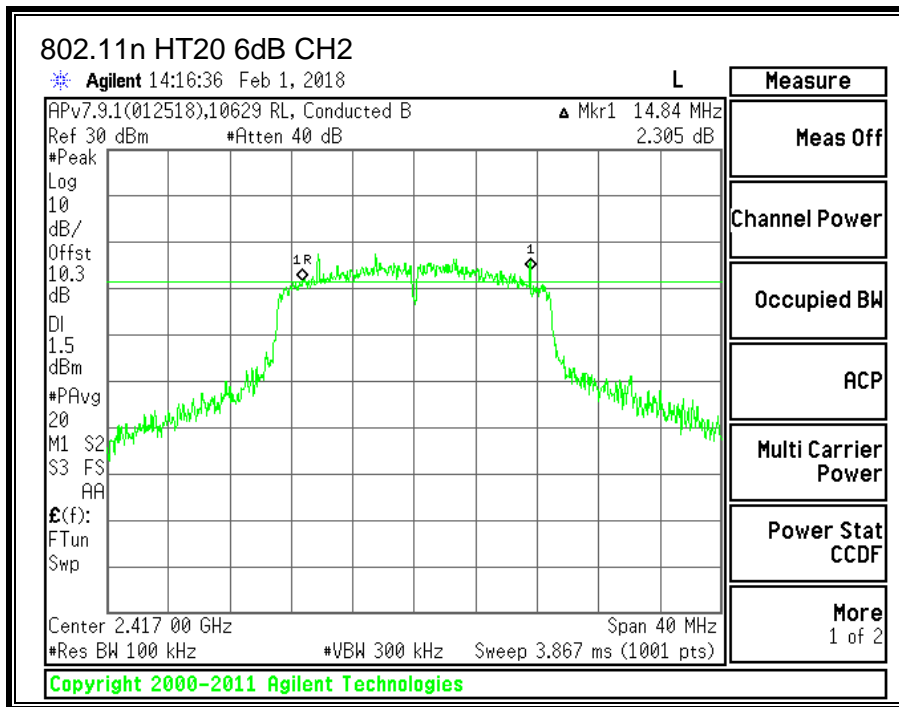
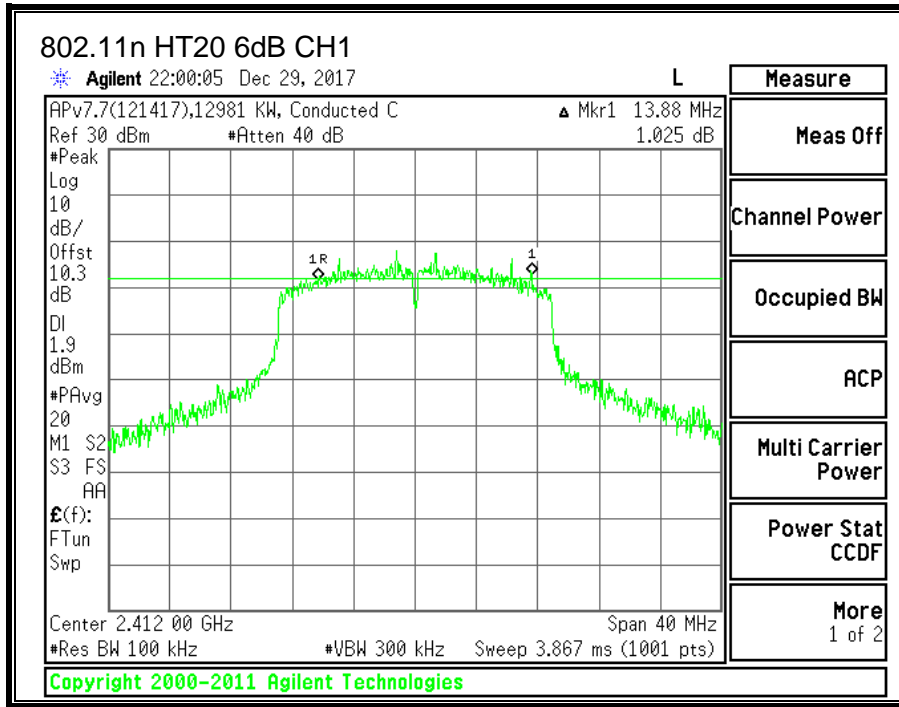

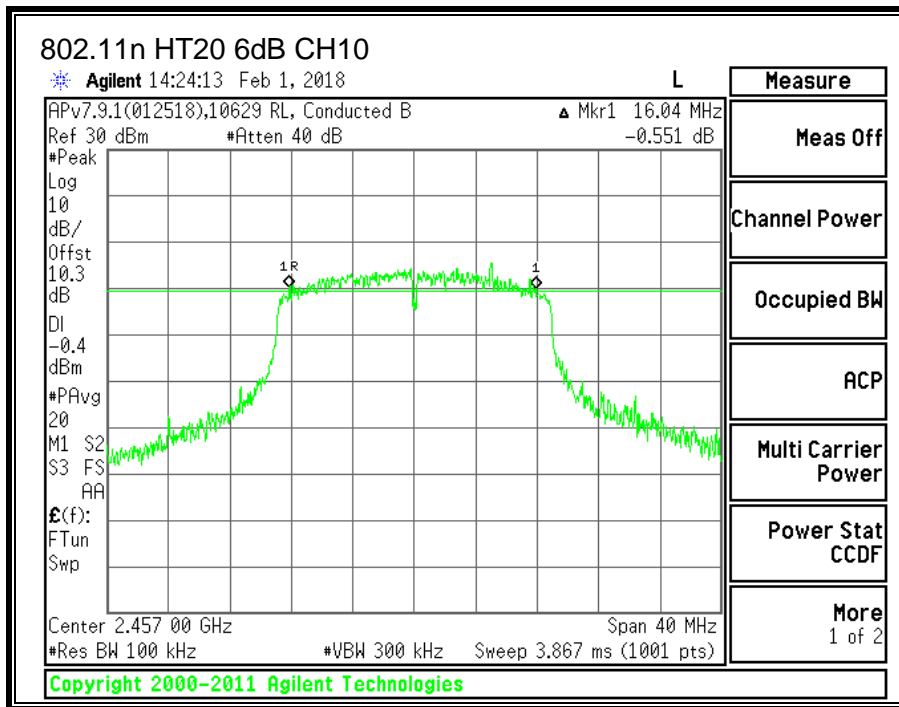
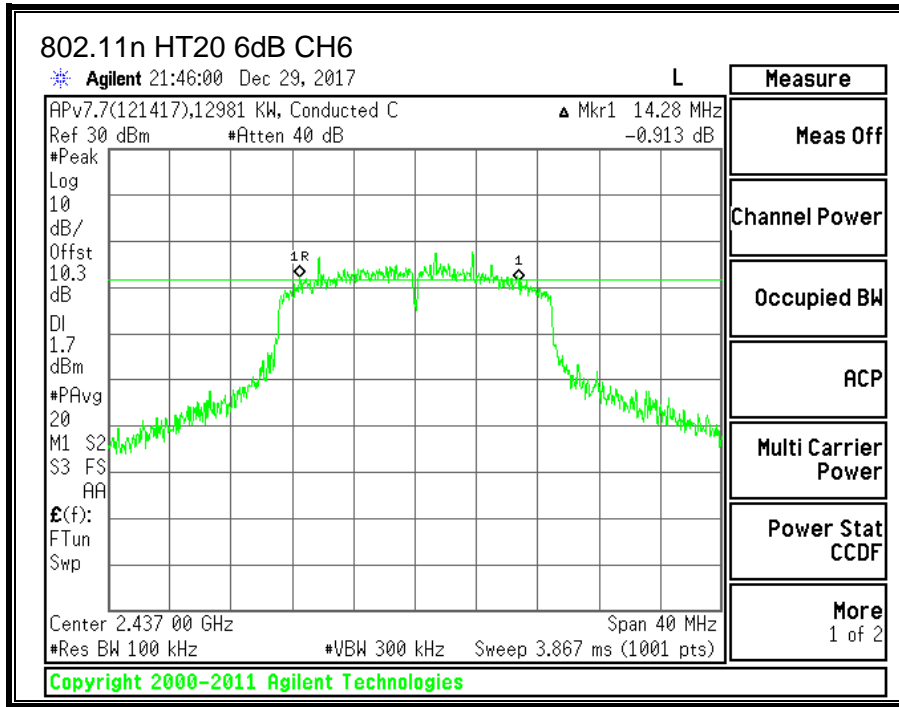

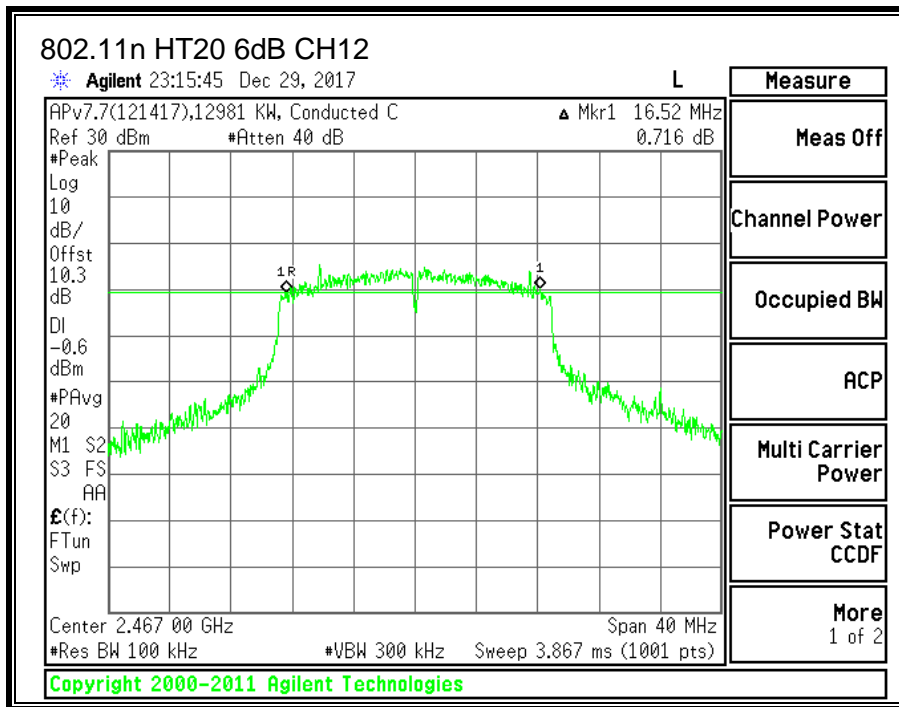
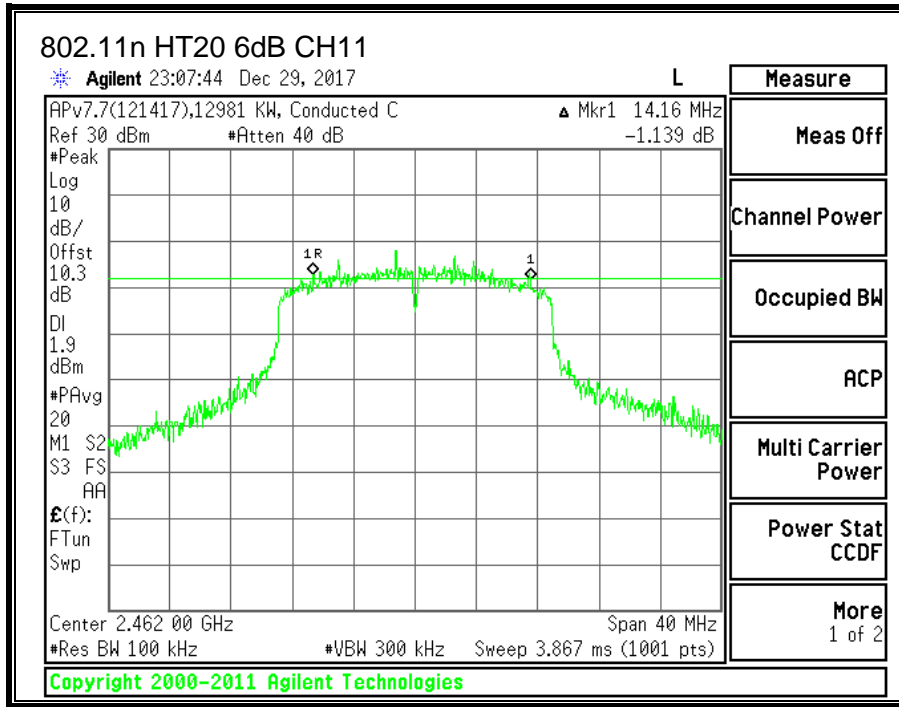

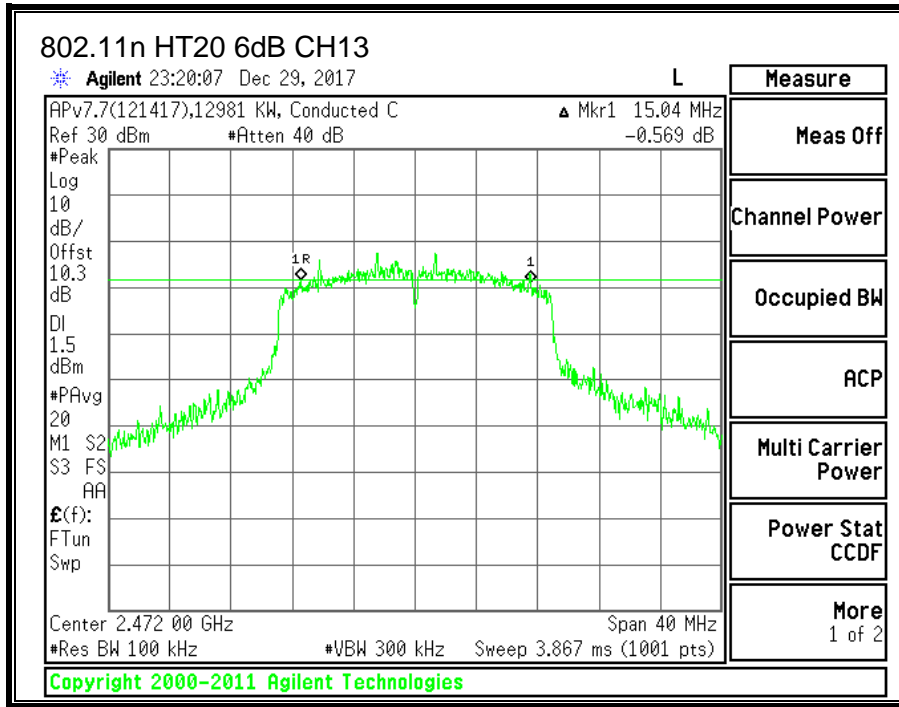

8.4.2. 99% BANDWIDTH

LIMITS

None; for reporting purposes only.

RESULTS

Channel	Frequency (MHz)	99% Bandwidth (MHz)
CH1	2412	17.4276
CH2	2417	17.6389
CH6	2437	17.5439
CH10	2457	17.4791
CH11	2462	17.5530
CH12	2467	17.5620
CH13	2472	17.5188

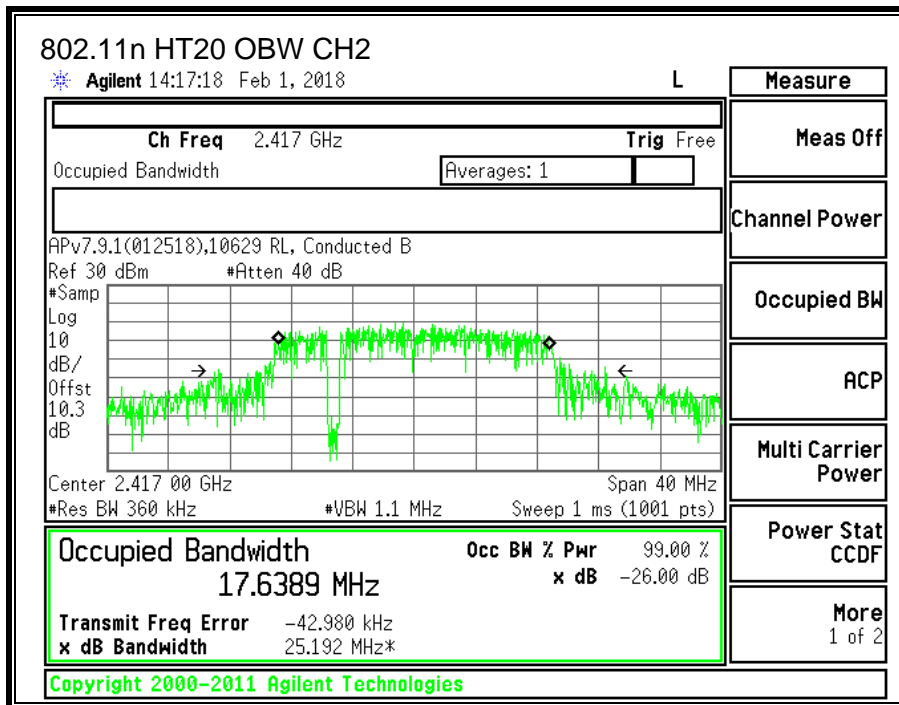
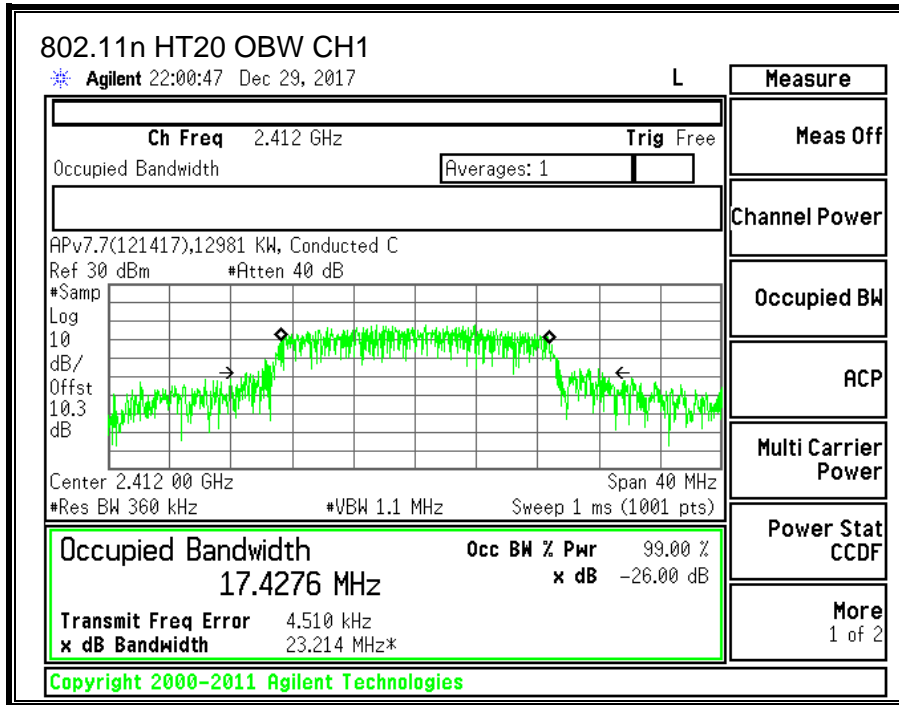

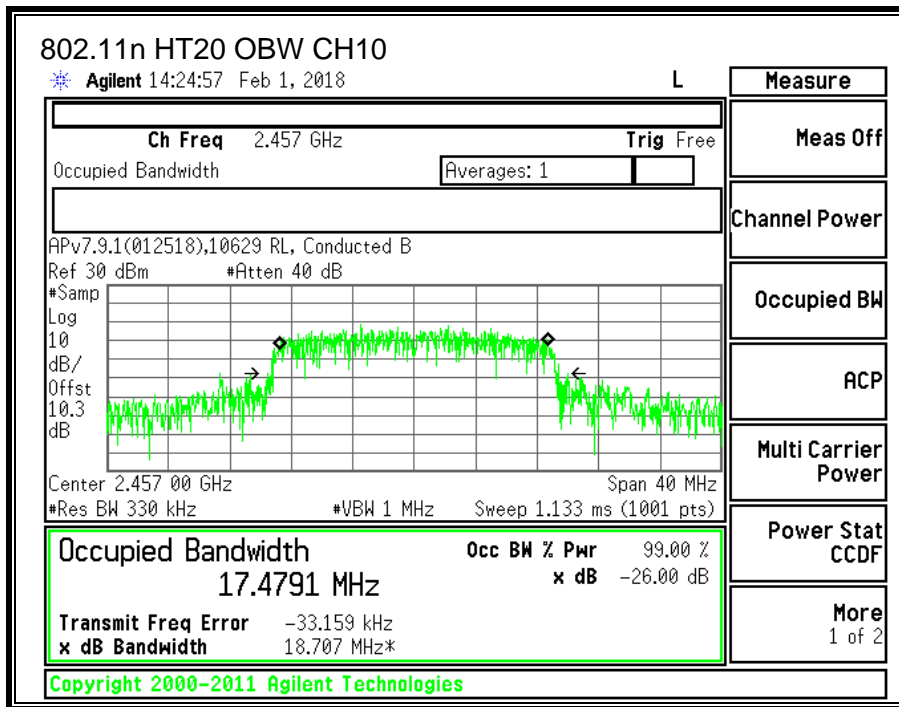
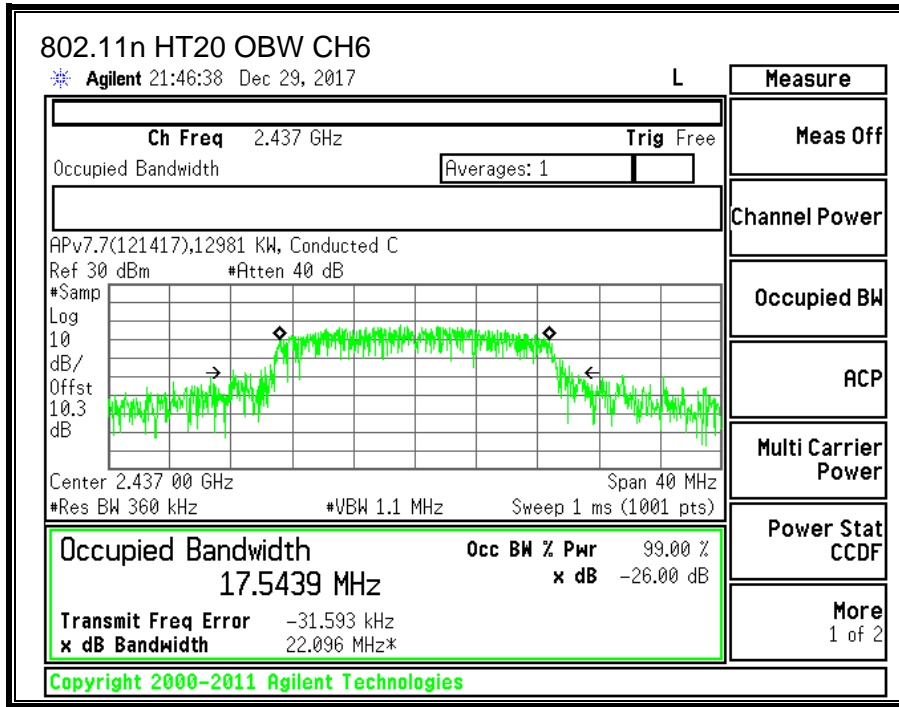

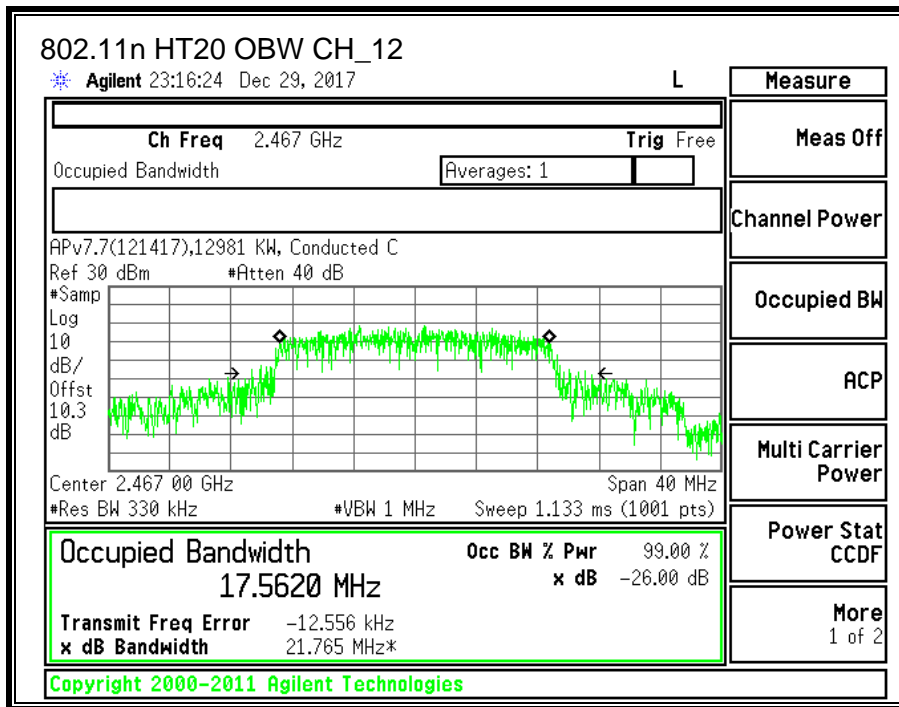
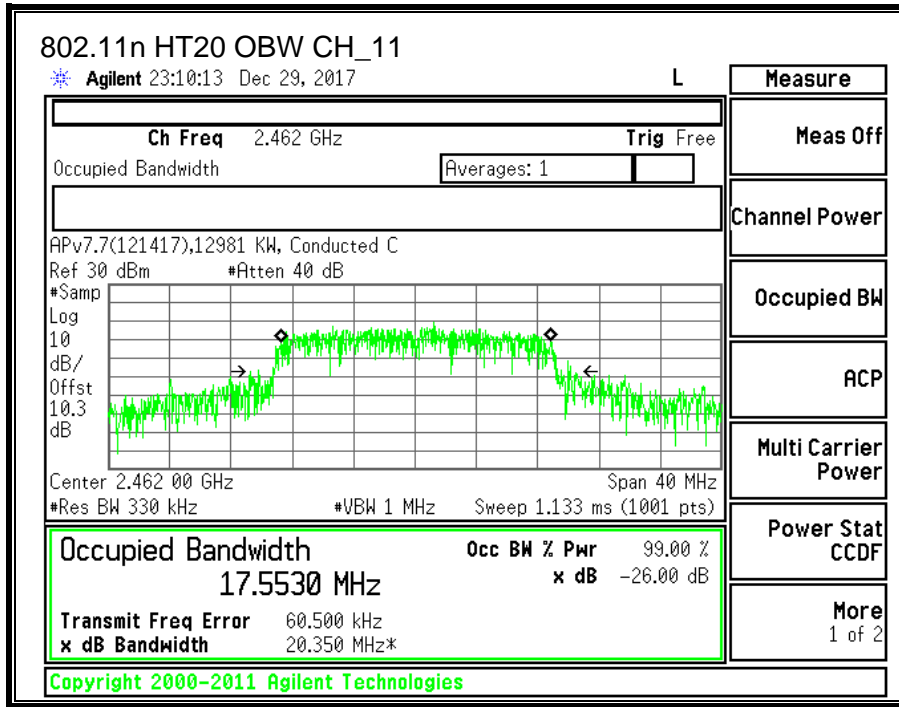

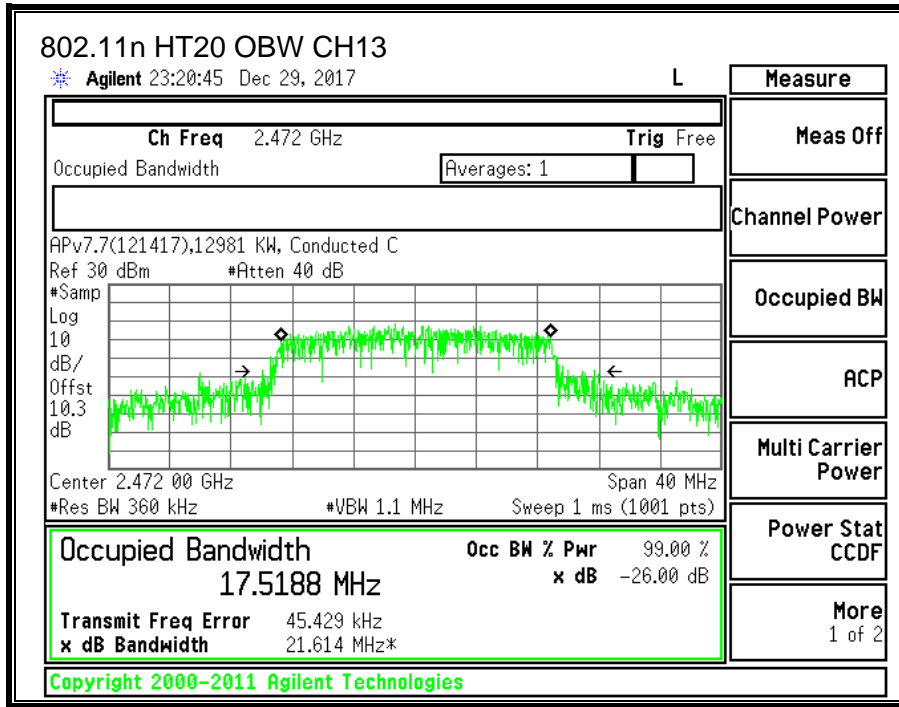

8.4.3. OUTPUT POWER

LIMITS

FCC §15.247

IC RSS-247 (5.4) (d)

The maximum antenna gain is less than or equal to 6 dBi, therefore the limit is 30 dBm.

DIRECTIONAL ANTENNA GAIN

There is only one transmitter output therefore the directional gain is equal to the antenna gain.

RESULTS

ID:	10629	Date:	02/01/18
------------	-------	--------------	----------

Limits

Channel	Frequency (MHz)	Directional Gain (dBi)	FCC Power Limit (dBm)	IC Power Limit (dBm)	IC EIRP Limit (dBm)	Max Power (dBm)
CH1	2412	-11.30	30.00	30	36	30.00
CH2	2417	-11.30	30.00	30	36	30.00
CH6	2437	-11.30	30.00	30	36	30.00
CH10	2457	-11.30	30.00	30	36	30.00
CH11	2462	-11.30	30.00	30	36	30.00
CH12	2467	-11.30	30.00	30	36	30.00
CH13	2472	-11.30	30.00	30	36	30.00

Results

Channel	Frequency (MHz)	Measured Power (dBm)	Power Limit (dBm)	Margin (dB)
CH1	2412	16.79	30.00	-13.21
CH2	2417	18.83	30.00	-11.17
CH6	2437	18.9	30.00	-11.10
CH10	2457	17.64	30.00	-12.36
CH11	2462	15.84	30.00	-14.16
CH12	2467	13.93	30.00	-16.07
CH13	2472	1.33	30.00	-28.67

8.4.4. POWER SPECTRAL DENSITY

LIMITS

FCC §15.247

IC RSS-247 (5.2) (b)

The power spectral density conducted from the transmitter to the antenna shall not be greater than 8 dBm in any 3 kHz band during any time interval of continuous transmission.

RESULTS

Duty Cycle CF (dB)	0.00	Included in Calculations of Corr'd PSD
---------------------------	------	---

PSD Results

Channel	Frequency (MHz)	Measured (dBm)	Corr'd PSD (dBm)	Limit (dBm)	Margin (dB)
CH1	2412	-7.070	-7.070	8.0	-15.1
CH2	2417	-4.898	-4.898	8.0	-12.9
CH6	2437	-5.240	-5.240	8.0	-13.2
CH10	2457	-6.256	-6.256	8.0	-14.3
CH11	2462	-8.018	-8.018	8.0	-16.0
CH12	2467	-10.025	-10.025	8.0	-18.0
CH13	2472	-22.698	-22.698	8.0	-30.7

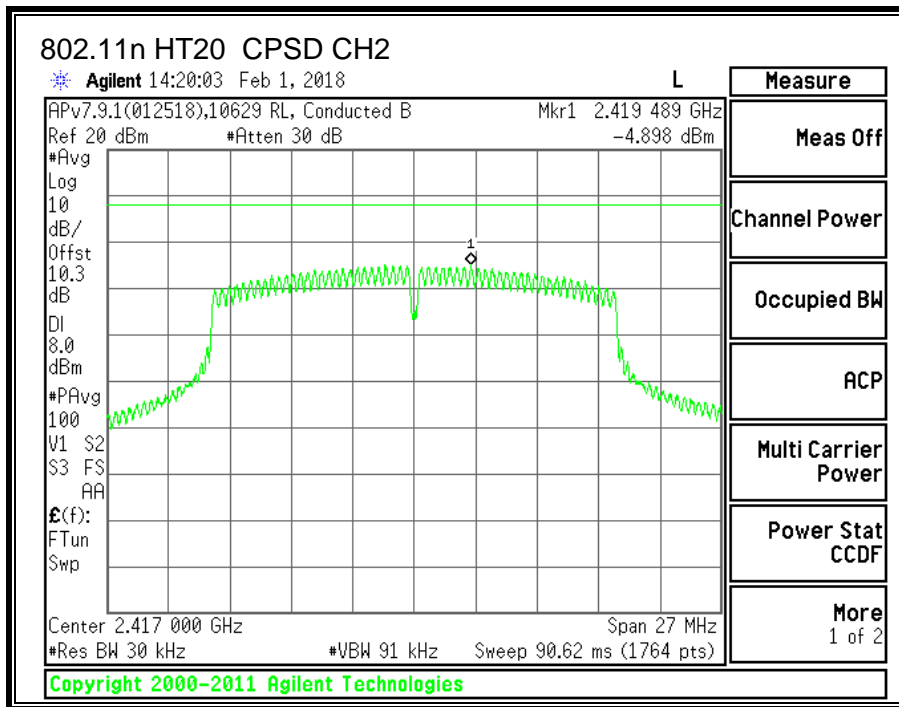
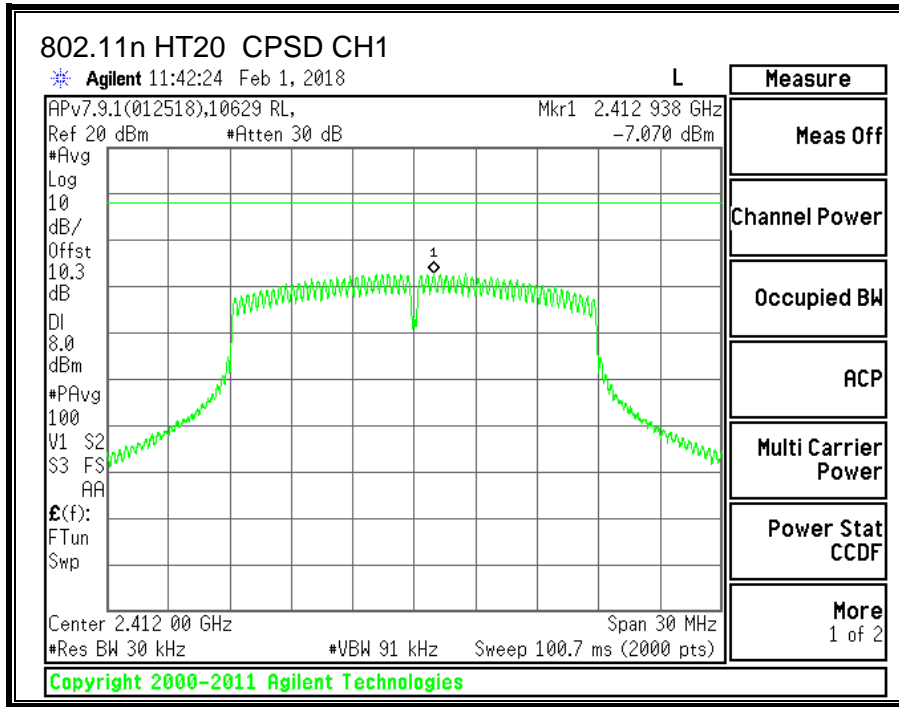

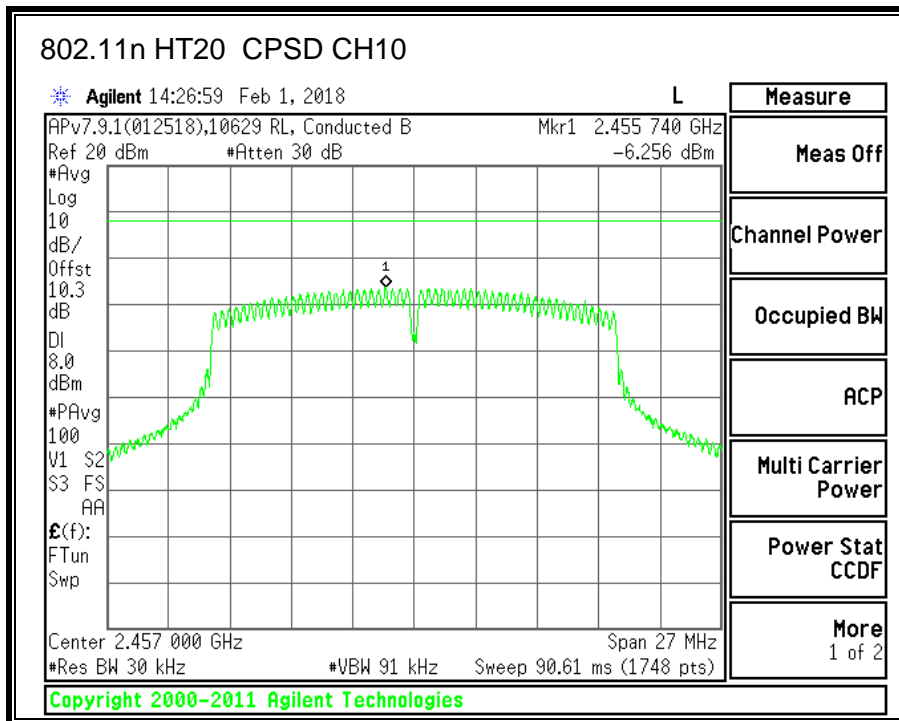
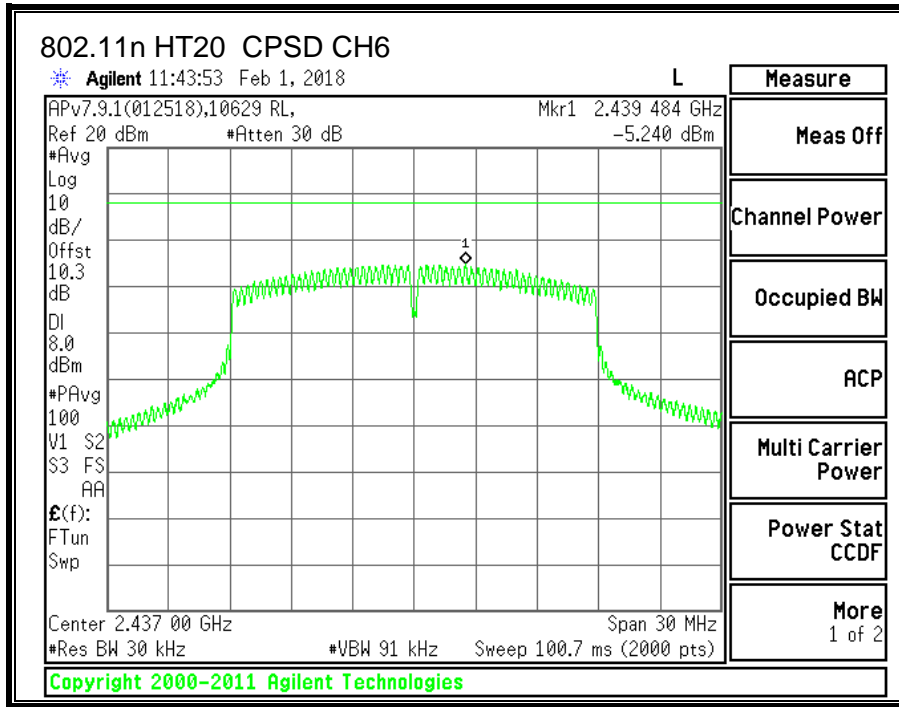

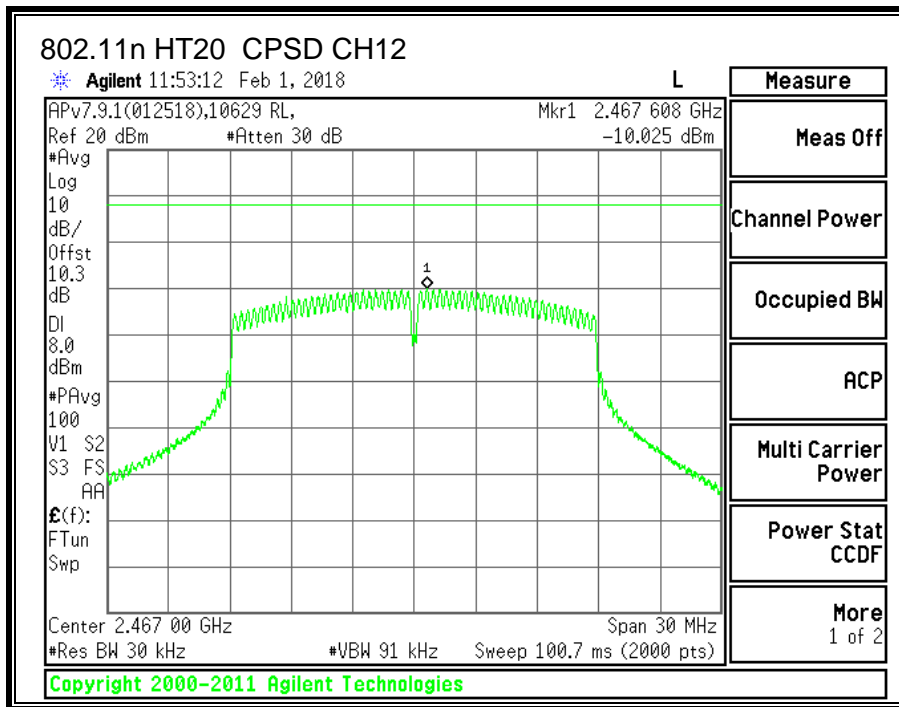
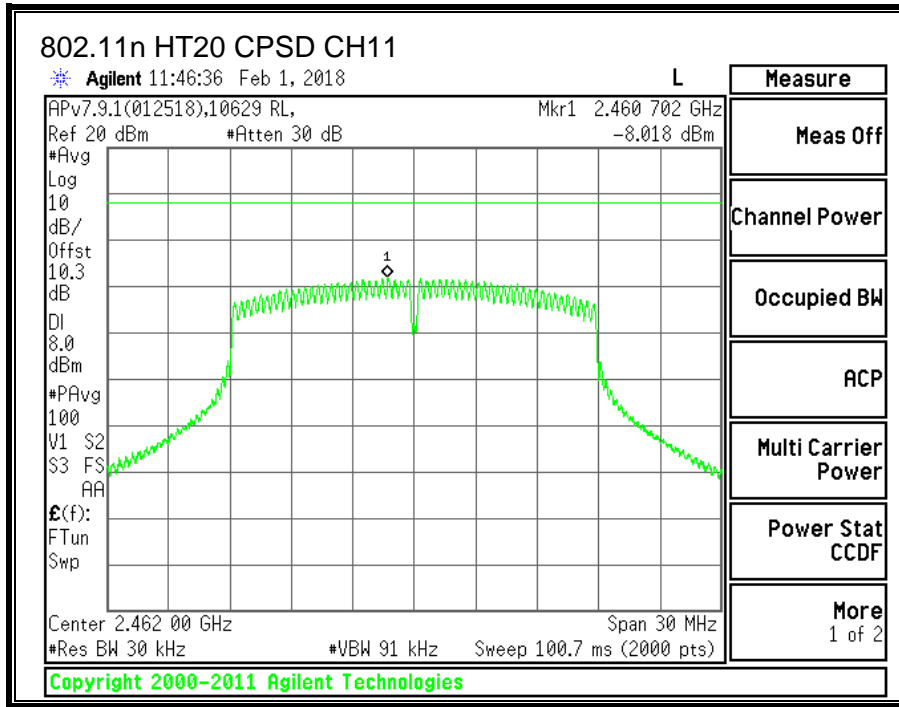

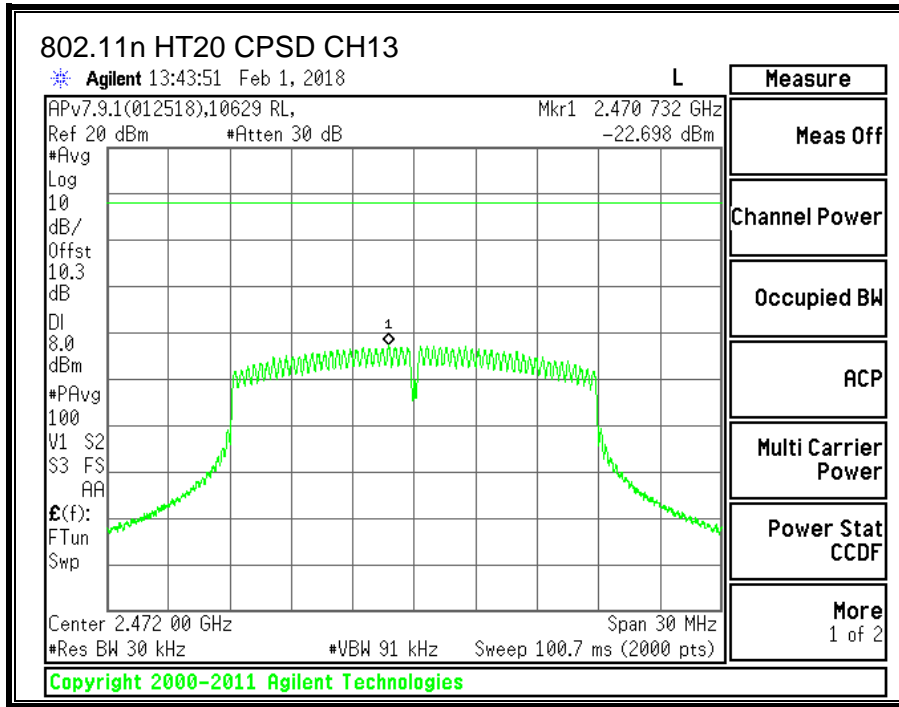

8.4.5. CONDUCTED BANDEDGE AND SPURIOUS EMISSIONS

LIMITS

FCC §15.247 (d)

IC RSS-247 (5.5)

In any 100 kHz bandwidth outside the frequency band in which the spread spectrum or digitally modulated intentional radiator is operating, the radio frequency power that is produced by the intentional radiator shall be at least 20 dB below that in the 100 kHz bandwidth within the band that contains the highest level of the desired power, based on either an RF conducted or a radiated measurement, provided the transmitter demonstrates compliance with the peak conducted power limits. If the transmitter complies with the conducted power limits based on the use of RMS averaging over a time interval, as permitted under paragraph (b)(3) of this section, the attenuation required under this paragraph shall be 30 dB instead of 20 dB. Attenuation below the general limits specified in §15.209(a) is not required.

RESULTS

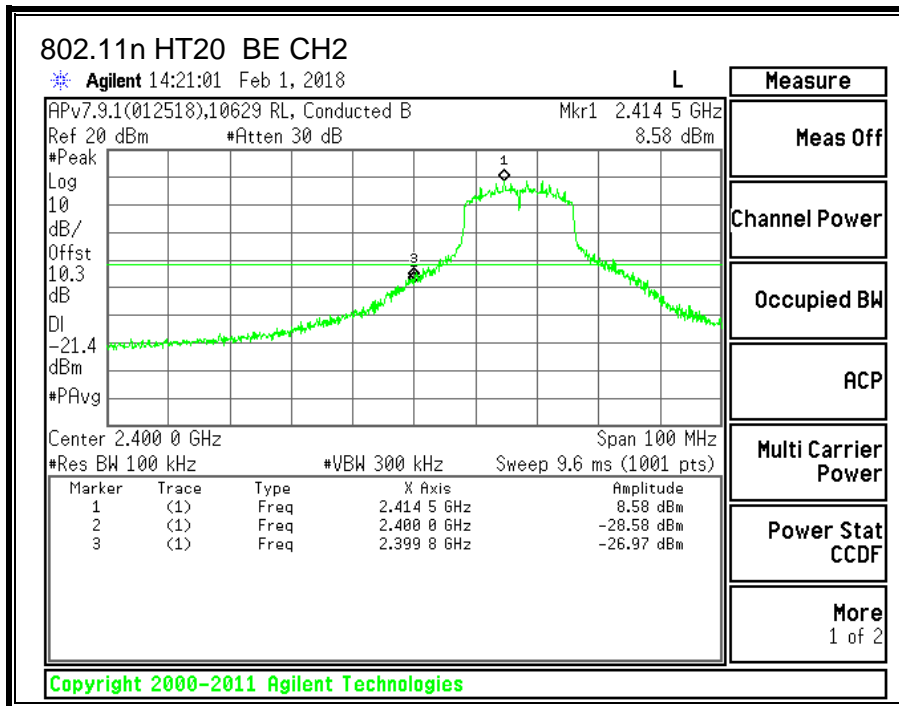
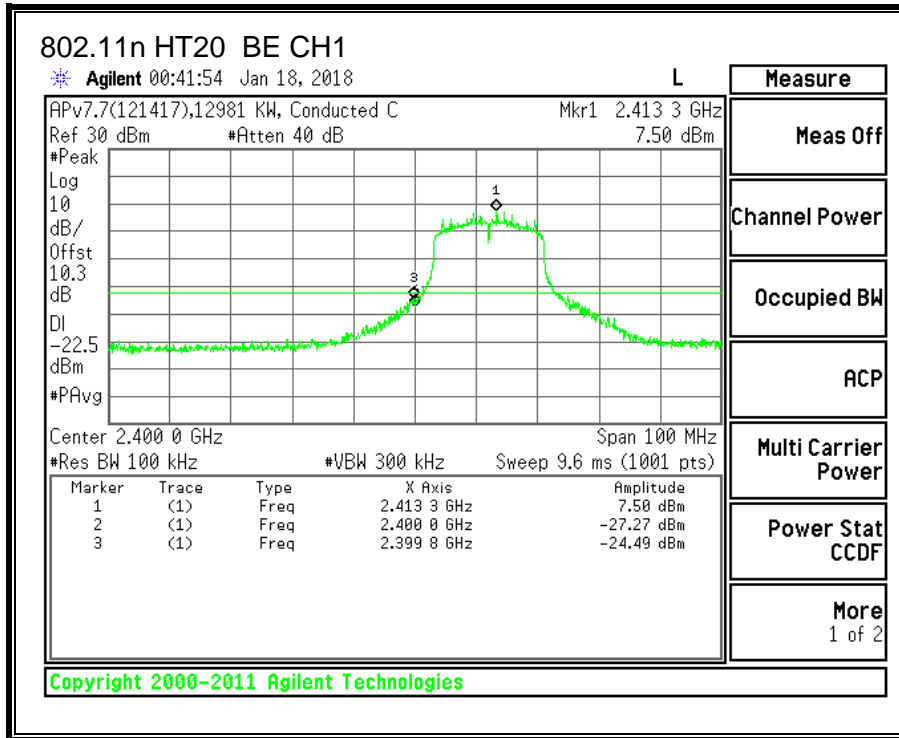

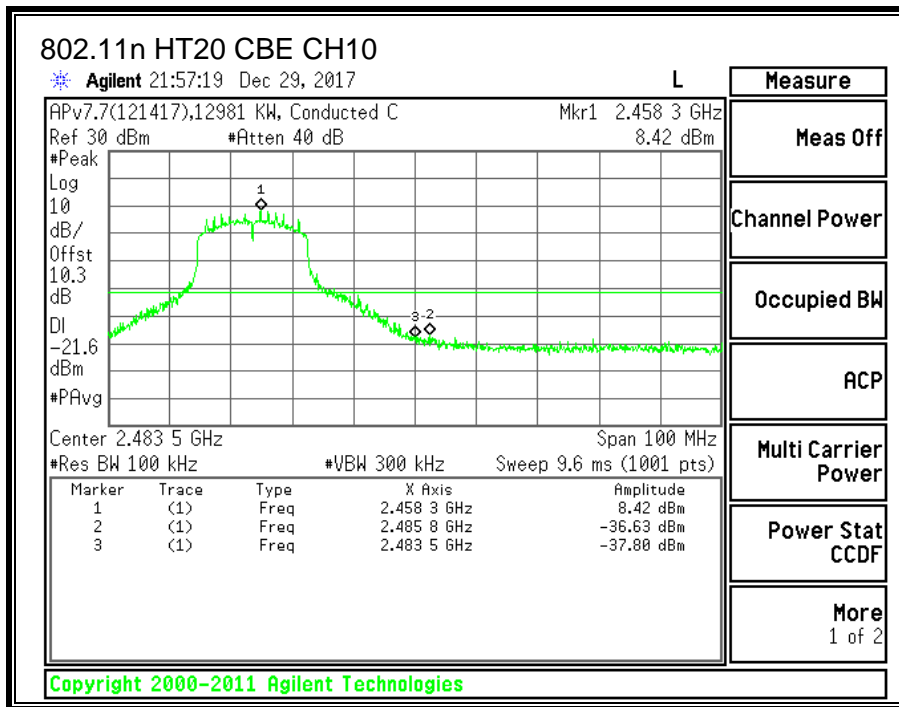
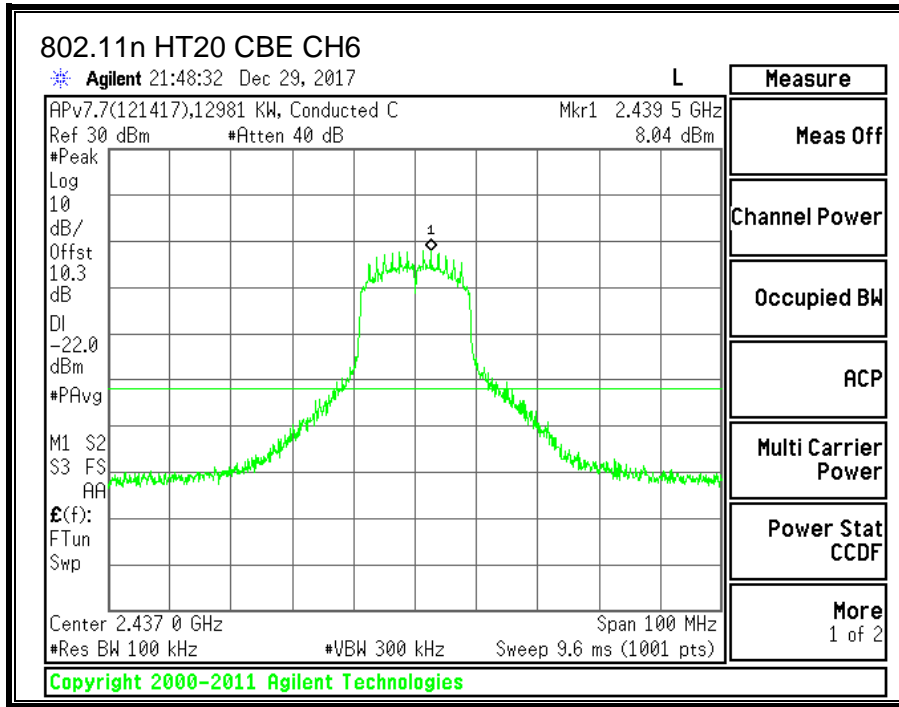

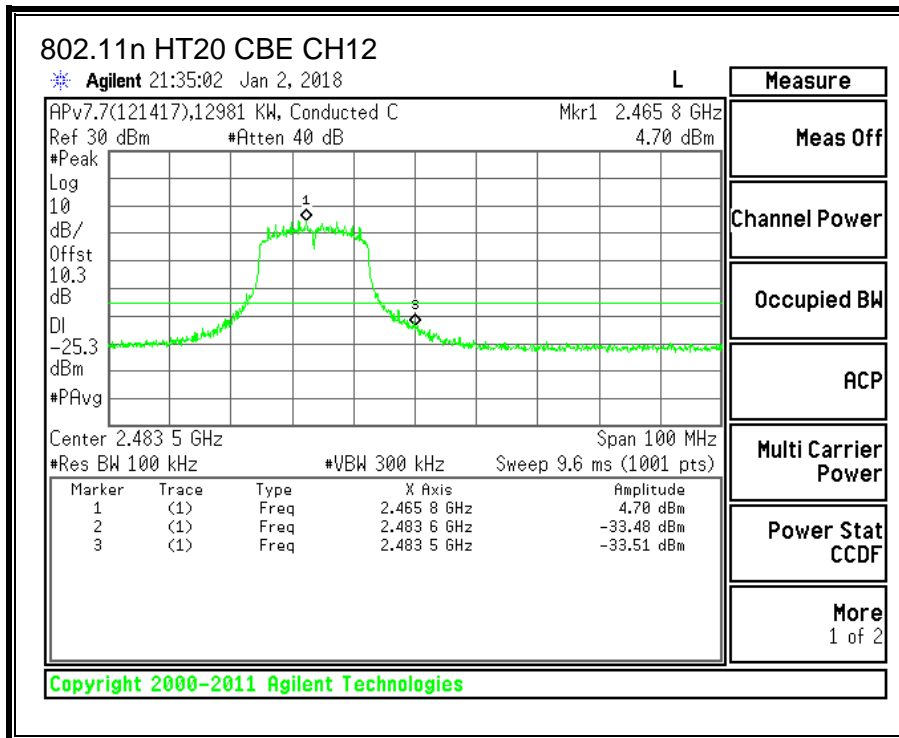
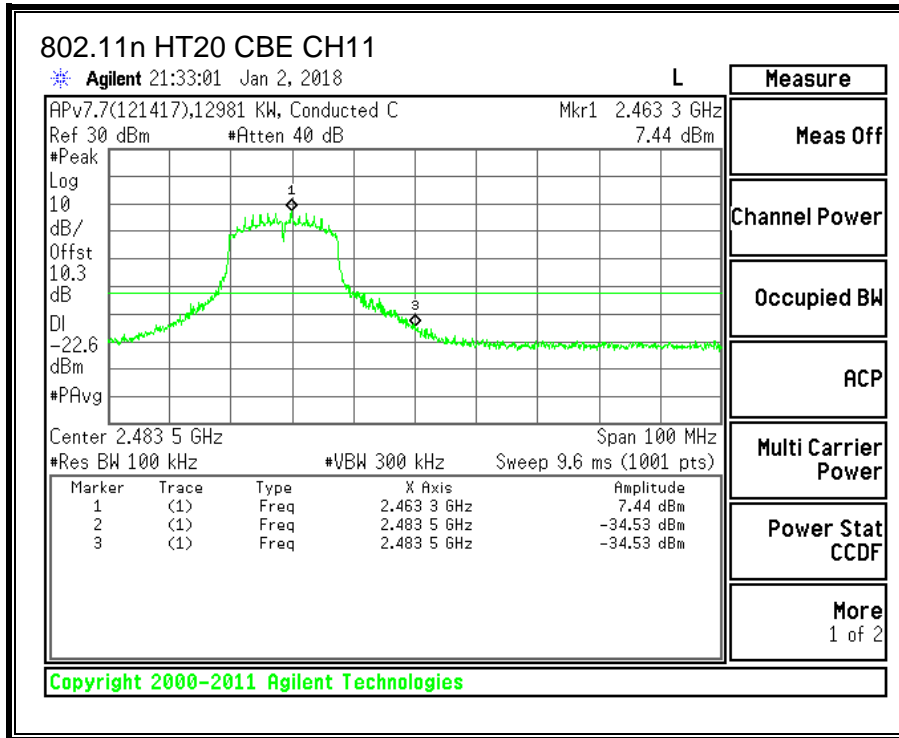

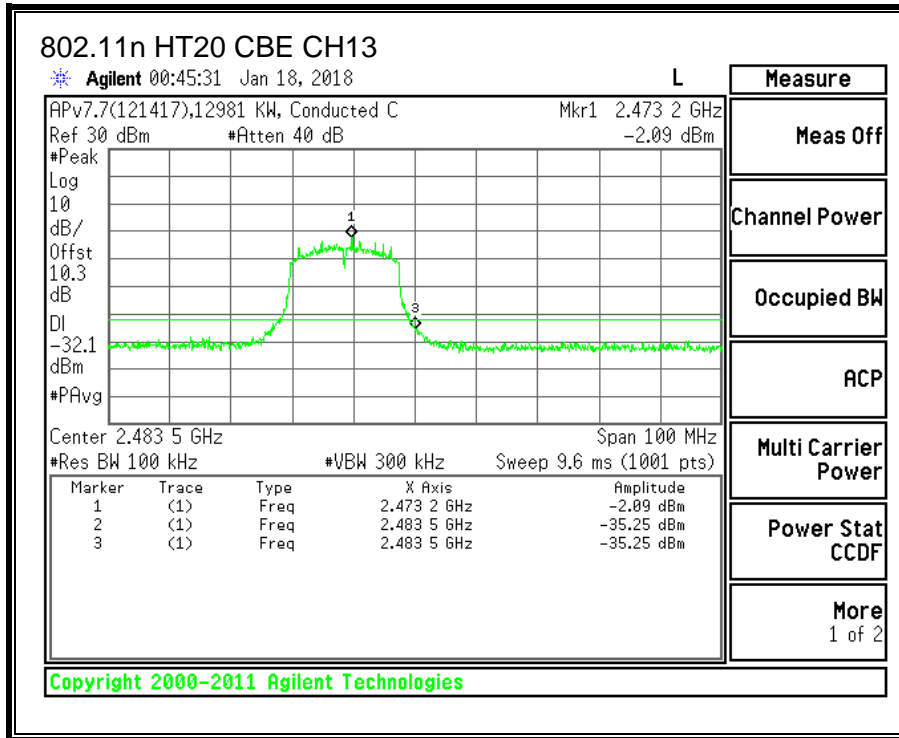

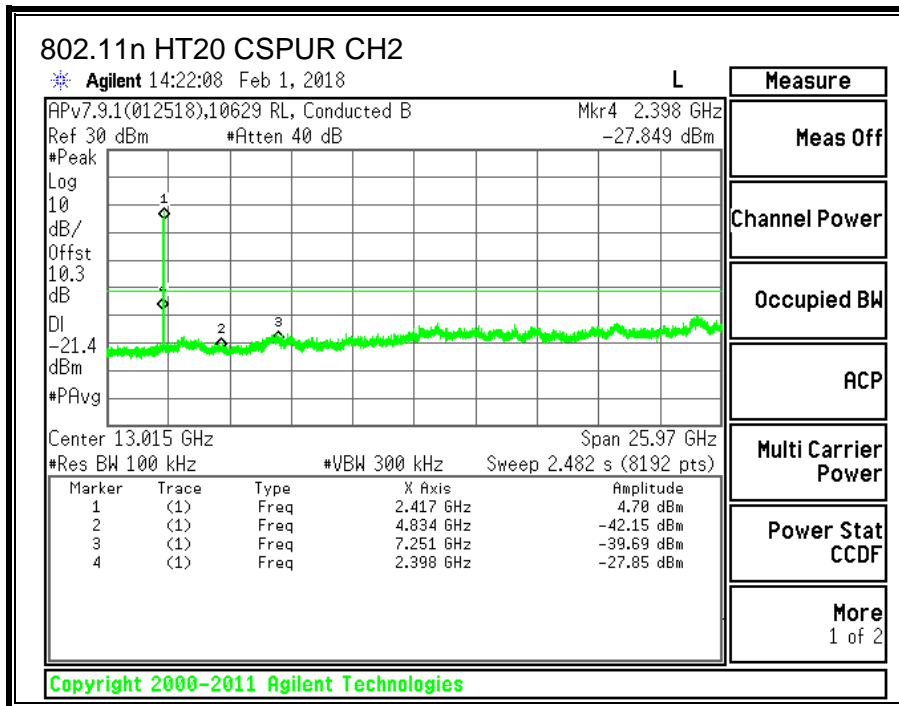
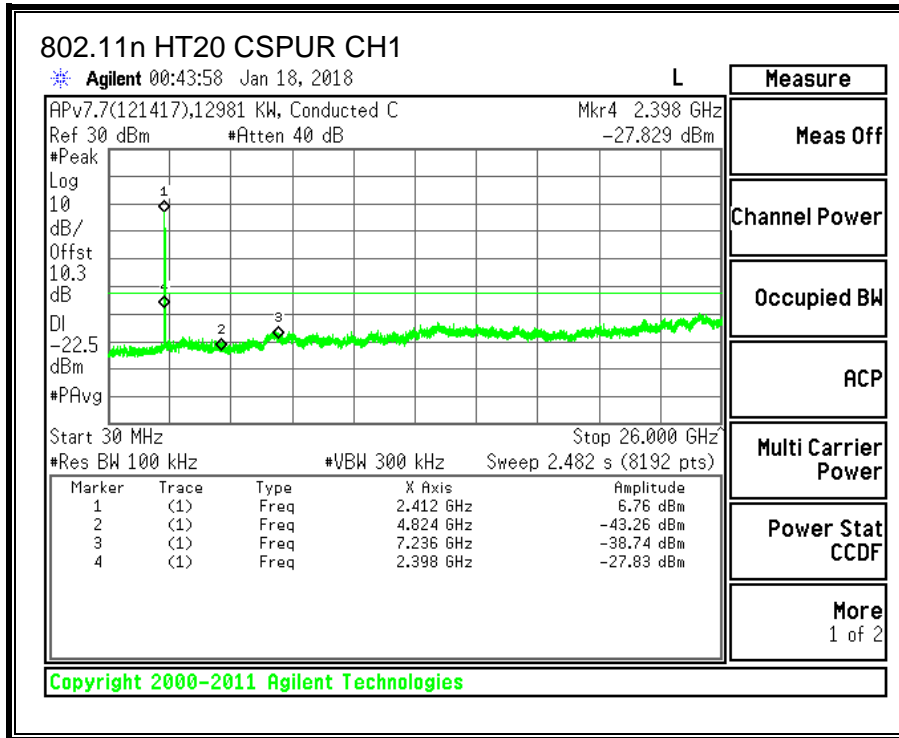

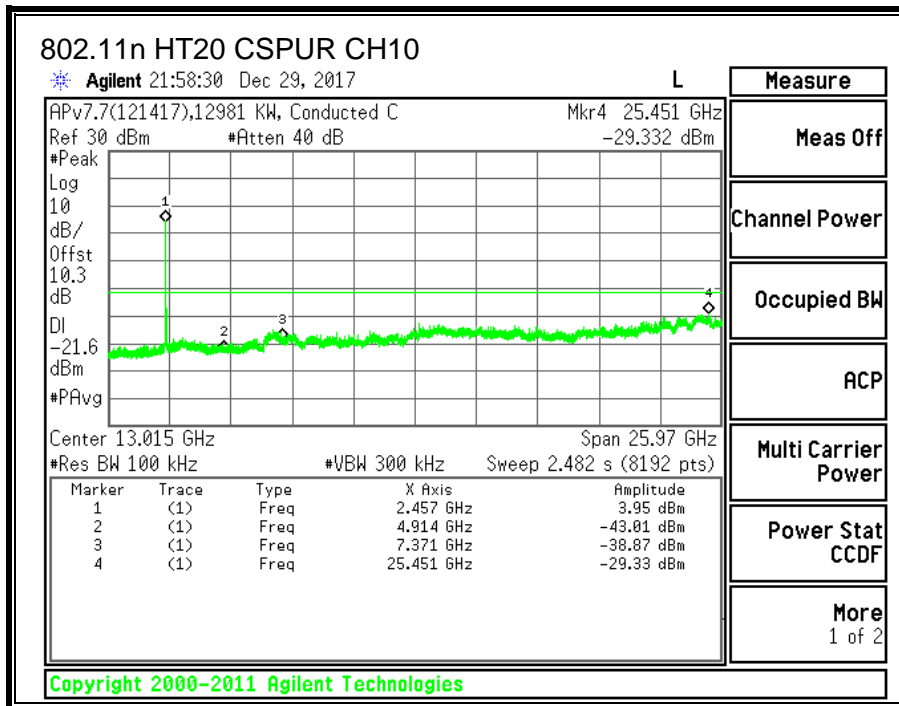
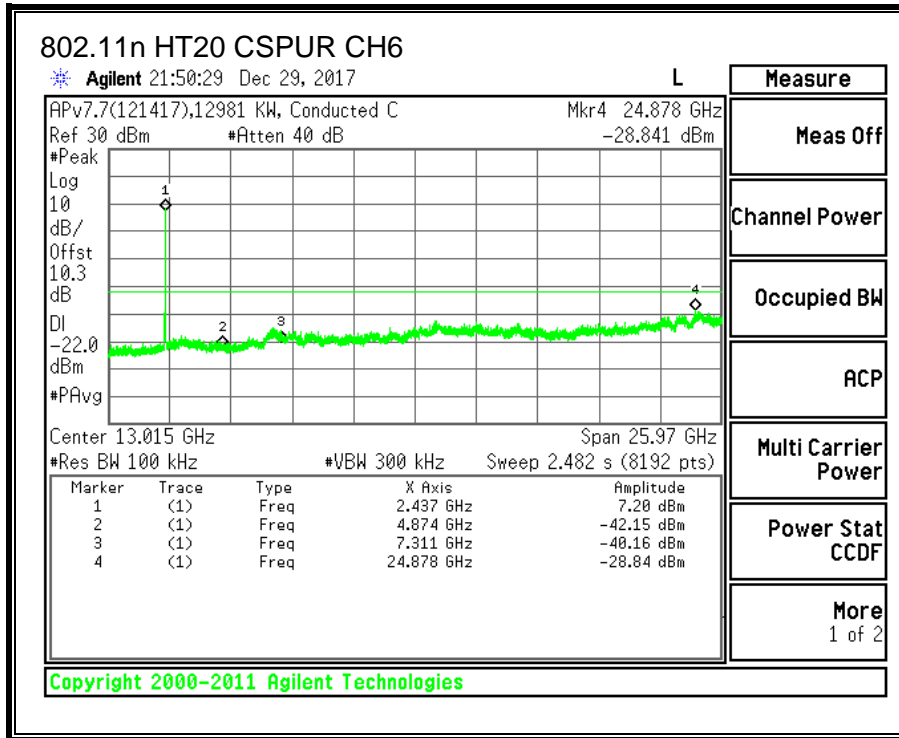

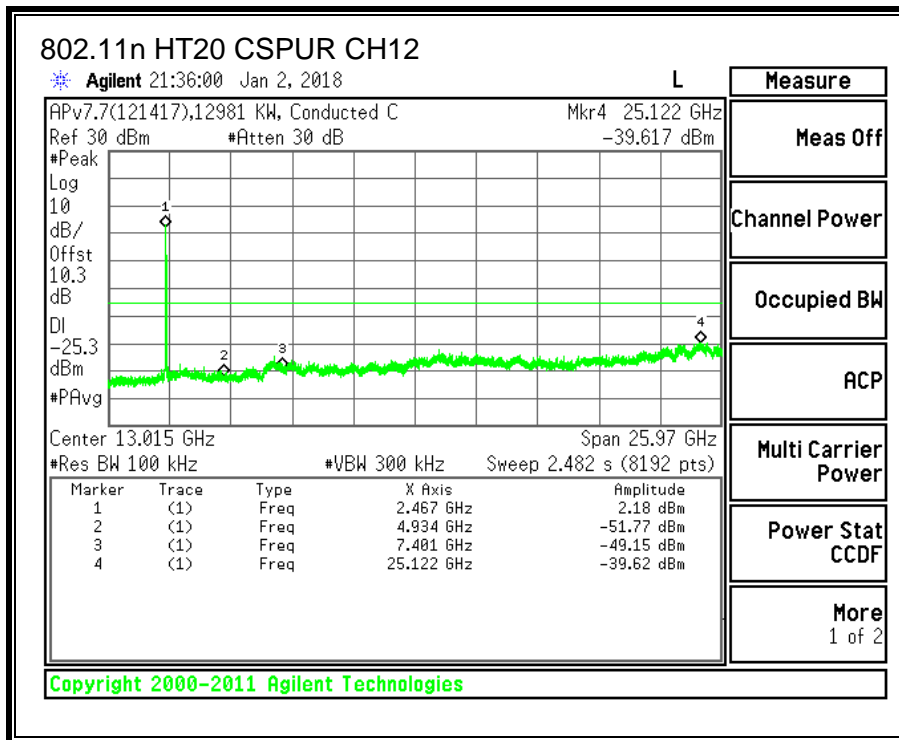
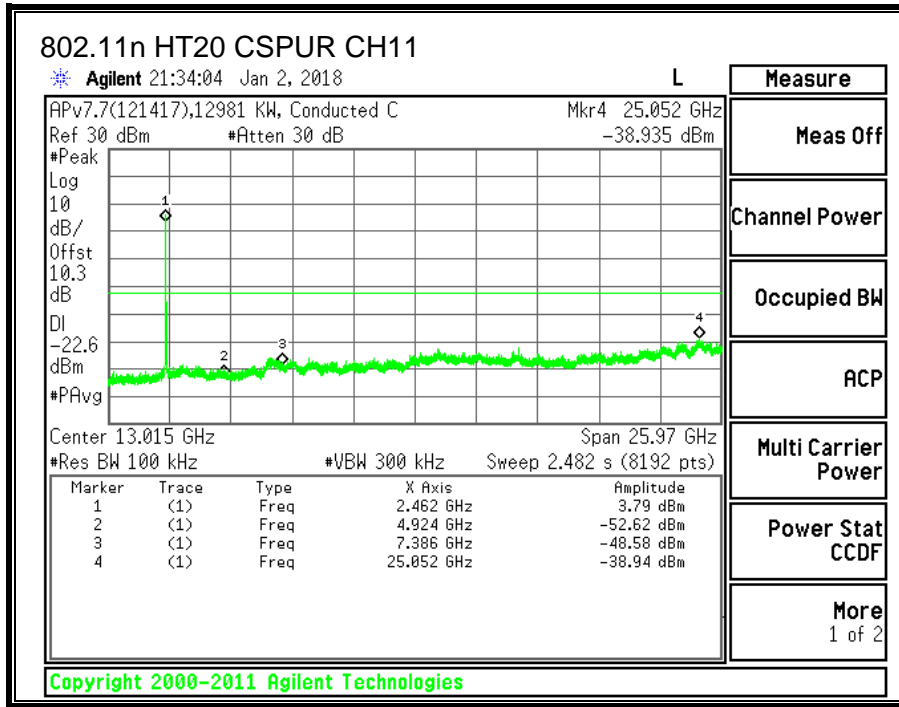

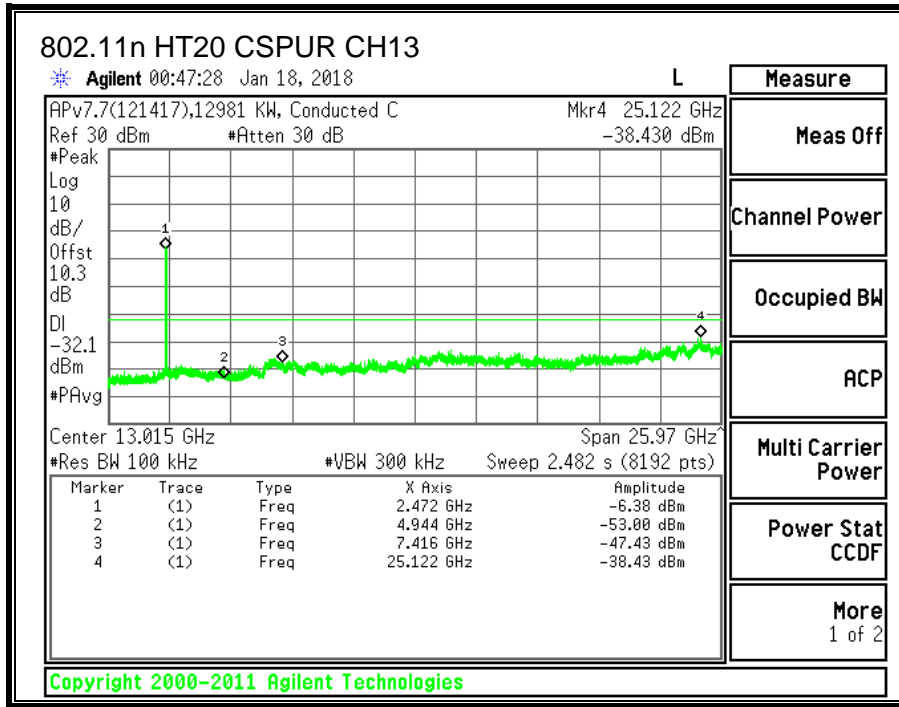

9. RADIATED TEST RESULTS

9.1. LIMITS AND PROCEDURE

LIMITS

FCC §15.205 and §15.209

IC RSS-GEN, Section 8.9 and 8.10.

Frequency Range (MHz)	Field Strength Limit (uV/m) at 3 m	Field Strength Limit (dBuV/m) at 3 m
0.009-0.490	2400/F(kHz) @ 300m	2400/F(kHz) @ 300m
0.490-1.705	24000/F(kHz) @ 30m	24000/F(kHz) @ 30m
1.705-30.0	30 @ 30m	30 @ 30m
30 - 88	100	40
88 - 216	150	43.5
216 - 960	200	46
Above 960	500	54

TEST PROCEDURE

The EUT is placed on a non-conducting table 80 cm above the ground plane for measurement below 1GHz; 1.5 m above the ground plane for measurement above 1GHz. The antenna to EUT distance is 3 meters. The EUT is configured in accordance with ANSI C63.10. The EUT is set to transmit in a continuous mode.

For measurements below 1 GHz the resolution bandwidth is set to 100 kHz for peak detection measurements or 120 kHz for quasi-peak detection measurements. Peak detection is used unless otherwise noted as quasi-peak.

For pre-scans above 1 GHz the resolution bandwidth is set to 1 MHz; the video bandwidth is set to 30 KHz for peak measurements.

For final measurements above 1 GHz the resolution bandwidth is set to 1 MHz; the video bandwidth is set to 3 MHz for peak measurements and as applicable for average measurements.

The spectrum from 1 GHz to 18 GHz is investigated with the transmitter set to the lowest, middle, and highest channels in each applicable band. Below 1GHz and above 18GHz emissions, the channel with the highest output power was tested.

The frequency range of interest is monitored at a fixed antenna height and EUT azimuth. The EUT is rotated through 360 degrees to maximize emissions received. The antenna is scanned from 1 to 4 meters above the ground plane to further maximize the emission. Measurements are made with the antenna polarized in both the vertical and the horizontal positions.

9.2. TRANSMITTER ABOVE 1 GHz

9.2.1. 802.11b MODE IN THE 2.4 GHz BAND

AUTHORIZED BANDEDGE (LOW CHANNEL, CH 1)

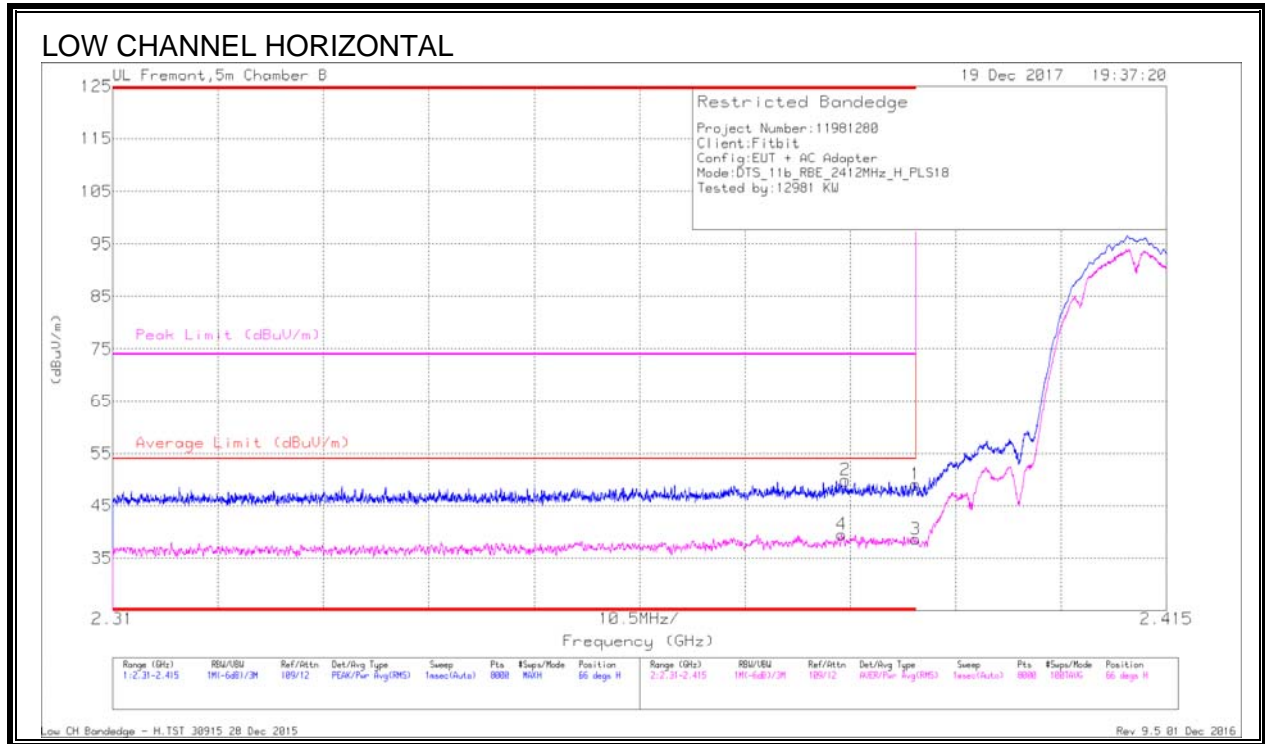

DATA

Marker	Frequency (GHz)	Meter Reading (dBuV)	Det	AF 1863 (dB/m)	Amp/Ch/Ftr/Pad (dB)	DC Corr (dB)	Corrected Reading (dBuV/m)	Average Limit (dBuV/m)	Margin (dB)	Peak Limit (dBuV/m)	PK Margin (dB)	Azimuth (Degs)	Height (cm)	Polarity
2	* 2.383	39.06	Pk	32	-21.2	0	49.86	-	-	74	-24.14	66	224	H
4	* 2.383	28.71	RMS	32	-21.2	0	39.51	54	-14.49	-	-	66	224	H
1	* 2.39	38.39	Pk	32	-21.3	0	49.09	-	-	74	-24.91	66	224	H
3	* 2.39	27.91	RMS	32	-21.3	0	38.61	54	-15.39	-	-	66	224	H

* - indicates frequency in CFR47 Pt 15 / IC RSS-Restricted Band

Pk - Peak detector

RMS - RMS detection

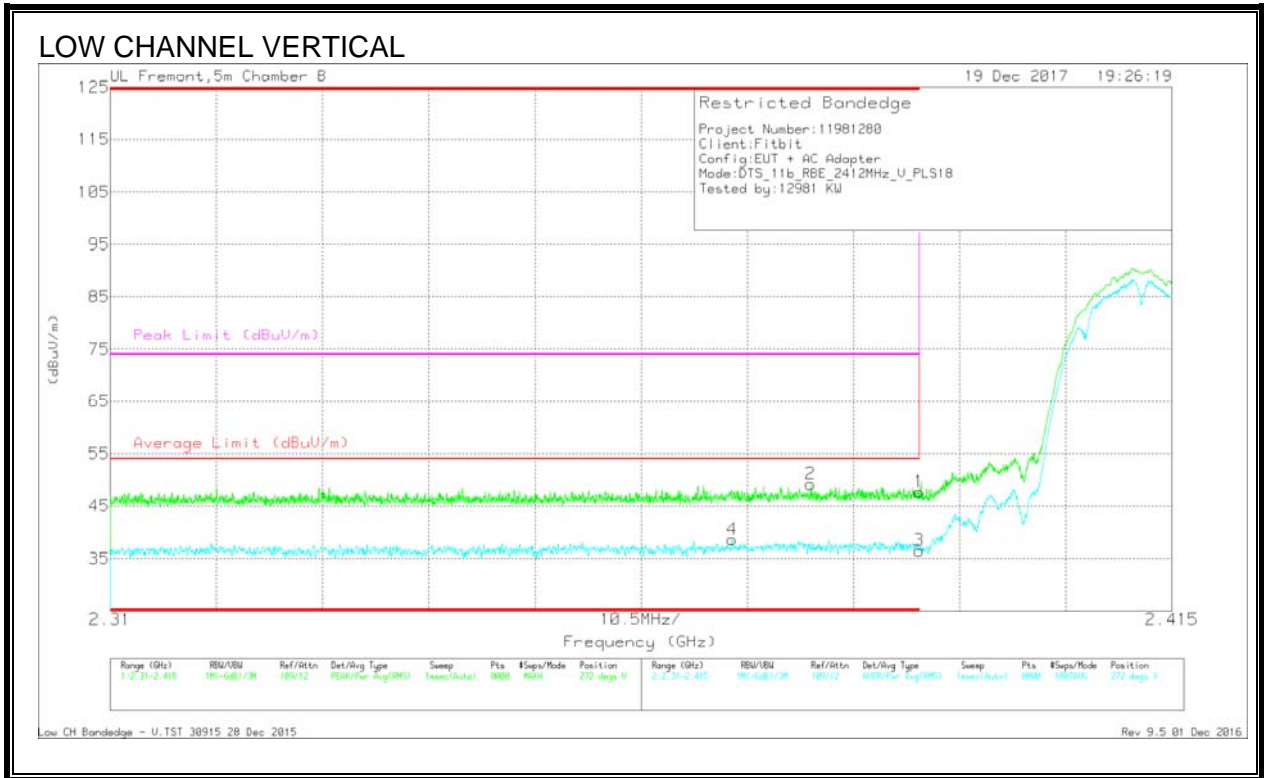

DATA

Marker	Frequency (GHz)	Meter Reading (dBuV)	Det	AF T863 (dB/m)	Amp/Ch/Flt/Pad (dB)	DC Corr (dB)	Corrected Reading (dBuV/m)	Average Limit (dBuV/m)	Margin (dB)	Peak Limit (dBuV/m)	PK Margin (dB)	Azimuth (Degs)	Height (cm)	Polarity
4	* 2.372	27.99	RMS	31.9	-21.3	0	38.59	54	-15.41	-	-	272	154	V
2	* 2.379	38.59	Pk	31.9	-21.3	0	49.19	-	-	74	-24.81	272	154	V
1	* 2.39	37.04	Pk	32	-21.3	0	47.74	-	-	74	-26.26	272	154	V
3	* 2.39	25.8	RMS	32	-21.3	0	36.5	54	-17.5	-	-	272	154	V

* - indicates frequency in CFR47 Pt 15 / IC RSS-Restricted Band

Pk - Peak detector

RMS - RMS detection

AUTHORIZED BANDEGE (HIGH CHANNEL, CH 11)

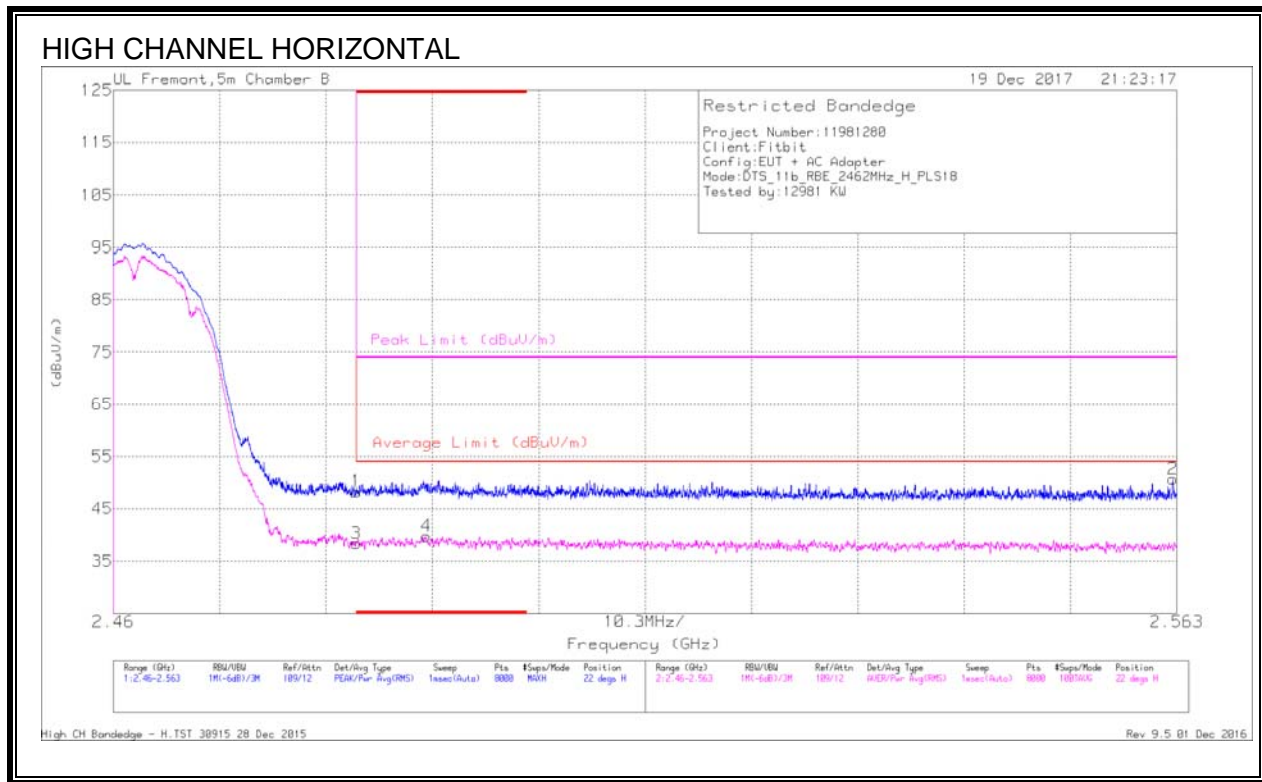

DATA

Marker	Frequency (GHz)	Meter Reading (dBuV)	Det	AF T863 (dB/m)	Amp/Ch/Filt/Pad (dB)	DC Corr (dB)	Corrected Reading (dBuV/m)	Average Limit (dBuV/m)	Margin (dB)	Peak Limit (dBuV/m)	PK Margin (dB)	Azimuth (Degs)	Height (cm)	Polarity
1	* 2.484	37.15	Pk	32.5	-21.3	0	48.35	-	-	74	-25.65	22	145	H
3	* 2.484	27.22	RMS	32.5	-21.3	0	38.42	54	-15.58	-	-	22	145	H
4	* 2.49	28.51	RMS	32.5	-21.3	0	39.71	54	-14.29	-	-	22	145	H
2	2.563	39.25	Pk	32.5	-21.1	0	50.65	-	-	74	-23.35	22	145	H

* - indicates frequency in CFR47 Pt 15 / IC RSS-Restricted Band

Pk - Peak detector

RMS - RMS detection

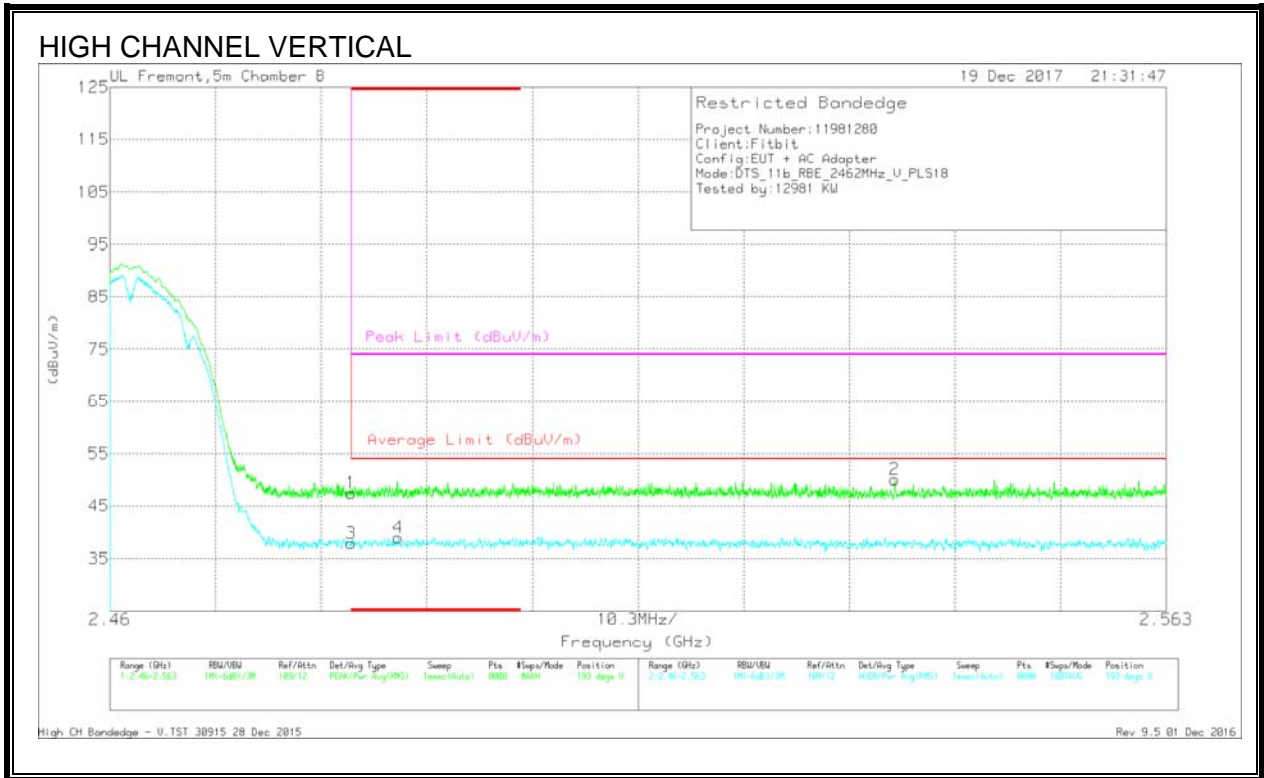

DATA

Marker	Frequency (GHz)	Meter Reading (dBuV)	Det	AF 1863 (dB/m)	Amp/Cbl/Ftr/Pad (dB)	DC Corr (dB)	Corrected Reading (dBuV/m)	Average Limit (dBuV/m)	Margin (dB)	Peak Limit (dBuV/m)	PK Margin (dB)	Azimuth (Degs)	Height (cm)	Polarity
1	* 2.484	36.22	Pk	32.5	-21.3	0	47.42	-	-	74	-26.58	193	116	V
3	* 2.484	26.66	RMS	32.5	-21.3	0	37.86	54	-16.14	-	-	193	116	V
4	* 2.488	27.85	RMS	32.5	-21.3	0	39.05	54	-14.95	-	-	193	116	V
2	2.537	38.71	Pk	32.5	-21.2	0	50.01	-	-	74	-23.99	193	116	V

* - indicates frequency in CFR47 Pt 15 / IC RSS-Restricted Band
 Pk - Peak detector
 RMS - RMS detection

AUTHORIZED BANDEGE (HIGH CHANNEL, CH 12)

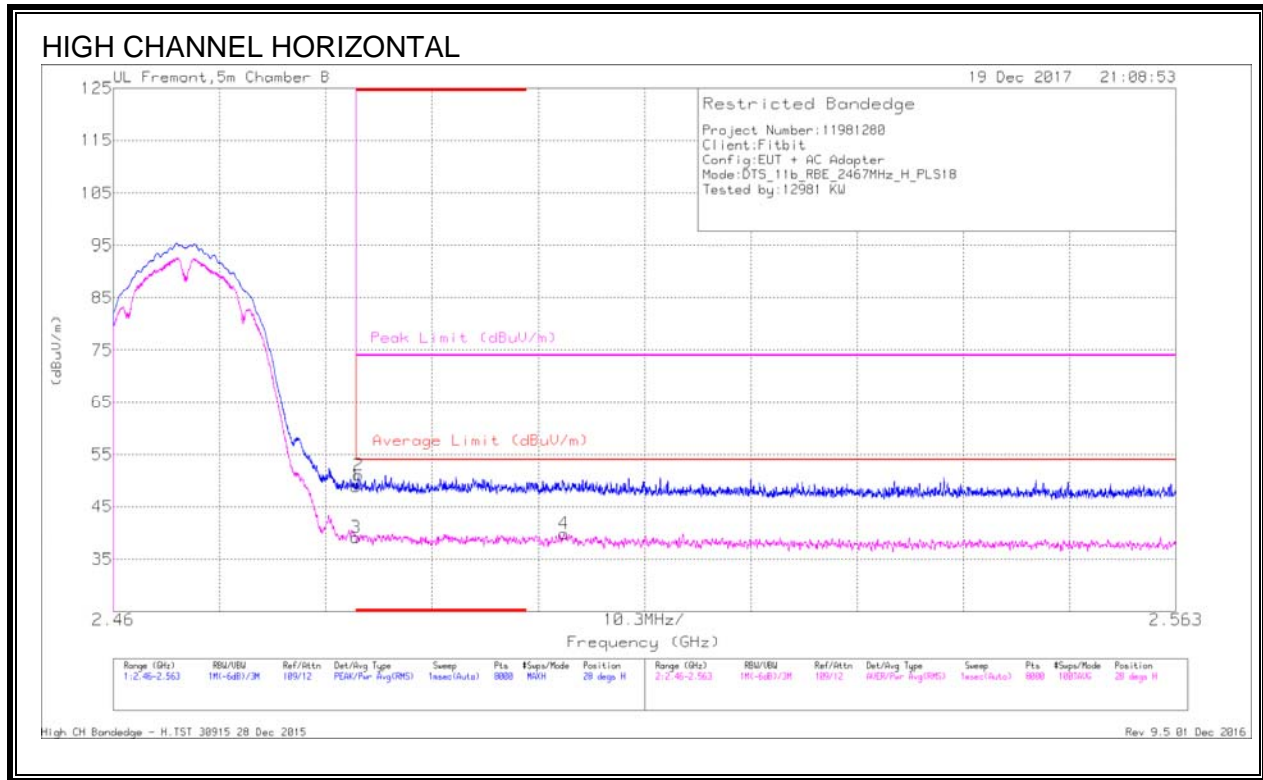

DATA

Marker	Frequency (GHz)	Meter Reading (dBuV)	Det	AF T863 (dB/m)	Amp/Ch/Filt/Pad (dB)	DC Corr (dB)	Corrected Reading (dBuV/m)	Average Limit (dBuV/m)	Margin (dB)	Peak Limit (dBuV/m)	PK Margin (dB)	Azimuth (Degs)	Height (cm)	Polarity
1	* 2.484	37.71	Pk	32.5	-21.3	0	48.91	-	-	74	-25.09	28	217	H
2	* 2.484	39.81	Pk	32.5	-21.3	0	51.01	-	-	74	-22.99	28	217	H
3	* 2.484	27.87	RMS	32.5	-21.3	0	39.07	54	-14.93	-	-	28	217	H
4	2.504	28.36	RMS	32.6	-21.1	0	39.86	54	-14.14	-	-	28	217	H

* - indicates frequency in CFR47 Pt 15 / IC RSS-Restricted Band

Pk - Peak detector

RMS - RMS detection

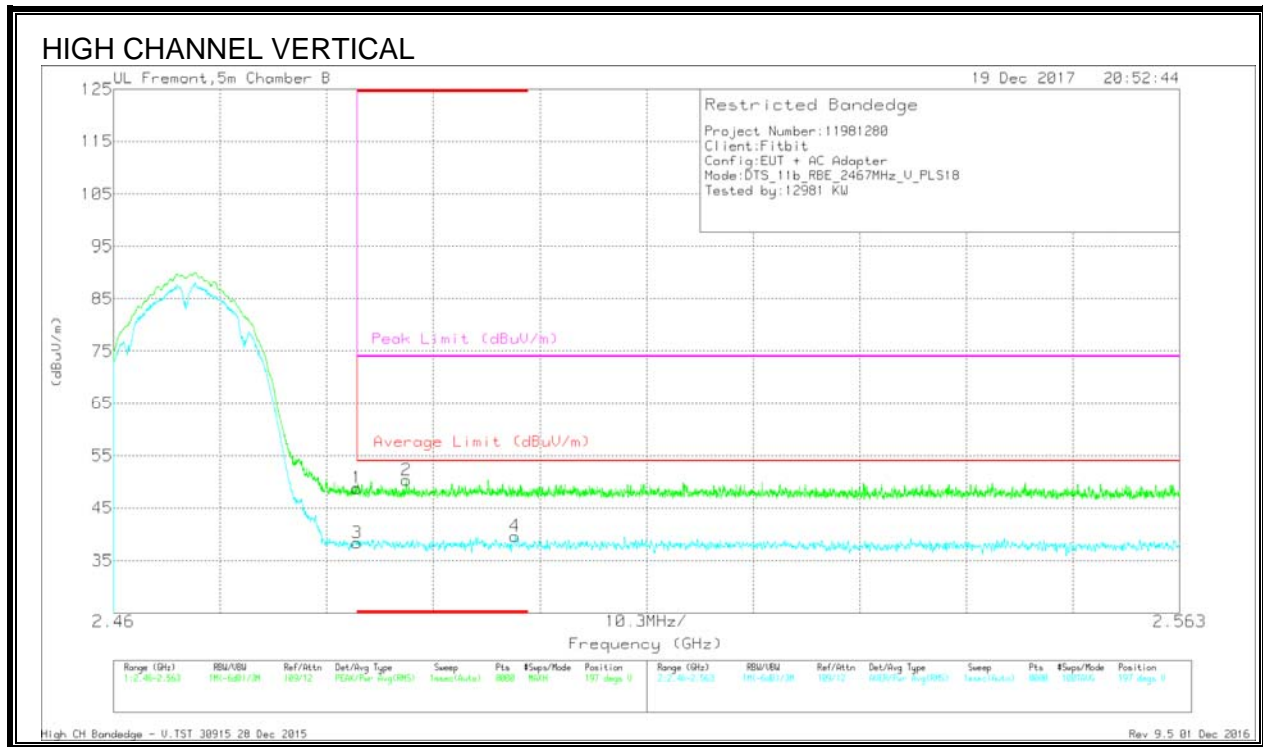

DATA

Marker	Frequency (GHz)	Meter Reading (dBuV)	Det	AF 1863 (dB/m)	Amp/Cbl/Ftr/Pad (dB)	DC Corr (dB)	Corrected Reading (dBuV/m)	Average Limit (dBuV/m)	Margin (dB)	Peak Limit (dBuV/m)	PK Margin (dB)	Asimuth (Degs)	Height (cm)	Polarity
1	* 2.484	37.55	Pk	32.5	-21.3	0	48.75	-	-	74	-25.25	197	128	V
3	* 2.484	27.18	RMS	32.5	-21.3	0	38.38	54	-15.62	-	-	197	128	V
2	* 2.488	39.08	Pk	32.5	-21.3	0	50.28	-	-	74	-23.72	197	128	V
4	* 2.499	28.24	RMS	32.6	-21.2	0	39.64	54	-14.36	-	-	197	128	V

* - indicates frequency in CFR47 Pt 15 / IC RSS-Restricted Band
 Pk - Peak detector
 RMS - RMS detection

AUTHORIZED BANDEGE (HIGH CHANNEL, CH 13)

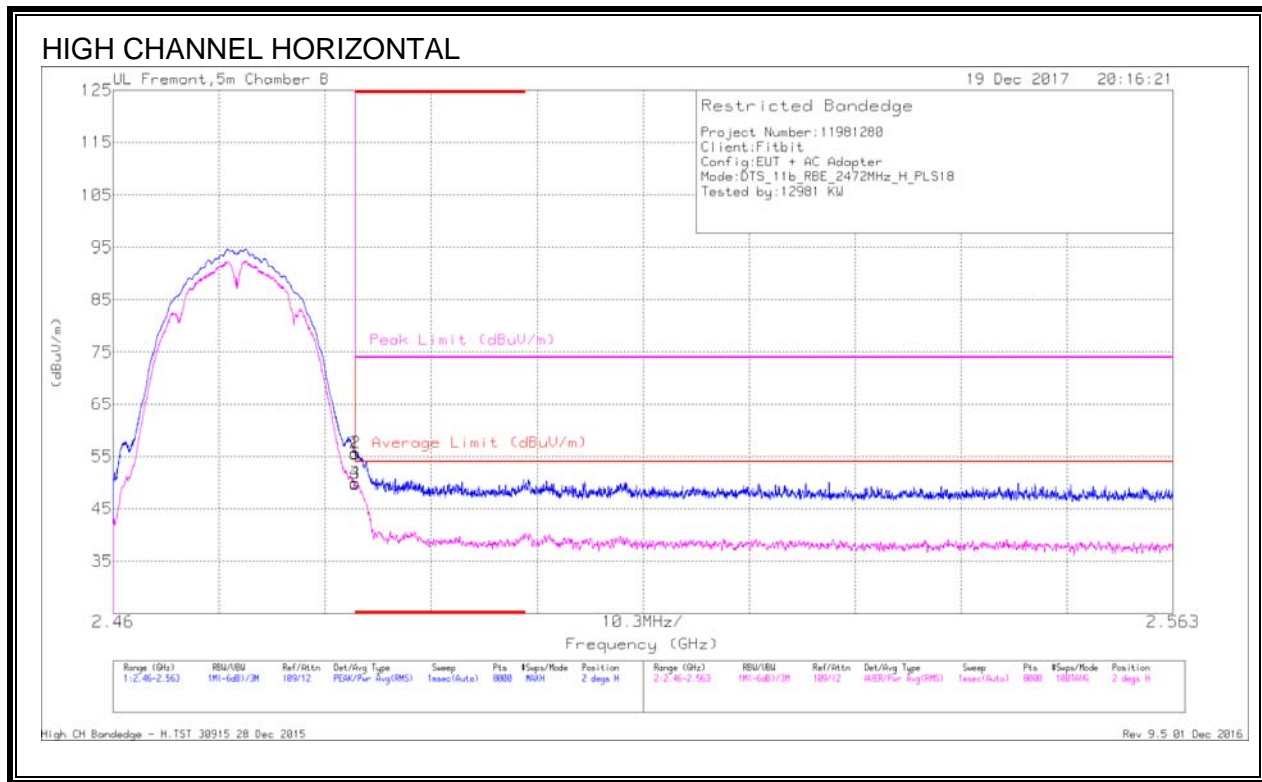

DATA

Marker	Frequency (GHz)	Meter Reading (dBuV)	Det	Af T863 (dB/m)	Amp/Ch/Filt/Pad (dB)	DC Corr (dB)	Corrected Reading (dBuV/m)	Average Limit (dBuV/m)	Margin (dB)	Peak Limit (dBuV/m)	PK Margin (dB)	Adimuth (Degs)	Height (cm)	Polarity
1	* 2.484	44.28	Pk	32.5	-21.3	0	55.48	-	-	74	-18.52	2	138	H
2	* 2.484	44.41	Pk	32.5	-21.3	0	55.61	-	-	74	-18.39	2	138	H
3	* 2.484	38.59	RMS	32.5	-21.3	0	49.79	54	-4.21	-	-	2	138	H
4	* 2.484	38.7	RMS	32.5	-21.3	0	49.9	54	-4.1	-	-	2	138	H

* - indicates frequency in CFR47 Pt 15 / IC RSS-Restricted Band

Pk - Peak detector

RMS - RMS detection

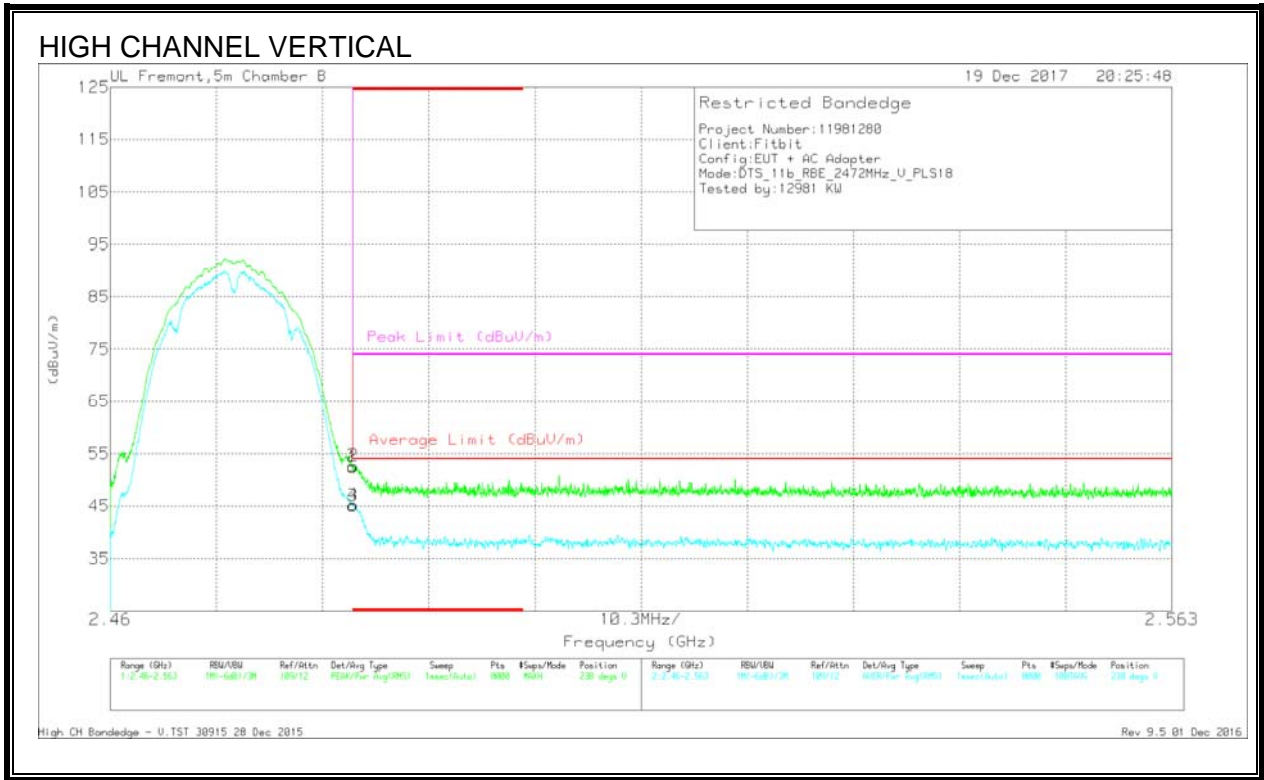

DATA

Marker	Frequency (GHz)	Meter Reading (dBuV)	Det	AF T863 (dB/m)	Amp/Cb/Ftr/Pad (dB)	DC Corr (dB)	Corrected Reading (dBuV/m)	Average Limit (dBuV/m)	Margin (dB)	Peak Limit (dBuV/m)	PK Margin (dB)	Azimuth (Degs)	Height (cm)	Polarity
1	* 2.484	41.19	Pk	32.5	-21.3	0	52.39	-	-	74	-21.61	238	130	V
2	* 2.484	41.4	Pk	32.5	-21.3	0	52.6	-	-	74	-21.4	238	130	V
3	* 2.484	33.88	RMS	32.5	-21.3	0	45.08	54	-8.92	-	-	238	130	V
4	* 2.484	33.95	RMS	32.5	-21.3	0	45.15	54	-8.85	-	-	238	130	V

* - indicates frequency in CFR47 Pt 15 / IC RSS-Restricted Band
 Pk - Peak detector
 RMS - RMS detection

HARMONICS AND SPURIOUS EMISSIONS LOW CHANNEL, CH 1)

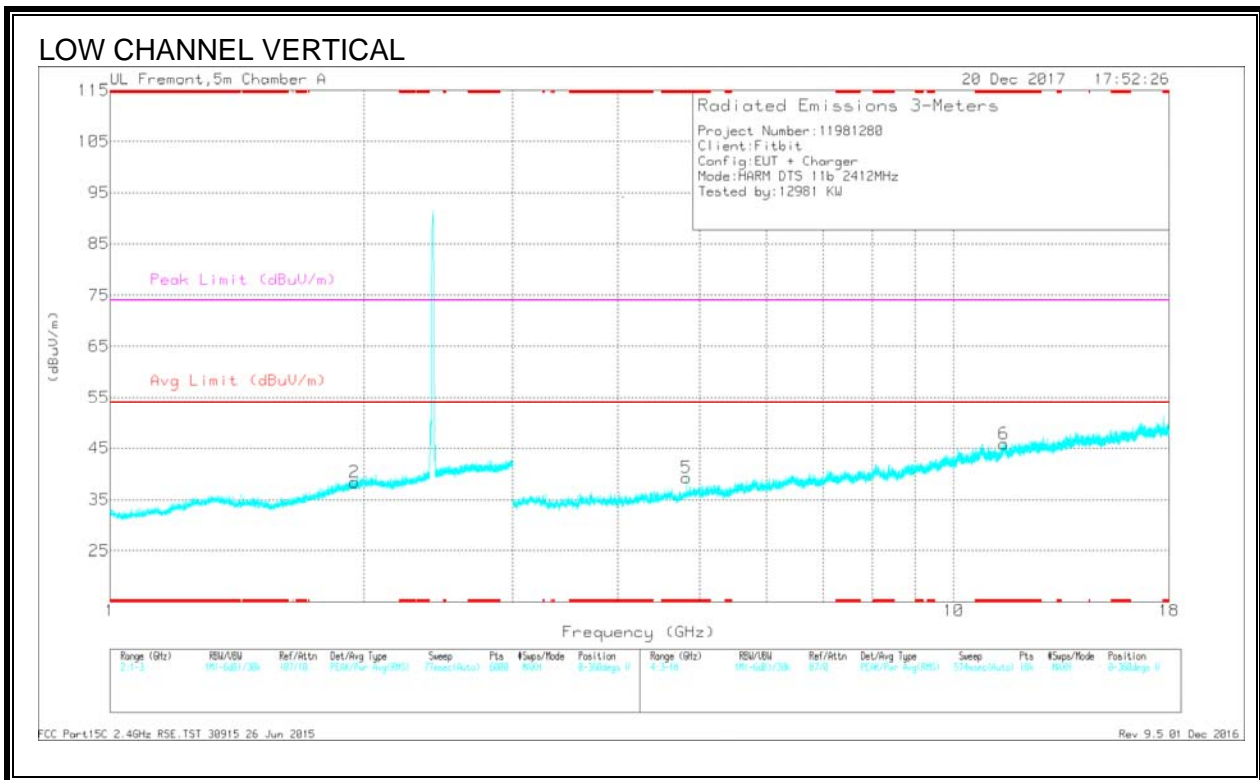
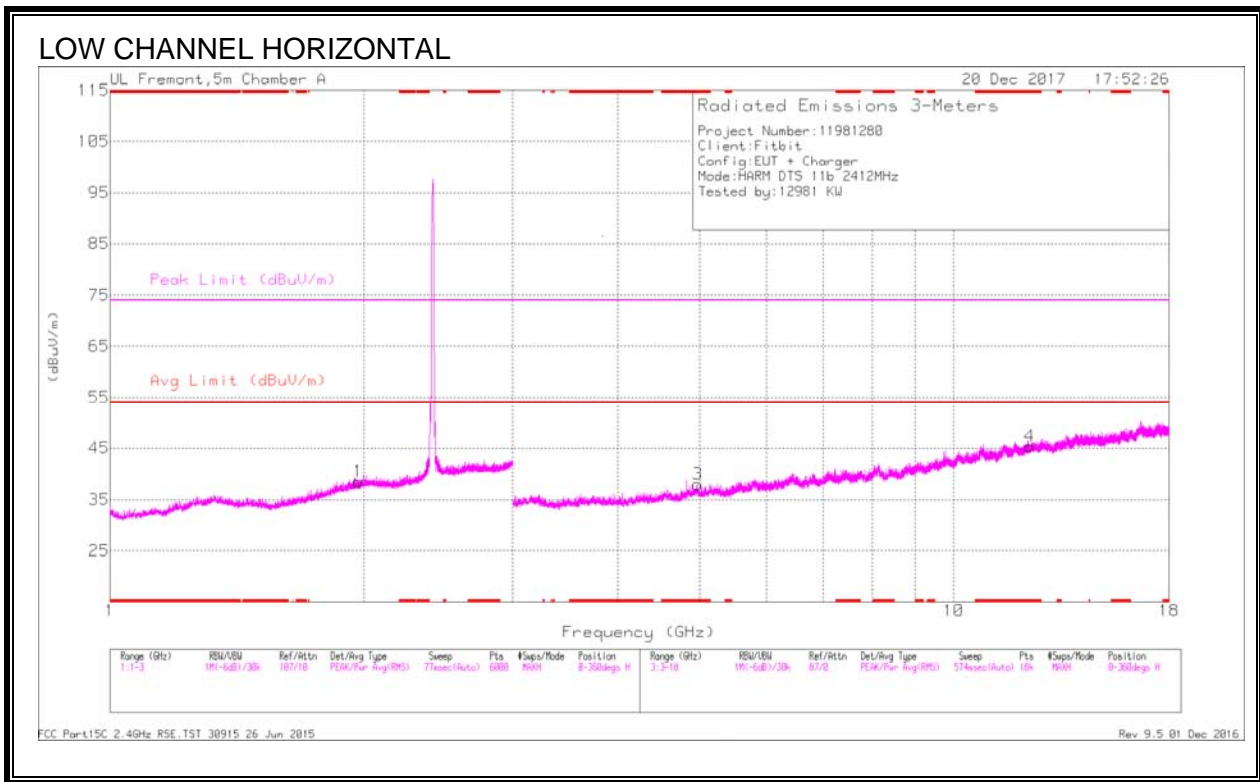

DATA

Market	Frequency (GHz)	Meter Reading (dBuV)	Det	AF T862 (dB/m)	Amp/Cb/Filtr/Par d (dB)	DC Corr (dB)	Corrected Reading (dBuV/m)	Avg Limit (dBuV/m)	Margin (dB)	Peak Limit (dBuV/m)	PK Margin (dB)	Azimuth (Degs)	Height (cm)	Polarity
3	* 4.972	37.4	PK2	34.3	-27.2	0	44.5	-	-	74	-29.5	70	142	H
	* 4.973	26.42	MAv1	34.3	-27.2	0	33.52	54	-20.48	-	-	70	142	H
4	* 12.303	31.76	PK2	38.9	-19	0	51.66	-	-	74	-22.34	88	172	H
	* 12.303	20.82	MAv1	38.9	-19	0	40.72	54	-13.28	-	-	88	172	H
5	* 4.825	35.15	PK2	34.2	-26.3	0	43.05	-	-	74	-30.95	129	151	V
	* 4.824	24.63	MAv1	34.2	-26.3	0	32.53	54	-21.47	-	-	129	151	V
6	* 11.475	32.05	PK2	38.3	-18	0	52.35	-	-	74	-21.65	262	260	V
	* 11.475	20.94	MAv1	38.3	-18	0	41.24	54	-12.76	-	-	262	260	V
2	1.947	30.29	Pk	31.4	-23.3	0	38.39	-	-	-	-	0-360	101	V
1	1.968	30.29	Pk	31.4	-23.2	0	38.49	-	-	-	-	0-360	101	H

* - indicates frequency in CFR47 Pt 15 / IC RSS-Restricted Band

PK2 - KDB558074 Method: Maximum Peak

MAv1 - KDB558074 Option 1 Maximum RMS Average

HARMONICS AND SPURIOUS EMISSIONS MID CHANNEL, CH 6)

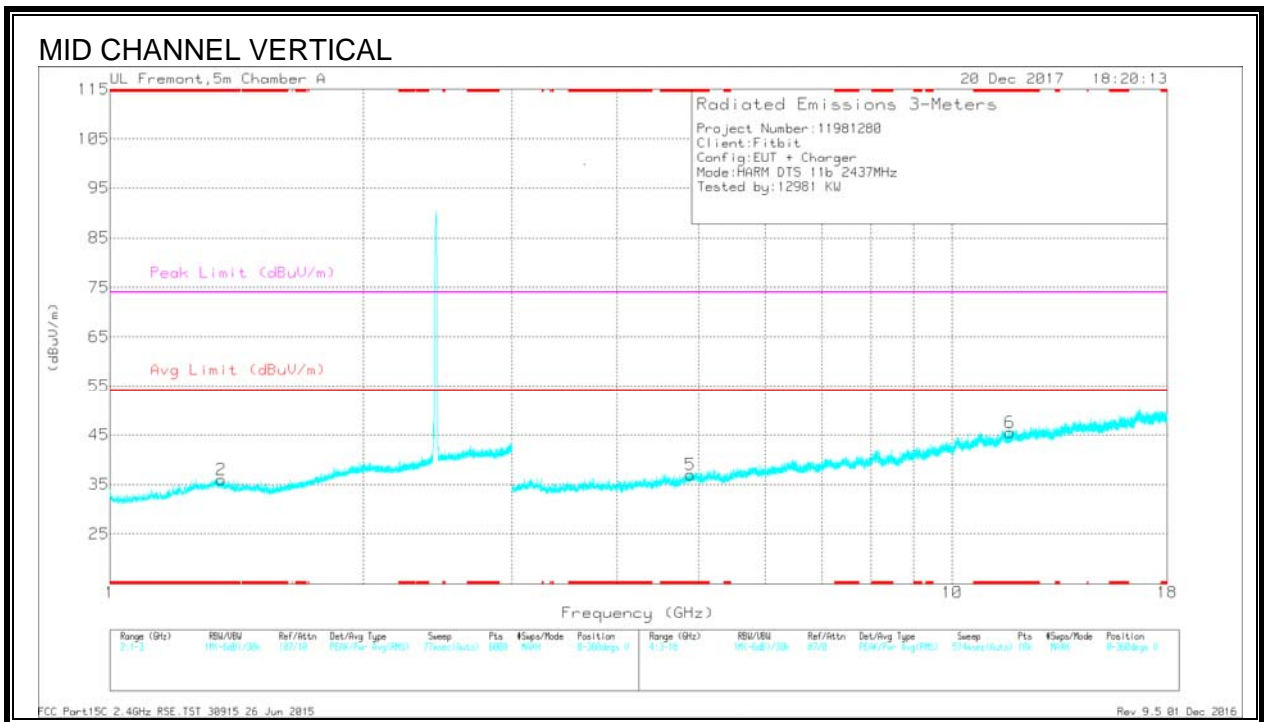
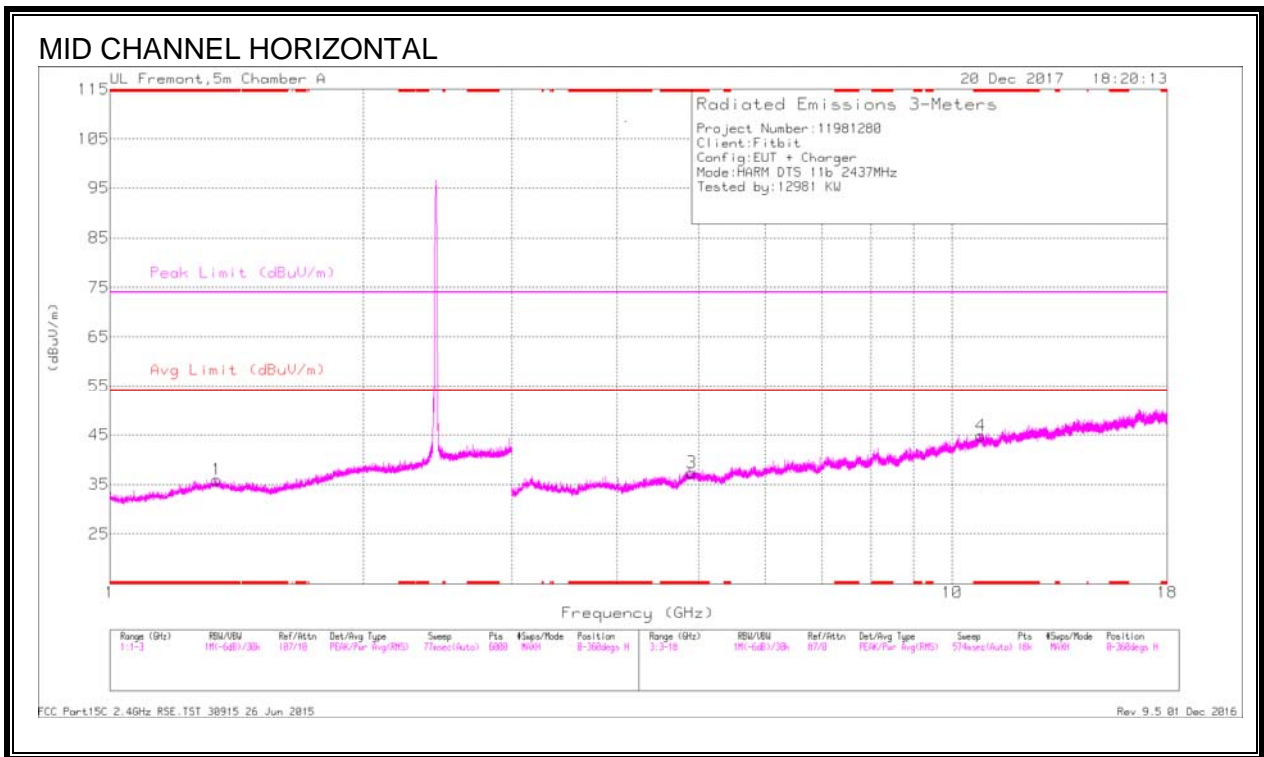

DATA

Marker	Frequency (GHz)	Meter Reading (dBuV)	Det	AF T862 (dB/m)	Amp/Cbi/Filtr/ Pad (dB)	DC Corr (dB)	Corrected Reading (dBuV/m)	Avg Limit (dBuV/m)	Margin (dB)	Peak Limit (dBuV/m)	PK Margin (dB)	Azimuth (Degs)	Height (cm)	Polarity
1	* 1.341	36.1	PK2	29.5	-23.6	0	42	-	-	74	-32	82	135	H
	* 1.338	24.45	MAv1	29.5	-23.7	0	30.25	54	-23.75	-	-	82	135	H
2	* 1.358	35.38	PK2	29.4	-23.5	0	41.28	-	-	74	-32.72	113	172	V
	* 1.357	24.33	MAv1	29.4	-23.5	0	30.23	54	-23.77	-	-	113	172	V
3	* 4.905	35.54	PK2	34.1	-26.3	0	43.34	-	-	74	-30.66	145	159	H
	* 4.903	24.61	MAv1	34.1	-26.3	0	32.41	54	-21.59	-	-	145	159	H
4	* 10.82	31.15	PK2	37.8	-18.4	0	50.55	-	-	74	-23.45	51	166	H
	* 10.823	20.81	MAv1	37.8	-18.4	0	40.21	54	-13.79	-	-	51	166	H
5	* 4.889	35.88	PK2	34.1	-26.2	0	43.78	-	-	74	-30.22	225	122	V
	* 4.89	25	MAv1	34.1	-26.2	0	32.9	54	-21.1	-	-	225	122	V
6	* 11.709	31.92	PK2	38.6	-19.2	0	51.32	-	-	74	-22.68	181	109	V
	* 11.705	20.71	MAv1	38.6	-19.3	0	40.01	54	-13.99	-	-	181	109	V

* - indicates frequency in CFR47 Pt 15 / IC RSS-Restricted Band

PK2 - KDB558074 Method: Maximum Peak

MAv1 - KDB558074 Option 1 Maximum RMS Average

HARMONICS AND SPURIOUS EMISSIONS HIGH CHANNEL, CH 13)

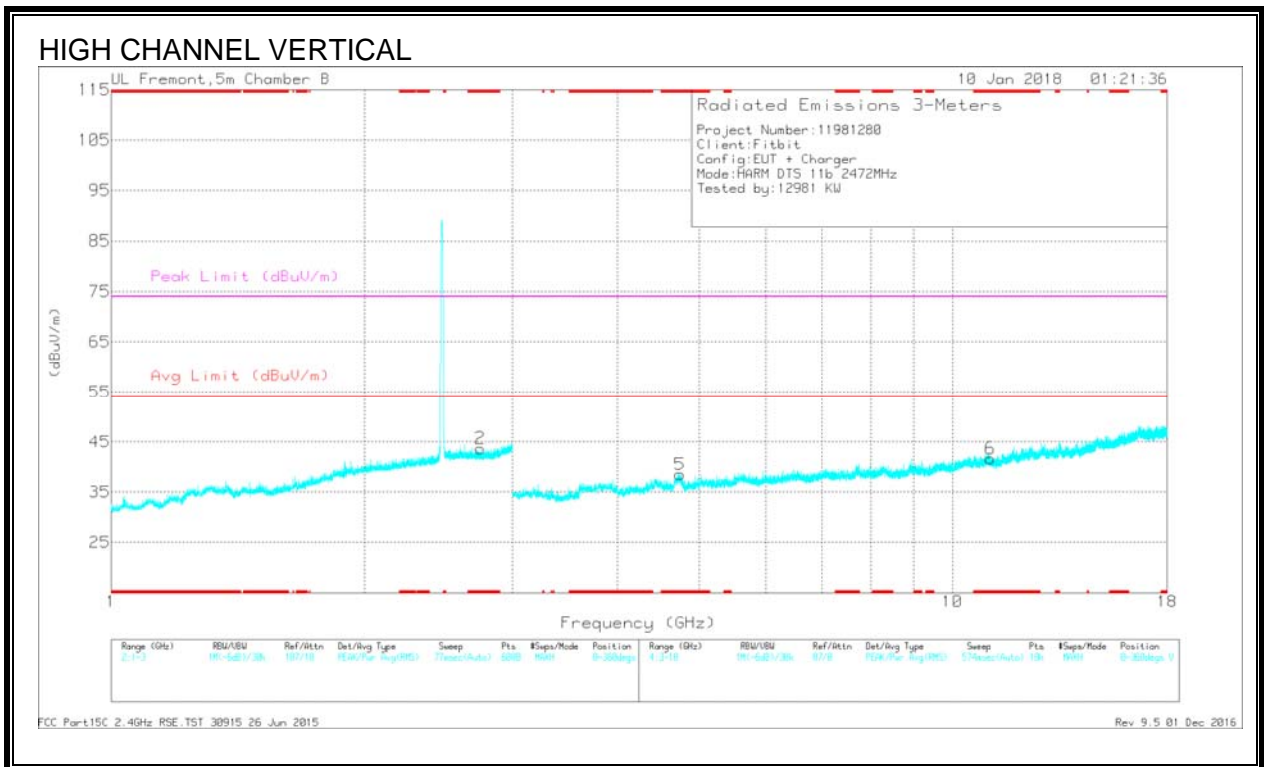
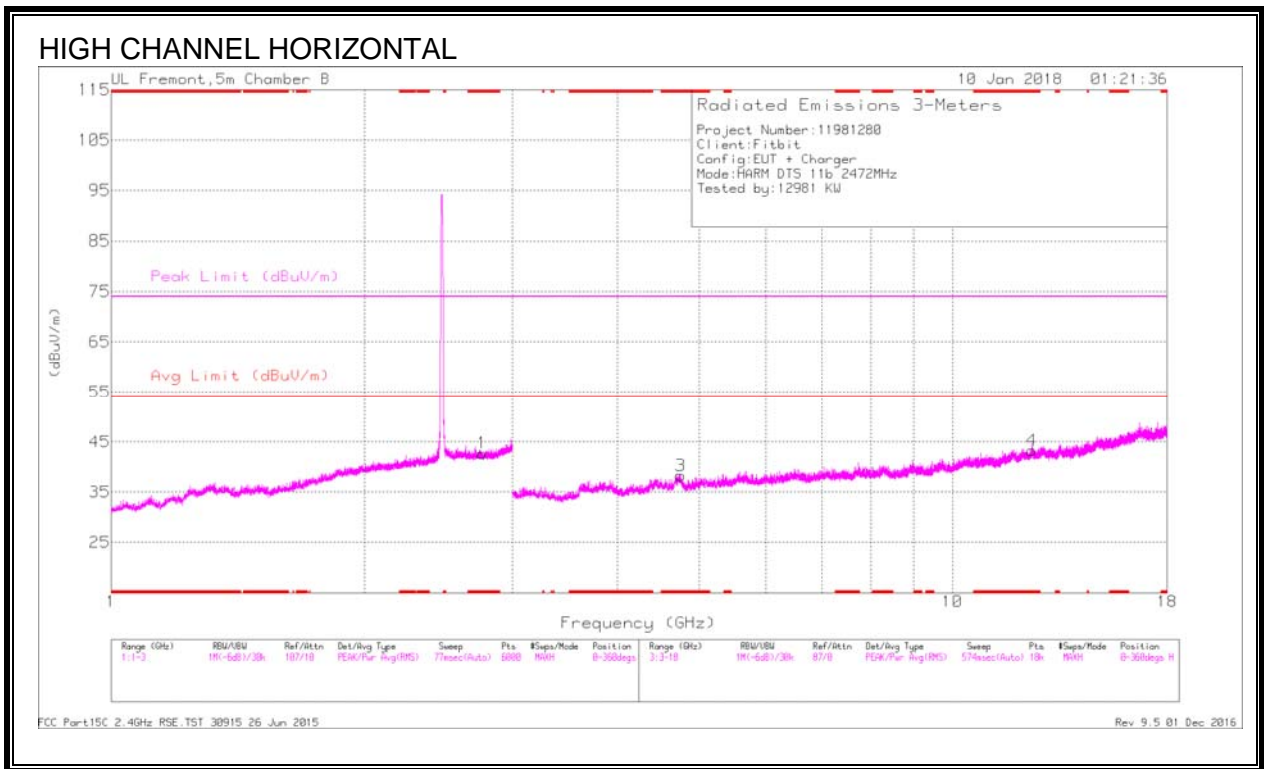

DATA

Marker	Frequency (GHz)	Meter Reading (dBuV)	Det	AF T863 (dB/m)	Amp/Cbi/Filtr/ Pad (dB)	DC Corr (dB)	Corrected Reading (dBuV/m)	Avg Limit (dBuV/m)	Margin (dB)	Peak Limit (dBuV/m)	PK Margin (dB)	Azimuth (Degs)	Height (cm)	Polarity
1	* 2.761	36.8	PK2	32.3	-20.8	0	48.3	-	-	74	-25.7	160	151	H
	* 2.758	25.48	MAv1	32.3	-20.8	0	36.98	54	-17.02	-	-	160	151	H
2	* 2.748	36.74	PK2	32.3	-20.7	0	48.34	-	-	74	-25.66	240	132	V
	* 2.749	25.45	MAv1	32.3	-20.7	0	37.05	54	-16.95	-	-	240	132	V
3	* 4.753	41.11	PK2	34.2	-29.3	0	46.01	-	-	74	-27.99	191	121	H
	* 4.753	29.28	MAv1	34.3	-29.3	0	34.28	54	-19.72	-	-	191	121	H
4	* 12.425	34.29	PK2	39	-23.6	0	49.69	-	-	74	-24.31	78	199	H
	* 12.425	23.37	MAv1	39	-23.6	0	38.77	54	-15.23	-	-	78	199	H
5	* 4.743	40.41	PK2	34.2	-29.4	0	45.21	-	-	74	-28.79	64	104	V
	* 4.743	29.63	MAv1	34.2	-29.4	0	34.43	54	-19.57	-	-	64	104	V
6	* 11.1	35.17	PK2	37.7	-24.6	0	48.27	-	-	74	-25.73	176	174	V
	* 11.097	24.02	MAv1	37.7	-24.6	0	37.12	54	-16.88	-	-	176	174	V

* - indicates frequency in CFR47 Pt 15 / IC RSS-Restricted Band

PK2 - KDB558074 Method: Maximum Peak

MAv1 - KDB558074 Option 1 Maximum RMS Average

9.2.2. 802.11g MODE IN THE 2.4 GHz BAND

AUTHORIZED BANDEDGE (LOW CHANNEL, CH 1)

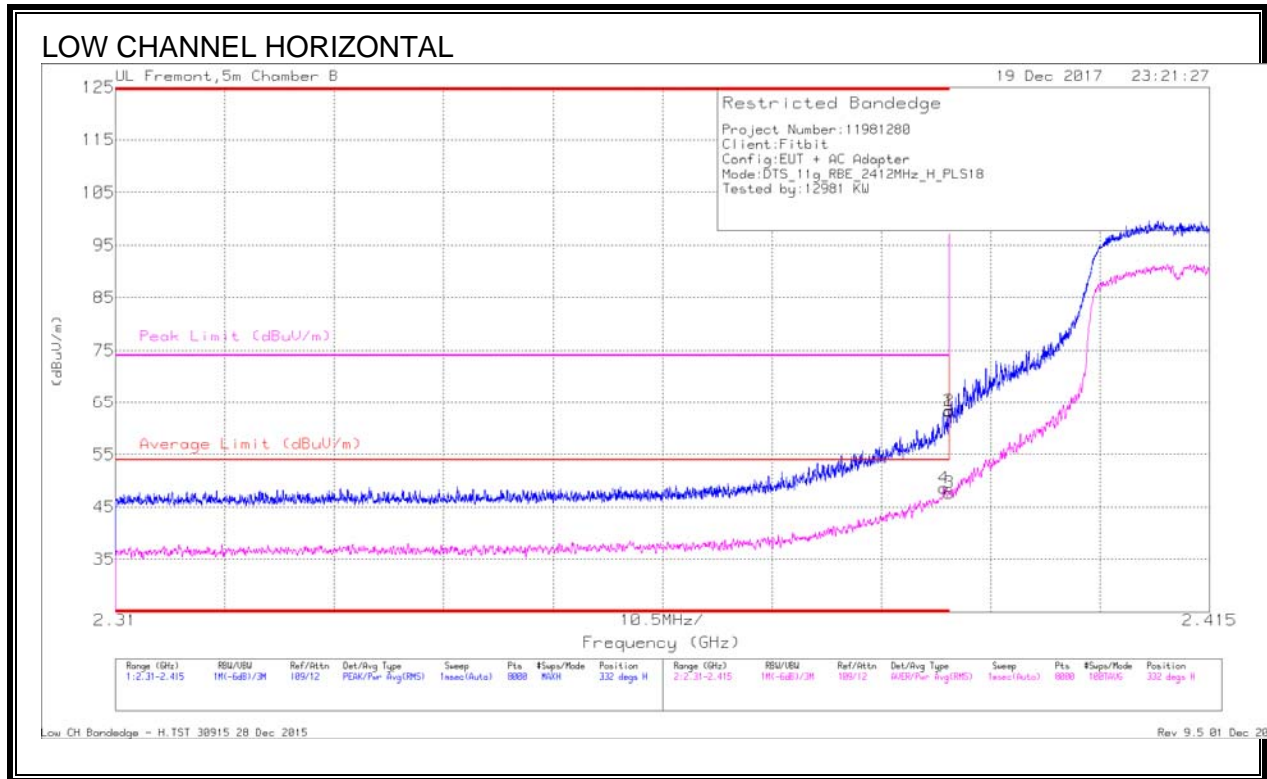

DATA

Marker	Frequency (GHz)	Meter Reading (dBuV)	Det	AF T863 (dB/m)	Amp/Cb/Ftr/Psd (dB)	DC Corr (dB)	Corrected Reading (dBuV/m)	Average Limit (dBuV/m)	Margin (dB)	Peak Limit (dBuV/m)	PK Margin (dB)	Azimuth (Degs)	Height (cm)	Polarity
4	* 2.389	37.84	RMS	32	-21.3	0	48.54	54	-5.46	-	-	332	119	H
1	* 2.39	52.55	Pk	32	-21.3	0	63.25	-	-	74	-10.75	332	119	H
2	* 2.39	52.69	Pk	32	-21.3	0	63.39	-	-	74	-10.61	332	119	H
3	* 2.39	36.99	RMS	32	-21.3	0	47.69	54	-6.31	-	-	332	119	H

* - indicates frequency in CFR47 Pt 15 / IC RSS-Restricted Band
 Pk - Peak detector
 RMS - RMS detection

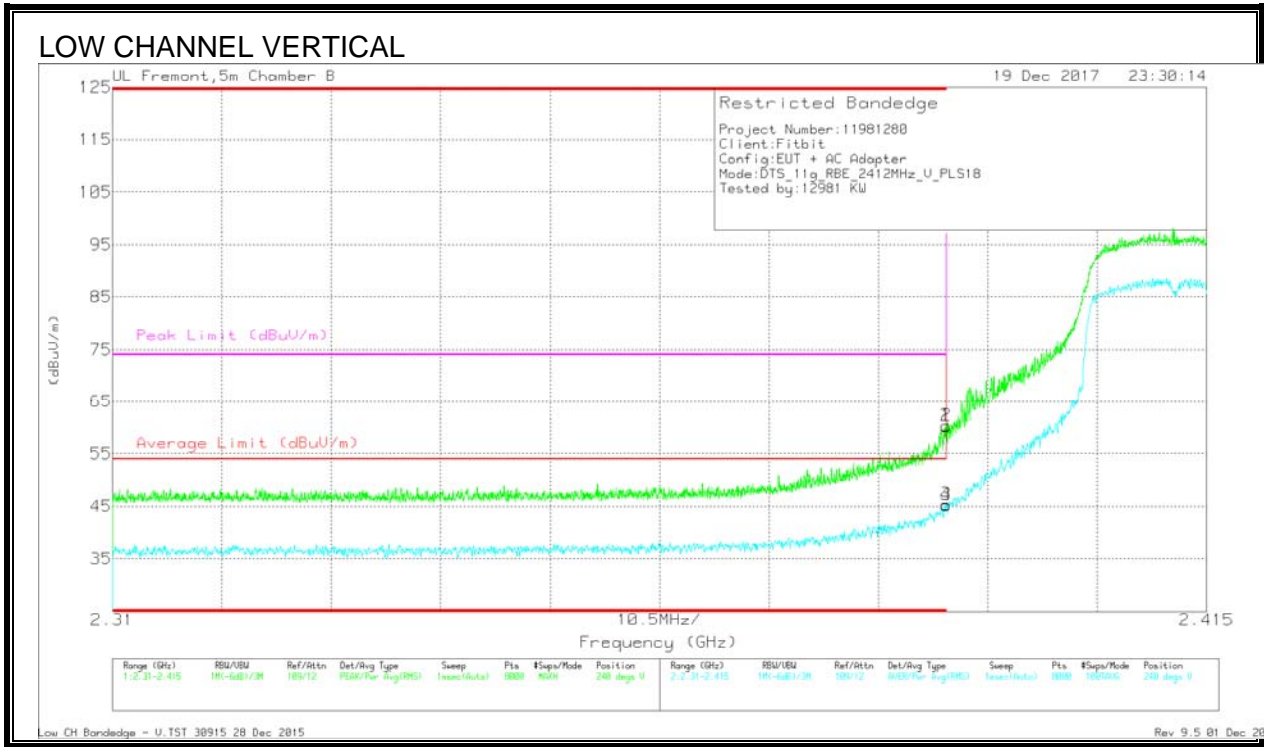

DATA

Marker	Frequency (GHz)	Meter Reading (dBuV)	Det	AF T863 (dB/m)	Amp/Cb/Fltr/Pad (dB)	DC Corr (dB)	Corrected Reading (dBuV/m)	Average Limit (dBuV/m)	Margin (dB)	Peak Limit (dBuV/m)	PK Margin (dB)	Azimuth (Degs)	Height (cm)	Polarity
1	* 2.39	49.63	PK	32	-21.3	0	60.33	-	-	74	-13.67	240	129	V
2	* 2.39	49.59	PK	32	-21.3	0	60.29	-	-	74	-13.71	240	129	V
3	* 2.39	34.64	RMS	32	-21.3	0	45.34	54	-8.66	-	-	240	129	V
4	* 2.39	34.56	RMS	32	-21.3	0	45.26	54	-8.74	-	-	240	129	V

* - indicates frequency in CFR47 Pt 15 / IC RSS-Restricted Band

PK - Peak detector

RMS - RMS detection

AUTHORIZED BANDEGE (LOW CHANNEL, CH 2)

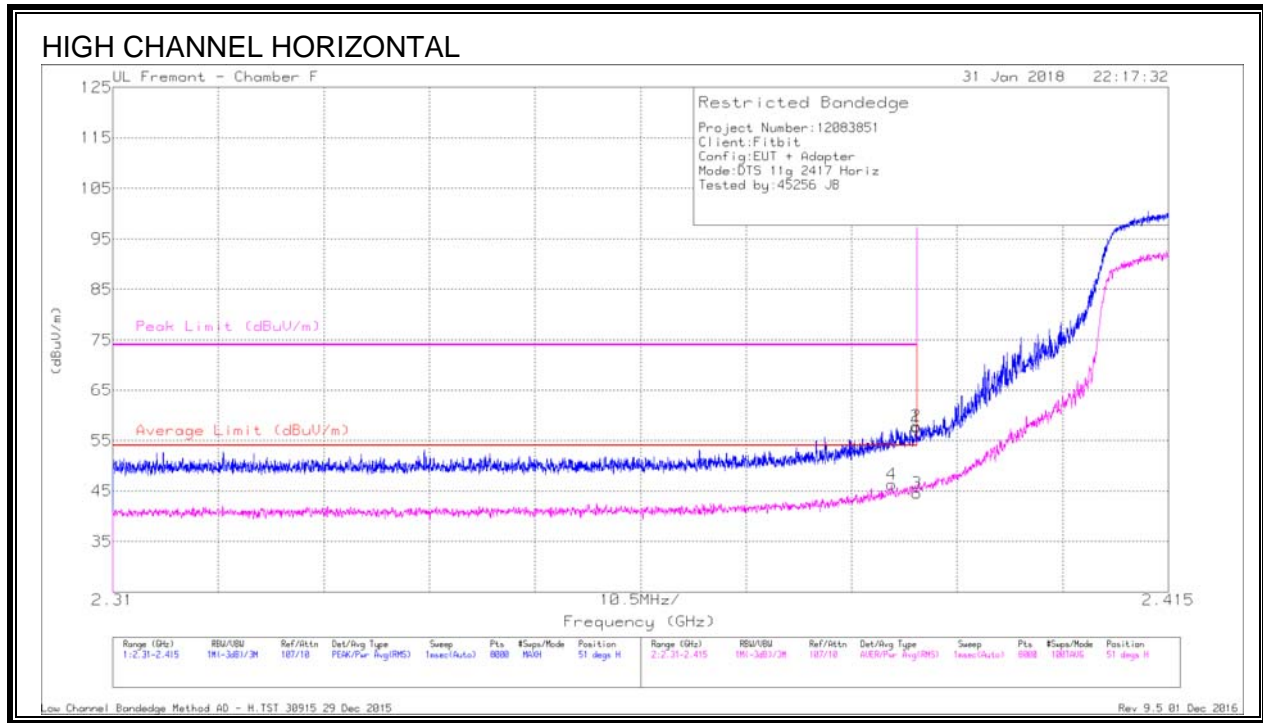

DATA

Marker	Frequency (GHz)	Meter Reading (dBuV)	Det	AF T119 (dB/m)	Amp/Cb/Filt/Pad (dB)	DC Corr (dB)	Corrected Reading (dBuV/m)	Average Limit (dBuV/m)	Margin (dB)	Peak Limit (dBuV/m)	PK Margin (dB)	Azimuth (Degs)	Height (cm)	Polarity
1	* 2.39	46.31	Pk	31.9	-20.6	0	57.61	-	-	74	-16.39	51	383	H
2	* 2.39	46.58	Pk	31.9	-20.6	0	57.88	-	-	74	-16.12	51	383	H
3	* 2.39	33.33	RMS	31.9	-20.6	0	44.63	54	-9.37	-	-	51	383	H
4	* 2.387	35.07	RMS	31.9	-20.6	0	46.37	54	-7.63	-	-	51	383	H

* - indicates frequency in CFR47 Pt 15 / IC RSS-Restricted Band

Pk - Peak detector

RMS - RMS detection

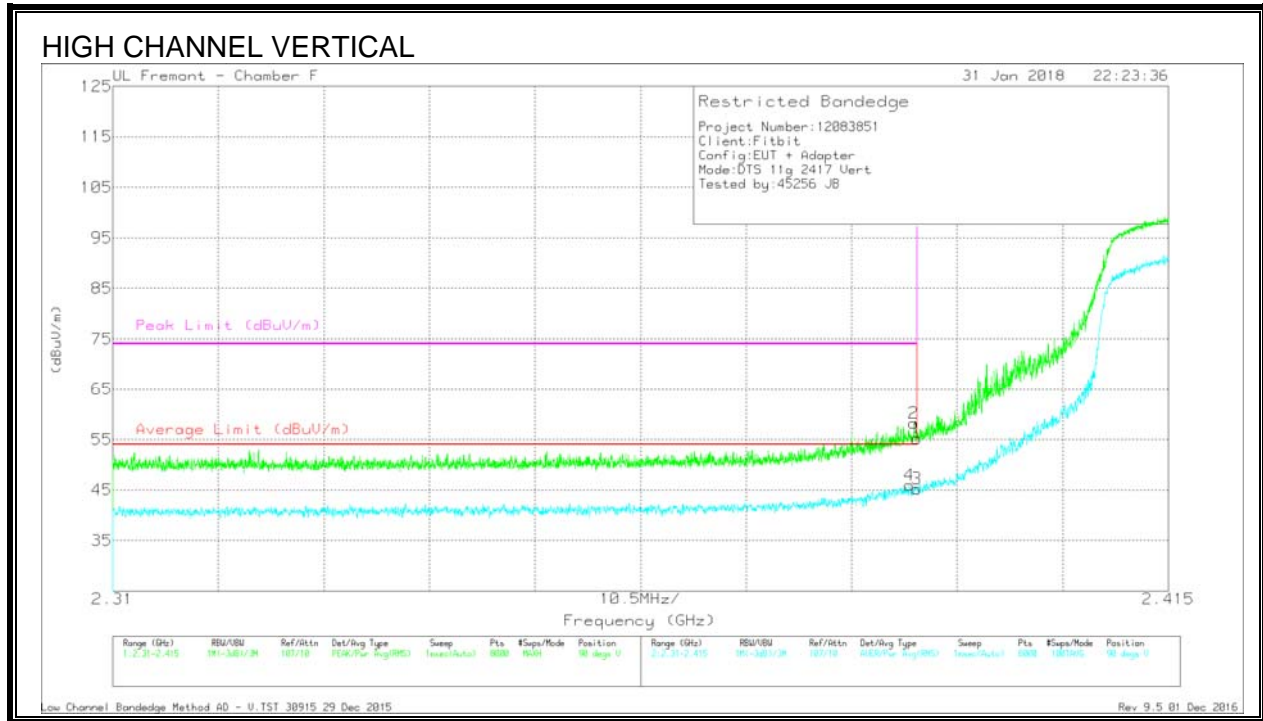

DATA

Marker	Frequency (GHz)	Meter Reading (dBuV)	Det	AF T119 (dB/m)	Amp/Ch/Filt/Pad (dB)	DC Corr (dB)	Corrected Reading (dBuV/m)	Average Limit (dBuV/m)	Margin (dB)	Peak Limit (dBuV/m)	PK Margin (dB)	Azimuth (Degs)	Height (cm)	Polarity
1	* 2.39	43.9	Pk	31.9	-20.6	0	55.2	-	-	74	-18.8	90	340	V
2	* 2.39	46.98	Pk	31.9	-20.6	0	58.28	-	-	74	-15.72	90	340	V
3	* 2.39	33.96	RMS	31.9	-20.6	0	45.26	54	-8.74	-	-	90	340	V
4	* 2.389	34.69	RMS	31.9	-20.6	0	45.99	54	-8.01	-	-	90	340	V

* - indicates frequency in CFR47 Pt 15 / IC RSS-Restricted Band
 Pk - Peak detector
 RMS - RMS detection

AUTHORIZED BANDEDGE (HIGH CHANNEL, CH 10)

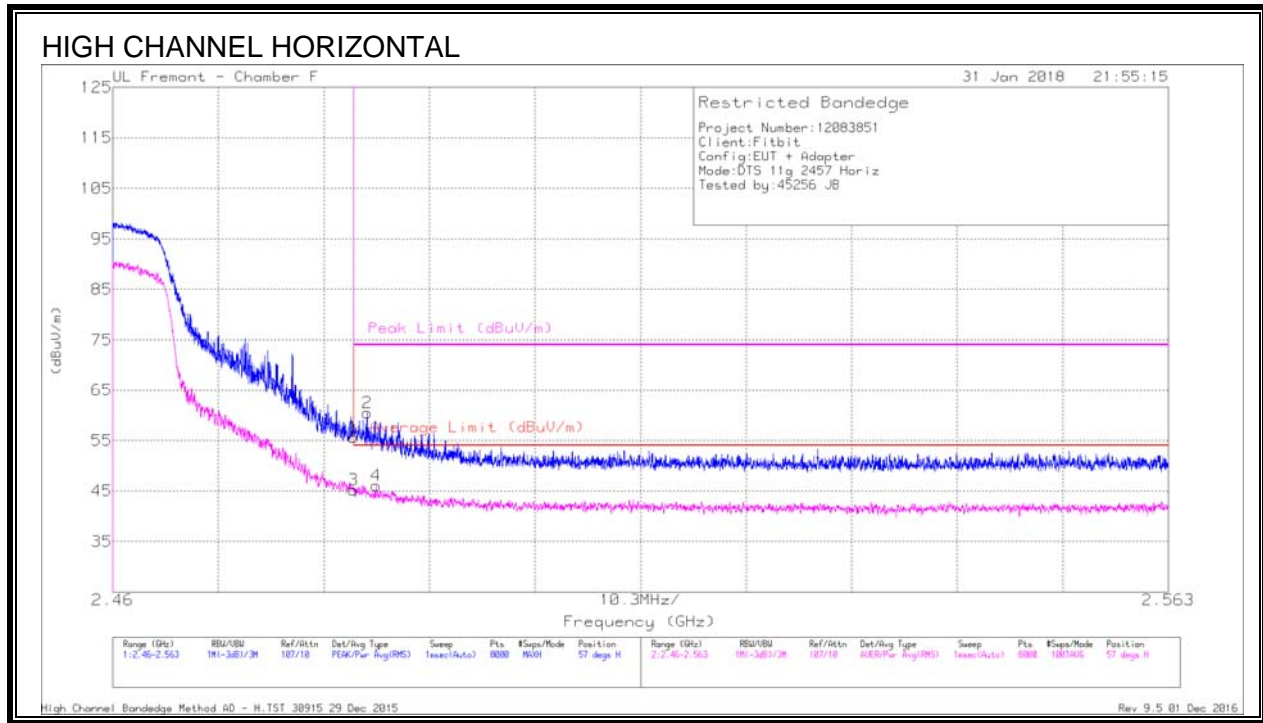

DATA

Marker	Frequency (GHz)	Meter Reading (dBuV)	Det	AF T119 (dB/m)	Amp/Cb/Filt/Pad (dB)	DC Corr (dB)	Corrected Reading (dBuV/m)	Average Limit (dBuV/m)	Margin (dB)	Peak Limit (dBuV/m)	PK Margin (dB)	Azimuth (Degs)	Height (cm)	Polarity
1	* 2.484	44.25	Pk	32.1	-20.7	0	55.65	-	-	74	-18.35	57	347	H
2	* 2.485	48.94	Pk	32.2	-20.7	0	60.44	-	-	74	-13.56	57	347	H
3	* 2.484	33.8	RMS	32.1	-20.7	0	45.2	54	-8.8	-	-	57	347	H
4	* 2.486	34.61	RMS	32.2	-20.7	0	46.11	54	-7.89	-	-	57	347	H

* - indicates frequency in CFR47 Pt 15 / IC RSS-Restricted Band

Pk - Peak detector

RMS - RMS detection

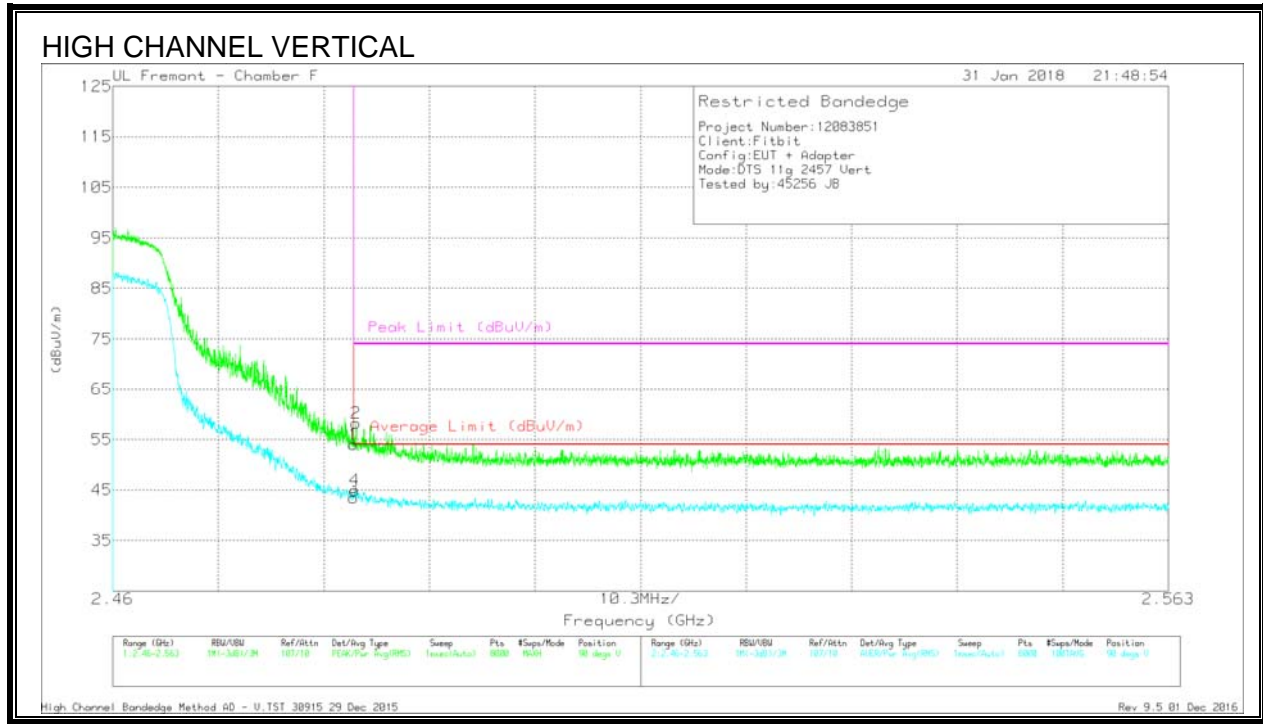

DATA

Marker	Frequency (GHz)	Meter Reading (dBuV)	Det	AF T119 (dB/m)	Amp/Ch/Fltr/Pad (dB)	DC Corr (dB)	Corrected Reading (dBuV/m)	Average Limit (dBuV/m)	Margin (dB)	Peak Limit (dBuV/m)	PK Margin (dB)	Azimuth (Degs)	Height (cm)	Polarity
1	* 2.484	42.67	Pk	32.1	-20.7	0	54.07	-	-	74	-19.93	90	318	V
2	* 2.484	46.86	Pk	32.1	-20.7	0	58.26	-	-	74	-15.74	90	318	V
3	* 2.484	32.06	RMS	32.1	-20.7	0	43.46	54	-10.54	-	-	90	318	V
4	* 2.484	33.59	RMS	32.1	-20.7	0	44.99	54	-9.01	-	-	90	318	V

* - indicates frequency in CFR47 Pt 15 / IC RSS-Restricted Band
 Pk - Peak detector
 RMS - RMS detection

AUTHORIZED BANDEGE (HIGH CHANNEL, CH 11)

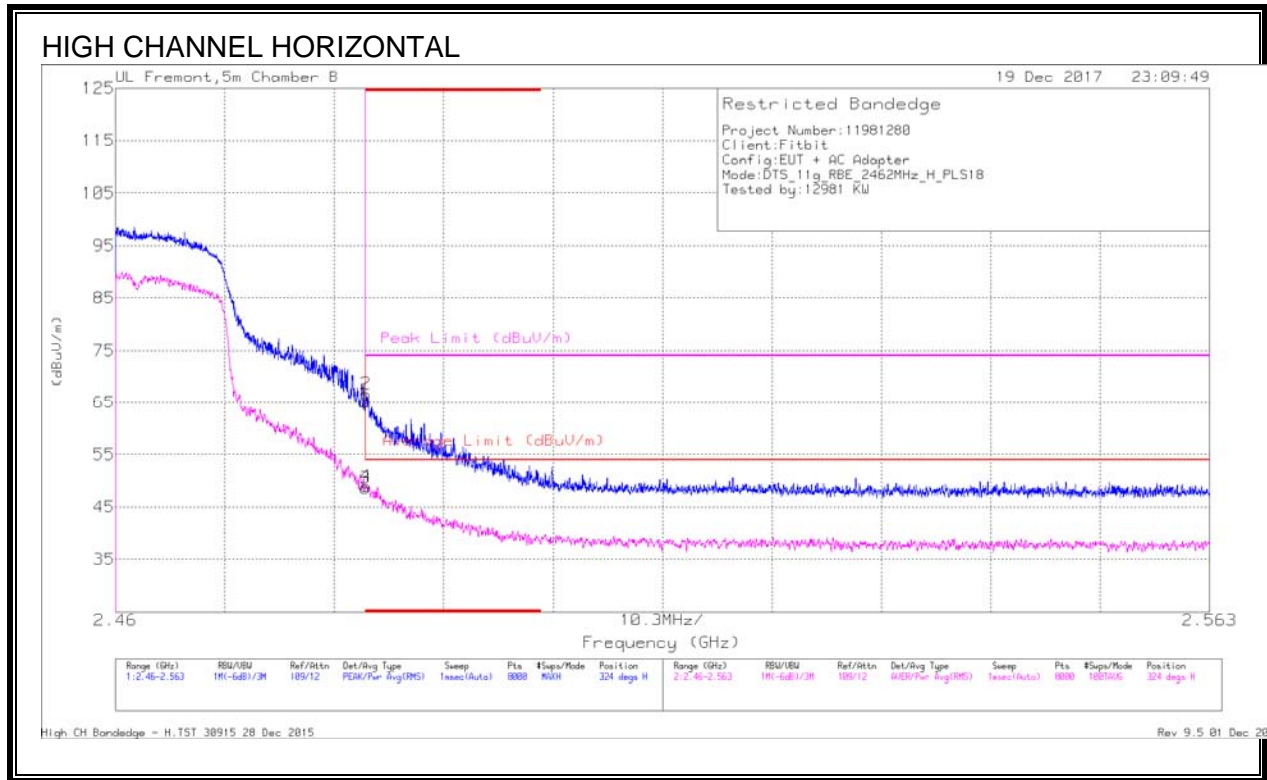

DATA

Marker	Frequency (GHz)	Meter Reading (dBuV)	Det	AF T863 (dB/m)	Amp/Ch/Filt/Pad (dB)	DC Corr (dB)	Corrected Reading (dBuV/m)	Average Limit (dBuV/m)	Margin (dB)	Peak Limit (dBuV/m)	PK Margin (dB)	Azimuth (Degs)	Height (cm)	Polarity
1	* 2.484	53.84	Pk	32.5	-21.3	0	65.04	-	-	74	-8.96	324	120	H
2	* 2.484	55.5	Pk	32.5	-21.3	0	66.7	-	-	74	-7.3	324	120	H
3	* 2.484	37.3	RMS	32.5	-21.3	0	48.5	54	-5.5	-	-	324	120	H
4	* 2.484	37.76	RMS	32.5	-21.3	0	48.96	54	-5.04	-	-	324	120	H

* - indicates frequency in CFR47 Pt 15 / IC RSS-Restricted Band

Pk - Peak detector

RMS - RMS detection

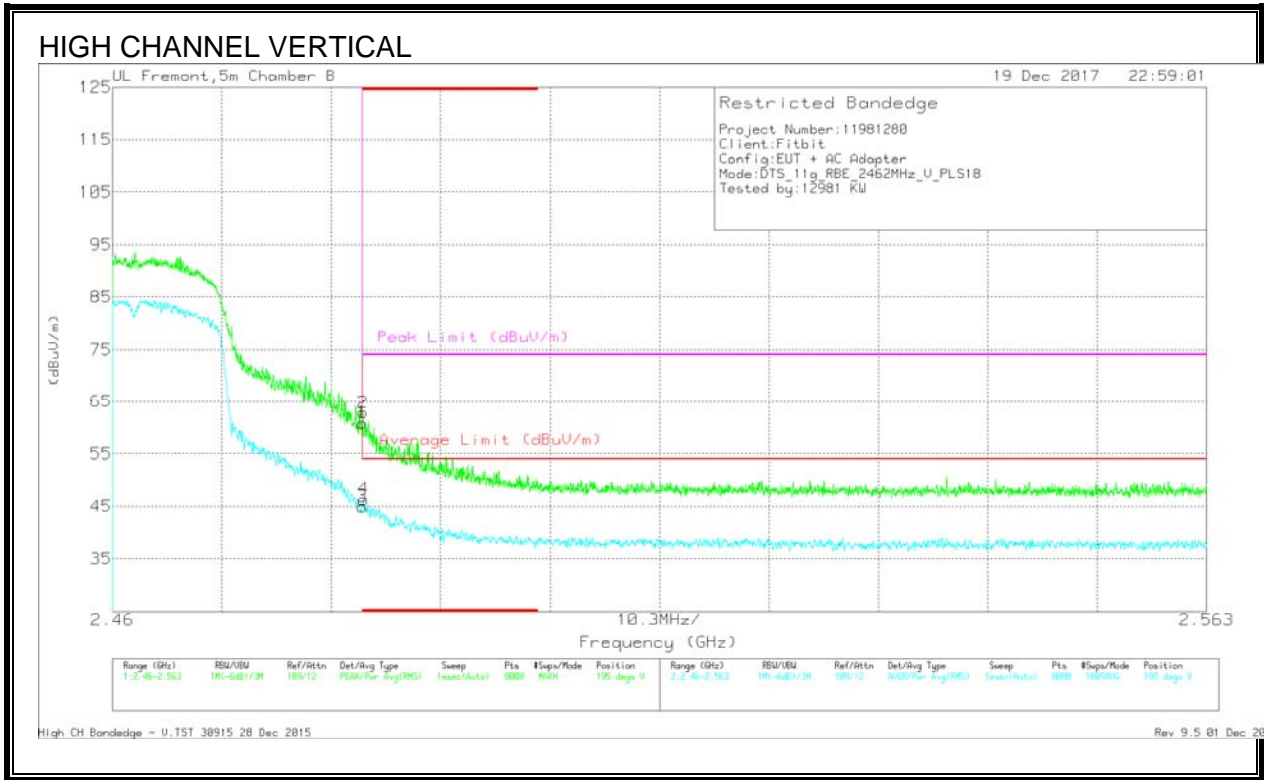

DATA

Marker	Frequency (GHz)	Meter Reading (dBuV)	Det	AF T863 (dB/m)	Amp/Cbl/Ftr/Pad (dB)	DC Corr (dB)	Corrected Reading (dBuV/m)	Average Limit (dBuV/m)	Margin (dB)	Peak Limit (dBuV/m)	PK Margin (dB)	Azimuth (Degs)	Height (cm)	Polarity
1	* 2.484	49.67	Pk	32.5	-21.3	0	60.87	-	-	74	-13.13	195	123	V
2	* 2.484	51.66	Pk	32.5	-21.3	0	62.86	-	-	74	-11.14	195	123	V
3	* 2.484	33.75	RMS	32.5	-21.3	0	44.95	54	-9.05	-	-	195	123	V
4	* 2.484	35.14	RMS	32.5	-21.3	0	46.34	54	-7.66	-	-	195	123	V

* - indicates frequency in CFR47 Pt 15 / IC RSS-Restricted Band
 Pk - Peak detector
 RMS - RMS detection

AUTHORIZED BANDEGE (HIGH CHANNEL, CH 12)

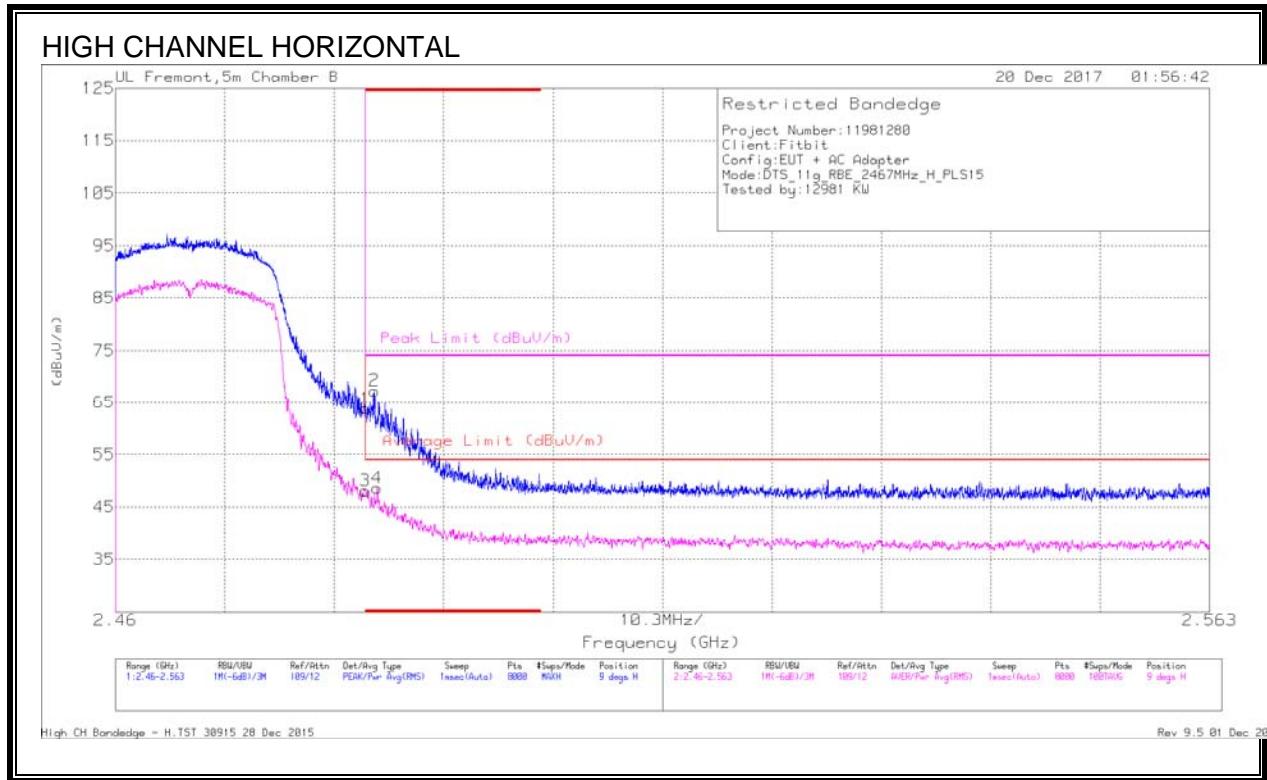

DATA

Marker	Frequency (GHz)	Meter Reading (dBuV)	Det	AF T863 (dB/m)	Amp/Ch/Filt/Pad (dB)	DC Corr (dB)	Corrected Reading (dBuV/m)	Average Limit (dBuV/m)	Margin (dB)	Peak Limit (dBuV/m)	PK Margin (dB)	Azimuth (Degs)	Height (cm)	Polarity
1	* 2.484	52.59	Pk	32.5	-21.3	0	63.79	-	-	74	-10.21	9	183	H
2	* 2.484	56.07	Pk	32.5	-21.3	0	67.27	-	-	74	-6.73	9	183	H
3	* 2.484	36.84	RMS	32.5	-21.3	0	48.04	54	-5.96	-	-	9	183	H
4	* 2.485	37.32	RMS	32.5	-21.3	0	48.52	54	-5.48	-	-	9	183	H

* - indicates frequency in CFR47 Pt 15 / IC RSS-Restricted Band
 Pk - Peak detector
 RMS - RMS detection

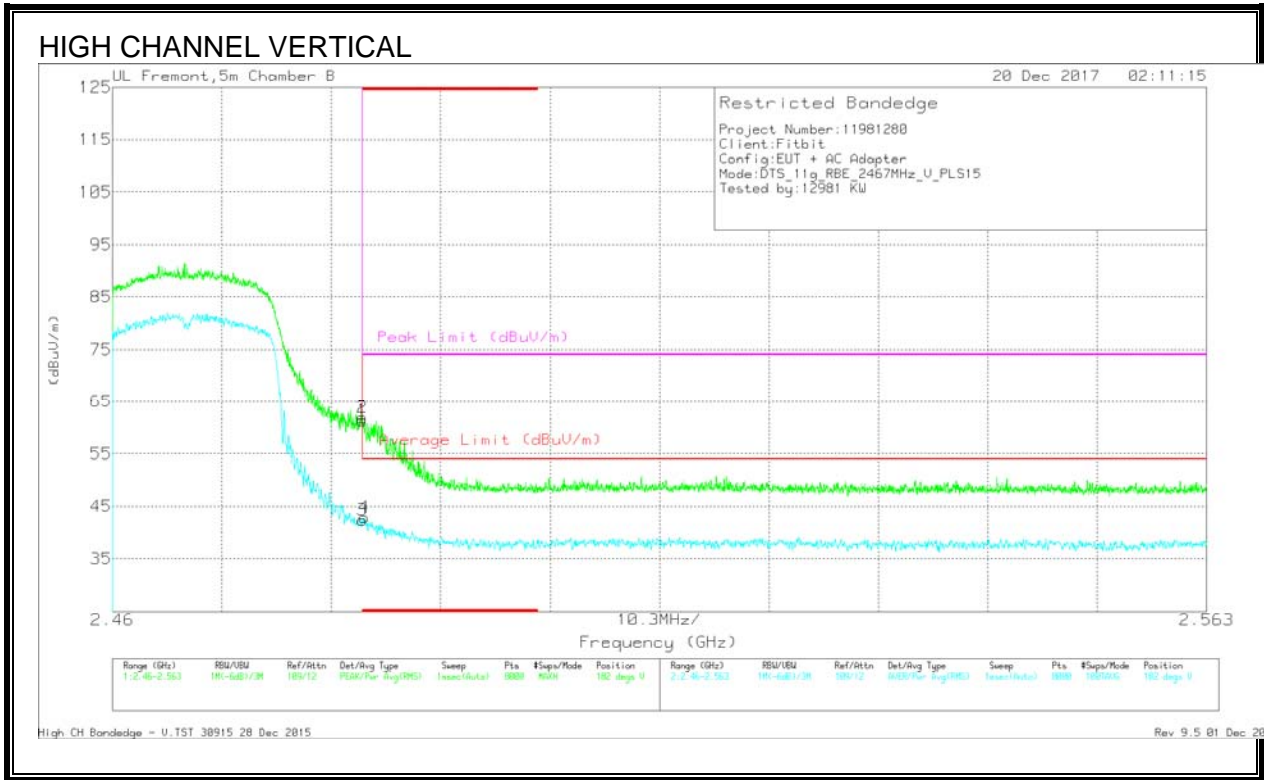

DATA

Marker	Frequency (GHz)	Meter Reading (dBuV)	Det	AF 1863 (dB/m)	Amp/Cbl/Ftr/Pad (dB)	DC Corr (dB)	Corrected Reading (dBuV/m)	Average Limit (dBuV/m)	Margin (dB)	Peak Limit (dBuV/m)	PK Margin (dB)	Asimuth (Degs)	Height (cm)	Polarity
1	* 2.484	50.13	Pk	32.5	-21.3	0	61.33	-	-	74	-12.67	182	167	V
2	* 2.484	50.65	Pk	32.5	-21.3	0	61.85	-	-	74	-12.15	182	167	V
3	* 2.484	31.14	RMS	32.5	-21.3	0	42.34	54	-11.66	-	-	182	167	V
4	* 2.484	31.67	RMS	32.5	-21.3	0	42.87	54	-11.13	-	-	182	167	V

* - indicates frequency in CFR47 Pt 15 / IC RSS-Restricted Band
 Pk - Peak detector
 RMS - RMS detection

AUTHORIZED BANDEGE (HIGH CHANNEL, CH 13)

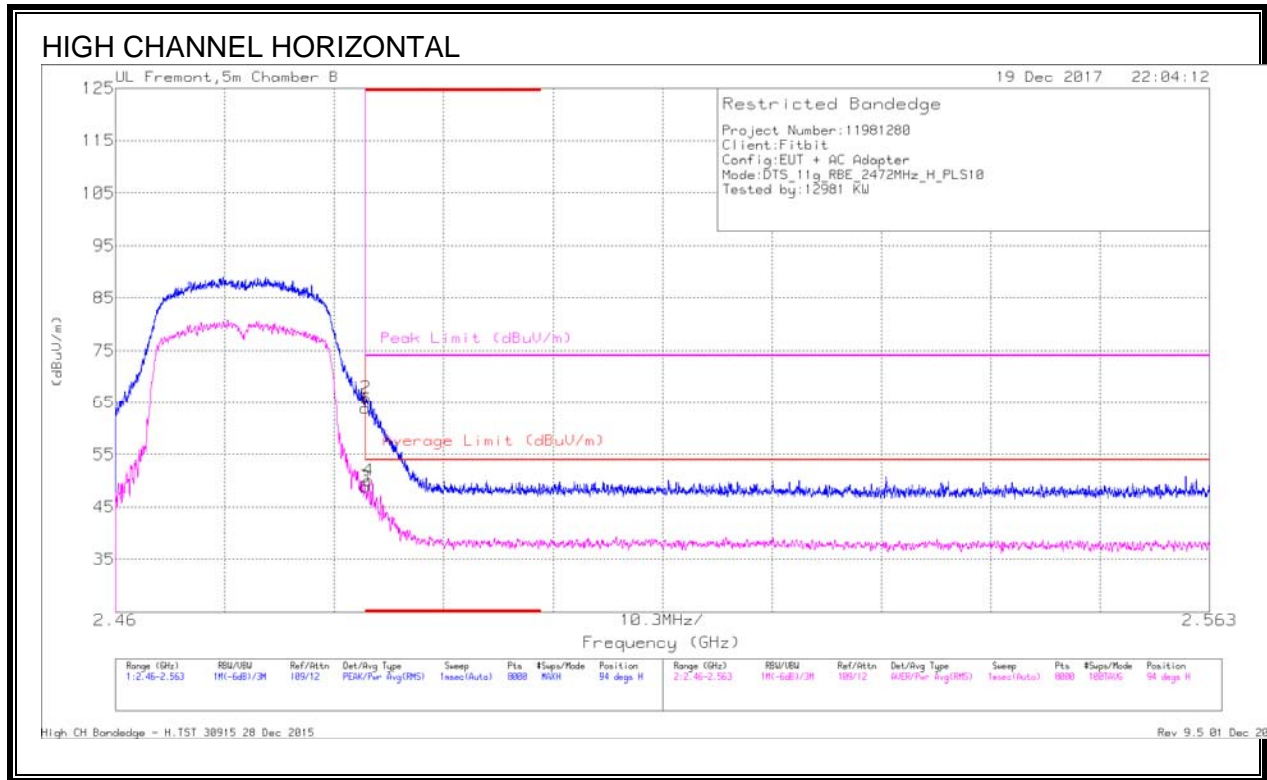

DATA

Marker	Frequency (GHz)	Meter Reading (dBuV)	Det	AF T663 (dB/m)	Amp/Ch/Filt/Pad (dB)	DC Corr (dB)	Corrected Reading (dBuV/m)	Average Limit (dBuV/m)	Margin (dB)	Peak Limit (dBuV/m)	PK Margin (dB)	Azimuth (Degs)	Height (cm)	Polarity
1	* 2.484	52.59	Pk	32.5	-21.3	0	63.79	-	-	74	-10.21	94	141	H
2	* 2.484	54.7	Pk	32.5	-21.3	0	65.9	-	-	74	-8.1	94	141	H
3	* 2.484	37.56	RMS	32.5	-21.3	0	48.76	54	-5.24	-	-	94	141	H
4	* 2.484	38.82	RMS	32.5	-21.3	0	50.02	54	-3.98	-	-	94	141	H

* - indicates frequency in CFR47 Pt 15 / IC RSS-Restricted Band

Pk - Peak detector

RMS - RMS detection

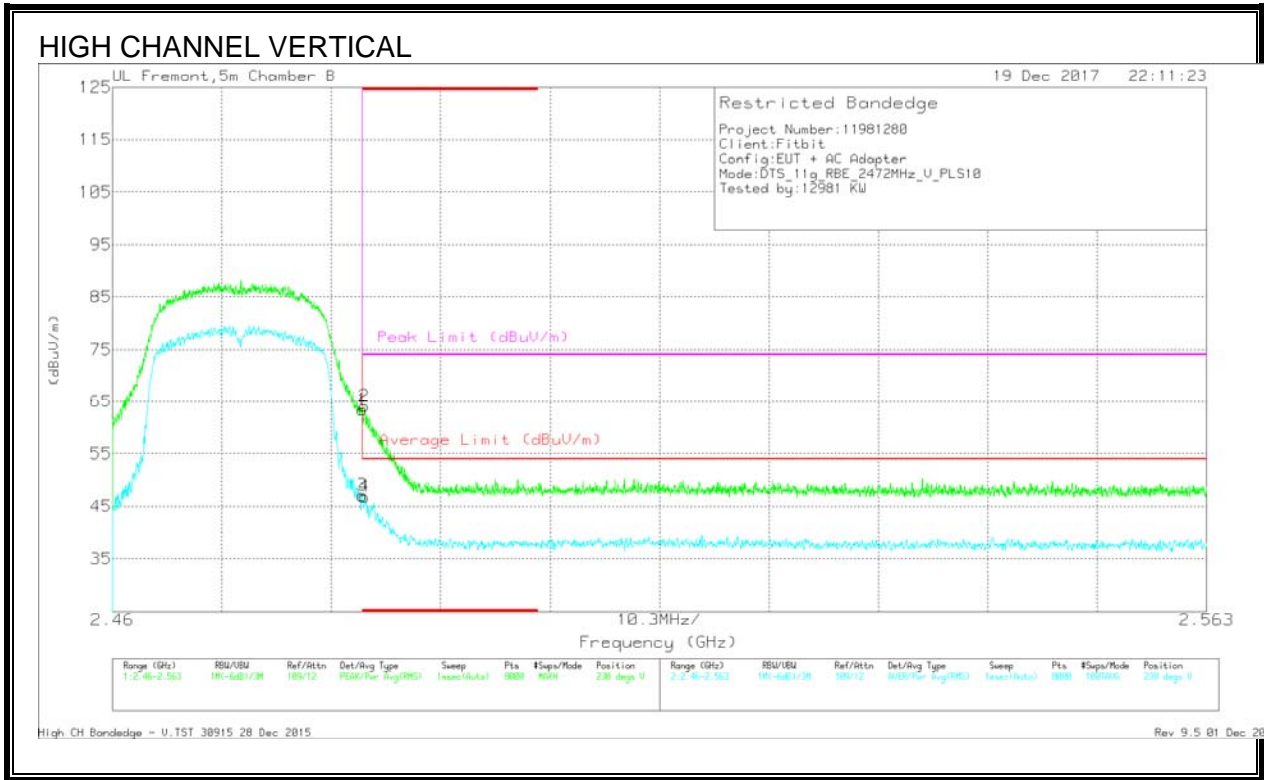

DATA

Marker	Frequency (GHz)	Meter Reading (dBuV)	Det	AF T863 (dB/m)	Amp/Ch/Flt/Pad (dB)	DC Corr (dB)	Corrected Reading (dBuV/m)	Average Limit (dBuV/m)	Margin (dB)	Peak Limit (dBuV/m)	PK Margin (dB)	Altitude (Degs)	Height (cm)	Polarity
1	* 2.484	52.19	Pk	32.5	-21.3	0	63.39	-	-	74	-10.61	238	124	V
2	* 2.484	52.93	Pk	32.5	-21.3	0	64.13	-	-	74	-9.87	238	124	V
3	* 2.484	35.92	RMS	32.5	-21.3	0	47.12	54	-6.88	-	-	238	124	V
4	* 2.484	35.6	RMS	32.5	-21.3	0	46.8	54	-7.2	-	-	238	124	V

* - indicates frequency in CFR47 Pt 15 / IC RSS-Restricted Band

Pk - Peak detector

RMS - RMS detection

HARMONICS AND SPURIOUS EMISSIONS LOW CHANNEL, CH 1)

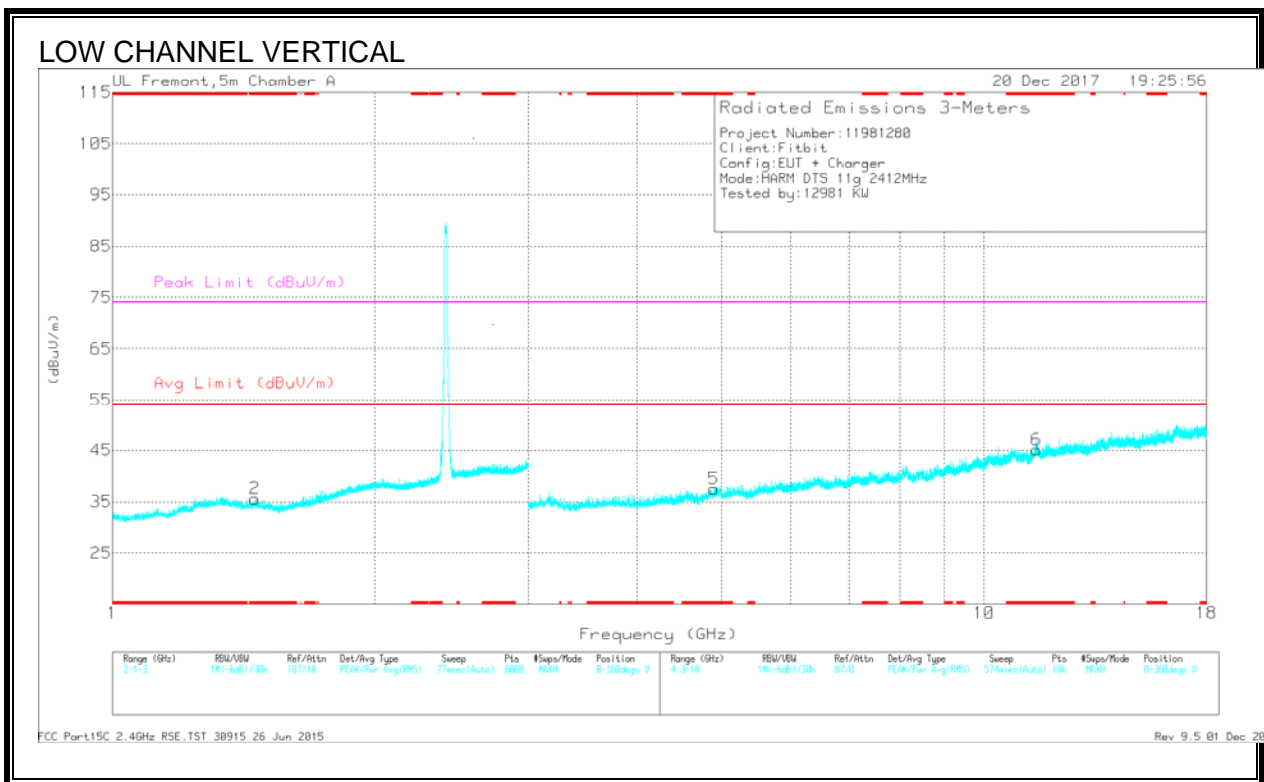
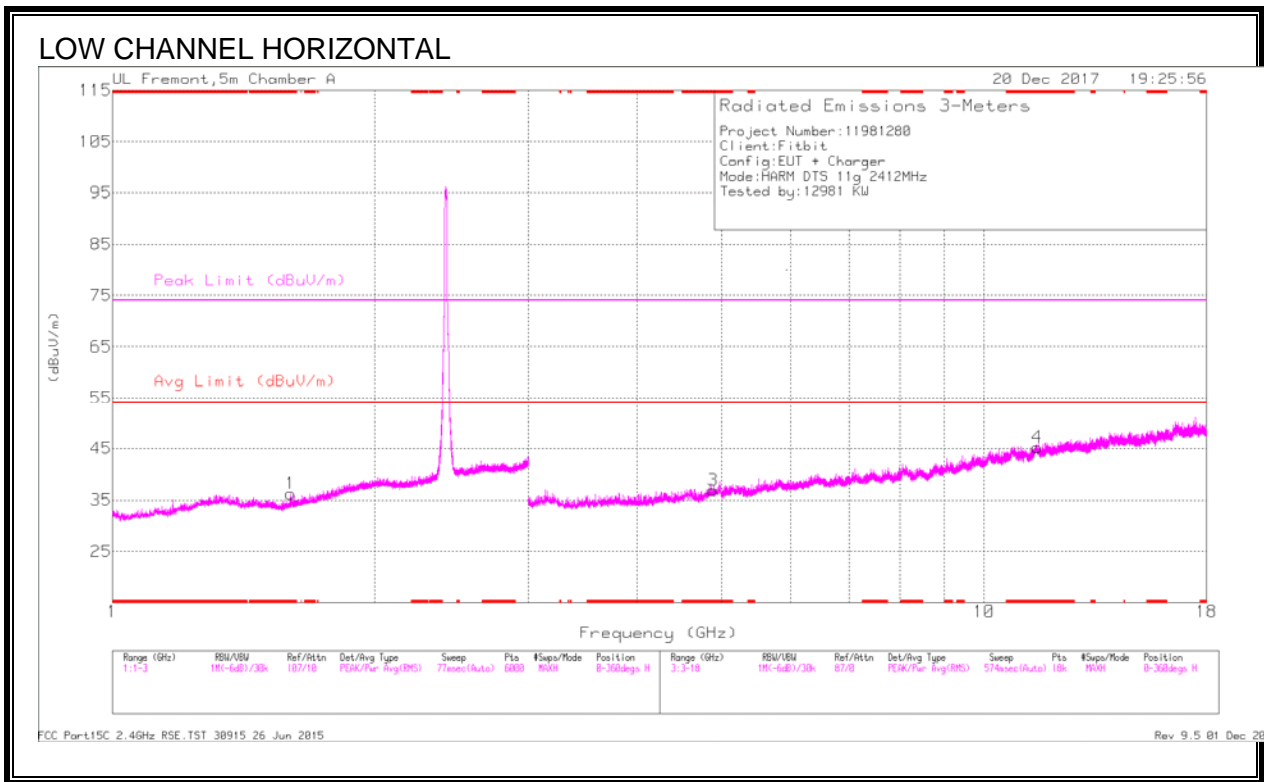

DATA

Marker	Frequency (GHz)	Meter Reading (dBuV)	Det	AF T862 (dB/m)	Amp/Cb1/Fitr/Paid (dB)	DC Corr (dB)	Corrected Reading (dBuV/m)	Avg Limit (dBuV/m)	Margin (dB)	Peak Limit (dBuV/m)	PK Margin (dB)	Azimuth (Degs)	Height (cm)	Polarity
1	* 1.602	36.29	PK2	28.2	-23.4	0	41.09	-	-	74	-32.91	311	181	H
	* 1.601	24.71	MAv1	28.2	-23.4	0	29.51	54	-24.49	-	-	311	181	H
2	* 1.457	36.53	PK2	28.7	-23.5	0	41.73	-	-	74	-32.27	325	101	V
	* 1.458	24.44	MAv1	28.7	-23.5	0	29.64	54	-24.36	-	-	325	101	V
3	* 4.886	35.56	PK2	34.1	-26.2	0	43.46	-	-	74	-30.54	78	172	H
	* 4.885	24.58	MAv1	34.1	-26.3	0	32.38	54	-21.62	-	-	78	172	H
4	* 11.503	31.76	PK2	38.3	-18.5	0	51.56	-	-	74	-22.44	120	149	H
	* 11.506	21.09	MAv1	38.3	-18.5	0	40.89	54	-13.11	-	-	120	149	H
5	* 4.897	35.99	PK2	34.1	-26.2	0	43.89	-	-	74	-30.11	192	189	V
	* 4.895	24.71	MAv1	34.1	-26.2	0	32.61	54	-21.39	-	-	192	189	V
6	* 11.49	32.17	PK2	38.3	-18.2	0	52.27	-	-	74	-21.73	110	135	V
	* 11.488	21.11	MAv1	38.3	-18.1	0	41.31	54	-12.69	-	-	110	135	V

* - indicates frequency in CFR47 Pt 15 / IC RSS-Restricted Band

PK2 - KDB558074 Method: Maximum Peak

MAv1 - KDB558074 Option 1 Maximum RMS Average

HARMONICS AND SPURIOUS EMISSIONS MID CHANNEL, CH 6)

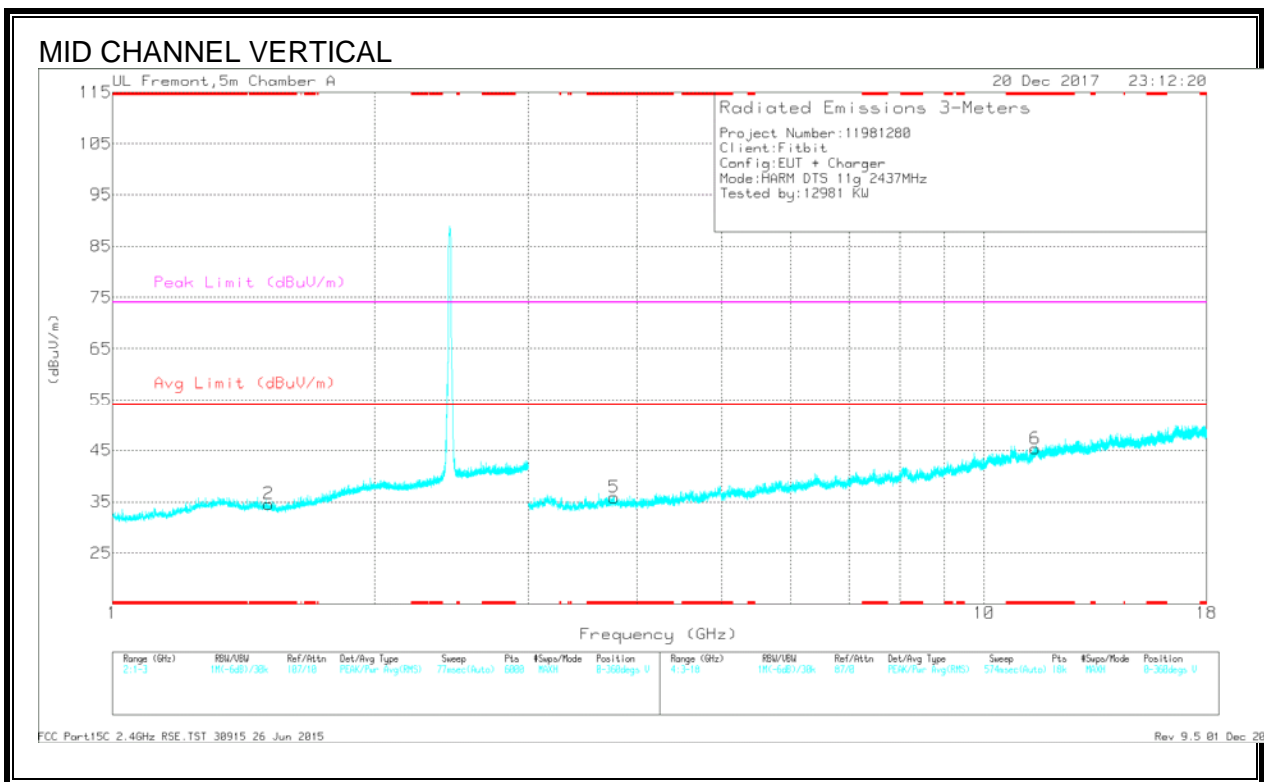
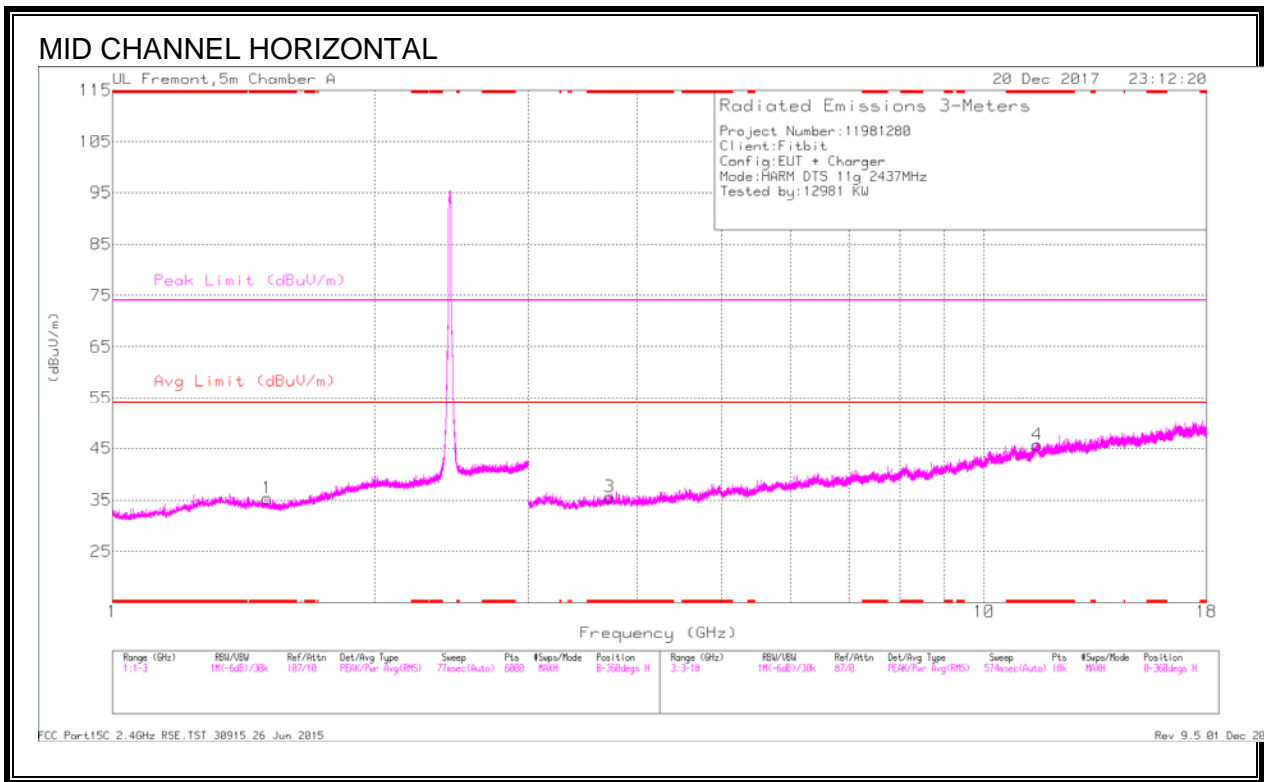

DATA

Marker	Frequency (GHz)	Meter Reading (dBuV)	Det	AF T862 (dB/m)	Amp/Cb1/Fitr/Pad (dB)	DC Corr (dB)	Corrected Reading (dBuV/m)	Avg Limit (dBuV/m)	Margin (dB)	Peak Limit (dBuV/m)	PK Margin (dB)	Azimuth (Degs)	Height (cm)	Polarity
1	* 1.506	36.4	PK2	28.3	-23.4	0	41.3	-	-	74	-32.7	91	160	H
	* 1.506	24.59	MAv1	28.3	-23.4	0	29.49	54	-24.51	-	-	91	160	H
2	* 1.513	36.48	PK2	28.2	-23.4	0	41.28	-	-	74	-32.72	115	173	V
	* 1.511	24.6	MAv1	28.3	-23.4	0	29.5	54	-24.5	-	-	115	173	V
3	* 3.721	38.12	PK2	33.1	-28.2	0	43.02	-	-	74	-30.98	231	131	H
	* 3.723	26.39	MAv1	33.1	-28.2	0	31.29	54	-22.71	-	-	231	131	H
4	* 11.511	31.62	PK2	38.3	-18.6	0	51.32	-	-	74	-22.68	181	189	H
	* 11.511	20.92	MAv1	38.3	-18.6	0	40.62	54	-13.38	-	-	181	189	H
5	* 3.768	37.13	PK2	33.2	-28.4	0	41.93	-	-	74	-32.07	291	193	V
	* 3.768	26.28	MAv1	33.2	-28.4	0	31.08	54	-22.92	-	-	291	193	V
6	* 11.452	31.58	PK2	38.2	-18.4	0	51.38	-	-	74	-22.62	55	153	V
	* 11.451	21	MAv1	38.2	-18.4	0	40.8	54	-13.2	-	-	55	153	V

* - indicates frequency in CFR47 Pt 15 / IC RSS-Restricted Band

PK2 - KDB558074 Method: Maximum Peak

MAv1 - KDB558074 Option 1 Maximum RMS Average

HARMONICS AND SPURIOUS EMISSIONS HIGH CHANNEL, CH 13)

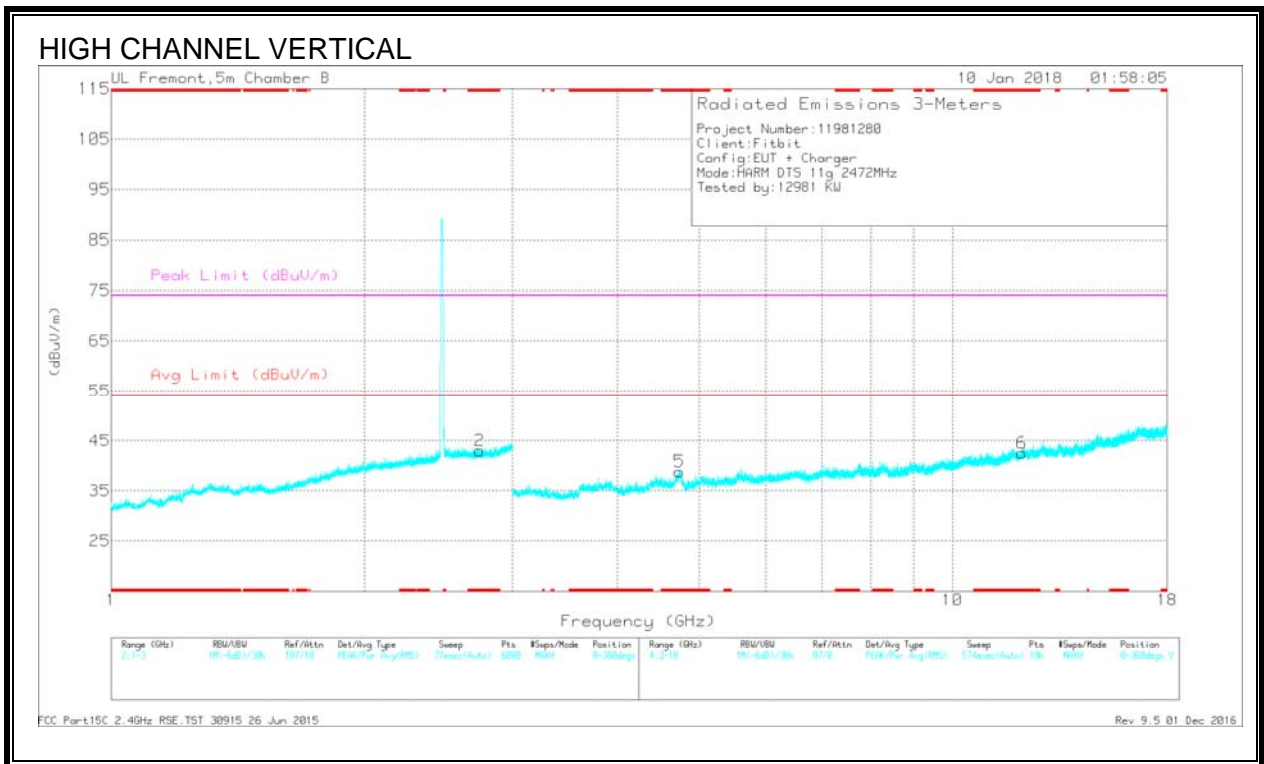
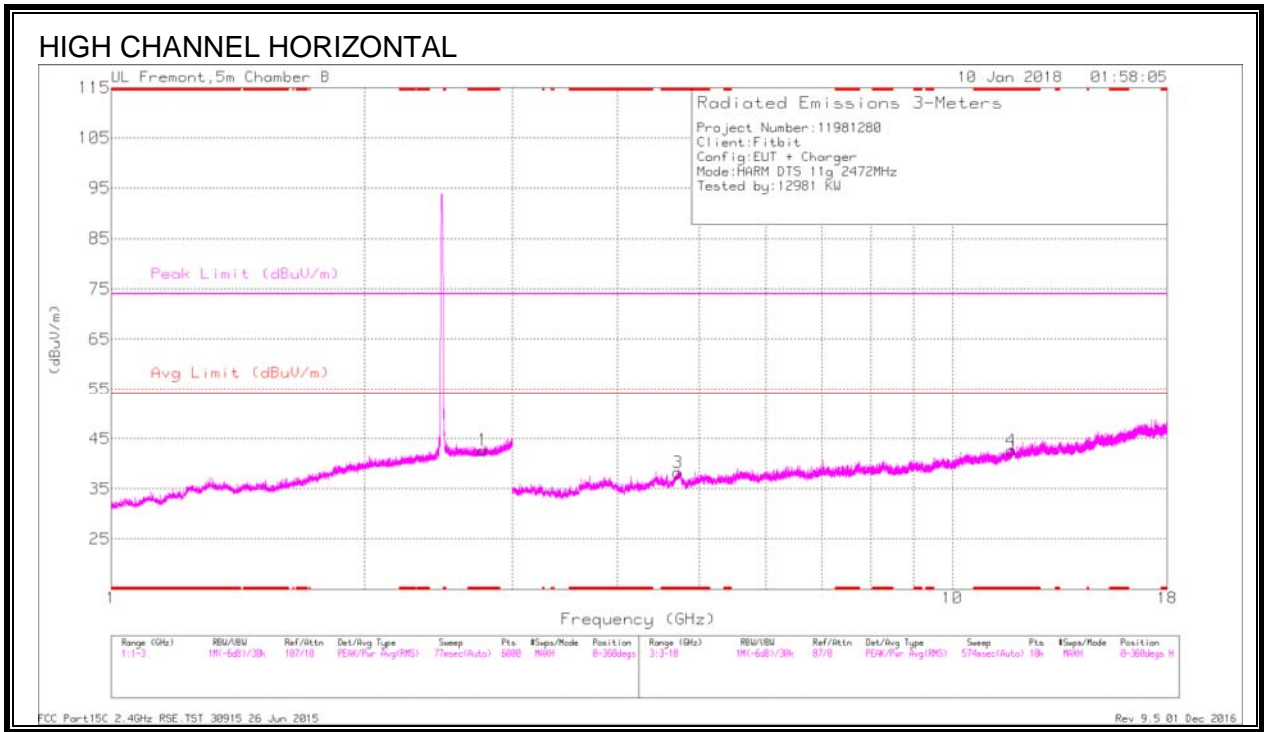

DATA

Marker	Frequency (GHz)	Meter Reading (dBuV)	Det	AF T863 (dB/m)	Amp/Cbi/Filtr/ Pad (dB)	DC Corr (dB)	Corrected Reading (dBuV/m)	Avg Limit (dBuV/m)	Margin (dB)	Peak Limit (dBuV/m)	PK Margin (dB)	Azimuth (Degs)	Height (cm)	Polarity
1	* 2.769	36.92	PK2	32.3	-20.8	0	48.42	-	-	74	-25.58	36	110	H
	* 2.769	25.39	MAv1	32.3	-20.8	0	36.89	54	-17.11	-	-	36	110	H
2	* 2.745	36.4	PK2	32.3	-20.8	0	47.9	-	-	74	-26.1	253	159	V
	* 2.742	25.1	MAv1	32.3	-20.8	0	36.6	54	-17.4	-	-	253	159	V
3	* 4.717	40.21	PK2	34.2	-29.9	0	44.51	-	-	74	-29.49	265	230	H
	* 4.719	29.4	MAv1	34.2	-29.9	0	33.7	54	-20.3	-	-	265	230	H
4	* 11.741	34.17	PK2	38.5	-24	0	48.67	-	-	74	-25.33	162	144	H
	* 11.738	23.71	MAv1	38.5	-24.1	0	38.11	54	-15.89	-	-	162	144	H
5	* 4.737	40.79	PK2	34.2	-29.5	0	45.49	-	-	74	-28.51	172	199	V
	* 4.736	29.61	MAv1	34.2	-29.5	0	34.31	54	-19.69	-	-	172	199	V
6	* 12.092	34.5	PK2	38.9	-24	0	49.4	-	-	74	-24.6	91	114	V
	* 12.094	23.61	MAv1	38.9	-24	0	38.51	54	-15.49	-	-	91	114	V

* - indicates frequency in CFR47 Pt 15 / IC RSS-Restricted Band

PK2 - KDB558074 Method: Maximum Peak

MAv1 - KDB558074 Option 1 Maximum RMS Average

9.2.3. 802.11n HT20 MODE IN THE 2.4 GHz BAND

AUTHORIZED BANDEDGE (LOW CHANNEL, CH 1)

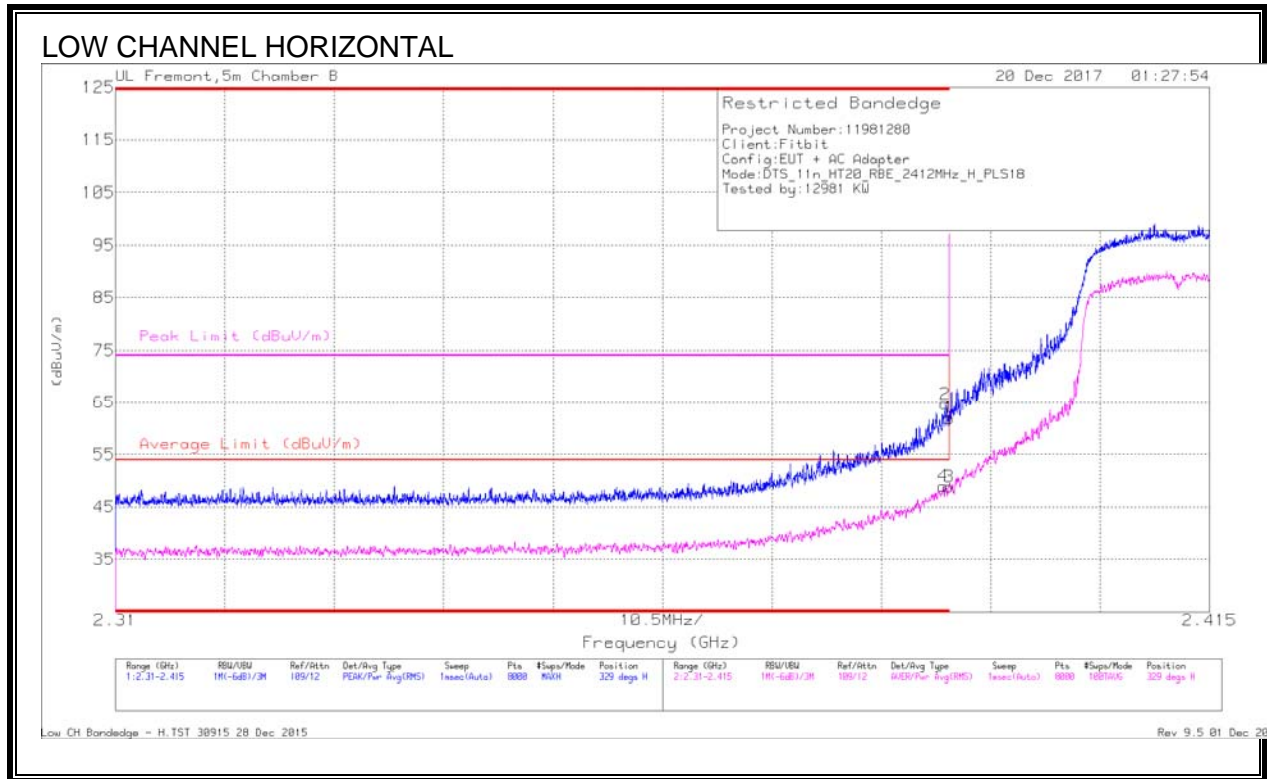

DATA

Marker	Frequency (GHz)	Meter Reading (dBuV)	Det	AF T863 (dB/m)	Amp/Cb/Ftr/Pad (dB)	DC Corr (dB)	Corrected Reading (dBuV/m)	Average Limit (dBuV/m)	Margin (dB)	Peak Limit (dBuV/m)	PK Margin (dB)	Asimuth (Degs)	Height (cm)	Polarity
4	* 2.389	38.23	RMS	32	-21.3	0	48.93	54	-5.07	-	-	329	225	H
1	* 2.39	51.3	Pk	32	-21.3	0	62	-	-	74	-12	329	225	H
2	* 2.39	53.96	Pk	32	-21.3	0	64.66	-	-	74	-9.34	329	225	H
3	* 2.39	38.07	RMS	32	-21.3	0	48.77	54	-5.23	-	-	329	225	H

* - indicates frequency in CFR47 Pt 15 / IC RSS-Restricted Band

Pk - Peak detector

RMS - RMS detection

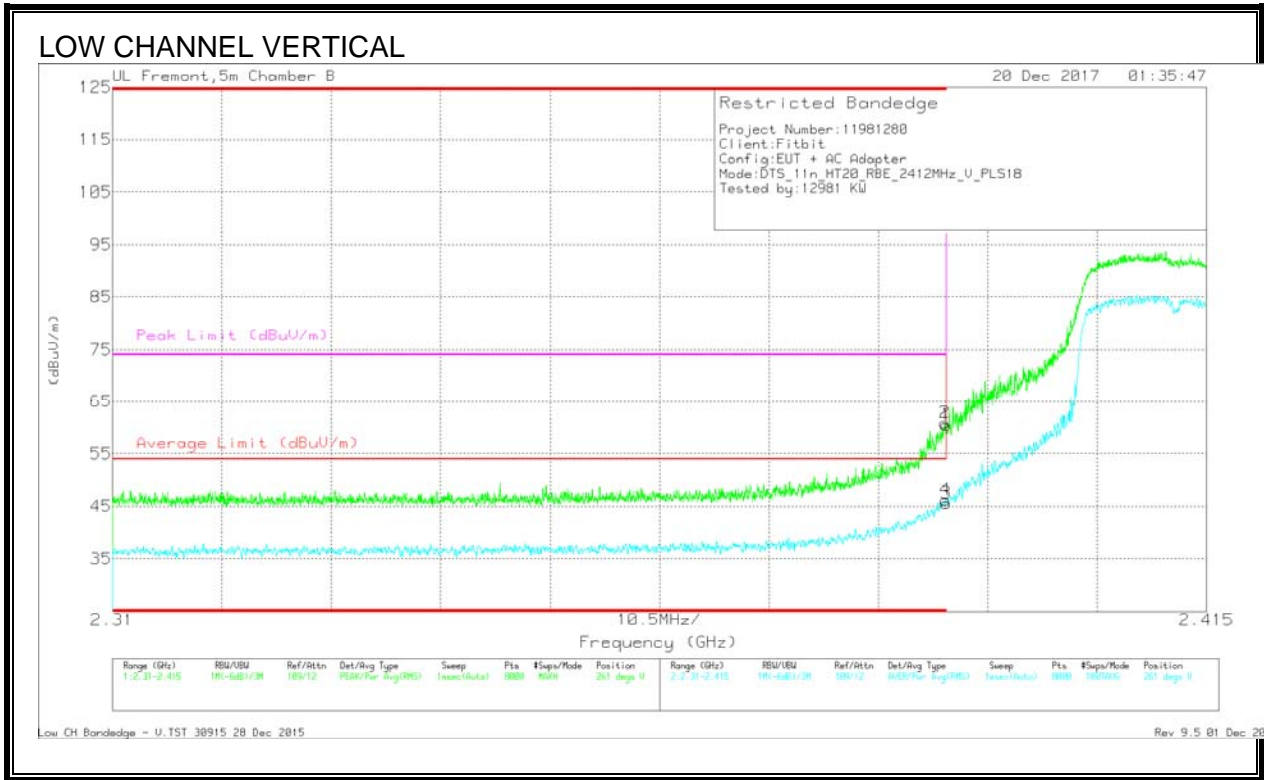

DATA

Marker	Frequency (GHz)	Meter Reading (dBuV)	Det	AF T863 (dB/m)	Amp/Cbl/Ftr/Pad (dB)	DC Corr (dB)	Corrected Reading (dBuV/m)	Average Limit (dBuV/m)	Margin (dB)	Peak Limit (dBuV/m)	PK Margin (dB)	Azimuth (Degs)	Height (cm)	Polarity
1	* 2.39	49.74	Pk	32	-21.3	0	60.44	-	-	74	-13.56	261	298	V
2	* 2.39	50.14	Pk	32	-21.3	0	60.84	-	-	74	-13.16	261	298	V
3	* 2.39	34.86	RMS	32	-21.3	0	45.56	54	-8.44	-	-	261	298	V
4	* 2.39	35.53	RMS	32	-21.3	0	46.23	54	-7.77	-	-	261	298	V

* - indicates frequency in CFR47 Pt 15 / IC RSS-Restricted Band
 Pk - Peak detector
 RMS - RMS detection

AUTHORIZED BANDEGE (LOW CHANNEL, CH 2)

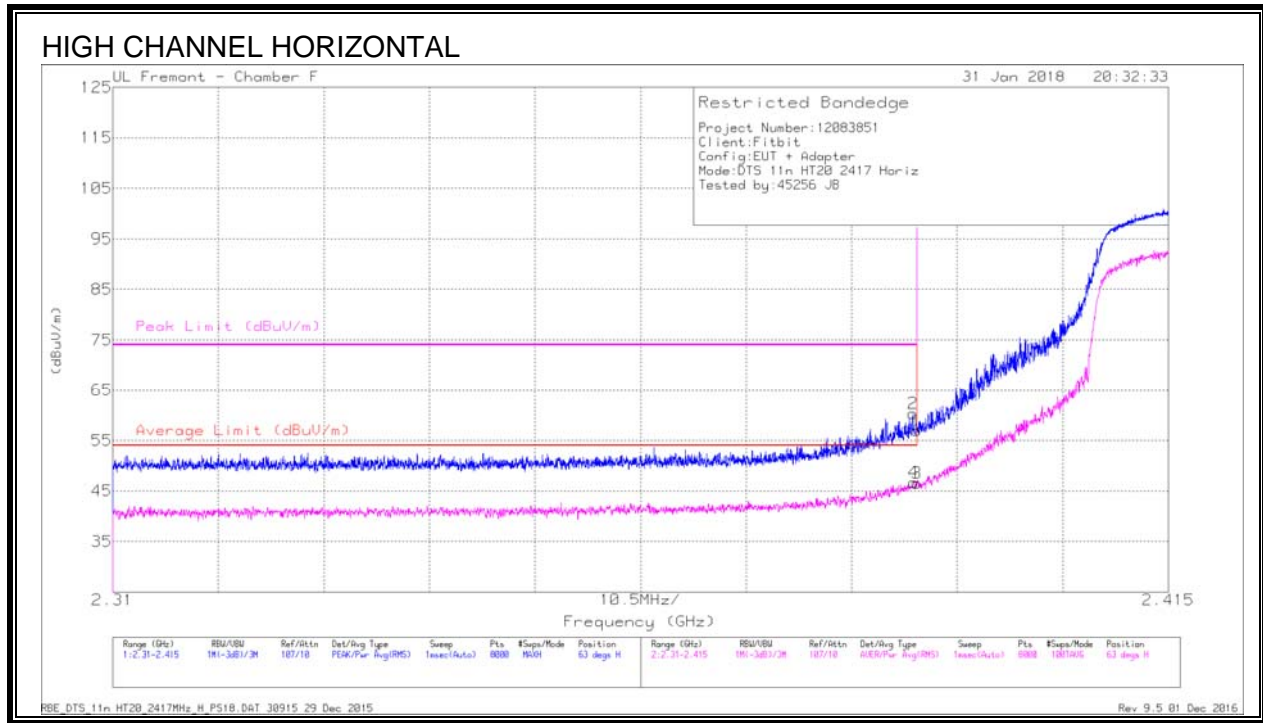

DATA

Marker	Frequency (GHz)	Meter Reading (dBuV)	Det	AF T119 (dB/m)	Amp/Cb/Filt/Pad (dB)	DC Corr (dB)	Corrected Reading (dBuV/m)	Average Limit (dBuV/m)	Margin (dB)	Peak Limit (dBuV/m)	PK Margin (dB)	Azimuth (Degs)	Height (cm)	Polarity
1	* 2.39	45.68	Pk	31.9	-20.6	0	56.98	-	-	74	-17.02	63	319	H
2	* 2.39	49.05	Pk	31.9	-20.6	0	60.35	-	-	74	-13.65	63	319	H
3	* 2.39	35.26	RMS	31.9	-20.6	0	46.56	54	-7.44	-	-	63	319	H
4	* 2.39	35.44	RMS	31.9	-20.6	0	46.74	54	-7.26	-	-	63	319	H

* - indicates frequency in CFR47 Pt 15 / IC RSS-Restricted Band

Pk - Peak detector

RMS - RMS detection

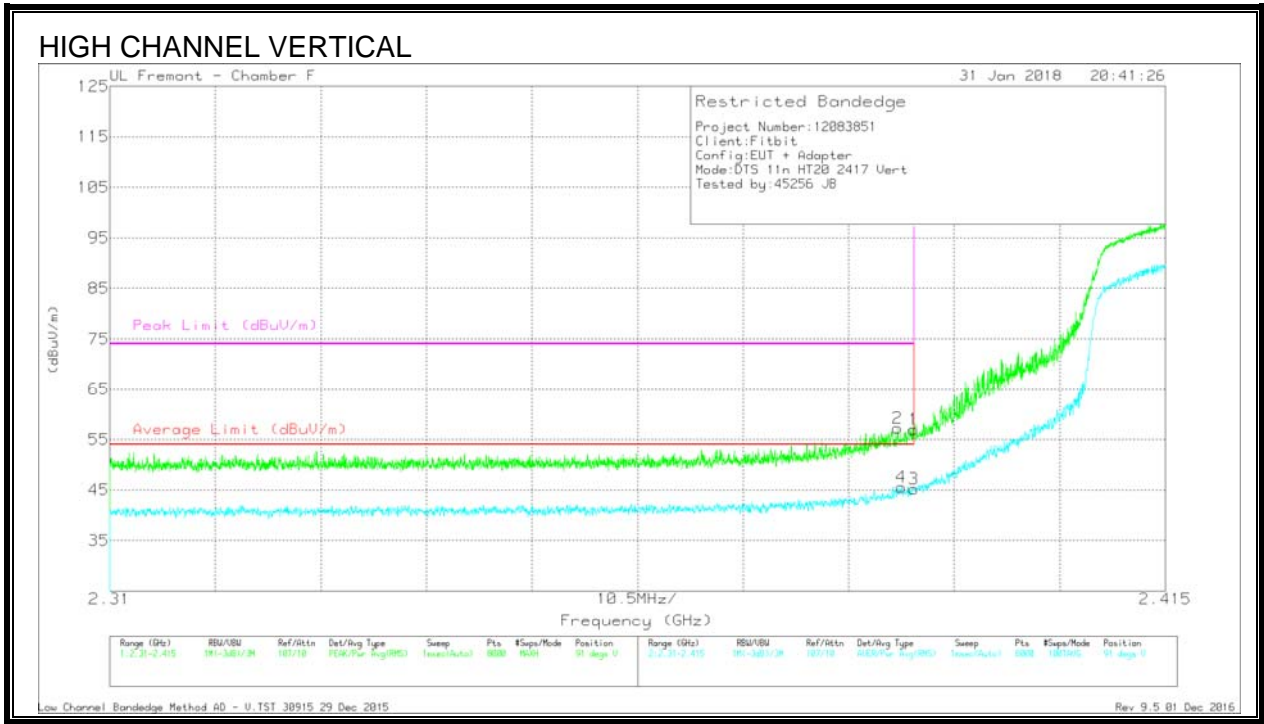

DATA

Marker	Frequency (GHz)	Meter Reading (dBuV)	Det	AF T119 (dB/m)	Amp/Ch/Filt/Pad (dB)	DC Corr (dB)	Corrected Reading (dBuV/m)	Average Limit (dBuV/m)	Margin (dB)	Peak Limit (dBuV/m)	PK Margin (dB)	Azimuth (Degs)	Height (cm)	Polarity
1	* 2.39	45.69	Pk	31.9	-20.6	0	56.99	-	-	74	-17.01	91	266	V
2	* 2.388	45.94	Pk	31.9	-20.6	0	57.24	-	-	74	-16.76	91	266	V
3	* 2.39	33.85	RMS	31.9	-20.6	0	45.15	54	-8.85	-	-	91	266	V
4	* 2.389	34.32	RMS	31.9	-20.6	0	45.62	54	-8.38	-	-	91	266	V

* - indicates frequency in CFR47 Pt 15 / IC RSS-Restricted Band
 Pk - Peak detector
 RMS - RMS detection

AUTHORIZED BANDEGE (HIGH CHANNEL, CH 10)

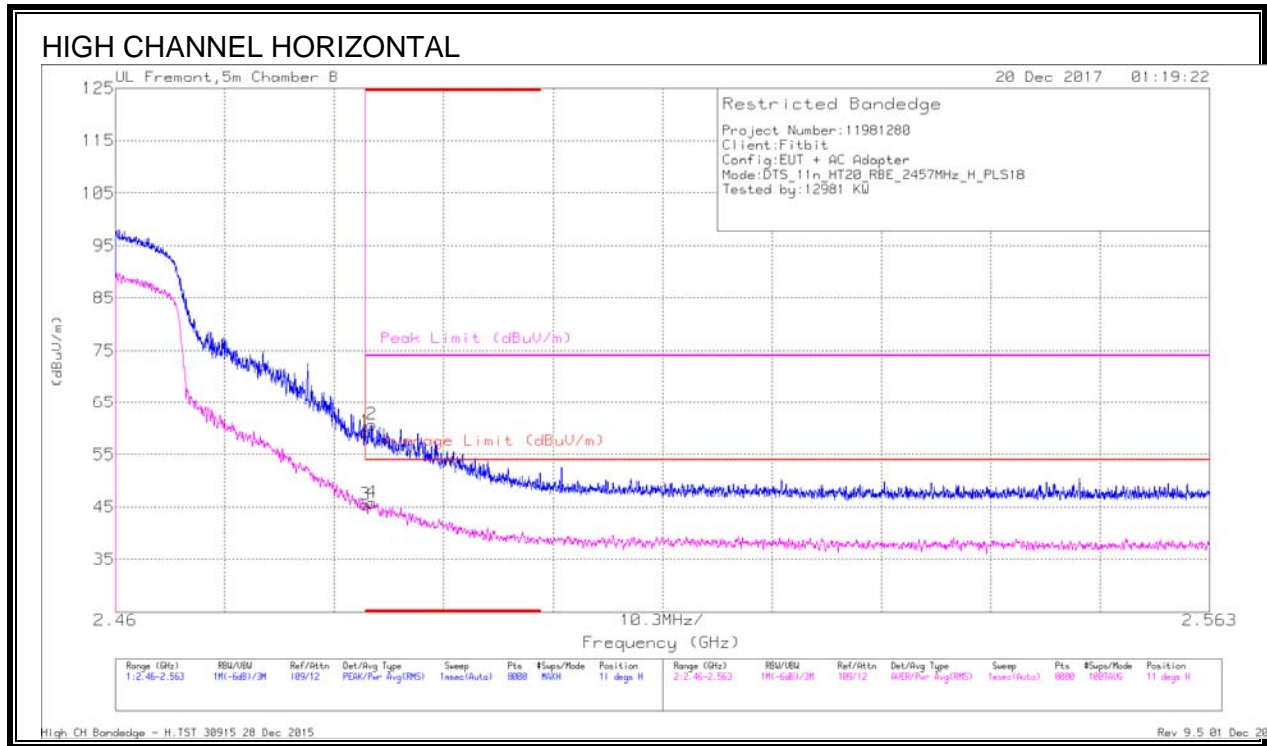

DATA

Marker	Frequency (GHz)	Meter Reading (dBuV)	Det	AF T863 (dB/m)	Amp/Ch/Fltr/Pad (dB)	DC Corr (dB)	Corrected Reading (dBuV/m)	Average Limit (dBuV/m)	Margin (dB)	Peak Limit (dBuV/m)	PK Margin (dB)	Azimuth (Degs)	Height (cm)	Polarity
1	* 2.484	48.18	Pk	32.5	-21.3	0	59.38	-	-	74	-14.62	11	142	H
2	* 2.484	49.5	Pk	32.5	-21.3	0	60.7	-	-	74	-13.3	11	142	H
3	* 2.484	34.26	RMS	32.5	-21.3	0	45.46	54	-8.54	-	-	11	142	H
4	* 2.484	34.59	RMS	32.5	-21.3	0	45.79	54	-8.21	-	-	11	142	H

* - indicates frequency in CFR47 Pt 15 / IC RSS-Restricted Band

Pk - Peak detector

RMS - RMS detection

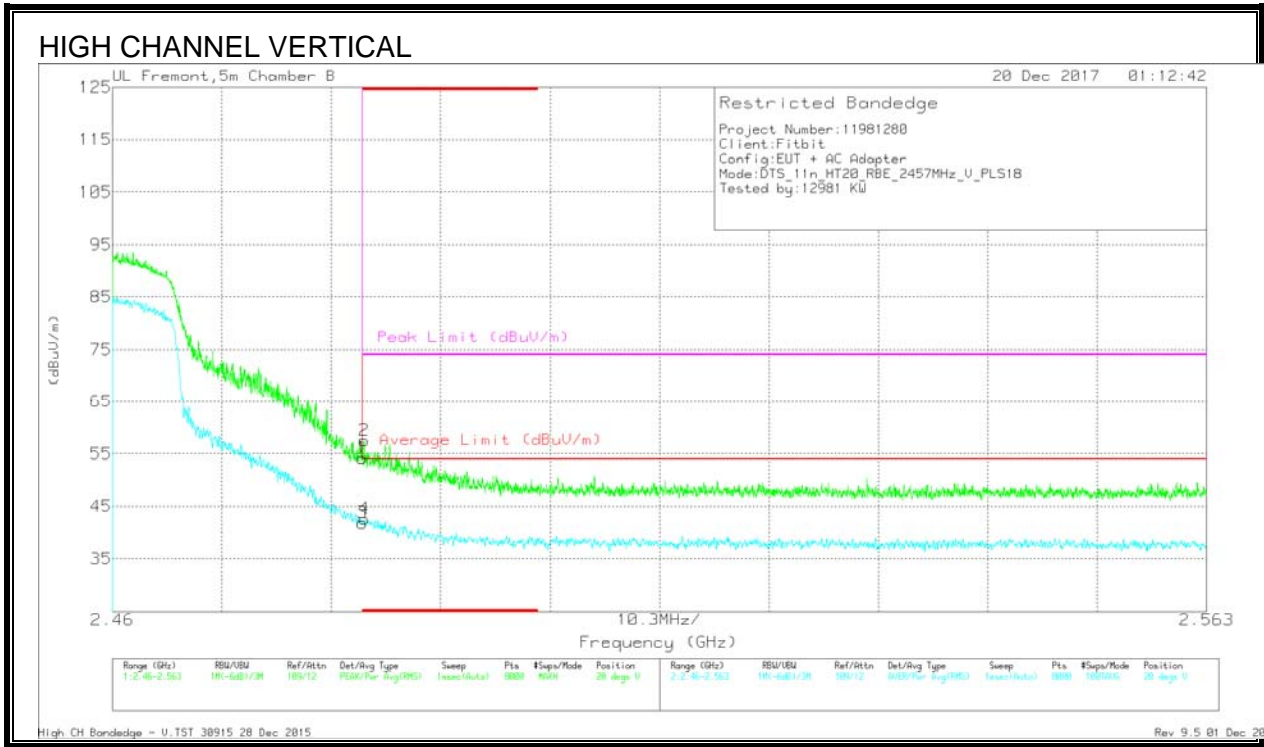

DATA

Marker	Frequency (GHz)	Meter Reading (dBuV)	Det	AF 1863 (dB/m)	Amp/Cb/Ftr/Pad (dB)	DC Corr (dB)	Corrected Reading (dBuV/m)	Average Limit (dBuV/m)	Margin (dB)	Peak Limit (dBuV/m)	PK Margin (dB)	Azimuth (Degs)	Height (cm)	Polarity
1	* 2.484	42.98	Pk	32.5	-21.3	0	54.18	-	-	74	-19.82	28	224	V
2	* 2.484	46.25	Pk	32.5	-21.3	0	57.45	-	-	74	-16.55	28	224	V
3	* 2.484	30.59	RMS	32.5	-21.3	0	41.79	54	-12.21	-	-	28	224	V
4	* 2.484	31.42	RMS	32.5	-21.3	0	42.62	54	-11.38	-	-	28	224	V

* - indicates frequency in CFR47 Pt 15 / IC RSS-Restricted Band
 Pk - Peak detector
 RMS - RMS detection

AUTHORIZED BANDEGE (HIGH CHANNEL, CH 11)

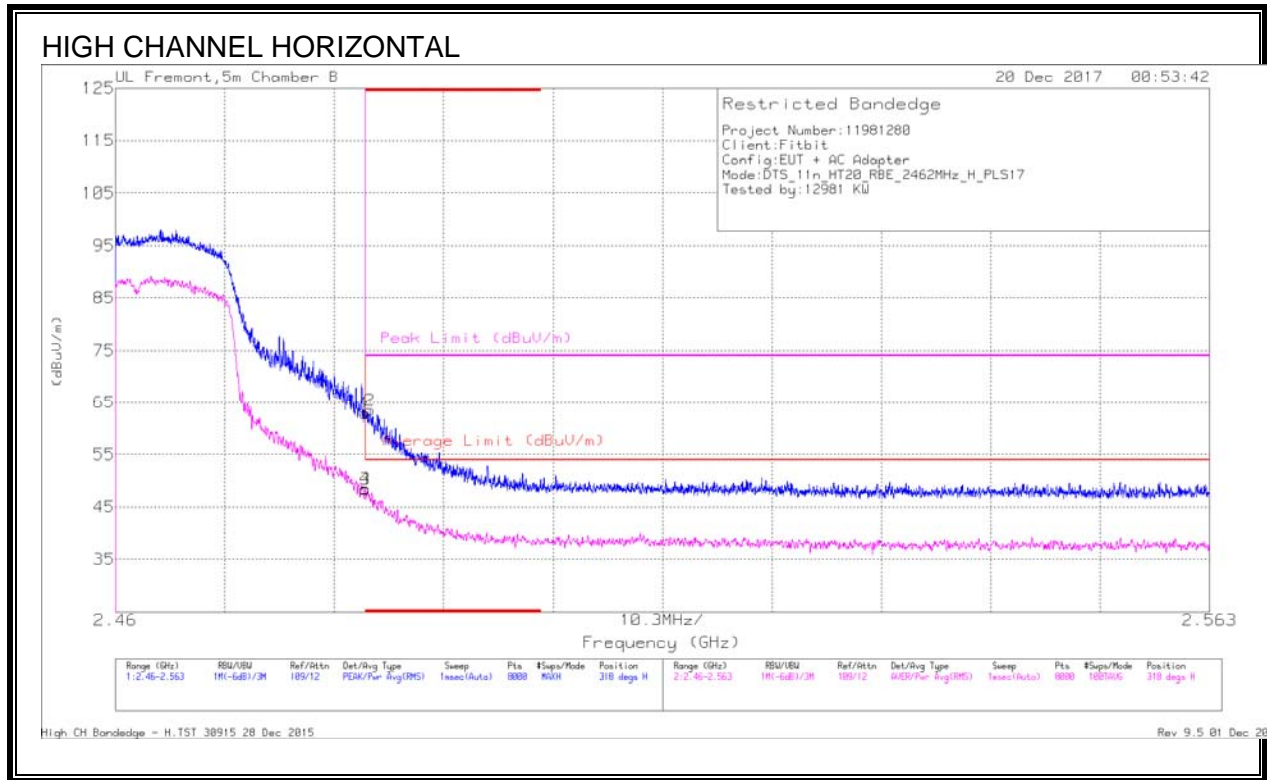

DATA

Marker	Frequency (GHz)	Meter Reading (dBuV)	Det	AF T863 (dB/m)	Amp/Ch/Filt/Pad (dB)	DC Corr (dB)	Corrected Reading (dBuV/m)	Average Limit (dBuV/m)	Margin (dB)	Peak Limit (dBuV/m)	PK Margin (dB)	Azimuth (Degs)	Height (cm)	Polarity
1	* 2.484	51.69	Pk	32.5	-21.3	0	62.89	-	-	74	-11.11	318	213	H
2	* 2.484	52.22	Pk	32.5	-21.3	0	63.42	-	-	74	-10.58	318	213	H
3	* 2.484	37.12	RMS	32.5	-21.3	0	48.32	54	-5.68	-	-	318	213	H
4	* 2.484	37.24	RMS	32.5	-21.3	0	48.44	54	-5.56	-	-	318	213	H

* - indicates frequency in CFR47 Pt 15 / IC RSS-Restricted Band
 Pk - Peak detector
 RMS - RMS detection

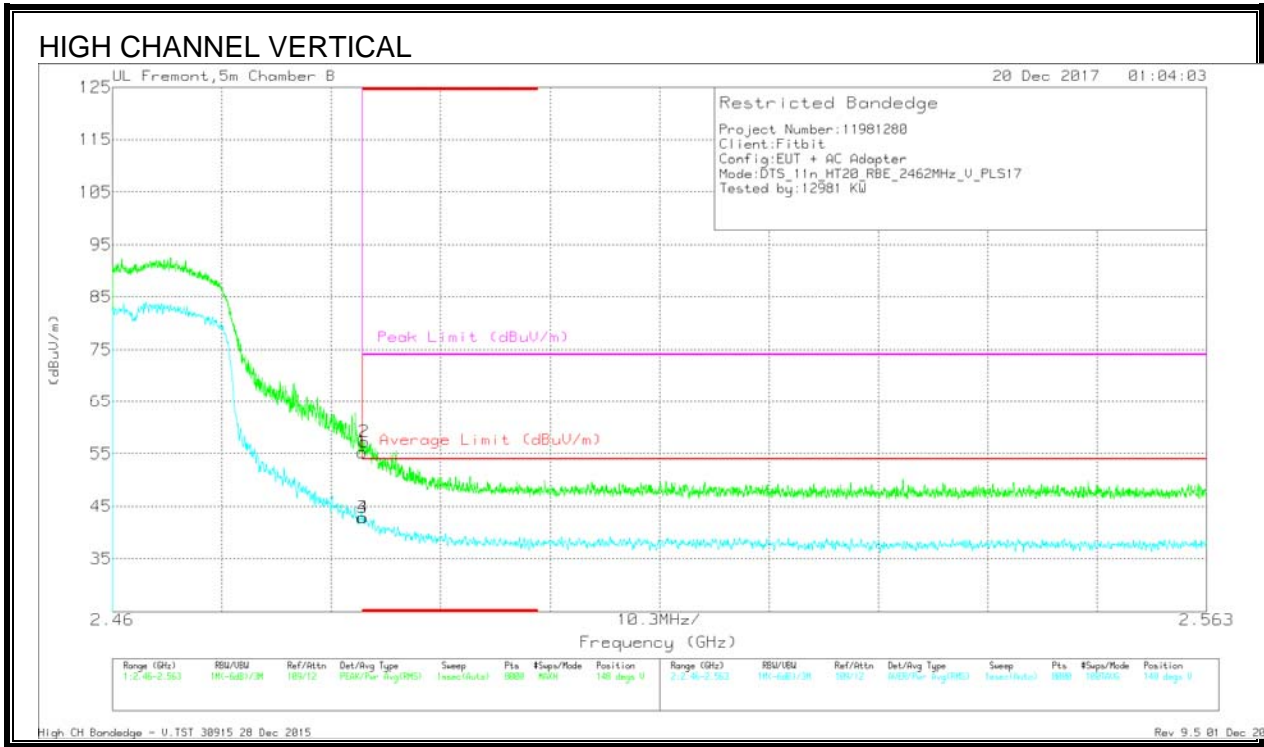

DATA

Marker	Frequency (GHz)	Meter Reading (dBuV)	Det	AF 1863 (dB/m)	Amp/Ch/Fltr/Pad (dB)	DC Corr (dB)	Corrected Reading (dBuV/m)	Average Limit (dBuV/m)	Margin (dB)	Peak Limit (dBuV/m)	PK Margin (dB)	Azimuth (Degs)	Height (cm)	Polarity
1	* 2.484	44.12	Pk	32.5	-21.3	0	55.32	-	-	74	-18.68	148	218	V
2	* 2.484	45.99	Pk	32.5	-21.3	0	57.19	-	-	74	-16.81	148	218	V
3	* 2.484	31.63	RMS	32.5	-21.3	0	42.83	54	-11.17	-	-	148	218	V
4	* 2.484	31.63	RMS	32.5	-21.3	0	42.83	54	-11.17	-	-	148	218	V

* - indicates frequency in CFR47 Pt 15 / IC RSS-Restricted Band

Pk - Peak detector

RMS - RMS detection

AUTHORIZED BANDEGE (HIGH CHANNEL, CH 12)

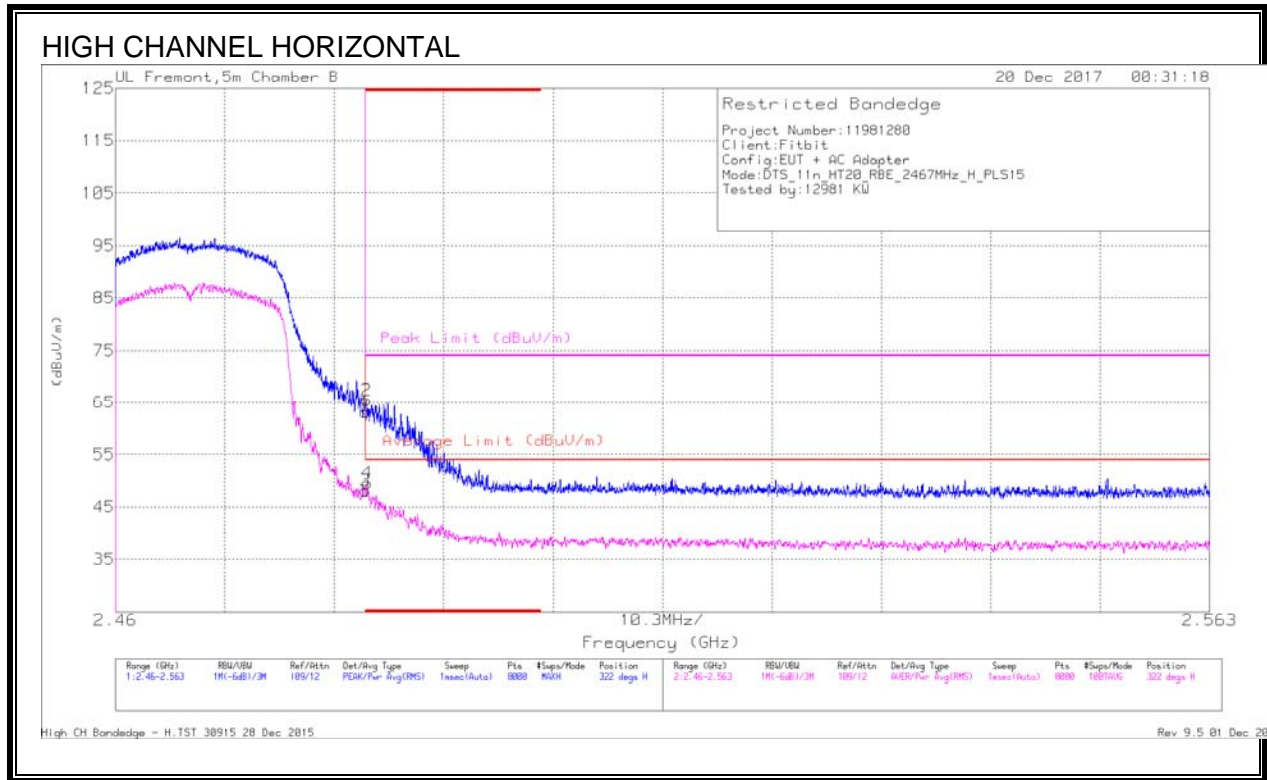

DATA

Marker	Frequency (GHz)	Meter Reading (dBuV)	Det	AF T863 (dB/m)	Amp/Ch/Filt/Pad (dB)	DC Corr (dB)	Corrected Reading (dBuV/m)	Average Limit (dBuV/m)	Margin (dB)	Peak Limit (dBuV/m)	PK Margin (dB)	Azimuth (Degs)	Height (cm)	Polarity
1	* 2.484	51.86	Pk	32.5	-21.3	0	63.06	-	-	74	-10.94	322	215	H
2	* 2.484	54.22	Pk	32.5	-21.3	0	65.42	-	-	74	-8.58	322	215	H
3	* 2.484	36.88	RMS	32.5	-21.3	0	48.08	54	-5.92	-	-	322	215	H
4	* 2.484	38.32	RMS	32.5	-21.3	0	49.52	54	-4.48	-	-	322	215	H

* - indicates frequency in CFR47 Pt 15 / IC RSS-Restricted Band

Pk - Peak detector

RMS - RMS detection

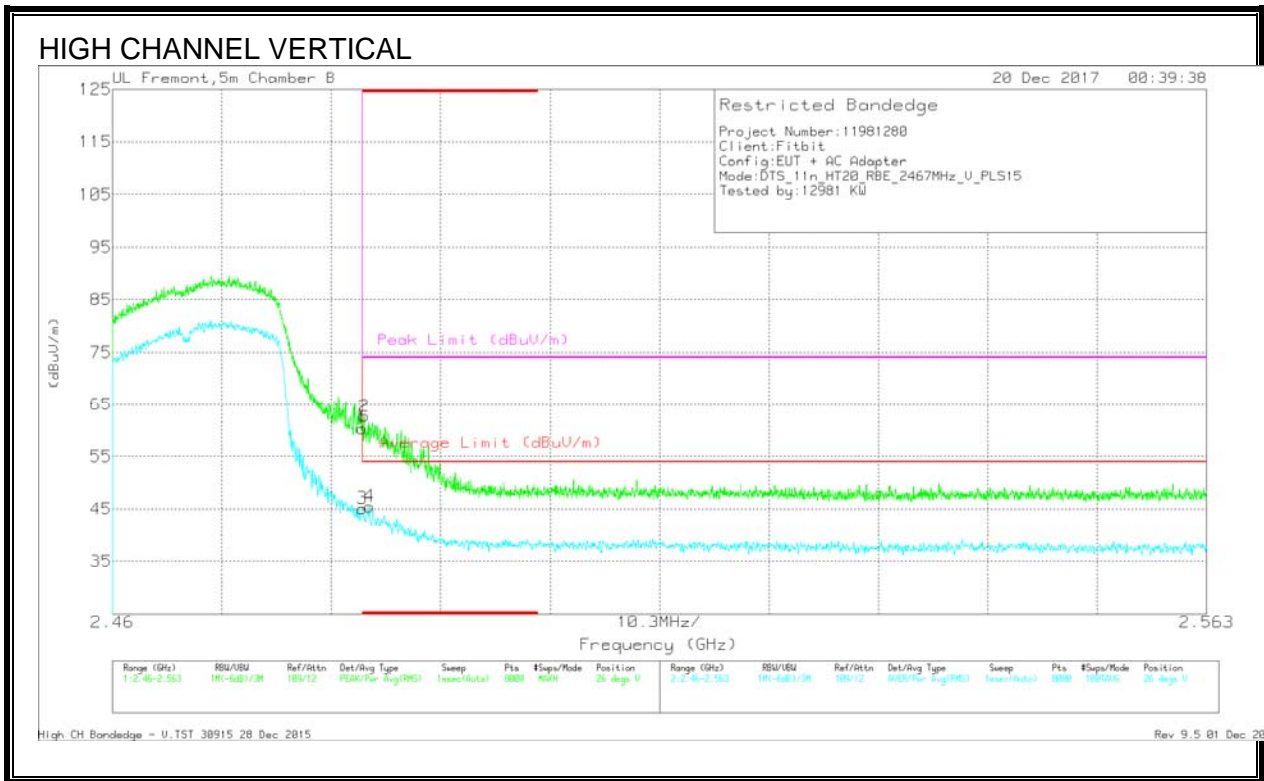

DATA

Marker	Frequency (GHz)	Meter Reading (dBuV)	Det	AF 1863 (dB/m)	Amp/Cb/Filter/Pad (dB)	DC Corr (dB)	Corrected Reading (dBuV/m)	Average Limit (dBuV/m)	Margin (dB)	Peak Limit (dBuV/m)	PK Margin (dB)	Azimuth (Degs)	Height (cm)	Polarity
1	* 2.484	49.13	Pk	32.5	-21.3	0	60.33	-	-	74	-13.67	26	349	V
2	* 2.484	51.49	Pk	32.5	-21.3	0	62.69	-	-	74	-11.31	26	349	V
3	* 2.484	33.82	RMS	32.5	-21.3	0	45.02	54	-8.98	-	-	26	349	V
4	* 2.484	34.22	RMS	32.5	-21.3	0	45.42	54	-8.58	-	-	26	349	V

* - indicates frequency in CFR47 Pt 15 / IC RSS-Restricted Band

Pk - Peak detector

RMS - RMS detection

AUTHORIZED BANDEGE (HIGH CHANNEL, CH 13)

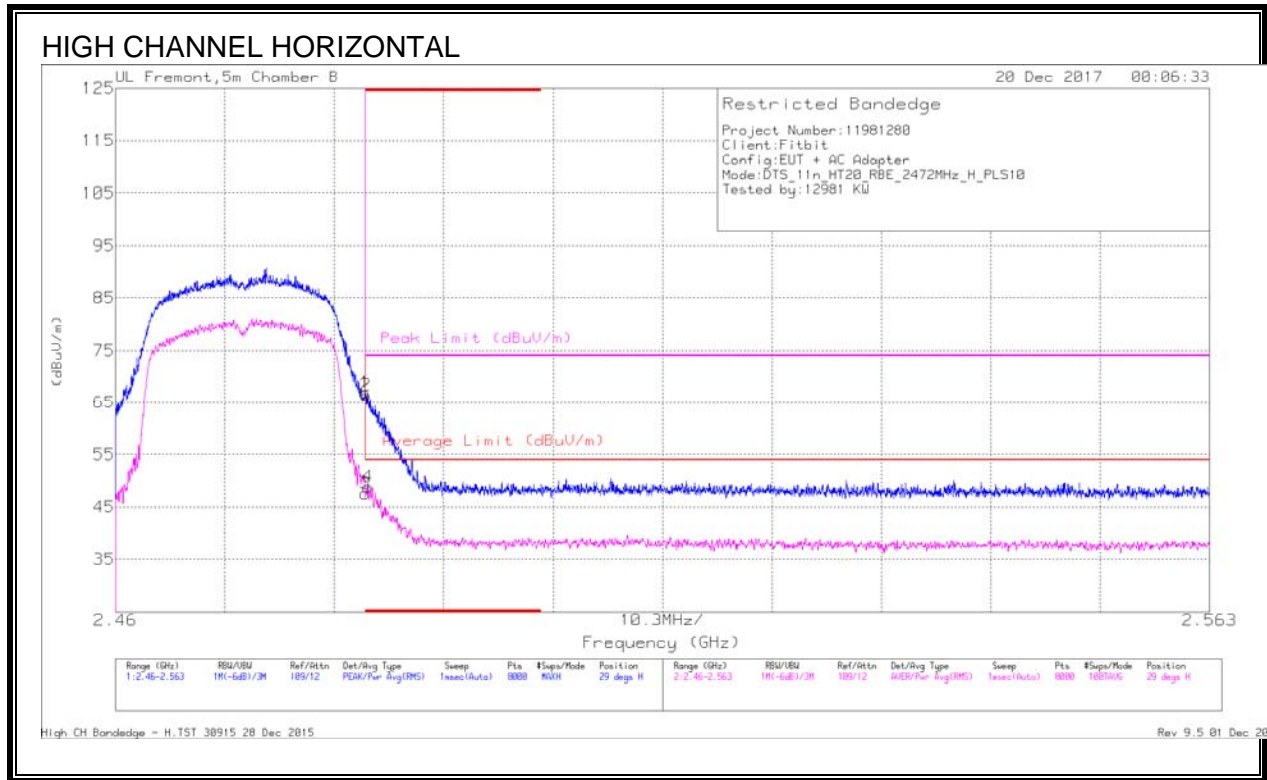

DATA

Marker	Frequency (GHz)	Meter Reading (dBuV)	Det	AF T863 (dB/m)	Amp/Ch/Filt/Pad (dB)	DC Corr (dB)	Corrected Reading (dBuV/m)	Average Limit (dBuV/m)	Margin (dB)	Peak Limit (dBuV/m)	PK Margin (dB)	Azimuth (Degs)	Height (cm)	Polarity
1	* 2.484	55.69	Pk	32.5	-21.3	0	66.89	-	-	74	-7.11	29	297	H
2	* 2.484	55.24	Pk	32.5	-21.3	0	66.44	-	-	74	-7.56	29	297	H
3	* 2.484	36.4	RMS	32.5	-21.3	0	47.60	54	-6.40	-	-	29	297	H
4	* 2.484	37.62	RMS	32.5	-21.3	0	48.82	54	-5.18	-	-	29	297	H

* - indicates frequency in CFR47 Pt 15 / IC RSS-Restricted Band

Pk - Peak detector

RMS - RMS detection

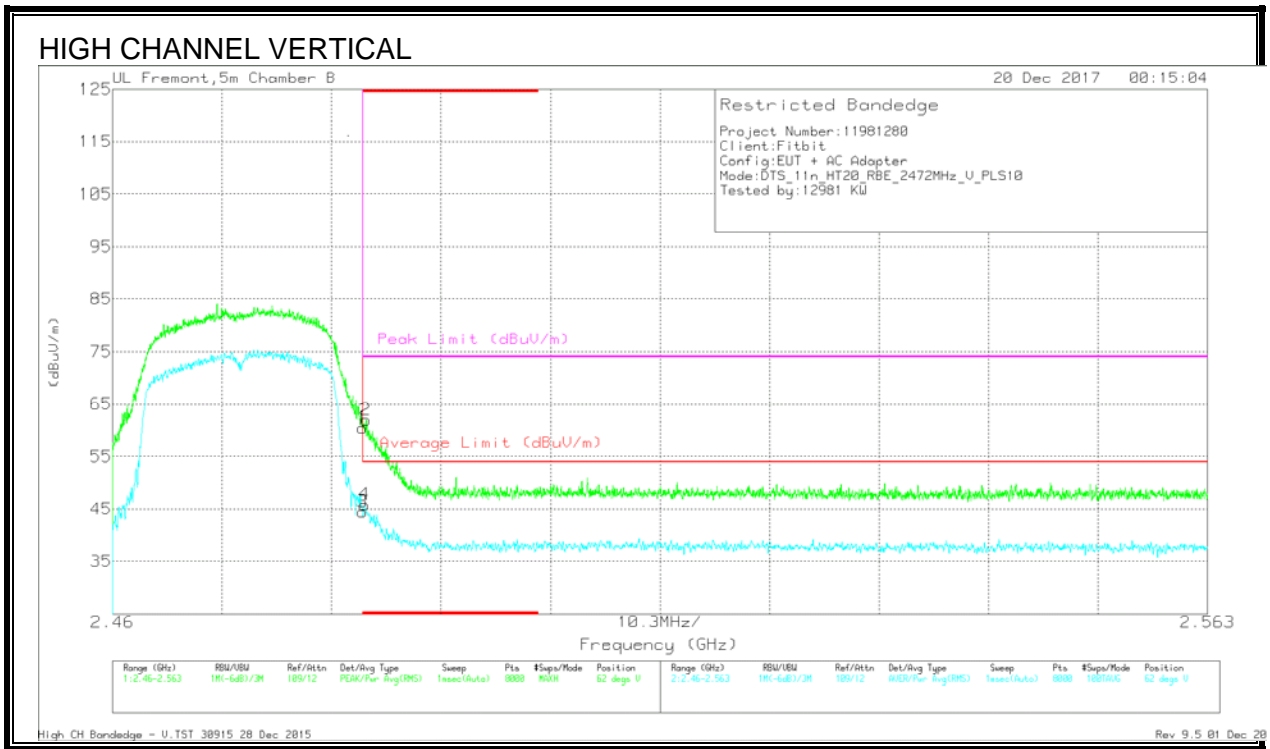

DATA

Marker	Frequency (GHz)	Meter Reading (dBuV)	Det	AF T863 (dB/m)	Amp/Cb/Ftr/Pad (dB)	DC Corr (dB)	Corrected Reading (dBuV/m)	Average Limit (dBuV/m)	Margin (dB)	Peak Limit (dBuV/m)	PK Margin (dB)	Azimuth (Degs)	Height (cm)	Polarity
1	* 2.484	49.24	PK	32.5	-21.3	0	60.44	-	-	74	-13.56	62	225	V
2	* 2.484	50.73	PK	32.5	-21.3	0	61.93	-	-	74	-12.07	62	225	V
3	* 2.484	33.31	RMS	32.5	-21.3	0	44.51	54	-9.49	-	-	62	225	V
4	* 2.484	34.65	RMS	32.5	-21.3	0	45.85	54	-8.15	-	-	62	225	V

* - indicates frequency in CFR47 Pt 15 / IC RSS-Restricted Band

PK - Peak detector

RMS - RMS detection

HARMONICS AND SPURIOUS EMISSIONS LOW CHANNEL, CH 1)

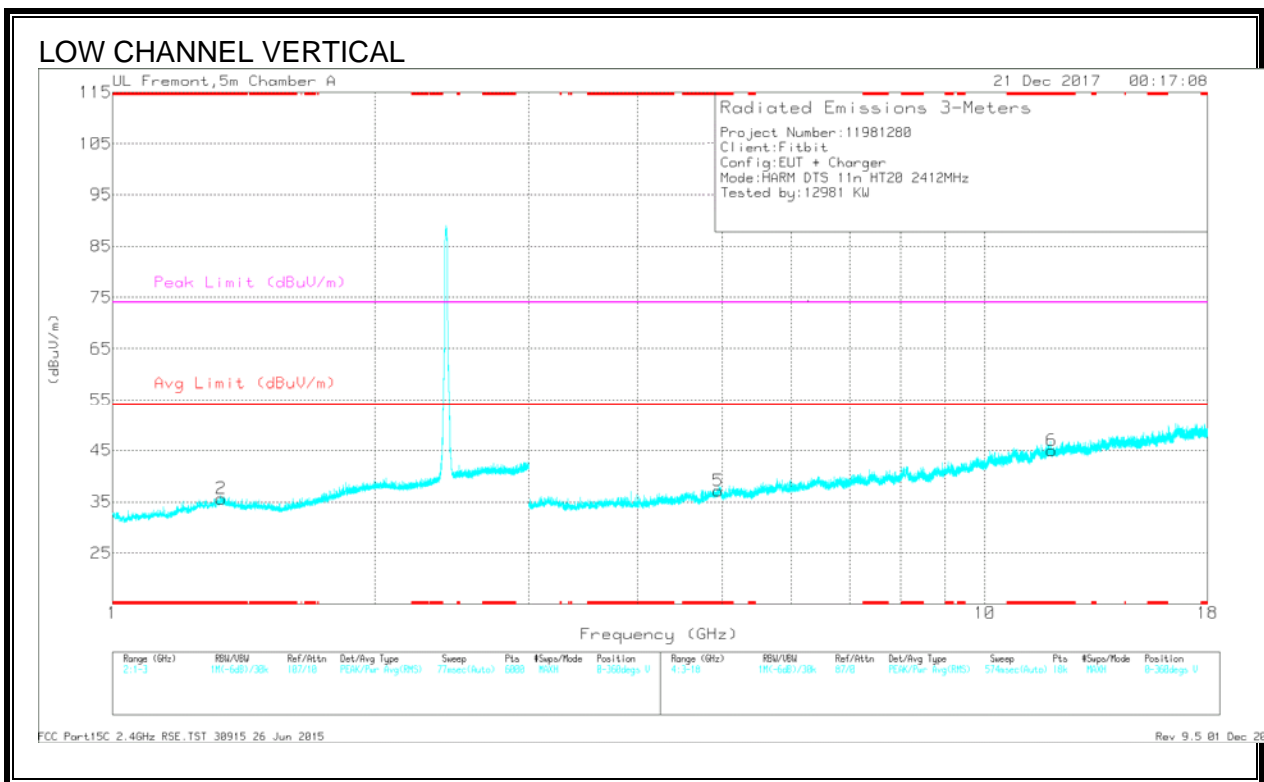
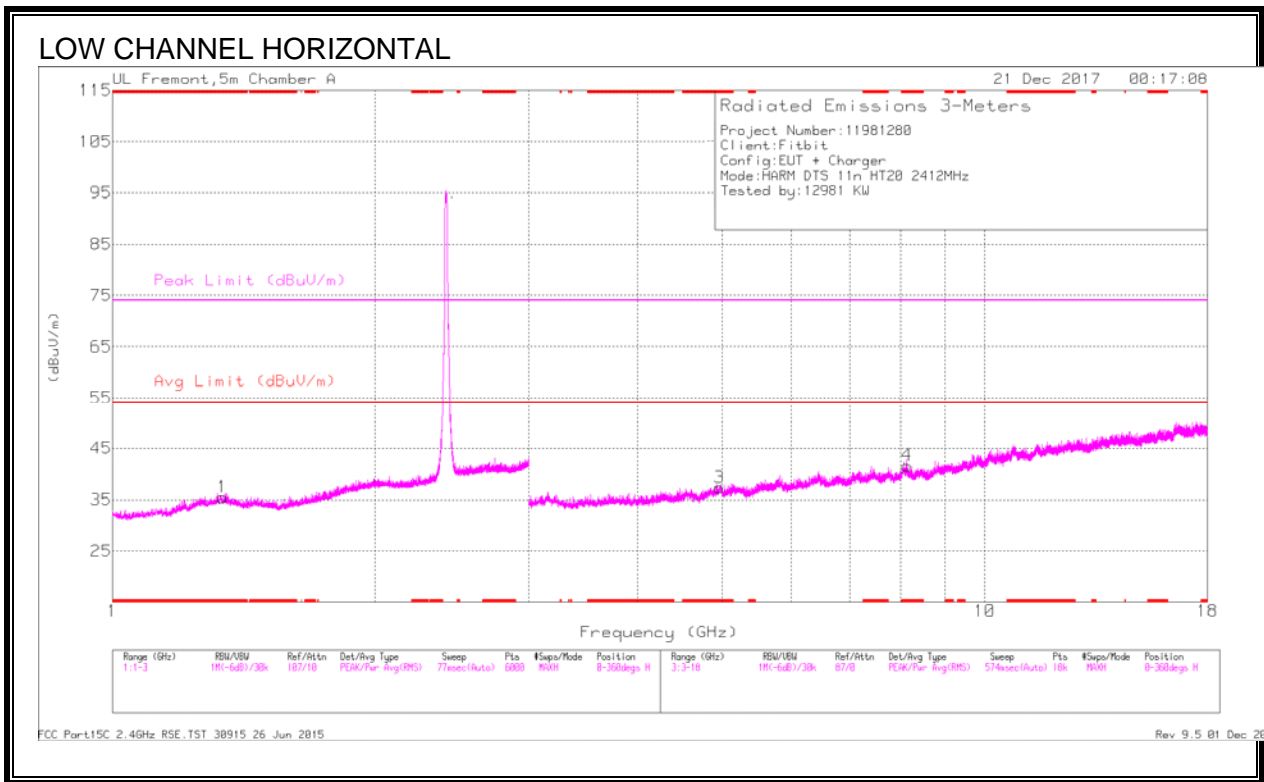

DATA

Marker	Frequency (GHz)	Meter Reading (dBuV)	Det	AF T862 (dB/m)	Amp/Cbl/Fitr/Pad (dB)	DC Corr (dB)	Corrected Reading (dBuV/m)	Avg Limit (dBuV/m)	Margin (dB)	Peak Limit (dBuV/m)	PK Margin (dB)	Azimuth (Degs)	Height (cm)	Polarity
1	* 1.337	36.55	PK2	29.5	-23.7	0	42.35	-	-	74	-31.65	110	181	H
	* 1.336	24.58	MAv1	29.5	-23.6	0	30.48	54	-23.52	-	-	110	181	H
2	* 1.334	36.03	PK2	29.5	-23.6	0	41.93	-	-	74	-32.07	135	251	V
	* 1.334	24.68	MAv1	29.5	-23.6	0	30.58	54	-23.42	-	-	135	251	V
3	* 4.962	36.82	PK2	34.2	-27.1	0	43.92	-	-	74	-30.08	51	131	H
	* 4.961	25.75	MAv1	34.2	-27.1	0	32.85	54	-21.15	-	-	51	131	H
4	* 8.14	32.59	PK2	35.8	-20.7	0	47.69	-	-	74	-26.31	291	189	H
	* 8.14	22.05	MAv1	35.8	-20.7	0	37.15	54	-16.85	-	-	291	189	H
5	* 4.948	35.94	PK2	34.2	-26.9	0	43.24	-	-	74	-30.76	88	195	V
	* 4.949	25.51	MAv1	34.2	-26.9	0	32.81	54	-21.19	-	-	88	195	V
6	* 11.93	31.57	PK2	38.9	-19.3	0	51.17	-	-	74	-22.83	20	171	V
	* 11.932	20.93	MAv1	38.9	-19.3	0	40.53	54	-13.47	-	-	20	171	V

* - indicates frequency in CFR47 Pt 15 / IC RSS-Restricted Band

PK2 - KDB558074 Method: Maximum Peak

MAv1 - KDB558074 Option 1 Maximum RMS Average

HARMONICS AND SPURIOUS EMISSIONS MID CHANNEL, CH 6)

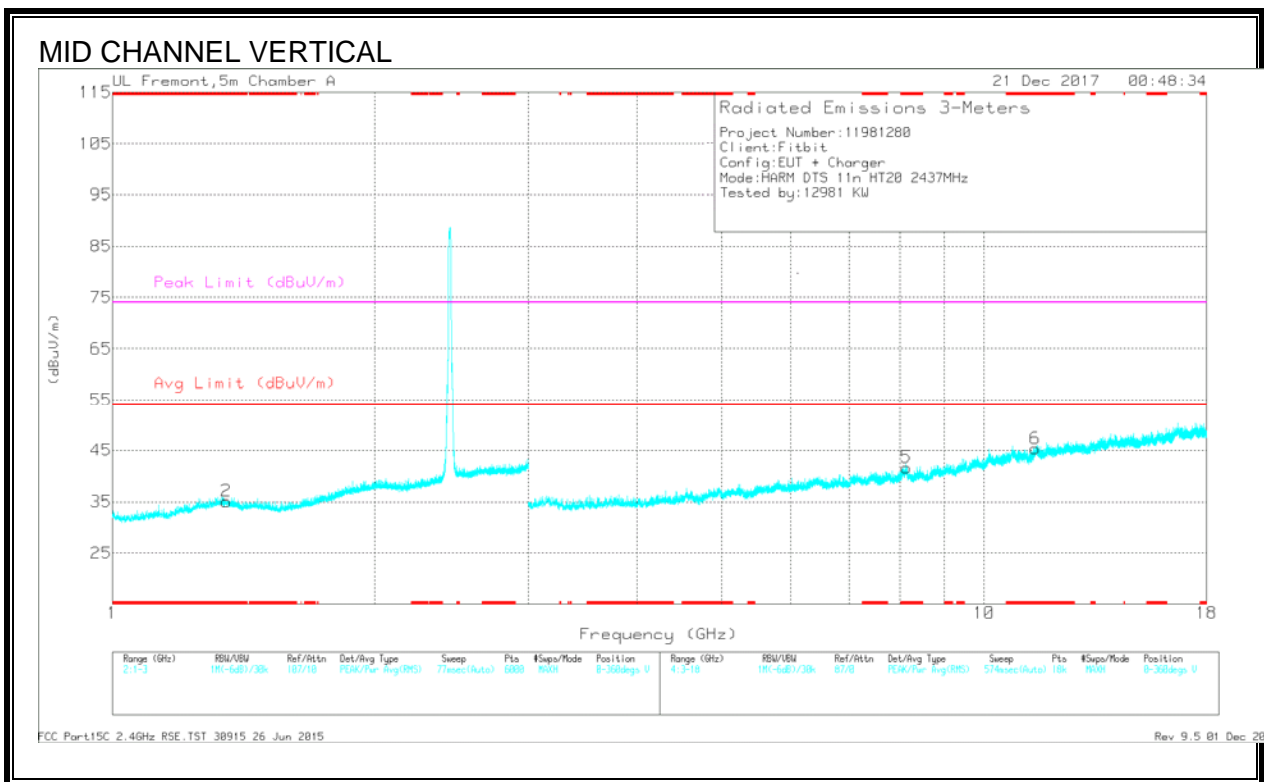
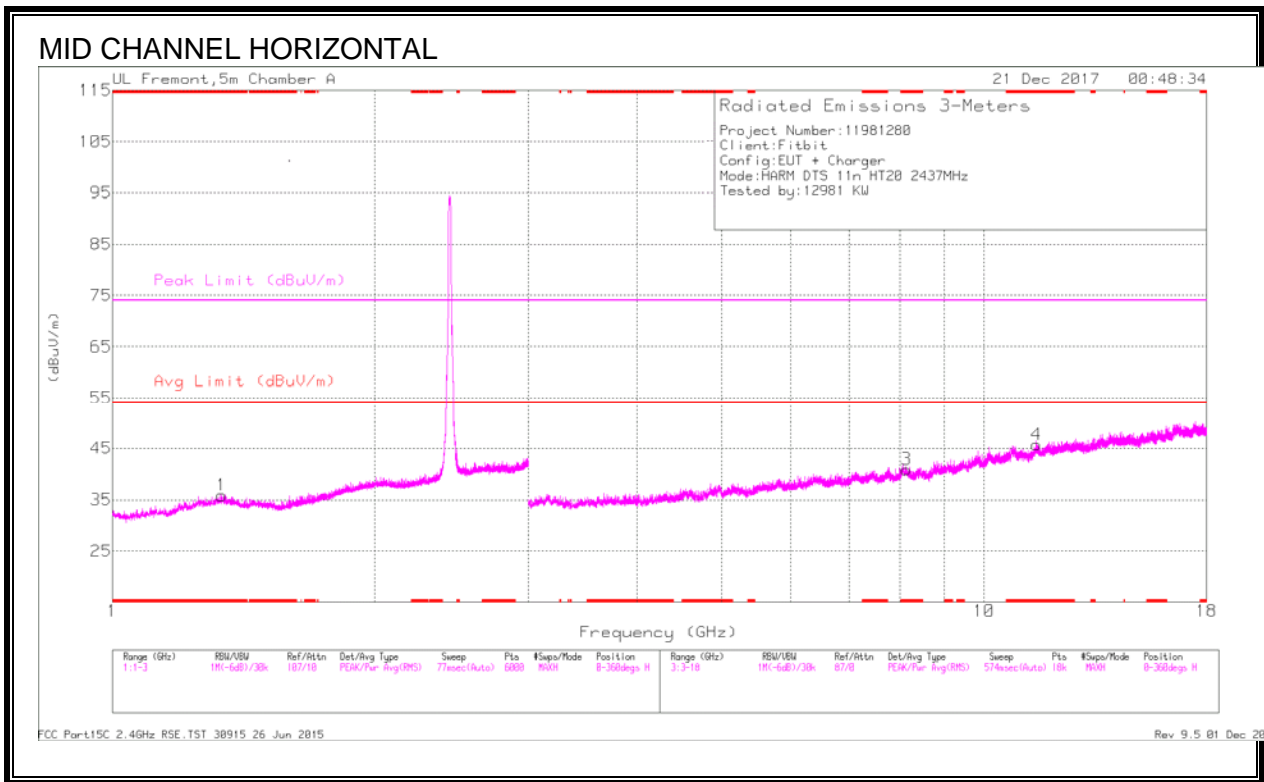

DATA

Marker	Frequency (GHz)	Meter Reading (dBuV)	Det	AF T862 (dB/m)	Amp/Cbl/Fitr/Par d (dB)	DC Corr (dB)	Corrected Reading (dBuV/m)	Avg Limit (dBuV/m)	Margin (dB)	Peak Limit (dBuV/m)	PK Margin (dB)	Azimuth (Degs)	Height (cm)	Polarity
1	* 1.335	36.13	PK2	29.5	-23.6	0	42.03	-	-	74	-31.97	181	112	H
	* 1.336	24.62	MAv1	29.5	-23.6	0	30.52	54	-23.48	-	-	181	112	H
2	* 1.351	35.98	PK2	29.5	-23.6	0	41.88	-	-	74	-32.12	62	240	V
	* 1.351	24.23	MAv1	29.5	-23.6	0	30.13	54	-23.87	-	-	62	240	V
3	* 8.146	32.72	PK2	35.8	-20.9	0	47.62	-	-	74	-26.38	255	212	H
	* 8.146	21.96	MAv1	35.8	-20.8	0	36.96	54	-17.04	-	-	255	212	H
4	* 11.492	31.97	PK2	38.3	-18.2	0	52.07	-	-	74	-21.93	310	289	H
	* 11.49	20.99	MAv1	38.3	-18.2	0	41.09	54	-12.91	-	-	310	289	H
5	* 8.147	33.41	PK2	35.8	-20.9	0	48.31	-	-	74	-25.69	251	152	V
	* 8.15	21.94	MAv1	35.8	-21.1	0	36.64	54	-17.36	-	-	251	152	V
6	* 11.453	32.02	PK2	38.2	-18.4	0	51.82	-	-	74	-22.18	80	122	V
	* 11.452	20.99	MAv1	38.2	-18.4	0	40.79	54	-13.21	-	-	80	122	V

* - indicates frequency in CFR47 Pt 15 / IC RSS-Restricted Band

PK2 - KDB558074 Method: Maximum Peak

MAv1 - KDB558074 Option 1 Maximum RMS Average

HARMONICS AND SPURIOUS EMISSIONS HIGH CHANNEL, CH 13)

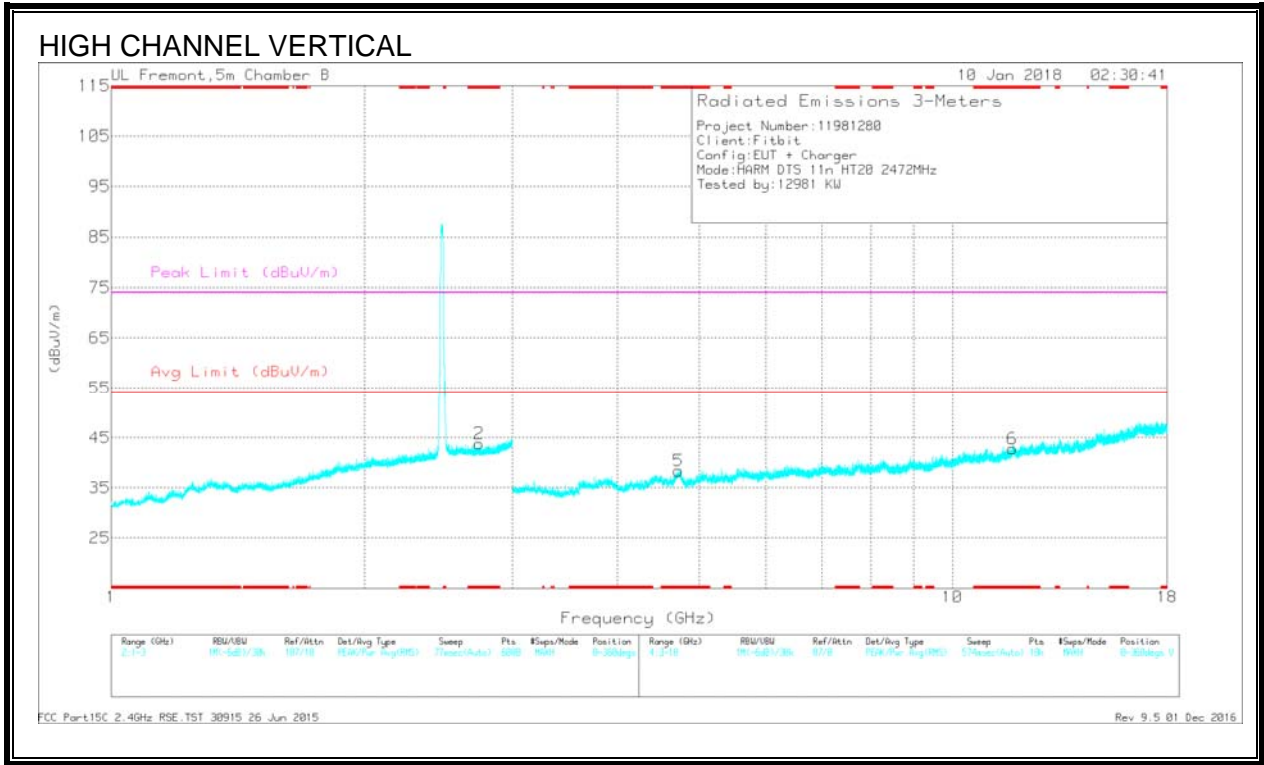
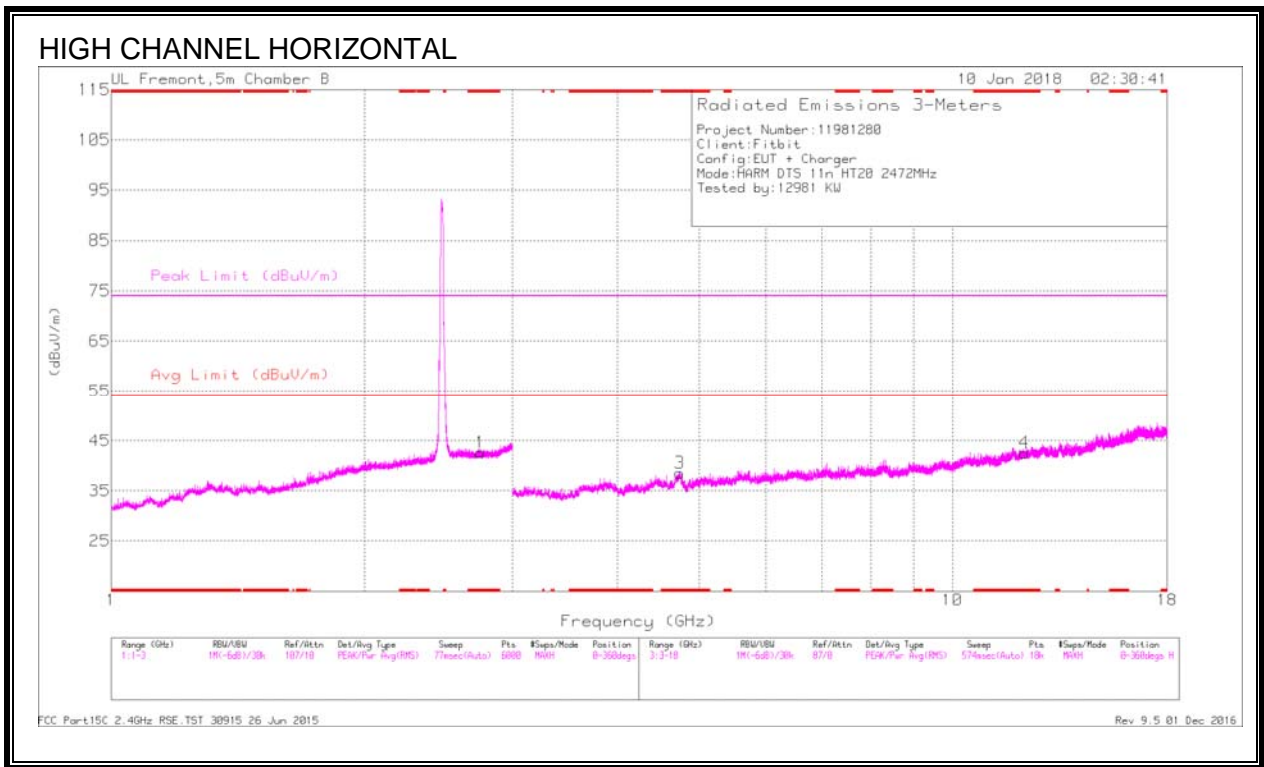

DATA

Marker	Frequency (GHz)	Meter Reading (dBuV)	Det	AF T863 (dB/m)	Amp/Cbi/Filtr/ Pad (dB)	DC Corr (dB)	Corrected Reading (dBuV/m)	Avg Limit (dBuV/m)	Margin (dB)	Peak Limit (dBuV/m)	PK Margin (dB)	Azimuth (Degs)	Height (cm)	Polarity
1	* 2.744	37.05	PK2	32.3	-20.8	0	48.55	-	-	74	-25.45	97	119	H
	* 2.745	25.46	MAv1	32.3	-20.7	0	37.06	54	-16.94	-	-	97	119	H
2	* 2.739	36.94	PK2	32.3	-20.8	0	48.44	-	-	74	-25.56	167	118	V
	* 2.738	25.47	MAv1	32.3	-20.8	0	36.97	54	-17.03	-	-	167	118	V
3	* 4.742	41.87	PK2	34.2	-29.5	0	46.57	-	-	74	-27.43	136	184	H
	* 4.743	29.51	MAv1	34.2	-29.4	0	34.31	54	-19.69	-	-	136	184	H
4	* 12.17	34.14	PK2	39.1	-23.9	0	49.34	-	-	74	-24.66	256	119	H
	* 12.17	23.31	MAv1	39.1	-23.9	0	38.51	54	-15.49	-	-	256	119	H
5	* 4.722	41.06	PK2	34.2	-29.8	0	45.46	-	-	74	-28.54	277	108	V
	* 4.723	29.31	MAv1	34.2	-29.7	0	33.81	54	-20.19	-	-	277	108	V
6	* 11.787	34.45	PK2	38.6	-23.7	0	49.35	-	-	74	-24.65	114	210	V
	* 11.789	23.5	MAv1	38.6	-23.6	0	38.50	54	-15.50	-	-	114	210	V

* - indicates frequency in CFR47 Pt 15 / IC RSS-Restricted Band

PK2 - KDB558074 Method: Maximum Peak

MAv1 - KDB558074 Option 1 Maximum RMS Average

9.3. WORST-CASE BELOW 30MHz

SPURIOUS EMISSIONS BELOW 30 MHz (WORST-CASE CONFIGURATION)

HORIZONTAL PLOT

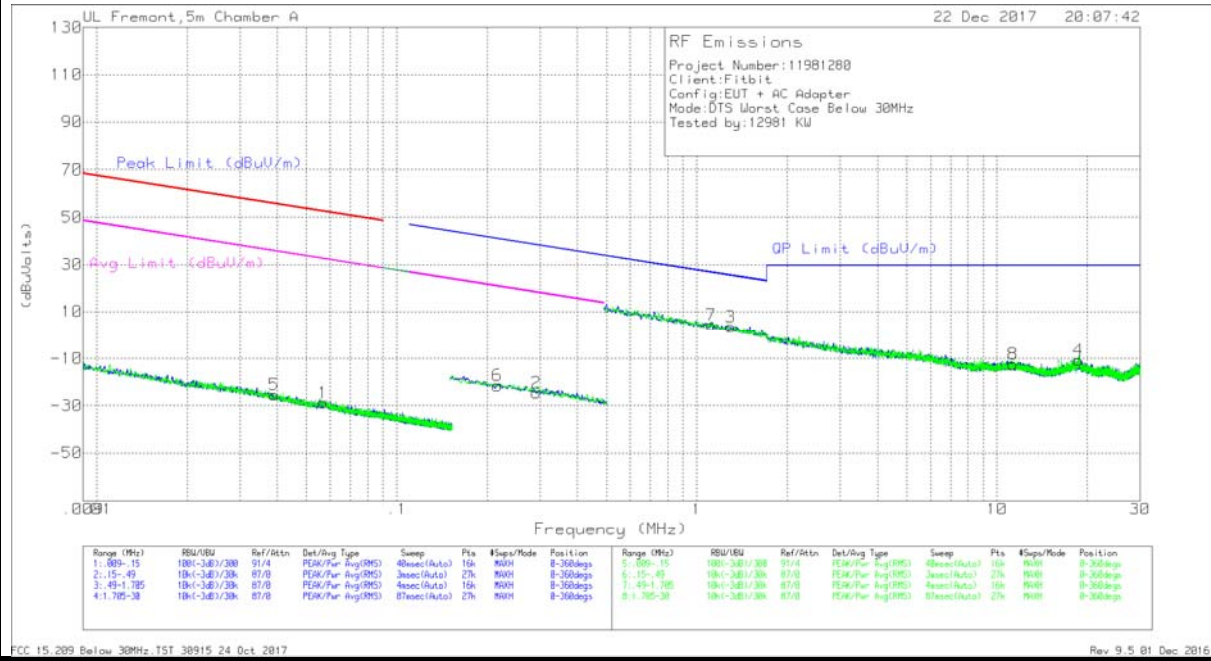

VERTICAL PLOT

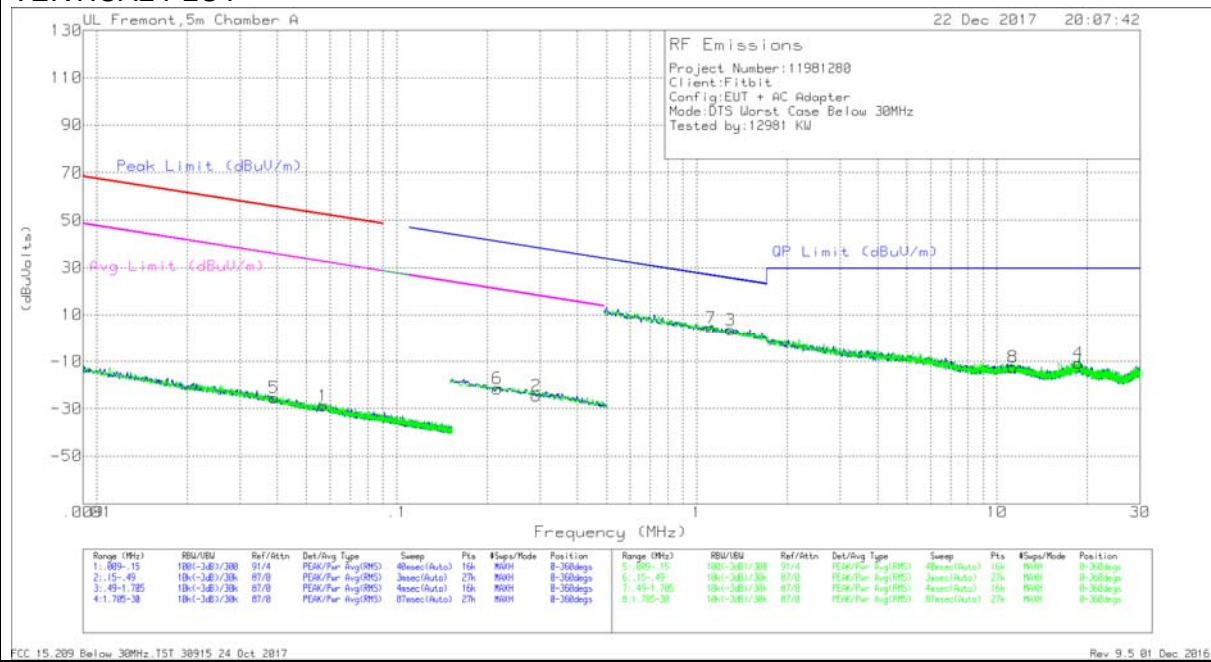

DATA

Marker	Frequency (MHz)	Meter Reading (dBuV)	Det	Loop Antenna (dB/m)	Cbl (dB)	Dist Corr 300m	Corrected Reading (dBuVolts)	Peak Limit (dBuV/m)	Margin (dB)	Avg Limit (dBuV/m)	Margin (dB)	Peak Limit (dBuV/m)	Margin (dB)	Avg Limit (dBuV/m)	Margin (dB)	Azimuth (Degs)
5	.03897	39.52	Pk	15	.1	-80	-25.38	55.77	-81.15	35.77	-61.15	-	-	-	-	0-360
1	.05679	36.69	Pk	14.4	.1	-80	-28.81	52.5	-81.31	32.5	-61.31	-	-	-	-	0-360
6	.21638	44.46	Pk	13.9	.1	-80	-21.54	-	-	-	-	40.91	-62.45	20.91	-42.45	0-360
2	.29181	41.38	Pk	13.8	.1	-80	-24.72	-	-	-	-	38.31	-63.03	18.31	-43.03	0-360

Marker	Frequency (MHz)	Meter Reading (dBuV)	Det	Loop Antenna (dB/m)	Cbl (dB)	Dist Corr 30m	Corrected Reading (dBuVolts)	QP Limit (dBuV/m)	Margin (dB)	Azimuth (Degs)
7	1.11616	29.84	Pk	14.3	.2	-40	4.34	26.67	-22.33	0-360
3	1.29549	29.01	Pk	14.3	.2	-40	3.51	25.38	-21.87	0-360
8	11.31306	12.3	Pk	14.7	.5	-40	-12.5	29.5	-42	0-360
4	18.67631	13.99	Pk	14.7	.6	-40	-10.71	29.5	-40.21	0-360

Pk - Peak detector

9.4. WORST-CASE 30MHz TO 1GHz

SPURIOUS EMISSIONS 30 TO 1000 MHz (WORST-CASE CONFIGURATION)

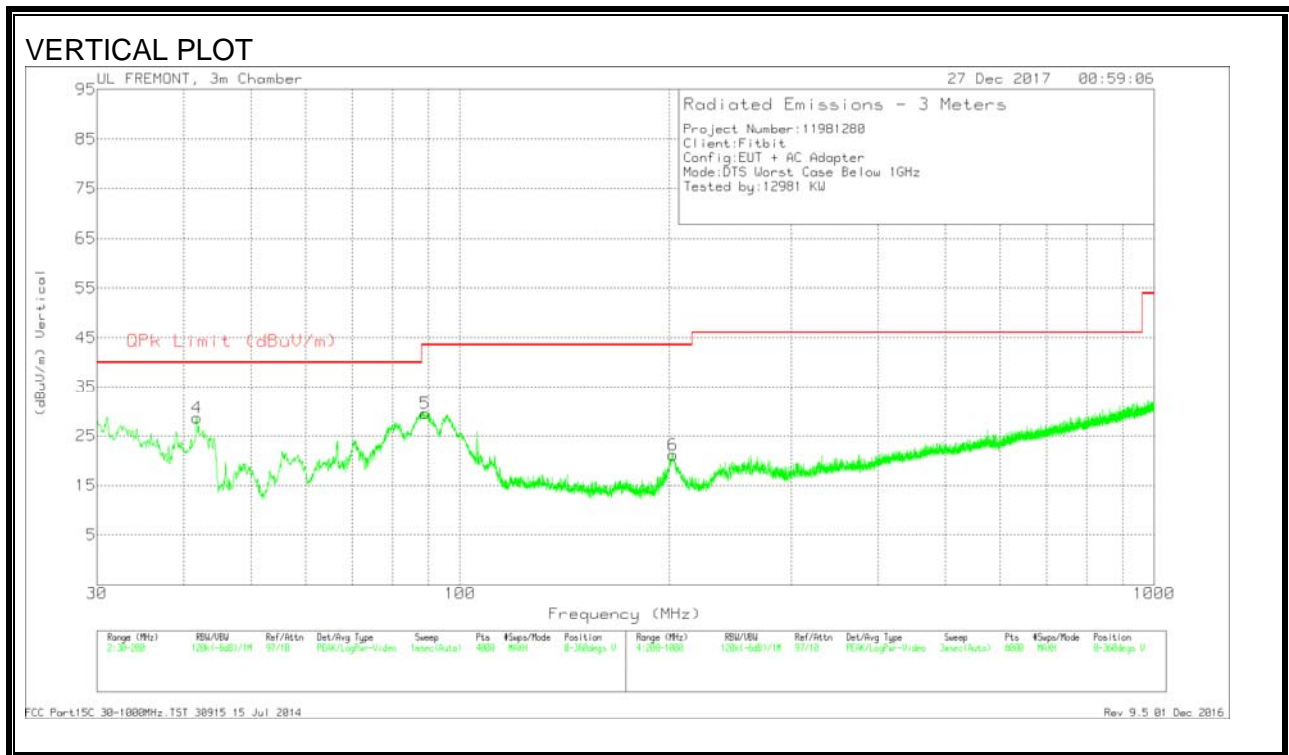
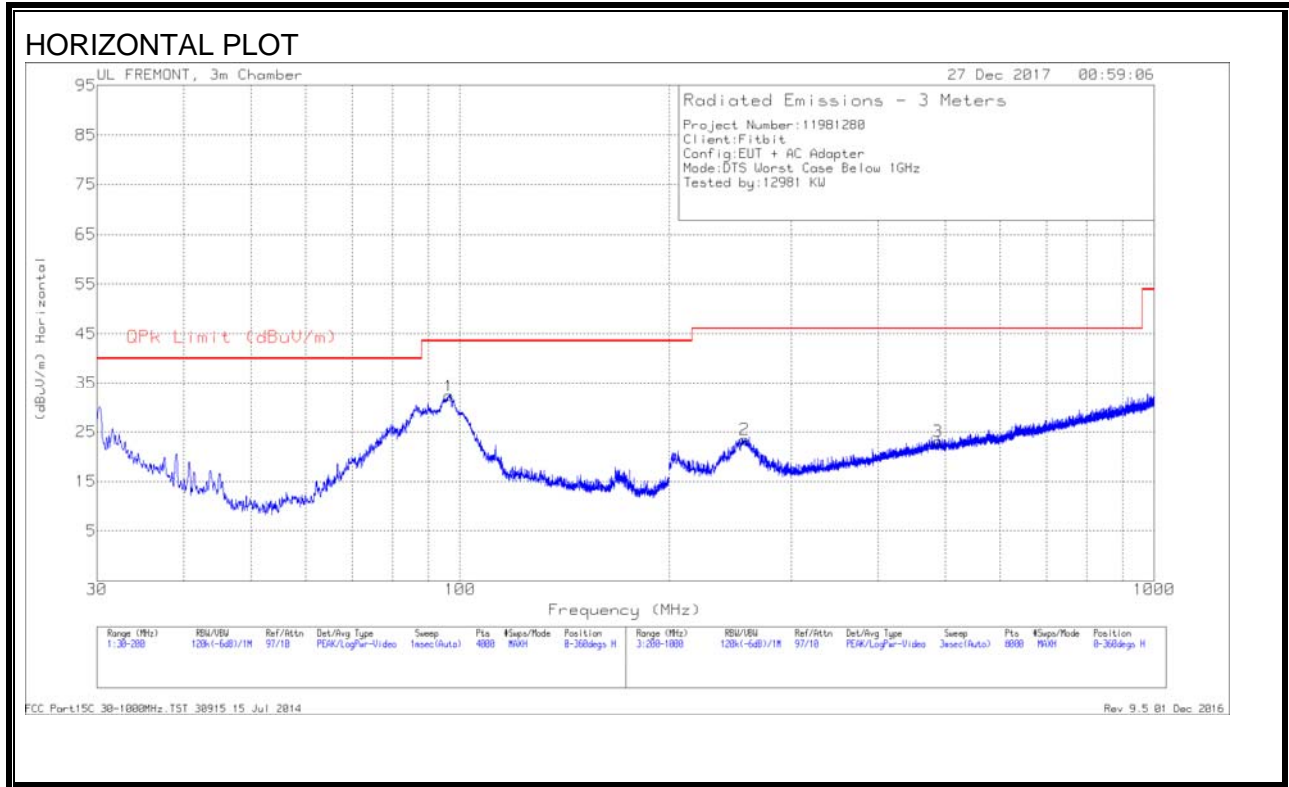

DATA

Marker	Frequency (MHz)	Meter Reading (dBuV)	Det	AF T243 (dB/m)	Amp/Cbl (dB/m)	Corrected Reading (dBuV/m)	QPk Limit (dBuV/m)	Margin (dB)	Azimuth (Degs)	Height (cm)	Polarity
4	41.7543	42.88	Pk	16.7	-30.9	28.68	40	-11.32	0-360	100	V
5	89.0903	48.45	Pk	11.5	-30.4	29.55	43.52	-13.97	0-360	100	V
1	96.4872	49.39	Pk	13.2	-30.3	32.29	43.52	-11.23	0-360	200	H
6	202.7004	34.7	Pk	16	-29.5	21.2	43.52	-22.32	0-360	200	V
2	257.0074	36.78	Pk	15.8	-29.1	23.48	46.02	-22.54	0-360	200	H
3	487.6374	28.98	Pk	21.8	-27.7	23.08	46.02	-22.94	0-360	400	H

Pk - Peak detector

9.5. WORST-CASE ABOVE 18GHz

SPURIOUS EMISSIONS 18 TO 26 GHz (WORST-CASE CONFIGURATION)

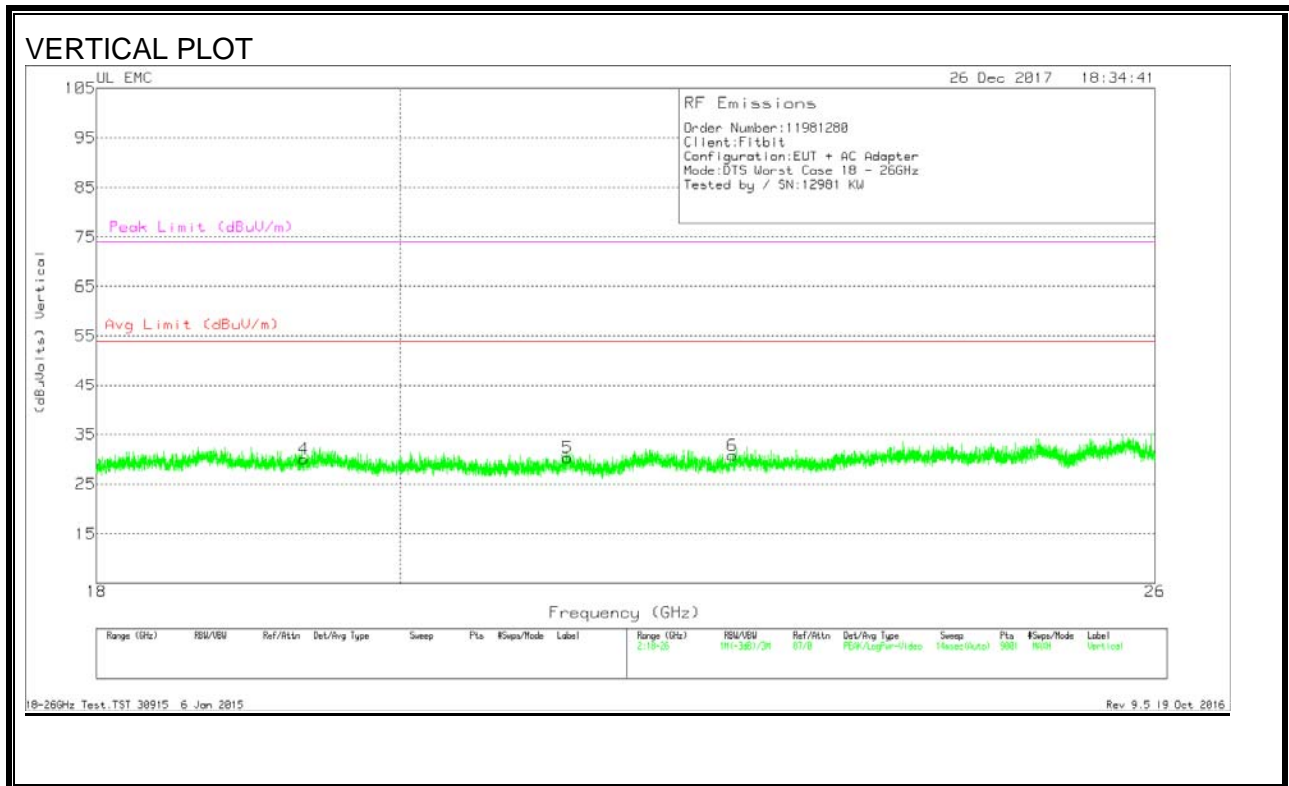
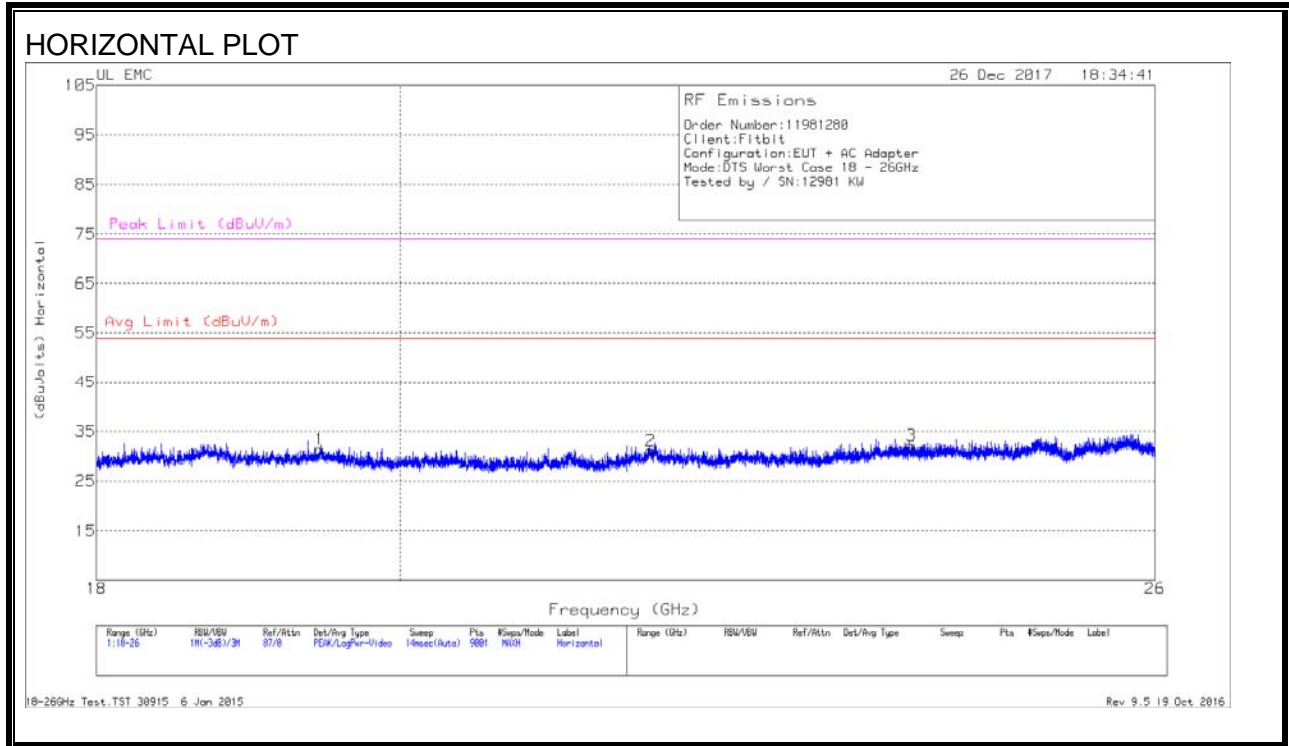

DATA

Marker	Frequency (GHz)	Meter Reading (dBuV)	Det	T89 AF (dB/m)	Amp/Cbl (dB)	Dist Corr (dB)	Corrected Reading (dBuVolts)	Avg Limit (dBuV/m)	Margin (dB)	Peak Limit (dBuV/m)	PK Margin (dB)
1	19.453	32.99	Pk	32.5	-24.6	-9.5	31.39	54	-22.61	74	-42.61
2	21.82	31.81	Pk	33.3	-24.5	-9.5	31.11	54	-22.89	74	-42.89
3	23.892	32.09	Pk	33.5	-23.9	-9.5	32.19	54	-21.81	74	-41.81
4	19.342	31.82	Pk	32.4	-24.7	-9.5	30.02	54	-23.98	74	-43.98
5	21.197	31.63	Pk	33	-24.8	-9.5	30.33	54	-23.67	74	-43.67
6	22.451	31.56	Pk	33.3	-24.6	-9.5	30.76	54	-23.24	74	-43.24

Pk - Peak detector

10. AC POWER LINE CONDUCTED EMISSIONS

LIMITS

FCC §15.207 (a)

RSS-Gen 8.8

Frequency of Emission (MHz)	Conducted Limit (dB μ V)	
	Quasi-peak	Average
0.15-0.5	66 to 56 *	56 to 46 *
0.5-5	56	46
5-30	60	50

*Decreases with the logarithm of the frequency.

TEST PROCEDURE

The EUT is placed on a non-conducting table 40 cm from the vertical ground plane and 80 cm above the horizontal ground plane. The EUT is configured in accordance with ANSI C63.10.

The receiver is set to a resolution bandwidth of 9 kHz. Peak detection is used unless otherwise noted as quasi-peak or average.

Line conducted data is recorded for both Line 1 (HOT) and Line 2 (NEUTRAL).

RESULTS

10.1. EUT POWERED BY AC/DC ADAPTER VIA USB CABLE

LINE 1 RESULTS

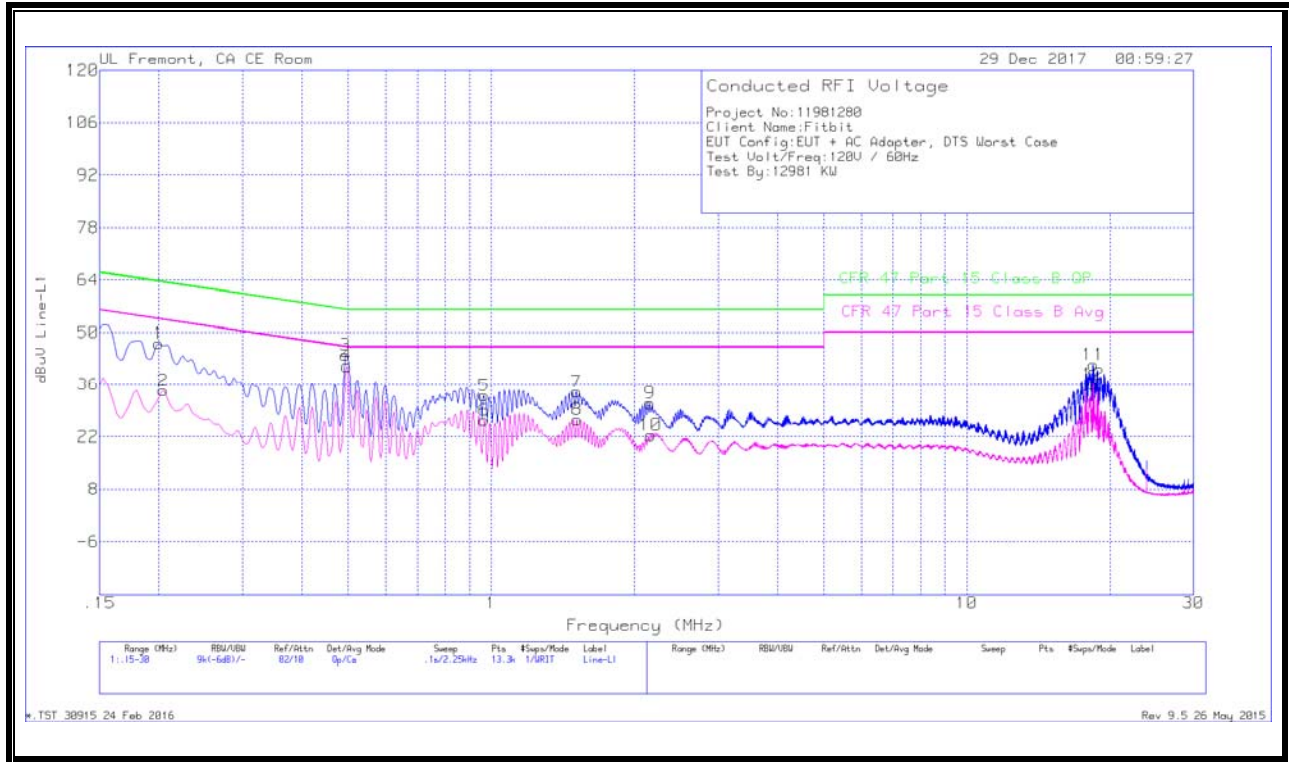

WORST EMISSIONS

Range 1: Line-L1 .15 - 30MHz											
Marker	Frequency (MHz)	Meter Reading (dBuV)	Det	LISN L1	LC Cables C1&C3	Limiters (dB)	Corrected Reading dBuV	CFR 47 Part 15 Class B QP	QP Margin (dB)	CFR 47 Part 15 Class B Avg	Av(CISPR)M argin (dB)
1	.1995	36.93	Qp	0	0	10.1	47.03	63.63	-16.6	-	-
2	.204	24.29	Ca	0	0	10.1	34.39	-	-	53.45	-19.06
3	.49425	33.82	Qp	0	0	10.1	43.92	56.1	-12.18	-	-
4	.4965	30.95	Ca	0	0	10.1	41.05	-	-	46.06	-5.01
5	.9645	22.7	Qp	0	.1	10.1	32.9	56	-23.1	-	-
6	.96675	16.18	Ca	0	.1	10.1	26.38	-	-	46	-19.62
7	1.509	23.82	Qp	0	.1	10.1	34.02	56	-21.98	-	-
8	1.5135	16.35	Ca	0	.1	10.1	26.55	-	-	46	-19.45
9	2.157	20.63	Qp	0	.1	10.1	30.83	56	-25.17	-	-
10	2.1615	12.24	Ca	0	.1	10.1	22.44	-	-	46	-23.56
11	18.447	30.67	Qp	0	.3	10.3	41.27	60	-18.73	-	-
12	18.447	25.48	Ca	0	.3	10.3	36.08	-	-	50	-13.92

Qp - Quasi-Peak detector

Ca - CISPR average detection

LINE 2 RESULTS

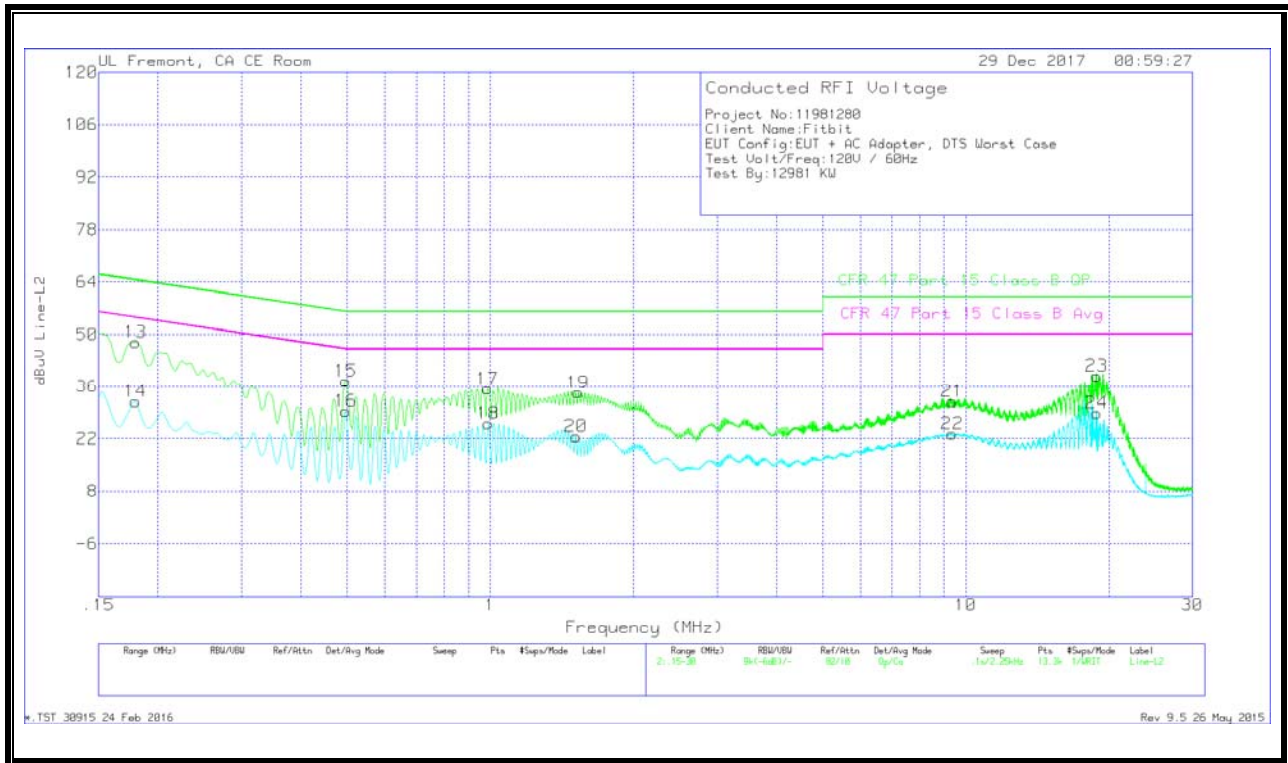

WORST EMISSIONS

Range 2: Line-L2 .15 - 30MHz											
Marker	Frequency (MHz)	Meter Reading (dBuV)	Det	LISN L2	LC Cables C2&C3	Limiter (dB)	Corrected Reading dBuV	CFR 47 Part 15 Class B QP	QP Margin (dB)	CFR 47 Part 15 Class B Avg	Av(CISPR)Margin (dB)
13	.17925	37.74	Qp	0	0	10.1	47.84	64.52	-16.68	-	-
14	.17925	21.81	Ca	0	0	10.1	31.91	-	-	54.52	-22.61
15	.4965	27.32	Qp	0	0	10.1	37.42	56.06	-18.64	-	-
16	.4965	19.14	Ca	0	0	10.1	29.24	-	-	46.06	-16.82
17	.987	25.22	Qp	0	.1	10.1	35.42	56	-20.58	-	-
18	.9915	15.86	Ca	0	.1	10.1	26.06	-	-	46	-19.94
19	1.5315	24.1	Qp	0	.1	10.1	34.3	56	-21.7	-	-
20	1.5135	12.4	Ca	0	.1	10.1	22.6	-	-	46	-23.4
21	9.36825	21.46	Qp	0	.2	10.2	31.86	60	-28.14	-	-
22	9.37725	12.76	Ca	0	.2	10.2	23.16	-	-	50	-26.84
23	18.8655	28.25	Qp	0	.3	10.3	38.85	60	-21.15	-	-
24	18.8655	18.22	Ca	0	.3	10.3	28.82	-	-	50	-21.18

Qp - Quasi-Peak detector

Ca - CISPR average detection