

EMC Test Report

Application for Grant of Equipment Authorization

Industry Canada RSS-Gen Issue 3 / RSS 210 Issue 8 FCC Part 15 Subpart C

Model: FB501

IC CERTIFICATION #: 8542A-FB501
FCC ID: XRAFB501

APPLICANT: Fitbit, Inc.
405 Howard Street
San Francisco, CA 94105

TEST SITE(S): National Technical Systems - Silicon Valley
41039 Boyce Road.
Fremont, CA. 94538-2435

IC SITE REGISTRATION #: 2848B-3, 2845B-7

REPORT DATE: August 12, 2014

REISSUE DATE: August 19, 2014

FINAL TEST DATES: July 7, 11, 18, and 21, 2014

TOTAL NUMBER OF PAGES: 67

PROGRAM MGR /
TECHNICAL REVIEWER:



Mark E Hill
Staff Engineer

QUALITY ASSURANCE DELEGATE /
FINAL REPORT PREPARER:

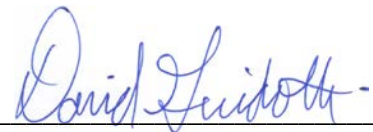

David Guidotti
Senior Technical Writer



National Technical Systems - Silicon Valley is accredited by the A2LA, certificate number 0214.26, to perform the test(s) listed in this report, except where noted otherwise. This report and the information contained herein represent the results of testing test articles identified and selected by the client performed to specifications and/or procedures selected by the client. National Technical Systems (NTS) makes no representations, expressed or implied, that such testing is adequate (or inadequate) to demonstrate efficiency, performance, reliability, or any other characteristic of the articles being tested, or similar products. This report should not be relied upon as an endorsement or certification by NTS of the equipment tested, nor does it represent any statement whatsoever as to its merchantability or fitness of the test article, or similar products, for a particular purpose. This report shall not be reproduced except in full

REVISION HISTORY

Rev#	Date	Comments	Modified By
-	August 12, 2014	First release	
1	August 19, 2014	Reissued to remove data	Dave Guidotti

TABLE OF CONTENTS

REVISION HISTORY	2
TABLE OF CONTENTS	3
SCOPE.....	4
OBJECTIVE	4
STATEMENT OF COMPLIANCE.....	5
DEVIATIONS FROM THE STANDARDS.....	5
TEST RESULTS SUMMARY	6
FREQUENCY HOPPING SPREAD SPECTRUM (2400 – 2483.5 MHZ, 15 CHANNELS OR MORE)	6
GENERAL REQUIREMENTS APPLICABLE TO ALL BANDS.....	7
MEASUREMENT UNCERTAINTIES.....	8
EQUIPMENT UNDER TEST (EUT) DETAILS.....	9
GENERAL.....	9
OTHER EUT DETAILS.....	9
ANTENNA SYSTEM	9
ENCLOSURE.....	9
MODIFICATIONS	9
SUPPORT EQUIPMENT	10
EUT INTERFACE PORTS	10
EUT OPERATION	10
TEST SITE.....	11
GENERAL INFORMATION.....	11
CONDUCTED EMISSIONS CONSIDERATIONS	11
RADIATED EMISSIONS CONSIDERATIONS	11
MEASUREMENT INSTRUMENTATION	12
RECEIVER SYSTEM	12
INSTRUMENT CONTROL COMPUTER	12
LINE IMPEDANCE STABILIZATION NETWORK (LISN).....	12
FILTERS/ATTENUATORS	13
ANTENNAS.....	13
ANTENNA MAST AND EQUIPMENT TURNTABLE.....	13
INSTRUMENT CALIBRATION.....	13
TEST PROCEDURES	14
EUT AND CABLE PLACEMENT	14
CONDUCTED EMISSIONS.....	14
RADIATED EMISSIONS	15
CONDUCTED EMISSIONS FROM ANTENNA PORT	17
BANDWIDTH MEASUREMENTS	17
SPECIFICATION LIMITS AND SAMPLE CALCULATIONS	18
CONDUCTED EMISSIONS SPECIFICATION LIMITS: FCC 15.207; FCC 15.107(A), RSS GEN	18
GENERAL TRANSMITTER RADIATED EMISSIONS SPECIFICATION LIMITS	19
OUTPUT POWER LIMITS – FHSS SYSTEMS	20
TRANSMIT MODE SPURIOUS RADIATED EMISSIONS LIMITS – FHSS AND DTS SYSTEMS.....	20
SAMPLE CALCULATIONS - CONDUCTED EMISSIONS	20
SAMPLE CALCULATIONS - RADIATED EMISSIONS.....	21
SAMPLE CALCULATIONS - FIELD STRENGTH TO EIRP CONVERSION.....	22
APPENDIX A TEST EQUIPMENT CALIBRATION DATA	23
APPENDIX B TEST DATA	24
END OF REPORT	67

SCOPE

An electromagnetic emissions test has been performed on the Fitbit, Inc. model FB501, pursuant to the following rules:

Industry Canada RSS-Gen Issue 3

RSS 210 Issue 8 “Low-power Licence-exempt Radiocommunication Devices (All Frequency Bands): Category I Equipment”

FCC Part 15 Subpart C

Conducted and radiated emissions data has been collected, reduced, and analyzed within this report in accordance with measurement guidelines set forth in the following reference standards and as outlined in National Technical Systems - Silicon Valley test procedures:

ANSI C63.10-2009

FHSS test procedure DA 00-0705A1

The intentional radiator above has been tested in a simulated typical installation to demonstrate compliance with the relevant Industry Canada performance and procedural standards.

Final system data was gathered in a mode that tended to maximize emissions by varying orientation of EUT, orientation of power and I/O cabling, antenna search height, and antenna polarization.

Every practical effort was made to perform an impartial test using appropriate test equipment of known calibration. All pertinent factors have been applied to reach the determination of compliance.

OBJECTIVE

The primary objective of the manufacturer is compliance with the regulations outlined in the previous section.

Prior to marketing in the USA, all unlicensed transmitters and transceivers require certification. Receive-only devices operating between 30 MHz and 960 MHz are subject to either certification or a manufacturer’s declaration of conformity, with all other receive-only devices exempt from the technical requirements.

Prior to marketing in Canada, Class I transmitters, receivers and transceivers require certification. Class II devices are required to meet the appropriate technical requirements but are exempt from certification requirements.

Certification is a procedure where the manufacturer submits test data and technical information to a certification body and receives a certificate or grant of equipment authorization upon successful completion of the certification body’s review of the submitted documents. Once the equipment authorization has been obtained, the label indicating compliance must be attached to all identical units, which are subsequently

manufactured.

Maintenance of compliance is the responsibility of the manufacturer. Any modification of the product which may result in increased emissions should be checked to ensure compliance has been maintained (i.e., printed circuit board layout changes, different line filter, different power supply, harnessing or I/O cable changes, etc.).

STATEMENT OF COMPLIANCE

The tested sample of Fitbit, Inc. model FB501 complied with the requirements of the following regulations:

Industry Canada RSS-Gen Issue 3
RSS 210 Issue 8 “Low-power Licence-exempt Radiocommunication Devices (All Frequency Bands): Category I Equipment”
FCC Part 15 Subpart C

Maintenance of compliance is the responsibility of the manufacturer. Any modifications to the product should be assessed to determine their potential impact on the compliance status of the device with respect to the standards detailed in this test report.

The test results recorded herein are based on a single type test of Fitbit, Inc. model FB501 and therefore apply only to the tested sample. The sample was selected and prepared by Arndt Hufenbach of Fitbit, Inc.

DEVIATIONS FROM THE STANDARDS

No deviations were made from the published requirements listed in the scope of this report.

TEST RESULTS SUMMARY**FREQUENCY HOPPING SPREAD SPECTRUM (2400 – 2483.5 MHz, 15 channels or more)**

FCC Rule Part	RSS Rule Part	Description	Measured Value / Comments	Limit / Requirement	Result
15.247 (a) (1)	RSS 210 A8.1 (1)	20dB Bandwidth	Basic: 885kHz EDR: 1350 kHz	Channel spacing > 2/3rds 20dB bandwidth	Complies
		Channel Separation	1 MHz		Complies
15.247 (a) (1) (iii)	RSS 210 A8.1 (4)	Channel Dwell Time (average time of occupancy)	Device complies with Bluetooth specifications with a minimum of 20 hopping channels	<0.4 second within a period of 0.4 x number of channels	Complies
15.247 (a) (1) (iii)	RSS 210 A8.1 (4)	Number of Channels		15 or more	Complies
15.247 (a) (1)	RSS 210 A8.1 (1)	Channel Utilization	The system uses the BlueTooth algorithm and, therefore, meets all requirements for channel utilization.	All channels shall, on average, be used equally	Complies
15.247 (b) (3)	RSS 210 A8.4 (2)	Output Power (multipoint systems)	Basic: 4.2 dBm (0.0026W) EDR: 6.6 dBm (0.0046 W) EIRP = 0.0027 W ^{Note 1}	0.125Watt	Complies
15.247(c)	RSS 210 A8.5	Spurious Emissions – 30MHz – 25GHz	All spurious emissions < -20dBc	< -20dBc	Complies
15.247(c) / 15.209	RSS 210 A8.5 Table 2, 3	Radiated Spurious Emissions 30MHz – 25GHz	51.8 dBµV/m @ 19527.0 MHz (-2.2 dB)	15.207 in restricted bands, all others < -20dBc	Complies
15.247 (a) (1)	RSS 210 A8.1(2)	Receiver bandwidth	Refer to operational description	Shall match the channel bandwidth	Complies
Note 1: EIRP calculated using antenna gain of -2.22 dBi					

GENERAL REQUIREMENTS APPLICABLE TO ALL BANDS

FCC Rule Part	RSS Rule part	Description	Measured Value / Comments	Limit / Requirement	Result (margin)
15.203	-	RF Connector	Antenna is internal and integral	Unique or integral antenna required	Complies
15.207	RSS GEN Table 4	AC Conducted Emissions	49.3 dB μ V @ 0.157 MHz (-16.3 dB)	Refer to page 18	Complies
15.109	RSS GEN 7.2.3 Table 1	Receiver spurious emissions	N/A – receiver tunes above 960MHz		
15.247 (b) (5) 15.407 (f)	RSS 102	RF Exposure Requirements	Refer to SAR Exclusion calculations in separate exhibit, RSS 102 declaration and User Manual statements.	Refer to OET 65, FCC Part 1 and RSS 102	Complies
-	RSP 100 RSS GEN 7.1.3	User Manual	-	Statement required regarding non-interference	Complies
-	RSP 100 RSS GEN 7.1.2	User Manual	-	Statement for products with detachable antenna	N/A
-	RSP 100 RSS GEN 4.6.1	99% Bandwidth	Basic: 866kHz EDR: 1228 kHz	Information only	N/A

MEASUREMENT UNCERTAINTIES

ISO/IEC 17025 requires that an estimate of the measurement uncertainties associated with the emissions test results be included in the report. The measurement uncertainties given below are based on a 95% confidence level and were calculated in accordance with UKAS document LAB 34.

Measurement Type	Measurement Unit	Frequency Range	Expanded Uncertainty
RF power, conducted (power meter)	dBm	25 to 7000 MHz	± 0.52 dB
RF power, conducted (Spectrum analyzer)	dBm	25 to 7000 MHz	± 0.7 dB
Conducted emission of transmitter	dBm	25 to 26500 MHz	± 0.7 dB
Conducted emission of receiver	dBm	25 to 26500 MHz	± 0.7 dB
Radiated emission (substitution method)	dBm	25 to 26500 MHz	± 2.5 dB
Radiated emission (field strength)	dB μ V/m	25 to 1000 MHz	± 3.6 dB
		1000 to 40000 MHz	± 6.0 dB
Conducted Emissions (AC Power)	dB μ V	0.15 to 30 MHz	± 2.4 dB

EQUIPMENT UNDER TEST (EUT) DETAILS

GENERAL

The Fitbit, Inc. model FB501 is a wearable fitness tracker. The EUT was treated as handheld equipment during testing to simulate the end-user environment. The EUT is powered via a rechargeable Li battery.

The sample was received on July 7, 2014 and tested on July 7, 11, 18, and 21, 2014. The EUT consisted of the following component(s):

Company	Model	Description	Serial Number	FCC ID
Fitbit	FB501	Fitness tracker	1 (radiated sample)	XRAFB501
Fitbit	FB501	Fitness tracker	prototype (RF conducted sample)	XRAFB501

OTHER EUT DETAILS

The following EUT details should be noted:

BT 4.0 (Basic/EDR/LE)

USB transfer data

ANTENNA SYSTEM

Internal antenna, -2.22dBi

ENCLOSURE

The EUT enclosure is primarily constructed of rubberized plastic. It measures approximately 3.5 cm wide by 1.2 cm deep by 3.2 cm high.

MODIFICATIONS

No modifications were made to the EUT during the time the product was at NTS Silicon Valley.

SUPPORT EQUIPMENT

The following equipment was used as local support equipment for testing:

Company	Model	Description	Serial Number	FCC ID
Lenovo	T430	Laptop Computer	A2113440	N/A
Lenovo	42T4418	AC/DC Adapter	11S42T4418Z1ZGW G25C49K	N/A

The following equipment was used as remote support equipment for testing:

Company	Model	Description	Serial Number	FCC ID
Cisco	SG100D-08	8port Ethernet Switch	DNI7120EB1	N/A
Gateway	25WT3	Laptop Computer	NXY47AA0034160B3 BE3400	N/A
Chicony	A13-040N3A	AC/DC Adapter	F254111411056692	N/A

EUT INTERFACE PORTS

The I/O cabling configuration during testing was as follows:

Port	Connected To	Cable(s)		
		Description	Shielded or Unshielded	Length(m)
USB/Charge	Lenovo Laptop	Multiconductor	Shielded	0.96

Additional on Support Equipment

Port	Connected To	Cable(s)		
		Description	Shielded or Unshielded	Length(m)
Lenovo Laptop - Ethernet	Remote Switch	CAT5	Unshielded	10
Lenovo Laptop - DC In	AC/DC Adapter	Multiconductor	Shielded	1.5
Lenovo AC/DC Adapter	AC Mains	2wire	Unshielded	1
Remote Switch	Remote Gateway Laptop	CAT5	Unshielded	2
Gateway Laptop - DC In	AC/DC Adapter	Multiconductor	Shielded	1.5
Chicony AC/DC Adapter	AC Mains	2wire	Unshielded	1

EUT OPERATION

Unless otherwise noted, the EUT was configured for continuous transmission at the maximum output power. The modulation used is noted for each test.

TEST SITE**GENERAL INFORMATION**

Final test measurements were taken at the test sites listed below. Pursuant to section 2.948 of the FCC's Rules and section 3.3 of RSP-100, construction, calibration, and equipment data has been filed with the Commission and with industry Canada.

Site	Designation / Registration Numbers		Location
	FCC	Canada	
Chamber 3	US00027	2845B-e	41039 Boyce Road Fremont, CA 94538-2435
Chamber 7	US0027	2845B-7	

ANSI C63.4 recommends that ambient noise at the test site be at least 6 dB below the allowable limits. Ambient levels are below this requirement. The test site(s) contain separate areas for radiated and conducted emissions testing. Considerable engineering effort has been expended to ensure that the facilities conform to all pertinent requirements of ANSI C63.4.

CONDUCTED EMISSIONS CONSIDERATIONS

Conducted emissions testing is performed in conformance with ANSI C63.10. Measurements are made with the EUT connected to the public power network through a nominal, standardized RF impedance, which is provided by a line impedance stabilization network, known as a LISN. A LISN is inserted in series with each current-carrying conductor in the EUT power cord.

RADIATED EMISSIONS CONSIDERATIONS

The FCC has determined that radiation measurements made in a shielded enclosure are not suitable for determining levels of radiated emissions. Radiated measurements are performed in an open field environment or in a semi-anechoic chamber. The test sites are maintained free of conductive objects within the CISPR defined elliptical area incorporated in ANSI C63.4 guidelines and meet the Normalized Site Attenuation (NSA) requirements of ANSI C63.4.

MEASUREMENT INSTRUMENTATION

RECEIVER SYSTEM

An EMI receiver as specified in CISPR 16-1-1 is used for emissions measurements. The receivers used can measure over the frequency range of 9 kHz up to 2000 MHz. These receivers allow both ease of measurement and high accuracy to be achieved. The receivers have Peak, Average, and CISPR (Quasi-peak) detectors built into their design so no external adapters are necessary. The receiver automatically sets the required bandwidth for the CISPR detector used during measurements. If the repetition frequency of the signal being measured is below 20Hz, peak measurements are made in lieu of Quasi-Peak measurements.

For measurements above the frequency range of the receivers, a spectrum analyzer is utilized because it provides visibility of the entire spectrum along with the precision and versatility required to support engineering analysis. Average measurements above 1000MHz are performed on the spectrum analyzer using the linear-average method with a resolution bandwidth of 1 MHz and a video bandwidth of 10 Hz, unless the signal is pulsed in which case the average (or video) bandwidth of the measuring instrument is reduced to onset of pulse desensitization and then increased.

INSTRUMENT CONTROL COMPUTER

The receivers utilize either a Rohde & Schwarz EZM Spectrum Monitor/Controller or contain an internal Spectrum Monitor/Controller to view and convert the receiver measurements to the field strength at an antenna or voltage developed at the LISN measurement port, which is then compared directly with the appropriate specification limit. This provides faster, more accurate readings by performing the conversions described under Sample Calculations within the Test Procedures section of this report. Results are printed in a graphic and/or tabular format, as appropriate. A personal computer is used to record all measurements made with the receivers.

The Spectrum Monitor provides a visual display of the signal being measured. In addition, the controller or a personal computer run automated data collection programs which control the receivers. This provides added accuracy since all site correction factors, such as cable loss and antenna factors are added automatically.

LINE IMPEDANCE STABILIZATION NETWORK (LISN)

Line conducted measurements utilize a fifty microhenry Line Impedance Stabilization Network as the monitoring point. The LISN used also contains a 250 uH CISPR adapter. This network provides for calibrated radio frequency noise measurements by the design of the internal low pass and high pass filters on the EUT and measurement ports, respectively.

FILTERS/ATTENUATORS

External filters and precision attenuators are often connected between the receiving antenna or LISN and the receiver. This eliminates saturation effects and non-linear operation due to high amplitude transient events.

ANTENNAS

A loop antenna is used below 30 MHz. For the measurement range 30 MHz to 1000 MHz either a combination of a biconical antenna and a log periodic or a bi-log antenna is used. Above 1000 MHz, horn antennas are used. The antenna calibration factors to convert the received voltage to an electric field strength are included with appropriate cable loss and amplifier gain factors to determine an overall site factor, which is then programmed into the test receivers or incorporated into the test software.

ANTENNA MAST AND EQUIPMENT TURNTABLE

The antennas used to measure the radiated electric field strength are mounted on a non-conductive antenna mast equipped with a motor-drive to vary the antenna height. Measurements below 30 MHz are made with the loop antenna at a fixed height of 1m above the ground plane.

ANSI C63.10 specifies that the test height above ground for table mounted devices shall be 80 centimeters. Floor mounted equipment shall be placed on the ground plane if the device is normally used on a conductive floor or separated from the ground plane by insulating material from 3 to 12 mm if the device is normally used on a non-conductive floor as specified in ANSI C63.4. During radiated measurements, the EUT is positioned on a motorized turntable in conformance with this requirement.

INSTRUMENT CALIBRATION

All test equipment is regularly checked to ensure that performance is maintained in accordance with the manufacturer's specifications. All antennas are calibrated at regular intervals with respect to tuned half-wave dipoles. An exhibit of this report contains the list of test equipment used and calibration information.

TEST PROCEDURES

EUT AND CABLE PLACEMENT

The regulations require that interconnecting cables be connected to the available ports of the unit and that the placement of the unit and the attached cables simulate the worst case orientation that can be expected from a typical installation, so far as practicable. To this end, the position of the unit and associated cabling is varied within the guidelines of ANSI C63.10, and the worst-case orientation is used for final measurements.

CONDUCTED EMISSIONS

Conducted emissions are measured at the plug end of the power cord supplied with the EUT. Excess power cord length is wrapped in a bundle between 30 and 40 centimeters in length near the center of the cord. Preliminary measurements are made to determine the highest amplitude emission relative to the specification limit for all the modes of operation. Placement of system components and varying of cable positions are performed in each mode. A final peak mode scan is then performed in the position and mode for which the highest emission was noted on all current carrying conductors of the power cord.

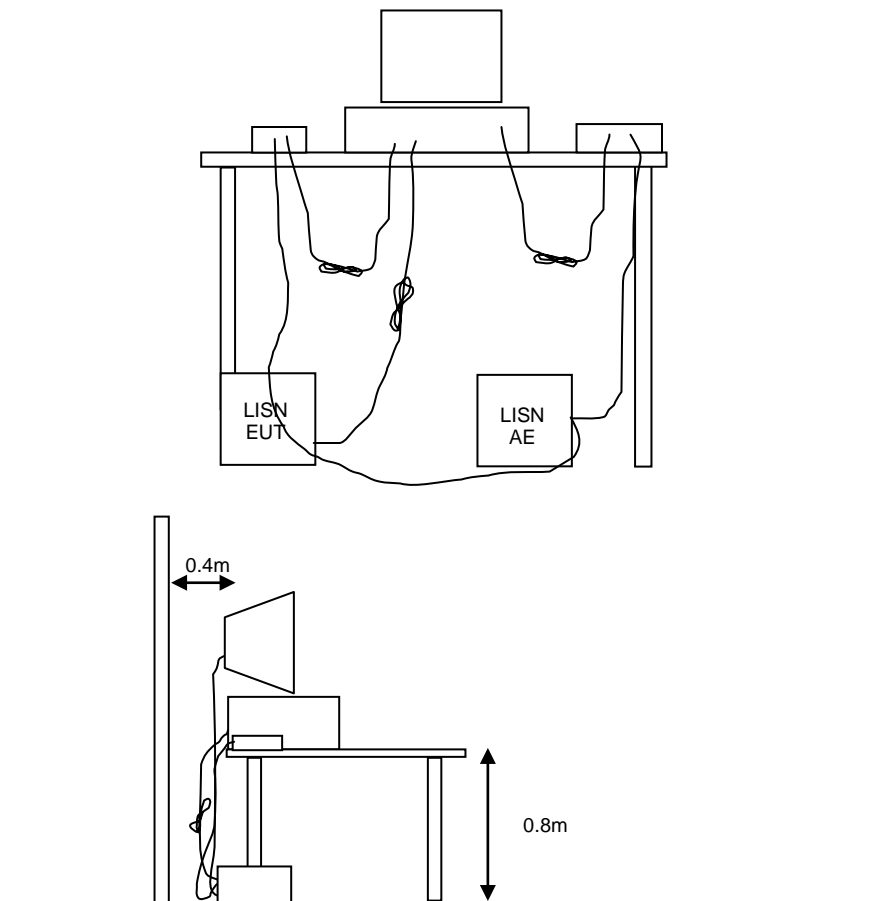

Figure 1 Typical Conducted Emissions Test Configuration

RADIATED EMISSIONS

A preliminary scan of the radiated emissions is performed in which all significant EUT frequencies are identified with the system in a nominal configuration. At least two scans are performed, one scan for each antenna polarization (horizontal and vertical; loop parallel and perpendicular to the EUT). During the preliminary scans, the EUT is rotated through 360°, the antenna height is varied (for measurements above 30 MHz) and cable positions are varied to determine the highest emission relative to the limit. Preliminary scans may be performed in a fully anechoic chamber for the purposes of identifying the frequencies of the highest emissions from the EUT.

A speaker is provided in the receiver to aid in discriminating between EUT and ambient emissions. Other methods used during the preliminary scan for EUT emissions involve scanning with near field magnetic loops, monitoring I/O cables with RF current clamps, and cycling power to the EUT.

Final maximization is a phase in which the highest amplitude emissions identified in the spectral search are viewed while the EUT azimuth angle is varied from 0 to 360 degrees relative to the receiving antenna. The azimuth, which results in the highest emission is then maintained while varying the antenna height from one to four meters (for measurements above 30 MHz, measurements below 30 MHz are made with the loop antenna at a fixed height of 1m). The result is the identification of the highest amplitude for each of the highest peaks. Each recorded level is corrected in the receiver using appropriate factors for cables, connectors, antennas, and preamplifier gain.

When testing above 18 GHz, the receive antenna is located at 1 meter from the EUT and the antenna height is restricted to a maximum of 2.5 meters.

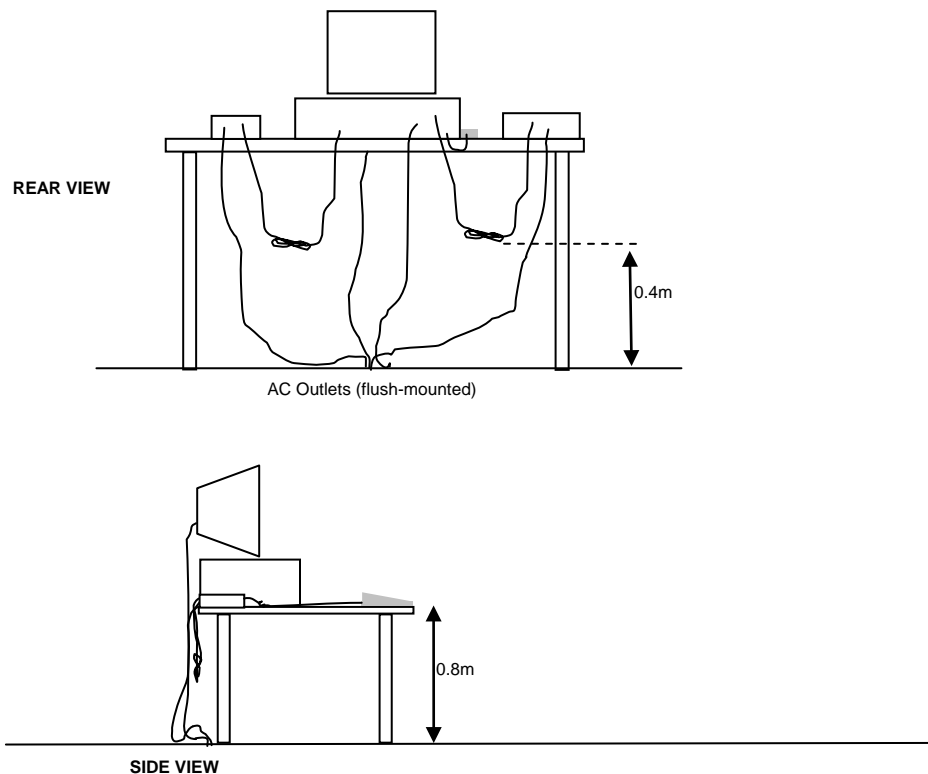

Typical Test Configuration for Radiated Field Strength Measurements

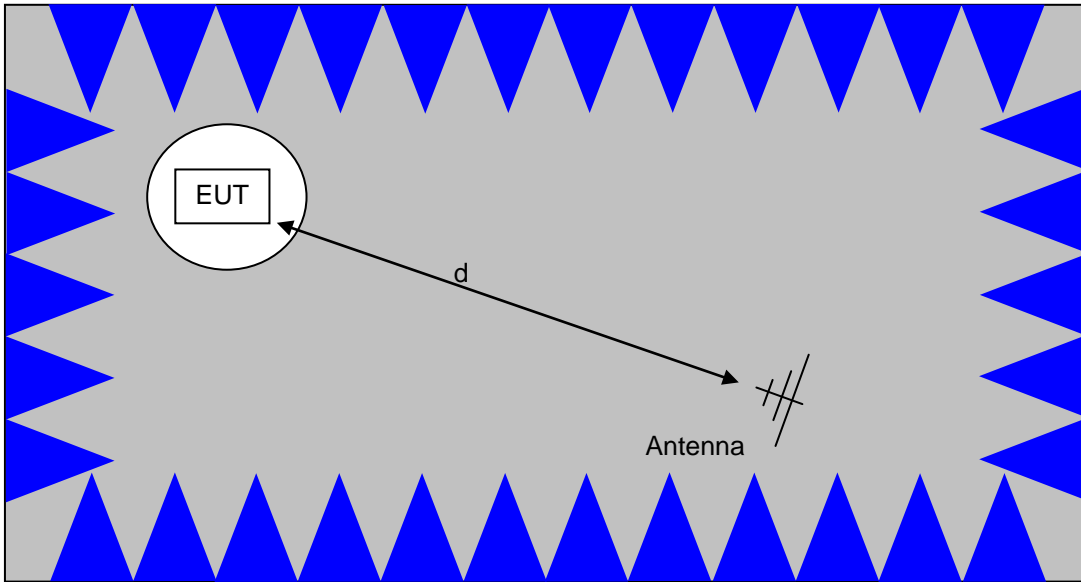

The anechoic materials on the walls and ceiling ensure compliance with the normalized site attenuation requirements of CISPR 16 / CISPR 22 / ANSI C63.4 for an alternate test site at the measurement distances used.

Floor-standing equipment is placed on the floor with insulating supports between the unit and the ground plane.

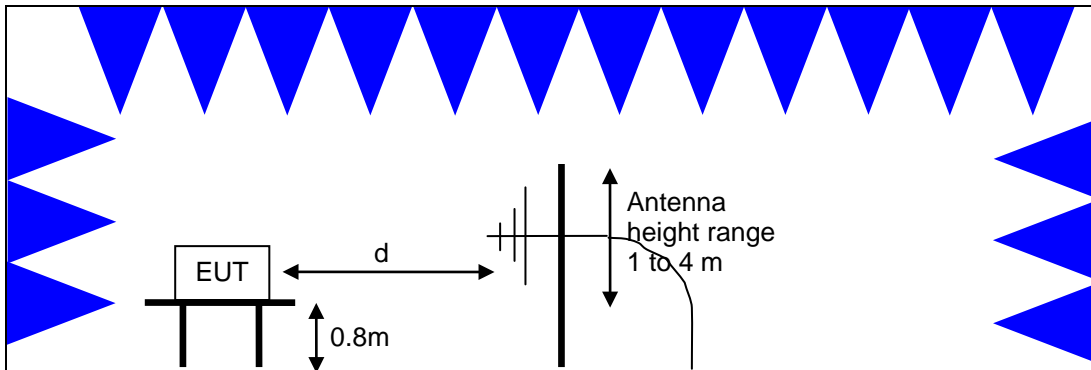

Test Configuration for Radiated Field Strength Measurements
Semi-Anechoic Chamber, Plan and Side Views

CONDUCTED EMISSIONS FROM ANTENNA PORT

Direct measurements of power, bandwidth and power spectral density are performed, where possible, with the antenna port of the EUT connected to either the power meter or spectrum analyzer via a suitable attenuator and/or filter. These are used to ensure that the front end of the measurement instrument is not overloaded by the fundamental transmission.

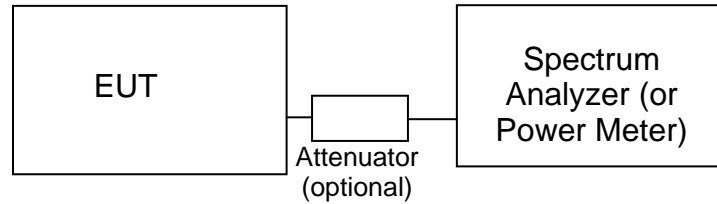
**Test Configuration for Antenna Port Measurements**

Measurement bandwidths (video and resolution) are set in accordance with the relevant standards and NTS Silicon Valley's test procedures for the type of radio being tested. When power measurements are made using a resolution bandwidth less than the signal bandwidth the power is calculated by summing the power across the signal bandwidth using either the analyzer channel power function or by capturing the trace data and calculating the power using software. In both cases the summed power is corrected to account for the equivalent noise bandwidth (ENBW) of the resolution bandwidth used.

If power averaging is used (typically for certain digital modulation techniques), the EUT is configured to transmit continuously. Power averaging is performed using either the built-in function of the analyzer or, if the analyzer does not feature power averaging, using external software. In both cases the average power is calculated over a number of sweeps (typically 100). When the EUT cannot be configured to continuously transmit then either the analyzer is configured to perform a gated sweep to ensure that the power is averaged over periods that the device is transmitting or power averaging is disabled and a max-hold feature is used.

If a power meter is used to make output power measurements the sensor head type (peak or average) is stated in the test data table.

BANDWIDTH MEASUREMENTS

The 6dB, 20dB, 26dB and/or 99% signal bandwidth are measured using the bandwidths recommended by ANSI C63.10 and RSS GEN.

SPECIFICATION LIMITS AND SAMPLE CALCULATIONS

The limits for conducted emissions are given in units of microvolts, and the limits for radiated emissions are given in units of microvolts per meter at a specified test distance. Data is measured in the logarithmic form of decibels relative to one microvolt, or dB microvolts (dBuV). For radiated emissions, the measured data is converted to the field strength at the antenna in dB microvolts per meter (dBuV/m). The results are then converted to the linear forms of uV and uV/m for comparison to published specifications.

For reference, converting the specification limits from linear to decibel form is accomplished by taking the base ten logarithm, then multiplying by 20. These limits in both linear and logarithmic form are as follows:

CONDUCTED EMISSIONS SPECIFICATION LIMITS: FCC 15.207; FCC 15.107(a), RSS GEN

The table below shows the limits for the emissions on the AC power line from an intentional radiator and a receiver.

Frequency (MHz)	Average Limit (dBuV)	Quasi Peak Limit (dBuV)
0.150 to 0.500	Linear decrease on logarithmic frequency axis between 56.0 and 46.0	Linear decrease on logarithmic frequency axis between 66.0 and 56.0
0.500 to 5.000	46.0	56.0
5.000 to 30.000	50.0	60.0

GENERAL TRANSMITTER RADIATED EMISSIONS SPECIFICATION LIMITS

The table below shows the limits for the spurious emissions from transmitters that fall in restricted bands¹ (with the exception of transmitters operating under FCC Part 15 Subpart D and RSS 210 Annex 9), the limits for all emissions from a low power device operating under the general rules of RSS 310 (tables 3 and 4), RSS 210 (table 2) and FCC Part 15 Subpart C section 15.209.

Frequency Range (MHz)	Limit (uV/m)	Limit (dBuV/m @ 3m)
0.009-0.490	$2400/F_{\text{KHz}} @ 300\text{m}$	$67.6-20*\log_{10}(F_{\text{KHz}}) @ 300\text{m}$
0.490-1.705	$24000/F_{\text{KHz}} @ 30\text{m}$	$87.6-20*\log_{10}(F_{\text{KHz}}) @ 30\text{m}$
1.705 to 30	30 @ 30m	29.5 @ 30m
30 to 88	100 @ 3m	40 @ 3m
88 to 216	150 @ 3m	43.5 @ 3m
216 to 960	200 @ 3m	46.0 @ 3m
Above 960	500 @ 3m	54.0 @ 3m

¹ The restricted bands are detailed in FCC 15.203, RSS 210 Table 1 and RSS 310 Table 2

OUTPUT POWER LIMITS – FHSS SYSTEMS

The table below shows the limits for output power based on the number of channels available for the hopping system.

Operating Frequency (MHz)	Number of Channels	Output Power
902 – 928	≥ 50	1 Watt (30 dBm)
902 – 928	25 to 49	0.25 Watts (24 dBm)
2400 – 2483.5	≥ 75	1 Watt (30 dBm)
2400 – 2483.5	< 75	0.125 Watts (21 dBm)
5725 – 5850	75	1 Watt (30 dBm)

The maximum permitted output power is reduced by 1dB for every dB the antenna gain exceeds 6dBi. Fixed point-to-point applications using the 5725 – 5850 MHz band are not subject to this restriction.

TRANSMIT MODE SPURIOUS RADIATED EMISSIONS LIMITS – FHSS and DTS SYSTEMS

The limits for unwanted (spurious) emissions from the transmitter falling in the restricted bands are those specified in the general limits sections of FCC Part 15 and RSS 210. All other unwanted (spurious) emissions shall be at least 20dB below the level of the highest in-band signal level (30dB if the power is measured using the sample detector/power averaging method).

SAMPLE CALCULATIONS - CONDUCTED EMISSIONS

Receiver readings are compared directly to the conducted emissions specification limit (decibel form) as follows:

$$R_T - S = M$$

where:

R_T = Receiver Reading in dBuV

S = Specification Limit in dBuV

M = Margin to Specification in +/- dB

SAMPLE CALCULATIONS - RADIATED EMISSIONS

Receiver readings are compared directly to the specification limit (decibel form). The receiver internally corrects for cable loss, preamplifier gain, and antenna factor. The calculations are in the reverse direction of the actual signal flow, thus cable loss is added and the amplifier gain is subtracted. The Antenna Factor converts the voltage at the antenna coaxial connector to the field strength at the antenna elements.

A distance factor, when used for electric field measurements above 30MHz, is calculated by using the following formula:

$$F_d = 20 * \text{LOG}_{10} (D_m/D_s)$$

where:

$$F_d = \text{Distance Factor in dB}$$

$$D_m = \text{Measurement Distance in meters}$$

$$D_s = \text{Specification Distance in meters}$$

For electric field measurements below 30MHz the extrapolation factor is either determined by making measurements at multiple distances or a theoretical value is calculated using the formula:

$$F_d = 40 * \text{LOG}_{10} (D_m/D_s)$$

Measurement Distance is the distance at which the measurements were taken and Specification Distance is the distance at which the specification limits are based. The antenna factor converts the voltage at the antenna coaxial connector to the field strength at the antenna elements.

The margin of a given emission peak relative to the limit is calculated as follows:

$$R_c = R_r + F_d$$

and

$$M = R_c - L_s$$

where:

$$R_r = \text{Receiver Reading in dBuV/m}$$

$$F_d = \text{Distance Factor in dB}$$

$$R_c = \text{Corrected Reading in dBuV/m}$$

$$L_s = \text{Specification Limit in dBuV/m}$$

$$M = \text{Margin in dB Relative to Spec}$$

SAMPLE CALCULATIONS - FIELD STRENGTH TO EIRP CONVERSION

Where the radiated electric field strength is expressed in terms of the equivalent isotropic radiated power (eirp), or where a field strength measurement of output power is made in lieu of a direct measurement, the following formula is used to convert between eirp and field strength at a distance of d (meters) from the equipment under test:

$$E = \frac{1000000 \sqrt{30 P}}{d} \quad \text{microvolts per meter}$$

where P is the eirp (Watts)

For a measurement at 3m the conversion from a logarithmic value for field strength (dBuV/m) to an eirp power (dBm) is -95.3dB.

Appendix A Test Equipment Calibration Data

<u>Manufacturer</u>	<u>Description</u>	<u>Model</u>	<u>Asset #</u>	<u>Cal Due</u>
Radiated Emissions, 1000 - 18,000 MHz, 11-Jul-14				
Hewlett Packard	SpecAn 9 kHz - 40 GHz, FT (SA40) Blue	8564E (84125C)	1393	5/6/2015
Rohde & Schwarz	EMI Test Receiver, 20 Hz-7 GHz	ESIB7	1538	12/14/2014
Hewlett Packard	Microwave Preamplifier, 1-26.5GHz	8449B	1780	11/26/2014
Micro-Tronics	Band Reject Filter, 2400-2500 MHz	BRM50702-02	2249	10/3/2014
EMCO	Antenna, Horn, 1-18 GHz	3115	2870	8/20/2015
Radio Antenna Port (Power and Spurious Emissions), 18-Jul-14				
Rohde & Schwarz	Power Sensor 100 uW - 2 Watts (w/ 20 dB pad, SN BJ5155)	NRV-Z32	1536	12/19/2014
Agilent Technologies	PSA, Spectrum Analyzer, (installed options, 111, 115, 123, 1DS, B7J, HYX,	E4446A	2139	4/8/2015
Radio Antenna Port (Power and Spurious Emissions), 18-Jul-14				
Rohde & Schwarz	Power Meter, Dual Channel	NRVD	1071	3/24/2015
Rohde & Schwarz	Power Sensor 100 uW - 2 Watts (w/ 20 dB pad, SN BJ5155)	NRV-Z32	1536	12/19/2014
Agilent Technologies	PSA, Spectrum Analyzer, (installed options, 111, 115, 123, 1DS, B7J, HYX,	E4446A	2139	4/8/2015
Radio Antenna Port (Power and Spurious Emissions), 21-Jul-14				
Rohde & Schwarz	Power Meter, Dual Channel	NRVD	1071	3/24/2015
Rohde & Schwarz	Power Sensor 100 uW - 2 Watts (w/ 20 dB pad, SN BJ5155)	NRV-Z32	1536	12/19/2014
Agilent Technologies	PSA, Spectrum Analyzer, (installed options, 111, 115, 123, 1DS, B7J, HYX,	E4446A	2139	4/8/2015
Conducted Emissions - AC Power Ports, 07-Jul-14				
<u>Manufacturer</u>	<u>Description</u>	<u>Model</u>	<u>Asset #</u>	<u>Cal Due</u>
EMCO	LISN, 10 kHz-100 MHz, 25A	3825/2	1292	2/13/2015
Rohde & Schwarz	Pulse Limiter	ESH3 Z2	1594	5/15/2015
Rohde & Schwarz	EMI Test Receiver, 20 Hz-7 GHz	ESIB7	1756	6/14/2015
FCC	Decoupling Network	F-203I-DCN-23mm	2457	N/A

Appendix B Test Data

T95507 Pages 25 – 62

T95502 Pages 63 – 66



EMC Test Data

Client:	Fitbit, Inc.	Job Number:	J95447
Product:	FB501 (Proton)	T-Log Number:	T95507
		Project Manager:	Deepa Shetty
Contact:	Arndt Hufenbach	Project Coordinator:	Irene Rademacher
Emissions Standard(s):	FCC 15.247/RSS-210/LP 00002	Class:	-
Immunity Standard(s):	-	Environment:	-

EMC Test Data

For The

Fitbit, Inc.

Product

FB501 (Proton)

Date of Last Test: 7/29/2014



EMC Test Data

Client: Fitbit, Inc.	Job Number: J95447
Model: FB501 (Proton)	T-Log Number: T95507
	Project Manager: Deepa Shetty
Contact: Arndt Hufenbach	Project Coordinator: Irene Rademacher
Standard: FCC 15.247/RSS-210/LP 00002	Class: N/A

RSS 210 and FCC 15.247 (DTS) Radiated Spurious Emissions

Test Specific Details

Objective: The objective of this test session is to perform final qualification testing of the EUT with respect to the specification listed above.

General Test Configuration

The EUT and all local support equipment were located on the turntable for radiated spurious emissions testing. For radiated emissions testing the measurement antenna was located 3 meters from the EUT, unless otherwise noted.

Ambient Conditions:

Temperature: 18-23 °C
Rel. Humidity: 30-35 %

Summary of Results - Device Operating in the 2400-2483.5 MHz Band

Run #	Mode	Channel	Target Setting	Power Setting	Test Performed	Limit	Result / Margin
1	Basic - GFSK	2402MHz	6	6	Restricted Band Edge (2390 MHz)	FCC Part 15.209 / 15.247(c)	30.2 dBµV/m @ 2374.5 MHz (-23.8 dB)
		2480MHz			Restricted Band Edge (2483.5 MHz)		31.3 dBµV/m @ 2483.5 MHz (-22.7 dB)
2	EDR - 8PSK	2402MHz	6	6	Restricted Band Edge (2390 MHz)		30.4 dBµV/m @ 2377.6 MHz (-23.6 dB)
		2480MHz			Restricted Band Edge (2483.5 MHz)		34.4 dBµV/m @ 2483.5 MHz (-19.6 dB)

Modifications Made During Testing

No modifications were made to the EUT during testing

Deviations From The Standard

No deviations were made from the requirements of the standard.

Sample Notes

Sample S/N: 1
Driver: F13.1
Antenna: Internal

Client: Fitbit, Inc.	Job Number: J95447
Model: FB501 (Proton)	T-Log Number: T95507
	Project Manager: Deepa Shetty
Contact: Arndt Hufenbach	Project Coordinator: Irene Rademacher
Standard: FCC 15.247/RSS-210/LP 00002	Class: N/A

Notes

Device is handheld. Determination of worse case orientation was done as a measurement of the fundamental at the center channel.

Procedure Comments:

Measurements performed in accordance with FCC KDB 558074

Peak measurements performed with: RBW=1MHz, VBW=3MHz, peak detector, max hold, auto sweep time

Unless otherwise stated/noted, emission has duty cycle $\geq 98\%$ and was measured using RBW=1MHz, VBW=10Hz, peak detector, linear average mode, auto sweep time, max hold.

Mode	Data Rate	Duty Cycle (x)	Constant DC?	T (ms)	Pwr Cor Factor*	Lin Volt Cor Factor**	Min VBW for FS (Hz)
Basic	1 Mb/s	1.00	-	-	0	0	-
EDR	3 Mb/s	1.00	-	-	0	0	-

Measurement Specific Notes:

Note 3:	Emission has duty cycle $< 98\%$, but constant, average measurement performed: RBW=1MHz, VBW=10Hz, peak detector, linear averaging, auto sweep, trace average 100 traces, measurement corrected by Linear Voltage correction factor
Note 6:	Plots of the average and peak bandedge do not account for any duty cycle correction. Refer to the tabular results for final measurements.



EMC Test Data

Client: Fitbit, Inc.	Job Number: J95447
Model: FB501 (Proton)	T-Log Number: T95507
	Project Manager: Deepa Shetty
Contact: Arndt Hufenbach	Project Coordinator: Irene Rademacher
Standard: FCC 15.247/RSS-210/LP 00002	Class: N/A

Run #0: Worse Case Orientation

Date of Test: 7/11/2014 0:00
 Test Engineer: John Caizzi
 Test Location: Chamber 7

Config. Used: 1
 Config Change: none
 Host Voltage: 120V / 60Hz

Channel: 2441MHz Mode: Basic
 Tx Chain: Main Data Rate: 1 Mb/s

Frequency	Level	Pol	15.209 / 15.247		Detector	Azimuth	Height	Comments
MHz	dB μ V/m	v/h	Limit	Margin	Pk/QP/Avg	degrees	meters	
2441.010	87.4	V	-	-	Pk	344	1.00	Side
2441.090	91.0	H	-	-	Pk	0	2.16	Side
2441.030	87.3	V	-	-	Pk	349	1.00	Face down
2441.070	92.3	H	-	-	Pk	17	2.16	Face down
2440.970	89.2	V	-	-	Pk	346	1.00	Upright
2441.070	85.4	H	-	-	Pk	0	2.15	Upright

Note 7 All measurements made with RBW = 100 kHz, VBW = 300 kHz.



EMC Test Data

Client: Fitbit, Inc.	Job Number: J95447
Model: FB501 (Proton)	T-Log Number: T95507
	Project Manager: Deepa Shetty
Contact: Arndt Hufenbach	Project Coordinator: Irene Rademacher
Standard: FCC 15.247/RSS-210/LP 00002	Class: N/A

Run #1: Radiated Bandedge Measurements

Date of Test: 7/11/2014 0:00
 Test Engineer: John Caizzi
 Test Location: Chamber 7

Config. Used: 1
 Config Change: none
 Host Voltage: 120V / 60Hz

Channel: 2402 MHz Mode: Basic
 Tx Chain: Main Data Rate: 1 Mb/s

Band Edge Signal Field Strength - Direct measurement of field strength

Frequency	Level	Pol	15.209 / 15.247		Detector	Azimuth	Height	Comments
MHz	dB μ V/m	v/h	Limit	Margin	Pk/QP/Avg	degrees	meters	
2374.450	30.2	H	54.0	-23.8	AVG	360	1.12	
2379.740	42.5	H	74.0	-31.5	PK	360	1.12	
2377.010	30.1	V	54.0	-23.9	AVG	165	1.00	
2351.920	42.6	V	74.0	-31.4	PK	165	1.00	

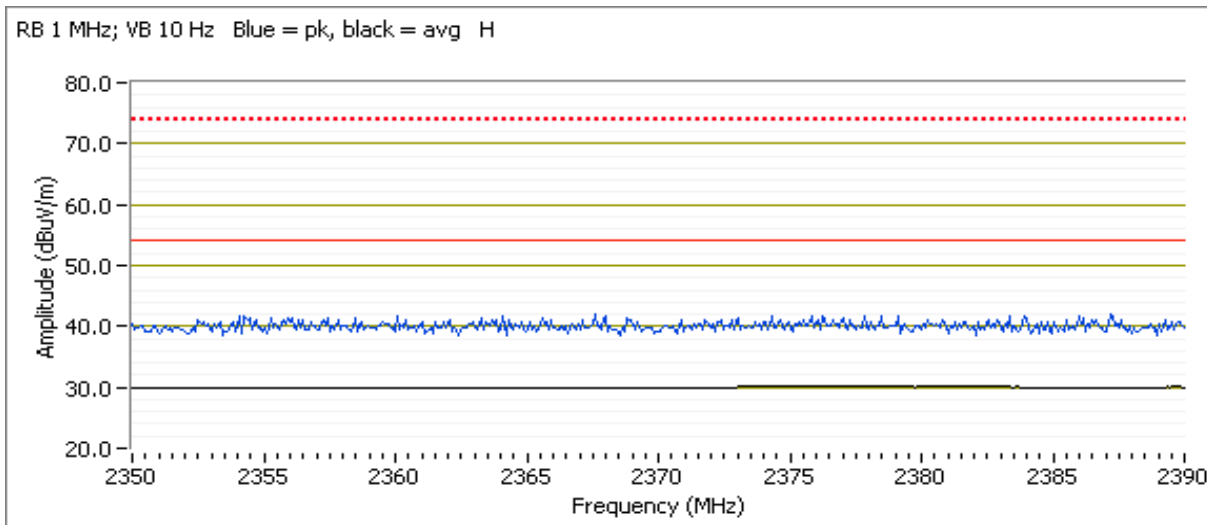



EMC Test Data

Client: Fitbit, Inc.	Job Number: J95447
Model: FB501 (Proton)	T-Log Number: T95507
Contact: Arndt Hufenbach	Project Manager: Deepa Shetty
Standard: FCC 15.247/RSS-210/LP 00002	Project Coordinator: Irene Rademacher
	Class: N/A

Channel: 2480 MHz Mode: Basic
 Tx Chain: Main Data Rate: 1 Mb/s

Band Edge Signal Field Strength - Direct measurement of field strength

Frequency MHz	Level dB μ V/m	Pol v/h	15.209 / 15.247		Detector Pk/QP/Avg	Azimuth degrees	Height meters	Comments
			Limit	Margin				
2483.500	31.3	H	54.0	-22.7	AVG	315	1.12	
2486.110	43.3	H	74.0	-30.7	PK	315	1.12	
2483.570	30.4	V	54.0	-23.6	AVG	263	1.00	
2485.290	42.3	V	74.0	-31.7	PK	263	1.00	

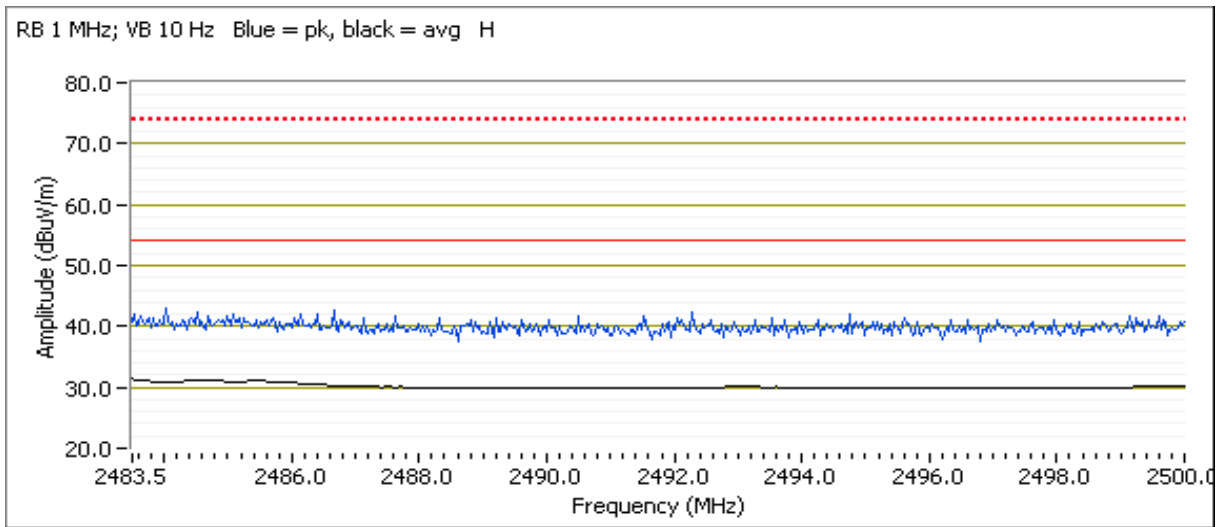



EMC Test Data

Client: Fitbit, Inc.	Job Number: J95447
Model: FB501 (Proton)	T-Log Number: T95507
Contact: Arndt Hufenbach	Project Manager: Deepa Shetty
Standard: FCC 15.247/RSS-210/LP 00002	Project Coordinator: Irene Rademacher
	Class: N/A

Run #2: Radiated Bandedge Measurements

Date of Test: 7/11/2014 0:00
 Test Engineer: John Caizzi
 Test Location: Chamber 7

Config. Used: 1
 Config Change: none
 Host Voltage: 120V / 60Hz

Channel: 2402 MHz Mode: EDR
 Tx Chain: Main Data Rate: 3 Mb/s

Band Edge Signal Field Strength - Direct measurement of field strength

Frequency	Level	Pol	15.209 / 15.247		Detector	Azimuth	Height	Comments
MHz	dB μ V/m	v/h	Limit	Margin	Pk/QP/Avg	degrees	meters	
2377.410	30.3	H	54.0	-23.7	AVG	49	1.91	
2382.630	43.9	H	74.0	-30.1	PK	49	1.91	
2377.580	30.4	V	54.0	-23.6	AVG	240	1.00	POS; RB 1 MHz; VB: 10 Hz
2386.950	43.2	V	74.0	-30.8	PK	240	1.00	POS; RB 1 MHz; VB: 3 MHz

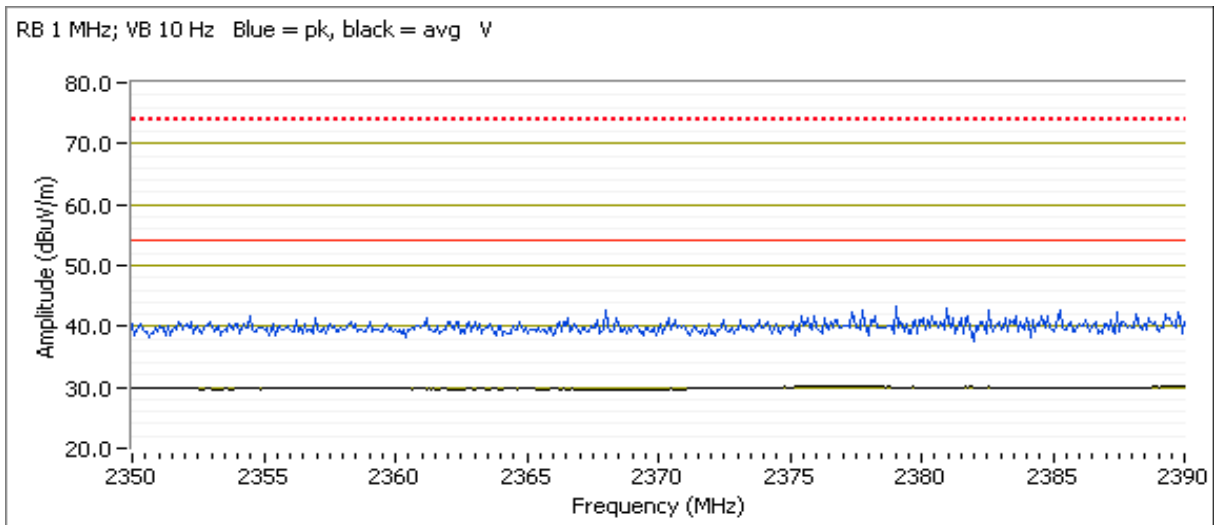



EMC Test Data

Client: Fitbit, Inc.	Job Number: J95447
Model: FB501 (Proton)	T-Log Number: T95507
Contact: Arndt Hufenbach	Project Manager: Deepa Shetty
Standard: FCC 15.247/RSS-210/LP 00002	Project Coordinator: Irene Rademacher
	Class: N/A

Channel: 2480 MHz Mode: EDR
 Tx Chain: Main Data Rate: 3 Mb/s

Band Edge Signal Field Strength - Direct measurement of field strength

Frequency	Level	Pol	15.209 / 15.247		Detector	Azimuth	Height	Comments
MHz	dB μ V/m	v/h	Limit	Margin	PK/QP/Avg	degrees	meters	
2483.670	48.1	H	74.0	-25.9	PK	300	1.74	
2483.500	31.9	V	54.0	-22.1	AVG	243	1.00	
2487.930	43.6	V	74.0	-30.4	PK	243	1.00	

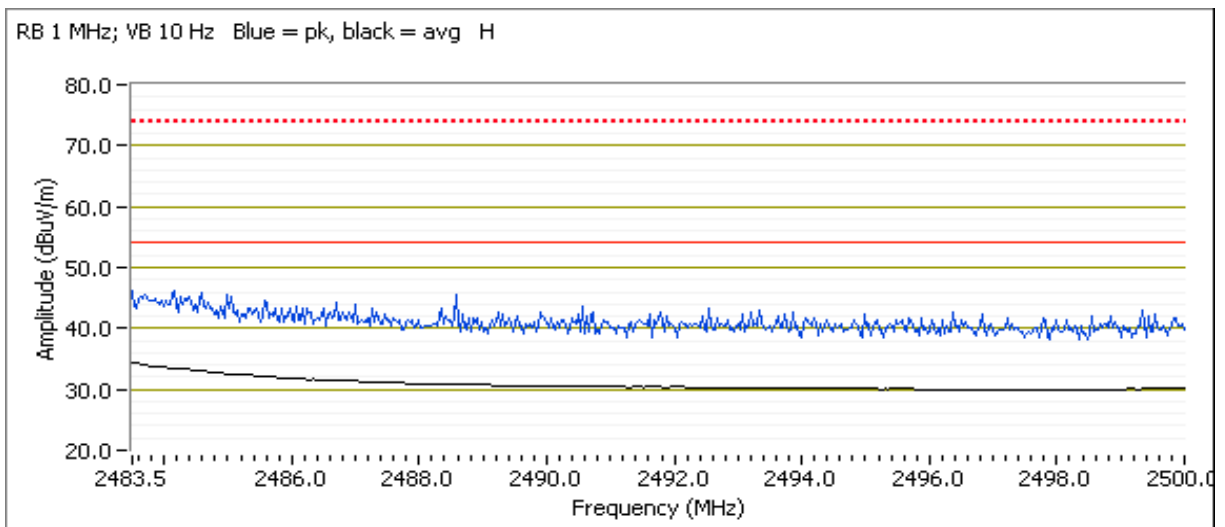



EMC Test Data

Client: Fitbit, Inc.	Job Number: J95447
Model: FB501 (Proton)	T-Log Number: T95507
	Project Manager: Deepa Shetty
Contact: Arndt Hufenbach	Project Coordinator: Irene Rademacher
Standard: FCC 15.247/RSS-210/LP 00002	Class: N/A

RSS 210 and FCC 15.247 (DTS) Radiated Spurious Emissions

Test Specific Details

Objective: The objective of this test session is to perform final qualification testing of the EUT with respect to the specification listed above.

General Test Configuration

The EUT and all local support equipment were located on the turntable for radiated spurious emissions testing.

For radiated emissions testing the measurement antenna was located 3 meters from the EUT, unless otherwise noted.

Ambient Conditions:

Temperature: 22-25 °C
Rel. Humidity: 35-45 %

Summary of Results - Device Operating in the 2400-2483.5 MHz Band

Run #	Mode	Channel	Target Power	Power Setting	Test Performed	Limit	Result / Margin
1	GFSK	2402MHz	6	6	Radiated Emissions, 1 - 25 GHz	FCC Part 15.209 / 15.247(c)	46.1 dBµV/m @ 7206.0 MHz (-7.9 dB)
		2441MHz		6			51.8 dBµV/m @ 19527.0 MHz (-2.2 dB)
		2480MHz		6			49.6 dBµV/m @ 7440.2 MHz (-4.4 dB)
2	8PSK	2402MHz	6	6			45.2 dBµV/m @ 7206.1 MHz (-8.8 dB)
		2441MHz		6			46.0 dBµV/m @ 19528.0 MHz (-8.0 dB)
		2480MHz		6			47.7 dBµV/m @ 7439.9 MHz (-6.3 dB)

Modifications Made During Testing

No modifications were made to the EUT during testing

Deviations From The Standard

No deviations were made from the requirements of the standard.



EMC Test Data

Client: Fitbit, Inc.	Job Number: J95447
Model: FB501 (Proton)	T-Log Number: T95507
	Project Manager: Deepa Shetty
Contact: Arndt Hufenbach	Project Coordinator: Irene Rademacher
Standard: FCC 15.247/RSS-210/LP 00002	Class: N/A

Sample Notes

Sample S/N: 1

Driver: F13.1

Antenna: Internal

Notes

Device is handheld. Determination of worse case orientation was done as a measurement of spurious emissions on center channel for GFSK mode

Procedure Comments:

Measurements performed in accordance with FCC KDB 558074

Peak measurements performed with: RBW=1MHz, VBW=3MHz, peak detector, max hold, auto sweep time

Unless otherwise stated/noted, emission has duty cycle $\geq 98\%$ and was measured using RBW=1MHz, VBW=10Hz, peak detector, linear average mode, auto sweep time, max hold.

2.4GHz band reject filter used

Preliminary testing showed no radio related emissions below 1GHz

Mode	Data Rate	Duty Cycle (x)	Constant DC?	T (ms)	Pwr Cor Factor*	Lin Volt Cor Factor**	Min VBW for FS (Hz)
Basic	1 Mb/s	100%	Constant		0	0	-
EDR	3 Mb/s	100%	Constant		0	0	-

Measurement Specific Notes:

Note 1:	Emission in non-restricted band, but limit of 15.209 used.
Note 2:	Emission in non-restricted band, the limit was set 30dB below the level of the fundamental and measured in 100kHz.
Note 3:	Emission has duty cycle $< 98\%$, but constant, average measurement performed: RBW=1MHz, VBW=10Hz, peak detector, linear averaging, auto sweep, trace average 100 traces, measurement corrected by Linear Voltage correction factor
Note 6:	Plots of the average and peak bandedge do not account for any duty cycle correction. Refer to the tabular results for final measurements.



EMC Test Data

Client: Fitbit, Inc.	Job Number: J95447
Model: FB501 (Proton)	T-Log Number: T95507
	Project Manager: Deepa Shetty
Contact: Arndt Hufenbach	Project Coordinator: Irene Rademacher
Standard: FCC 15.247/RSS-210/LP 00002	Class: N/A

Run #1: Radiated Spurious Emissions, 1,000 - 25000 MHz. Operating Mode: Basic - GFSK

Date of Test: 07/11/14	Config. Used: 1
Test Engineer: J. Caizzi, M. Birgani	Config Change: none
Test Location: Chamber 7	EUT Voltage:

Run #1a: Low Channel

Channel: 2402	Mode: Basic
Tx Chain: Main	Data Rate: 1 Mb/s

Frequency	Level	Pol	15.209 / 15.247		Detector	Azimuth	Height	Comments
MHz	dB μ V/m	v/h	Limit	Margin	Pk/QP/Avg	degrees	meters	
7206.030	46.1	V	54.0	-7.9	AVG	253	1.77	Note 1
4804.020	39.0	V	54.0	-15.0	AVG	314	1.34	
19214.880	48.3	H	54.0	-16.2	AVG	316	1.00	RB 1 MHz;VB 10 Hz;Peak
1325.000	35.8	V	54.0	-18.2	Peak	183	2.0	Same as run 1b. Not radio related.
7206.670	53.4	V	74.0	-20.6	PK	253	1.77	Note 1
19217.420	58.5	H	74.0	-26.0	PK	316	1.00	RB 1 MHz;VB 3 MHz;Peak
4804.100	45.5	V	74.0	-28.5	PK	314	1.34	

Client: Fitbit, Inc.	Job Number: J95447
Model: FB501 (Proton)	T-Log Number: T95507
Contact: Arndt Hufenbach	Project Manager: Deepa Shetty
Standard: FCC 15.247/RSS-210/LP 00002	Project Coordinator: Irene Rademacher
	Class: N/A

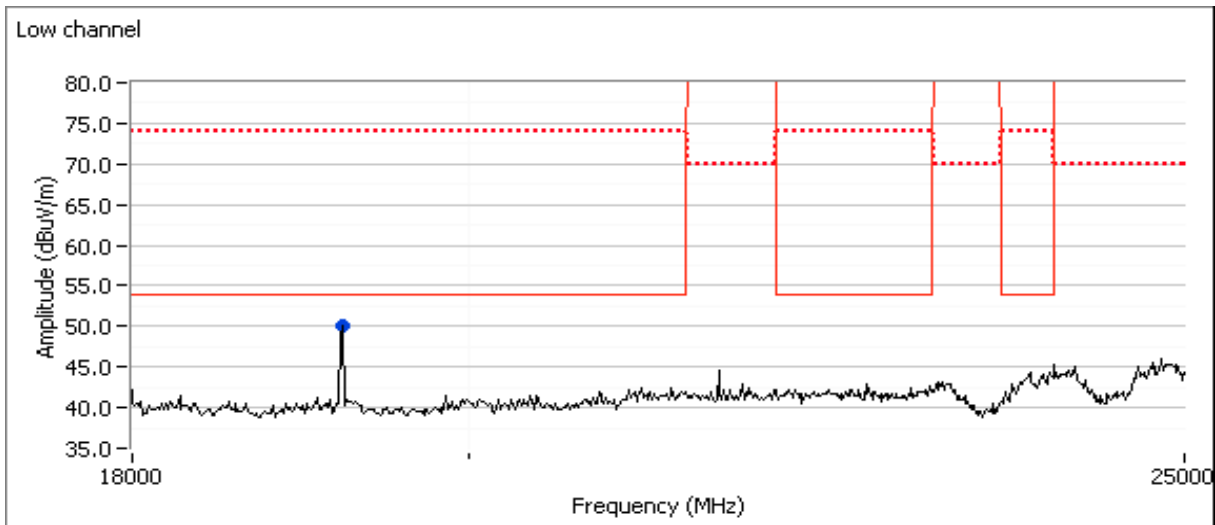
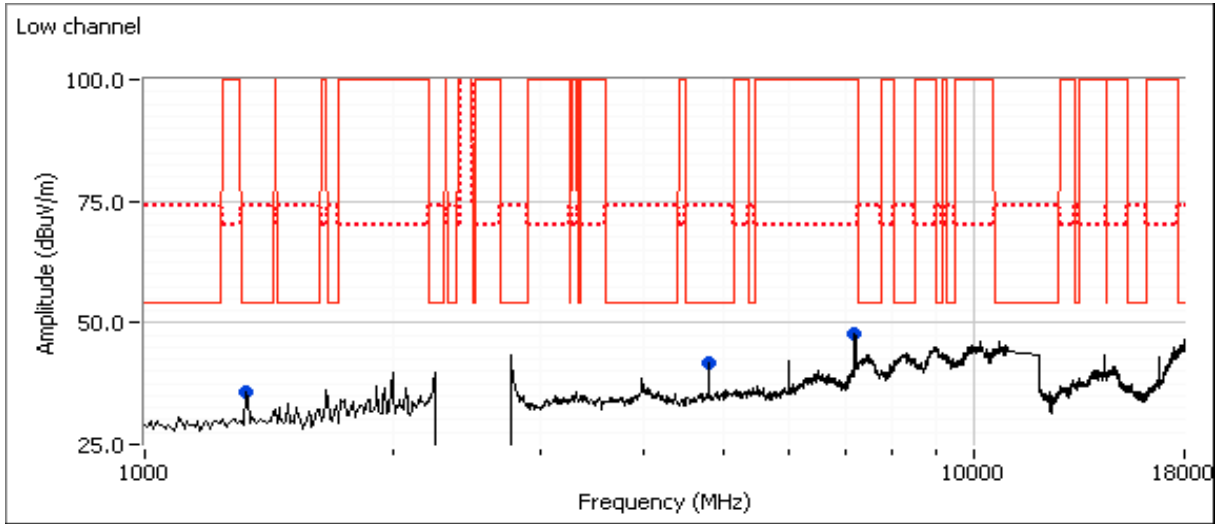



EMC Test Data

Client: Fitbit, Inc.	Job Number: J95447
Model: FB501 (Proton)	T-Log Number: T95507
	Project Manager: Deepa Shetty
Contact: Arndt Hufenbach	Project Coordinator: Irene Rademacher
Standard: FCC 15.247/RSS-210/LP 00002	Class: N/A

Run #1b: Center Channel

Channel: 2441 Mode: Basic
 Tx Chain: Main Data Rate: 1 Mb/s

EUT face down

Frequency MHz	Level dB μ V/m	Pol v/h	15.209 / 15.247		Detector Pk/QP/Avg	Azimuth degrees	Height meters	Comments
			Limit	Margin				
19526.950	48.2	V	54.0	-5.8	AVG	81	1.00	
7323.050	48.0	V	54.0	-6.0	AVG	50	1.62	
14646.950	47.6	V	54.0	-6.4	AVG	114	1.64	Note 1
24408.670	46.8	V	54.0	-7.2	AVG	89	1.37	Note 1
4882.030	41.3	H	54.0	-12.7	AVG	360	1.15	
12204.350	40.0	H	54.0	-14.0	AVG	54	1.00	
19529.500	58.8	V	74.0	-15.2	PK	81	1.00	
14646.900	58.4	V	74.0	-15.6	PK	114	1.64	Note 1
24406.680	58.2	V	74.0	-15.8	PK	89	1.37	Note 1
7323.350	54.9	V	74.0	-19.1	PK	50	1.62	
1333.330	34.8	V	54.0	-19.2	Peak	131	1.50	
12205.820	51.2	H	74.0	-22.8	PK	54	1.00	
4882.210	47.3	H	74.0	-26.7	PK	360	1.15	



EMC Test Data

Client: Fitbit, Inc.	Job Number: J95447
Model: FB501 (Proton)	T-Log Number: T95507
	Project Manager: Deepa Shetty
Contact: Arndt Hufenbach	Project Coordinator: Irene Rademacher
Standard: FCC 15.247/RSS-210/LP 00002	Class: N/A

EUT Upright

Frequency MHz	Level dB μ V/m	Pol v/h	15.209 / 15.247		Detector Pk/QP/Avg	Azimuth degrees	Height meters	Comments
			Limit	Margin				
14646.970	48.3	V	54.0	-5.7	AVG	134	1.55	Note 1
19526.980	47.9	V	54.0	-6.1	AVG	220	1.00	
14646.970	47.2	H	54.0	-6.8	AVG	54	1.34	Note 1
7323.100	47.2	V	54.0	-6.8	AVG	360	1.43	
7323.000	46.1	H	54.0	-7.9	AVG	144	1.41	
19529.350	45.8	H	54.0	-8.2	AVG	51	1.28	
24408.570	45.1	V	54.0	-8.9	AVG	0	1.29	Note 1
24405.470	44.5	H	54.0	-9.5	AVG	360	1.00	Note 1
12205.720	40.9	V	54.0	-13.1	AVG	179	1.57	
12204.420	40.3	H	54.0	-13.7	AVG	214	1.52	
14645.030	59.1	V	74.0	-14.9	PK	134	1.55	Note 1
14646.870	58.3	H	74.0	-15.7	PK	54	1.34	Note 1
19529.500	58.1	V	74.0	-15.9	PK	220	1.00	
24409.200	56.8	V	74.0	-17.2	PK	0	1.29	Note 1
4882.050	36.7	H	54.0	-17.3	AVG	356	1.13	
19526.880	56.5	H	74.0	-17.5	PK	51	1.28	
24406.300	56.2	H	74.0	-17.8	PK	360	1.00	Note 1
4882.030	36.1	V	54.0	-17.9	AVG	32	1.49	
7323.600	54.2	V	74.0	-19.8	PK	360	1.43	
7323.150	53.4	H	74.0	-20.6	PK	144	1.41	
12204.480	51.8	V	74.0	-22.2	PK	179	1.57	
12204.320	50.9	H	74.0	-23.1	PK	214	1.52	
4881.870	44.6	H	74.0	-29.4	PK	356	1.13	
4882.130	44.2	V	74.0	-29.8	PK	32	1.49	



EMC Test Data

Client: Fitbit, Inc.	Job Number: J95447
Model: FB501 (Proton)	T-Log Number: T95507
	Project Manager: Deepa Shetty
Contact: Arndt Hufenbach	Project Coordinator: Irene Rademacher
Standard: FCC 15.247/RSS-210/LP 00002	Class: N/A

EUT Side

Frequency MHz	Level dB μ V/m	Pol v/h	15.209 / 15.247		Detector Pk/QP/Avg	Azimuth degrees	Height meters	Comments
			Limit	Margin				
19526.950	51.8	H	54.0	-2.2	AVG	179	1.13	
14646.950	49.5	H	54.0	-4.5	AVG	40	1.46	Note 1
7323.070	48.7	V	54.0	-5.3	AVG	241	1.44	
14646.950	47.8	V	54.0	-6.2	AVG	128	1.51	Note 1
19529.310	46.5	V	54.0	-7.5	AVG	149	1.00	
24408.500	46.1	H	54.0	-7.9	AVG	81	1.12	Note 1
24408.480	45.6	V	54.0	-8.4	AVG	123	1.25	Note 1
7323.020	44.8	H	54.0	-9.2	AVG	190	1.44	
12204.470	42.1	V	54.0	-11.9	AVG	121	1.58	
12204.380	41.8	H	54.0	-12.2	AVG	12	1.58	
19529.500	61.0	H	74.0	-13.0	PK	179	1.13	
14646.970	60.1	H	74.0	-13.9	PK	40	1.46	Note 1
4882.020	39.0	V	54.0	-15.0	AVG	284	1.44	
14647.130	58.9	V	74.0	-15.1	PK	128	1.51	Note 1
24414.620	57.4	H	74.0	-16.6	PK	81	1.12	Note 1
19526.710	57.1	V	74.0	-16.9	PK	149	1.00	
24407.220	57.1	V	74.0	-16.9	PK	123	1.25	Note 1
4881.950	35.6	H	54.0	-18.4	AVG	14	1.11	
7323.470	55.3	V	74.0	-18.7	PK	241	1.44	
7323.520	52.9	H	74.0	-21.1	PK	190	1.44	
12206.020	51.9	H	74.0	-22.1	PK	12	1.58	
12205.720	51.7	V	74.0	-22.3	PK	121	1.58	
4881.750	45.6	V	74.0	-28.4	PK	284	1.44	
4881.930	43.5	H	74.0	-30.5	PK	14	1.11	

Client: Fitbit, Inc.	Job Number: J95447
Model: FB501 (Proton)	T-Log Number: T95507
Contact: Arndt Hufenbach	Project Manager: Deepa Shetty
Standard: FCC 15.247/RSS-210/LP 00002	Project Coordinator: Irene Rademacher
	Class: N/A

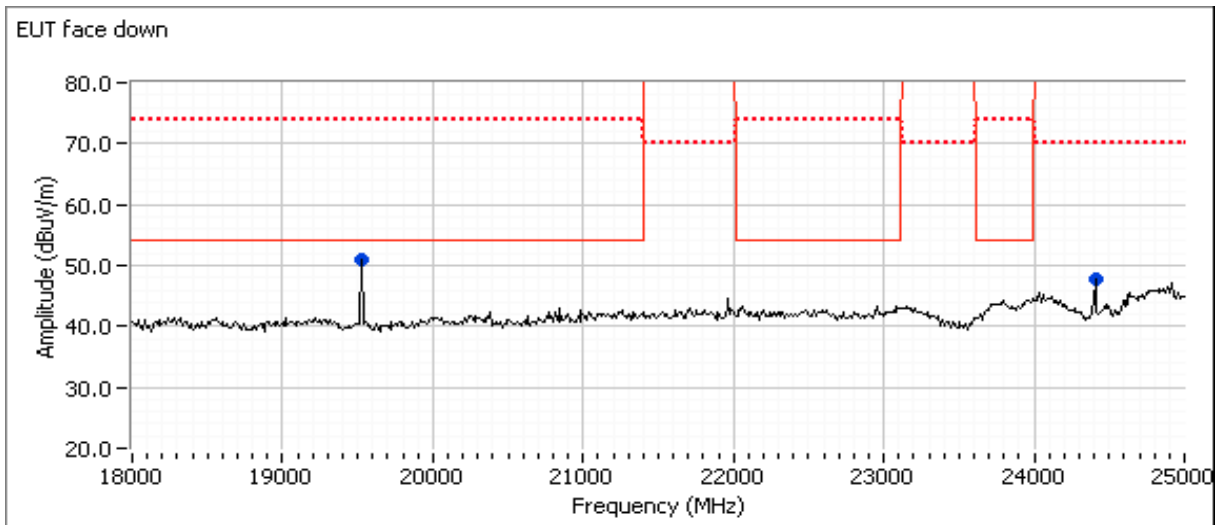
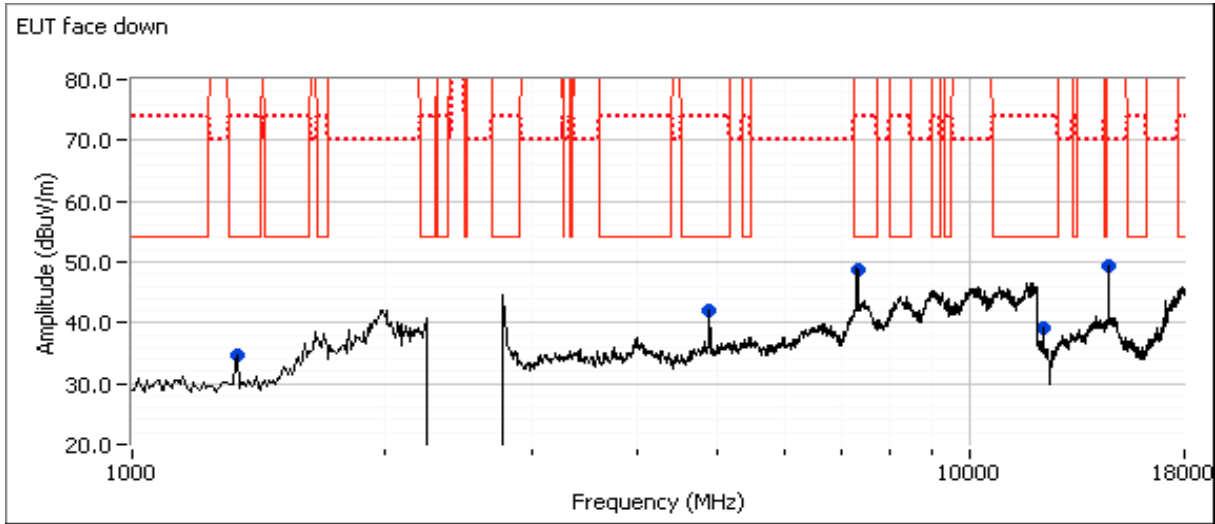



EMC Test Data

Client: Fitbit, Inc.	Job Number: J95447
Model: FB501 (Proton)	T-Log Number: T95507
	Project Manager: Deepa Shetty
Contact: Arndt Hufenbach	Project Coordinator: Irene Rademacher
Standard: FCC 15.247/RSS-210/LP 00002	Class: N/A

Run #1c: High Channel

Channel: 2480 Mode: Basic
 Tx Chain: Main Data Rate: 1 Mb/s

Frequency MHz	Level dB μ V/m	Pol v/h	15.209 / 15.247		Detector Pk/QP/Avg	Azimuth degrees	Height meters	Comments
			Limit	Margin				
7440.150	49.6	V	54.0	-4.4	AVG	244	1.61	
14880.780	44.4	H	54.0	-9.6	AVG	245	1.00	Note 1
4959.960	38.3	V	54.0	-15.7	AVG	253	1.00	
1325.000	36.1	V	54.0	-17.9	Peak	61	1.5	Same as run 1b. Not radio related.
7440.600	55.9	V	74.0	-18.1	PK	244	1.61	
19841.350	45.0	V	54.0	-19.5	AVG	234	1.00	RB 1 MHz;VB 10 Hz;Peak
14881.020	54.1	H	74.0	-19.9	PK	245	1.00	Note 1
19835.700	55.5	V	74.0	-29.0	PK	234	1.00	RB 1 MHz;VB 3 MHz;Peak
4960.310	44.3	V	74.0	-29.7	PK	253	1.00	

Client: Fitbit, Inc.	Job Number: J95447
Model: FB501 (Proton)	T-Log Number: T95507
Contact: Arndt Hufenbach	Project Manager: Deepa Shetty
Standard: FCC 15.247/RSS-210/LP 00002	Project Coordinator: Irene Rademacher
	Class: N/A

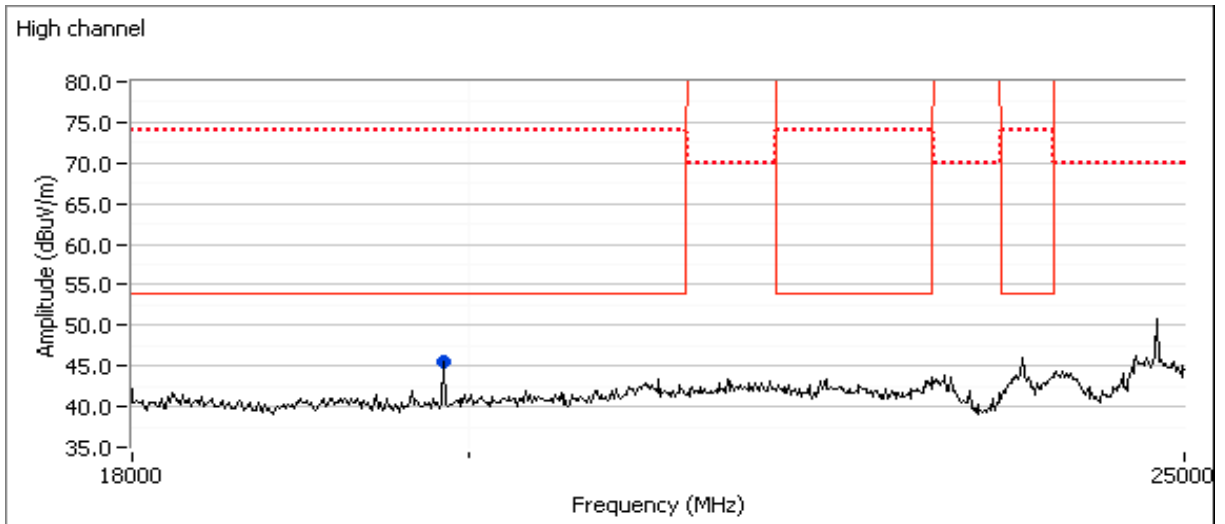
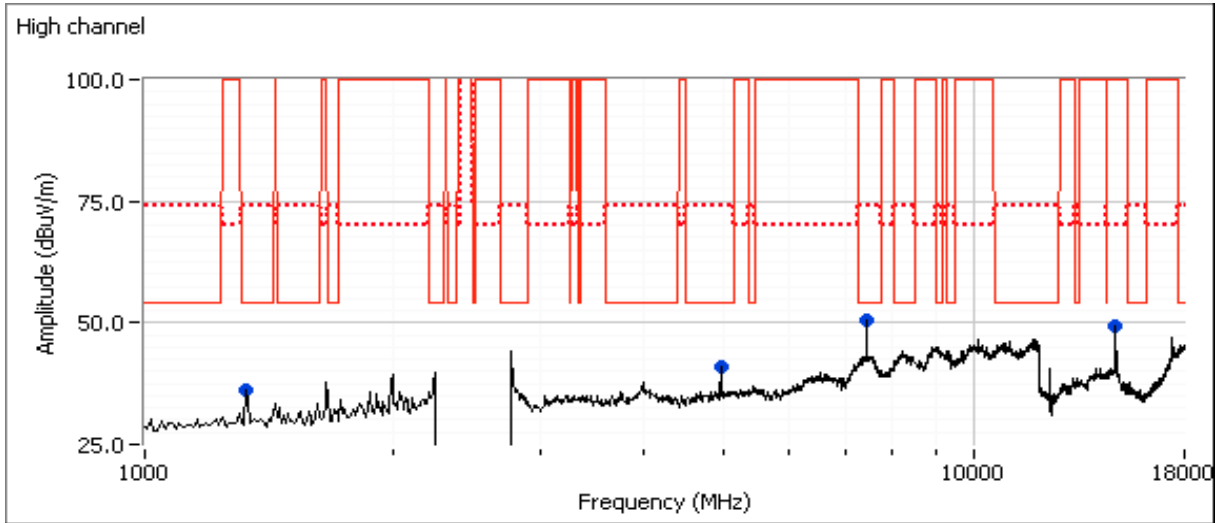



EMC Test Data

Client: Fitbit, Inc.	Job Number: J95447
Model: FB501 (Proton)	T-Log Number: T95507
	Project Manager: Deepa Shetty
Contact: Arndt Hufenbach	Project Coordinator: Irene Rademacher
Standard: FCC 15.247/RSS-210/LP 00002	Class: N/A

Run #2: Radiated Spurious Emissions, 1,000 - 25000 MHz. Operating Mode: EDR - 8PSK

Date of Test: 07/11/14	Config. Used: 1
Test Engineer: J. Caizzi, M. Birgani	Config Change: none
Test Location: Chamber 7	EUT Voltage:

Run #2a: Low Channel

Channel: 2402	Mode: 8PSK
Tx Chain: Main	Data Rate: 3 Mb/s

Frequency MHz	Level dB μ V/m	Pol v/h	15.209 / 15.247		Detector Pk/QP/Avg	Azimuth degrees	Height meters	Comments
			Limit	Margin				
7206.100	45.2	H	54.0	-8.8	AVG	142	1.13	Note 1
14410.000	41.4	H	54.0	-12.6	AVG	349	1.00	Note1
4803.980	39.6	V	54.0	-14.4	AVG	264	1.04	
19216.110	48.6	H	54.0	-15.9	AVG	316	1.0	RB 1 MHz;VB 10 Hz;Peak
1325.000	36.9	V	54.0	-17.1	Peak	180	2.0	Same as run 1b. Not radio related.
7206.030	53.4	H	74.0	-20.6	PK	142	1.13	Note 1
19216.120	59.2	H	74.0	-25.3	PK	316	1.0	RB 1 MHz;VB 3 MHz;Peak
4803.680	47.7	V	74.0	-26.3	PK	264	1.04	
14410.000	47.4	H	74.0	-26.6	PK	349	1.00	Note 1

Client: Fitbit, Inc.	Job Number: J95447
Model: FB501 (Proton)	T-Log Number: T95507
Contact: Arndt Hufenbach	Project Manager: Deepa Shetty
Standard: FCC 15.247/RSS-210/LP 00002	Project Coordinator: Irene Rademacher
	Class: N/A

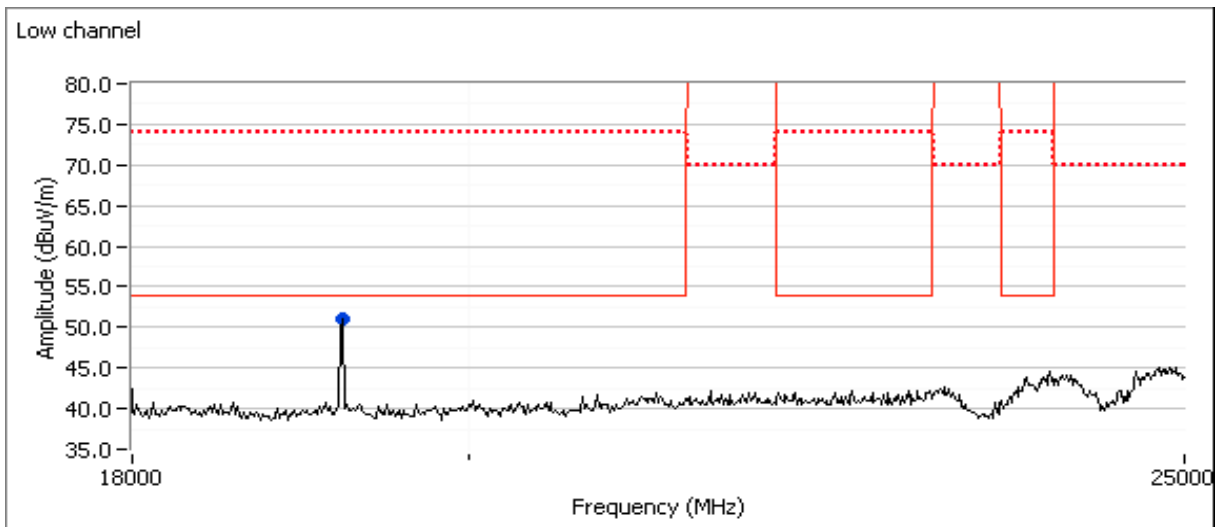
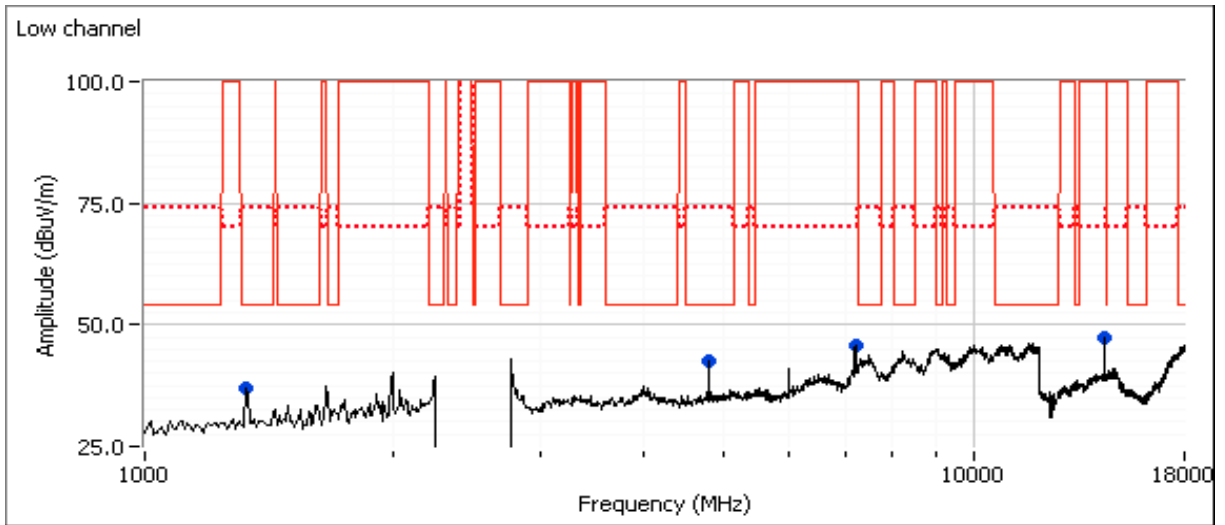



EMC Test Data

Client: Fitbit, Inc.	Job Number: J95447
Model: FB501 (Proton)	T-Log Number: T95507
	Project Manager: Deepa Shetty
Contact: Arndt Hufenbach	Project Coordinator: Irene Rademacher
Standard: FCC 15.247/RSS-210/LP 00002	Class: N/A

Run #2b: Center Channel

Channel: 2441 Mode: 8PSK
 Tx Chain: Main Data Rate: 3 Mb/s

Frequency MHz	Level dB μ V/m	Pol v/h	15.209 / 15.247		Detector Pk/QP/Avg	Azimuth degrees	Height meters	Comments
			Limit	Margin				
19527.970	46.0	V	54.0	-8.0	AVG	300	1.00	RB 1 MHz;VB 10 Hz;Peak
7323.020	44.6	V	54.0	-9.4	AVG	300	1.40	
4881.980	42.1	V	54.0	-11.9	AVG	265	1.17	
14640.830	39.2	H	54.0	-14.8	AVG	350	1.00	Note 1
19527.740	58.1	V	74.0	-15.9	PK	300	1.00	RB 1 MHz;VB 3 MHz;Peak
1325.000	36.8	V	54.0	-17.2	Peak	120	1.5	Same as run 1b. Not radio related.
7323.630	54.0	V	74.0	-20.0	PK	300	1.40	
14641.320	50.2	H	74.0	-23.8	PK	350	1.00	Note 1
4881.780	49.2	V	74.0	-24.8	PK	265	1.17	

Client: Fitbit, Inc.	Job Number: J95447
Model: FB501 (Proton)	T-Log Number: T95507
Contact: Arndt Hufenbach	Project Manager: Deepa Shetty
Standard: FCC 15.247/RSS-210/LP 00002	Project Coordinator: Irene Rademacher
	Class: N/A

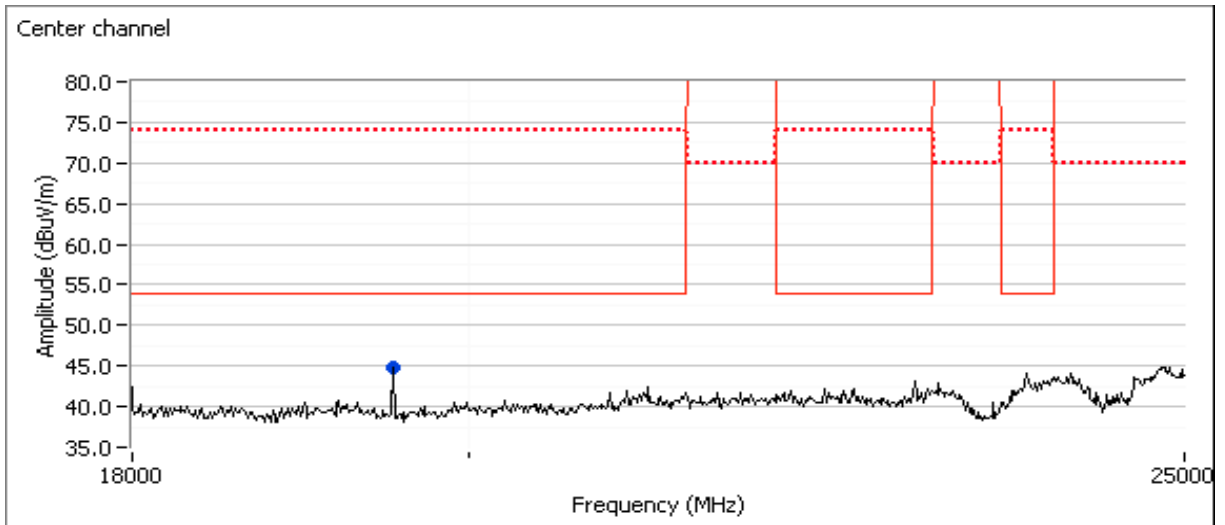
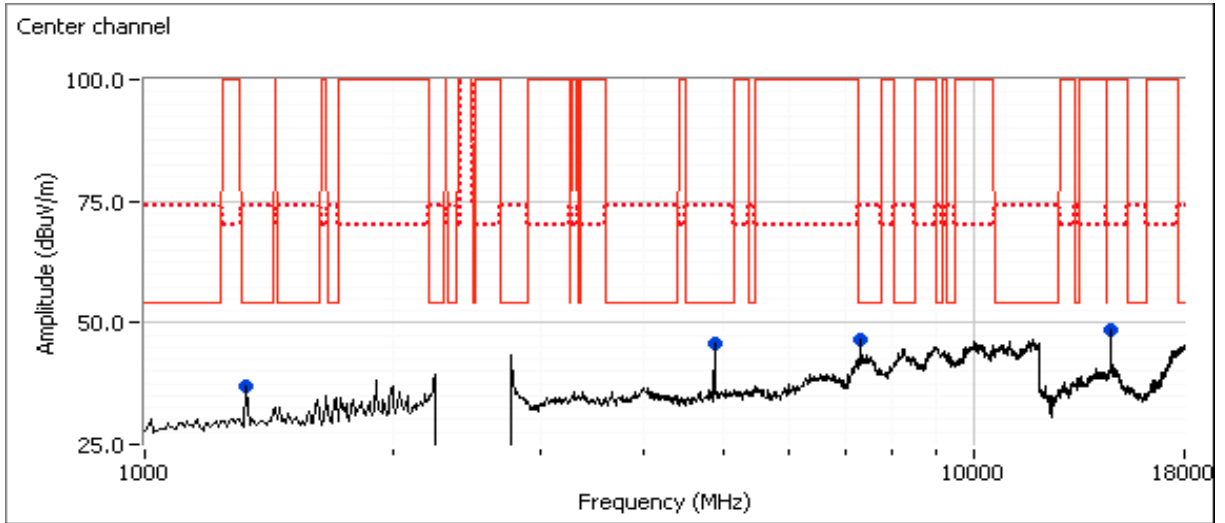



EMC Test Data

Client: Fitbit, Inc.	Job Number: J95447
Model: FB501 (Proton)	T-Log Number: T95507
	Project Manager: Deepa Shetty
Contact: Arndt Hufenbach	Project Coordinator: Irene Rademacher
Standard: FCC 15.247/RSS-210/LP 00002	Class: N/A

Run #2c: High Channel

Channel: 2480 Mode: 8PSK
 Tx Chain: Main Data Rate: 3 Mb/s

Frequency MHz	Level dB μ V/m	Pol v/h	15.209 / 15.247		Detector Pk/QP/Avg	Azimuth degrees	Height meters	Comments
			Limit	Margin				
7439.850	47.7	V	54.0	-6.3	AVG	242	1.7	RB 1 MHz;VB 10 Hz;Peak
19840.030	45.2	H	54.0	-8.8	AVG	234	1.0	RB 1 MHz;VB 10 Hz;Peak
4960.030	44.6	V	54.0	-9.4	AVG	262	1.0	RB 1 MHz;VB 10 Hz;Peak
14880.000	42.6	H	54.0	-11.4	AVG	346	1.0	Note 1
1333.330	37.3	V	54.0	-16.7	Peak	138	1.5	
7439.920	56.8	V	74.0	-17.2	PK	242	1.7	RB 1 MHz;VB 3 MHz;Peak
19840.250	56.5	H	74.0	-17.5	PK	234	1.0	RB 1 MHz;VB 3 MHz;Peak
4959.970	50.6	V	74.0	-23.4	PK	262	1.0	RB 1 MHz;VB 3 MHz;Peak
14880.000	49.6	H	74.0	-24.4	PK	346	1.0	Note 1

Client: Fitbit, Inc.	Job Number: J95447
Model: FB501 (Proton)	T-Log Number: T95507
Contact: Arndt Hufenbach	Project Manager: Deepa Shetty
Standard: FCC 15.247/RSS-210/LP 00002	Project Coordinator: Irene Rademacher
	Class: N/A

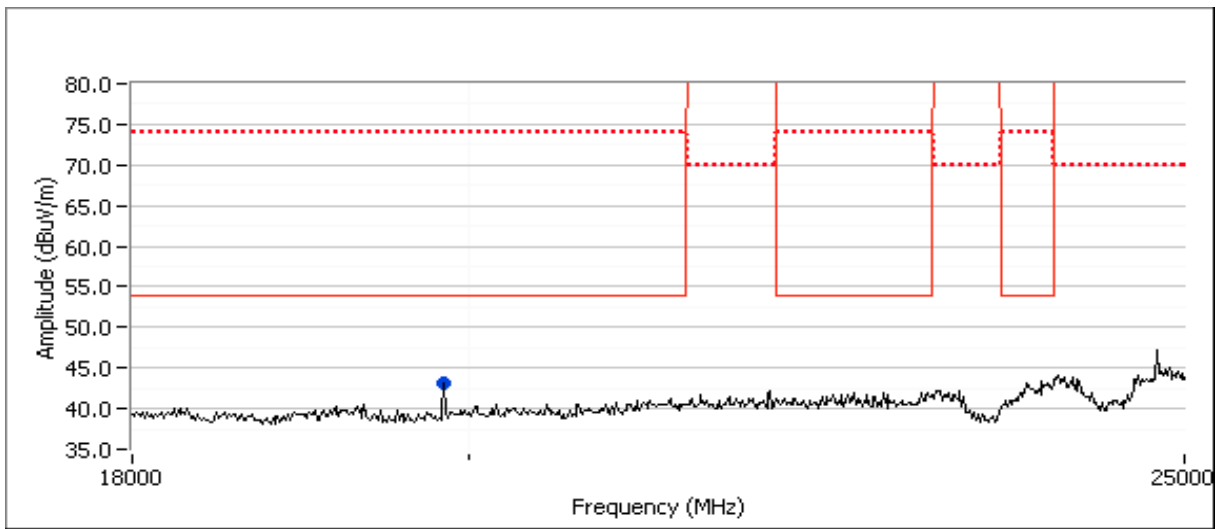
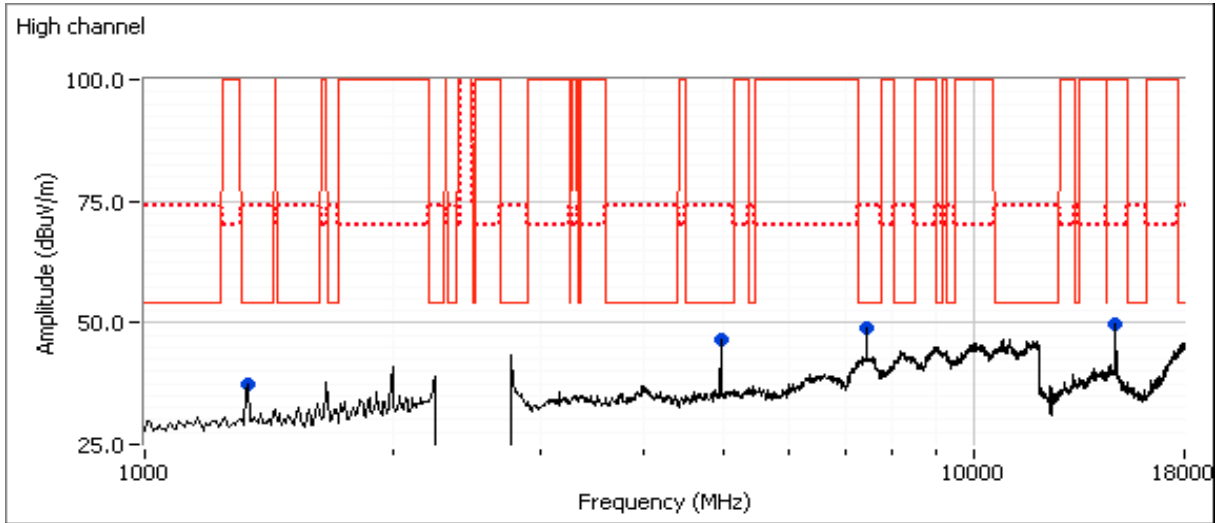



EMC Test Data

Client: Fitbit, Inc.	Job Number: J95447
Model: FB501 (Proton)	T-Log Number: T95507
	Project Manager: Deepa Shetty
Contact: Arndt Hufenbach	Project Coordinator: Irene Rademacher
Standard: FCC 15.247/RSS-210/LP 00002	Class: N/A

FCC 15.247 FHSS - Power, Bandwidth and Spurious Emissions

Test Specific Details

Objective: The objective of this test session is to perform final qualification testing of the EUT with respect to the specification listed above.

Date of Test: 7/18/14 & 7/21/14
 Test Engineer: M. Birgani & J. Caizzi
 Test Location: Lab 4A

Config. Used: 1
 Config Change: none
 EUT Voltage: Battery

General Test Configuration

The antenna port of the EUT was connected to the spectrum analyzer or power meter via a suitable attenuator to prevent overloading the measurement system. All measurements are corrected to allow for the external attenuators used.

Unless stated otherwise the EUT was operating such that it constantly hopped on either the low, center or high channels.

Ambient Conditions: Temperature: 18-23 °C
 Rel. Humidity: 30-35 %

Summary of Results

Run #	Test Performed	Limit	Pass / Fail	Result / Margin
3	30 - 25000 MHz - Transmitter Conducted Spurious Emissions	FCC Part 15.247(c)	Pass	All signal were below -20dBc
4	Output Power	15.247(b)	Pass	Basic: 4.2 dBm (0.0026W) EDR: 6.6 dBm (0.0046 W)
5	20dB Bandwidth	15.247(a)	Pass	Basic: 885kHz EDR: 1350 kHz
5	99% bandwidth	15.247(a)	-	Basic: 866kHz EDR: 1228 kHz
5	Channel Occupancy	15.247(a)	Pass	259.2 ms
5	Number of Channels	15.247(a)	Pass	79

Modifications Made During Testing:

No modifications were made to the EUT during testing

Deviations From The Standard

No deviations were made from the requirements of the standard.

Client: Fitbit, Inc.	Job Number: J95447
Model: FB501 (Proton)	T-Log Number: T95507
Contact: Arndt Hufenbach	Project Manager: Deepa Shetty
Standard: FCC 15.247/RSS-210/LP 00002	Project Coordinator: Irene Rademacher
	Class: N/A

Run #3a: Antenna Conducted Spurious Emissions, 30 - 25000 MHz., BT Basic
 Refer to plots below. Scans made using RBW=VB=100 KHz with the limit line set at 20dB below the highest in-band signal level with the hopping feature disabled.

Low channel

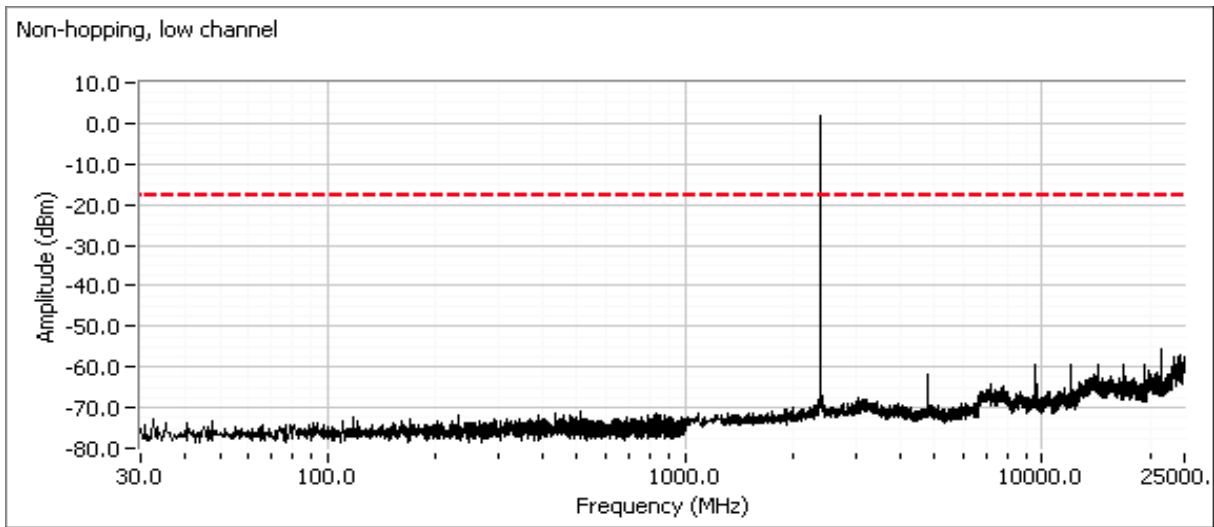

Plot showing -20dBc at the lower band edge

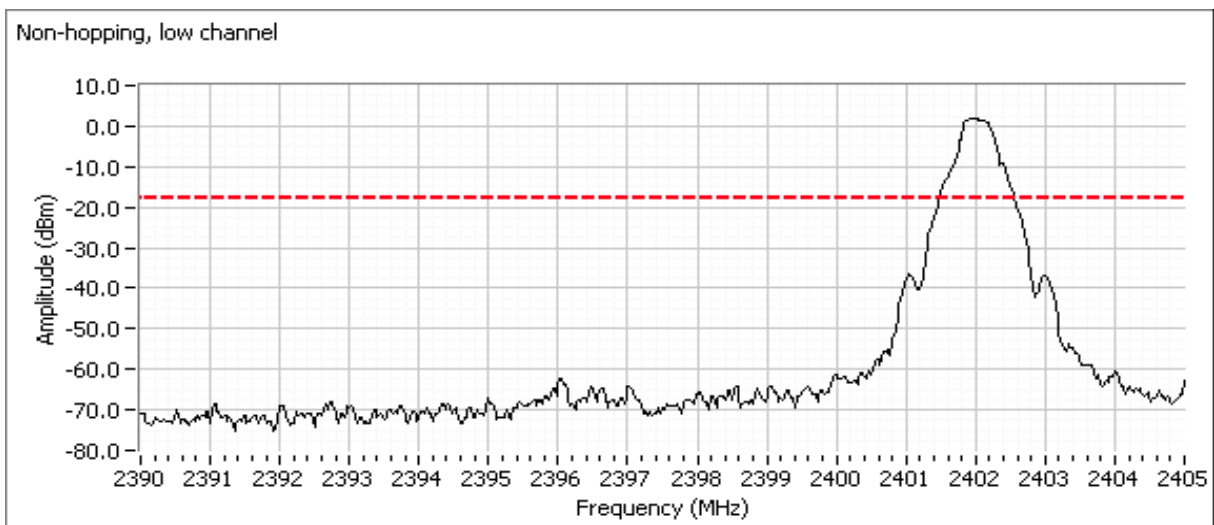

Client: Fitbit, Inc.	Job Number: J95447
Model: FB501 (Proton)	T-Log Number: T95507
Contact: Arndt Hufenbach	Project Manager: Deepa Shetty
Standard: FCC 15.247/RSS-210/LP 00002	Project Coordinator: Irene Rademacher
	Class: N/A

Center channel

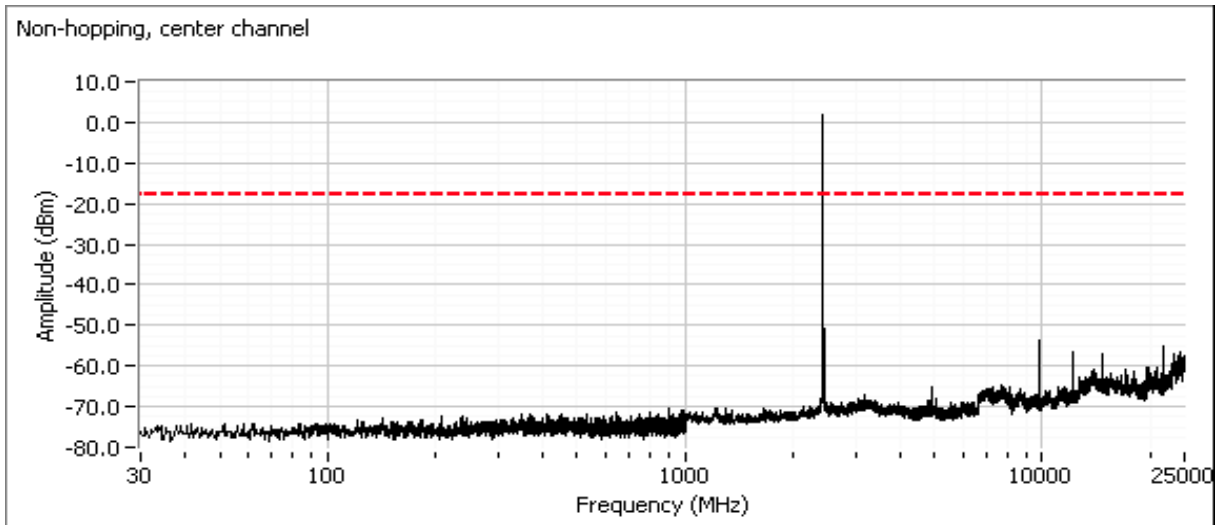

High channel

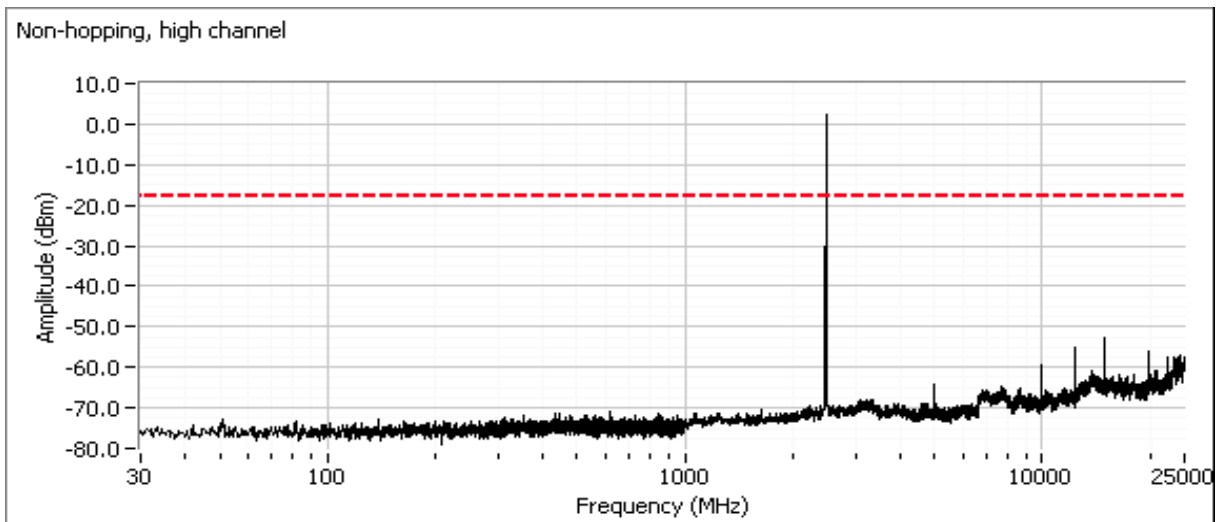

Client: Fitbit, Inc.	Job Number: J95447
Model: FB501 (Proton)	T-Log Number: T95507
	Project Manager: Deepa Shetty
Contact: Arndt Hufenbach	Project Coordinator: Irene Rademacher
Standard: FCC 15.247/RSS-210/LP 00002	Class: N/A

Plot showing -20dBc at the upper band edge

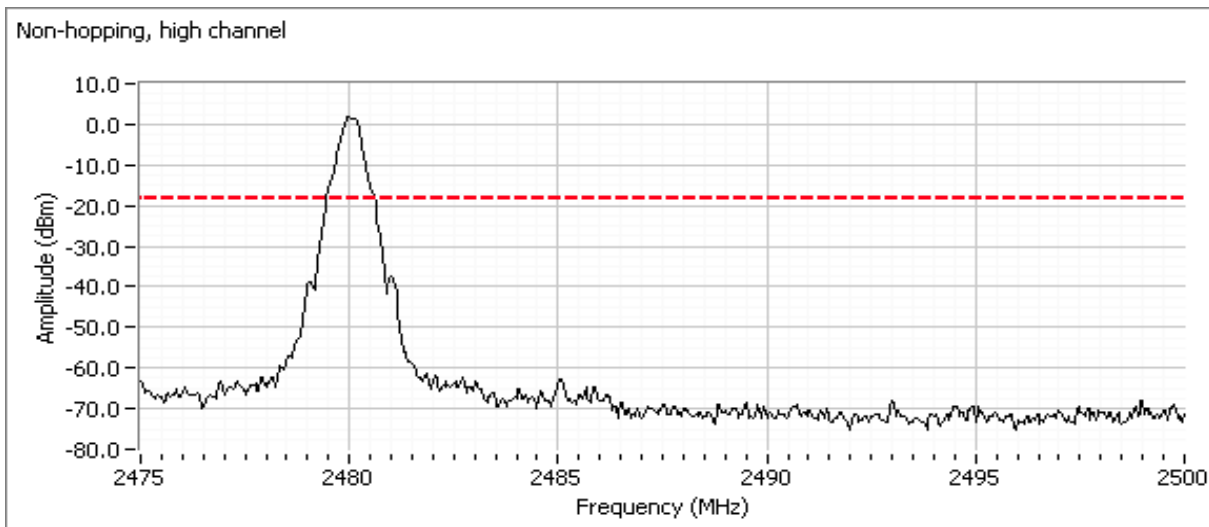

Refer to plots below. Scans made using RBW=VB=100 KHz with the limit line set at 20dB below the highest in-band signal level with the hopping feature enabled to show compliance with the -20dBc requirement at the allocated band edge. The spectrum analyzer is left in max hold mode until the trace stabilizes.

Client: Fitbit, Inc.	Job Number: J95447
Model: FB501 (Proton)	T-Log Number: T95507
Contact: Arndt Hufenbach	Project Manager: Deepa Shetty
Standard: FCC 15.247/RSS-210/LP 00002	Project Coordinator: Irene Rademacher
	Class: N/A

Low channel, hopping enabled
 Plot showing -20dBc at the lower band edge

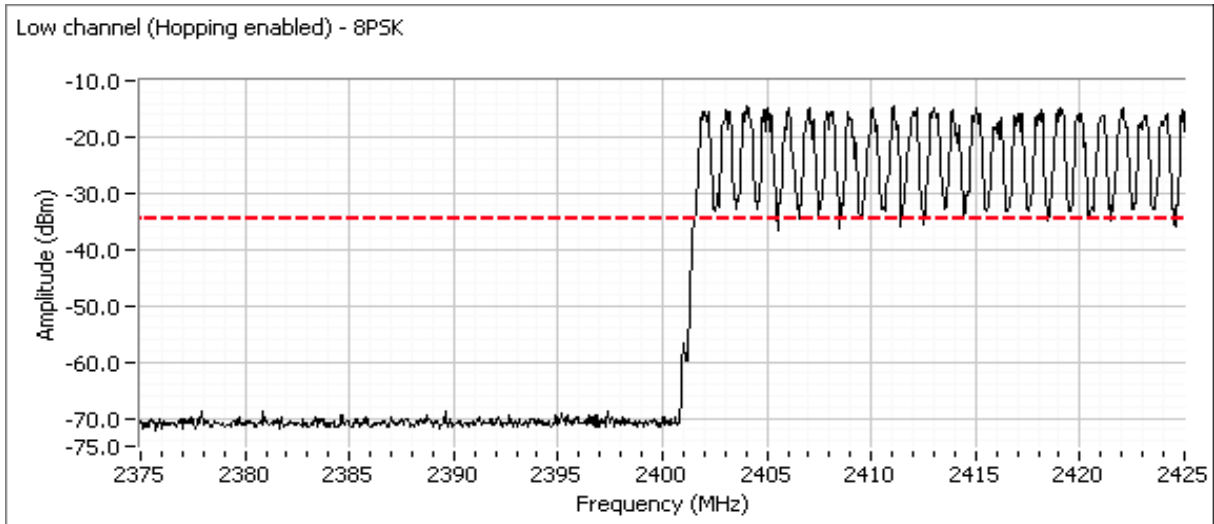

High channel, hopping enabled
 Plot showing -20dBc at the upper band edge

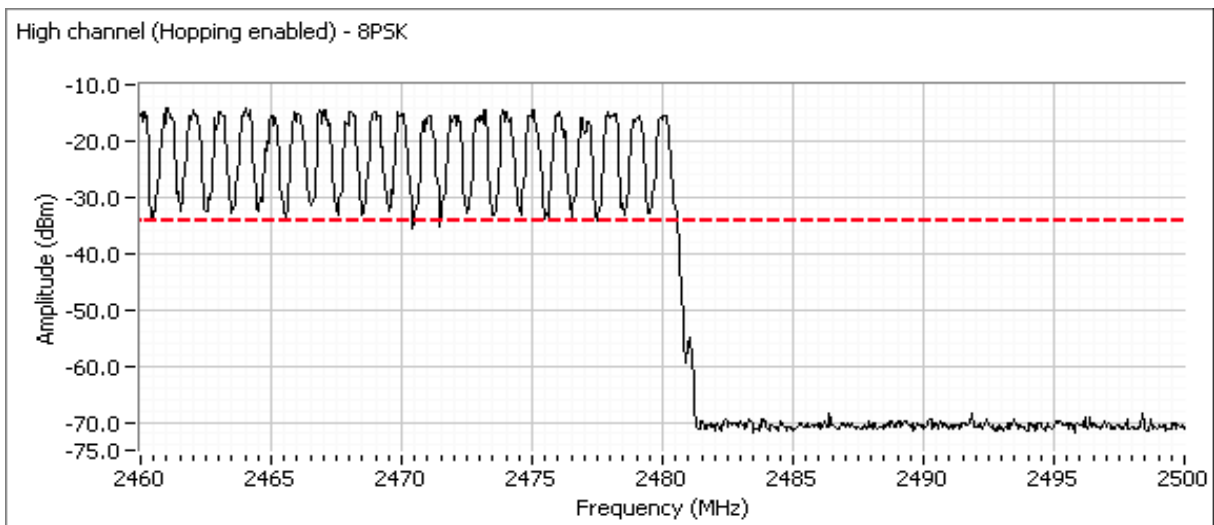

Client: Fitbit, Inc.	Job Number: J95447
Model: FB501 (Proton)	T-Log Number: T95507
Contact: Arndt Hufenbach	Project Manager: Deepa Shetty
Standard: FCC 15.247/RSS-210/LP 00002	Project Coordinator: Irene Rademacher
	Class: N/A

Run #3b: Antenna Conducted Spurious Emissions, 30 - 25000 MHz., BT EDR

Refer to plots below. Scans made using RBW=VB=100 KHz with the limit line set at 20dB below the highest in-band signal level with the hopping feature disabled.

Low channel

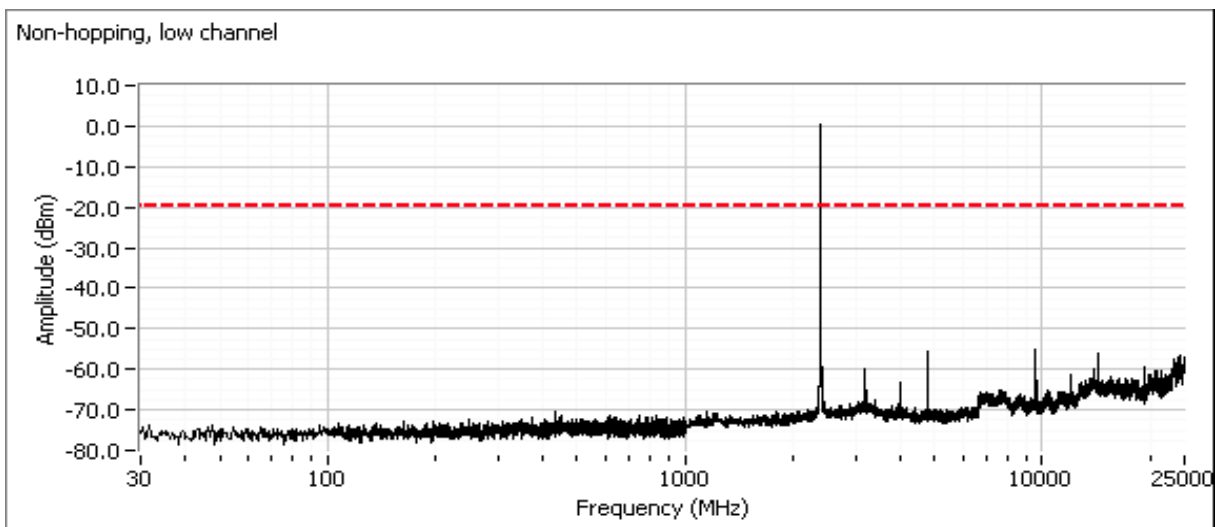

Plot showing -20dBc at the lower band edge

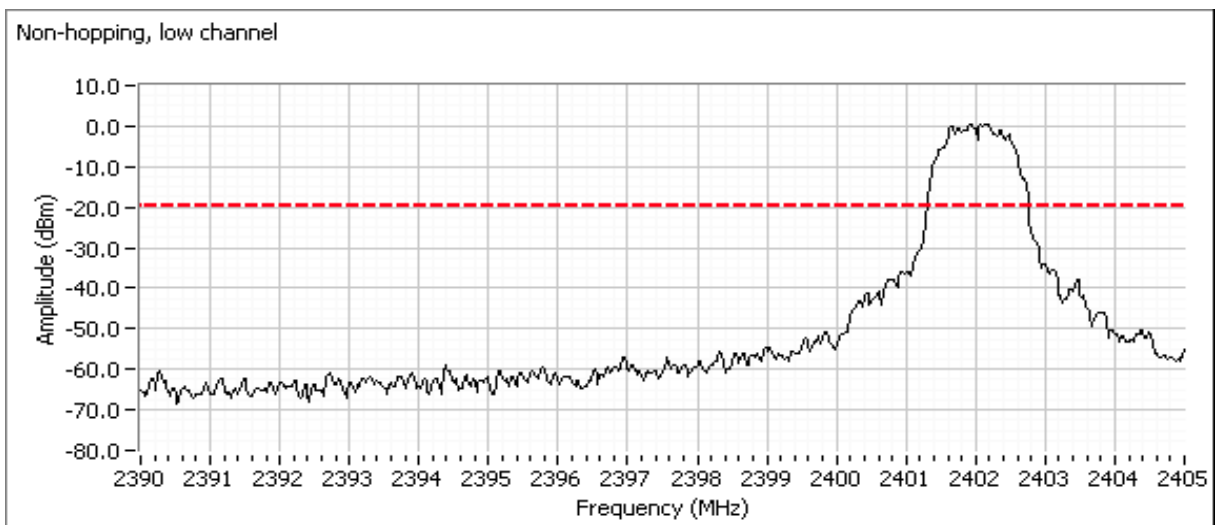

Client: Fitbit, Inc.	Job Number: J95447
Model: FB501 (Proton)	T-Log Number: T95507
Contact: Arndt Hufenbach	Project Manager: Deepa Shetty
Standard: FCC 15.247/RSS-210/LP 00002	Project Coordinator: Irene Rademacher
	Class: N/A

Center channel

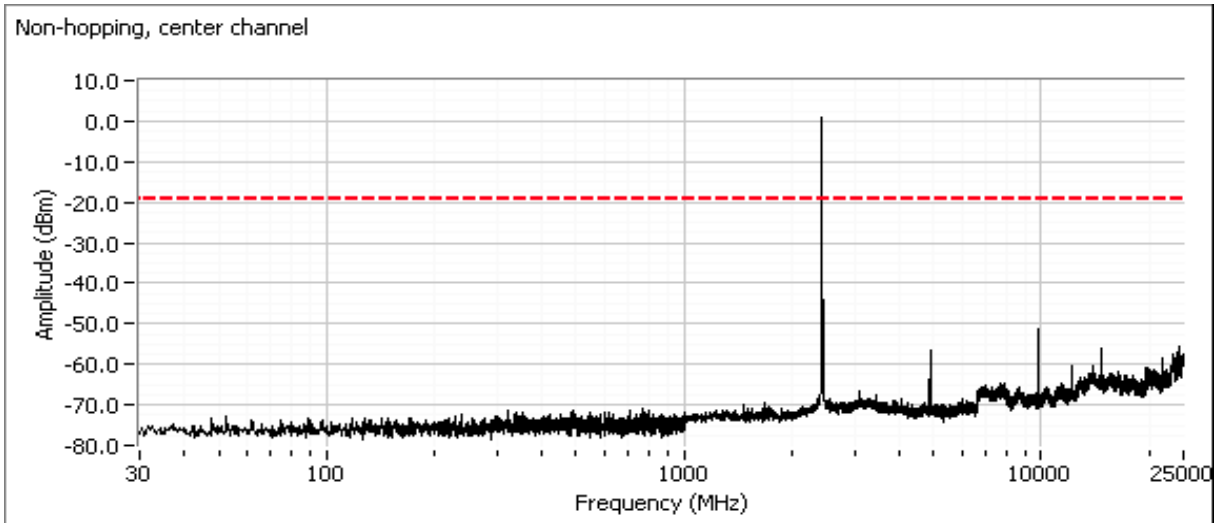

High channel

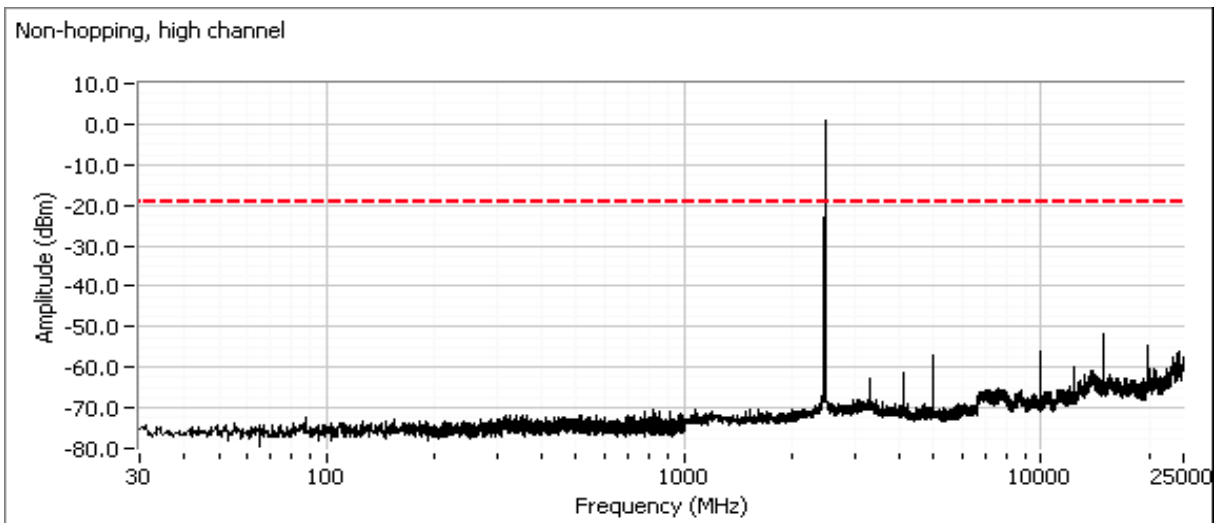

Client: Fitbit, Inc.	Job Number: J95447
Model: FB501 (Proton)	T-Log Number: T95507
	Project Manager: Deepa Shetty
Contact: Arndt Hufenbach	Project Coordinator: Irene Rademacher
Standard: FCC 15.247/RSS-210/LP 00002	Class: N/A

Plot showing -20dBc at the upper band edge

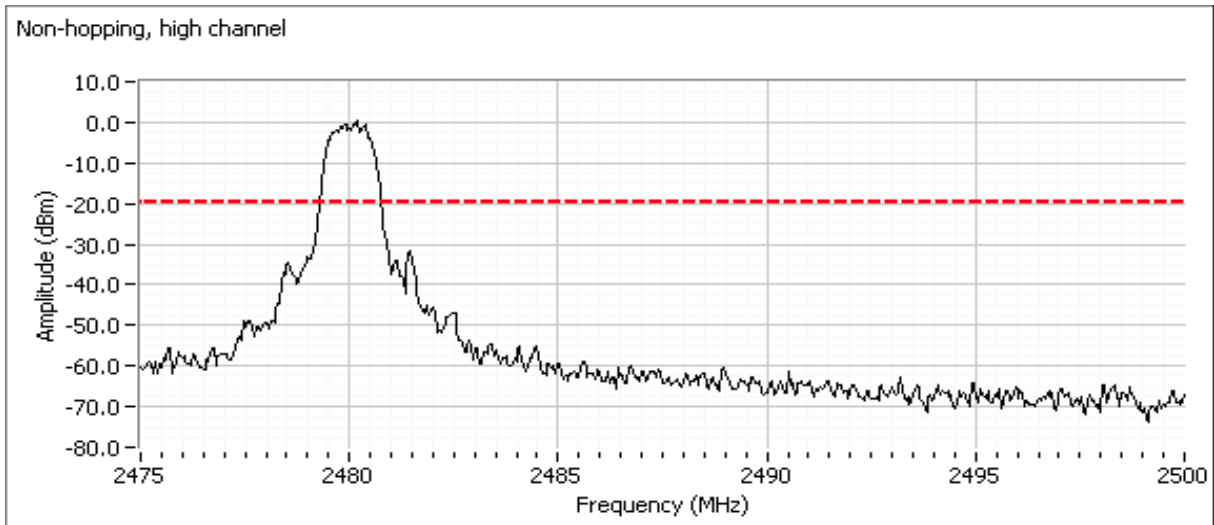

Client: Fitbit, Inc.	Job Number: J95447
Model: FB501 (Proton)	T-Log Number: T95507
	Project Manager: Deepa Shetty
Contact: Arndt Hufenbach	Project Coordinator: Irene Rademacher
Standard: FCC 15.247/RSS-210/LP 00002	Class: N/A

Run #4: Output Power

For frequency hopping systems operating in the 2400-2483.5 MHz band employing at least 75 non-overlapping hopping channels: 1 watt.

Maximum antenna gain: -2.22 dBi

Channel	Frequency (MHz)	Output Power (dBm) ^{Note 1}	Output Power (W)	EIRP (W)
Low	GFSK - 2402	4.2	0.0026	0.0016
Mid	GFSK - 2441	3.9	0.0025	0.0015
High	GFSK - 2480	4.0	0.0025	0.0015
Low	8PSK - 2402	6.5	0.0045	0.0027
Mid	8PSK - 2441	6.5	0.0045	0.0027
High	8PSK - 2480	6.6	0.0046	0.0027

Note 1: Peak power meter was used for measurement.

Run #5: Bandwidth, Channel Occupancy, Spacing and Number of Channels

Channel	Frequency (MHz)	Resolution Bandwidth	20dB Bandwidth (kHz)	Resolution Bandwidth	99% Bandwidth (kHz)
Low	GFSK - 2402	15kHz	883	30kHz	860
Mid	GFSK - 2441	15kHz	885	30kHz	866
High	GFSK - 2480	15kHz	883	30kHz	863
Low	8PSK - 2402	15kHz	1350	30kHz	1228
Mid	8PSK - 2441	15kHz	1348	30kHz	1226
High	8PSK - 2480	15kHz	1348	30kHz	1197

Note 1: 20dB bandwidth measured using RB = 15kHz, VB = 51kHz (VB > RB)

Note 2: 99% bandwidth measured using RB = 30kHz, VB = 100kHz (VB >= 3RB)

Client: Fitbit, Inc.	Job Number: J95447
Model: FB501 (Proton)	T-Log Number: T95507
Contact: Arndt Hufenbach	Project Manager: Deepa Shetty
Standard: FCC 15.247/RSS-210/LP 00002	Project Coordinator: Irene Rademacher
	Class: N/A

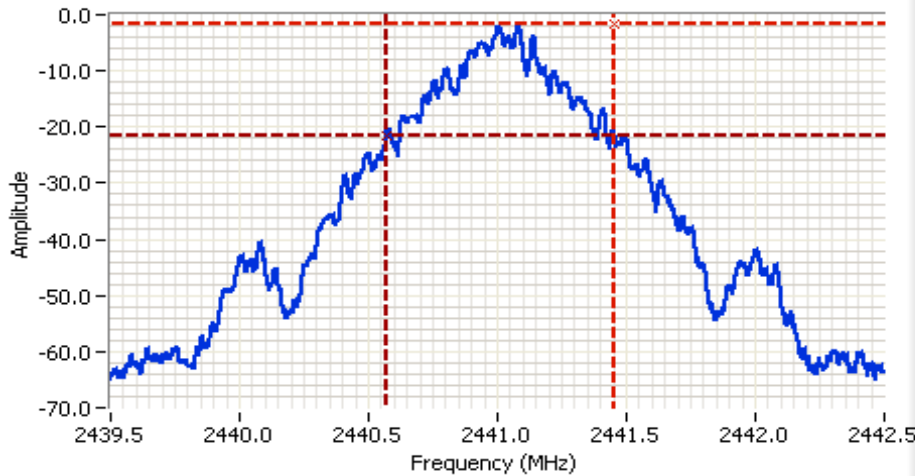

Analyzer Settings

Agilent Technologies, E4446A
 CF: 2441.000 MHz
 SPAN: 3.000 MHz
 RB: 15.0 kHz
 VB: 51.0 kHz
 Detector: POS
 Attn: 10 DB
 RL Offset: 10.5 DB
 Sweep Time: 12.7ms
 Ref Lvl: 10.5 DBM

Comments

GFSK
 20dB BW: 885 kHz

Cursor 1 2441.4558 -1.52 

Cursor 2 2440.5706 -21.52 

Delta Freq. 885 kHz

Delta Amplitude 20.00

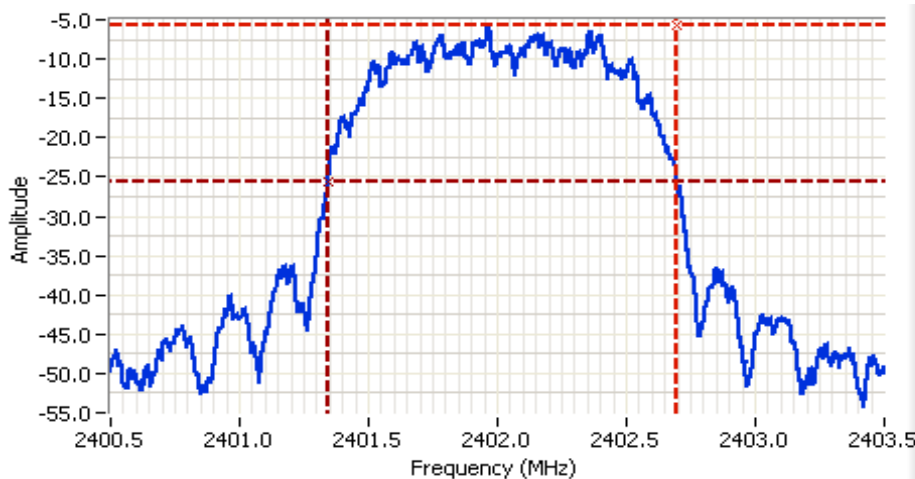

Analyzer Settings

Agilent Technologies, E4446A
 CF: 2402.000 MHz
 SPAN: 3.000 MHz
 RB: 15.0 kHz
 VB: 51.0 kHz
 Detector: POS
 Attn: 10 DB
 RL Offset: 10.5 DB
 Sweep Time: 12.7ms
 Ref Lvl: 10.5 DBM

Comments

8PSK:
 20dB BW: 1.350 MHz

Cursor 1 2402.6958 -5.70 

Cursor 2 2401.3456 -25.70 

Delta Freq. 1.350

Delta Amplitude 20.00



Client: Fitbit, Inc.	Job Number: J95447
Model: FB501 (Proton)	T-Log Number: T95507
Contact: Arndt Hufenbach	Project Manager: Deepa Shetty
Standard: FCC 15.247/RSS-210/LP 00002	Project Coordinator: Irene Rademacher
	Class: N/A

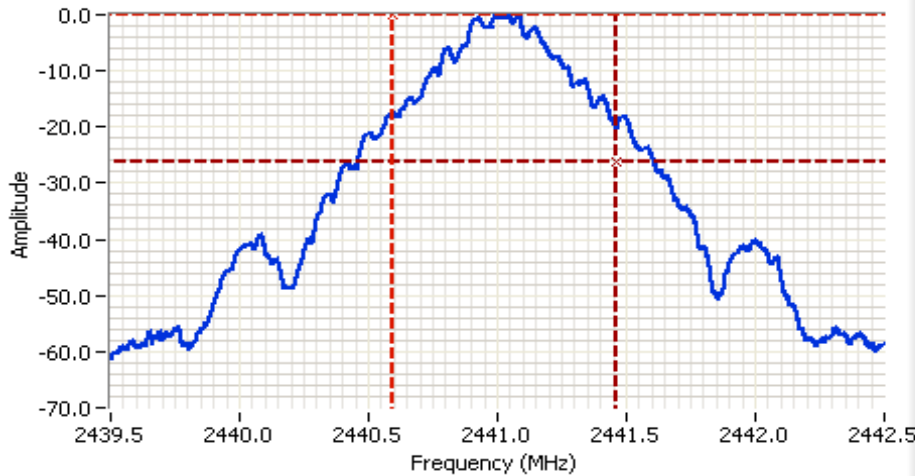

Analyzer Settings
 Agilent Technologies, E4446A
 CF: 2441.000 MHz
 SPAN: 3.000 MHz
 RB: 30.0 kHz
 VB: 100 kHz
 Detector: POS
 Attn: 10 DB
 RL Offset: 10.5 DB
 Sweep Time: 3.3ms
 Ref Lvl: 10.5 DBM

Comments
 GFSK
 99% BW: 866 kHz

Cursor 1	2440.5926	-0.05		Delta Freq.	866 kHz
Cursor 2	2441.4584	-26.05		Delta Amplitude	26.00

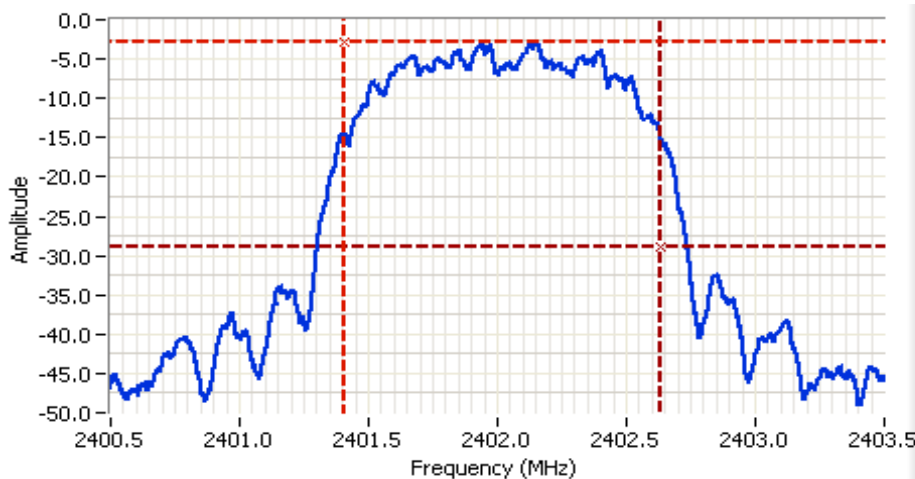

Analyzer Settings
 Agilent Technologies, E4446A
 CF: 2402.000 MHz
 SPAN: 3.000 MHz
 RB: 30.0 kHz
 VB: 100 kHz
 Detector: POS
 Attn: 10 DB
 RL Offset: 10.5 DB
 Sweep Time: 3.3ms
 Ref Lvl: 10.5 DBM

Comments
 8PSK
 99% BW: 1.228 MHz

Cursor 1	2401.4060	-2.89		Delta Freq.	1.228
Cursor 2	2402.6336	-28.89		Delta Amplitude	26.00





EMC Test Data

Client: Fitbit, Inc.	Job Number: J95447
Model: FB501 (Proton)	T-Log Number: T95507
Contact: Arndt Hufenbach	Project Manager: Deepa Shetty
Standard: FCC 15.247/RSS-210/LP 00002	Project Coordinator: Irene Rademacher
	Class: N/A

Frequency hopping systems in the 2400-2483.5 MHz band shall use at least 15 channels.
 The average time of occupancy on any channel shall not be greater than 0.4 seconds within a period of 0.4 seconds multiplied by the number of hopping channels employed. (Frequency hopping systems may avoid or suppress transmissions on a particular hopping frequency provided that a minimum of 15 channels are used.)
 The channel dwell time is calculated from the transmit time on a channel multiplied by the number of times a channel could be used in a period of 0.4 times the number of channels, N (i.e. 0.4N divided by the time between successive hops, rounded up to the closest integer), unless the time between successive hops exceeds 0.4N, in which case the channel dwell time is the transmit time on a channel.

Maximum 20dB bandwidth:	1350 kHz	
Channel spacing:	1016 kHz	
Transmission time per hop:	0.2 ms	
The time between successive hops on a channel:	24.4 ms	
Number of channels (N):	79	Pass
Channel dwell time in 31.6 seconds:	259.2 ms	Pass

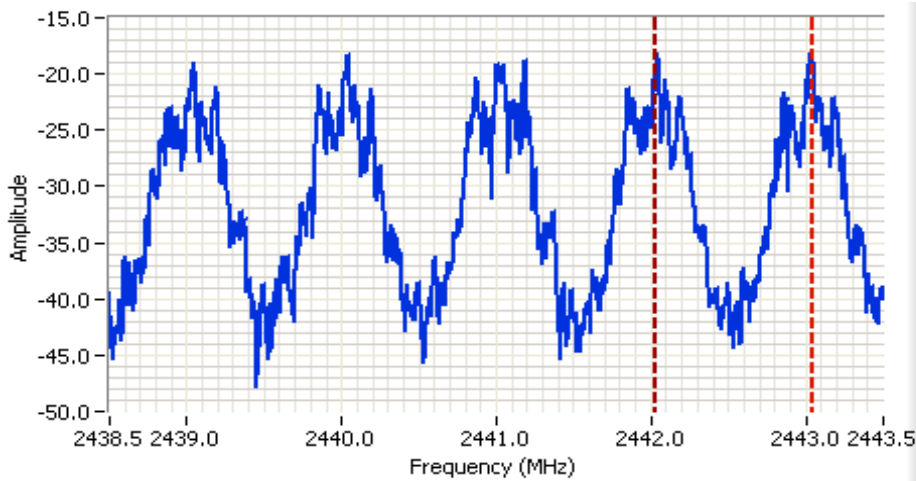

Analyzer Settings
 Agilent Technologies, E4446A
 CF: 2441.000 MHz
 SPAN: 5.000 MHz
 RB: 30.0 kHz
 VB: 1.000 MHz
 Detector: POS
 Attn: 10 DB
 RL Offset: 10.5 DB
 Sweep Time: 5.3ms
 Ref Lvl: 10.5 DBM

Comments
 Channel Spacing: 1016kHz

Cursor 1	2443.0443	0.00		Delta Freq.	1.016
Cursor 2	2442.0286	0.00		Delta Amplitude	0.00



Client: Fitbit, Inc.	Job Number: J95447
Model: FB501 (Proton)	T-Log Number: T95507
Contact: Arndt Hufenbach	Project Manager: Deepa Shetty
Standard: FCC 15.247/RSS-210/LP 00002	Project Coordinator: Irene Rademacher
	Class: N/A

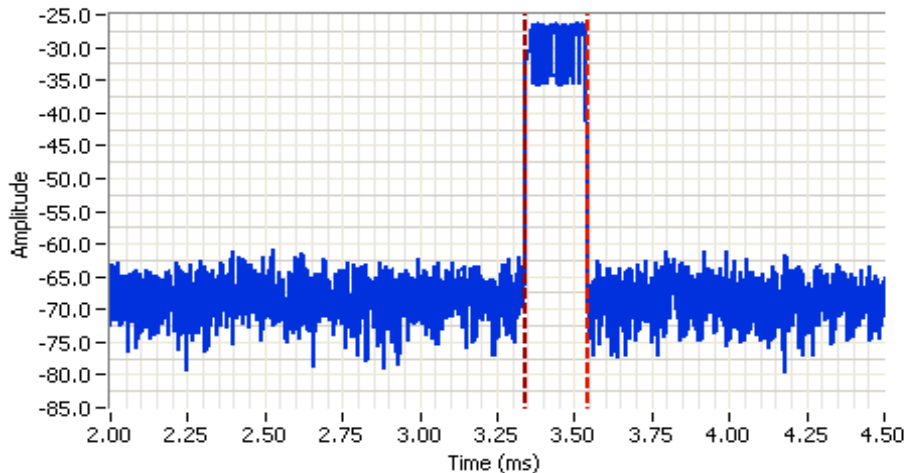

Analyzer Settings

Agilent Technologies, E4446A
 CF: 2441.000 MHz
 SPAN: 0.000 MHz
 RB: 1.000 MHz
 VB: 3.000 MHz
 Detector: POS
 Attn: 10 DB
 RL Offset: 10.5 DB
 Sweep Time: 5.0ms
 Ref Lvl: 10.5 DBM

Comments

Transmission time/ hop:
 0.2ms

Cursor 1 3.5430 0.00  Delta Time (ms) 0.199

Cursor 2 3.3440 0.00  Delta Amplitude 0.00

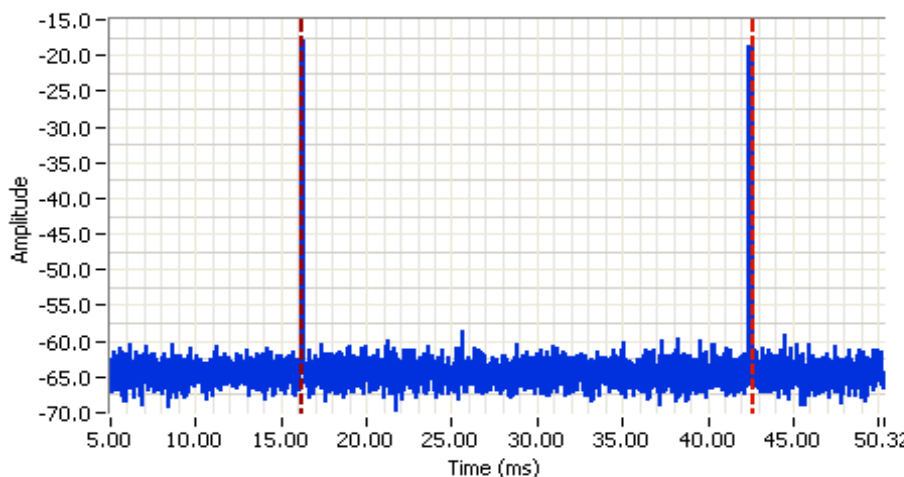

Analyzer Settings

Agilent Technologies, E4446A
 CF: 2441.500 MHz
 SPAN: 0.000 MHz
 RB: 1.000 MHz
 VB: 3.000 MHz
 Detector: POS
 Attn: 10 DB
 RL Offset: 10.5 DB
 Sweep Time: 50.3ms
 Ref Lvl: 10.5 DBM

Comments

The time between successive hops on a channel: 24.4 ms

Cursor 1 42.6223 0.00  Delta Time (ms) 26.445

Cursor 2 16.1771 0.00  Delta Amplitude 0.00





EMC Test Data

Client: Fitbit, Inc.	Job Number: J95447
Model: FB501 (Proton)	T-Log Number: T95507
Contact: Arndt Hufenbach	Project Manager: Deepa Shetty
Standard: FCC 15.247/RSS-210/LP 00002	Project Coordinator: Irene Rademacher
	Class: N/A

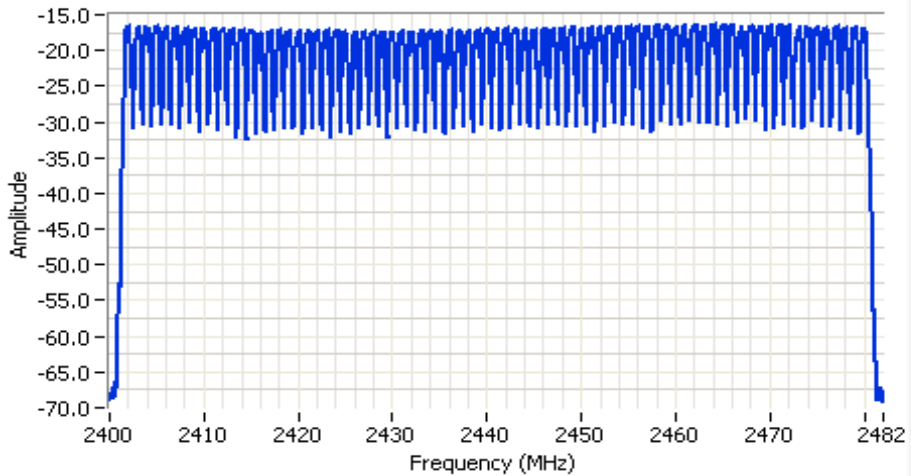

Analyzer Settings

- Agilent Technologies, E4446A
- CF: 2441.000 MHz
- SPAN: 82.000 MHz
- RB: 300 kHz
- VB: 100 kHz
- Detector: POS
- Attn: 10 DB
- RL Offset: 10.5 DB
- Sweep Time: 2.3ms
- Ref Lvl: 10.5 DBM

Comments

Number of channels: 79

Cursor 1: 2390.0000 0.00

Cursor 2: 2485.0000 0.00

Delta Freq: 95.000

Delta Amplitude: 0.00





EMC Test Data

Client:	Fitbit, Inc.	Job Number:	J95447
Product:	FB501 (Proton)	T-Log Number:	T95502
		Project Manager:	Deepa Shetty
Contact:	Arndt Hufenbach	Project Coordinator:	Irene Rademacher
Emissions Standard(s):	FCC 15B / EN55022 / CNS 13438	Class:	-
Immunity Standard(s):	EN 55024 / EN 301 489-1/-3/-17	Environment:	-

EMC Test Data

For The

Fitbit, Inc.

Product

FB501 (Proton)

Date of Last Test: 7/22/2014



EMC Test Data

Client: Fitbit, Inc.	Job Number: J95447
Model: FB501 (Proton)	T-Log Number: T95502
	Project Manager: Deepa Shetty
Contact: Arndt Hufenbach	Project Coordinator: Irene Rademacher
Standard: FCC 15B / EN55022 / CNS 13438	Class: -

Conducted Emissions

(Elliott Laboratories Fremont Facility, Semi-Anechoic Chamber)

Test Specific Details

Objective: The objective of this test session is to perform final qualification testing of the EUT with respect to the specification listed above.

Date of Test: 7/7/2014	Config. Used: 1
Test Engineer: Alika Hirano	Config Change: None
Test Location: Fremont Chamber #3	Host Unit Voltage 120V/60Hz & 220V/60Hz

General Test Configuration

For tabletop equipment, the host system was located on a wooden table inside the semi-anechoic chamber, 40 cm from a vertical coupling plane and 80cm from the LISN. Remote support equipment was located outside of the semi-anechoic chamber. Any cables running to remote support equipment where routed through metal conduit and when possible passed through a ferrite clamp upon exiting the chamber.

Ambient Conditions:	Temperature: 24 °C
	Rel. Humidity: 36 %

Summary of Results

Run #	Test Performed	Limit	Result	Margin
1	CE, AC Power, 110V/60Hz	FCC 15.207	Pass	49.3 dBµV @ 0.157 MHz (-16.3 dB)

Modifications Made During Testing

No modifications were made to the EUT during testing

Deviations From The Standard

No deviations were made from the requirements of the standard.

Notes

EUT is a PC peripheral. Testing performed connected to a host computer and setup in accordance with ANSI 63.4
 BT radio should be transmitting (active) and GPS active
 Results to be used for FCC 15.207 compliance

Client: Fitbit, Inc.	Job Number: J95447
Model: FB501 (Proton)	T-Log Number: T95502
Contact: Arndt Hufenbach	Project Manager: Deepa Shetty
Standard: FCC 15B / EN55022 / CNS 13438	Project Coordinator: Irene Rademacher
	Class: -

Run #1: AC Power Port Conducted Emissions, 0.15 - 30MHz, 110V/60Hz

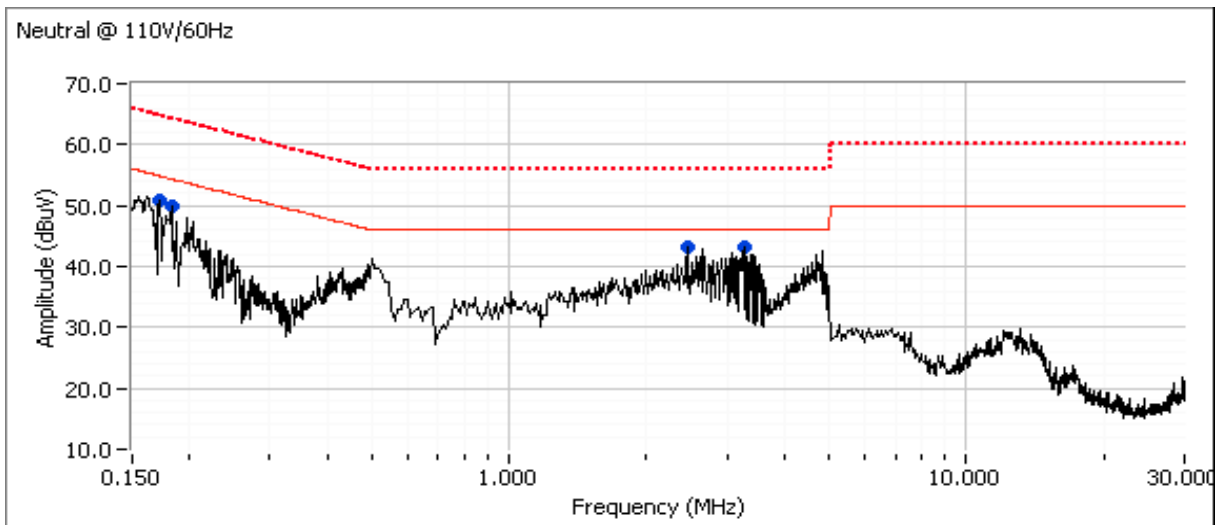
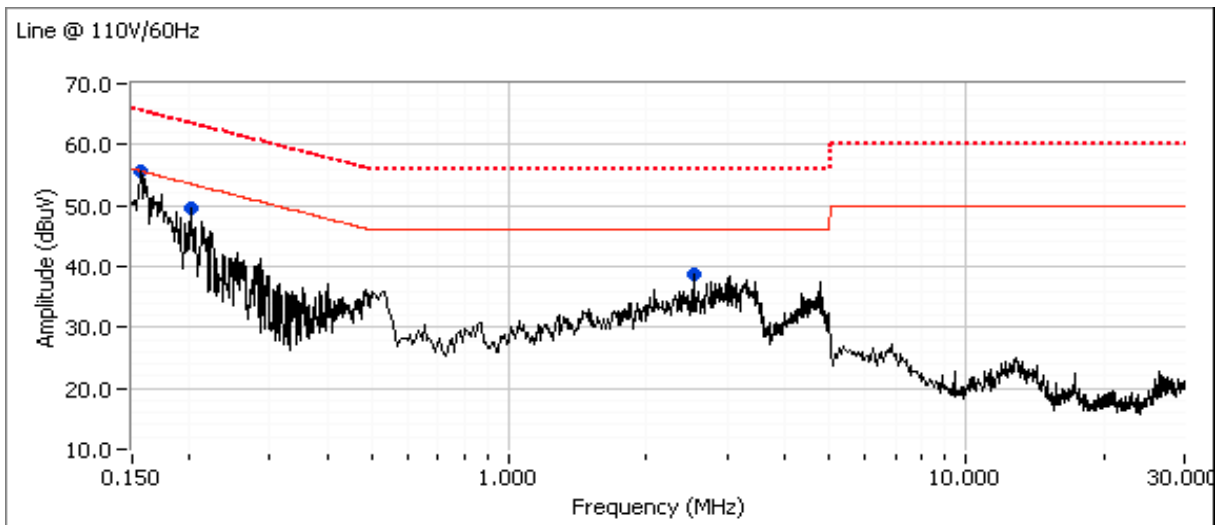



EMC Test Data

Client: Fitbit, Inc.	Job Number: J95447
Model: FB501 (Proton)	T-Log Number: T95502
	Project Manager: Deepa Shetty
Contact: Arndt Hufenbach	Project Coordinator: Irene Rademacher
Standard: FCC 15B / EN55022 / CNS 13438	Class: -

Preliminary peak readings captured during pre-scan (peak readings vs. average limit)

Frequency MHz	Level dB μ V	AC Line	15.207		Detector QP/Ave	Comments
			Limit	Margin		
0.157	55.6	Line 1	55.6	0.0	Peak	
0.201	49.6	Line 1	53.6	-4.0	Peak	
2.523	38.6	Line 1	46.0	-7.4	Peak	
0.171	50.9	Neutral	54.9	-4.0	Peak	
0.184	49.9	Neutral	54.3	-4.4	Peak	
2.473	43.1	Neutral	46.0	-2.9	Peak	
3.242	43.1	Neutral	46.0	-2.9	Peak	

Final quasi-peak and average readings

Frequency MHz	Level dB μ V	AC Line	15.207		Detector QP/Ave	Comments
			Limit	Margin		
0.157	49.3	Line 1	65.6	-16.3	QP	QP (1.00s)
2.473	27.3	Neutral	46.0	-18.7	AVG	AVG (0.10s)
0.170	45.6	Neutral	65.0	-19.4	QP	QP (1.00s)
3.242	36.5	Neutral	56.0	-19.5	QP	QP (1.00s)
0.184	43.0	Neutral	64.3	-21.3	QP	QP (1.00s)
3.242	24.6	Neutral	46.0	-21.4	AVG	AVG (0.10s)
2.473	34.4	Neutral	56.0	-21.6	QP	QP (1.00s)
0.201	42.0	Line 1	63.6	-21.6	QP	QP (1.00s)
0.157	32.1	Line 1	55.6	-23.5	AVG	AVG (0.10s)
2.523	22.2	Line 1	46.0	-23.8	AVG	AVG (0.10s)
2.523	29.2	Line 1	56.0	-26.8	QP	QP (1.00s)
0.170	26.9	Neutral	55.0	-28.1	AVG	AVG (0.10s)
0.201	25.5	Line 1	53.6	-28.1	AVG	AVG (0.10s)
0.184	25.8	Neutral	54.3	-28.5	AVG	AVG (0.10s)

End of Report

This page is intentionally blank and marks the last page of this test report.