

**EMC Test Report****Application for FCC Grant of Equipment Authorization  
Canada Certification****Innovation, Science and Economic Development Canada  
RSS-Gen Issue 5 / RSS-247 Issue 2  
FCC Part 15 Subpart C****Model: FB410**IC CERTIFICATION #: 8542A-FB410  
FCC ID: XRAFB410APPLICANT: Fitbit, Inc.  
199 Fremont Street, 14th Floor  
San Francisco, CA 94105TEST SITE(S): National Technical Systems  
41039 Boyce Road.  
Fremont, CA. 94538-2435

IC SITE REGISTRATION #: 2845B-7

PROJECT NUMBER: PR069580

REPORT DATE: May 30, 2018

FINAL TEST DATES: April 9, 10, 11, 12, 13, 16 and 17, 2018

TOTAL NUMBER OF PAGES: 60



This report and the information contained herein represent the results of testing test articles identified and selected by the client performed to specifications and/or procedures selected by the client. National Technical Systems (NTS) makes no representations, expressed or implied, that such testing is adequate (or inadequate) to demonstrate efficiency, performance, reliability, or any other characteristic of the articles being tested, or similar products. This report should not be relied upon as an endorsement or certification by NTS of the equipment tested, nor does it represent any statement whatsoever as to its merchantability or fitness of the test article, or similar products, for a particular purpose. This report shall not be reproduced except in full

---

**VALIDATING SIGNATORIES**

PROGRAM MGR

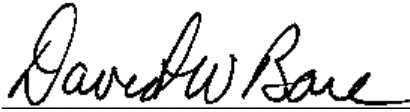

David W. Bare  
Chief Engineer

TECHNICAL REVIEWER:



David W. Bare  
Chief Engineer

FINAL REPORT PREPARER:



David Guidotti  
Senior Technical Writer

QUALITY ASSURANCE DELEGATE



Gary Izard  
Technical Writer



---

**REVISION HISTORY**

Rev#	Date	Comments	Modified By
-	May 30, 2018	First release	

## TABLE OF CONTENTS

<b>COVER PAGE</b> .....	<b>1</b>
<b>VALIDATING SIGNATORIES</b> .....	<b>2</b>
<b>REVISION HISTORY</b> .....	<b>3</b>
<b>TABLE OF CONTENTS</b> .....	<b>4</b>
<b>SCOPE</b> .....	<b>5</b>
<b>OBJECTIVE</b> .....	<b>6</b>
<b>STATEMENT OF COMPLIANCE</b> .....	<b>7</b>
<b>DEVIATIONS FROM THE STANDARDS</b> .....	<b>7</b>
<b>TEST RESULTS SUMMARY</b> .....	<b>8</b>
DIGITAL TRANSMISSION SYSTEMS (2400 – 2483.5MHZ) .....	8
MEASUREMENT UNCERTAINTIES.....	9
<b>EQUIPMENT UNDER TEST (EUT) DETAILS</b> .....	<b>10</b>
GENERAL.....	10
ANTENNA SYSTEM .....	10
ENCLOSURE.....	10
MODIFICATIONS.....	10
SUPPORT EQUIPMENT.....	10
EUT INTERFACE PORTS .....	10
ADDITIONAL INTERFACE PORTS ON SUPPORT EQUIPMENT .....	11
EUT OPERATION .....	11
<b>TEST SITE</b> .....	<b>12</b>
GENERAL INFORMATION .....	12
CONDUCTED EMISSIONS CONSIDERATIONS .....	12
RADIATED EMISSIONS CONSIDERATIONS .....	12
<b>MEASUREMENT INSTRUMENTATION</b> .....	<b>13</b>
RECEIVER SYSTEM .....	13
INSTRUMENT CONTROL COMPUTER .....	13
LINE IMPEDANCE STABILIZATION NETWORK (LISN).....	13
FILTERS/ATTENUATORS .....	14
ANTENNAS.....	14
ANTENNA MAST AND EQUIPMENT TURNTABLE.....	14
INSTRUMENT CALIBRATION.....	14
<b>TEST PROCEDURES</b> .....	<b>15</b>
EUT AND CABLE PLACEMENT .....	15
CONDUCTED EMISSIONS.....	15
RADIATED EMISSIONS .....	15
CONDUCTED EMISSIONS FROM ANTENNA PORT .....	19
BANDWIDTH MEASUREMENTS .....	19
SPECIFICATION LIMITS AND SAMPLE CALCULATIONS.....	20
CONDUCTED EMISSIONS SPECIFICATION LIMITS: FCC 15.207; FCC 15.107(A), RSS GEN .....	20
GENERAL TRANSMITTER RADIATED EMISSIONS SPECIFICATION LIMITS .....	21
RECEIVER RADIATED SPURIOUS EMISSIONS SPECIFICATION LIMITS.....	21
OUTPUT POWER LIMITS – DIGITAL TRANSMISSION SYSTEMS .....	22
TRANSMIT MODE SPURIOUS RADIATED EMISSIONS LIMITS – FHSS AND DTS SYSTEMS.....	22
SAMPLE CALCULATIONS - CONDUCTED EMISSIONS .....	23
SAMPLE CALCULATIONS - RADIATED EMISSIONS.....	23
SAMPLE CALCULATIONS - FIELD STRENGTH TO EIRP CONVERSION.....	24
<b>APPENDIX A TEST EQUIPMENT CALIBRATION DATA</b> .....	<b>25</b>
<b>APPENDIX B TEST DATA</b> .....	<b>28</b>
<b>END OF REPORT</b> .....	<b>60</b>

## **SCOPE**

An electromagnetic emissions test has been performed on the Fitbit, Inc. model FB410, pursuant to the following rules:

RSS-Gen Issue 5 “General Requirements for Compliance of Radio Apparatus”  
RSS 247 Issue 2 “Digital Transmission Systems (DTSs), Frequency Hopping Systems (FHSS) and Licence-Exempt Local Area Network (LE-LAN) Devices”  
FCC Part 15 Subpart C

Conducted and radiated emissions data has been collected, reduced, and analyzed within this report in accordance with measurement guidelines set forth in the following reference standards and as outlined in National Technical Systems test procedures:

ANSI C63.10-2013  
FCC DTS Measurement Guidance KDB558074

The intentional radiator above has been tested in a simulated typical installation to demonstrate compliance with the relevant Industry Canada performance and procedural standards.

Final system data was gathered in a mode that tended to maximize emissions by varying orientation of EUT, orientation of power and I/O cabling, antenna search height, and antenna polarization.

Every practical effort was made to perform an impartial test using appropriate test equipment of known calibration. All pertinent factors have been applied to reach the determination of compliance.

National Technical Systems is accredited by the A2LA, certificate number 0214.26, to perform the test(s) listed in this report, except where noted otherwise.

**OBJECTIVE**

The primary objective of the manufacturer is compliance with the regulations outlined in the previous section.

Prior to marketing in the USA, all unlicensed transmitters and transceivers require certification. Receive-only devices operating between 30 MHz and 960 MHz are subject to either certification or a manufacturer's declaration of conformity, with all other receive-only devices exempt from the technical requirements.

Prior to marketing in Canada, Class I transmitters, receivers and transceivers require certification. Class II devices are required to meet the appropriate technical requirements but are exempt from certification requirements.

Certification is a procedure where the manufacturer submits test data and technical information to a certification body and receives a certificate or grant of equipment authorization upon successful completion of the certification body's review of the submitted documents. Once the equipment authorization has been obtained, the label indicating compliance must be attached to all identical units, which are subsequently manufactured.

Maintenance of compliance is the responsibility of the manufacturer. Any modification of the product which may result in increased emissions should be checked to ensure compliance has been maintained (i.e., printed circuit board layout changes, different line filter, different power supply, harnessing or I/O cable changes, etc.).

**STATEMENT OF COMPLIANCE**

The tested sample of Fitbit, Inc. model FB410 complied with the requirements of the following regulations:

RSS-Gen Issue 5 “General Requirements for Compliance of Radio Apparatus”  
RSS 247 Issue 2 “Digital Transmission Systems (DTSs), Frequency Hopping Systems (FHSS) and Licence-Exempt Local Area Network (LE-LAN) Devices”  
FCC Part 15 Subpart C

Maintenance of compliance is the responsibility of the manufacturer. Any modifications to the product should be assessed to determine their potential impact on the compliance status of the device with respect to the standards detailed in this test report.

The test results recorded herein are based on a single type test of Fitbit, Inc. model FB410 and therefore apply only to the tested sample. The sample was selected and prepared by Ricky Wang of Fitbit, Inc.

**DEVIATIONS FROM THE STANDARDS**

No deviations were made from the published requirements listed in the scope of this report.

## TEST RESULTS SUMMARY

### DIGITAL TRANSMISSION SYSTEMS (2400 – 2483.5MHz)

FCC Rule Part	RSS Rule Part	Description	Measured Value / Comments	Limit / Requirement	Result
15.247(a)	RSS 247 5.2	Digital Modulation	Systems uses GFSK modulation	System must utilize a digital transmission technology	Complies
15.247 (a) (2)	RSS 247 5.2 (1)	6dB Bandwidth	760 kHz	>500kHz	Complies
15.247 (b) (3)	RSS 247 5.4 (4)	Output Power (multipoint systems)	4.5 dBm (0.0028 Watts) EIRP = 0.00024 W <sup>Note 1</sup>	1Watt, EIRP limited to 4 Watts.	Complies
15.247(e)	RSS 247 5.2 (2)	Power Spectral Density	-3.9 dBm/10 kHz	8dBm/3kHz	Complies
15.247(d)	RSS 247 5.5	Antenna Port Spurious Emissions 30MHz – 25 GHz	All emissions < -20 dBc	< -20dBc	Complies
15.247(d) / 15.209	RSS 247 5.5	Radiated Spurious Emissions 30MHz – 25 GHz	27.8 dBμV/m @ 76.48 MHz (-12.2 dB)	Refer to the limits section (p21) for restricted bands, all others < -20dBc	Complies

Note 1: EIRP calculated using antenna gains of -10.7 dBi for the highest EIRP system.

### GENERAL REQUIREMENTS APPLICABLE TO ALL BANDS

FCC Rule Part	RSS Rule part	Description	Measured Value / Comments	Limit / Requirement	Result (margin)
15.203	-	RF Connector	Integral antenna	Unique or integral antenna required	Complies
15.407 (b) (6)	RSS-Gen Table 4	AC Conducted Emissions	35.5 dBμV @ 0.48 MHz (-20.7 dB)	Refer to page 20	Complies
15.247 (i) / 15.407 (f)	RSS 102	RF Exposure Requirements	Refer to SAR exclusion report and RSS 102 declaration	Refer to OET 65, FCC Part 1 and RSS 102	Complies
-	RSS-Gen 6.8	User Manual	N/A	Statement for products with detachable antenna	Complies
-	RSS-Gen 8.4	User Manual	In user manual, product to small	Statement for all products	Complies
-	RSP-100 RSS-Gen 6.7	Occupied Bandwidth	1804 kHz	Information only	N/A



**MEASUREMENT UNCERTAINTIES**

ISO/IEC 17025 requires that an estimate of the measurement uncertainties associated with the emissions test results be included in the report. The measurement uncertainties given below are based on a 95% confidence level and were calculated in accordance with UKAS document LAB 34.

Measurement Type	Measurement Unit	Frequency Range	Expanded Uncertainty
RF power, conducted (power meter)	dBm	25 to 7000 MHz	± 0.52 dB
RF power, conducted (Spectrum analyzer)	dBm	25 to 7000 MHz	± 0.7 dB
Conducted emission of transmitter	dBm	25 to 26500 MHz	± 0.7 dB
Conducted emission of receiver	dBm	25 to 26500 MHz	± 0.7 dB
Radiated emission (substitution method)	dBm	25 to 26500 MHz	± 2.5 dB
Radiated emission (field strength)	dB $\mu$ V/m	25 to 1000 MHz	± 3.6 dB
		1000 to 40000 MHz	± 6.0 dB
Conducted Emissions (AC Power)	dB $\mu$ V	0.15 to 30 MHz	± 2.4 dB

## EQUIPMENT UNDER TEST (EUT) DETAILS

### GENERAL

The Fitbit, Inc. model FB410 is a wrist-worn activity tracker, which sends data about activity to the user via a Bluetooth Low Energy (BLE) link. It also has an NFC transceiver. It is powered by an internal, rechargeable battery. The EUT was treated as tabletop equipment during testing to simulate the end-user environment. The electrical rating of the EUT is 3.85 VDC.

The sample was received on April 9, 2018 and tested on April 9, 10, 11, 12, 13, 16 and 17, 2018. The EUT consisted of the following component(s):

Company	Model	Description	Serial Number	FCC ID
Fitbit, Inc.	FB410	Wireless Activity Tracker	B2-SAT2-279A-C43	XRAFB410

### ANTENNA SYSTEM

The antenna system consists of an integral -10.7 dBi antenna

### ENCLOSURE

The EUT enclosure is primarily constructed of metal and plastic. It measures approximately 24 cm wide by 2.5 cm deep by 1.3 cm high.

### MODIFICATIONS

No modifications were made to the EUT during the time the product was at NTS Silicon Valley.

### SUPPORT EQUIPMENT

The following equipment was used as local support equipment for testing:

Company	Model	Description	Serial Number	FCC ID
Choetech	Qualcomm Quickcharge 30	USB charger	NA	-
Fitbit	-	Charging cable	NA	-

### EUT INTERFACE PORTS

The I/O cabling configuration during testing was as follows:

Port	Connected To	Cable(s)		Length(m)
		Description	Shielded or Unshielded	
Charge contacts	Charger	3 pin custom	Shielded	0.4

**ADDITIONAL INTERFACE PORTS ON SUPPORT EQUIPMENT**

The I/O cabling configuration during testing was as follows:

Port	Connected To	Description	Cable(s)	
			Shielded or Unshielded	Length(m)
AC in (charger)	AC mains	Direct connect	NA	NA

**EUT OPERATION**

During emissions testing the EUT was continuously transmitting at maximum power on the channel called out in the individual test. The modulation used was noted for each test. The display was configured to display a cross pattern.

**TEST SITE**

**GENERAL INFORMATION**

Final test measurements were taken at the test sites listed below. Pursuant to section 2.948 of the FCC’s Rules and section 3.3 of RSP-100, construction, calibration, and equipment data has been filed with the Commission and with industry Canada.

Site	Designation / Registration Numbers		Location
	FCC	Canada	
Chamber 7	US0027	2845B-7	41039 Boyce Road Fremont, CA 94538-2435

ANSI C63.4 recommends that ambient noise at the test site be at least 6 dB below the allowable limits. Ambient levels are below this requirement. The test site(s) contain separate areas for radiated and conducted emissions testing. Considerable engineering effort has been expended to ensure that the facilities conform to all pertinent requirements of ANSI C63.4.

**CONDUCTED EMISSIONS CONSIDERATIONS**

Conducted emissions testing is performed in conformance with ANSI C63.10. Measurements are made with the EUT connected to the public power network through a nominal, standardized RF impedance, which is provided by a line impedance stabilization network, known as a LISN. A LISN is inserted in series with each current-carrying conductor in the EUT power cord.

**RADIATED EMISSIONS CONSIDERATIONS**

The FCC has determined that radiation measurements made in a shielded enclosure are not suitable for determining levels of radiated emissions. Radiated measurements are performed in an open field environment or in a semi-anechoic chamber. The test sites are maintained free of conductive objects within the CISPR defined elliptical area incorporated in ANSI C63.4 guidelines and meet the Normalized Site Attenuation (NSA) requirements of ANSI C63.4.

---

## **MEASUREMENT INSTRUMENTATION**

### **RECEIVER SYSTEM**

An EMI receiver as specified in CISPR 16-1-1 is used for emissions measurements. The receivers used can measure over the frequency range of 9 kHz up to 2000 MHz. These receivers allow both ease of measurement and high accuracy to be achieved. The receivers have Peak, Average, and CISPR (Quasi-peak) detectors built into their design so no external adapters are necessary. The receiver automatically sets the required bandwidth for the CISPR detector used during measurements. If the repetition frequency of the signal being measured is below 20Hz, peak measurements are made in lieu of Quasi-Peak measurements.

For measurements above the frequency range of the receivers, a spectrum analyzer is utilized because it provides visibility of the entire spectrum along with the precision and versatility required to support engineering analysis. Average measurements above 1000MHz are performed on the spectrum analyzer using the linear-average method with a resolution bandwidth of 1 MHz and a video bandwidth of 10 Hz, unless the signal is pulsed in which case the average (or video) bandwidth of the measuring instrument is reduced to onset of pulse desensitization and then increased.

### **INSTRUMENT CONTROL COMPUTER**

Software is used to view and convert receiver measurements to the field strength at an antenna or voltage developed at the LISN measurement port, which is then compared directly with the appropriate specification limit. This provides faster, more accurate readings by performing the conversions described under Sample Calculations within the Test Procedures section of this report. Results are printed in a graphic and/or tabular format, as appropriate. A personal computer is used to record all measurements made with the receivers. The software used for radiated and conducted emissions measurements is NTS EMI Test Software (rev 2.10)

### **LINE IMPEDANCE STABILIZATION NETWORK (LISN)**

Line conducted measurements utilize a fifty microhenry Line Impedance Stabilization Network as the monitoring point. The LISN used also contains a 250 uH CISPR adapter. This network provides for calibrated radio frequency noise measurements by the design of the internal low pass and high pass filters on the EUT and measurement ports, respectively.

---

**FILTERS/ATTENUATORS**

External filters and precision attenuators are often connected between the receiving antenna or LISN and the receiver. This eliminates saturation effects and non-linear operation due to high amplitude transient events.

**ANTENNAS**

A loop antenna is used below 30 MHz. For the measurement range 30 MHz to 1000 MHz either a combination of a biconical antenna and a log periodic or a bi-log antenna is used. Above 1000 MHz, horn antennas are used. The antenna calibration factors to convert the received voltage to an electric field strength are included with appropriate cable loss and amplifier gain factors to determine an overall site factor, which is then programmed into the test receivers or incorporated into the test software.

**ANTENNA MAST AND EQUIPMENT TURNTABLE**

The antennas used to measure the radiated electric field strength are mounted on a non-conductive antenna mast equipped with a motor-drive to vary the antenna height. Measurements below 30 MHz are made with the loop antenna at a fixed height of 1m above the ground plane.

ANSI C63.10 specifies that the test height above ground for table mounted devices shall be 80 centimeters for testing below 1 GHz and 1.5m for testing above 1 GHz. Floor mounted equipment shall be placed on the ground plane if the device is normally used on a conductive floor or separated from the ground plane by insulating material from 3 to 12 mm if the device is normally used on a non-conductive floor as specified in ANSI C63.4. During radiated measurements, the EUT is positioned on a motorized turntable in conformance with this requirement.

**INSTRUMENT CALIBRATION**

All test equipment is regularly checked to ensure that performance is maintained in accordance with the manufacturer's specifications. All antennas are calibrated at regular intervals with respect to tuned half-wave dipoles. An exhibit of this report contains the list of test equipment used and calibration information.

## TEST PROCEDURES

### EUT AND CABLE PLACEMENT

The regulations require that interconnecting cables be connected to the available ports of the unit and that the placement of the unit and the attached cables simulate the worst case orientation that can be expected from a typical installation, so far as practicable. To this end, the position of the unit and associated cabling is varied within the guidelines of ANSI C63.10, and the worst-case orientation is used for final measurements.

### CONDUCTED EMISSIONS

Conducted emissions are measured at the plug end of the power cord supplied with the EUT. Excess power cord length is wrapped in a bundle between 30 and 40 centimeters in length near the center of the cord. Preliminary measurements are made to determine the highest amplitude emission relative to the specification limit for all the modes of operation. Placement of system components and varying of cable positions are performed in each mode. A final peak mode scan is then performed in the position and mode for which the highest emission was noted on all current carrying conductors of the power cord.

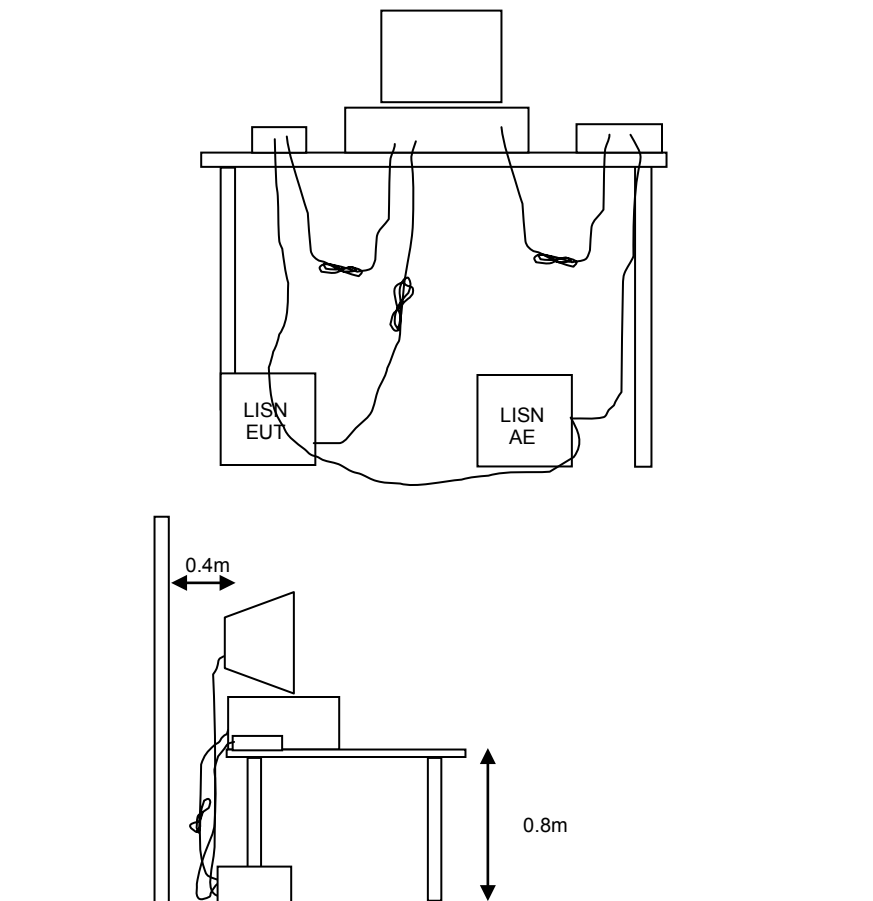

Figure 1 Typical Conducted Emissions Test Configuration

**RADIATED EMISSIONS**

A preliminary scan of the radiated emissions is performed in which all significant EUT frequencies are identified with the system in a nominal configuration. At least two scans are performed, one scan for each antenna polarization (horizontal and vertical; loop parallel and perpendicular to the EUT). During the preliminary scans, the EUT is rotated through 360°, the antenna height is varied (for measurements above 30 MHz) and cable positions are varied to determine the highest emission relative to the limit. Preliminary scans may be performed in a fully anechoic chamber for the purposes of identifying the frequencies of the highest emissions from the EUT.

A speaker is provided in the receiver to aid in discriminating between EUT and ambient emissions. Other methods used during the preliminary scan for EUT emissions involve scanning with near field magnetic loops, monitoring I/O cables with RF current clamps, and cycling power to the EUT.

Final maximization is a phase in which the highest amplitude emissions identified in the spectral search are viewed while the EUT azimuth angle is varied from 0 to 360 degrees relative to the receiving antenna. The azimuth, which results in the highest emission is then maintained while varying the antenna height from one to four meters (for measurements above 30 MHz, measurements below 30 MHz are made with the loop antenna at a fixed height of 1m). The result is the identification of the highest amplitude for each of the highest peaks. Each recorded level is corrected in the receiver using appropriate factors for cables, connectors, antennas, and preamplifier gain.

When testing above 18 GHz, the receive antenna is located at 1 meter from the EUT and the antenna height is restricted to a maximum of 2.5 meters.



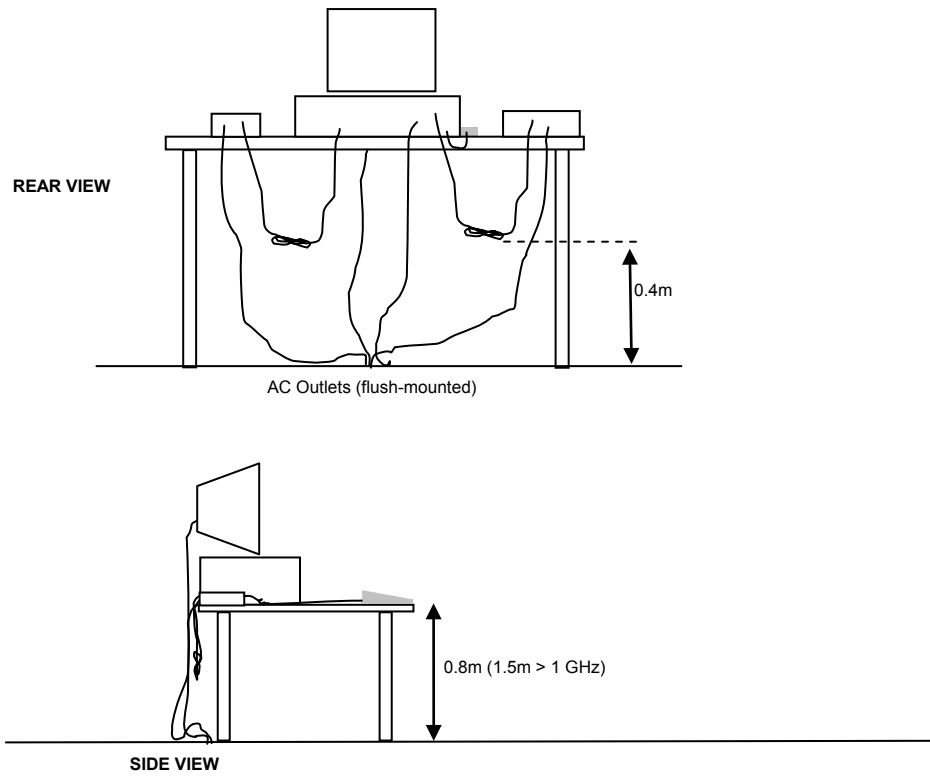

Typical Test Configuration for Radiated Field Strength Measurements

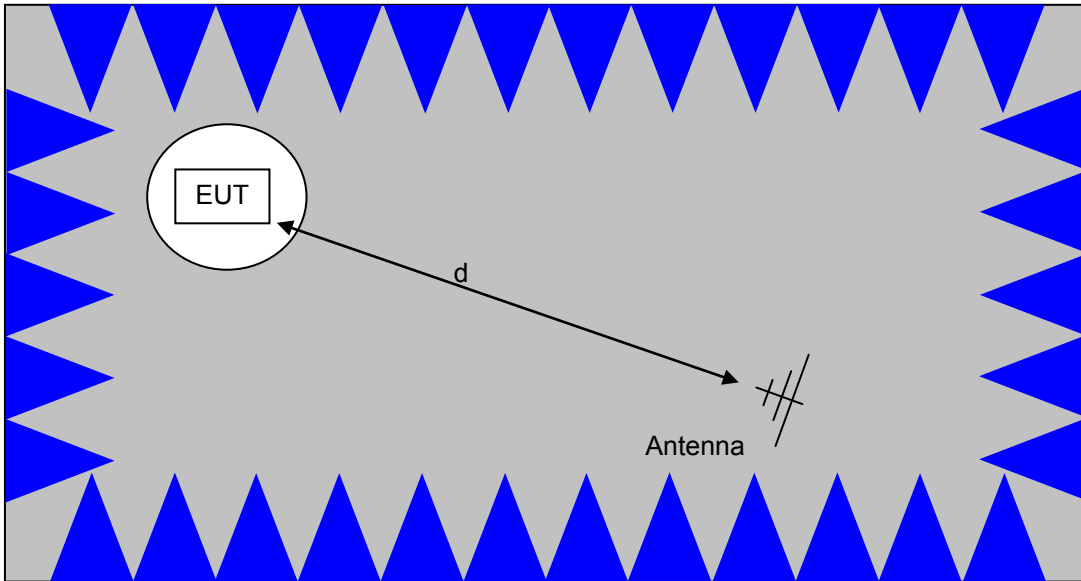

The anechoic materials on the walls and ceiling ensure compliance with the normalized site attenuation requirements of CISPR 16 / CISPR 22 / ANSI C63.4 for an alternate test site at the measurement distances used.

Floor-standing equipment is placed on the floor with insulating supports between the unit and the ground plane.

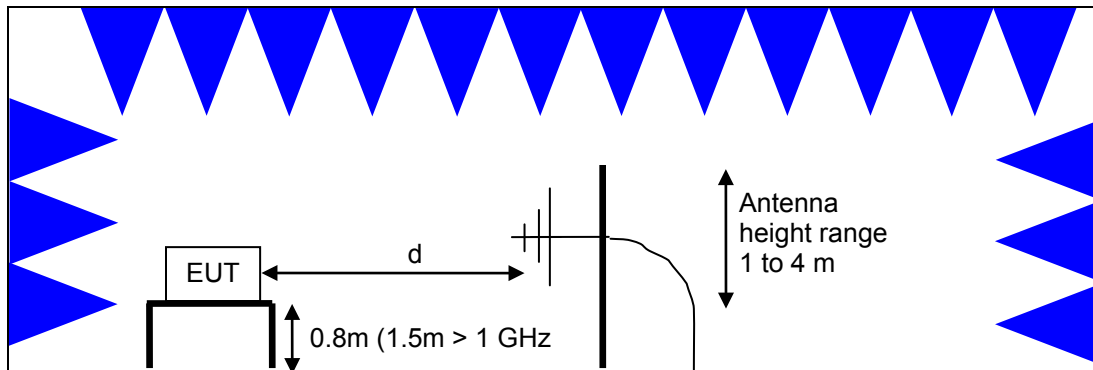

Test Configuration for Radiated Field Strength Measurements  
Semi-Anechoic Chamber, Plan and Side Views

### **CONDUCTED EMISSIONS FROM ANTENNA PORT**

Direct measurements of power, bandwidth and power spectral density are performed, where possible, with the antenna port of the EUT connected to either the power meter or spectrum analyzer via a suitable attenuator and/or filter. These are used to ensure that the front end of the measurement instrument is not overloaded by the fundamental transmission.

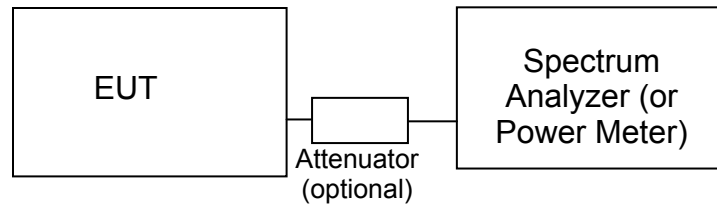

#### Test Configuration for Antenna Port Measurements

Measurement bandwidths (video and resolution) are set in accordance with the relevant standards and NTS Silicon Valley's test procedures for the type of radio being tested. When power measurements are made using a resolution bandwidth less than the signal bandwidth the power is calculated by summing the power across the signal bandwidth using either the analyzer channel power function or by capturing the trace data and calculating the power using software. In both cases the summed power is corrected to account for the equivalent noise bandwidth (ENBW) of the resolution bandwidth used.

If power averaging is used (typically for certain digital modulation techniques), the EUT is configured to transmit continuously. Power averaging is performed using either the built-in function of the analyzer or, if the analyzer does not feature power averaging, using external software. In both cases the average power is calculated over a number of sweeps (typically 100). When the EUT cannot be configured to continuously transmit then either the analyzer is configured to perform a gated sweep to ensure that the power is averaged over periods that the device is transmitting or power averaging is disabled and a max-hold feature is used.

If a power meter is used to make output power measurements the sensor head type (peak or average) is stated in the test data table.

### **BANDWIDTH MEASUREMENTS**

The 6dB, 20dB, 26dB and/or 99% signal bandwidth are measured using the bandwidths recommended by ANSI C63.10 and RSS GEN.

**SPECIFICATION LIMITS AND SAMPLE CALCULATIONS**

The limits for conducted emissions are given in units of microvolts, and the limits for radiated emissions are given in units of microvolts per meter at a specified test distance. Data is measured in the logarithmic form of decibels relative to one microvolt, or dB microvolts (dBuV). For radiated emissions, the measured data is converted to the field strength at the antenna in dB microvolts per meter (dBuV/m). The results are then converted to the linear forms of uV and uV/m for comparison to published specifications.

For reference, converting the specification limits from linear to decibel form is accomplished by taking the base ten logarithm, then multiplying by 20. These limits in both linear and logarithmic form are as follows:

**CONDUCTED EMISSIONS SPECIFICATION LIMITS: FCC 15.207; FCC 15.107(a), RSS GEN**

The table below shows the limits for the emissions on the AC power line from an intentional radiator and a receiver.

Frequency (MHz)	Average Limit (dBuV)	Quasi Peak Limit (dBuV)
0.150 to 0.500	Linear decrease on logarithmic frequency axis between 56.0 and 46.0	Linear decrease on logarithmic frequency axis between 66.0 and 56.0
0.500 to 5.000	46.0	56.0
5.000 to 30.000	50.0	60.0

**GENERAL TRANSMITTER RADIATED EMISSIONS SPECIFICATION LIMITS**

The table below shows the limits for the spurious emissions from transmitters that fall in restricted bands<sup>1</sup>.

Frequency Range (MHz)	Limit (uV/m)	Limit (dBuV/m @ 3m)
0.009-0.490	2400/F <sub>KHz</sub> @ 300m	67.6-20*log <sub>10</sub> (F <sub>KHz</sub> ) @ 300m
0.490-1.705	24000/F <sub>KHz</sub> @ 30m	87.6-20*log <sub>10</sub> (F <sub>KHz</sub> ) @ 30m
1.705 to 30	30 @ 30m	29.5 @ 30m
30 to 88	100 @ 3m	40 @ 3m
88 to 216	150 @ 3m	43.5 @ 3m
216 to 960	200 @ 3m	46.0 @ 3m
Above 960	500 @ 3m	54.0 @ 3m

**RECEIVER RADIATED SPURIOUS EMISSIONS SPECIFICATION LIMITS**

The table below shows the limits for the spurious emissions from receivers as detailed in FCC Part 15.109 and RSS GEN Table 3. Note that receivers operating outside of the frequency range 30 MHz – 960 MHz are exempt from the requirements of FCC Part 15.109 and receivers that are not stand-alone are exempt from the ISED Canada requirements per RSS-GEN and instead are subject to the requirements of ICES-003.

Frequency Range (MHz)	Limit (uV/m @ 3m)	Limit (dBuV/m @ 3m)
30 to 88	100	40
88 to 216	150	43.5
216 to 960	200	46.0
Above 960	500	54.0

<sup>1</sup> The restricted bands are detailed in FCC 15.205 and RSS-Gen Table 7

**OUTPUT POWER LIMITS – DIGITAL TRANSMISSION SYSTEMS**

The table below shows the limits for output power and output power density. Where the signal bandwidth is less than 20 MHz the maximum output power is reduced to the power spectral density limit plus 10 times the log of the bandwidth (in MHz).

Operating Frequency (MHz)	Output Power	Power Spectral Density
902 – 928	1 Watt (30 dBm)	8 dBm/3kHz
2400 – 2483.5	1 Watt (30 dBm)	8 dBm/3kHz
5725 – 5850	1 Watt (30 dBm)	8 dBm/3kHz

The maximum permitted output power is reduced by 1dB for every dB the antenna gain exceeds 6dBi. Fixed point-to-point applications using the 5725 – 5850 MHz band are not subject to this restriction.

**TRANSMIT MODE SPURIOUS RADIATED EMISSIONS LIMITS – FHSS and DTS SYSTEMS**

The limits for unwanted (spurious) emissions from the transmitter falling in the restricted bands are those specified in the general limits sections of FCC Part 15 and RSS 210. All other unwanted (spurious) emissions shall be at least 20dB below the level of the highest in-band signal level (30dB if the power is measured using the sample detector/power averaging method).

**SAMPLE CALCULATIONS - CONDUCTED EMISSIONS**

Receiver readings are compared directly to the conducted emissions specification limit (decibel form) as follows:

$$R_r - S = M$$

where:

$R_r$  = Receiver Reading in dBuV

S = Specification Limit in dBuV

M = Margin to Specification in +/- dB

**SAMPLE CALCULATIONS - RADIATED EMISSIONS**

Receiver readings are compared directly to the specification limit (decibel form). The receiver internally corrects for cable loss, preamplifier gain, and antenna factor. The calculations are in the reverse direction of the actual signal flow, thus cable loss is added and the amplifier gain is subtracted. The Antenna Factor converts the voltage at the antenna coaxial connector to the field strength at the antenna elements.

A distance factor, when used for electric field measurements above 30MHz, is calculated by using the following formula:

$$F_d = 20 * \text{LOG}_{10} (D_m/D_s)$$

where:

$F_d$  = Distance Factor in dB

$D_m$  = Measurement Distance in meters

$D_s$  = Specification Distance in meters

For electric field measurements below 30MHz the extrapolation factor is either determined by making measurements at multiple distances or a theoretical value is calculated using the formula:

$$F_d = 40 * \text{LOG}_{10} (D_m/D_s)$$

Measurement Distance is the distance at which the measurements were taken and Specification Distance is the distance at which the specification limits are based. The antenna factor converts the voltage at the antenna coaxial connector to the field strength at the antenna elements.

The margin of a given emission peak relative to the limit is calculated as follows:

$$R_c = R_r + F_d$$

and

$$M = R_c - L_s$$

where:

$R_r$  = Receiver Reading in dBuV/m

$F_d$  = Distance Factor in dB

$R_c$  = Corrected Reading in dBuV/m

$L_s$  = Specification Limit in dBuV/m

M = Margin in dB Relative to Spec

**SAMPLE CALCULATIONS - FIELD STRENGTH TO EIRP CONVERSION**

Where the radiated electric field strength is expressed in terms of the equivalent isotropic radiated power (eirp), or where a field strength measurement of output power is made in lieu of a direct measurement, the following formula is used to convert between eirp and field strength at a distance of d (meters) from the equipment under test:

$$E = \frac{1000000 \sqrt{30 P}}{d} \quad \text{microvolts per meter}$$

where P is the eirp (Watts)

For a measurement at 3m the conversion from a logarithmic value for field strength (dBuV/m) to an eirp power (dBm) is -95.3dB.



### Appendix A Test Equipment Calibration Data

<u>Manufacturer</u>	<u>Description</u>	<u>Model</u>	<u>Asset #</u>	<u>Calibrated</u>	<u>Cal Due</u>
<b>Radiated Emissions, 1000 - 6,000 MHz, 09-Apr-18</b>					
EMCO	Antenna, Horn, 1-18 GHz	3115	1561	7/8/2016	7/8/2018
Rohde & Schwarz	EMI Test Receiver, 20 Hz-40 GHz	ESI 40	2493	3/22/2018	3/22/2019
<b>Radiated Emissions, 1000 - 25,000 MHz, 09-Apr-18</b>					
EMCO	Antenna, Horn, 1-18 GHz	3115	1561	7/8/2016	7/8/2018
Micro-Tronics	Band Reject Filter, 2400-2500 MHz	BRM50702-02	1683	5/17/2017	5/17/2018
Hewlett Packard	Microwave Preamplifier, 1-26.5GHz	8449B	1780	8/31/2017	8/31/2018
Hewlett Packard	Spectrum Analyzer (SA40) Purple 9 kHz - 40 GHz,	8564E (84125C)	2415	2/16/2018	2/16/2019
HP / Miteq	SA40 P Head HF preAmplifier, 18-40 GHz (w/2415)	TTA1840-45-5P-HG-S	1772	9/14/2017	N/A
A. H. Systems	System Horn, 18-40GHz	SAS-574, p/n: 2581	2161	7/21/2017	7/21/2019
<b>Radiated Emissions, 30 - 1,000 MHz, 09-Apr-18</b>					
Sunol Sciences	Biconilog, 30-3000 MHz	JB3	1657	7/27/2016	7/27/2018
Rohde & Schwarz	EMI Test Receiver, 20 Hz-40 GHz	ESI 40	2493	3/22/2018	3/22/2019
Hewlett Packard	9KHz-1300MHz pre-amp	8447F	2777	12/27/2017	12/27/2018
<b>Radiated Spurious Emissions, 30 - 25,000 MHz, 10-Apr-18</b>					
National Technical Systems	NTS EMI Software (rev 2.10)	N/A	0		N/A
EMCO	Antenna, Horn, 1-18 GHz	3115	1561	7/8/2016	7/8/2018
Sunol Sciences	Biconilog, 30-3000 MHz	JB3	1657	7/27/2016	7/27/2018
Micro-Tronics	Band Reject Filter, 2400-2500 MHz	BRM50702-02	1683	5/17/2017	5/17/2018
Hewlett Packard	Microwave Preamplifier, 1-26.5GHz	8449B	1780	8/31/2017	8/31/2018
Hewlett Packard	Spectrum Analyzer (SA40) Purple 9 kHz - 40 GHz,	8564E (84125C)	2415	2/16/2018	2/16/2019
Rohde & Schwarz	EMI Test Receiver, 20 Hz-40 GHz	ESI 40	2493	3/22/2018	3/22/2019
Hewlett Packard	9KHz-1300MHz pre-amp	8447F	2777	12/27/2017	12/27/2018
<b>Radio Antenna Port (Power and Spurious Emissions), 11-Apr-18</b>					
National Technical Systems	NTS EMI Software (rev 2.10)	N/A	0		N/A
National Technical Systems	NTS Capture Analyzer Software (rev 3.8)	N/A	0		N/A
Agilent Technologies	PSA, Spectrum Analyzer, (installed options, 111, 115, 123, 1DS, B7J, HYG,	E4446A	2139	7/31/2017	7/31/2018
<b>Radiated Emissions, 1000 - 6,000 MHz, 11-Apr-18</b>					
Rohde & Schwarz	EMI Test Receiver, 20 Hz-40 GHz	ESI 40	2493	3/22/2018	3/22/2019



<u>Manufacturer</u>	<u>Description</u>	<u>Model</u>	<u>Asset #</u>	<u>Calibrated</u>	<u>Cal Due</u>
EMCO	Antenna, Horn, 1-18 GHz	3115	2870	8/24/2017	8/24/2019
<b>Radiated Emissions, 30 - 1,000 MHz, 11-Apr-18</b>					
Sunol Sciences	Biconilog, 30-3000 MHz	JB3	1657	7/27/2016	7/27/2018
Rohde & Schwarz	EMI Test Receiver, 20 Hz-40 GHz	ESI 40	2493	3/22/2018	3/22/2019
Hewlett Packard	9KHz-1300MHz pre-amp	8447F	2777	12/27/2017	12/27/2018
<b>Radiated Emissions, 1000 - 25000 MHz, 11-Apr-18</b>					
Hewlett Packard	Spectrum Analyzer (SA40) Red 30 Hz -40 GHz	8564E (84125C)	1148	10/14/2017	10/14/2018
Micro-Tronics	Band Reject Filter, 2400-2500 MHz	BRM50702-02	1683	5/17/2017	5/17/2018
HP / Miteq	SA40 P Head HF preAmplifier, 18-40 GHz (w/2415)	TTA1840-45-5P- HG-S	1772	9/14/2017	N/A
A. H. Systems	System Horn, 18-40GHz	SAS-574, p/n: 2581	2161	7/21/2017	7/21/2019
EMCO	Antenna, Horn, 1-18 GHz	3115	2870	8/24/2017	8/24/2019
<b>Conducted Emissions - AC Power Ports, 12-Apr-18</b>					
EMCO	LISN, 10 kHz-100 MHz	3825/2	1292	8/8/2017	8/8/2018
Rohde & Schwarz	Pulse Limiter	ESH3 Z2	1401	1/8/2018	1/8/2019
Rohde & Schwarz	EMI Test Receiver, 20 Hz-40 GHz	ESI 40	2493	3/22/2018	3/22/2019
<b>Radiated Spurious Emissions, 30 - 8,000 MHz, 12-Apr-18</b>					
National Technical Systems	NTS EMI Software (rev 2.10)	N/A	0		N/A
Hewlett Packard	Spectrum Analyzer (SA40) Red 30 Hz -40 GHz	8564E (84125C)	1148	10/14/2017	10/14/2018
Sunol Sciences	Biconilog, 30-3000 MHz	JB3	1657	7/27/2016	7/27/2018
Hewlett Packard	Microwave Preamplifier, 1-26.5GHz	8449B	2199	8/30/2017	8/30/2018
Rohde & Schwarz	EMI Test Receiver, 20 Hz-40 GHz	ESI 40	2493	3/22/2018	3/22/2019
Hewlett Packard	9KHz-1300MHz pre-amp	8447F	2777	12/27/2017	12/27/2018
EMCO	Antenna, Horn, 1-18 GHz	3115	2870	8/24/2017	8/24/2019
<b>Radiated Spurious Emissions, 1000 - 12,000 MHz, 13-Apr-18</b>					
National Technical Systems	NTS EMI Software (rev 2.10)	N/A	0		N/A
EMCO	Antenna, Horn, 1-18 GHz	3115	1561	7/8/2016	7/8/2018
Hewlett Packard	Microwave Preamplifier, 1-26.5GHz	8449B	1780	8/31/2017	8/31/2018
Micro-Tronics	Band Reject Filter, 2400-2500 MHz 18GHz	BRM50702-02	2238	5/17/2017	5/17/2018
Hewlett Packard	Spectrum Analyzer (SA40) Purple 9 kHz - 40 GHz,	8564E (84125C)	2415	2/16/2018	2/16/2019
Rohde & Schwarz	EMI Test Receiver, 20 Hz-40 GHz	ESI 40	2493	3/22/2018	3/22/2019
<b>Radiated Emissions, 1000 - 6,000 MHz, 13-Apr-18</b>					
EMCO	Antenna, Horn, 1-18 GHz	3115	1561	7/8/2016	7/8/2018
Rohde & Schwarz	EMI Test Receiver, 20 Hz-40 GHz	ESI 40	2493	3/22/2018	3/22/2019



<u>Manufacturer</u>	<u>Description</u>	<u>Model</u>	<u>Asset #</u>	<u>Calibrated</u>	<u>Cal Due</u>
<b>Radiated Emissions, 30 - 1,000 MHz, 13-Apr-18</b>					
Sunol Sciences	Biconilog, 30-3000 MHz	JB3	1657	7/27/2016	7/27/2018
Rohde & Schwarz	EMI Test Receiver, 20 Hz-40 GHz	ESI 40	2493	3/22/2018	3/22/2019
Hewlett Packard	9KHz-1300MHz pre-amp	8447F	2777	12/27/2017	12/27/2018
<b>Radiated Emissions, 9kHz - 30 MHz, 16-Apr-18</b>					
Rohde & Schwarz	EMI Test Receiver, 20 Hz-7 GHz	ESIB 7	1756	7/8/2017	7/8/2018
Compower	Magnetic Loop Antenna, 9 kHz-30 MHz	AL-130	3003	8/9/2016	8/9/2018
<b>Radiated Emissions, 30 - 150 MHz, 16-Apr-18</b>					
Sunol Sciences	Biconilog, 30-3000 MHz	JB3	1548	10/12/2016	10/12/2018
Com-Power	Preamplifier, 30-1000 MHz	PA-103	1632	1/30/2018	1/30/2019
Rohde & Schwarz	EMI Test Receiver, 20 Hz-7 GHz	ESIB 7	1756	7/8/2017	7/8/2018
<b>Radiated Emissions, 9kHz - 30 MHz, 17-Apr-18</b>					
Rohde & Schwarz	EMI Test Receiver, 20 Hz-40 GHz	ESI 40	2493	3/22/2018	3/22/2019
Compower	Magnetic Loop Antenna, 9 kHz-30 MHz	AL-130	3003	8/9/2016	8/9/2018
<b>Radiated Emissions, 30 - 150 MHz, 17-Apr-18</b>					
Sunol Sciences	Biconilog, 30-3000 MHz	JB3	1657	7/27/2016	7/27/2018
Rohde & Schwarz	EMI Test Receiver, 20 Hz-40 GHz	ESI 40	2493	3/22/2018	3/22/2019
Hewlett Packard	9KHz-1300MHz pre-amp	8447F	2777	12/27/2017	12/27/2018
<b>Frequency Stability and Occupied Bandwidth, 24-Apr-18</b>					
Agilent Technologies	PSA, Spectrum Analyzer, (installed options, 111, 115, 123, 1DS, B7J, HYX,	E4446A	2139	7/31/2017	7/31/2018
Watlow	Temp Chamber (w/ F4 watlow Controller)	96A0	2171	7/7/2017	7/7/2018

## **Appendix B Test Data**

T106007 Pages 29 – 59



## EMC Test Data

Client:	Fitbit, Inc.	Job Number:	JD105947
Product:	FB410	T-Log Number:	T106007
System Configuration:	-	Project Manager:	Deepa Shetty
Contact:	Ricky Wang	Project Coordinator:	-
Emissions Standard(s):	FCC 15.247, 15.209 / RSS-247, RSS-210 / LP0002	Class:	-
Immunity Standard(s):	-	Environment:	-

# EMC Test Data

For The

**Fitbit, Inc.**

Product

FB410

Date of Last Test: 4/17/2018



# EMC Test Data

Client:	Fitbit, Inc.	PR Number:	JD105947
Model:	FB410	T-Log Number:	T106007
Contact:	Ricky Wang	Project Manager:	Deepa Shetty
Standard:	FCC 15.247, 15.209 / RSS-247, RSS-210 / LP0002	Project Engineer:	-
		Class:	-

## Conducted Emissions

*(NTS Silicon Valley, Fremont Facility, Semi-Anechoic Chamber)*

### Test Specific Details

Objective: The objective of this test session is to perform final qualification testing of the EUT with respect to the specification listed above.

Date of Test: 4/12/2018  
 Test Engineer: Rafael Varelas  
 Test Location: FT Chamber #7

Config. Used: 1  
 Config Change: None  
 EUT Voltage: See Individual Runs

### General Test Configuration

For tabletop equipment, the EUT was located on a wooden table inside the semi-anechoic chamber, 40 cm from a vertical coupling plane and 80cm from the LISN.

**Ambient Conditions:**  
 Temperature: 22.4 °C  
 Rel. Humidity: 38 %

### Summary of Results

Run #	Test Performed	Limit	Result	Margin
1	CE, AC Power,110V/60Hz	Class B	Pass	33.1 dBµV @ 0.40 MHz(-24.6 dB)
2	CE, AC Power,220V/60Hz	Class B	Pass	35.5 dBµV @ 0.48 MHz(-20.7 dB)

### Modifications Made During Testing

No modifications were made to the EUT during testing

### Deviations From The Standard

No deviations were made from the requirements of the standard.

### Sample Notes

Sample S/N: B2-SAT2-279A-C43  
 Driver: 1.5.9615  
 Antenna: internal

### Notes:

EUT configured to transmit on channel 19 at power setting Max



# EMC Test Data

Client: Fitbit, Inc.	PR Number: JD105947
Model: FB410	T-Log Number: T106007
Contact: Ricky Wang	Project Manager: Deepa Shetty
Standard: FCC 15.247, 15.209 / RSS-247, RSS-210 / LP0002	Project Engineer: -
	Class: -

Run #1: AC Power Port Conducted Emissions, 0.15 - 30MHz, 110V/60Hz

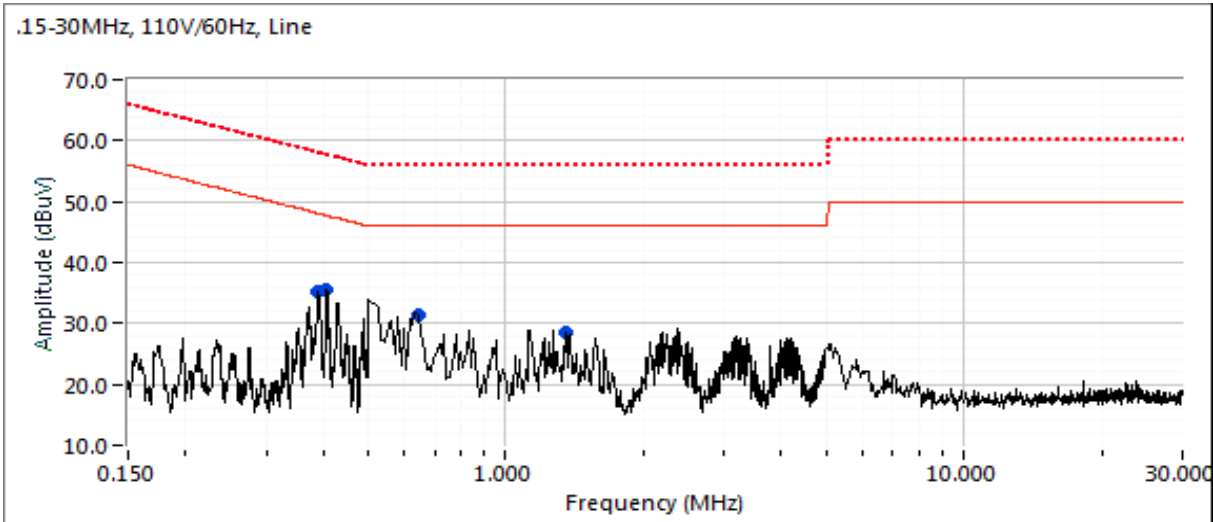
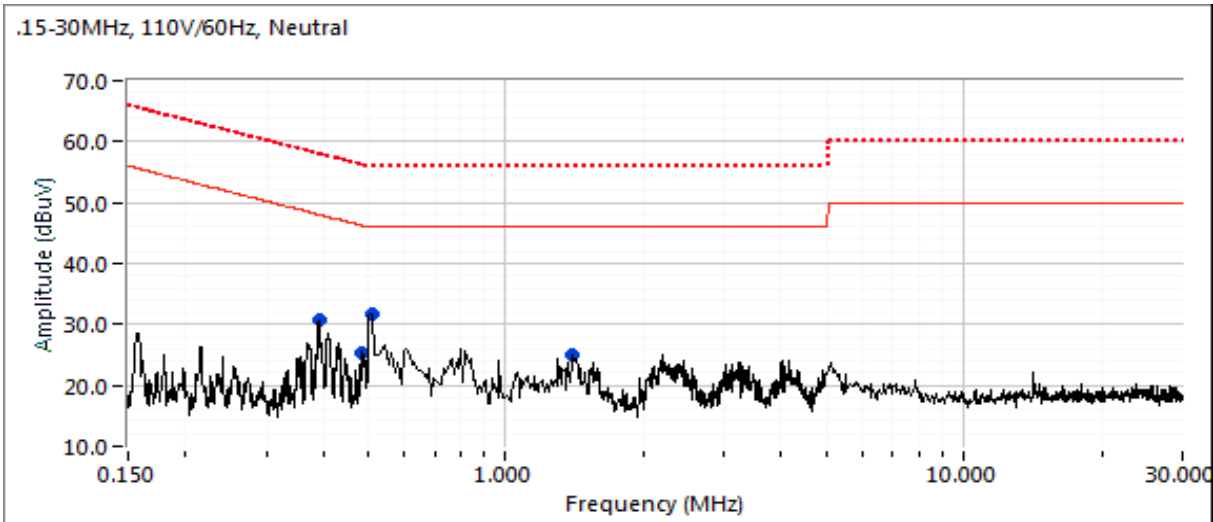



# EMC Test Data

Client: Fitbit, Inc.	PR Number: JD105947
Model: FB410	T-Log Number: T106007
Contact: Ricky Wang	Project Manager: Deepa Shetty
Standard: FCC 15.247, 15.209 / RSS-247, RSS-210 / LP0002	Project Engineer: -
	Class: -

**Preliminary peak readings captured during pre-scan (peak readings vs. average limit)**

Frequency MHz	Level dB $\mu$ V	AC Line	Class B		Detector QP/Ave	Comments
			Limit	Margin		
0.388	30.8	Neutral	48.0	-17.2	Peak	
0.487	25.4	Neutral	46.2	-20.8	Peak	
0.522	31.6	Neutral	46.0	-14.4	Peak	
1.416	24.9	Neutral	46.0	-21.1	Peak	
0.389	35.3	Line 1	48.1	-12.8	Peak	
0.406	35.6	Line 1	47.7	-12.1	Peak	
0.602	31.5	Line 1	46.0	-14.5	Peak	
1.305	28.5	Line 1	46.0	-17.5	Peak	

**Final quasi-peak and average readings**

Frequency MHz	Level dB $\mu$ V	AC Line	Class B		Detector QP/Ave	Comments
			Limit	Margin		
0.406	33.1	Line 1	57.7	-24.6	QP	QP (1.00s)
0.406	21.6	Line 1	47.7	-26.1	AVG	AVG (0.10s)
0.389	21.9	Line 1	48.1	-26.2	AVG	AVG (0.10s)
0.389	31.8	Line 1	58.1	-26.3	QP	QP (1.00s)
0.602	28.3	Line 1	56.0	-27.7	QP	QP (1.00s)
0.388	19.8	Neutral	48.1	-28.3	AVG	AVG (0.10s)
0.602	17.7	Line 1	46.0	-28.3	AVG	AVG (0.10s)
0.522	16.6	Neutral	46.0	-29.4	AVG	AVG (0.10s)
0.522	25.7	Neutral	56.0	-30.3	QP	QP (1.00s)
0.487	15.6	Neutral	46.2	-30.6	AVG	AVG (0.10s)
0.388	26.5	Neutral	58.1	-31.6	QP	QP (1.00s)
0.487	24.2	Neutral	56.2	-32.0	QP	QP (1.00s)
1.305	21.6	Line 1	56.0	-34.4	QP	QP (1.00s)
1.416	10.5	Neutral	46.0	-35.5	AVG	AVG (0.10s)
1.416	19.2	Neutral	56.0	-36.8	QP	QP (1.00s)
1.305	8.9	Line 1	46.0	-37.1	AVG	AVG (0.10s)





# EMC Test Data

Client: Fitbit, Inc.	PR Number: JD105947
Model: FB410	T-Log Number: T106007
Contact: Ricky Wang	Project Manager: Deepa Shetty
Standard: FCC 15.247, 15.209 / RSS-247, RSS-210 / LP0002	Project Engineer: -
	Class: -

Run #2: AC Power Port Conducted Emissions, 0.15 - 30MHz, 220V/60Hz

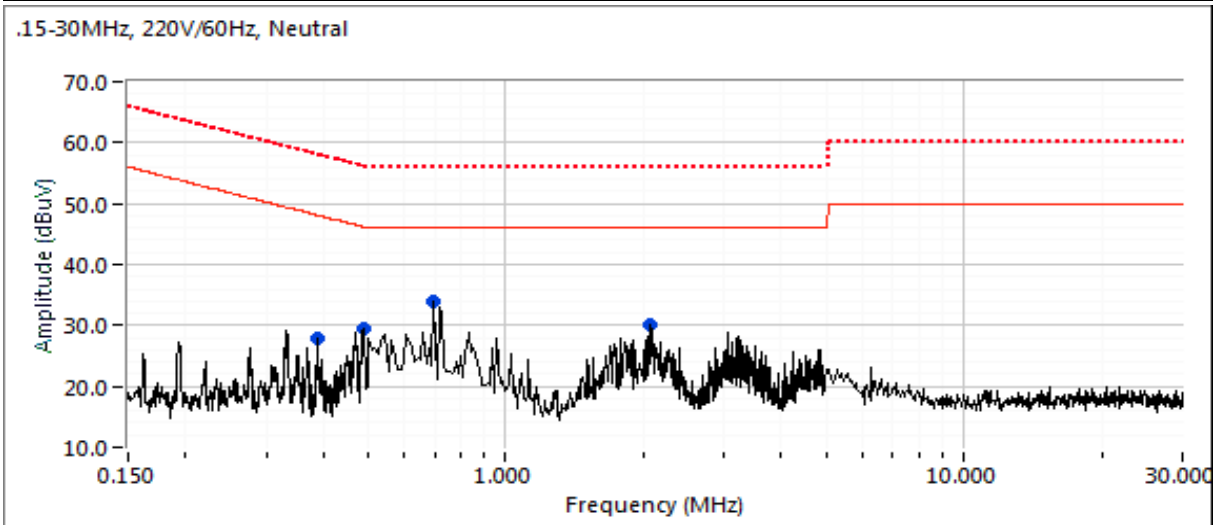
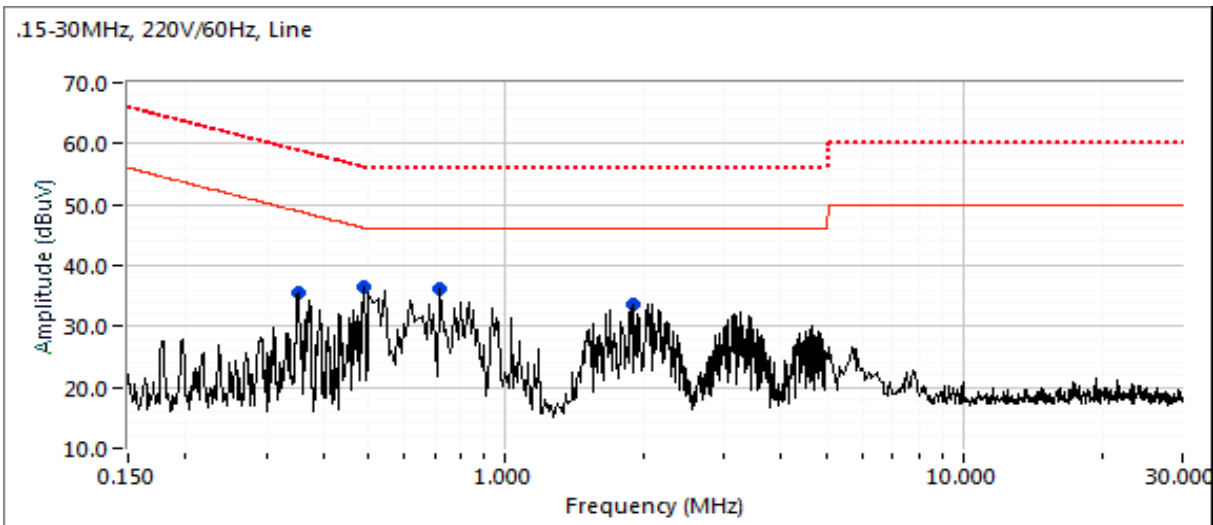



# EMC Test Data

Client: Fitbit, Inc.	PR Number: JD105947
Model: FB410	T-Log Number: T106007
Contact: Ricky Wang	Project Manager: Deepa Shetty
Standard: FCC 15.247, 15.209 / RSS-247, RSS-210 / LP0002	Project Engineer: -
	Class: -

### Preliminary peak readings captured during pre-scan (peak readings vs. average limit)

Frequency MHz	Level dB $\mu$ V	AC Line	Class B		Detector QP/Ave	Comments
			Limit	Margin		
0.352	35.6	Line 1	48.9	-13.3	Peak	
0.486	36.5	Line 1	46.2	-9.7	Peak	
0.698	36.1	Line 1	46.0	-9.9	Peak	
1.885	33.5	Line 1	46.0	-12.5	Peak	
0.392	27.9	Neutral	48.1	-20.2	Peak	
0.487	29.4	Neutral	46.2	-16.8	Peak	
0.700	34.0	Neutral	46.0	-12.0	Peak	
2.043	30.2	Neutral	46.0	-15.8	Peak	

### Final quasi-peak and average readings

Frequency MHz	Level dB $\mu$ V	AC Line	Class B		Detector QP/Ave	Comments
			Limit	Margin		
0.486	35.5	Line 1	56.2	-20.7	QP	QP (1.00s)
0.697	30.4	Line 1	56.0	-25.6	QP	QP (1.00s)
0.487	29.6	Neutral	56.2	-26.6	QP	QP (1.00s)
1.885	28.9	Line 1	56.0	-27.1	QP	QP (1.00s)
0.486	18.2	Line 1	46.2	-28.0	AVG	AVG (0.10s)
0.352	30.8	Line 1	58.9	-28.1	QP	QP (1.00s)
0.700	26.8	Neutral	56.0	-29.2	QP	QP (1.00s)
0.487	15.1	Neutral	46.2	-31.1	AVG	AVG (0.10s)
0.697	14.0	Line 1	46.0	-32.0	AVG	AVG (0.10s)
2.043	23.4	Neutral	56.0	-32.6	QP	QP (1.00s)
0.700	13.3	Neutral	46.0	-32.7	AVG	AVG (0.10s)
1.885	12.9	Line 1	46.0	-33.1	AVG	AVG (0.10s)
0.352	15.0	Line 1	48.9	-33.9	AVG	AVG (0.10s)
0.392	13.1	Neutral	48.0	-34.9	AVG	AVG (0.10s)
2.043	11.0	Neutral	46.0	-35.0	AVG	AVG (0.10s)
0.392	22.4	Neutral	58.0	-35.6	QP	QP (1.00s)



# EMC Test Data

Client: Fitbit, Inc.	Job Number: JD105947
Model: FB410	T-Log Number: T106007
	Project Manager: Deepa Shetty
Contact: Ricky Wang	Project Coordinator: -
Standard: FCC 15.247, 15.209 / RSS-247, RSS-210 / LP0002	Class: N/A

## RSS-247 and FCC 15.247 (DTS) Radiated Spurious Emissions

### Test Specific Details

Objective: The objective of this test session is to perform final qualification testing of the EUT with respect to the specification listed above.

### General Test Configuration

The EUT and all local support equipment were located on the turntable for radiated spurious emissions testing. For radiated emissions testing the measurement antenna was located 3 meters from the EUT, unless otherwise noted.

**Ambient Conditions:** Temperature: 21.8 °C  
Rel. Humidity: 41 %

### Summary of Results - Device Operating in the 2400-2483.5 MHz Band

Run #	Mode	Channel	Target Power	Power Setting	Test Performed	Limit	Result / Margin
1	BLE	2402MHz	Max	Max	Restricted Band Edge (2390 MHz)	FCC Part 15.209 / 15.247( c)	34.7 dBµV/m @ 2389.6 MHz (-19.3 dB)
	BLE	2480MHz	Max	Max	Restricted Band Edge (2483.5 MHz)	FCC Part 15.209 / 15.247( c)	38.3 dBµV/m @ 2483.5 MHz (-15.7 dB)

### Modifications Made During Testing

No modifications were made to the EUT during testing

### Deviations From The Standard

No deviations were made from the requirements of the standard.

### Sample Notes

Sample S/N: B2-SAT2-279A-C43  
Driver: 1.5.9615  
Antenna: internal



# EMC Test Data

Client: Fitbit, Inc.	Job Number: JD105947
Model: FB410	T-Log Number: T106007
	Project Manager: Deepa Shetty
Contact: Ricky Wang	Project Coordinator: -
Standard: FCC 15.247, 15.209 / RSS-247, RSS-210 / LP0002	Class: N/A

## Procedure Comments:

Measurements performed in accordance with FCC KDB 558074

Peak measurements performed with: RBW=1MHz, VBW=3MHz, peak detector, max hold, auto sweep time

Unless otherwise stated/noted, emission has a duty cycle  $\geq 98\%$  and was measured using RBW=1MHz, VBW=10Hz, peak detector, linear average mode, auto sweep time, max hold.

Mode	Data Rate	Duty Cycle (x)	Constant DC?	T (ms)	Pwr Cor Factor*	Lin Volt Cor Factor**	Min VBW for FS (Hz)
BLE	1Mbps	85.6%	Yes	2.145	0.68	1.35	466

## Measurement Specific Notes:

Note 1:	Emission in non-restricted band, but limit of 15.209 used.
Note 2:	Emission in non-restricted band, the limit was set 30dB below the level of the fundamental and measured in 100kHz.
Note 3:	Emission has a duty cycle $\geq 98\%$ , average measurement performed: RBW=1MHz, VBW=3MHz, RMS, Power averaging, auto sweep, trace average 100 traces
Note 4:	Emission has constant duty cycle $< 98\%$ , average measurement performed: RBW=1MHz, VBW> $> 1/T$ but not less than 10Hz, peak detector, linear averaging, auto sweep, trace average 100 traces, measurement corrected by Linear voltage correction factor
Note 5:	Emission has constant duty cycle $< 98\%$ , average measurement performed: RBW=1MHz, VBW=3MHz, RMS, Power averaging, auto sweep, trace average 100 traces, measurement corrected by Pwr correction factor
Note 6:	Emission has non constant duty cycle $< 98\%$ , average measurement performed: RBW=1MHz, VBW> $> 1/T$ , peak detector, linear average mode, sweep time auto, max hold. Max hold for $50 \cdot (1/DC)$ traces
Note 7:	Emission has non constant duty cycle $< 98\%$ , average measurement performed: RBW=1MHz, VBW> $> 1/T$ , RMS detector, sweep time auto, max hold. Max hold for $50 \cdot (1/DC)$ traces
Note 8:	Plots of the average and peak bandedge do not account for any duty cycle correction. Refer to the tabular results for final measurements.



# EMC Test Data

Client: Fitbit, Inc.	Job Number: JD105947
Model: FB410	T-Log Number: T106007
	Project Manager: Deepa Shetty
Contact: Ricky Wang	Project Coordinator: -
Standard: FCC 15.247, 15.209 / RSS-247, RSS-210 / LP0002	Class: N/A

### Run #1: Radiated Bandedge Measurements

Date of Test: 4/11/18  
 Test Engineer: Rafael Varelas  
 Test Location: Chamber #7

Config. Used: 1  
 Config Change: -  
 EUT Voltage: 120V/ 60Hz

Channel: 2402MHz  
 Tx Chain: Main

Mode: BLE  
 Data Rate: 1Mbps

Orientation: Flat

### Band Edge Signal Field Strength - Direct measurement of field strength

Frequency MHz	Level dB $\mu$ V/m	Pol v/h	15.209 / 15.247		Detector Pk/QP/Avg	Azimuth degrees	Height meters	Comments
			Limit	Margin				
2389.570	34.7	H	54.0	-19.3	RMS	360	1.0	RMS Vavg;100; RB 1 MHz; VB: 3 MHz
2389.990	45.9	H	74.0	-28.1	PK	360	1.0	POS; RB 1 MHz; VB: 3 MHz
2389.570	34.6	V	54.0	-19.4	RMS	357	1.0	RMS Vavg;100; RB 1 MHz; VB: 3 MHz
2389.770	45.4	V	74.0	-28.6	PK	357	1.0	POS; RB 1 MHz; VB: 3 MHz

RB 1 MHz; VB 3 MHz Avg=Black Trace; PK=Blue Trace; H

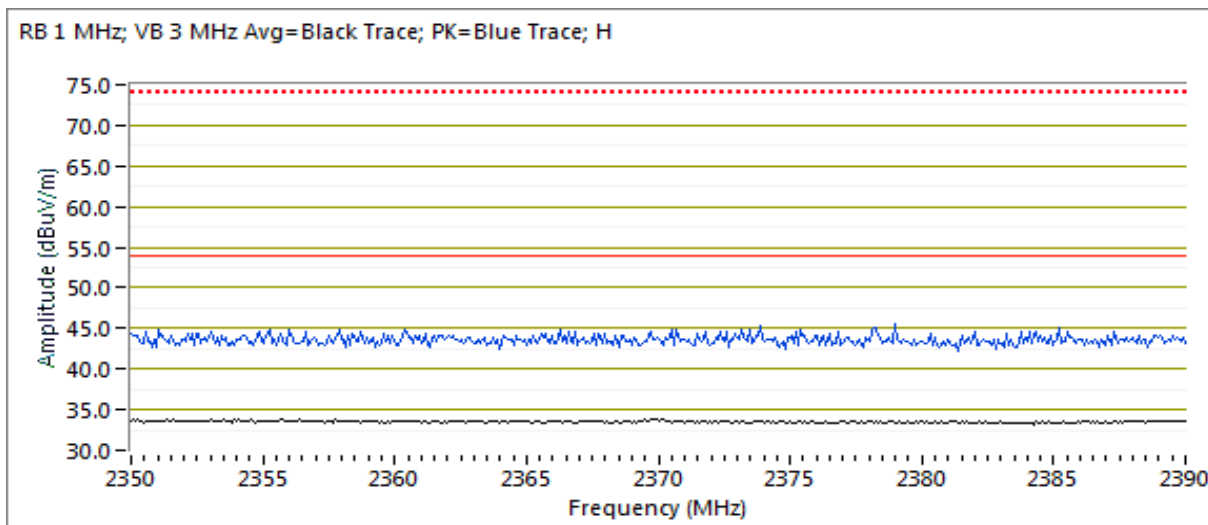



# EMC Test Data

Client: Fitbit, Inc.	Job Number: JD105947
Model: FB410	T-Log Number: T106007
Contact: Ricky Wang	Project Manager: Deepa Shetty
Standard: FCC 15.247, 15.209 / RSS-247, RSS-210 / LP0002	Project Coordinator: -
	Class: N/A

Channel: 2480MHz      Mode: BLE      Orientation: Flat  
 Tx Chain: Main      Data Rate: 1Mbps

### Band Edge Signal Field Strength - Direct measurement of field strength

Frequency MHz	Level dB $\mu$ V/m	Pol v/h	15.209 / 15.247		Detector PK/QP/Avg	Azimuth degrees	Height meters	Comments
			Limit	Margin				
2483.500	38.3	H	54.0	-15.7	RMS	178	1.6	RMS Vavg:100; RB 1 MHz; VB: 3 MHz
2483.500	55.8	H	74.0	-18.2	PK	178	1.6	POS; RB 1 MHz; VB: 3 MHz
2483.560	37.7	V	54.0	-16.3	RMS	133	1.8	RMS Vavg:100; RB 1 MHz; VB: 3 MHz
2483.690	54.6	V	74.0	-19.4	PK	133	1.8	POS; RB 1 MHz; VB: 3 MHz

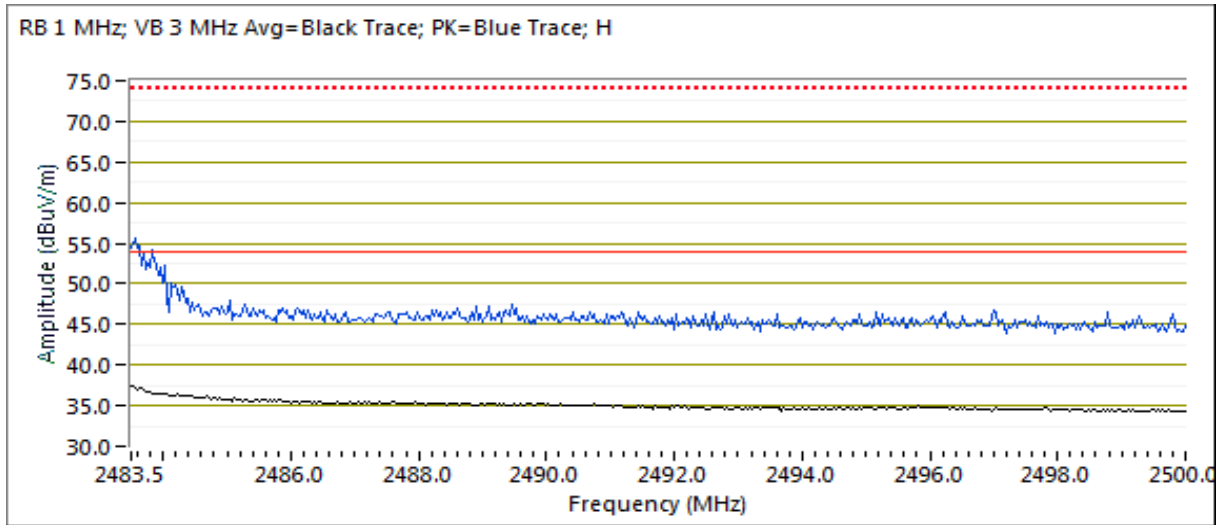



# EMC Test Data

Client: Fitbit, Inc.	Job Number: JD105947
Model: FB410	T-Log Number: T106007
	Project Manager: Deepa Shetty
Contact: Ricky Wang	Project Coordinator: -
Standard: FCC 15.247, 15.209 / RSS-247, RSS-210 / LP0002	Class: N/A

## RSS-247 and FCC 15.247 (DTS) Radiated Spurious Emissions

### Test Specific Details

Objective: The objective of this test session is to perform final qualification testing of the EUT with respect to the specification listed above.

### General Test Configuration

The EUT and all local support equipment were located on the turntable for radiated spurious emissions testing.

For radiated emissions testing the measurement antenna was located 3 meters from the EUT, unless otherwise noted.

### Ambient Conditions:

Temperature: 21.8 °C  
Rel. Humidity: 41 %

### Summary of Results - Device Operating in the 2400-2483.5 MHz Band

Run #	Mode	Channel	Target Power	Power Setting	Test Performed	Limit	Result / Margin
1	BLE	2402MHz	Max	Max	Radiated Emissions, 1 - 25 GHz	FCC Part 15.209 / 15.247( c)	36.9 dBµV/m @ 4824.9 MHz (-17.2 dB)
	BLE	2440MHz	Max	Max	Radiated Emissions, 1 - 25 GHz	FCC Part 15.209 / 15.247( c)	36.4 dBµV/m @ 4881.2 MHz (-17.7 dB)
	BLE	2480MHz	Max	Max	Radiated Emissions, 1 - 25 GHz	FCC Part 15.209 / 15.247( c)	35.8 dBµV/m @ 4959.8 MHz (-18.3 dB)
2	BLE	2402MHz	Max	Max	Radiated Emissions, 30-1000MHz	FCC Part 15.209 / 15.247( c)	26.1 dBµV/m @ 75.08 MHz (-13.9 dB)
	BLE	2480MHz	Max	Max	Radiated Emissions, 30-1000MHz	FCC Part 15.209 / 15.247( c)	27.8 dBµV/m @ 76.48 MHz (-12.2 dB)

### Modifications Made During Testing

No modifications were made to the EUT during testing

### Deviations From The Standard

No deviations were made from the requirements of the standard.



# EMC Test Data

Client: Fitbit, Inc.	Job Number: JD105947
Model: FB410	T-Log Number: T106007
	Project Manager: Deepa Shetty
Contact: Ricky Wang	Project Coordinator: -
Standard: FCC 15.247, 15.209 / RSS-247, RSS-210 / LP0002	Class: N/A

### Sample Notes

Sample S/N: B2-SAT2-279A-C43  
 Driver: 1.5.9615  
 Antenna: internal

### Procedure Comments:

Measurements performed in accordance with FCC KDB 558074  
 Peak measurements performed with: RBW=1MHz, VBW=3MHz, peak detector, max hold, auto sweep time  
 Unless otherwise stated/noted, emission has duty cycle  $\geq 98\%$  and was measured using RBW=1MHz, VBW=10Hz, peak detector, linear average mode, auto sweep time, max hold.  
 2.4GHz band reject filter used

Mode	Data Rate	Duty Cycle (x)	Constant DC?	T (ms)	Pwr Cor Factor*	Lin Volt Cor Factor**	Min VBW for FS (Hz)
BLE	1Mbps	85.6%	Yes	2.145	0.68	1.35	466

### Measurement Specific Notes:

Note 1:	Emission in non-restricted band, but limit of 15.209 used.
Note 2:	Emission in non-restricted band, the limit was set 30dB below the level of the fundamental and measured in 100kHz.
Note 4:	Emission has constant duty cycle $< 98\%$ , average measurement performed: RBW=1MHz, VBW>1/T but not less than 10Hz, peak detector, linear averaging, auto sweep, trace average 100 traces, measurement corrected by Linear voltage correction factor





# EMC Test Data

Client: Fitbit, Inc.	Job Number: JD105947
Model: FB410	T-Log Number: T106007
	Project Manager: Deepa Shetty
Contact: Ricky Wang	Project Coordinator: -
Standard: FCC 15.247, 15.209 / RSS-247, RSS-210 / LP0002	Class: N/A

Run #0: Fundamental Field Strength, to determine worst case orientation.

Date of Test: 4/10/18  
 Test Engineer: John Caizzi  
 Test Location: Chamber #7

Config. Used: 1  
 Config Change: -  
 EUT Voltage: 120V/ 60Hz

Channel: 2402 MHz      Mode: dB below the level of the      Average Measurement: Note 5 method was used  
 Tx Chain: Main      Data Rate: 0

EUT SN: **B2-SAT2-279A-C43**      FW:

Frequency	Level	Pol			Detector	Azimuth	Height	Comments
MHz	dBuV/m	V/H			Pk/QP/Avg	degrees	meters	Orientation Upright
2402.110	92.6	H	-	-	RMS	118	1.23	Vavg 100, RB 1 MHz, VB: 3 MHz
2401.710	96.3	H	-	-	PK	118	1.23	
2402.110	89.4	V	-	-	RMS	347	1.72	Vavg 100, RB 1 MHz, VB: 3 MHz
2402.210	93.4	V	-	-	PK	347	1.72	

Frequency	Level	Pol			Detector	Azimuth	Height	Comments
MHz	dBuV/m	V/H			Pk/QP/Avg	degrees	meters	Orientation Side
2402.110	88.4	V	-	-	RMS	124	2.46	Vavg 100, RB 1 MHz, VB: 3 MHz
2401.730	92.4	V	-	-	PK	124	2.46	
2402.110	91.7	H	-	-	RMS	176	1.06	Vavg 100, RB 1 MHz, VB: 3 MHz
2402.250	95.9	H	-	-	PK	176	1.06	

Frequency	Level	Pol			Detector	Azimuth	Height	Comments
MHz	dBuV/m	V/H			Pk/QP/Avg	degrees	meters	Orientation Flat
2402.030	89.7	H	-	-	RMS	136	1.03	Vavg 100, RB 1 MHz, VB: 3 MHz
2402.210	93.1	H	-	-	PK	136	1.03	
2402.110	93.1	V	-	-	RMS	186	1.34	Vavg 100, RB 1 MHz, VB: 3 MHz
2402.030	96.1	V	-	-	PK	186	1.34	



# EMC Test Data

Client: Fitbit, Inc.	Job Number: JD105947
Model: FB410	T-Log Number: T106007
Contact: Ricky Wang	Project Manager: Deepa Shetty
Standard: FCC 15.247, 15.209 / RSS-247, RSS-210 / LP0002	Project Coordinator: -
	Class: N/A

EUT SN: **B2-SAT2-279A-C43** FW: **1.5.9615**

Frequency	Level	Pol			Detector	Azimuth	Height	Comments
MHz	dBuV/m	V/H			Pk/QP/Avg	degrees	meters	Orientation Flat
2402.110	93.1	V			RMS	186	1.34	Vavg 100, RB 1 MHz, VB: 3 MHz
2402.030	96.1	V			PK	186	1.34	

EUT SN: **B2-SAT2-405A-C43** FW: **1.5.9615**

Frequency	Level	Pol			Detector	Azimuth	Height	Comments
MHz	dBuV/m	V/H			Pk/QP/Avg	degrees	meters	Orientation Flat
2402.110	91.8	V			RMS	197	1.32	Vavg 100, RB 1 MHz, VB: 3 MHz
2402.250	94.0	V			PK	197	1.32	

EUT SN: **B2-SAT2-275A-C43** FW: **1.5.9615**

Frequency	Level	Pol			Detector	Azimuth	Height	Comments
MHz	dBuV/m	V/H			Pk/QP/Avg	degrees	meters	Orientation Flat
2402.110	89.9	V	54.0	35.2	RMS	195	1.38	Vavg 100, RB 1 MHz, VB: 3 MHz
2401.770	93.3	V	74.0	19.3	PK	195	1.38	

EUT SN: **B2-SAT2-275A-C43** FW: **1.5.9615**

Frequency	Level	Pol			Detector	Azimuth	Height	Comments
MHz	dBuV/m	V/H			Pk/QP/Avg	degrees	meters	Orientation Flat
2402.110	90.7	V	54.0	36.0	RMS	192	1.36	Vavg 100, RB 1 MHz, VB: 3 MHz
2402.250	94.0	V	74.0	20.0	PK	192	1.36	



# EMC Test Data

Client: Fitbit, Inc.	Job Number: JD105947
Model: FB410	T-Log Number: T106007
	Project Manager: Deepa Shetty
Contact: Ricky Wang	Project Coordinator: -
Standard: FCC 15.247, 15.209 / RSS-247, RSS-210 / LP0002	Class: N/A

Run #1: Radiated Spurious Emissions, 1,000 - 25000 MHz. Operating Mode: BLE

Date of Test: 4/11/18  
 Test Engineer: Rafael Varelas  
 Test Location: Chamber #7

Config. Used: 1  
 Config Change: -  
 EUT Voltage: 120V/ 60Hz

Run #1a: Low Channel

Channel: 2402MHz Mode: BLE Orientation: Flat  
 Tx Chain: Main Data Rate: 1Mbps

Frequency	Level	Pol	15.209 / 15.247		Detector	Azimuth	Height	Comments
MHz	dB $\mu$ V/m	v/h	Limit	Margin	Pk/QP/Avg	degrees	meters	
4824.920	36.9	H	54.0	-17.2	Avg	76	1.2	Note 4, RB 1 MHz; VB 1 kHz; Peak VA
4823.010	47.8	H	74.0	-26.2	PK	76	1.2	RB 1 MHz; VB 3 MHz; Peak

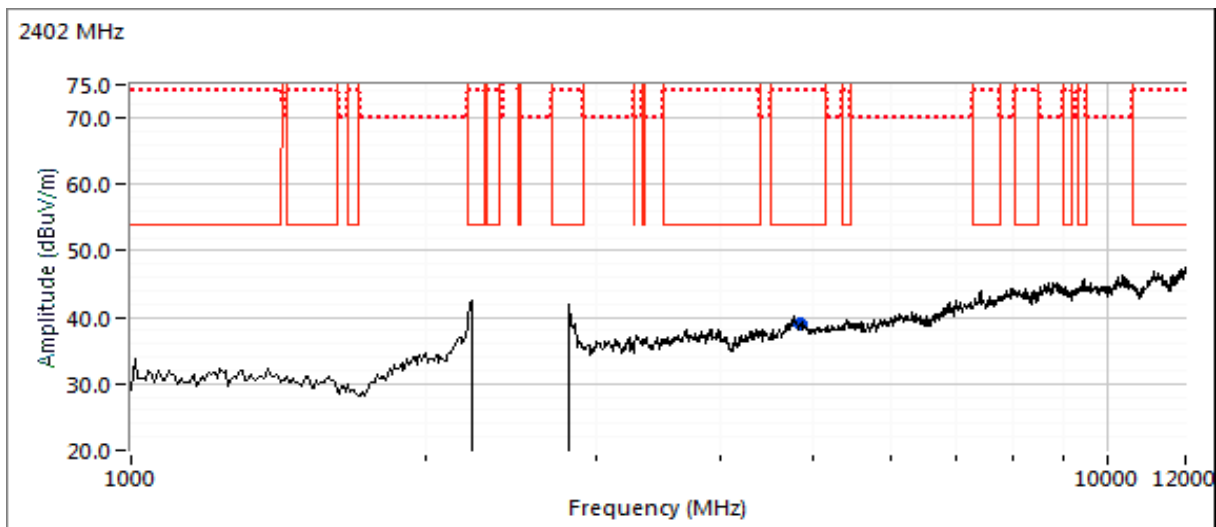

Client: Fitbit, Inc.	Job Number: JD105947
Model: FB410	T-Log Number: T106007
	Project Manager: Deepa Shetty
Contact: Ricky Wang	Project Coordinator: -
Standard: FCC 15.247, 15.209 / RSS-247, RSS-210 / LP0002	Class: N/A

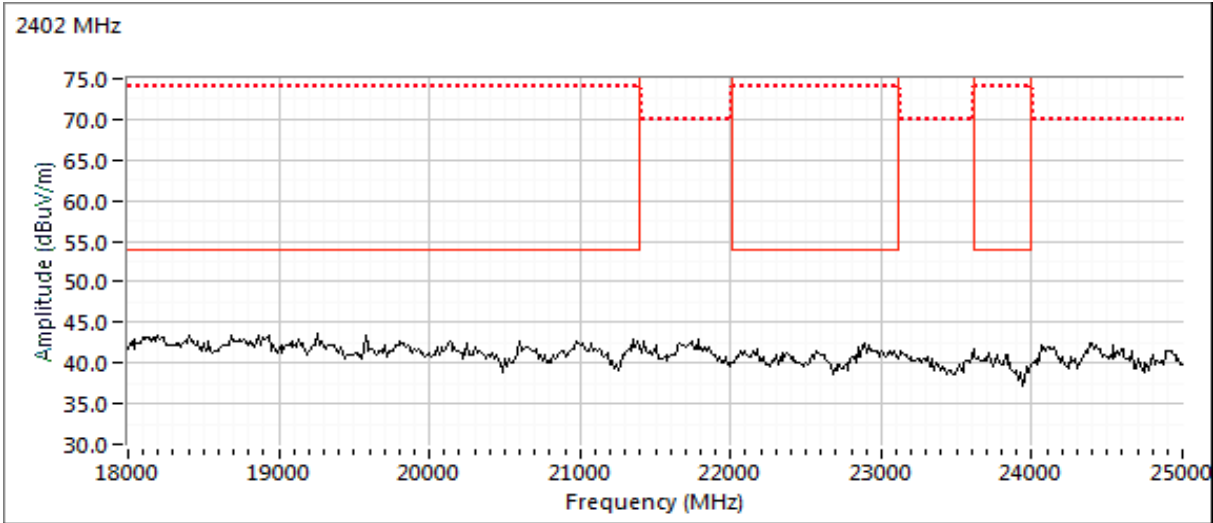
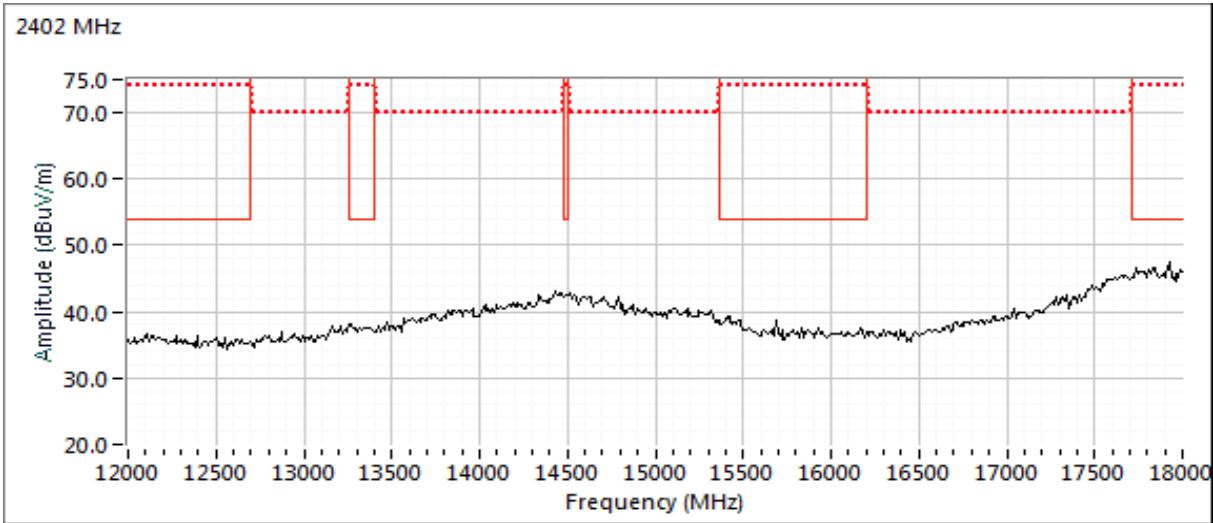



# EMC Test Data

Client: Fitbit, Inc.	Job Number: JD105947
Model: FB410	T-Log Number: T106007
Contact: Ricky Wang	Project Manager: Deepa Shetty
Standard: FCC 15.247, 15.209 / RSS-247, RSS-210 / LP0002	Project Coordinator: -
	Class: N/A

## Run #1b: Center Channel

Channel: 2440MHz      Mode: BLE      Orientation: Flat  
 Tx Chain: Main      Data Rate: 1Mbps

Frequency	Level	Pol	15.209 / 15.247		Detector	Azimuth	Height	Comments
MHz	dB $\mu$ V/m	v/h	Limit	Margin	Pk/QP/Avg	degrees	meters	
4881.230	36.4	V	54.0	-17.7	Avg	360	1.7	Note 4, RB 1 MHz; VB 1 kHz; Peak VA
4881.710	47.9	V	74.0	-26.1	PK	360	1.7	RB 1 MHz; VB 3 MHz; Peak

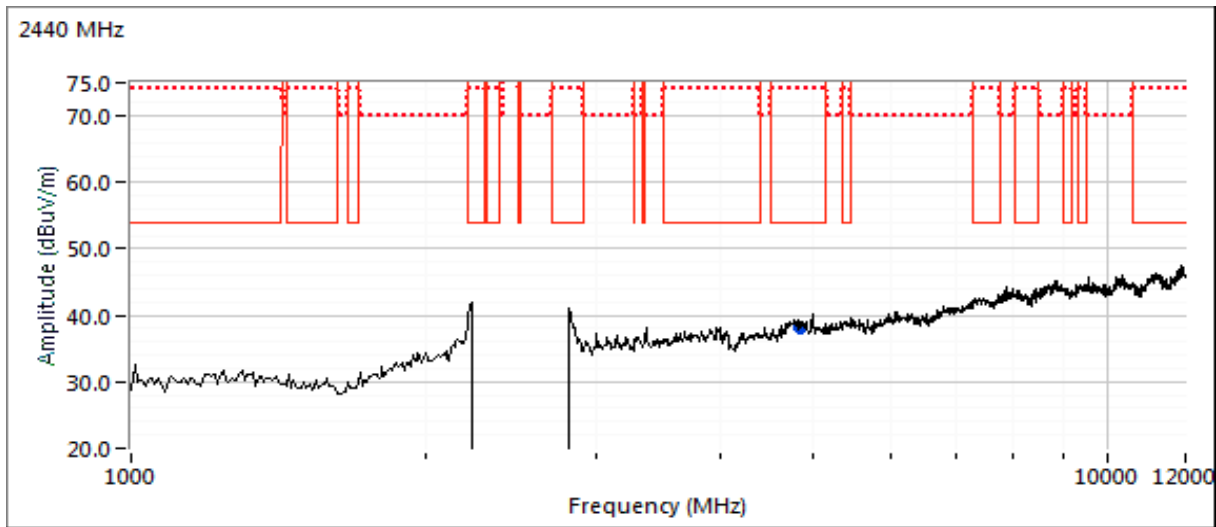

Client: Fitbit, Inc.	Job Number: JD105947
Model: FB410	T-Log Number: T106007
	Project Manager: Deepa Shetty
Contact: Ricky Wang	Project Coordinator: -
Standard: FCC 15.247, 15.209 / RSS-247, RSS-210 / LP0002	Class: N/A

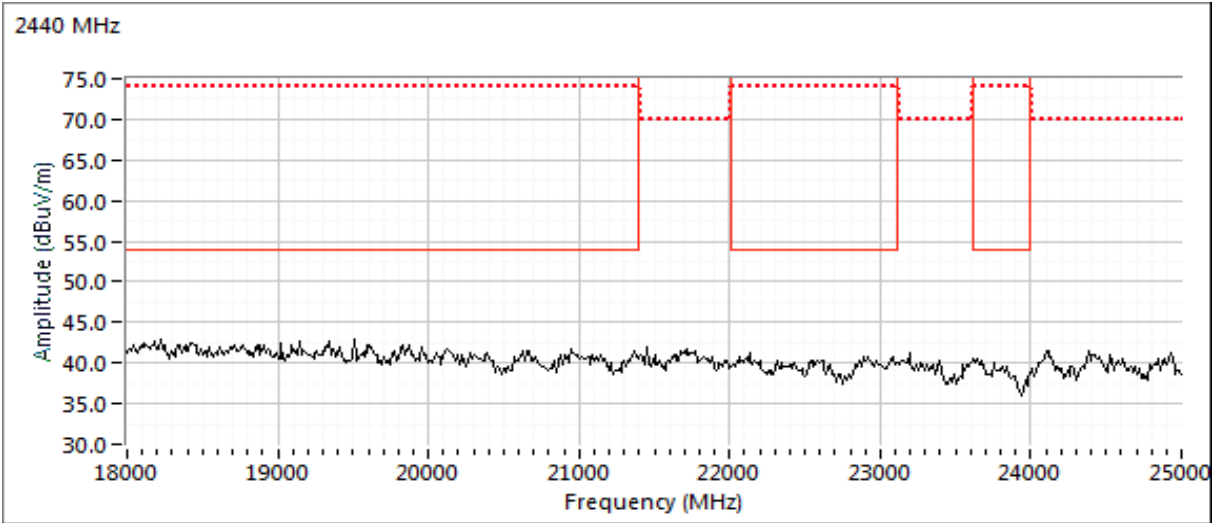
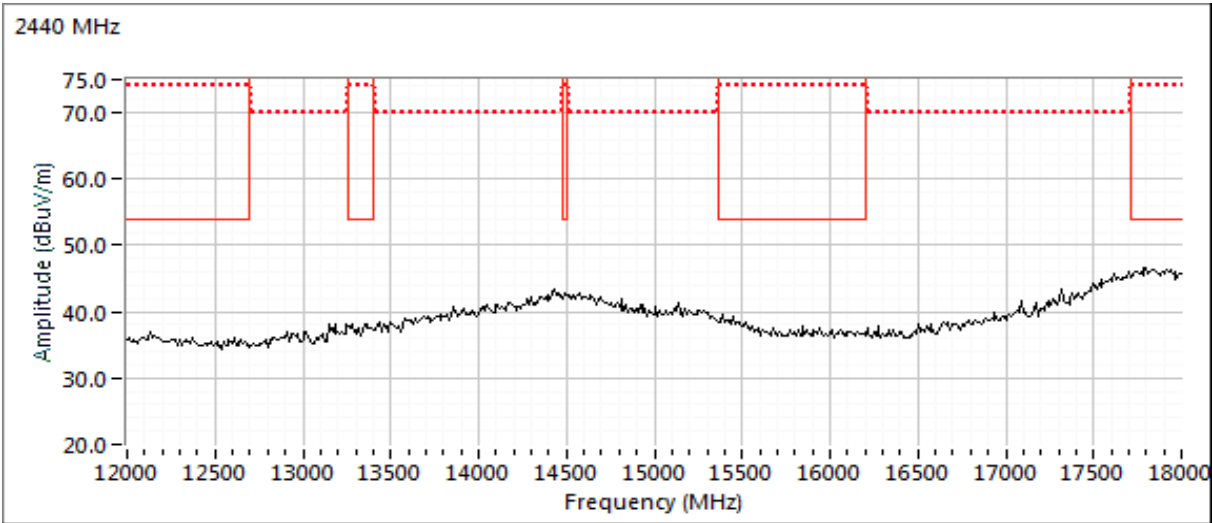



# EMC Test Data

Client: Fitbit, Inc.	Job Number: JD105947
Model: FB410	T-Log Number: T106007
Contact: Ricky Wang	Project Manager: Deepa Shetty
Standard: FCC 15.247, 15.209 / RSS-247, RSS-210 / LP0002	Project Coordinator: -
	Class: N/A

## Run #1c: High Channel

Channel: 2480MHz      Mode: BLE      Orientation: Flat  
 Tx Chain: Main      Data Rate: 1Mbps

Frequency	Level	Pol	15.209 / 15.247		Detector	Azimuth	Height	Comments
MHz	dB $\mu$ V/m	v/h	Limit	Margin	Pk/QP/Avg	degrees	meters	
4959.790	35.8	V	54.0	-18.3	Avg	120	1.0	Note 4, RB 1 MHz; VB 1 kHz; Peak VA
4960.060	46.8	V	74.0	-27.2	PK	120	1.0	RB 1 MHz; VB 3 MHz; Peak

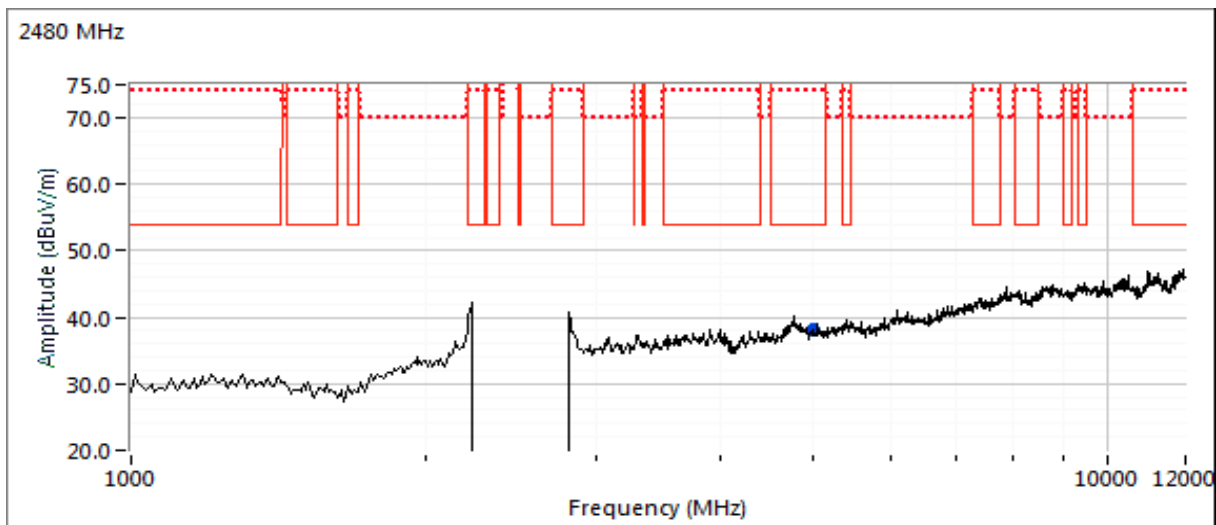

Client: Fitbit, Inc.	Job Number: JD105947
Model: FB410	T-Log Number: T106007
Contact: Ricky Wang	Project Manager: Deepa Shetty
Standard: FCC 15.247, 15.209 / RSS-247, RSS-210 / LP0002	Project Coordinator: -
	Class: N/A

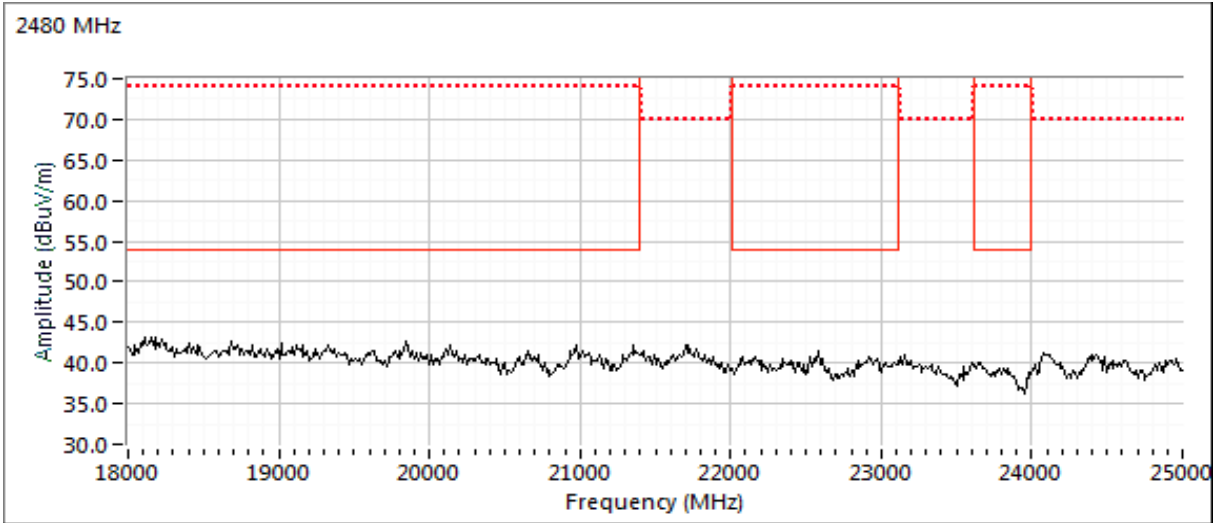
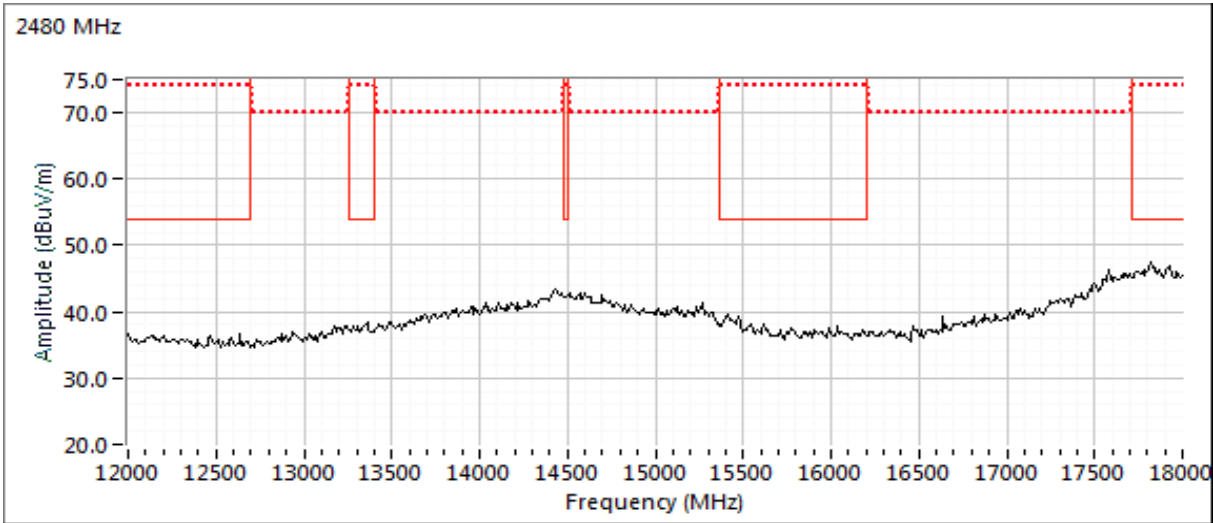





# EMC Test Data

Client: Fitbit, Inc.	Job Number: JD105947
Model: FB410	T-Log Number: T106007
Contact: Ricky Wang	Project Manager: Deepa Shetty
Standard: FCC 15.247, 15.209 / RSS-247, RSS-210 / LP0002	Project Coordinator: -
	Class: N/A

## Run #2: Radiated Spurious Emissions, 30-1000 MHz. Operating Mode: BLE

Date of Test: 4/11/18  
 Test Engineer: Rafael Varelas  
 Test Location: Chamber #7  
 Config. Used: 1  
 Config Change: -  
 EUT Voltage: 120V/ 60Hz

### Run #2a: Low Channel

Channel: 2402MHz      Mode: BLE      Orientation: Flat  
 Tx Chain: Main      Data Rate: 1Mbps

Frequency MHz	Level dB $\mu$ V/m	Pol v/h	15.209 / 15.247		Detector Pk/QP/Avg	Azimuth degrees	Height meters	Comments
			Limit	Margin				
75.075	26.1	V	40.0	-13.9	QP	320	1.0	QP (1.00s)
78.355	25.6	V	40.0	-14.4	QP	178	1.0	QP (1.00s)
179.213	26.2	H	43.5	-17.3	QP	10	3.3	QP (1.00s)
172.213	24.5	H	43.5	-19.0	QP	48	3.5	QP (1.00s)
640.961	25.2	V	46.0	-20.8	QP	138	1.0	QP (1.00s)

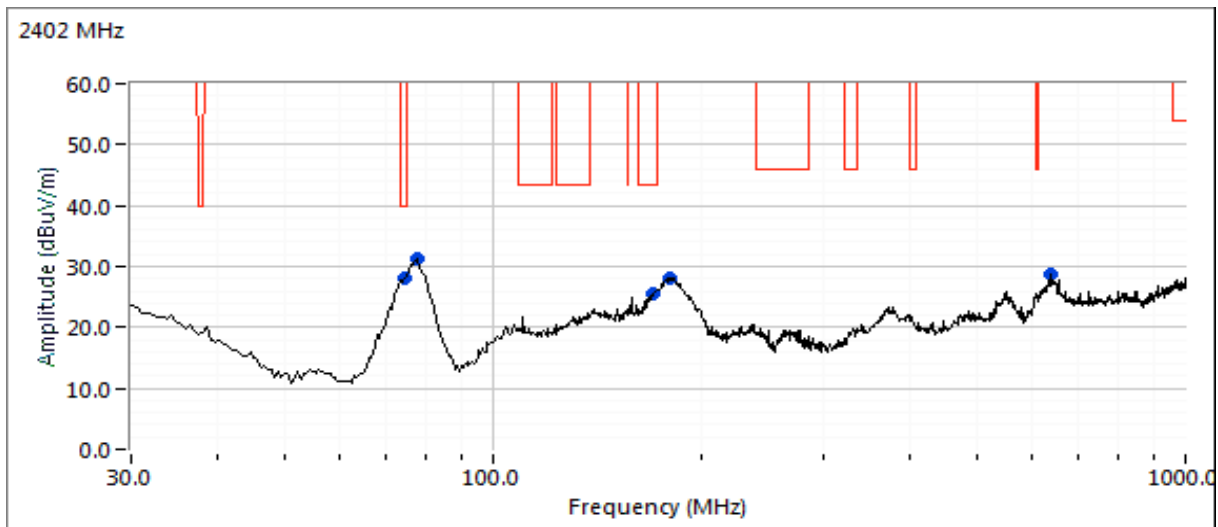



# EMC Test Data

Client: Fitbit, Inc.	Job Number: JD105947
Model: FB410	T-Log Number: T106007
Contact: Ricky Wang	Project Manager: Deepa Shetty
Standard: FCC 15.247, 15.209 / RSS-247, RSS-210 / LP0002	Project Coordinator: -
	Class: N/A

## Run #2: Radiated Spurious Emissions, 30-1000 MHz. Operating Mode: BLE

Date of Test: 4/11/18  
 Test Engineer: Rafael Varelas  
 Test Location: Chamber #7  
 Config. Used: 1  
 Config Change: -  
 EUT Voltage: 120V/ 60Hz

### Run #2b: High Channel

Channel: 2480MHz      Mode: BLE      Orientation: Flat  
 Tx Chain: Main      Data Rate: 1Mbps

Frequency MHz	Level dB $\mu$ V/m	Pol v/h	15.209 / 15.247		Detector Pk/QP/Avg	Azimuth degrees	Height meters	Comments
			Limit	Margin				
76.481	27.8	V	40.0	-12.2	QP	185	1.0	QP (1.00s)
181.460	26.1	H	43.5	-17.4	QP	266	2.0	QP (1.00s)
639.793	20.8	V	46.0	-25.2	QP	94	1.0	QP (1.00s)
271.119	16.0	H	46.0	-30.0	QP	162	4.0	QP (1.00s)

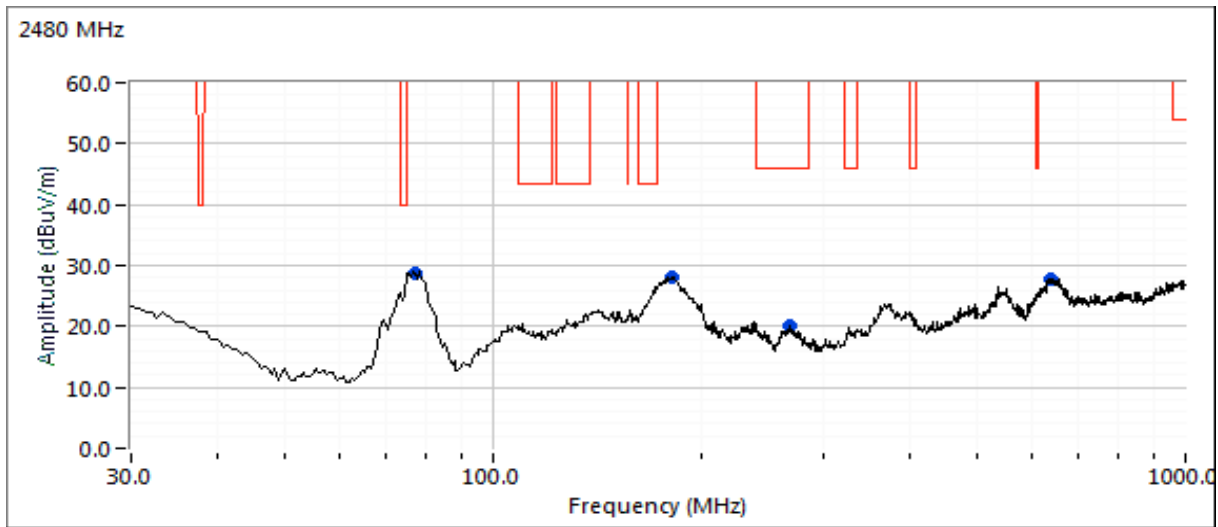



# EMC Test Data

Client: Fitbit, Inc.	Job Number: JD105947
Model: FB410	T-Log Number: T106007
	Project Manager: Deepa Shetty
Contact: Ricky Wang	Project Coordinator: -
Standard: FCC 15.247, 15.209 / RSS-247, RSS-210 / LP0002	Class: N/A

## RSS-247 and FCC 15.247 (DTS) Antenna Port Measurements Power, PSD, Bandwidth and Spurious Emissions

### Test Specific Details

Objective: The objective of this test session is to perform final qualification testing of the EUT with respect to the specification listed above.

Date of Test: 4/11/2019  
 Test Engineer: John Caizzi  
 Test Location: Lab 4B

Config. Used: Conducted  
 Config Change: none  
 EUT Voltage: 120V / 60Hz

### General Test Configuration

The EUT was connected to the spectrum analyzer or power meter via a suitable attenuator. All measurements were made on a single chain.

All measurements have been corrected to allow for the external attenuators used.

### Ambient Conditions:

Temperature: 23 °C  
 Rel. Humidity: 36 %

### Summary of Results

Run #	Pwr setting	Avg Pwr	Test Performed	Limit	Pass / Fail	Result / Margin
1	4		Output Power	15.247(b)	Pass	4.5 dBm
2			Power spectral Density (PSD)	15.247(d)	Pass	-3.9 dBm/10 kHz
3			Minimum 6dB Bandwidth	15.247(a)	Pass	760 kHz
3			99% Bandwidth	RSS GEN	-	1804 kHz
4			Spurious emissions	15.247(b)	Pass	All emissions < -20 dBc

### Modifications Made During Testing

No modifications were made to the EUT during testing

### Deviations From The Standard

No deviations were made from the requirements of the standard.

### Procedure Comments:

Measurements performed in accordance with FCC KDB 558074



# EMC Test Data

Client: Fitbit, Inc.	Job Number: JD105947
Model: FB410	T-Log Number: T106007
	Project Manager: Deepa Shetty
Contact: Ricky Wang	Project Coordinator: -
Standard: FCC 15.247, 15.209 / RSS-247, RSS-210 / LP0002	Class: N/A

Mode	Data Rate	Duty Cycle (x)	Constant DC?	T (ms)	Pwr Cor Factor*	Lin Volt Cor Factor**	Min VBW for FS (Hz)
BLE	1Mbps	85.6%	Yes	2.145	0.68	1.35	466

## Sample Notes

Sample S/N: #33

Driver: 1.5.9615



# EMC Test Data

Client: Fitbit, Inc.	Job Number: JD105947
Model: FB410	T-Log Number: T106007
	Project Manager: Deepa Shetty
Contact: Ricky Wang	Project Coordinator: -
Standard: FCC 15.247, 15.209 / RSS-247, RSS-210 / LP0002	Class: N/A

## Run #1: Output Power

Mode: BLE

Power Setting <sup>2</sup>	Frequency (MHz)	Output Power		Antenna Gain (dBi)	Result	EIRP		Output Power	
		(dBm) <sup>1</sup>	mW			dBm	W	(dBm) <sup>3</sup>	mW
4	2402	4.4	2.8	-10.7	Pass	-6.3	0.00023		
	2440	4.5	2.8	-10.7	Pass	-6.2	0.00024		
	2480	4.4	2.8	-10.7	Pass	-6.3	0.00023		

- Note 1: Output power measured using a peak power meter, spurious limit is -20dBc.
- Note 2: Power setting - the software power setting used during testing, included for reference only.
- Note 3: Power measured using average power meter (non-gated) and is included for reference only.

Client: Fitbit, Inc.	Job Number: JD105947
Model: FB410	T-Log Number: T106007
	Project Manager: Deepa Shetty
Contact: Ricky Wang	Project Coordinator: -
Standard: FCC 15.247, 15.209 / RSS-247, RSS-210 / LP0002	Class: N/A

Run #2: Power spectral Density

Mode: BLE

Power Setting	Frequency (MHz)	PSD	Limit	Result
		(dBm/10kHz) <small>Note 1</small>		
4	2402	-3.9	8.0	Pass
	2440	-4.0	8.0	Pass
	2480	-4.4	8.0	Pass

Note 1: Test performed per method PKSPD, in KDB 558074. Power spectral density measured using:  $3\text{kHz} \leq \text{RBW} \leq 100\text{kHz}$ ,  $\text{VBW}=3*\text{RBW}$ , peak detector, span =  $1.5*\text{DTS BW}$ , auto sweep time, max hold.

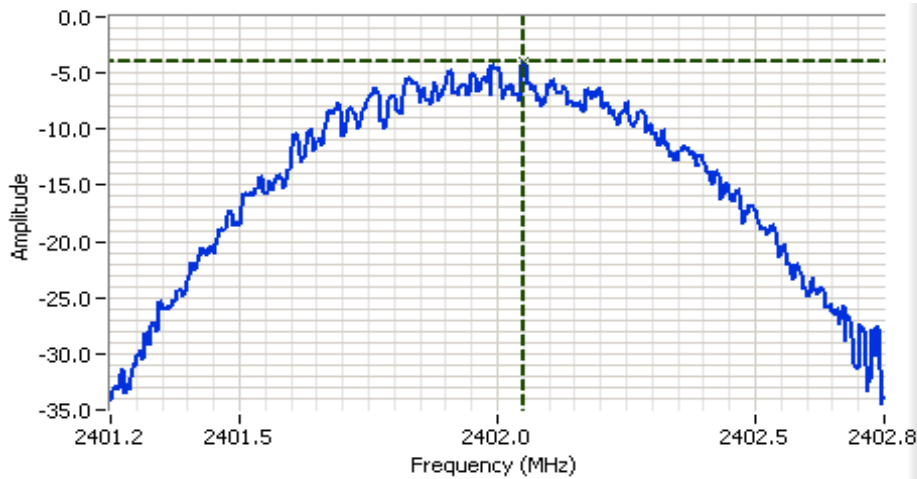

**Analyzer Settings**

Agilent Technologies, E4446A  
 CF: 2402.000 MHz  
 SPAN: 1.500 MHz  
 RB: 10.0 kHz  
 VB: 30.0 kHz  
 Detector: POS  
 Attn: 10 DB  
 RL Offset: 10.5 DB  
 Sweep Time: 14.4ms  
 Ref Lvl: 10.0 DBM

---

**Comments**

PSD = -3.9 dBm/10 KHz

Cursor 1 2402.0525 -3.9

0.0000 0.0

Client: Fitbit, Inc.	Job Number: JD105947
Model: FB410	T-Log Number: T106007
	Project Manager: Deepa Shetty
Contact: Ricky Wang	Project Coordinator: -
Standard: FCC 15.247, 15.209 / RSS-247, RSS-210 / LP0002	Class: N/A

### Run #3: Signal Bandwidth

Mode: BLE

Power Setting	Frequency (MHz)	Bandwidth (kHz)		RBW Setting (kHz)	
		6dB	99%	6dB	99%
4	2402	760	1258	100	30
	2440	847	1498		
	2480	913	1804		

Note 1: DTS BW: RBW=100kHz, VBW ≥ 3\*RBW, peak detector, max hold, auto sweep time, Span 2-5 times measured BW.  
 99% BW: RBW=1-5% of 99%BW, VBW ≥ 3\*RBW, peak detector, max hold, auto sweep time. Span 1.5-5 times OBW.

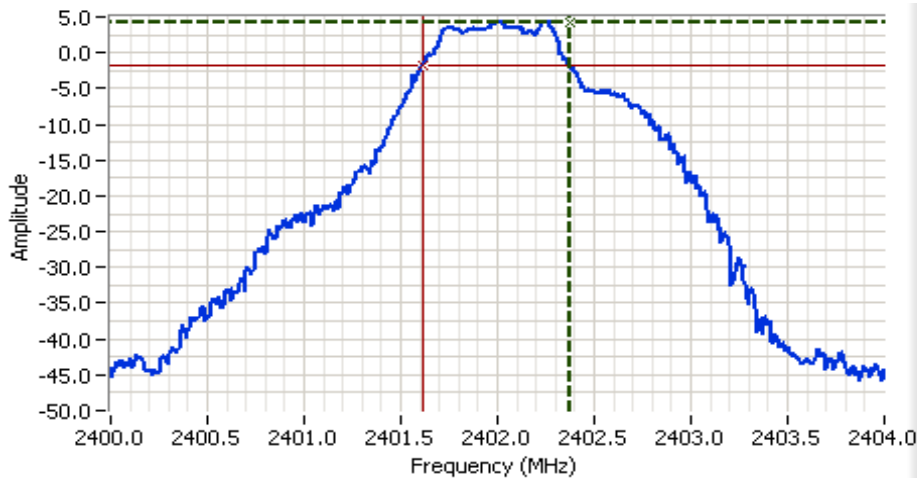

**Analyzer Settings**

Agilent Technologies, E4446A  
 CF: 2402.000 MHz  
 SPAN: 4.000 MHz  
 RB: 100 kHz  
 VB: 300 kHz  
 Detector: POS  
 Attn: 10 DB  
 RL Offset: 10.5 DB  
 Sweep Time: 1.0ms  
 Ref Lvl: 10.0 DBM

---

**Comments**

6dB BW: 760 kHz

Cursor 1	2402.3733	4.3	
Cursor 2	2401.6133	-1.7	

Delta Freq. 760 kHz  
 Delta Amplitude 6.0

Client: Fitbit, Inc.	Job Number: JD105947
Model: FB410	T-Log Number: T106007
Contact: Ricky Wang	Project Manager: Deepa Shetty
Standard: FCC 15.247, 15.209 / RSS-247, RSS-210 / LP0002	Project Coordinator: -
	Class: N/A

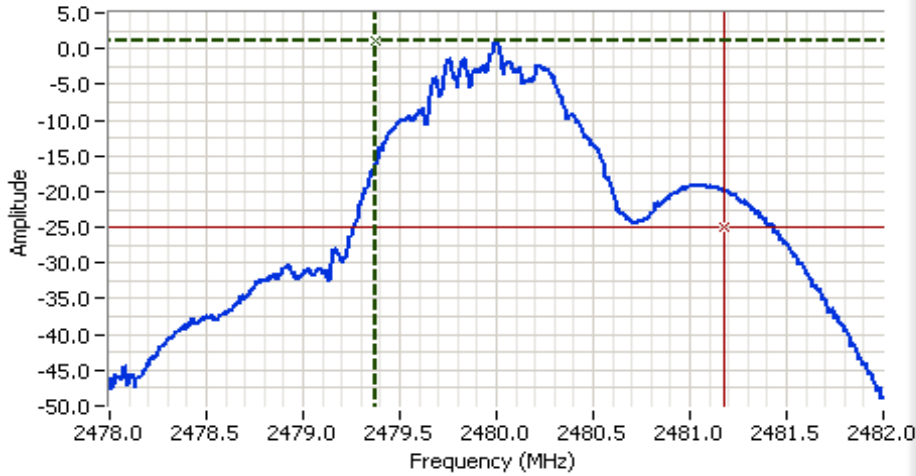

**Analyzer Settings**

- Agilent Technologies, E4446A
- CF: 2480.000 MHz
- SPAN: 4.000 MHz
- RB: 30.0 kHz
- VB: 91.0 kHz
- Detector: POS
- Attn: 10 DB
- RL Offset: 10.5 DB
- Sweep Time: 4.3ms
- Ref Lvl: 10.0 DBM

**Comments**

99% power BW: 1.804 MHz

Cursor 1	2479.3777	1.0		Delta Freq.	1.804
Cursor 2	2481.1814	-25.0		Delta Amplitude	26.0



Client: Fitbit, Inc.	Job Number: JD105947
Model: FB410	T-Log Number: T106007
	Project Manager: Deepa Shetty
Contact: Ricky Wang	Project Coordinator: -
Standard: FCC 15.247, 15.209 / RSS-247, RSS-210 / LP0002	Class: N/A

Run #4a: Out of Band Spurious Emissions

Frequency (MHz)	Power Setting	Mode	Limit	Result
2402	4	BLE	-20dBc	Pass
2440				Pass
2480				Pass

RBW = 100 kHz and VBW = 300 kHz for all plots.

Plots for low channel

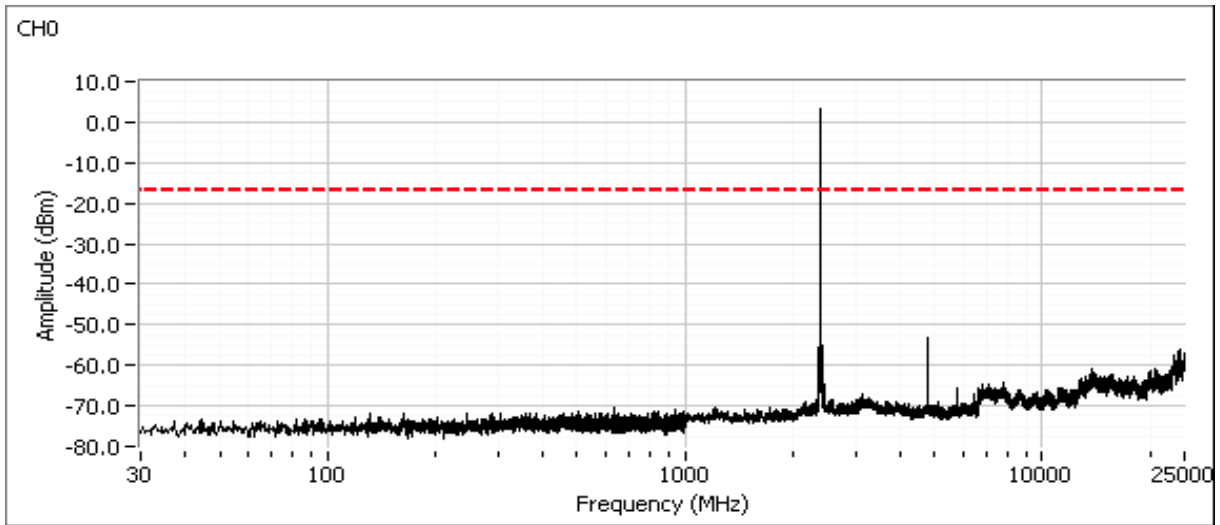

Client: Fitbit, Inc.	Job Number: JD105947
Model: FB410	T-Log Number: T106007
Contact: Ricky Wang	Project Manager: Deepa Shetty
Standard: FCC 15.247, 15.209 / RSS-247, RSS-210 / LP0002	Project Coordinator: -
	Class: N/A

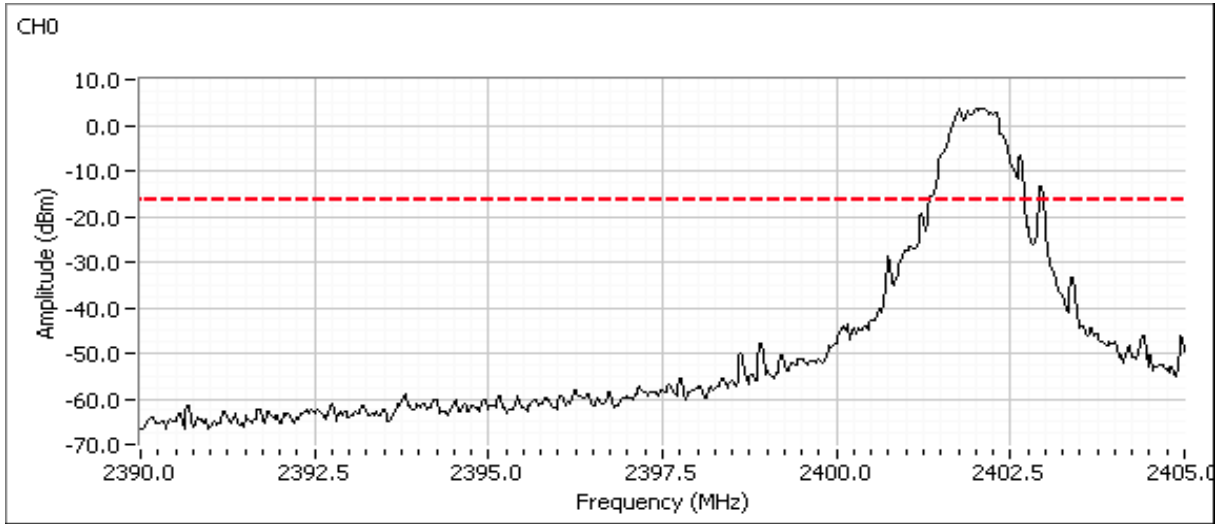

Additional plot showing compliance with -20dBc limit from 2390 MHz to 2400 MHz. Radiated measurements used to show compliance with the limits in the restricted band below 2390 MHz.

Plot for center channel

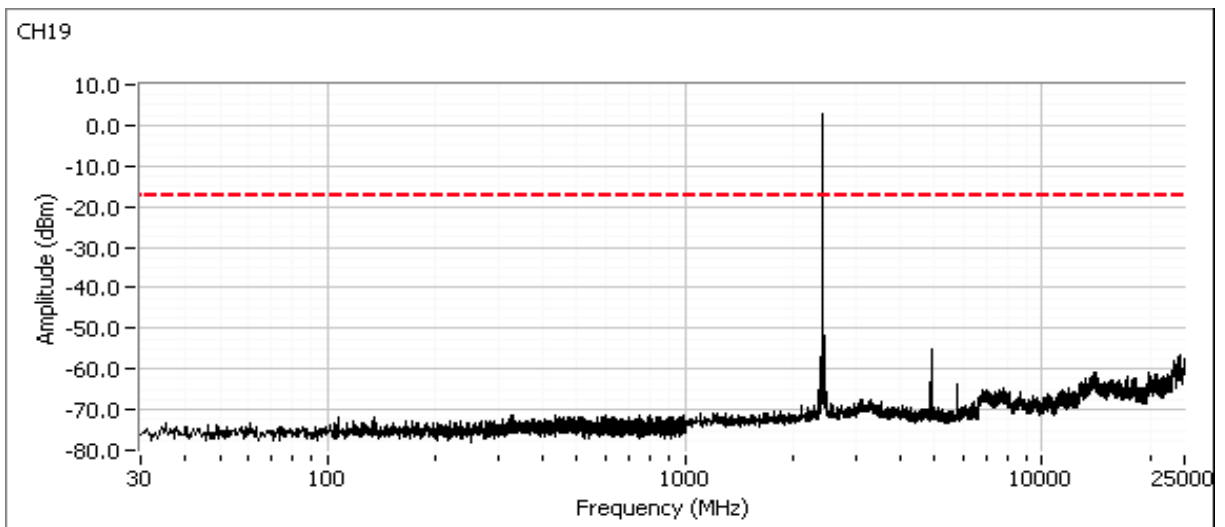

Client: Fitbit, Inc.	Job Number: JD105947
Model: FB410	T-Log Number: T106007
	Project Manager: Deepa Shetty
Contact: Ricky Wang	Project Coordinator: -
Standard: FCC 15.247, 15.209 / RSS-247, RSS-210 / LP0002	Class: N/A

Plot for high channel

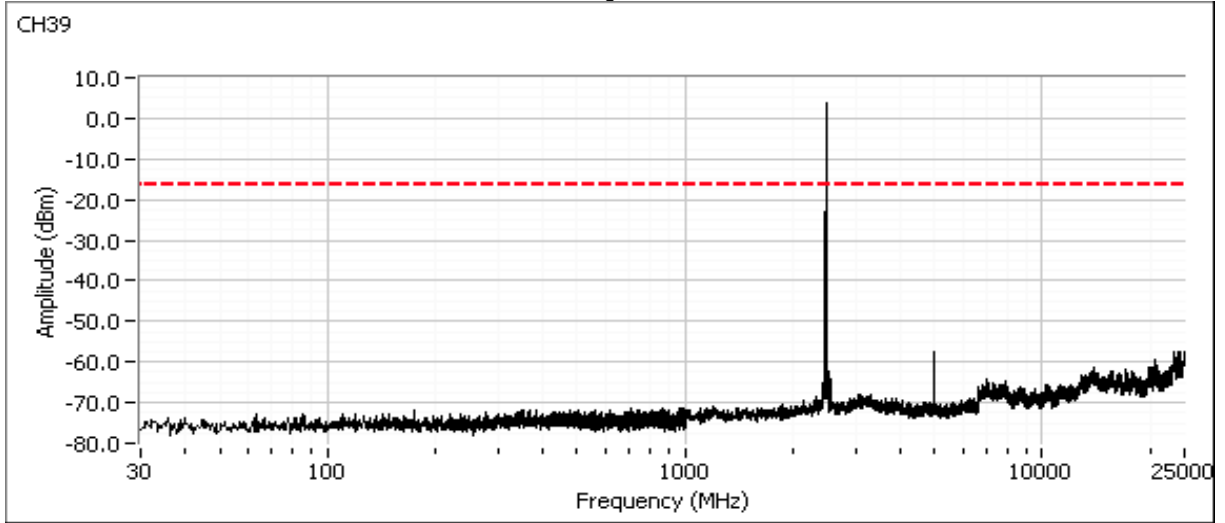

***End of Report***

This page is intentionally blank and marks the last page of this test report.