

## *EMC Test Report*

### *Application for Grant of Equipment Authorization*

### *Industry Canada RSS-Gen Issue 3 / RSS 210 Issue 8 FCC Part 15 Subpart C*

#### *Model: FB405*

IC CERTIFICATION #: XRAFB405  
FCC ID: 8542A-FB405

APPLICANT: Fitbit, Inc.  
405 Howard Street  
San Francisco, CA 94105

TEST SITE(S): National Technical Systems - Silicon Valley  
41039 Boyce Road.  
Fremont, CA. 94538-2435

IC SITE REGISTRATION #: 2845B-3, 2845B-7

REPORT DATE: August 4, 2014

REISSUE DATE: September 3, 2014

FINAL TEST DATES: June 25, July 2 and 7, 2014

TOTAL NUMBER OF PAGES: 49

PROGRAM MGR /  
TECHNICAL REVIEWER:

QUALITY ASSURANCE DELEGATE /  
FINAL REPORT PREPARER:



---

Mark Hill  
Staff Engineer



---

David Guidotti  
Senior Technical Writer



National Technical Systems - Silicon Valley is accredited by the A2LA, certificate number 0214.26, to perform the test(s) listed in this report, except where noted otherwise. This report and the information contained herein represent the results of testing test articles identified and selected by the client performed to specifications and/or procedures selected by the client. National Technical Systems (NTS) makes no representations, expressed or implied, that such testing is adequate (or inadequate) to demonstrate efficiency, performance, reliability, or any other characteristic of the articles being tested, or similar products. This report should not be relied upon as an endorsement or certification by NTS of the equipment tested, nor does it represent any statement whatsoever as to its merchantability or fitness of the test article, or similar products, for a particular purpose. This report shall not be reproduced except in full

**REVISION HISTORY**

Rev#	Date	Comments	Modified By
	August 4, 2014	First release	
1.0	September 3, 2014	Updated notes regarding output power measurement	MEH

## TABLE OF CONTENTS

<b>REVISION HISTORY .....</b>	<b>2</b>
<b>TABLE OF CONTENTS .....</b>	<b>3</b>
<b>SCOPE.....</b>	<b>4</b>
<b>OBJECTIVE .....</b>	<b>4</b>
<b>STATEMENT OF COMPLIANCE.....</b>	<b>5</b>
<b>DEVIATIONS FROM THE STANDARDS.....</b>	<b>5</b>
<b>TEST RESULTS SUMMARY .....</b>	<b>6</b>
DIGITAL TRANSMISSION SYSTEMS (2400 – 2483.5MHZ).....	6
GENERAL REQUIREMENTS APPLICABLE TO ALL BANDS.....	6
MEASUREMENT UNCERTAINTIES.....	7
<b>EQUIPMENT UNDER TEST (EUT) DETAILS.....</b>	<b>8</b>
GENERAL.....	8
OTHER EUT DETAILS.....	8
ANTENNA SYSTEM .....	8
ENCLOSURE.....	8
MODIFICATIONS.....	8
SUPPORT EQUIPMENT.....	8
EUT INTERFACE PORTS .....	8
EUT OPERATION .....	8
<b>TEST SITE.....</b>	<b>9</b>
GENERAL INFORMATION.....	9
CONDUCTED EMISSIONS CONSIDERATIONS .....	9
RADIATED EMISSIONS CONSIDERATIONS .....	9
<b>MEASUREMENT INSTRUMENTATION .....</b>	<b>10</b>
RECEIVER SYSTEM .....	10
INSTRUMENT CONTROL COMPUTER .....	10
LINE IMPEDANCE STABILIZATION NETWORK (LISN).....	10
FILTERS/ATTENUATORS .....	11
ANTENNAS.....	11
ANTENNA MAST AND EQUIPMENT TURNTABLE.....	11
INSTRUMENT CALIBRATION.....	11
<b>TEST PROCEDURES .....</b>	<b>12</b>
EUT AND CABLE PLACEMENT .....	12
CONDUCTED EMISSIONS.....	12
RADIATED EMISSIONS .....	13
CONDUCTED EMISSIONS FROM ANTENNA PORT .....	15
BANDWIDTH MEASUREMENTS .....	15
SPECIFICATION LIMITS AND SAMPLE CALCULATIONS .....	16
CONDUCTED EMISSIONS SPECIFICATION LIMITS: FCC 15.207; FCC 15.107(A), RSS GEN .....	16
GENERAL TRANSMITTER RADIATED EMISSIONS SPECIFICATION LIMITS .....	17
RECEIVER RADIATED SPURIOUS EMISSIONS SPECIFICATION LIMITS.....	17
OUTPUT POWER LIMITS – DIGITAL TRANSMISSION SYSTEMS .....	17
TRANSMIT MODE SPURIOUS RADIATED EMISSIONS LIMITS – FHSS AND DTS SYSTEMS.....	18
SAMPLE CALCULATIONS - CONDUCTED EMISSIONS .....	18
SAMPLE CALCULATIONS - RADIATED EMISSIONS.....	18
SAMPLE CALCULATIONS - FIELD STRENGTH TO EIRP CONVERSION.....	19
<b>APPENDIX A TEST EQUIPMENT CALIBRATION DATA .....</b>	<b>20</b>
<b>APPENDIX B TEST DATA .....</b>	<b>21</b>
<b>END OF REPORT .....</b>	<b>49</b>

## SCOPE

An electromagnetic emissions test has been performed on the Fitbit, Inc. model FB405, pursuant to the following rules:

Industry Canada RSS-Gen Issue 3

RSS 210 Issue 8 “Low-power Licence-exempt Radiocommunication Devices (All Frequency Bands): Category I Equipment”

FCC Part 15 Subpart C

Conducted and radiated emissions data has been collected, reduced, and analyzed within this report in accordance with measurement guidelines set forth in the following reference standards and as outlined in National Technical Systems - Silicon Valley test procedures:

ANSI C63.10-2009

FCC DTS Measurement Guidance KDB558074

The intentional radiator above has been tested in a simulated typical installation to demonstrate compliance with the relevant Industry Canada performance and procedural standards.

Final system data was gathered in a mode that tended to maximize emissions by varying orientation of EUT, orientation of power and I/O cabling, antenna search height, and antenna polarization.

Every practical effort was made to perform an impartial test using appropriate test equipment of known calibration. All pertinent factors have been applied to reach the determination of compliance.

## OBJECTIVE

The primary objective of the manufacturer is compliance with the regulations outlined in the previous section.

Prior to marketing in the USA, all unlicensed transmitters and transceivers require certification. Receive-only devices operating between 30 MHz and 960 MHz are subject to either certification or a manufacturer’s declaration of conformity, with all other receive-only devices exempt from the technical requirements.

Prior to marketing in Canada, Class I transmitters, receivers and transceivers require certification. Class II devices are required to meet the appropriate technical requirements but are exempt from certification requirements.

Certification is a procedure where the manufacturer submits test data and technical information to a certification body and receives a certificate or grant of equipment authorization upon successful completion of the certification body’s review of the submitted documents. Once the equipment authorization has been obtained, the label indicating compliance must be attached to all identical units, which are subsequently

manufactured.

Maintenance of compliance is the responsibility of the manufacturer. Any modification of the product which may result in increased emissions should be checked to ensure compliance has been maintained (i.e., printed circuit board layout changes, different line filter, different power supply, harnessing or I/O cable changes, etc.).

#### **STATEMENT OF COMPLIANCE**

The tested sample of Fitbit, Inc. model FB405 complied with the requirements of the following regulations:

Industry Canada RSS-Gen Issue 3  
RSS 210 Issue 8 “Low-power Licence-exempt Radiocommunication Devices (All Frequency Bands): Category I Equipment”  
FCC Part 15 Subpart C

Maintenance of compliance is the responsibility of the manufacturer. Any modifications to the product should be assessed to determine their potential impact on the compliance status of the device with respect to the standards detailed in this test report.

The test results recorded herein are based on a single type test of Fitbit, Inc. model FB405 and therefore apply only to the tested sample. The sample was selected and prepared by Arndt Hufenbach of Fitbit, Inc.

#### **DEVIATIONS FROM THE STANDARDS**

No deviations were made from the published requirements listed in the scope of this report.

**TEST RESULTS SUMMARY****DIGITAL TRANSMISSION SYSTEMS (2400 – 2483.5MHz)**

FCC Rule Part	RSS Rule Part	Description	Measured Value / Comments	Limit / Requirement	Result
15.247(a)	RSS 210 A8.2	Digital Modulation	Systems uses DSSS techniques	System must utilize a digital transmission technology	Complies
15.247 (a) (2)	RSS 210 A8.2 (1)	6dB Bandwidth	700 kHz	>500kHz	Complies
15.247 (b) (3)	RSS 210 A8.2 (4)	Output Power (multipoint systems)	0.9 dBm (1.2mW) EIRP = 0.002 W <small>Note 1</small>	1Watt, EIRP limited to 4 Watts.	Complies
15.247(d)	RSS 210 A8.2 (2)	Power Spectral Density	-5.0 dBm/10kHz	8dBm/3kHz	Complies
15.247(c)	RSS 210 A8.5	Antenna Port Spurious Emissions 30MHz – 25 GHz	All spurious < -20 dBc	< -20dBc	Complies
15.247(c) / 15.209	RSS 210 A8.5	Radiated Spurious Emissions 30MHz – 25 GHz	48.3 dB $\mu$ V/m @ 4804.0 MHz (-5.7 dB)	15.207 in restricted bands, all others < -20dBc	Complies

Note 1: EIRP calculated using antenna gain of 1.7 dBi for the highest EIRP system.

**GENERAL REQUIREMENTS APPLICABLE TO ALL BANDS**

FCC Rule Part	RSS Rule part	Description	Measured Value / Comments	Limit / Requirement	Result (margin)
15.203	-	RF Connector	Integral antenna (Note 1)	Unique or integral antenna required	Complies
15.207	RSS GEN Table 4	AC Conducted Emissions	26.3 dB $\mu$ V @ 0.625 MHz (-19.7 dB)	Refer to page 16	Complies
15.109	RSS GEN 7.2.3 Table 1	Receiver spurious emissions	N/A – EUT tunes above 960MHz		
15.247 (b) (5) / 15.407 (f)	RSS 102	RF Exposure Requirements	Refer to SAR Exclusion calculations in separate exhibit, RSS 102 declaration and User Manual statements.	Refer to OET 65, FCC Part 1 and RSS 102	Complies
-	RSP 100 RSS GEN 7.1.3	User Manual	Refer to manual	Statement required regarding non-interference	Complies
-	RSP 100 RSS GEN 4.6.1	99% Bandwidth	1572 kHz	Information only	N/A

Note 1 – A modified sample of the EUT was provided to allow for direct antenna port measurements.

**MEASUREMENT UNCERTAINTIES**

ISO/IEC 17025 requires that an estimate of the measurement uncertainties associated with the emissions test results be included in the report. The measurement uncertainties given below are based on a 95% confidence level and were calculated in accordance with UKAS document LAB 34.

Measurement Type	Measurement Unit	Frequency Range	Expanded Uncertainty
RF power, conducted (power meter)	dBm	25 to 7000 MHz	± 0.52 dB
RF power, conducted (Spectrum analyzer)	dBm	25 to 7000 MHz	± 0.7 dB
Conducted emission of transmitter	dBm	25 to 26500 MHz	± 0.7 dB
Conducted emission of receiver	dBm	25 to 26500 MHz	± 0.7 dB
Radiated emission (substitution method)	dBm	25 to 26500 MHz	± 2.5 dB
Radiated emission (field strength)	dB $\mu$ V/m	25 to 1000 MHz	± 3.6 dB
		1000 to 40000 MHz	± 6.0 dB
Conducted Emissions (AC Power)	dB $\mu$ V	0.15 to 30 MHz	± 2.4 dB

**EQUIPMENT UNDER TEST (EUT) DETAILS****GENERAL**

The Fitbit, Inc. model FB405 is a wearable fitness tracker.

The sample was received on June 25, 2014 and tested on June 25, July 2 and 7, 2014. The EUT consisted of the following component(s):

Company	Model	Description	Serial Number	FCC ID
Fitbit, Inc.	FB405	Wearable Fitness Tracker	6-158 (radiated and conducted emissions) and 6-156 (RF port measurements)	XRAFB405

**OTHER EUT DETAILS**

Radio: Bluetooth Low Energy only

USB used for charging only, no data transfer

**ANTENNA SYSTEM**

Internal antenna, 1.74dBi

**ENCLOSURE**

The EUT enclosure is primarily constructed of plastic. It measures approximately 2 cm wide by 4 cm deep by 1 cm high. .

**MODIFICATIONS**

No modifications were made to the EUT during the time the product was at NTS Silicon Valley.

**SUPPORT EQUIPMENT**

The following equipment was used as support equipment for testing:

Company	Model	Description	Serial Number	FCC ID
Apple	A1357 W010A051	AC/DC USB Charger	-	-

**EUT INTERFACE PORTS**

The I/O cabling configuration during testing was as follows:

Port	Connected To	Description	Cable(s)	
			Shielded or Unshielded	Length(m)
USB Charging Port	AC/DC Charger	Multiconductor	Shielded	0.3

**EUT OPERATION**

EUT was operating using test firmware that allowed for continuous transmission on a low, middle or high channel, at the maximum output power.



**TEST SITE****GENERAL INFORMATION**

Final test measurements were taken at the test sites listed below. Pursuant to section 2.948 of the FCC's Rules and section 3.3 of RSP-100, construction, calibration, and equipment data has been filed with the Commission and with industry Canada.

Site	Designation / Registration Numbers		Location
	FCC	Canada	
Chamber 3	US0027	2845B-7	41039 Boyce Road Fremont, CA 94538-2435
Chamber 7	US0027	2845B-7	

ANSI C63.4 recommends that ambient noise at the test site be at least 6 dB below the allowable limits. Ambient levels are below this requirement. The test site(s) contain separate areas for radiated and conducted emissions testing. Considerable engineering effort has been expended to ensure that the facilities conform to all pertinent requirements of ANSI C63.4.

**CONDUCTED EMISSIONS CONSIDERATIONS**

Conducted emissions testing is performed in conformance with ANSI C63.10. Measurements are made with the EUT connected to the public power network through a nominal, standardized RF impedance, which is provided by a line impedance stabilization network, known as a LISN. A LISN is inserted in series with each current-carrying conductor in the EUT power cord.

**RADIATED EMISSIONS CONSIDERATIONS**

The FCC has determined that radiation measurements made in a shielded enclosure are not suitable for determining levels of radiated emissions. Radiated measurements are performed in an open field environment or in a semi-anechoic chamber. The test sites are maintained free of conductive objects within the CISPR defined elliptical area incorporated in ANSI C63.4 guidelines and meet the Normalized Site Attenuation (NSA) requirements of ANSI C63.4.

## MEASUREMENT INSTRUMENTATION

### RECEIVER SYSTEM

An EMI receiver as specified in CISPR 16-1-1 is used for emissions measurements. The receivers used can measure over the frequency range of 9 kHz up to 2000 MHz. These receivers allow both ease of measurement and high accuracy to be achieved. The receivers have Peak, Average, and CISPR (Quasi-peak) detectors built into their design so no external adapters are necessary. The receiver automatically sets the required bandwidth for the CISPR detector used during measurements. If the repetition frequency of the signal being measured is below 20Hz, peak measurements are made in lieu of Quasi-Peak measurements.

For measurements above the frequency range of the receivers, a spectrum analyzer is utilized because it provides visibility of the entire spectrum along with the precision and versatility required to support engineering analysis. Average measurements above 1000MHz are performed on the spectrum analyzer using the linear-average method with a resolution bandwidth of 1 MHz and a video bandwidth of 10 Hz, unless the signal is pulsed in which case the average (or video) bandwidth of the measuring instrument is reduced to onset of pulse desensitization and then increased.

### INSTRUMENT CONTROL COMPUTER

The receivers utilize either a Rohde & Schwarz EZM Spectrum Monitor/Controller or contain an internal Spectrum Monitor/Controller to view and convert the receiver measurements to the field strength at an antenna or voltage developed at the LISN measurement port, which is then compared directly with the appropriate specification limit. This provides faster, more accurate readings by performing the conversions described under Sample Calculations within the Test Procedures section of this report. Results are printed in a graphic and/or tabular format, as appropriate. A personal computer is used to record all measurements made with the receivers.

The Spectrum Monitor provides a visual display of the signal being measured. In addition, the controller or a personal computer run automated data collection programs which control the receivers. This provides added accuracy since all site correction factors, such as cable loss and antenna factors are added automatically.

### LINE IMPEDANCE STABILIZATION NETWORK (LISN)

Line conducted measurements utilize a fifty microhenry Line Impedance Stabilization Network as the monitoring point. The LISN used also contains a 250 uH CISPR adapter. This network provides for calibrated radio frequency noise measurements by the design of the internal low pass and high pass filters on the EUT and measurement ports, respectively.

#### **FILTERS/ATTENUATORS**

External filters and precision attenuators are often connected between the receiving antenna or LISN and the receiver. This eliminates saturation effects and non-linear operation due to high amplitude transient events.

#### **ANTENNAS**

A loop antenna is used below 30 MHz. For the measurement range 30 MHz to 1000 MHz either a combination of a biconical antenna and a log periodic or a bi-log antenna is used. Above 1000 MHz, horn antennas are used. The antenna calibration factors to convert the received voltage to an electric field strength are included with appropriate cable loss and amplifier gain factors to determine an overall site factor, which is then programmed into the test receivers or incorporated into the test software.

#### **ANTENNA MAST AND EQUIPMENT TURNTABLE**

The antennas used to measure the radiated electric field strength are mounted on a non-conductive antenna mast equipped with a motor-drive to vary the antenna height. Measurements below 30 MHz are made with the loop antenna at a fixed height of 1m above the ground plane.

ANSI C63.10 specifies that the test height above ground for table mounted devices shall be 80 centimeters. Floor mounted equipment shall be placed on the ground plane if the device is normally used on a conductive floor or separated from the ground plane by insulating material from 3 to 12 mm if the device is normally used on a non-conductive floor as specified in ANSI C63.4. During radiated measurements, the EUT is positioned on a motorized turntable in conformance with this requirement.

#### **INSTRUMENT CALIBRATION**

All test equipment is regularly checked to ensure that performance is maintained in accordance with the manufacturer's specifications. All antennas are calibrated at regular intervals with respect to tuned half-wave dipoles. An exhibit of this report contains the list of test equipment used and calibration information.

## TEST PROCEDURES

### EUT AND CABLE PLACEMENT

The regulations require that interconnecting cables be connected to the available ports of the unit and that the placement of the unit and the attached cables simulate the worst case orientation that can be expected from a typical installation, so far as practicable. To this end, the position of the unit and associated cabling is varied within the guidelines of ANSI C63.10, and the worst-case orientation is used for final measurements.

### CONDUCTED EMISSIONS

Conducted emissions are measured at the plug end of the power cord supplied with the EUT. Excess power cord length is wrapped in a bundle between 30 and 40 centimeters in length near the center of the cord. Preliminary measurements are made to determine the highest amplitude emission relative to the specification limit for all the modes of operation. Placement of system components and varying of cable positions are performed in each mode. A final peak mode scan is then performed in the position and mode for which the highest emission was noted on all current carrying conductors of the power cord.

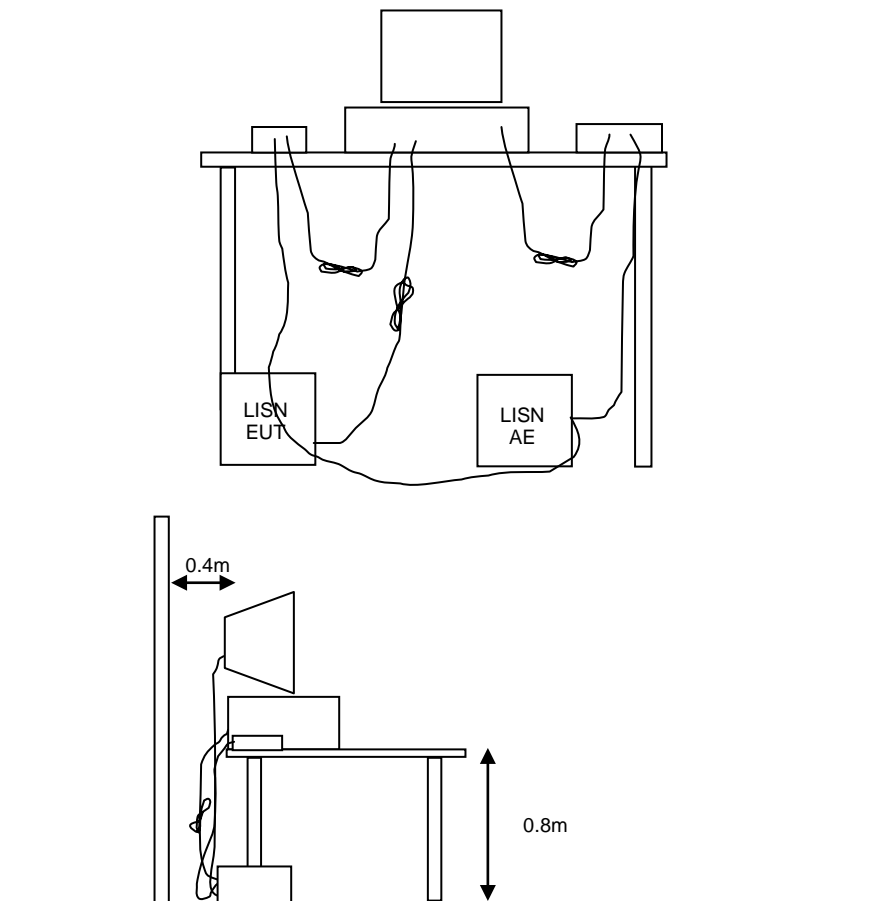

**Figure 1 Typical Conducted Emissions Test Configuration**

**RADIATED EMISSIONS**

A preliminary scan of the radiated emissions is performed in which all significant EUT frequencies are identified with the system in a nominal configuration. At least two scans are performed, one scan for each antenna polarization (horizontal and vertical; loop parallel and perpendicular to the EUT). During the preliminary scans, the EUT is rotated through 360°, the antenna height is varied (for measurements above 30 MHz) and cable positions are varied to determine the highest emission relative to the limit. Preliminary scans may be performed in a fully anechoic chamber for the purposes of identifying the frequencies of the highest emissions from the EUT.

A speaker is provided in the receiver to aid in discriminating between EUT and ambient emissions. Other methods used during the preliminary scan for EUT emissions involve scanning with near field magnetic loops, monitoring I/O cables with RF current clamps, and cycling power to the EUT.

Final maximization is a phase in which the highest amplitude emissions identified in the spectral search are viewed while the EUT azimuth angle is varied from 0 to 360 degrees relative to the receiving antenna. The azimuth, which results in the highest emission is then maintained while varying the antenna height from one to four meters (for measurements above 30 MHz, measurements below 30 MHz are made with the loop antenna at a fixed height of 1m). The result is the identification of the highest amplitude for each of the highest peaks. Each recorded level is corrected in the receiver using appropriate factors for cables, connectors, antennas, and preamplifier gain.

When testing above 18 GHz, the receive antenna is located at 1meter from the EUT and the antenna height is restricted to a maximum of 2.5 meters.

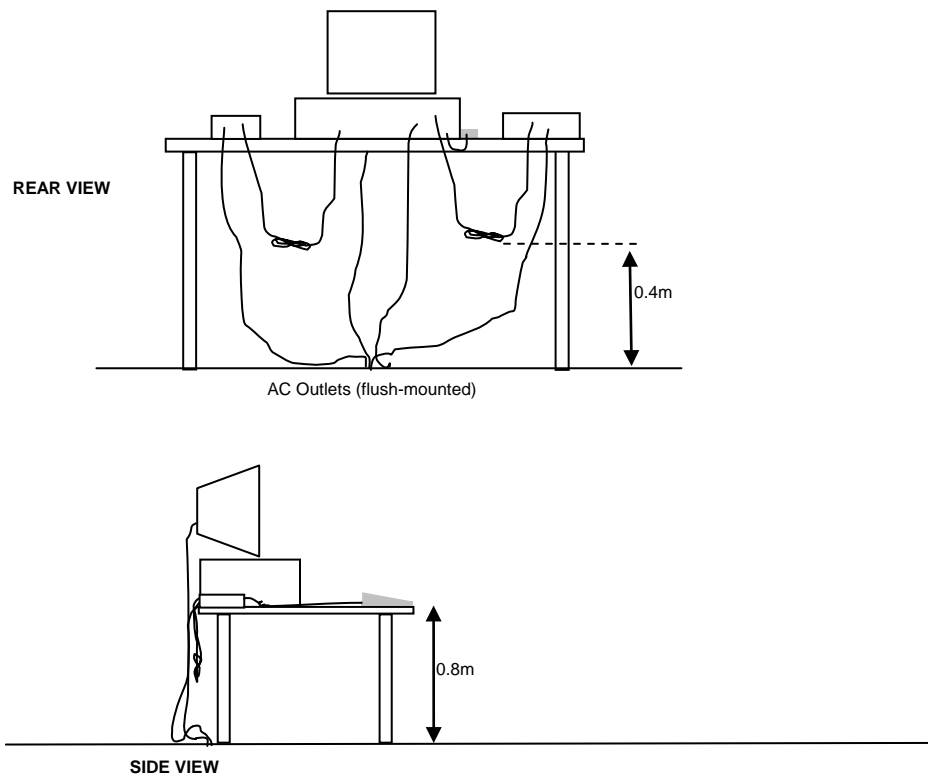

Typical Test Configuration for Radiated Field Strength Measurements

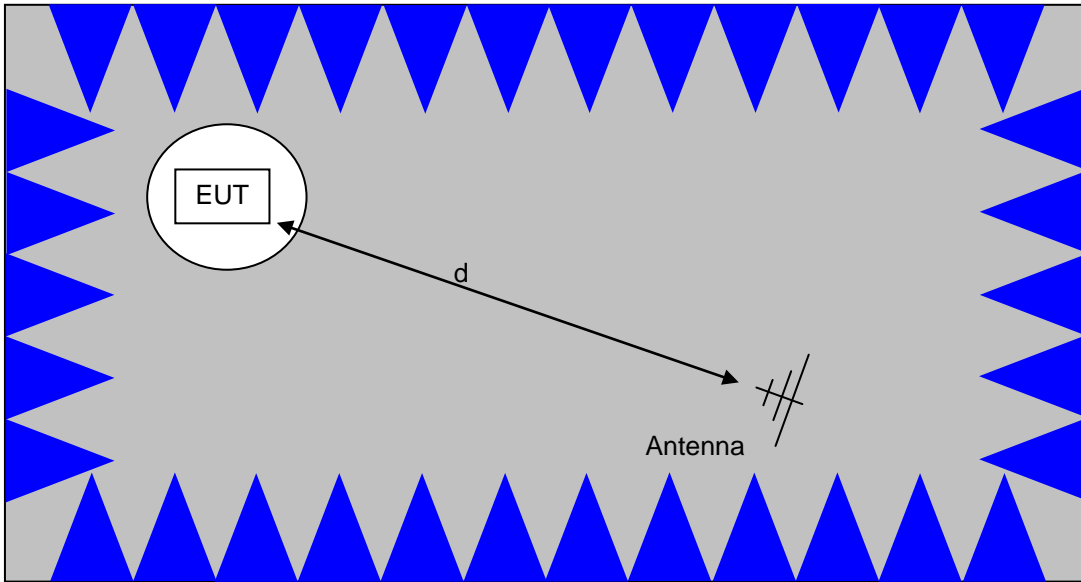

The anechoic materials on the walls and ceiling ensure compliance with the normalized site attenuation requirements of CISPR 16 / CISPR 22 / ANSI C63.4 for an alternate test site at the measurement distances used.

Floor-standing equipment is placed on the floor with insulating supports between the unit and the ground plane.

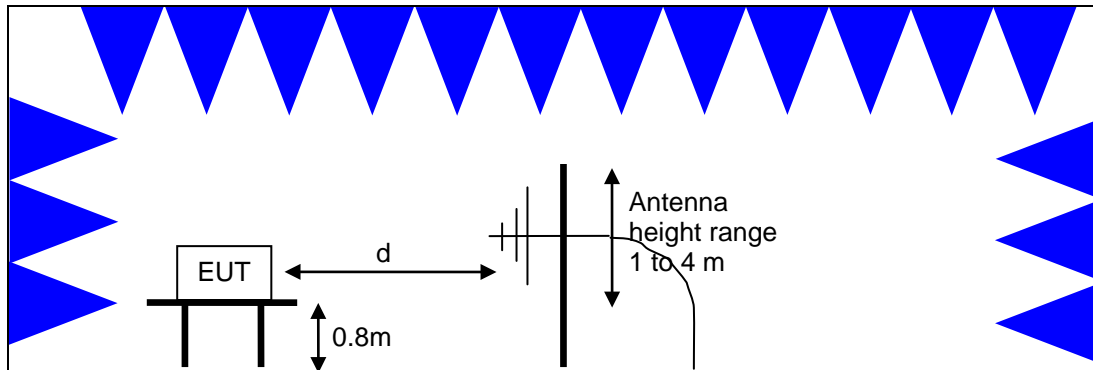

Test Configuration for Radiated Field Strength Measurements  
Semi-Anechoic Chamber, Plan and Side Views

**CONDUCTED EMISSIONS FROM ANTENNA PORT**

Direct measurements of power, bandwidth and power spectral density are performed, where possible, with the antenna port of the EUT connected to either the power meter or spectrum analyzer via a suitable attenuator and/or filter. These are used to ensure that the front end of the measurement instrument is not overloaded by the fundamental transmission.

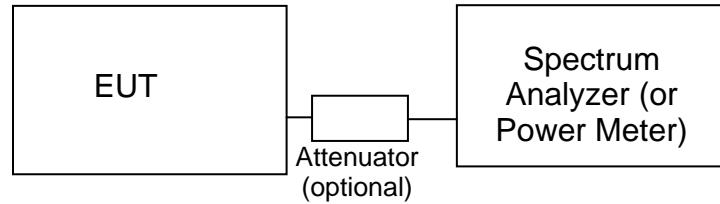
**Test Configuration for Antenna Port Measurements**

Measurement bandwidths (video and resolution) are set in accordance with the relevant standards and NTS Silicon Valley's test procedures for the type of radio being tested. When power measurements are made using a resolution bandwidth less than the signal bandwidth the power is calculated by summing the power across the signal bandwidth using either the analyzer channel power function or by capturing the trace data and calculating the power using software. In both cases the summed power is corrected to account for the equivalent noise bandwidth (ENBW) of the resolution bandwidth used.

If power averaging is used (typically for certain digital modulation techniques), the EUT is configured to transmit continuously. Power averaging is performed using either the built-in function of the analyzer or, if the analyzer does not feature power averaging, using external software. In both cases the average power is calculated over a number of sweeps (typically 100). When the EUT cannot be configured to continuously transmit then either the analyzer is configured to perform a gated sweep to ensure that the power is averaged over periods that the device is transmitting or power averaging is disabled and a max-hold feature is used.

If a power meter is used to make output power measurements the sensor head type (peak or average) is stated in the test data table.

**BANDWIDTH MEASUREMENTS**

The 6dB, 20dB, 26dB and/or 99% signal bandwidth are measured using the bandwidths recommended by ANSI C63.10 and RSS GEN.

**SPECIFICATION LIMITS AND SAMPLE CALCULATIONS**

The limits for conducted emissions are given in units of microvolts, and the limits for radiated emissions are given in units of microvolts per meter at a specified test distance. Data is measured in the logarithmic form of decibels relative to one microvolt, or dB microvolts (dBuV). For radiated emissions, the measured data is converted to the field strength at the antenna in dB microvolts per meter (dBuV/m). The results are then converted to the linear forms of uV and uV/m for comparison to published specifications.

For reference, converting the specification limits from linear to decibel form is accomplished by taking the base ten logarithm, then multiplying by 20. These limits in both linear and logarithmic form are as follows:

**CONDUCTED EMISSIONS SPECIFICATION LIMITS: FCC 15.207; FCC 15.107(a), RSS GEN**

The table below shows the limits for the emissions on the AC power line from an intentional radiator and a receiver.

Frequency (MHz)	Average Limit (dBuV)	Quasi Peak Limit (dBuV)
0.150 to 0.500	Linear decrease on logarithmic frequency axis between 56.0 and 46.0	Linear decrease on logarithmic frequency axis between 66.0 and 56.0
0.500 to 5.000	46.0	56.0
5.000 to 30.000	50.0	60.0



**GENERAL TRANSMITTER RADIATED EMISSIONS SPECIFICATION LIMITS**

The table below shows the limits for the spurious emissions from transmitters that fall in restricted bands<sup>1</sup> (with the exception of transmitters operating under FCC Part 15 Subpart D and RSS 210 Annex 9), the limits for all emissions from a low power device operating under the general rules of RSS 310 (tables 3 and 4), RSS 210 (table 2) and FCC Part 15 Subpart C section 15.209.

Frequency Range (MHz)	Limit (uV/m)	Limit (dBuV/m @ 3m)
0.009-0.490	2400/F <sub>KHz</sub> @ 300m	67.6-20*log <sub>10</sub> (F <sub>KHz</sub> ) @ 300m
0.490-1.705	24000/F <sub>KHz</sub> @ 30m	87.6-20*log <sub>10</sub> (F <sub>KHz</sub> ) @ 30m
1.705 to 30	30 @ 30m	29.5 @ 30m
30 to 88	100 @ 3m	40 @ 3m
88 to 216	150 @ 3m	43.5 @ 3m
216 to 960	200 @ 3m	46.0 @ 3m
Above 960	500 @ 3m	54.0 @ 3m

**RECEIVER RADIATED SPURIOUS EMISSIONS SPECIFICATION LIMITS**

The table below shows the limits for the spurious emissions from receivers as detailed in FCC Part 15.109, RSS 210 Table 2, RSS GEN Table 1 and RSS 310 Table 3. Note that receivers operating outside of the frequency range 30 MHz – 960 MHz are exempt from the requirements of 15.109.

Frequency Range (MHz)	Limit (uV/m @ 3m)	Limit (dBuV/m @ 3m)
30 to 88	100	40
88 to 216	150	43.5
216 to 960	200	46.0
Above 960	500	54.0

**OUTPUT POWER LIMITS – DIGITAL TRANSMISSION SYSTEMS**

The table below shows the limits for output power and output power density. Where the signal bandwidth is less than 20 MHz the maximum output power is reduced to the power spectral density limit plus 10 times the log of the bandwidth (in MHz).

Operating Frequency (MHz)	Output Power	Power Spectral Density
902 – 928	1 Watt (30 dBm)	8 dBm/3kHz
2400 – 2483.5	1 Watt (30 dBm)	8 dBm/3kHz
5725 – 5850	1 Watt (30 dBm)	8 dBm/3kHz

The maximum permitted output power is reduced by 1dB for every dB the antenna gain exceeds 6dBi. Fixed point-to-point applications using the 5725 – 5850 MHz band are not

<sup>1</sup> The restricted bands are detailed in FCC 15.203, RSS 210 Table 1 and RSS 310 Table 2

subject to this restriction.

#### TRANSMIT MODE SPURIOUS RADIATED EMISSIONS LIMITS – FHSS and DTS SYSTEMS

The limits for unwanted (spurious) emissions from the transmitter falling in the restricted bands are those specified in the general limits sections of FCC Part 15 and RSS 210. All other unwanted (spurious) emissions shall be at least 20dB below the level of the highest in-band signal level (30dB if the power is measured using the sample detector/power averaging method).

#### SAMPLE CALCULATIONS - CONDUCTED EMISSIONS

Receiver readings are compared directly to the conducted emissions specification limit (decibel form) as follows:

$$R_r - S = M$$

where:

$R_r$  = Receiver Reading in dBuV

$S$  = Specification Limit in dBuV

$M$  = Margin to Specification in +/- dB

#### SAMPLE CALCULATIONS - RADIATED EMISSIONS

Receiver readings are compared directly to the specification limit (decibel form). The receiver internally corrects for cable loss, preamplifier gain, and antenna factor. The calculations are in the reverse direction of the actual signal flow, thus cable loss is added and the amplifier gain is subtracted. The Antenna Factor converts the voltage at the antenna coaxial connector to the field strength at the antenna elements.

A distance factor, when used for electric field measurements above 30MHz, is calculated by using the following formula:

$$F_d = 20 * \text{LOG}_{10} (D_m/D_s)$$

where:

$F_d$  = Distance Factor in dB

$D_m$  = Measurement Distance in meters

$D_s$  = Specification Distance in meters

For electric field measurements below 30MHz the extrapolation factor is either determined by making measurements at multiple distances or a theoretical value is calculated using the formula:

$$F_d = 40 * \text{LOG}_{10} (D_m/D_s)$$

Measurement Distance is the distance at which the measurements were taken and Specification Distance is the distance at which the specification limits are based. The antenna factor converts the voltage at the antenna coaxial connector to the field strength at the antenna elements.

The margin of a given emission peak relative to the limit is calculated as follows:

$$R_C = R_R + F_d$$

and

$$M = R_C - L_S$$

where:

$R_R$  = Receiver Reading in dBuV/m

$F_d$  = Distance Factor in dB

$R_C$  = Corrected Reading in dBuV/m

$L_S$  = Specification Limit in dBuV/m

$M$  = Margin in dB Relative to Spec

#### SAMPLE CALCULATIONS - FIELD STRENGTH TO EIRP CONVERSION

Where the radiated electric field strength is expressed in terms of the equivalent isotropic radiated power (eirp), or where a field strength measurement of output power is made in lieu of a direct measurement, the following formula is used to convert between eirp and field strength at a distance of d (meters) from the equipment under test:

$$E = \frac{1000000 \sqrt{30 P}}{d} \text{ microvolts per meter}$$

where P is the eirp (Watts)

For a measurement at 3m the conversion from a logarithmic value for field strength (dBuV/m) to an eirp power (dBm) is -95.3dB.

## Appendix A Test Equipment Calibration Data

### Conducted Emissions - AC Power Ports, 25-Jun-14

<u>Manufacturer</u>	<u>Description</u>	<u>Model</u>	<u>Asset #</u>	<u>Cal Due</u>
EMCO	LISN, 10 kHz-100 MHz	3825/2	1293	2/13/2015
Rohde & Schwarz	Pulse Limiter	ESH3 Z2	1594	5/15/2015
Rohde & Schwarz	EMI Test Receiver, 20 Hz-7 GHz	ESIB7	1756	6/14/2015

### Radiated Spurious Emissions, 1000 - 25,000 MHz, 02-Jul-14

<u>Manufacturer</u>	<u>Description</u>	<u>Model</u>	<u>Asset #</u>	<u>Cal Due</u>
Hewlett Packard	SpecAn 9 kHz - 40 GHz, FT (SA40) Blue	8564E (84125C)	1393	5/6/2015
Rohde & Schwarz	EMI Test Receiver, 20 Hz-7 GHz	ESIB7	1538	12/14/2014
Hewlett Packard	Microwave Preamplifier, 1-26.5GHz	8449B	1780	11/26/2014
Micro-Tronics	Band Reject Filter, 2400-2500 MHz	BRM50702-02	2238	9/18/2014
EMCO	Antenna, Horn, 1-18 GHz	3115	2870	8/20/2015
Hewlett Packard	Head (Inc flex cable, (1742,1743) Blue)	84125C	1620	5/6/2015
A. H. Systems	Purple System Horn, 18-40GHz	SAS-574, p/n: 2581	2160	7/28/2014

### Radiated Spurious Emissions, 30 - 9000 MHz, 03-Jul-14

<u>Manufacturer</u>	<u>Description</u>	<u>Model</u>	<u>Asset #</u>	<u>Cal Due</u>
Hewlett Packard	SpecAn 9 kHz - 40 GHz, FT (SA40) Blue	8564E (84125C)	1393	5/6/2015
Rohde & Schwarz	EMI Test Receiver, 20 Hz-7 GHz	ESIB7	1538	12/14/2014
Hewlett Packard	Microwave Preamplifier, 1-26.5GHz	8449B	1780	11/26/2014
Sunol Sciences	Biconilog, 30-3000 MHz	JB3	2197	2/13/2016
Com-Power	Preamplifier, 30-1000 MHz	PA-103	2465	9/13/2014
EMCO	Antenna, Horn, 1-18 GHz	3115	2870	8/20/2015

### Radio Antenna Port (Power and Spurious Emissions), 08-Jul-14

<u>Manufacturer</u>	<u>Description</u>	<u>Model</u>	<u>Asset #</u>	<u>Cal Due</u>
Rohde & Schwarz	Power Meter, Dual Channel	NRVD	1071	3/24/2015
Rohde & Schwarz	Power Sensor 100 uW - 2 Watts (w/ 20 dB pad, SN BJ5155)	NRV-Z32	1536	12/19/2014
Agilent Technologies	PSA, Spectrum Analyzer, (installed options, 111, 115, 123, 1DS, B7J, HYX,	E4446A	2139	4/8/2015

## **Appendix B Test Data**

T95652 Pages 22 – 25

T95582 Pages 26 – 48



# EMC Test Data

Client:	Fitbit, Inc.	Job Number:	J95442
Product:	FB405 (CHARGE HR)	T-Log Number:	T95652
		Project Manager:	Deepa Shetty
Contact:	Arndt Hufenbach	Project Coordinator:	
Emissions Standard(s):	FCC Part 15B, CISPR/EN 55022, VCCI, AS/NZS	Class:	B
Immunity Standard(s):	EN 55024, EN 301 -489-1, -17	Environment:	Residential

## EMC Test Data

For The

**Fitbit, Inc.**

Product

FB405 (CHARGE HR)

Date of Last Test: 6/30/2014



# EMC Test Data

Client: Fitbit, Inc.	Job Number: J95442
Model: FB405 (CHARGE HR)	T-Log Number: T95652
	Project Manager: Deepa Shetty
Contact: Arndt Hufenbach	Project Coordinator: -
Standard: FCC Part 15B, CISPR/EN 55022, VCCI, AS/NZS CISPR 22, CNS 13438 &	Class: B

## Conducted Emissions

*(Elliott Laboratories Fremont Facility, Semi-Anechoic Chamber)*

### Test Specific Details

Objective: The objective of this test session is to perform final qualification testing of the EUT with respect to the specification listed above.

Date of Test: 6/25/2014  
 Test Engineer: Alike Hirano  
 Test Location: Fremont Chamber #3

Config. Used: 1  
 Config Change: None  
 EUT Voltage: Refer to individual run

### General Test Configuration

For tabletop equipment, the EUT was located on a wooden table inside the semi-anechoic chamber, 40 cm from a vertical coupling plane and 80cm from the LISN.

**Ambient Conditions:** Temperature: 23 °C  
 Rel. Humidity: 35 %

### Summary of Results

Run #	Test Performed	Limit	Result	Margin
2	CE, AC Power, 110V/60Hz	FCC 15.207	Pass	26.3 dBµV @ 0.625 MHz (-19.7 dB)

### Modifications Made During Testing

No modifications were made to the EUT during testing

### Deviations From The Standard

No deviations were made from the requirements of the standard.

Client: Fitbit, Inc.	Job Number: J95442
Model: FB405 (CHARGE HR)	T-Log Number: T95652
Contact: Arndt Hufenbach	Project Manager: Deepa Shetty
Standard: FCC Part 15B, CISPR/EN 55022, VCCI, AS/NZS CISPR 22, CNS 13438 &	Project Coordinator: -
	Class: B

Run #2: AC Power Port Conducted Emissions, 0.15 - 30MHz, 110V/60Hz

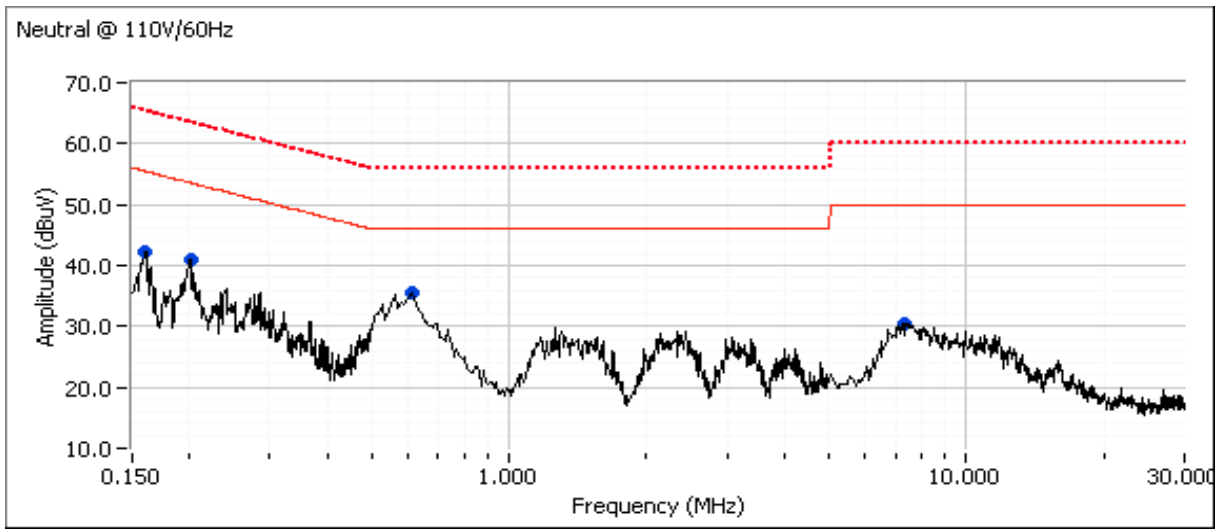
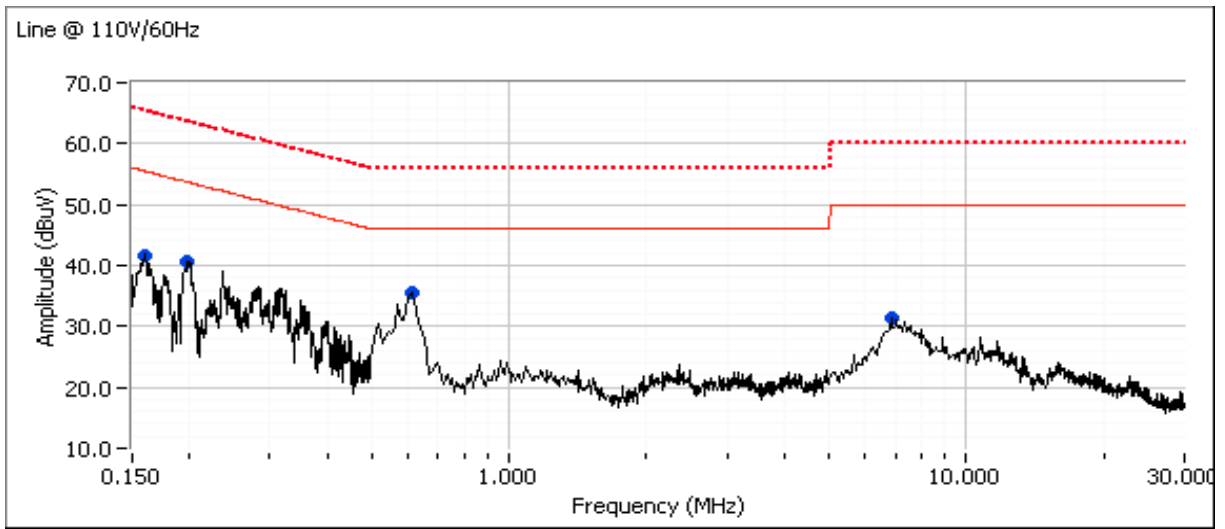





# EMC Test Data

Client: Fitbit, Inc.	Job Number: J95442
Model: FB405 (CHARGE HR)	T-Log Number: T95652
	Project Manager: Deepa Shetty
Contact: Arndt Hufenbach	Project Coordinator: -
Standard: FCC Part 15B, CISPR/EN 55022, VCCI, AS/NZS CISPR 22, CNS 13438 &	Class: B

### Preliminary peak readings captured during pre-scan (peak readings vs. average limit)

Frequency MHz	Level dB $\mu$ V	AC Line	Class B		Detector QP/Ave	Comments
			Limit	Margin		
0.160	41.7	Line 1	55.4	-13.7	Peak	
0.198	40.7	Line 1	53.7	-13.0	Peak	
0.613	35.5	Line 1	46.0	-10.5	Peak	
6.870	31.4	Line 1	50.0	-18.6	Peak	
0.161	42.3	Neutral	55.4	-13.1	Peak	
0.202	41.0	Neutral	53.6	-12.6	Peak	
0.625	35.4	Neutral	46.0	-10.6	Peak	
7.319	30.4	Neutral	50.0	-19.6	Peak	

### Final quasi-peak and average readings

Frequency MHz	Level dB $\mu$ V	AC Line	Class B		Detector QP/Ave	Comments
			Limit	Margin		
<b>0.625</b>	<b>26.3</b>	Neutral	46.0	<b>-19.7</b>	AVG	AVG (0.10s)
0.613	22.5	Line 1	46.0	-23.5	AVG	AVG (0.10s)
0.625	32.5	Neutral	56.0	-23.5	QP	QP (1.00s)
0.613	31.6	Line 1	56.0	-24.4	QP	QP (1.00s)
0.198	38.4	Line 1	63.7	-25.3	QP	QP (1.00s)
0.160	38.7	Line 1	65.5	-26.8	QP	QP (1.00s)
0.202	26.1	Neutral	53.5	-27.4	AVG	AVG (0.10s)
0.161	37.6	Neutral	65.4	-27.8	QP	QP (1.00s)
0.202	35.7	Neutral	63.5	-27.8	QP	QP (1.00s)
0.198	24.7	Line 1	53.7	-29.0	AVG	AVG (0.10s)
6.870	20.8	Line 1	50.0	-29.2	AVG	AVG (0.10s)
0.161	25.6	Neutral	55.4	-29.8	AVG	AVG (0.10s)
0.160	25.5	Line 1	55.5	-30.0	AVG	AVG (0.10s)
7.319	19.2	Neutral	50.0	-30.8	AVG	AVG (0.10s)
7.319	23.3	Neutral	60.0	-36.7	QP	QP (1.00s)
6.870	22.7	Line 1	60.0	-37.3	QP	QP (1.00s)



## EMC Test Data

Client:	Fitbit, Inc.	Job Number:	J95442
Product:	FB405 (CHARGE HR)	T-Log Number:	T95582
		Project Manager:	Deepa Shetty
Contact:	Arndt Hufenbach	Project Coordinator:	Irene Rademacher
Emissions Standard(s):	FCC 15.247/RSS-210/LP 00002	Class:	-
Immunity Standard(s):	-	Environment:	-

# EMC Test Data

For The

## Fitbit, Inc.

Product

FB405 (CHARGE HR)

Date of Last Test: 7/8/2014



# EMC Test Data

Client: Fitbit, Inc.	Job Number: J95442
Model: FB405 (CHARGE HR)	T-Log Number: T95582
	Project Manager: Deepa Shetty
Contact: Arndt Hufenbach	Project Coordinator: Irene Rademacher
Standard: FCC 15.247/RSS-210/LP 00002	Class: N/A

## RSS 210 and FCC 15.247 (DTS) Radiated Spurious Emissions

### Test Specific Details

Objective: The objective of this test session is to perform final qualification testing of the EUT with respect to the specification listed above.

### General Test Configuration

The EUT and all local support equipment were located on the turntable for radiated spurious emissions testing. For radiated emissions testing the measurement antenna was located 3 meters from the EUT, unless otherwise noted.

### Ambient Conditions:

Temperature: 25 °C  
Rel. Humidity: 34 %

### Summary of Results - Device Operating in the 2400-2483.5 MHz Band

Run #	Mode	Channel	Target Power	Power Setting	Test Performed	Limit	Result / Margin
1	BLE	2402MHz	Default	Default	Restricted Band Edge (2390 MHz)	FCC Part 15.209 / 15.247( c)	36.1 dBµV/m @ 2386.2 MHz (-17.9 dB)
	BLE	2480MHz			Restricted Band Edge (2483.5 MHz)		37.8 dBµV/m @ 2483.5 MHz (-16.2 dB)

### Modifications Made During Testing

No modifications were made to the EUT during testing

### Deviations From The Standard

No deviations were made from the requirements of the standard.

### Sample Notes

Sample S/N: 6-158  
Driver: F13.1  
Antenna: internal

### Notes

Device is handheld. Determination of worse case orientation was done as a measurement of the fundamental at the center channel.

Client: Fitbit, Inc.	Job Number: J95442
Model: FB405 (CHARGE HR)	T-Log Number: T95582
	Project Manager: Deepa Shetty
Contact: Arndt Hufenbach	Project Coordinator: Irene Rademacher
Standard: FCC 15.247/RSS-210/LP 00002	Class: N/A

### Procedure Comments:

Measurements performed in accordance with FCC KDB 558074

Peak measurements performed with: RBW=1MHz, VBW=3MHz, peak detector, max hold, auto sweep time

Unless otherwise stated/noted, emission has duty cycle  $\geq 98\%$  and was measured using RBW=1MHz, VBW=10Hz, peak detector, linear average mode, auto sweep time, max hold.

Mode	Data Rate	Duty Cycle (x)	Constant DC?	T (ms)	Pwr Cor Factor*	Lin Volt Cor Factor**	Min VBW for FS (Hz)
LE	1 Mb/s	0.60	Yes	0.376	2.2069217	4.4138434	2660

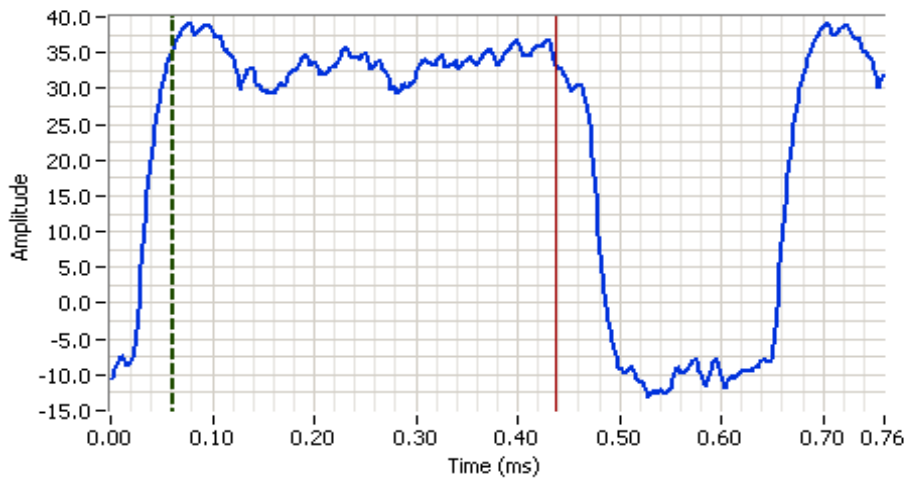

**Analyzer Settings**

Rohde&Schwarz, ESI  
 CF: 2440.000 MHz  
 SPAN: 0.000 MHz  
 RB: 100 kHz  
 VB: 10.0 kHz  
 Detector: POS  
 Attn: 0 DB  
 RL Offset: 0.0 DB  
 Sweep Time: 0.8ms  
 Ref Lvl: 51.0 DBUV

---

**Comments**

BTLE on time = .376 ms

Cursor 1	0.0614	42.35		Delta Time (ms)	0.376
Cursor 2	0.4374	42.87		Delta Amplitude	0.52

Client: Fitbit, Inc.	Job Number: J95442
Model: FB405 (CHARGE HR)	T-Log Number: T95582
Contact: Arndt Hufenbach	Project Manager: Deepa Shetty
Standard: FCC 15.247/RSS-210/LP 00002	Project Coordinator: Irene Rademacher
	Class: N/A

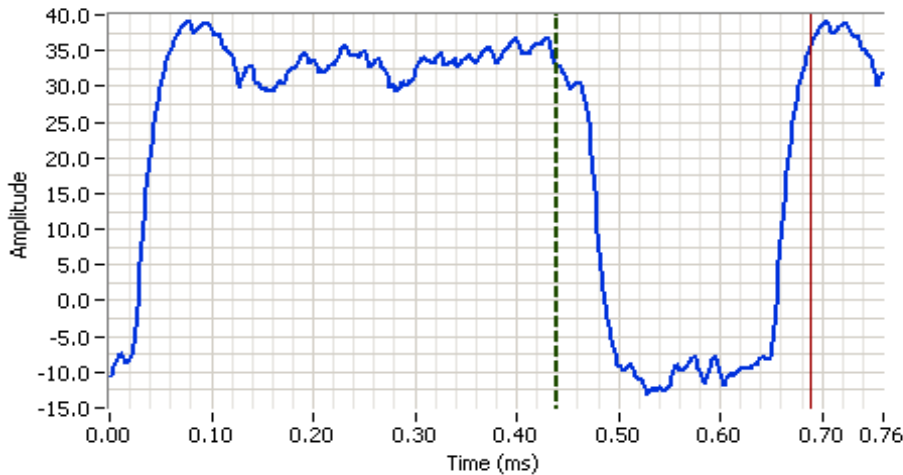

**Analyzer Settings**  
 Rohde&Schwarz,ESI  
 CF: 2440.000 MHz  
 SPAN: 0.000 MHz  
 RB: 100 kHz  
 VB: 10.0 kHz  
 Detector: POS  
 Attn: 0 DB  
 RL Offset: 0.0 DB  
 Sweep Time: 0.8ms  
 Ref Lvl: 51.0 DBUV

**Comments**  
 BTLE off time = .249 ms

Cursor 1	0.4394	42.35	↕	↔	🔒	Delta Time (ms)	0.249
Cursor 2	0.6887	42.87	↕	↔	🔒	Delta Amplitude	0.52

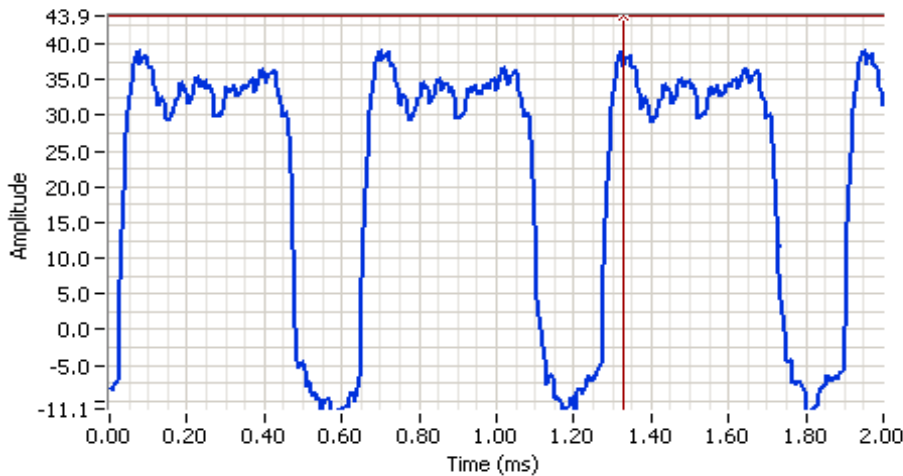

**Analyzer Settings**  
 Rohde&Schwarz,ESI  
 CF: 2440.000 MHz  
 SPAN: 0.000 MHz  
 RB: 100 kHz  
 VB: 10.0 kHz  
 Detector: POS  
 Attn: 0 DB  
 RL Offset: 0.0 DB  
 Sweep Time: 2.0ms  
 Ref Lvl: 51.0 DBUV

**Comments**  
 BTLE constant duty cycle

Cursor 1	-0.2812	45.21	↕	↔	🔒	Delta Time (ms)	1.608
Cursor 2	1.3267	43.91	↕	↔	🔒	Delta Amplitude	1.30





# EMC Test Data

Client: Fitbit, Inc.	Job Number: J95442
Model: FB405 (CHARGE HR)	T-Log Number: T95582
	Project Manager: Deepa Shetty
Contact: Arndt Hufenbach	Project Coordinator: Irene Rademacher
Standard: FCC 15.247/RSS-210/LP 00002	Class: N/A

### Measurement Specific Notes:

Note 3:	Emission has duty cycle < 98%, but constant, average measurement performed: RBW=1MHz, VBW=10Hz, peak detector, linear averaging, auto sweep, trace average 100 traces, measurement corrected by Linear Voltage correction factor
Note 6:	Plots of the average and peak bandedge do not account for any duty cycle correction. Refer to the tabular results for final measurements.



# EMC Test Data

Client: Fitbit, Inc.	Job Number: J95442
Model: FB405 (CHARGE HR)	T-Log Number: T95582
	Project Manager: Deepa Shetty
Contact: Arndt Hufenbach	Project Coordinator: Irene Rademacher
Standard: FCC 15.247/RSS-210/LP 00002	Class: N/A

## Run #0: Worse Case Orientation

Date of Test: 7/2/2014 0:00  
 Test Engineer: John Caizzi  
 Test Location: Chamber 7

Config. Used: 1  
 Config Change: none  
 EUT Voltage: Internal 3.7 VDC battery

Channel: 2441MHz                      Mode: LE  
 Tx Chain: Main                      Data Rate: 1 Mb/s

Frequency	Level	Pol	15.209 / 15.247		Detector	Azimuth	Height	Comments
MHz	dB $\mu$ V/m	v/h	Limit	Margin	Pk/QP/Avg	degrees	meters	
2440.270	83.8	V	-	-	Pk	216	1.00	Side
2440.010	96.3	H	-	-	Pk	25	1.82	Side
2439.750	97.0	V	-	-	Pk	150	1.00	Upright
2440.010	87.6	H	-	-	Pk	222	1.63	Upright
2440.010	92.7	V	-	-	Pk	262	1.00	Face down
2440.290	95.9	H	-	-	Pk	184	1.85	Face down

Note 7 All measurements made with RBW = 100 kHz, VBW = 300 kHz.



# EMC Test Data

Client: Fitbit, Inc.	Job Number: J95442
Model: FB405 (CHARGE HR)	T-Log Number: T95582
	Project Manager: Deepa Shetty
Contact: Arndt Hufenbach	Project Coordinator: Irene Rademacher
Standard: FCC 15.247/RSS-210/LP 00002	Class: N/A

## Run #1: Radiated Bandedge Measurements

Date of Test: 7/2/2014 0:00  
 Test Engineer: John Caizzi  
 Test Location: Chamber 7

Config. Used: 1  
 Config Change: none  
 EUT Voltage: Internal 3.7 VDC battery

Channel: 2402 MHz      Mode: LE  
 Tx Chain: Main      Data Rate: 1 Mb/s

### Band Edge Signal Field Strength - Direct measurement of field strength

Frequency MHz	Level dB $\mu$ V/m	Pol v/h	15.209 / 15.247		Detector Pk/QP/Avg	Azimuth degrees	Height meters	Comments
			Limit	Margin				
2386.150	36.1	V	54.0	-17.9	AVG	189	1.31	Note 3
2374.530	43.8	V	74.0	-30.2	PK	189	1.31	
2374.770	29.3	H	54.0	-24.7	AVG	0	1.00	Noise floor
2379.500	41.6	H	74.0	-32.4	PK	0	1.00	Noise floor

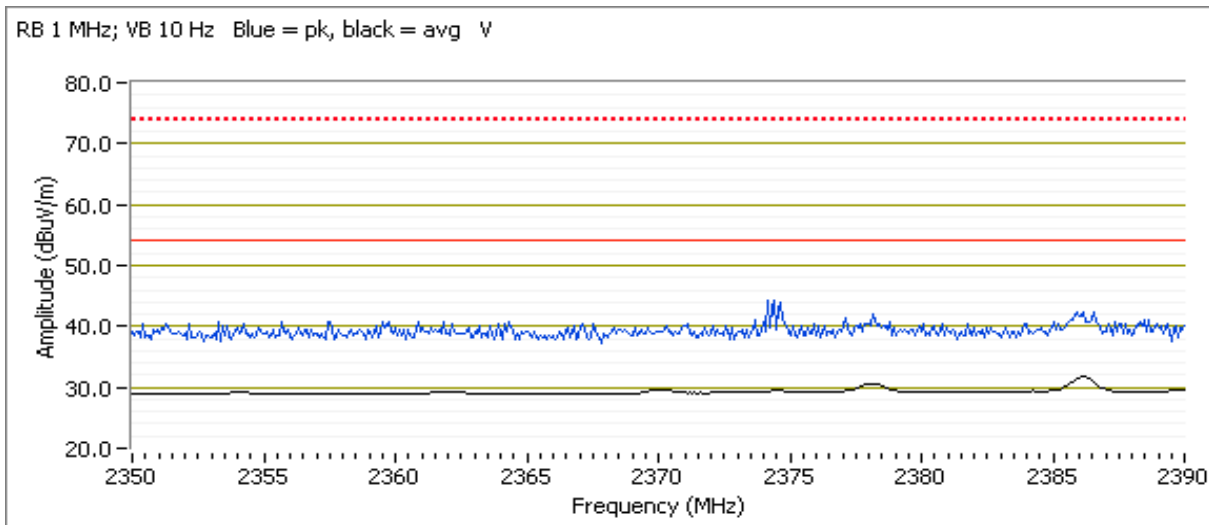





# EMC Test Data

Client: Fitbit, Inc.	Job Number: J95442
Model: FB405 (CHARGE HR)	T-Log Number: T95582
Contact: Arndt Hufenbach	Project Manager: Deepa Shetty
Standard: FCC 15.247/RSS-210/LP 00002	Project Coordinator: Irene Rademacher
	Class: N/A

Channel: 2480 MHz      Mode: LE  
 Tx Chain: Main      Data Rate: 1 Mb/s

### Band Edge Signal Field Strength - Direct measurement of field strength

Frequency	Level	Pol	15.209 / 15.247		Detector	Azimuth	Height	Comments
MHz	dB $\mu$ V/m	v/h	Limit	Margin	PK/QP/Avg	degrees	meters	
2483.500	37.8	V	54.0	-16.2	AVG	184	1.28	Note 3
2483.730	52.5	V	74.0	-21.5	PK	184	1.28	

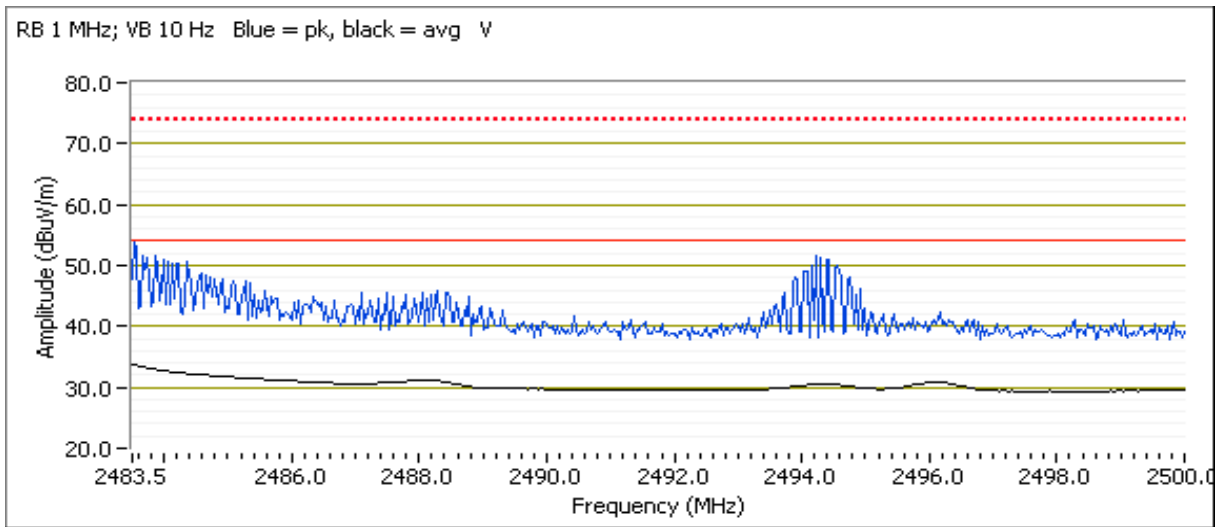



# EMC Test Data

Client: Fitbit, Inc.	Job Number: J95442
Model: FB405 (CHARGE HR)	T-Log Number: T95582
	Project Manager: Deepa Shetty
Contact: Arndt Hufenbach	Project Coordinator: Irene Rademacher
Standard: FCC 15.247/RSS-210/LP 00002	Class: N/A

## RSS 210 and FCC 15.247 (DTS) Radiated Spurious Emissions

### Test Specific Details

Objective: The objective of this test session is to perform final qualification testing of the EUT with respect to the specification listed above.

### General Test Configuration

The EUT and all local support equipment were located on the turntable for radiated spurious emissions testing.

For radiated emissions testing the measurement antenna was located 3 meters from the EUT, unless otherwise noted.

### Ambient Conditions:

Temperature: 25 °C  
Rel. Humidity: 34 %

### Summary of Results - Device Operating in the 2400-2483.5 MHz Band

Run #	Mode	Channel	Target Power	Power Setting	Test Performed	Limit	Result / Margin
1	LE - GFSK	2402MHz	Default	Default	Radiated Emissions, 1 - 25 GHz	FCC Part 15.209 / 15.247( c)	48.3 dBµV/m @ 4804.0 MHz (-5.7 dB)
		2441MHz					48.3 dBµV/m @ 4880.0 MHz (-5.7 dB)
		2480MHz					45.7 dBµV/m @ 4960.0 MHz (-8.3 dB)

### Modifications Made During Testing

No modifications were made to the EUT during testing

### Deviations From The Standard

No deviations were made from the requirements of the standard.

### Sample Notes

Sample S/N: 6-158  
Driver: F13.1  
Antenna: internal

### Notes

Device is handheld. Determination of worse case orientation was done as a measurement of spurious emissions on center channel.



# EMC Test Data

Client: Fitbit, Inc.	Job Number: J95442
Model: FB405 (CHARGE HR)	T-Log Number: T95582
	Project Manager: Deepa Shetty
Contact: Arndt Hufenbach	Project Coordinator: Irene Rademacher
Standard: FCC 15.247/RSS-210/LP 00002	Class: N/A

## Procedure Comments:

Measurements performed in accordance with FCC KDB 558074

Peak measurements performed with: RBW=1MHz, VBW=3MHz, peak detector, max hold, auto sweep time

Unless otherwise stated/noted, emission has duty cycle  $\geq 98\%$  and was measured using RBW=1MHz, VBW=10Hz, peak detector, linear average mode, auto sweep time, max hold.

2.4GHz band reject filter used

Preliminary testing showed no radio related emissions below 1GHz.

Mode	Data Rate	Duty Cycle (x)	Constant DC?	T (ms)	Pwr Cor Factor*	Lin Volt Cor Factor**	Min VBW for FS (Hz)
LE	1 Mb/s	0.60	Yes	0.376	2.2069217	4.4138434	2660

## Measurement Specific Notes:

Note 1:	Emission in non-restricted band, but limit of 15.209 used.
Note 2:	Emission in non-restricted band, the limit was set 30dB below the level of the fundamental and measured in 100kHz.
Note 3:	Emission has duty cycle $< 98\%$ , but constant, average measurement performed: RBW=1MHz, VBW=10Hz, peak detector, linear averaging, auto sweep, trace average 100 traces, measurement corrected by Linear Voltage correction factor

Client: Fitbit, Inc.	Job Number: J95442
Model: FB405 (CHARGE HR)	T-Log Number: T95582
Contact: Arndt Hufenbach	Project Manager: Deepa Shetty
Standard: FCC 15.247/RSS-210/LP 00002	Project Coordinator: Irene Rademacher
	Class: N/A

**Run #1: Radiated Spurious Emissions, 1,000 - 25000 MHz. Operating Mode: LE - GFSK**

Date of Test: 7/2/2014 0:00  
 Test Engineer: John Caizzi  
 Test Location: Chamber 7

Config. Used: 1  
 Config Change: none  
 EUT Voltage: Internal 3.7 VDC battery

**Run #1a: Low Channel**

Channel: 2402                      Mode: LE  
 Tx Chain: Main                    Data Rate: 1 Mb/s

Frequency	Level	Pol	15.209 / 15.247		Detector	Azimuth	Height	Comments
MHz	dB $\mu$ V/m	v/h	Limit	Margin	Pk/QP/Avg	degrees	meters	
4803.980	48.3	H	54.0	-5.7	AVG	258	1.31	
4804.580	51.7	H	74.0	-22.3	PK	258	1.31	

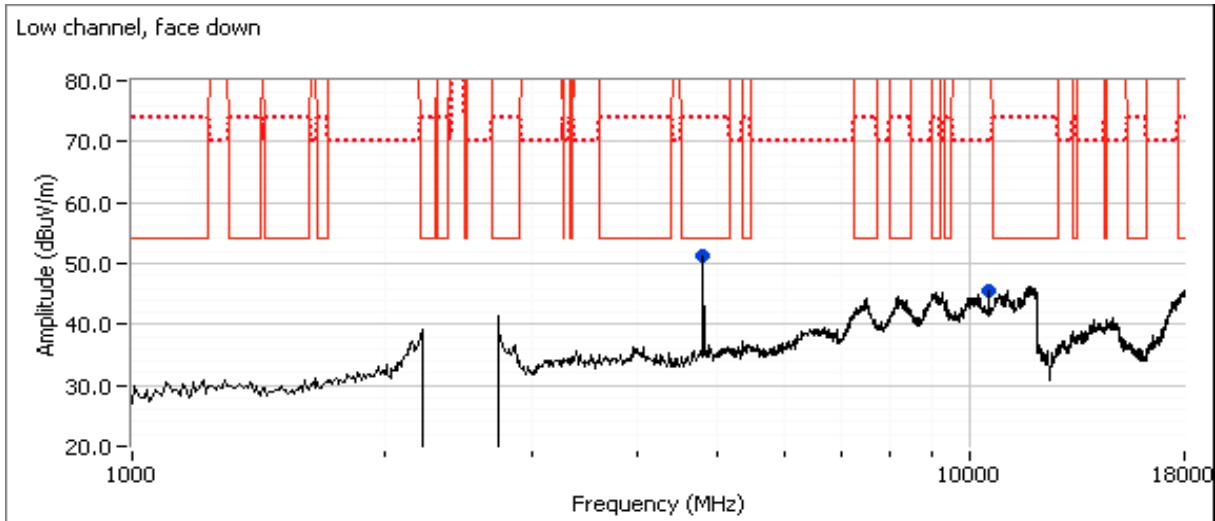

Client: Fitbit, Inc.	Job Number: J95442
Model: FB405 (CHARGE HR)	T-Log Number: T95582
	Project Manager: Deepa Shetty
Contact: Arndt Hufenbach	Project Coordinator: Irene Rademacher
Standard: FCC 15.247/RSS-210/LP 00002	Class: N/A

### Run #1b: Center Channel

Channel: 2440                      Mode: LE  
 Tx Chain: Main                      Data Rate: 1 Mb/s

Frequency MHz	Level dB $\mu$ V/m	Pol v/h	15.209 / 15.247		Detector PK/QP/Avg	Azimuth degrees	Height meters	Comments
			Limit	Margin				
4879.930	46.9	V	54.0	-7.1	AVG	258	1.27	Upright, note 3
4879.470	50.2	V	74.0	-23.8	PK	258	1.27	Upright
4880.020	45.8	V	54.0	-8.2	AVG	250	1.34	Side, note 3
4880.600	49.4	V	74.0	-24.6	PK	250	1.34	Side
4880.020	47.2	H	54.0	-6.8	AVG	209	1.30	Side, note 3
4880.530	50.6	H	74.0	-23.4	PK	209	1.30	Side
4879.930	43.9	V	54.0	-10.1	AVG	258	1.06	Face down, note 3
4880.020	48.2	V	74.0	-25.8	PK	258	1.06	Face down
4879.970	48.3	H	54.0	-5.7	AVG	254	1.12	Face down, note 3
4879.630	51.6	H	74.0	-22.4	PK	254	1.12	Face down

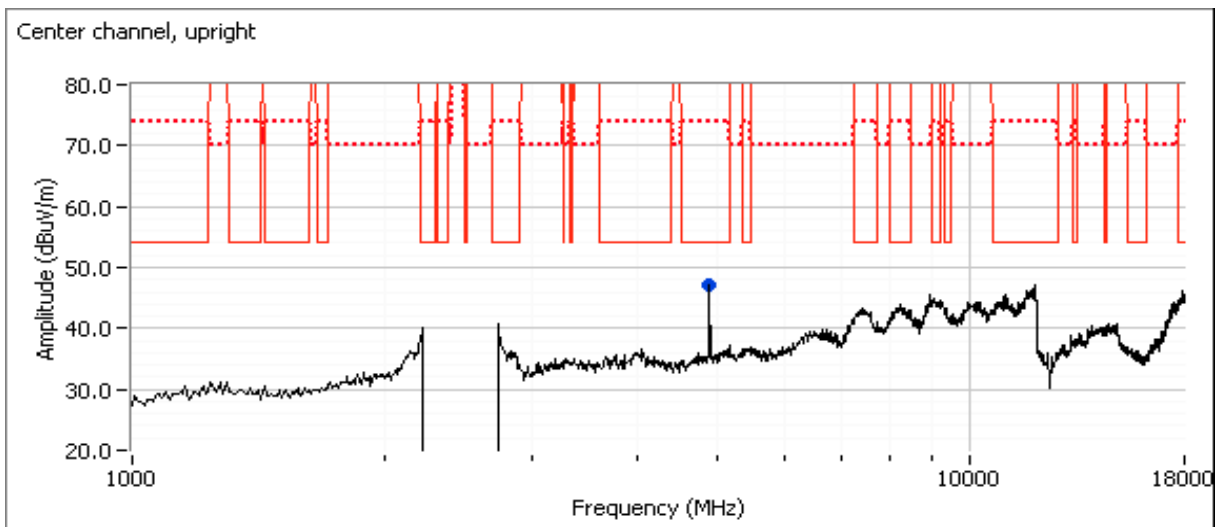

Client: Fitbit, Inc.	Job Number: J95442
Model: FB405 (CHARGE HR)	T-Log Number: T95582
	Project Manager: Deepa Shetty
Contact: Arndt Hufenbach	Project Coordinator: Irene Rademacher
Standard: FCC 15.247/RSS-210/LP 00002	Class: N/A

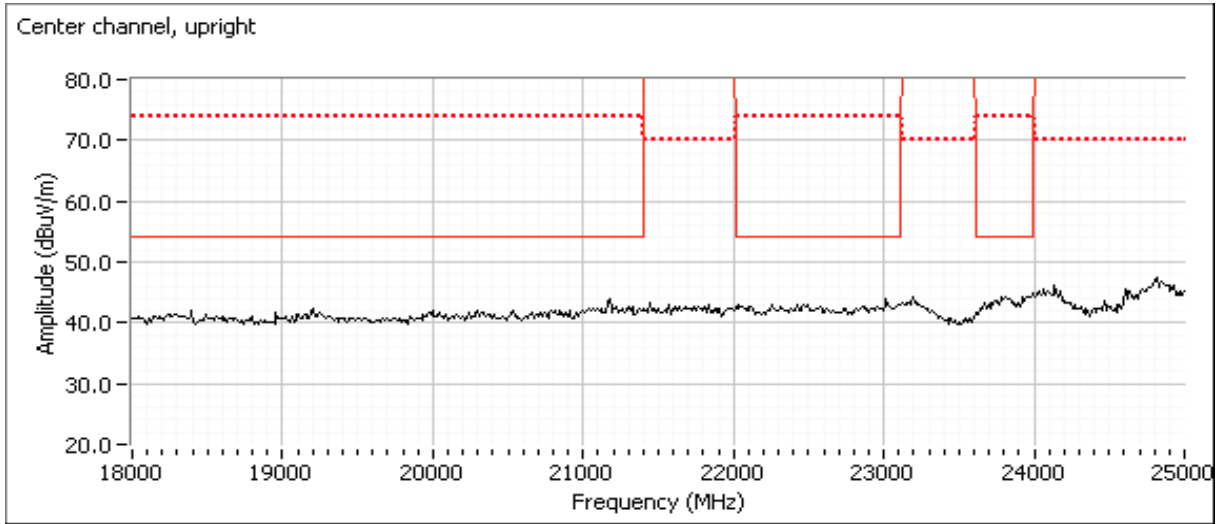



# EMC Test Data

Client: Fitbit, Inc.	Job Number: J95442
Model: FB405 (CHARGE HR)	T-Log Number: T95582
Contact: Arndt Hufenbach	Project Manager: Deepa Shetty
Standard: FCC 15.247/RSS-210/LP 00002	Project Coordinator: Irene Rademacher
	Class: N/A

## Run #1c: High Channel

Channel: 2480 MHz      Mode: LE  
 Tx Chain: Main      Data Rate: 1 Mb/s

Frequency	Level	Pol	15.209 / 15.247		Detector	Azimuth	Height	Comments
MHz	dB $\mu$ V/m	v/h	Limit	Margin	PK/QP/Avg	degrees	meters	
4960.010	45.7	H	54.0	-8.3	AVG	266	1.26	Face down, note 3
4959.550	49.5	H	74.0	-24.5	PK	266	1.26	Face down

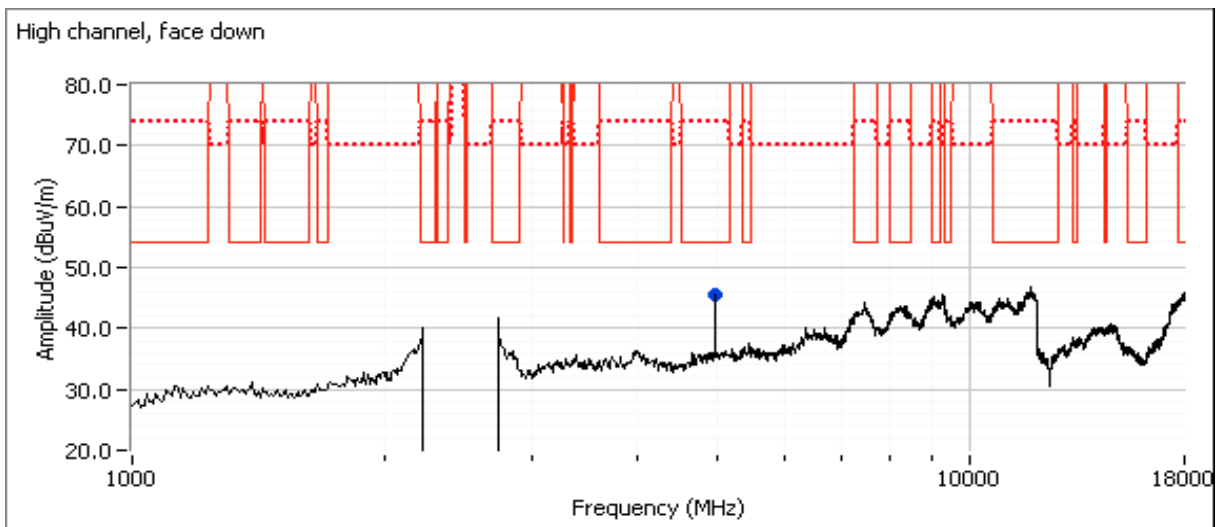



# EMC Test Data

Client: Fitbit, Inc.	Job Number: J95442
Model: FB405 (CHARGE HR)	T-Log Number: T95582
	Project Manager: Deepa Shetty
Contact: Arndt Hufenbach	Project Coordinator: Irene Rademacher
Standard: FCC 15.247/RSS-210/LP 00002	Class: N/A

## RSS 210 and FCC 15.247 (DTS) Antenna Port Measurements Power, PSD, Bandwidth and Spurious Emissions

### Test Specific Details

Objective: The objective of this test session is to perform final qualification testing of the EUT with respect to the specification listed above.

Date of Test: 7/7/2014  
 Test Engineer: John Caizzi  
 Test Location: Lab 4A

Config. Used: 1  
 Config Change: Direct connection to attached pigtail connector.  
 EUT Voltage: Internal battery

### General Test Configuration

The EUT was connected to the spectrum analyzer or power meter via a suitable attenuator.

All measurements have been corrected to allow for the external attenuators used.

### Ambient Conditions:

Temperature: 24 °C  
 Rel. Humidity: 37 %

### Summary of Results

Run #	Pwr setting	Avg Pwr	Test Performed	Limit	Pass / Fail	Result / Margin
1	Default		Output Power	15.247(b)	Pass	0.9 dBm (1.2mW)
2			Power spectral Density (PSD)	15.247(d)	Pass	-5.0 dBm/10kHz
3			Minimum 6dB Bandwidth	15.247(a)	Pass	700 kHz
3			99% Bandwidth	RSS GEN	-	1572 kHz
4			Spurious emissions	15.247(b)	Pass	All spurious < -20 dBc

### Modifications Made During Testing

No modifications were made to the EUT during testing

### Deviations From The Standard

No deviations were made from the requirements of the standard.

### Procedure Comments:

Measurements performed in accordance with FCC KDB 558074





# EMC Test Data

Client: Fitbit, Inc.	Job Number: J95442
Model: FB405 (CHARGE HR)	T-Log Number: T95582
	Project Manager: Deepa Shetty
Contact: Arndt Hufenbach	Project Coordinator: Irene Rademacher
Standard: FCC 15.247/RSS-210/LP 00002	Class: N/A

Mode	Data Rate	Duty Cycle (x)	Constant DC?	T (ms)	Pwr Cor Factor*	Lin Volt Cor Factor**	Min VBW for FS (Hz)
LE	1 Mb/s	0.60	Yes	0.376	2.2069217	4.4138434	2660

## Sample Notes

Sample S/N: 6-156  
 Driver: F13.1



# EMC Test Data

Client: Fitbit, Inc.	Job Number: J95442
Model: FB405 (CHARGE HR)	T-Log Number: T95582
	Project Manager: Deepa Shetty
Contact: Arndt Hufenbach	Project Coordinator: Irene Rademacher
Standard: FCC 15.247/RSS-210/LP 00002	Class: N/A

## Run #1: Output Power

Mode: LE

Power Setting <sup>2</sup>	Frequency (MHz)	Output Power		Antenna Gain (dBi)	Result	EIRP		Output Power	
		(dBm) <sup>1</sup>	mW			dBm	W	(dBm) <sup>3</sup>	mW
Default	2402	0.5	1.1	1.7	Pass	2.2	0.002		
	2440	0.9	1.2	1.7	Pass	2.6	0.002		
	2480	0.7	1.2	1.7	Pass	2.4	0.002		

- Note 1: Output power measured using a peak power meter, spurious limit is -20dBc. Loss for the pigtail cable used was included in the power measurement.
- Note 2: Power setting - the software power setting used during testing, included for reference only.
- Note 3: Power measured using average power meter (non-gated) and is included for reference only.



# EMC Test Data

Client: Fitbit, Inc.	Job Number: J95442
Model: FB405 (CHARGE HR)	T-Log Number: T95582
Contact: Arndt Hufenbach	Project Manager: Deepa Shetty
Standard: FCC 15.247/RSS-210/LP 00002	Project Coordinator: Irene Rademacher
	Class: N/A

## Run #2: Power spectral Density

Mode: LE

Power Setting	Frequency (MHz)	PSD	Limit dBm/3kHz	Result
		(dBm/10kHz) <small>Note 1</small>		
Default	2402	-6.3	8.0	Pass
	2440	-5.5	8.0	Pass
	2480	-5.0	8.0	Pass

Note 1: Test performed per method PKSPD, in KDB 558074. Power spectral density measured using:  $3\text{kHz} \leq \text{RBW} \leq 100\text{kHz}$ ,  $\text{VBW}=3*\text{RBW}$ , peak detector, span =  $1.5*\text{DTS BW}$ , auto sweep time, max hold.

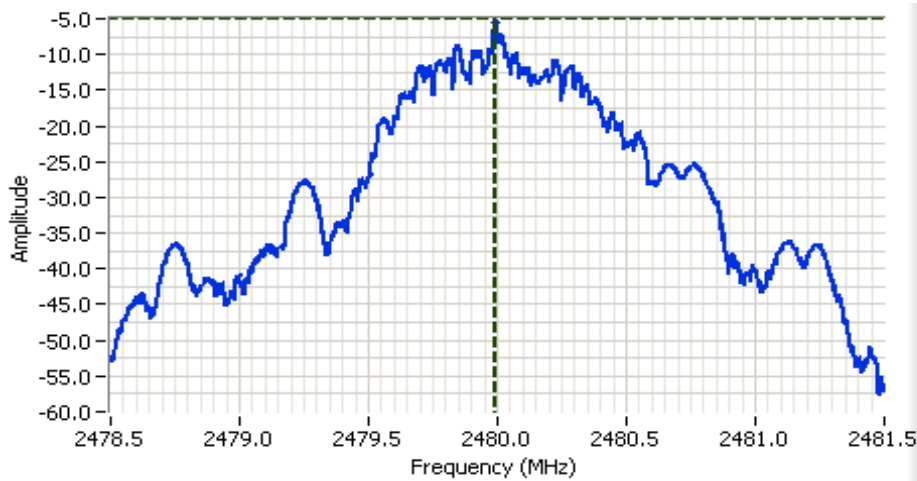

**Analyzer Settings**

Agilent Technologies, E4446A  
 CF: 2480.000 MHz  
 SPAN: 3.000 MHz  
 RB: 10.0 kHz  
 VB: 30.0 kHz  
 Detector: POS  
 Attn: 10 DB  
 RL Offset: 11.7 DB  
 Sweep Time: 28.8ms  
 Ref Lvl: 10.0 DBM

---

**Comments**

PSD = -5.04 dBm/10 kHz

Cursor 1	2479.9935	-5.04	
	0.0000	0.00	



Client: Fitbit, Inc.	Job Number: J95442
Model: FB405 (CHARGE HR)	T-Log Number: T95582
	Project Manager: Deepa Shetty
Contact: Arndt Hufenbach	Project Coordinator: Irene Rademacher
Standard: FCC 15.247/RSS-210/LP 00002	Class: N/A

### Run #3: Signal Bandwidth

Mode: LE

Power Setting	Frequency (MHz)	Bandwidth (kHz)		RBW Setting (kHz)	
		6dB	99%	6dB	99%
Default	2402	710	1022	100	30
	2440	700	1142		
	2480	732	1572		

Note 1: DTS BW: RBW=100kHz, VBW ≥ 3\*RBW, peak detector, max hold, auto sweep time.  
 99% BW: RBW=1-5% of of 99%BW, VBW ≥ 3\*RBW, peak detector, max hold, auto sweep time.

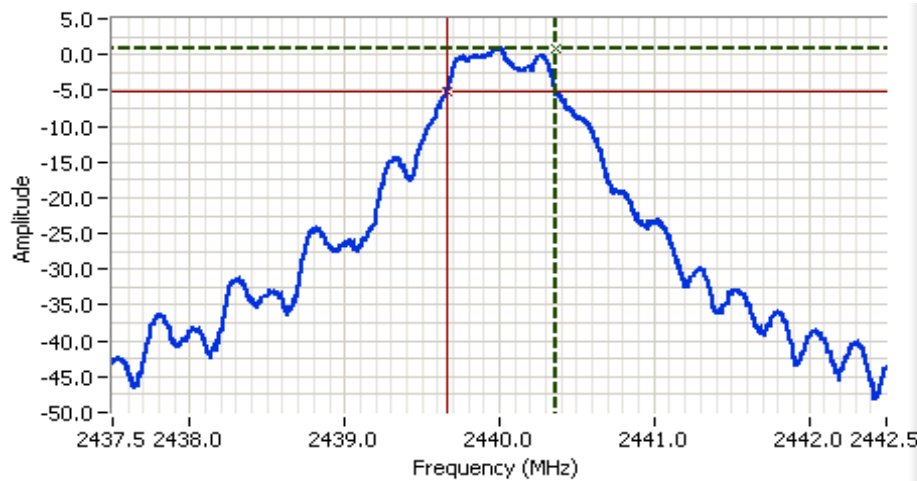

**Analyzer Settings**

Agilent Technologies, E4446A  
 CF: 2440.000 MHz  
 SPAN: 5.000 MHz  
 RB: 100 kHz  
 VB: 300 kHz  
 Detector: POS  
 Attn: 10 DB  
 RL Offset: 11.7 DB  
 Sweep Time: 1.0ms  
 Ref Lvl: 10.0 DBM

---

**Comments**

6dB BW: 700 kHz

Cursor 1	2440.3626	0.71		Delta Freq.	700 kHz
Cursor 2	2439.6624	-5.29		Delta Amplitude	6.00

Client: Fitbit, Inc.	Job Number: J95442
Model: FB405 (CHARGE HR)	T-Log Number: T95582
Contact: Arndt Hufenbach	Project Manager: Deepa Shetty
Standard: FCC 15.247/RSS-210/LP 00002	Project Coordinator: Irene Rademacher
	Class: N/A

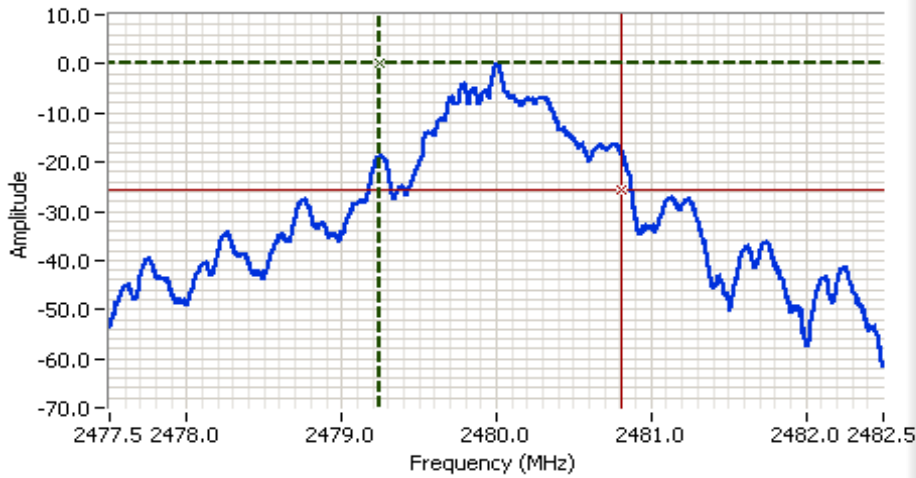

**Analyzer Settings**

Agilent Technologies, E4446A  
 CF: 2480.000 MHz  
 SPAN: 5.000 MHz  
 RB: 30.0 kHz  
 VB: 91.0 kHz  
 Detector: POS  
 Attn: 10 DB  
 RL Offset: 11.7 DB  
 Sweep Time: 5.4ms  
 Ref Lvl: 10.0 DBM

**Comments**

99% power BW: 1.572 MHz

Cursor 1	2479.2417	0.30	
Cursor 2	2480.8133	-25.70	

Delta Freq.	1.572
Delta Amplitude	26.00

Client: Fitbit, Inc.	Job Number: J95442
Model: FB405 (CHARGE HR)	T-Log Number: T95582
	Project Manager: Deepa Shetty
Contact: Arndt Hufenbach	Project Coordinator: Irene Rademacher
Standard: FCC 15.247/RSS-210/LP 00002	Class: N/A

Run #4a: Out of Band Spurious Emissions

Frequency (MHz)	Power Setting	Mode	Limit	Result
2402	Default	BTLE	-20dBc	Pass
2440				Pass
2480				Pass

Plots for low channel

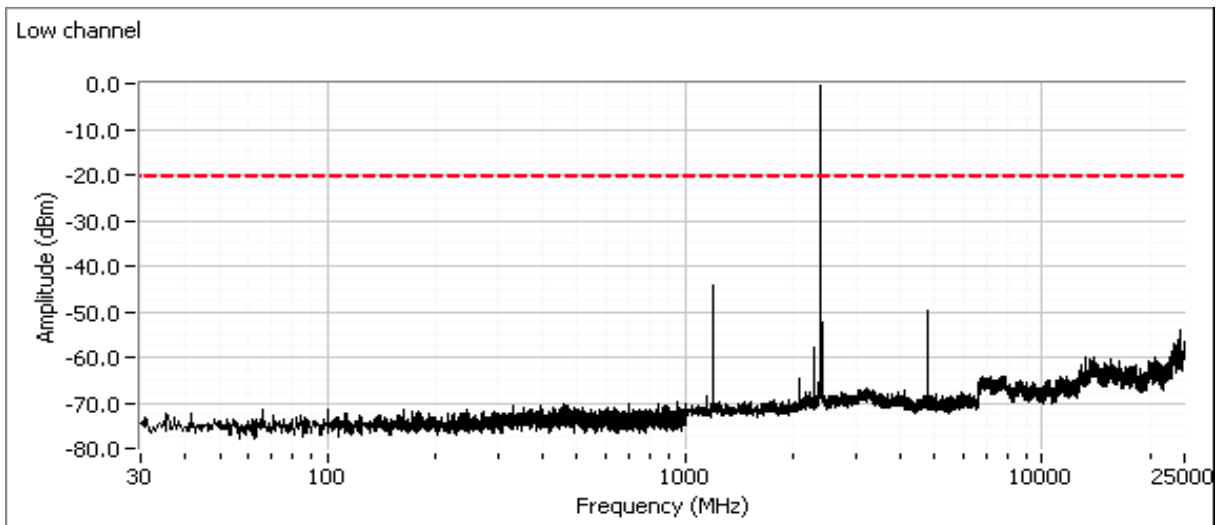

Client: Fitbit, Inc.	Job Number: J95442
Model: FB405 (CHARGE HR)	T-Log Number: T95582
Contact: Arndt Hufenbach	Project Manager: Deepa Shetty
Standard: FCC 15.247/RSS-210/LP 00002	Project Coordinator: Irene Rademacher
	Class: N/A

Additional plot showing compliance with -20dBc limit from 2390 MHz to 2400 MHz. Radiated measurements used to show compliance with the limits in the restricted band below 2390 MHz.

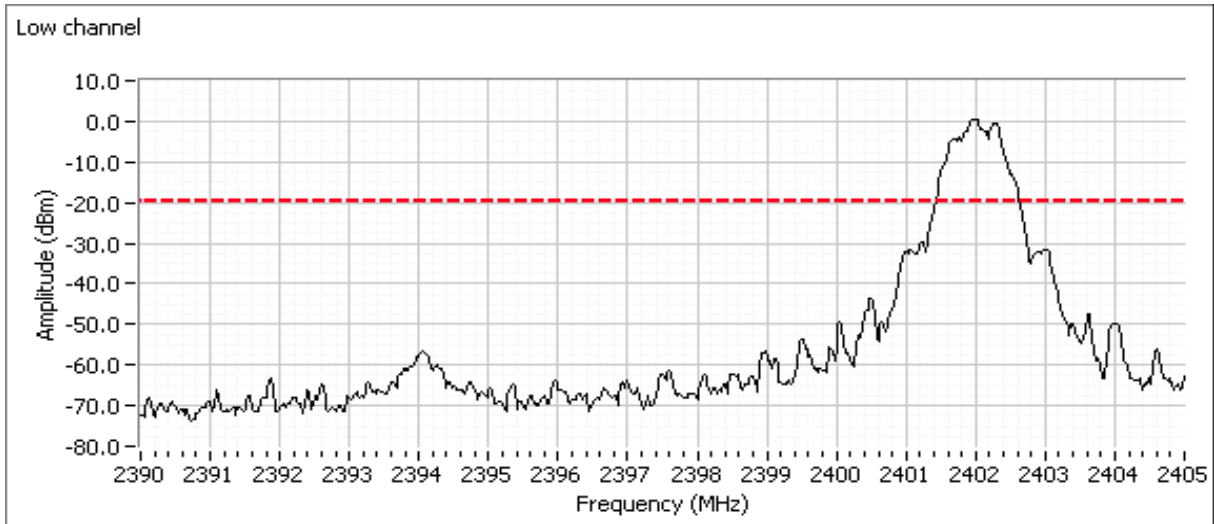

Plot for center channel

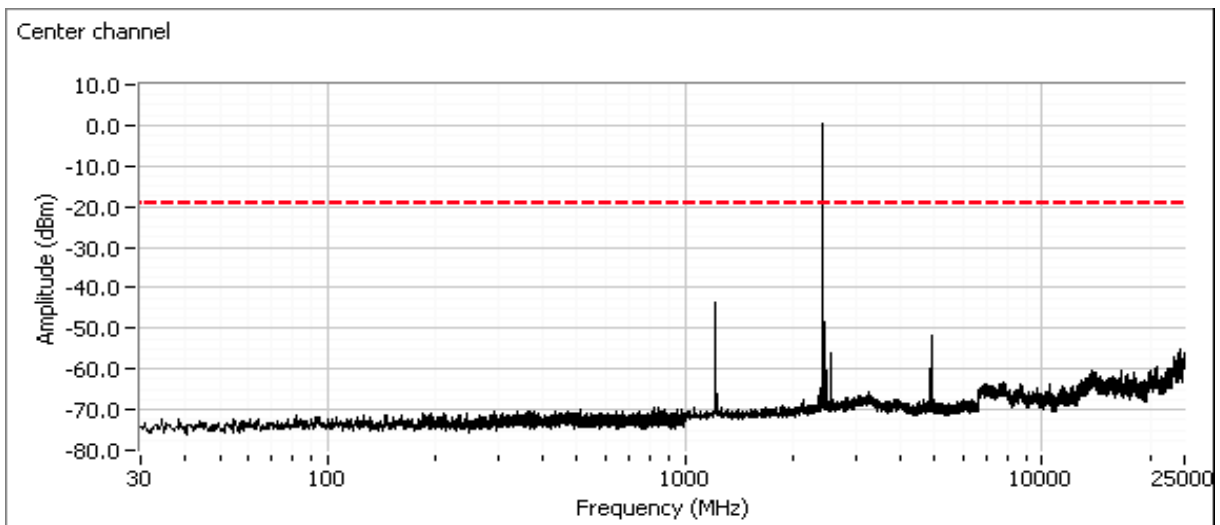

Client: Fitbit, Inc.	Job Number: J95442
Model: FB405 (CHARGE HR)	T-Log Number: T95582
	Project Manager: Deepa Shetty
Contact: Arndt Hufenbach	Project Coordinator: Irene Rademacher
Standard: FCC 15.247/RSS-210/LP 00002	Class: N/A

Plot for high channel

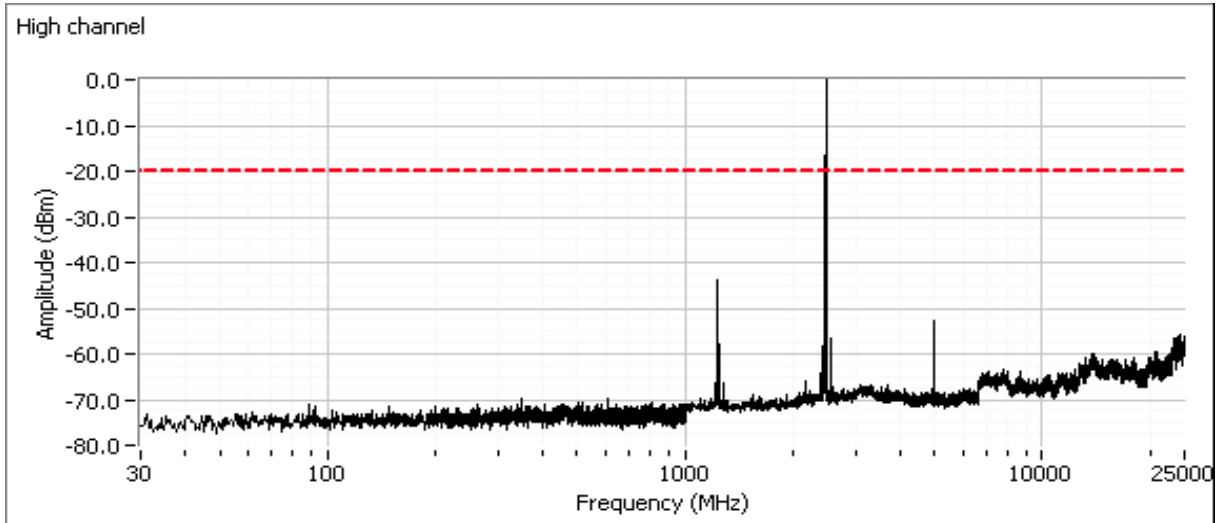



*End of Report*

This page is intentionally blank and marks the last page of this test report.