



Shenzhen CTA Testing Technology Co., Ltd.

Room 106, Building 1, Yibaolai Industrial Park, Qiaotou Community, Fuhai Street, Bao'an District, Shenzhen, China

FCC PART 15 SUBPART C TEST REPORT

FCC PART 15.247

Report Reference No.....: CTA23070503203

FCC ID.....: XR3-TABUITRACPRO

Compiled by
(position+printed name+signature) .: File administrators Zoey Cao

Supervised by
(position+printed name+signature) .: Project Engineer Amy Wen

Approved by
(position+printed name+signature) .: RF Manager Eric Wang

Date of issue: Jul. 27, 2023



Testing Laboratory Name: Shenzhen CTA Testing Technology Co., Ltd.

Address.....: Room 106, Building 1, Yibaolai Industrial Park, Qiaotou Community, Fuhai Street, Bao'an District, Shenzhen, China

Applicant's name.....: ONYX INTERNATIONAL INC.

Address: Room 101, Building 4, No. 202 Shiyu Road, Nansha District, Guangzhou City, Guangdong Province, China

Test specification

Standard.....: **FCC Part 15.247**

TRF Originator.....: Shenzhen CTA Testing Technology Co., Ltd.

Shenzhen CTA Testing Technology Co., Ltd. All rights reserved.

This publication may be reproduced in whole or in part for non-commercial purposes as long as the Shenzhen CTA Testing Technology Co., Ltd. is acknowledged as copyright owner and source of the material. Shenzhen CTA Testing Technology Co., Ltd. takes no responsibility for and will not assume liability for damages resulting from the reader's interpretation of the reproduced material due to its placement and context.

Test item description ePaper Tablet PC, E Ink Tablet PC, 2-in-1 Tablet PC, E Ink Tablet, E reader, Paper tablet, eBook reader, Digital Paper, Digital Writing Tablet, Color ePaper Tablet PC, Color E Ink Tablet PC

Trade Mark.....: BOOX

Manufacturer.....: ONYX INTERNATIONAL INC.

Model/Type reference.....: Tab Ultra C Pro

Listed Models.....: BOOX Tab Ultra C Pro, BOOX Tab Ultra Pro, BOOX Tab Ultra Plus, BOOX Tab Ultra2, BOOX Tab Ultra2 C, BOOX Tab Ultra2 C Pro

Modulation Type.....: CCK/DSSS/OFDM

Operation Frequency.....: From 2412 - 2462MHz

Rating.....: DC 3.85V From Battery and DC 5.0V From external circuit

Result.....: **PASS**

Shenzhen CTA Testing Technology Co., Ltd.

Room 106, Building 1, Yibaolai Industrial Park, Qiaotou Community, Fuhai Street, Bao'an District, Shenzhen, China
Tel:+86-755 2322 5875 E-mail:cta@cta-test.cn Web:http://www.cta-test.cn

TEST REPORT

Equipment under Test : ePaper Tablet PC, E Ink Tablet PC, 2-in-1 Tablet PC, E Ink Tablet, E reader, Paper tablet, eBook reader, Digital Paper, Digital Writing Tablet, Color ePaper Tablet PC, Color E Ink Tablet PC

Model /Type : Tab Ultra C Pro

Series Model No. BOOX Tab Ultra C Pro, BOOX Tab Ultra Pro, BOOX Tab Ultra Plus, BOOX Tab Ultra2, BOOX Tab Ultra2 C, BOOX Tab Ultra2 C Pro

Applicant : **ONYX INTERNATIONAL INC.**

Address : Room 101, Building 4, No. 202 Shiyu Road, Nansha District, Guangzhou City, Guangdong Province, China

Manufacturer : **ONYX INTERNATIONAL INC.**

Address : Room 101, Building 4, No. 202 Shiyu Road, Nansha District, Guangzhou City, Guangdong Province, China

| | |
|---------------------|-------------|
| Test Result: | PASS |
|---------------------|-------------|

The test report merely corresponds to the test sample.
It is not permitted to copy extracts of these test result without the written permission of the test laboratory.

Contents

| | | |
|----------|---|-----------|
| 1 | <u>TEST STANDARDS</u> | 4 |
| 2 | <u>SUMMARY</u> | 5 |
| 2.1 | General Remarks | 5 |
| 2.2 | Product Description | 5 |
| 2.3 | Equipment Under Test | 5 |
| 2.4 | Short description of the Equipment under Test (EUT) | 5 |
| 2.5 | EUT operation mode | 6 |
| 2.6 | Block Diagram of Test Setup | 6 |
| 2.7 | Related Submittal(s) / Grant (s) | 6 |
| 2.8 | Modifications | 6 |
| 3 | <u>TEST ENVIRONMENT</u> | 7 |
| 3.1 | Address of the test laboratory | 7 |
| 3.2 | Test Facility | 7 |
| 3.3 | Environmental conditions | 7 |
| 3.4 | Test Description | 8 |
| 3.5 | Statement of the measurement uncertainty | 8 |
| 3.6 | Equipments Used during the Test | 9 |
| 4 | <u>TEST CONDITIONS AND RESULTS.....</u> | 10 |
| 4.1 | AC Power Conducted Emission | 10 |
| 4.2 | Radiated Emission | 13 |
| 4.3 | Maximum Peak Conducted Output Power | 19 |
| 4.4 | Power Spectral Density | 21 |
| 4.5 | 6dB Bandwidth | 27 |
| 4.6 | Out-of-band Emissions | 33 |
| 4.7 | Antenna Requirement | 50 |
| 5 | <u>TEST SETUP PHOTOS OF THE EUT</u> | 51 |
| 6 | <u>PHOTOS OF THE EUT</u> | 51 |

1 TEST STANDARDS

The tests were performed according to following standards:

[FCC Rules Part 15.247](#): Frequency Hopping, Direct Spread Spectrum and Hybrid Systems that are in operation within the bands of 902-928 MHz, 2400-2483.5 MHz, and 5725-5850 MHz.

[ANSI C63.10-2013](#): American National Standard for Testing Unlicensed Wireless Devices

[KDB558074 D01 v05r02](#): Guidance for Compliance Measurements on Digital Transmission Systems (DTS) ,Frequency Hopping Spread Spectrum System(HFSS), and Hybrid System Devices Operating Under §15.247 of The FCC rules.

2 SUMMARY

2.1 General Remarks

| | | |
|--------------------------------|---|---------------|
| Date of receipt of test sample | : | Jul. 03, 2023 |
| Testing commenced on | : | Jul. 03, 2023 |
| Testing concluded on | : | Jul. 27, 2023 |

2.2 Product Description

| | |
|--|---|
| Product Description: | ePaper Tablet PC, E Ink Tablet PC, 2-in-1 Tablet PC, E Ink Tablet, E reader, Paper tablet, eBook reader, Digital Paper, Digital Writing Tablet, Color ePaper Tablet PC, Color E Ink Tablet PC |
| Model/Type reference: | Tab Ultra C Pro |
| Power supply: | DC 3.85V From Battery and DC 5.0V From external circuit |
| Adapter information (Auxiliary test supplied by test Lab) : | Input: AC 100-240V 50/60Hz Output: DC 5V 3A |
| testing sample ID: | CTA230705032-1# (Engineer sample) CTA230705032-2# (Normal sample) |
| Hardware version: | V1.0 |
| Software version: | V1.0 |
| WIFI : | |
| Supported type: | 802.11b/802.11g/802.11n(H20)/ 802.11n(H40) |
| Modulation: | 802.11b: DSSS 802.11g/802.11n(H20)/ 802.11n(H40): OFDM |
| Operation frequency: | 802.11b/802.11g/802.11n(H20)/ 802.11n(H40): 2412MHz~2462MHz |
| Channel number: | 802.11b/802.11g/802.11n(H20): 11 802.11n(H40):7 |
| Channel separation: | 5MHz |
| Antenna type: | PIFA antenna |
| Antenna gain: | -1.35 dBi for Ant 1 and -5.58 dBi for Ant 2 |

2.3 Equipment Under Test

Power supply system utilised

| | | | |
|----------------------|---|---|-----------------------------------|
| Power supply voltage | : | <input type="radio"/> 230V / 50 Hz | <input type="radio"/> 120V / 60Hz |
| | | <input type="radio"/> 5 V DC | <input type="radio"/> 24 V DC |
| | | <input checked="" type="radio"/> Other (specified in blank below) | |

DC 3.85V From Battery and DC 5.0V From external circuit

2.4 Short description of the Equipment under Test (EUT)

This is an ePaper Tablet PC, E Ink Tablet PC, 2-in-1 Tablet PC, E Ink Tablet, E reader, Paper tablet, eBook reader, Digital Paper, Digital Writing Tablet, Color ePaper Tablet PC, Color E Ink Tablet PC.
For more details, refer to the user's manual of the EUT.

Shenzhen CTA Testing Technology Co., Ltd.

Room 106, Building 1, Yibaolai Industrial Park, Qiaotou Community, Fuhai Street, Bao'an District, Shenzhen, China
Tel:+86-755 2322 5875 E-mail:cta@cta-test.cn Web:http://www.cta-test.cn

2.5 EUT operation mode

The application provider specific test software(AT command) to control sample in continuous TX and RX (Duty Cycle >98%) for testing meet KDB558074 test requirement.

IEEE 802.11b/g/n: Thirteen channels are provided to the EUT.

| Channel | Frequency(MHz) | Channel | Frequency(MHz) |
|---------|----------------|---------|----------------|
| 1 | 2412 | 8 | 2447 |
| 2 | 2417 | 9 | 2452 |
| 3 | 2422 | 10 | 2457 |
| 4 | 2427 | 11 | 2462 |
| 5 | 2432 | | |
| 6 | 2437 | | |
| 7 | 2442 | | |

2.6 Block Diagram of Test Setup

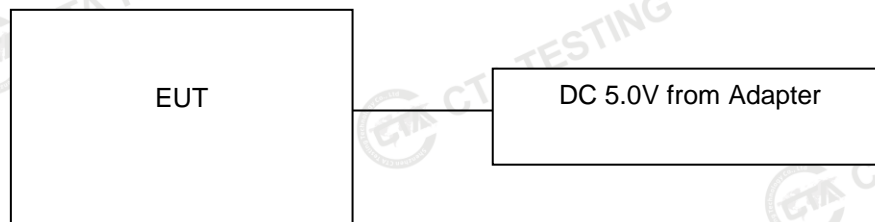

2.7 Related Submittal(s) / Grant (s)

This submittal(s) (test report) is intended for filing to comply with Section 15.247 of the FCC Part 15, Subpart C Rules.

2.8 Modifications

No modifications were implemented to meet testing criteria.

3 TEST ENVIRONMENT

3.1 Address of the test laboratory

Shenzhen CTA Testing Technology Co., Ltd.

Room 106, Building 1, Yibaolai Industrial Park, Qiaotou Community, Fuhai Street, Bao'an District, Shenzhen, China

3.2 Test Facility

The test facility is recognized, certified, or accredited by the following organizations:

FCC-Registration No.: 517856 Designation Number: CN1318

Shenzhen CTA Testing Technology Co., Ltd. has been listed on the US Federal Communications Commission list of test facilities recognized to perform electromagnetic emissions measurements.

A2LA-Lab Cert. No.: 6534.01

Shenzhen CTA Testing Technology Co., Ltd. has been listed by American Association for Laboratory Accreditation to perform electromagnetic emission measurement.

ISED#: 27890 CAB identifier: CN0127

Shenzhen CTA Testing Technology Co., Ltd. has been listed by Innovation, Science and Economic Development Canada to perform electromagnetic emission measurement.

The 3m-Semi anechoic test site fulfils CISPR 16-1-4 according to ANSI C63.10 and CISPR 16-1-4:2010.

3.3 Environmental conditions

During the measurement the environmental conditions were within the listed ranges:

Radiated Emission:

| | |
|-----------------------|--------------|
| Temperature: | 25 ° C |
| Humidity: | 45 % |
| Atmospheric pressure: | 950-1050mbar |

Conducted testing:

| | |
|-----------------------|--------------|
| Temperature: | 25 ° C |
| Humidity: | 44 % |
| Atmospheric pressure: | 950-1050mbar |

AC Power Conducted Emission

| | |
|-----------------------|--------------|
| Temperature: | 24 ° C |
| Humidity: | 44 % |
| Atmospheric pressure: | 950-1050mbar |

Shenzhen CTA Testing Technology Co., Ltd.

Room 106, Building 1, Yibaolai Industrial Park, Qiaotou Community, Fuhai Street, Bao'an District, Shenzhen, China
Tel:+86-755 2322 5875 E-mail:cta@cta-test.cn Web:http://www.cta-test.cn

3.4 Test Description

| | | |
|---------------------------------|-------------------------------------|------|
| FCC PART 15.247 | | |
| FCC Part 15.207 | AC Power Conducted Emission | PASS |
| FCC Part 15.247(a)(2) | 6dB Bandwidth | PASS |
| FCC Part 15.247(d) | Spurious RF Conducted Emission | PASS |
| FCC Part 15.247(b) | Maximum Peak Conducted Output Power | PASS |
| FCC Part 15.247(e) | Power Spectral Density | PASS |
| FCC Part 15.109/ 15.205/ 15.209 | Radiated Emissions | PASS |
| FCC Part 15.247(d) | Band Edge | PASS |
| FCC Part 15.203/15.247 (b) | Antenna Requirement | PASS |

Data Rate Used:

Preliminary tests were performed in different data rate to find the worst radiated emission. The data rate shown in the table below is the worst-case rate with respect to the specific test item. Investigation has been done on all the possible configurations for searching the worst cases. The following table is a list of the test modes shown in this test report.

| Test Items | Mode | Data Rate | Channel |
|--|-----------------|-----------|---------|
| Maximum Peak Conducted Output Power Power Spectral Density 6dB Bandwidth Spurious RF conducted emission Radiated Emission 9KHz~1GHz& Radiated Emission 1GHz~10 th Harmonic | 11b/DSSS | 1 Mbps | 1/6/11 |
| | 11g/OFDM | 6 Mbps | 1/6/11 |
| | 11n(20MHz)/OFDM | 6.5Mbps | 1/6/11 |
| | 11n(40MHz)/OFDM | 13.5Mbps | 3/6/9 |
| Band Edge | 11b/DSSS | 1 Mbps | 1/11 |
| | 11g/OFDM | 6 Mbps | 1/11 |
| | 11n(20MHz)/OFDM | 6.5Mbps | 1/11 |
| | 11n(40MHz)/OFDM | 13.5Mbps | 3/9 |

3.5 Statement of the measurement uncertainty

The data and results referenced in this document are true and accurate. The reader is cautioned that there may be errors within the calibration limits of the equipment and facilities. The measurement uncertainty was calculated for all measurements listed in this test report acc. to TR-100028-01 "Electromagnetic compatibility and Radio spectrum Matters (ERM);Uncertainties in the measurement of mobile radio equipment characteristics; Part 1" and TR-100028-02 "Electromagnetic compatibility and Radio spectrum Matters (ERM);Uncertainties in the measurement of mobile radio equipment characteristics; Part 2 " and is documented in the Shenzhen CTA Testing Technology Co., Ltd. quality system acc. to DIN EN ISO/IEC 17025. Furthermore, component and process variability of devices similar to that tested may result in additional deviation. The manufacturer has the sole responsibility of continued compliance of the device.

Hereafter the best measurement capability for Shenzhen CTA Testing Technology Co., Ltd. :

| Test | Range | Measurement Uncertainty | Notes |
|-----------------------|------------|-------------------------|-------|
| Radiated Emission | 30~1000MHz | 4.06 dB | (1) |
| Radiated Emission | 1~18GHz | 5.14 dB | (1) |
| Radiated Emission | 18-40GHz | 5.38 dB | (1) |
| Conducted Disturbance | 0.15~30MHz | 2.14 dB | (1) |

- (1) This uncertainty represents an expanded uncertainty expressed at approximately the 95% confidence level using a coverage factor of k=2.

3.6 Equipments Used during the Test

| Test Equipment | Manufacturer | Model No. | Equipment No. | Calibration Date | Calibration Due Date |
|--------------------------------|------------------------|-------------|---------------|------------------|----------------------|
| LISN | R&S | ENV216 | CTA-308 | 2022/08/03 | 2023/08/02 |
| LISN | R&S | ENV216 | CTA-314 | 2022/08/03 | 2023/08/02 |
| EMI Test Receiver | R&S | ESPI | CTA-307 | 2022/08/03 | 2023/08/02 |
| EMI Test Receiver | R&S | ESCI | CTA-306 | 2022/08/03 | 2023/08/02 |
| Spectrum Analyzer | Agilent | N9020A | CTA-301 | 2022/08/03 | 2023/08/02 |
| Spectrum Analyzer | R&S | FSP | CTA-337 | 2022/08/03 | 2023/08/02 |
| Vector Signal generator | Agilent | N5182A | CTA-305 | 2022/08/03 | 2023/08/02 |
| Analog Signal Generator | R&S | SML03 | CTA-304 | 2022/08/03 | 2023/08/02 |
| Universal Radio Communication | CMW500 | R&S | CTA-302 | 2022/08/03 | 2023/08/02 |
| Temperature and humidity meter | Chigo | ZG-7020 | CTA-326 | 2022/08/03 | 2023/08/02 |
| Ultra-Broadband Antenna | Schwarzbeck | VULB9163 | CTA-310 | 2021/08/07 | 2024/08/06 |
| Horn Antenna | Schwarzbeck | BBHA 9120D | CTA-309 | 2021/08/07 | 2024/08/06 |
| Loop Antenna | Zhinan | ZN30900C | CTA-311 | 2021/08/07 | 2024/08/06 |
| Horn Antenna | Beijing Hangwei Dayang | OBH100400 | CTA-336 | 2021/08/07 | 2024/08/06 |
| Amplifier | Schwarzbeck | BBV 9745 | CTA-312 | 2022/08/03 | 2023/08/02 |
| Amplifier | Taiwan chengyi | EMC051845B | CTA-313 | 2022/08/03 | 2023/08/02 |
| Directional coupler | NARDA | 4226-10 | CTA-303 | 2022/08/03 | 2023/08/02 |
| High-Pass Filter | XingBo | XBLBQ-GTA18 | CTA-402 | 2022/08/03 | 2023/08/02 |
| High-Pass Filter | XingBo | XBLBQ-GTA27 | CTA-403 | 2022/08/03 | 2023/08/02 |
| Automated filter bank | Tonscend | JS0806-F | CTA-404 | 2022/08/03 | 2023/08/02 |
| Power Sensor | Agilent | U2021XA | CTA-405 | 2022/08/03 | 2023/08/02 |
| Amplifier | Schwarzbeck | BBV9719 | CTA-406 | 2022/08/03 | 2023/08/02 |

4 TEST CONDITIONS AND RESULTS

4.1 AC Power Conducted Emission

TEST CONFIGURATION

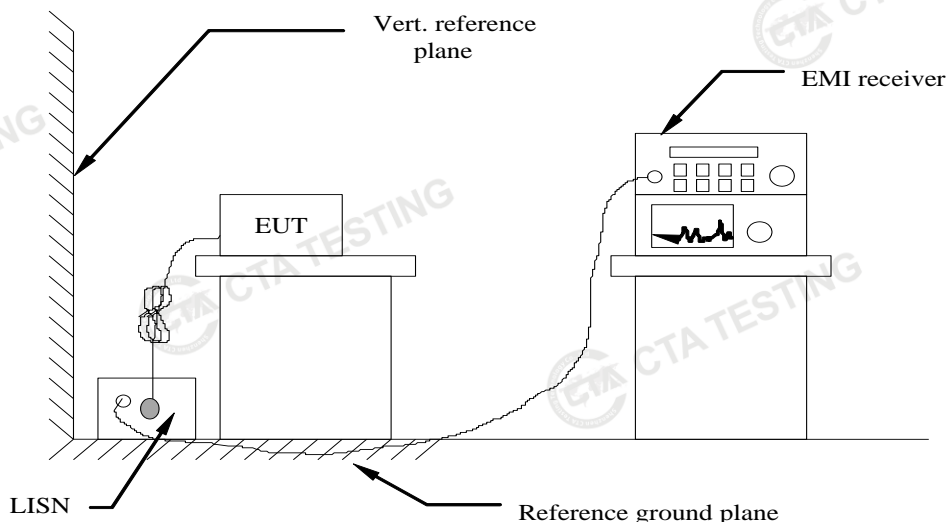

TEST PROCEDURE

- 1 The equipment was set up as per the test configuration to simulate typical actual usage per the user's manual. The EUT is a tabletop system, a wooden table with a height of 0.8 meters is used and is placed on the ground plane as per ANSI C63.10-2013.
- 2 Support equipment, if needed, was placed as per ANSI C63.10-2013
- 3 All I/O cables were positioned to simulate typical actual usage as per ANSI C63.10-2013
- 4 The EUT received power from adapter, the adapter received AC120V/60Hz and AC 240V/60Hz power through a Line Impedance Stabilization Network (LISN) which supplied power source and was grounded to the ground plane.
- 5 All support equipments received AC power from a second LISN, if any.
- 6 The EUT test program was started. Emissions were measured on each current carrying line of the EUT using a spectrum Analyzer / Receiver connected to the LISN powering the EUT. The LISN has two monitoring points: Line 1 (Hot Side) and Line 2 (Neutral Side). Two scans were taken: one with Line 1 connected to Analyzer / Receiver and Line 2 connected to a 50 ohm load; the second scan had Line 1 connected to a 50 ohm load and Line 2 connected to the Analyzer / Receiver.
- 7 Analyzer / Receiver scanned from 150 KHz to 30MHz for emissions in each of the test modes.
- 8 During the above scans, the emissions were maximized by cable manipulation.

AC Power Conducted Emission Limit

For intentional device, according to § 15.207(a) AC Power Conducted Emission Limits is as following :

| Frequency range (MHz) | Limit (dBuV) | |
|-----------------------|--------------|-----------|
| | Quasi-peak | Average |
| 0.15-0.5 | 66 to 56* | 56 to 46* |
| 0.5-5 | 56 | 46 |
| 5-30 | 60 | 50 |

* Decreases with the logarithm of the frequency.

TEST RESULTS

Remark:

1. All modes of 802.11b/g/nHT20/nHT40 were tested at Low, Middle, and High channel; only the worst result of 802.11b CH11 was reported as below:
2. Both 120 VAC, 50/60 Hz and 240 VAC, 50/60 Hz power supply have been tested, only the worst result of 120 VAC, 60 Hz was reported as below:

| | | | |
|---------------|-----------------------------------|--------------|---|
| Power supply: | DC 5.0V from Adapter AC 120V/60Hz | Polarization | L |
|---------------|-----------------------------------|--------------|---|

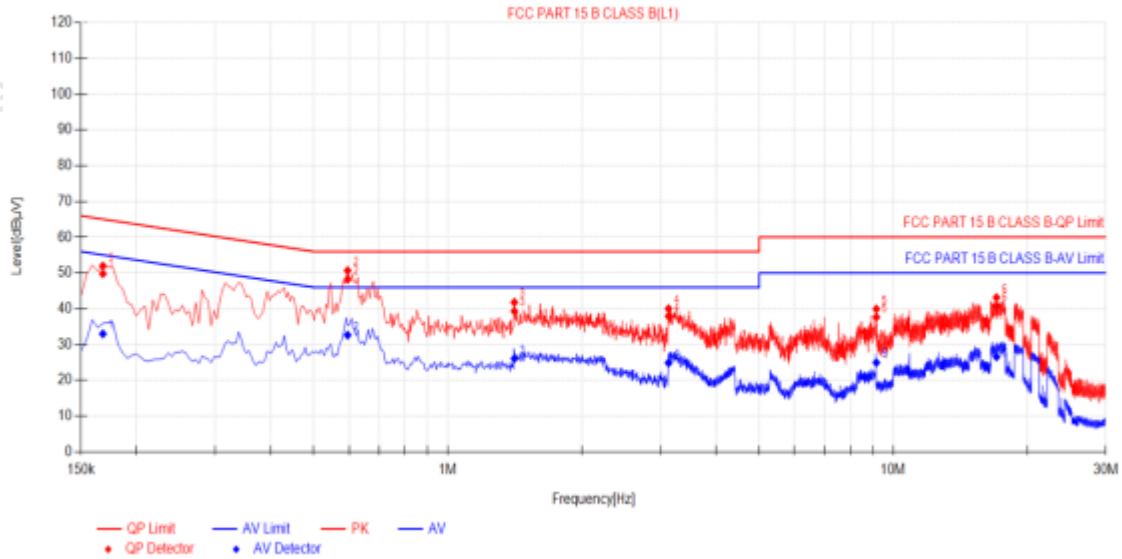

Final Data List

| NO. | Freq. [MHz] | Factor [dB] | QP Reading[dB μV] | QP Value [dBμV] | QP Limit [dBμV] | QP Margin [dB] | AV Reading [dBμV] | AV Value [dBμV] | AV Limit [dBμV] | AV Margin [dB] | Verdict |
|-----|-------------|-------------|-------------------|-----------------|-----------------|----------------|-------------------|-----------------|-----------------|----------------|---------|
| 1 | 0.168 | 10.50 | 39.30 | 49.80 | 65.06 | 15.26 | 22.50 | 33.00 | 55.06 | 22.06 | PASS |
| 2 | 0.5955 | 10.50 | 37.70 | 48.20 | 56.00 | 7.80 | 22.13 | 32.63 | 46.00 | 13.37 | PASS |
| 3 | 1.41 | 10.50 | 28.82 | 39.32 | 56.00 | 16.68 | 15.58 | 26.08 | 46.00 | 19.92 | PASS |
| 4 | 3.129 | 10.50 | 27.43 | 37.93 | 56.00 | 18.07 | 14.38 | 24.88 | 46.00 | 21.12 | PASS |
| 5 | 9.1635 | 10.50 | 27.15 | 37.65 | 60.00 | 22.35 | 14.45 | 24.95 | 50.00 | 25.05 | PASS |
| 6 | 17.052 | 10.50 | 30.25 | 40.75 | 60.00 | 19.25 | 16.07 | 26.57 | 50.00 | 23.43 | PASS |

- Note:1). QP Value (dBμV) = QP Reading (dBμV) + Factor (dB)
 2). Factor (dB) = insertion loss of LISN (dB) + Cable loss (dB)
 3). QPMargin(dB) = QP Limit (dBμV) - QP Value (dBμV)
 4). AVMargin(dB) = AV Limit (dBμV) - AV Value (dBμV)

| | | | |
|---------------|-----------------------------------|--------------|---|
| Power supply: | DC 5.0V from Adapter AC 120V/60Hz | Polarization | N |
|---------------|-----------------------------------|--------------|---|

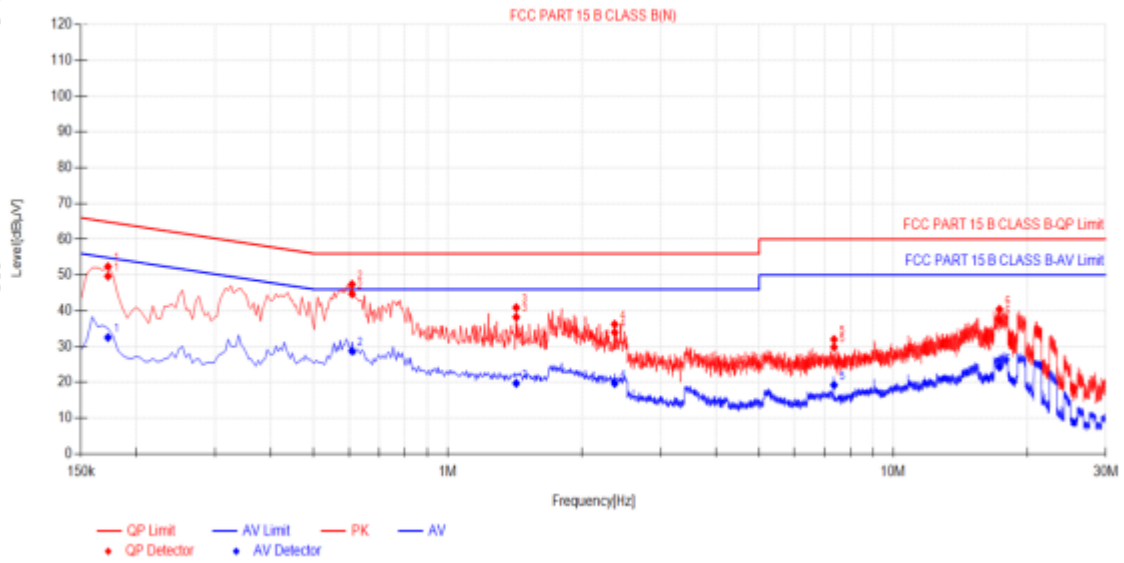

Final Data List

| NO. | Freq. [MHz] | Factor [dB] | QP Reading [dB µV] | QP Value [dBµV] | QP Limit [dBµV] | QP Margin [dB] | AV Reading [dBµV] | AV Value [dBµV] | AV Limit [dBµV] | AV Margin [dB] | Verdict |
|-----|-------------|-------------|--------------------|-----------------|-----------------|----------------|-------------------|-----------------|-----------------|----------------|---------|
| 1 | 0.1725 | 10.50 | 39.19 | 49.69 | 64.84 | 15.15 | 22.04 | 32.54 | 54.84 | 22.30 | PASS |
| 2 | 0.609 | 10.50 | 34.23 | 44.73 | 56.00 | 11.27 | 18.24 | 28.74 | 46.00 | 17.26 | PASS |
| 3 | 1.4235 | 10.50 | 27.73 | 38.23 | 56.00 | 17.77 | 9.23 | 19.73 | 46.00 | 26.27 | PASS |
| 4 | 2.3685 | 10.50 | 23.48 | 33.98 | 56.00 | 22.02 | 9.19 | 19.69 | 46.00 | 26.31 | PASS |
| 5 | 7.3635 | 10.50 | 19.33 | 29.83 | 60.00 | 30.17 | 8.73 | 19.23 | 50.00 | 30.77 | PASS |
| 6 | 17.3175 | 10.50 | 26.94 | 37.44 | 60.00 | 22.56 | 13.70 | 24.20 | 50.00 | 25.80 | PASS |

- Note:1). QP Value (dBµV) = QP Reading (dBµV) + Factor (dB)
- 2). Factor (dB) = insertion loss of LISN (dB) + Cable loss (dB)
- 3). QPMargin (dB) = QP Limit (dBµV) - QP Value (dBµV)
- 4). AVMargin (dB) = AV Limit (dBµV) - AV Value (dBµV)

4.2 Radiated Emission

TEST CONFIGURATION

Frequency range 9 KHz – 30MHz

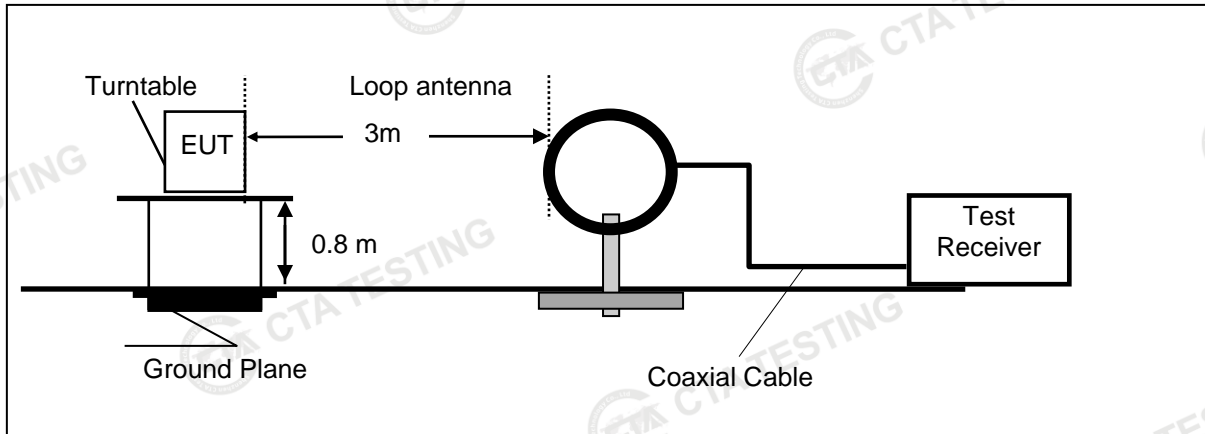

Frequency range 30MHz – 1000MHz

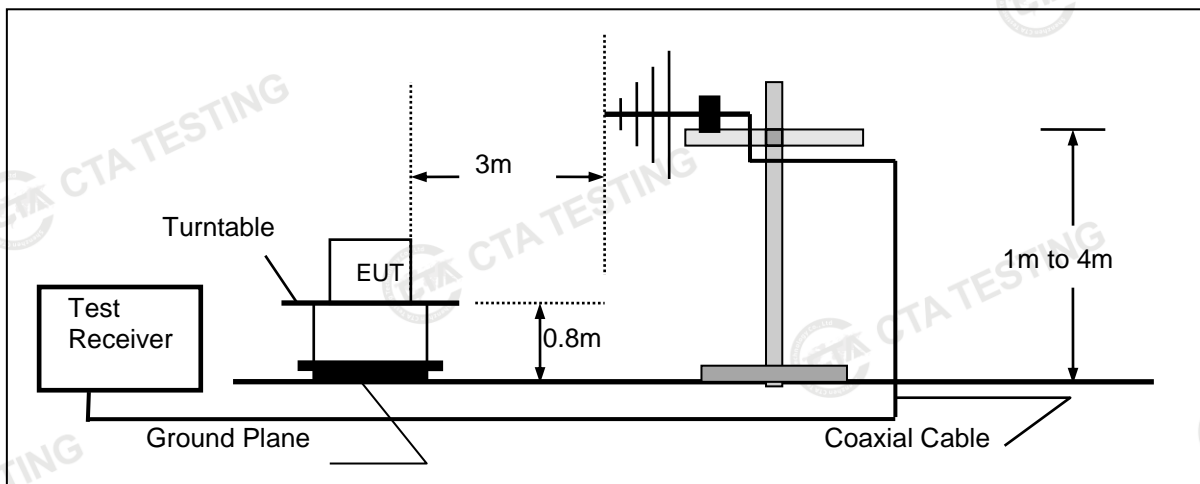

Frequency range above 1GHz-25GHz

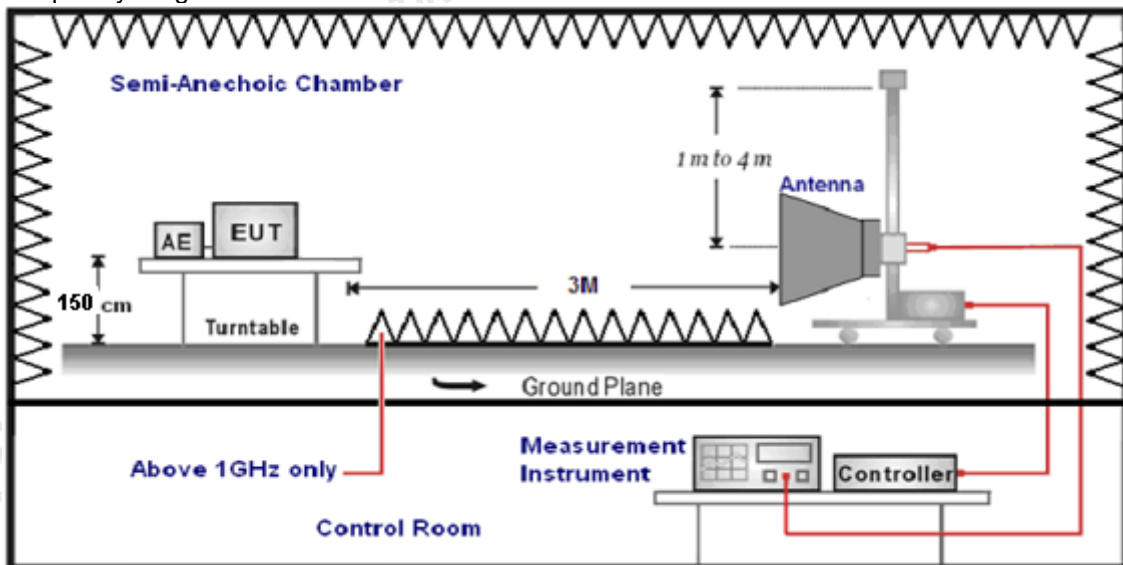

TEST PROCEDURE

- The EUT was placed on a turn table which is 0.8m above ground plane when testing frequency range 9 KHz –1GHz;the EUT was placed on a turn table which is 1.5m above ground plane when testing frequency range 1GHz – 25GHz.
- Maximum procedure was performed by raising the receiving antenna from 1m to 4m and rotating the turn table from 0° to 360° to acquire the highest emissions from EUT.
- And also, each emission was to be maximized by changing the polarization of receiving antenna both horizontal and vertical.
- Repeat above procedures until all frequency measurements have been completed.
- Radiated emission test frequency band from 9KHz to 25GHz.
- The distance between test antenna and EUT as following table states:

| Test Frequency range | Test Antenna Type | Test Distance |
|----------------------|----------------------------|---------------|
| 9KHz-30MHz | Active Loop Antenna | 3 |
| 30MHz-1GHz | Ultra-Broadband Antenna | 3 |
| 1GHz-18GHz | Double Ridged Horn Antenna | 3 |
| 18GHz-25GHz | Horn Antenna | 1 |

- Setting test receiver/spectrum as following table states:

| Test Frequency range | Test Receiver/Spectrum Setting | Detector |
|----------------------|---|----------|
| 9KHz-150KHz | RBW=200Hz/VBW=3KHz, Sweep time=Auto | QP |
| 150KHz-30MHz | RBW=9KHz/VBW=100KHz, Sweep time=Auto | QP |
| 30MHz-1GHz | RBW=120KHz/VBW=1000KHz, Sweep time=Auto | QP |
| 1GHz-40GHz | Peak Value: RBW=1MHz/VBW=3MHz, Sweep time=Auto Average Value: RBW=1MHz/VBW=10Hz, Sweep time=Auto | Peak |

Field Strength Calculation

The field strength is calculated by adding the Antenna Factor and Cable Factor and subtracting the Amplifier Gain and Duty Cycle Correction Factor(if any) from the measured reading. The basic equation with a sample calculation is as follows:

$$FS = RA + AF + CL - AG$$

| | |
|---------------------------|--|
| Where FS = Field Strength | CL = Cable Attenuation Factor (Cable Loss) |
| RA = Reading Amplitude | AG = Amplifier Gain |
| AF = Antenna Factor | |

$$\text{Transd} = \text{AF} + \text{CL} - \text{AG}$$

RADIATION LIMIT

For intentional device, according to § 15.209(a), the general requirement of field strength of radiated emission from intentional radiators at a distance of 3 meters shall not exceed the following table. According to § 15.247(d), in any 100kHz bandwidth outside the frequency band in which the EUT is operating, the radio frequency power that is produced by the intentional radiator shall be at least 20dB below that in the 100kHz bandwidth within the band that contains the highest level of desired power.

The pre-test have done for the EUT in three axes and found the worst emission at position shown in test setup photos.

| Frequency (MHz) | Distance (Meters) | Radiated (dBµV/m) | Radiated (µV/m) |
|-----------------|-------------------|----------------------------------|-----------------|
| 0.009-0.49 | 3 | 20log(2400/F(KHz))+40log(300/3) | 2400/F(KHz) |
| 0.49-1.705 | 3 | 20log(24000/F(KHz))+ 40log(30/3) | 24000/F(KHz) |
| 1.705-30 | 3 | 20log(30)+ 40log(30/3) | 30 |
| 30-88 | 3 | 40.0 | 100 |
| 88-216 | 3 | 43.5 | 150 |
| 216-960 | 3 | 46.0 | 200 |
| Above 960 | 3 | 54.0 | 500 |

TEST RESULTS

Remark:

1. This test was performed with EUT in X, Y, Z position and the worse case was found when EUT in X position.
2. All three channels (lowest/middle/highest) of each mode were measured below 1GHz and recorded worst case at 802.11b low channel.
3. Radiated emission test from 9 KHz to 10th harmonic of fundamental was verified, and no emission found except system noise floor in 9 KHz to 30MHz and not recorded in this report.

For 30MHz-1GHz

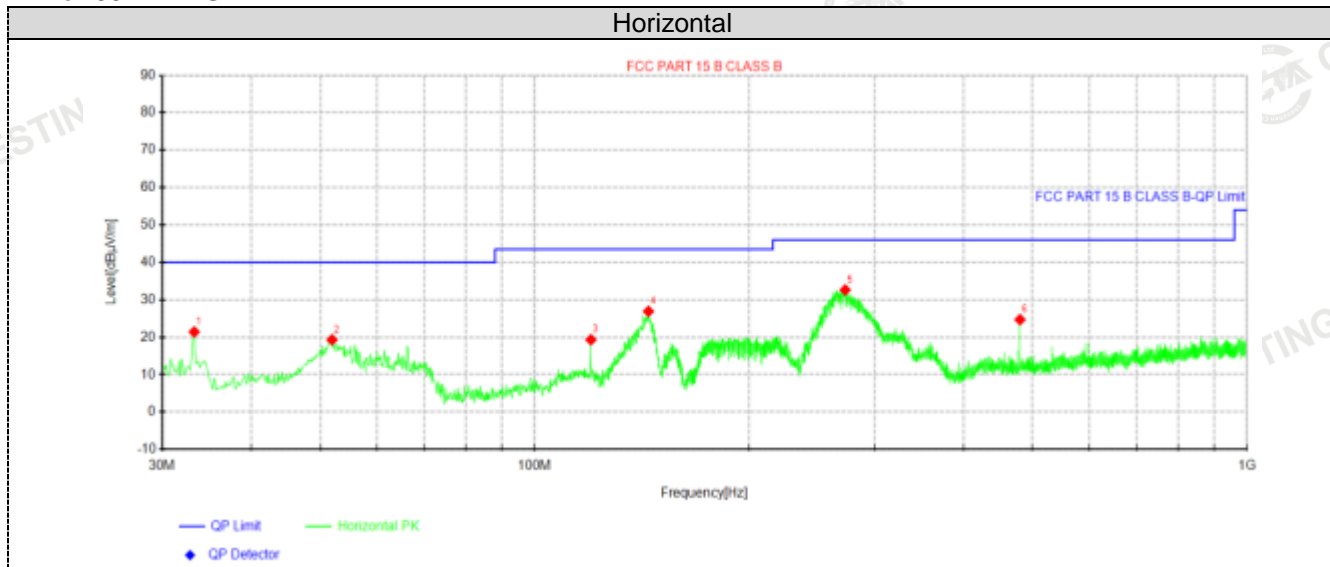

| Suspected Data List | | | | | | | | | |
|---------------------|-------------|----------------|----------------|---------------|----------------|-------------|-------------|-----------|------------|
| NO. | Freq. [MHz] | Reading [dBµV] | Level [dBµV/m] | Factor [dB/m] | Limit [dBµV/m] | Margin [dB] | Height [cm] | Angle [°] | Polarity |
| 1 | 33.2738 | 39.57 | 21.41 | -18.16 | 40.00 | 18.59 | 100 | 40 | Horizontal |
| 2 | 51.9462 | 35.77 | 19.30 | -16.47 | 40.00 | 20.70 | 100 | 350 | Horizontal |
| 3 | 119.967 | 39.61 | 19.32 | -20.29 | 43.50 | 24.18 | 100 | 120 | Horizontal |
| 4 | 144.46 | 48.67 | 26.90 | -21.77 | 43.50 | 16.60 | 100 | 70 | Horizontal |
| 5 | 272.863 | 50.31 | 32.62 | -17.69 | 46.00 | 13.38 | 100 | 80 | Horizontal |
| 6 | 480.08 | 39.26 | 24.69 | -14.57 | 46.00 | 21.31 | 100 | 30 | Horizontal |

Note:1).Level (dBµV/m)= Reading (dBµV)+ Factor (dB/m)

2). Factor(dB/m)=Antenna Factor (dB/m) + Cable loss (dB) - Pre Amplifier gain (dB)

3). Margin(dB) = Limit (dBµV/m) - Level (dBµV/m)

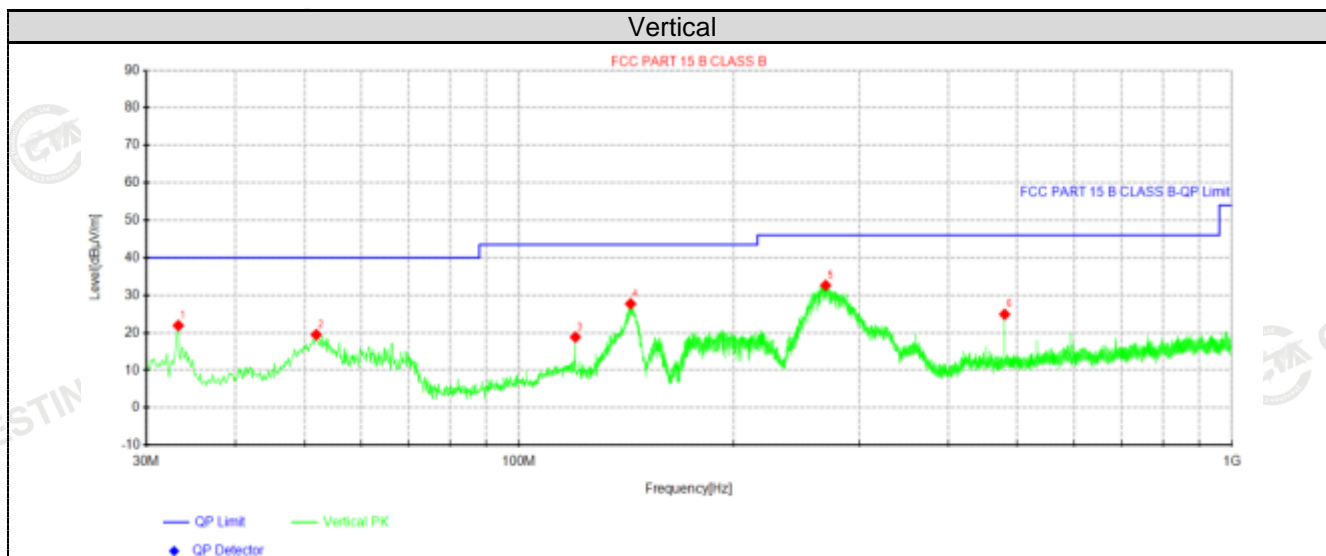

Suspected Data List

| NO. | Freq. [MHz] | Reading [dBuV] | Level [dBuV/m] | Factor [dB/m] | Limit [dBuV/m] | Margin [dB] | Height [cm] | Angle [°] | Polarity |
|-----|-------------|----------------|----------------|---------------|----------------|-------------|-------------|-----------|----------|
| 1 | 33.2738 | 40.08 | 21.92 | -18.16 | 40.00 | 18.08 | 100 | 230 | Vertical |
| 2 | 51.9462 | 35.94 | 19.47 | -16.47 | 40.00 | 20.53 | 100 | 120 | Vertical |
| 3 | 119.967 | 39.11 | 18.82 | -20.29 | 43.50 | 24.68 | 100 | 290 | Vertical |
| 4 | 143.368 | 49.50 | 27.72 | -21.78 | 43.50 | 15.78 | 100 | 170 | Vertical |
| 5 | 269.226 | 50.32 | 32.63 | -17.69 | 46.00 | 13.37 | 100 | 70 | Vertical |
| 6 | 479.958 | 39.47 | 24.90 | -14.57 | 46.00 | 21.10 | 100 | 250 | Vertical |

Note:1).Level (dBuV/m)= Reading (dBuV)+ Factor (dB/m)

2). Factor(dB/m)=Antenna Factor (dB/m) + Cable loss (dB) - Pre Amplifier gain (dB)

3). Margin(dB) = Limit (dBuV/m) - Level (dBuV/m)

For 1GHz to 25GHz

Note: 802.11b/802.11g/802.11n (H20)/ 802.11n (H40) Mode all have been tested, only worse case 802.11b mode is reported

(above 1GHz)

| Frequency(MHz): | | | 2412 | | Polarity: | | HORIZONTAL | | |
|-----------------|-------------------------|----|----------------|-------------|------------------|-----------------------|-------------------|--------------------|--------------------------|
| Frequency (MHz) | Emission Level (dBuV/m) | | Limit (dBuV/m) | Margin (dB) | Raw Value (dBuV) | Antenna Factor (dB/m) | Cable Factor (dB) | Pre-amplifier (dB) | Correction Factor (dB/m) |
| 4824.00 | 61.84 | PK | 74 | 12.16 | 66.20 | 32.4 | 5.11 | 41.87 | -4.36 |
| 4824.00 | 45.32 | AV | 54 | 8.68 | 49.68 | 32.4 | 5.11 | 41.87 | -4.36 |
| 7236.00 | 54.57 | PK | 74 | 19.43 | 55.20 | 36.58 | 6.43 | 43.64 | -0.63 |
| 7236.00 | 43.26 | AV | 54 | 10.74 | 43.89 | 36.58 | 6.43 | 43.64 | -0.63 |

| Frequency(MHz): | | | 2412 | | Polarity: | | VERTICAL | | |
|-----------------|-------------------------|----|----------------|-------------|------------------|-----------------------|-------------------|--------------------|--------------------------|
| Frequency (MHz) | Emission Level (dBuV/m) | | Limit (dBuV/m) | Margin (dB) | Raw Value (dBuV) | Antenna Factor (dB/m) | Cable Factor (dB) | Pre-amplifier (dB) | Correction Factor (dB/m) |
| 4824.00 | 60.38 | PK | 74 | 13.62 | 64.74 | 32.4 | 5.11 | 41.87 | -4.36 |
| 4824.00 | 44.73 | AV | 54 | 9.27 | 49.09 | 32.4 | 5.11 | 41.87 | -4.36 |
| 7236.00 | 53.81 | PK | 74 | 20.19 | 54.44 | 36.58 | 6.43 | 43.64 | -0.63 |
| 7236.00 | 41.79 | AV | 54 | 12.21 | 42.42 | 36.58 | 6.43 | 43.64 | -0.63 |

| Frequency(MHz): | | | 2437 | | Polarity: | | HORIZONTAL | | |
|-----------------|-------------------------|----|----------------|-------------|------------------|-----------------------|-------------------|--------------------|--------------------------|
| Frequency (MHz) | Emission Level (dBuV/m) | | Limit (dBuV/m) | Margin (dB) | Raw Value (dBuV) | Antenna Factor (dB/m) | Cable Factor (dB) | Pre-amplifier (dB) | Correction Factor (dB/m) |
| 4874.00 | 61.55 | PK | 74 | 12.45 | 65.50 | 32.56 | 5.34 | 41.85 | -3.95 |
| 4874.00 | 45.94 | AV | 54 | 8.06 | 49.89 | 32.56 | 5.34 | 41.85 | -3.95 |
| 7311.00 | 54.24 | PK | 74 | 19.76 | 54.60 | 36.54 | 6.81 | 43.71 | -0.36 |
| 7311.00 | 42.16 | AV | 54 | 11.84 | 42.52 | 36.54 | 6.81 | 43.71 | -0.36 |

| Frequency(MHz): | | | 2437 | | Polarity: | | VERTICAL | | |
|-----------------|-------------------------|----|----------------|-------------|------------------|-----------------------|-------------------|--------------------|--------------------------|
| Frequency (MHz) | Emission Level (dBuV/m) | | Limit (dBuV/m) | Margin (dB) | Raw Value (dBuV) | Antenna Factor (dB/m) | Cable Factor (dB) | Pre-amplifier (dB) | Correction Factor (dB/m) |
| 4874.00 | 59.85 | PK | 74 | 14.15 | 63.80 | 32.56 | 5.34 | 41.85 | -3.95 |
| 4874.00 | 45.28 | AV | 54 | 8.72 | 49.23 | 32.56 | 5.34 | 41.85 | -3.95 |
| 7311.00 | 52.78 | PK | 74 | 21.22 | 53.14 | 36.54 | 6.81 | 43.71 | -0.36 |
| 7311.00 | 42.01 | AV | 54 | 11.99 | 42.37 | 36.54 | 6.81 | 43.71 | -0.36 |

| Frequency(MHz): | | | 2462 | | Polarity: | | HORIZONTAL | | |
|-----------------|-------------------------|----|----------------|-------------|------------------|-----------------------|-------------------|--------------------|--------------------------|
| Frequency (MHz) | Emission Level (dBuV/m) | | Limit (dBuV/m) | Margin (dB) | Raw Value (dBuV) | Antenna Factor (dB/m) | Cable Factor (dB) | Pre-amplifier (dB) | Correction Factor (dB/m) |
| 4924.00 | 61.29 | PK | 74 | 12.71 | 64.75 | 32.73 | 5.64 | 41.83 | -3.46 |
| 4924.00 | 45.47 | AV | 54 | 8.53 | 48.93 | 32.73 | 5.64 | 41.83 | -3.46 |
| 7386.00 | 54.23 | PK | 74 | 19.77 | 54.29 | 36.5 | 7.23 | 43.79 | -0.06 |
| 7386.00 | 42.91 | PK | 54 | 11.09 | 42.97 | 36.5 | 7.23 | 43.79 | -0.06 |

| Frequency(MHz): | | | 2462 | | Polarity: | | VERTICAL | | |
|-----------------|-------------------------|----|----------------|-------------|------------------|-----------------------|-------------------|--------------------|--------------------------|
| Frequency (MHz) | Emission Level (dBuV/m) | | Limit (dBuV/m) | Margin (dB) | Raw Value (dBuV) | Antenna Factor (dB/m) | Cable Factor (dB) | Pre-amplifier (dB) | Correction Factor (dB/m) |
| 4924.00 | 59.32 | PK | 74 | 14.68 | 62.78 | 32.73 | 5.64 | 41.83 | -3.46 |
| 4924.00 | 43.02 | AV | 54 | 10.98 | 46.48 | 32.73 | 5.64 | 41.83 | -3.46 |
| 7386.00 | 52.36 | PK | 74 | 21.64 | 52.42 | 36.5 | 7.23 | 43.79 | -0.06 |
| 7386.00 | 41.57 | PK | 54 | 12.43 | 41.63 | 36.5 | 7.23 | 43.79 | -0.06 |

Shenzhen CTA Testing Technology Co., Ltd.

Room 106, Building 1, Yibaolai Industrial Park, Qiaotou Community, Fuhai Street, Bao'an District, Shenzhen, China
Tel:+86-755 2322 5875 E-mail:cta@cta-test.cn Web:http://www.cta-test.cn

- 1) Emission level (dBuV/m) = Meter Reading+ antenna Factor+ cable loss- preamp factor.
- 2) Margin value = Limits-Emission level.
- 3) -- Mean the PK detector measured value is below average limit.
- 4) The other emission levels were very low against the limit.
- 5) RBW1MHz VBW3MHz Peak detector is for PK value; RBW 1MHz VBW10Hz Peak detector is for AV value.

Results of Band Edges Test (Radiated)

Note: 802.11b/802.11g/802.11n (H20)/ 802.11n (H40) Mode all have been tested, only worse case 802.11b mode is reported

| Frequency(MHz): | | | 2412 | | Polarity: | | HORIZONTAL | | |
|-----------------|-------------------------|----|----------------|-------------|------------------|-----------------------|-------------------|--------------------|--------------------------|
| Frequency (MHz) | Emission Level (dBuV/m) | | Limit (dBuV/m) | Margin (dB) | Raw Value (dBuV) | Antenna Factor (dB/m) | Cable Factor (dB) | Pre-amplifier (dB) | Correction Factor (dB/m) |
| 2390.00 | 61.72 | PK | 74 | 12.28 | 72.14 | 27.42 | 4.31 | 42.15 | -10.42 |
| 2390.00 | 42.24 | AV | 54 | 11.76 | 52.66 | 27.42 | 4.31 | 42.15 | -10.42 |
| Frequency(MHz): | | | 2412 | | Polarity: | | VERTICAL | | |
| Frequency (MHz) | Emission Level (dBuV/m) | | Limit (dBuV/m) | Margin (dB) | Raw Value (dBuV) | Antenna Factor (dB/m) | Cable Factor (dB) | Pre-amplifier (dB) | Correction Factor (dB/m) |
| 2390.00 | 59.36 | PK | 74 | 14.64 | 69.78 | 27.42 | 4.31 | 42.15 | -10.42 |
| 2390.00 | 41.06 | AV | 54 | 12.94 | 51.48 | 27.42 | 4.31 | 42.15 | -10.42 |
| Frequency(MHz): | | | 2462 | | Polarity: | | HORIZONTAL | | |
| Frequency (MHz) | Emission Level (dBuV/m) | | Limit (dBuV/m) | Margin (dB) | Raw Value (dBuV) | Antenna Factor (dB/m) | Cable Factor (dB) | Pre-amplifier (dB) | Correction Factor (dB/m) |
| 2483.50 | 61.64 | PK | 74 | 12.36 | 71.75 | 27.7 | 4.47 | 42.28 | -10.11 |
| 2483.50 | 41.78 | AV | 54 | 12.22 | 51.89 | 27.7 | 4.47 | 42.28 | -10.11 |
| Frequency(MHz): | | | 2462 | | Polarity: | | VERTICAL | | |
| Frequency (MHz) | Emission Level (dBuV/m) | | Limit (dBuV/m) | Margin (dB) | Raw Value (dBuV) | Antenna Factor (dB/m) | Cable Factor (dB) | Pre-amplifier (dB) | Correction Factor (dB/m) |
| 2483.50 | 59.19 | PK | 74 | 14.81 | 69.30 | 27.7 | 4.47 | 42.28 | -10.11 |
| 2483.50 | 40.43 | AV | 54 | 13.57 | 50.54 | 27.7 | 4.47 | 42.28 | -10.11 |

Note:

- 1) Emission level (dBuV/m) = Meter Reading+ antenna Factor+ cable loss- preamp factor.
- 2) Margin value = Limits-Emission level.
- 3) -- Mean the PK detector measured value is below average limit.
- 4) The other emission levels were very low against the limit.
- 5) RBW1MHz VBW3MHz Peak detector is for PK value; RBW 1MHz VBW10Hz Peak detector is for AV value.

4.3 Maximum Peak Conducted Output Power

Limit

The Maximum Peak Output Power Measurement is 30dBm.

Test Procedure

Remove the antenna from the EUT and then connect a low loss RF cable from the antenna port to the power sensor.

Test Configuration

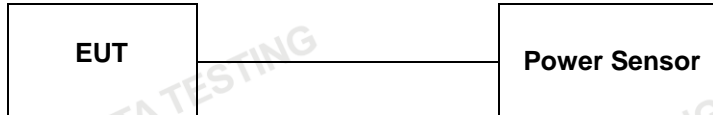

Test Results

Ant1:

| Type | Channel | Output power PK (dBm) | Limit (dBm) | Result |
|---------------|---------|-----------------------|-------------|--------|
| 802.11b | 01 | 7.02 | 30.00 | Pass |
| | 06 | 7.88 | | |
| | 11 | 5.72 | | |
| 802.11g | 01 | 7.29 | 30.00 | Pass |
| | 06 | 7.16 | | |
| | 11 | 6.32 | | |
| 802.11n(HT20) | 01 | 4.66 | 30.00 | Pass |
| | 06 | 6.30 | | |
| | 11 | 4.45 | | |
| 802.11n(HT40) | 03 | 6.12 | 30.00 | Pass |
| | 06 | 6.20 | | |
| | 09 | 5.98 | | |

Ant2:

| Type | Channel | Output power PK (dBm) | Limit (dBm) | Result |
|---------------|---------|-----------------------|-------------|--------|
| 802.11b | 01 | 6.27 | 30.00 | Pass |
| | 06 | 8.08 | | |
| | 11 | 5.79 | | |
| 802.11g | 01 | 4.25 | 30.00 | Pass |
| | 06 | 7.10 | | |
| | 11 | 5.11 | | |
| 802.11n(HT20) | 01 | 5.02 | 30.00 | Pass |
| | 06 | 6.68 | | |
| | 11 | 4.65 | | |
| 802.11n(HT40) | 03 | 6.10 | 30.00 | Pass |
| | 06 | 5.90 | | |
| | 09 | 6.32 | | |

Note:

- 1) Measured output power at difference data rate for each mode and recorded worst case for each mode.
- 2) Test results including cable loss.
- 3) Worst case data at 1Mbps at IEEE 802.11b; 6Mbps at IEEE 802.11g; 6.5Mbps at IEEE 802.11n HT20; 13.5Mbps at IEEE 802.11n HT40;

For MIMO:

| Type | Channel | Output power PK(dBm) ANT1 | Output power PK(dBm) ANT2 | Output power PK(dBm) MIMO | Limit (dBm) | Result |
|---------------|---------|---------------------------|---------------------------|---------------------------|-------------|--------|
| 802.11n(HT20) | 01 | 4.66 | 5.02 | 7.85 | 30.00 | Pass |
| | 06 | 6.30 | 6.68 | 9.50 | | |
| | 11 | 4.45 | 4.65 | 7.56 | | |
| 802.11n(HT40) | 03 | 6.12 | 6.10 | 9.12 | 30.00 | Pass |
| | 06 | 6.20 | 5.90 | 9.06 | | |
| | 09 | 5.98 | 6.32 | 9.16 | | |

4.4 Power Spectral Density

Limit

For digitally modulated systems, the power spectral density conducted from the intentional radiator to the antenna shall not be greater than 8 dBm in any 3 kHz band during any time interval of continuous transmission.

Test Procedure

1. Use this procedure when the maximum peak conducted output power in the fundamental emission is used to demonstrate compliance.
2. Set the RBW \geq 3 kHz.
3. Set the VBW \geq 3 \times RBW.
4. Set the span to 1.5 times the DTS channel bandwidth.
5. Detector = peak.
6. Sweep time = auto couple.
7. Trace mode = max hold.
8. Allow trace to fully stabilize.
9. Use the peak marker function to determine the maximum power level.
10. If measured value exceeds limit, reduce RBW (no less than 3 kHz) and repeat.
11. The resulting peak PSD level must be 8dBm.

Test Configuration



Test Results

Ant1:

| Type | Channel | Power Spectral Density (dBm/3KHz) | Limit (dBm/3KHz) | Result |
|---------------|---------|-----------------------------------|------------------|--------|
| 802.11b | 01 | -18.39 | 8.00 | Pass |
| | 06 | -16.58 | | |
| | 11 | -19.06 | | |
| 802.11g | 01 | -20.05 | 8.00 | Pass |
| | 06 | -21.77 | | |
| | 11 | -21.41 | | |
| 802.11n(HT20) | 01 | -24.58 | 8.00 | Pass |
| | 06 | -21.84 | | |
| | 11 | -25.01 | | |
| 802.11n(HT40) | 03 | -26.90 | 8.00 | Pass |
| | 06 | -25.46 | | |
| | 09 | -25.87 | | |

Ant2:

| Type | Channel | Power Spectral Density (dBm/3KHz) | Limit (dBm/3KHz) | Result |
|---------------|---------|-----------------------------------|------------------|--------|
| 802.11b | 01 | -18.88 | 8.00 | Pass |
| | 06 | -17.11 | | |
| | 11 | -18.73 | | |
| 802.11g | 01 | -24.02 | 8.00 | Pass |
| | 06 | -21.36 | | |
| | 11 | -24.49 | | |
| 802.11n(HT20) | 01 | -24.26 | 8.00 | Pass |
| | 06 | -21.60 | | |
| | 11 | -25.19 | | |
| 802.11n(HT40) | 03 | -27.50 | 8.00 | Pass |
| | 06 | -24.45 | | |
| | 09 | -26.03 | | |

Note:

- 1) Measured peak power spectrum density at difference data rate for each mode and recorded worst case for each mode.
 - 2) Test results including cable loss;
 - 3) Worst case data at 1Mbps at IEEE 802.11b; 6Mbps at IEEE 802.11g; 6.5Mbps at IEEE 802.11n HT20; 13.5Mbps at IEEE 802.11n HT40;
- Please refer to following plots;

For MIMO:

| Type | Channel | Power Spectral Density (dBm/3KHz) ANT1 | Power Spectral Density (dBm/3KHz) ANT2 | Power Spectral Density (dBm/3KHz) MIMO | Limit (dBm) | Result |
|---------------|---------|--|--|--|-------------|--------|
| 802.11n(HT20) | 01 | -24.58 | -24.26 | -21.41 | 8.00 | Pass |
| | 06 | -21.84 | -21.6 | -18.71 | | |
| | 11 | -25.01 | -25.19 | -22.09 | | |
| 802.11n(HT40) | 03 | -26.9 | -27.5 | -24.18 | 8.00 | Pass |
| | 06 | -25.46 | -24.45 | -21.92 | | |
| | 09 | -25.87 | -26.03 | -22.94 | | |

Ant1:

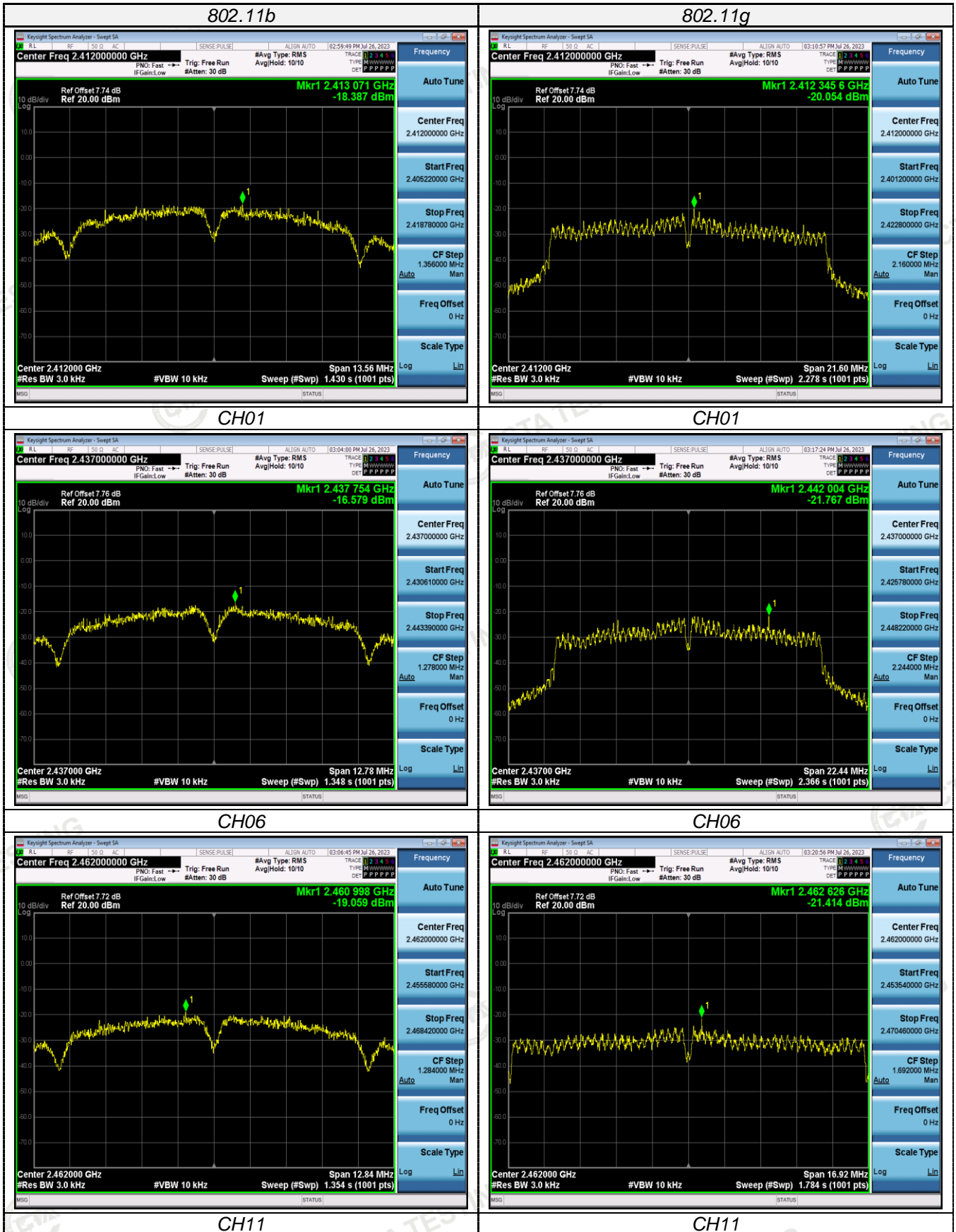

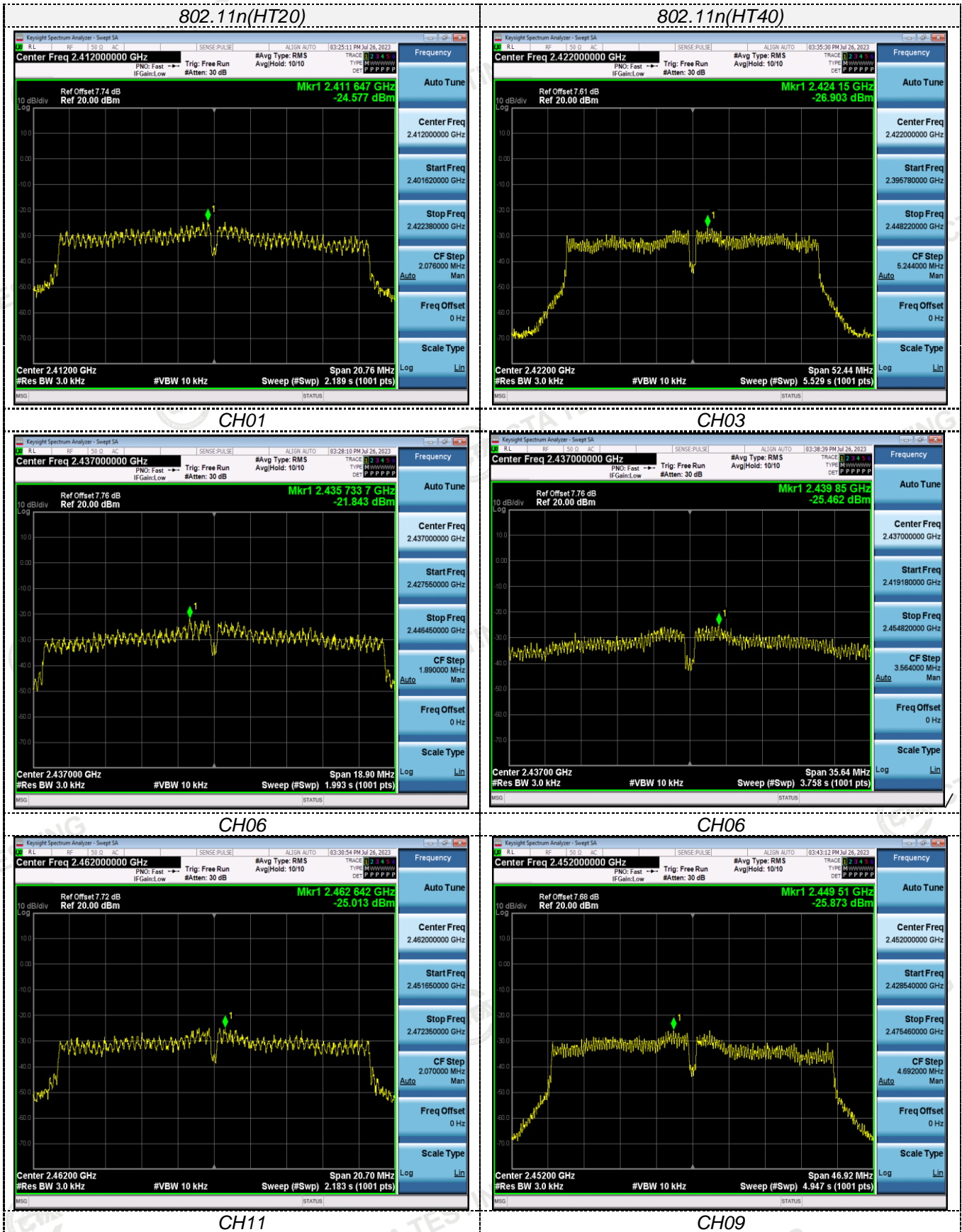

Ant2:

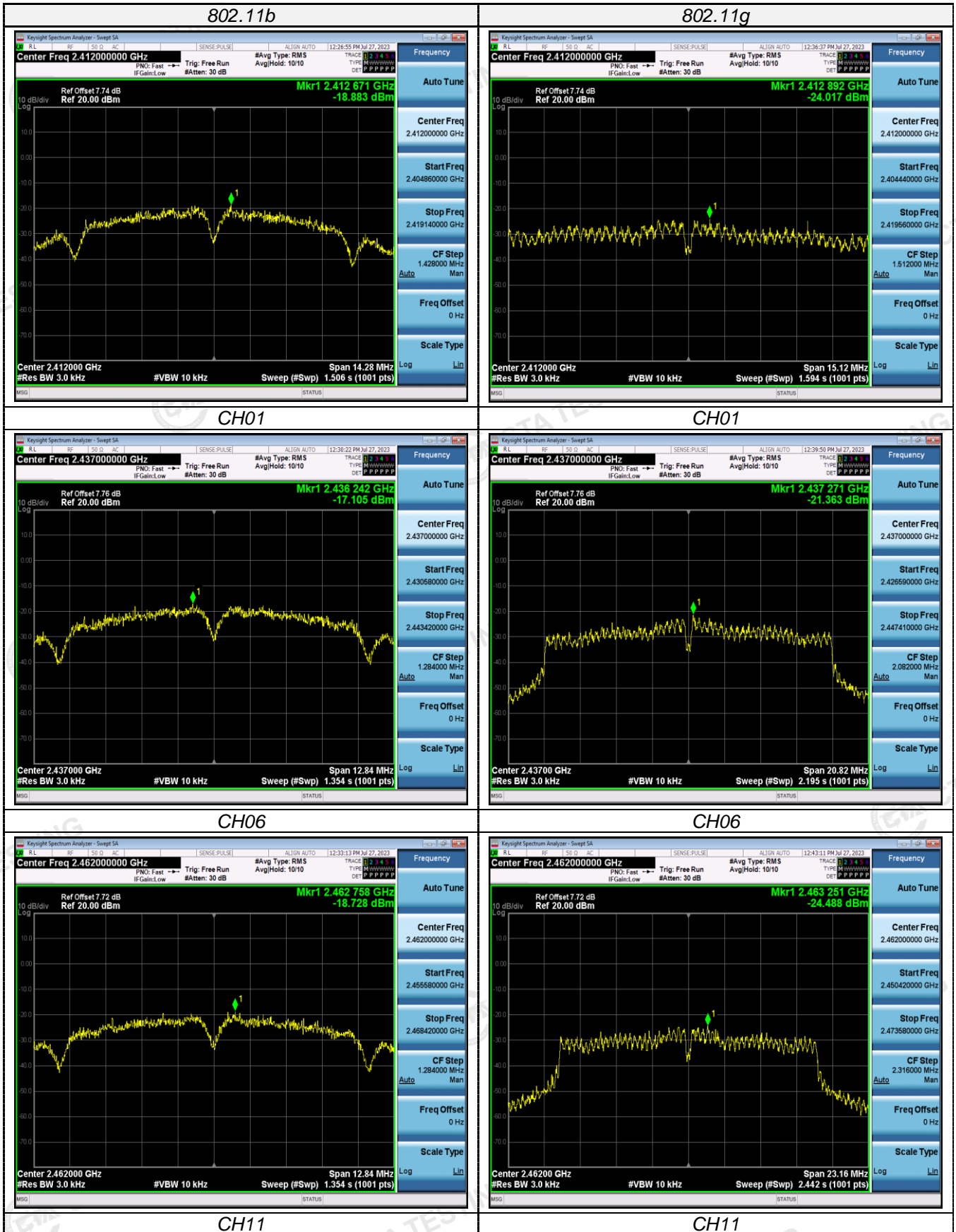

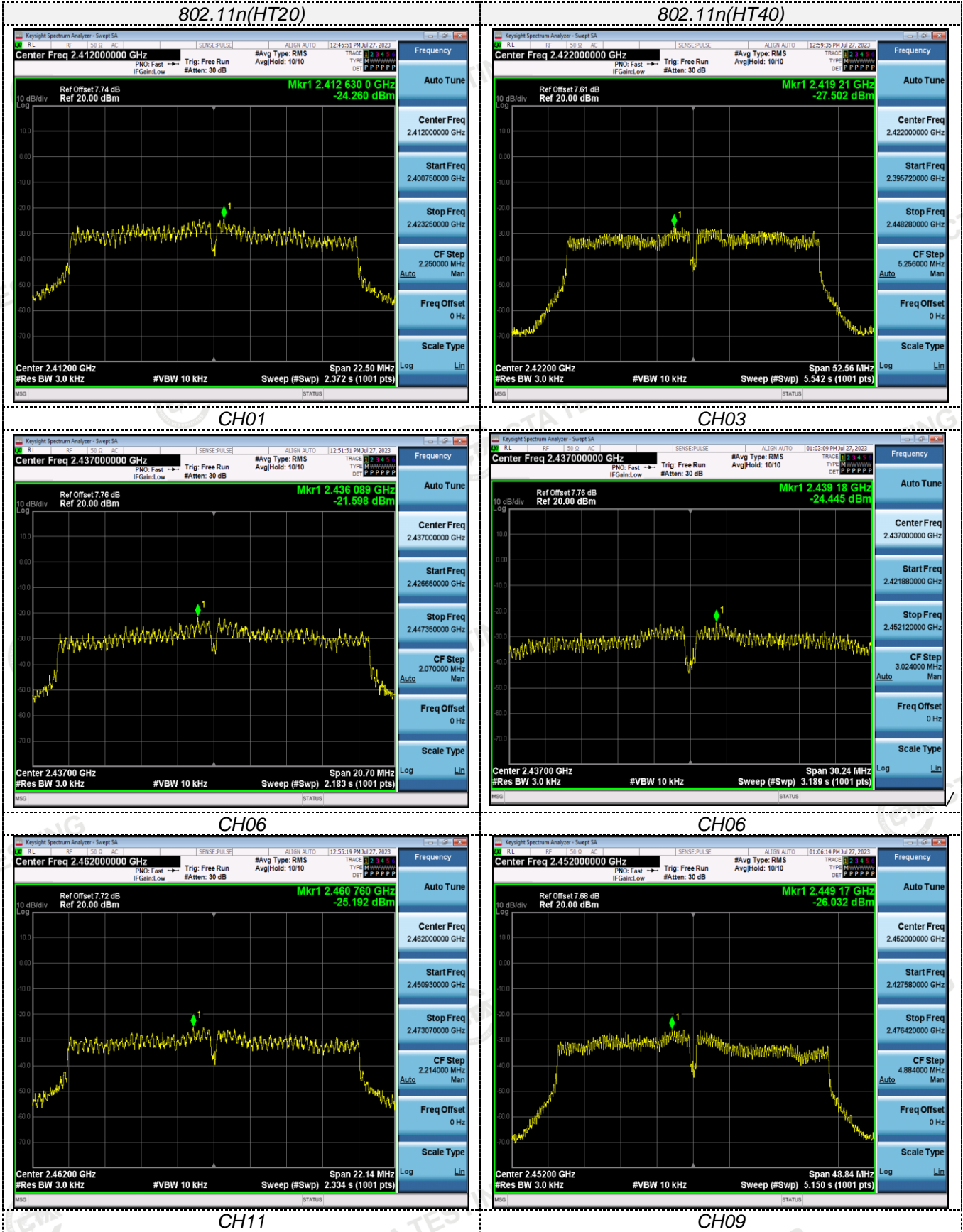

4.5 6dB Bandwidth

Limit

For digital modulation systems, the minimum 6 dB bandwidth shall be at least 500 kHz

Test Procedure

The transmitter output was connected to the spectrum analyzer through an attenuator. The bandwidth of the fundamental frequency was measured by spectrum analyzer with 100 KHz RBW and 300 KHz VBW. The 6dB bandwidth is defined as the total spectrum the power of which is higher than peak power minus 6dB.

Test Configuration

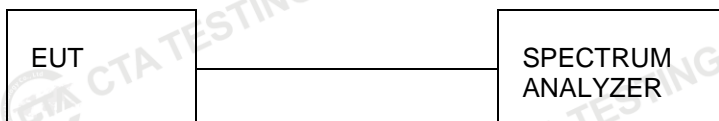

Test Results

Ant1:

| Type | Channel | 6dB Bandwidth (MHz) | Limit (KHz) | Result |
|---------------|---------|---------------------|-------------|--------|
| 802.11b | 01 | 9.040 | ≥500 | Pass |
| | 06 | 8.520 | | |
| | 11 | 8.560 | | |
| 802.11g | 01 | 14.400 | ≥500 | Pass |
| | 06 | 14.960 | | |
| | 11 | 11.280 | | |
| 802.11n(HT20) | 01 | 13.840 | ≥500 | Pass |
| | 06 | 12.600 | | |
| | 11 | 13.800 | | |
| 802.11n(HT40) | 03 | 34.960 | ≥500 | Pass |
| | 06 | 23.760 | | |
| | 09 | 31.280 | | |

Ant2:

| Type | Channel | 6dB Bandwidth (MHz) | Limit (KHz) | Result |
|---------------|---------|---------------------|-------------|--------|
| 802.11b | 01 | 9.520 | ≥500 | Pass |
| | 06 | 8.560 | | |
| | 11 | 8.560 | | |
| 802.11g | 01 | 10.080 | ≥500 | Pass |
| | 06 | 13.880 | | |
| | 11 | 15.440 | | |
| 802.11n(HT20) | 01 | 15.000 | ≥500 | Pass |
| | 06 | 13.800 | | |
| | 11 | 14.760 | | |
| 802.11n(HT40) | 03 | 35.040 | ≥500 | Pass |
| | 06 | 20.160 | | |
| | 09 | 32.560 | | |

Note:

- 1) Measured peak power spectrum density at difference data rate for each mode and recorded worst case for each mode.
- 2) Test results including cable loss;
- 3) Worst case data at 1Mbps at IEEE 802.11b; 6Mbps at IEEE 802.11g; 6.5Mbps at IEEE 802.11n HT20; 13.5Mbps at IEEE 802.11n HT40;

Please refer to following plots;

Ant1:

