



Shenzhen CTA Testing Technology Co., Ltd.

Room 106, Building 1, Yibaolai Industrial Park, Qiaotou Community, Fuhai Street, Bao'an District, Shenzhen, China

FCC PART 15 SUBPART C TEST REPORT

FCC PART 15.247

Report Reference No.....: **CTA23031400102**

FCC ID..... : **XR3-TABMINIC**

Compiled by

(position+printed name+signature)...: File administrators Zoey Cao

Supervised by

(position+printed name+signature)...: Project Engineer Amy Wen

Approved by

(position+printed name+signature)...: RF Manager Eric Wang

Date of issue.....: Mar. 31, 2023

Zoey Cao

Amy Wen

Eric Wang

Shenzhen CTA Testing Technology Co., Ltd.
approved

Testing Laboratory Name: **Shenzhen CTA Testing Technology Co., Ltd.**

Address: Room 106, Building 1, Yibaolai Industrial Park, Qiaotou Community, Fuhai Street, Bao'an District, Shenzhen, China

Applicant's name.....: **ONYX INTERNATIONAL INC.**

Address: Room 101, Building 4, No. 202 Shiyu Road, Nansha District, Guangzhou City, Guangdong Province, China

Test specification

Standard.....: **FCC Part 15.247**

Shenzhen CTA Testing Technology Co., Ltd. All rights reserved.

This publication may be reproduced in whole or in part for non-commercial purposes as long as the Shenzhen CTA Testing Technology Co., Ltd. is acknowledged as copyright owner and source of the material. Shenzhen CTA Testing Technology Co., Ltd. takes no responsibility for and will not assume liability for damages resulting from the reader's interpretation of the reproduced material due to its placement and context.

Test item description: **ePaper Tablet PC, E Ink Tablet PC, 2-in-1 Tablet PC, E Ink Tablet, Color ePaper Tablet PC, Color E Ink Tablet PC, Color 2-in-1 Tablet PC, Color E Ink Table**

Trade Mark: BOOX

Manufacturer: ONYX INTERNATIONAL INC.

Model/Type reference.....: Tab Mini C

Listed Models: Tab Mini, Tab Mini Plus, Tab Mini Pro, Tab Mini C Plus, Tab Mini C Pro, Tab Mini2, Tab Mini2 C, Tab Mini2 Plus, Tab Mini2 Pro

Modulation: GFSK, Π/4DQPSK, 8DPSK

Frequency..... From 2402MHz to 2480MHz

Rating: DC 3.8V From Battery and DC 5.0V From external circuit

Result.....: **PASS**

Shenzhen CTA Testing Technology Co., Ltd.

Room 106, Building 1, Yibaolai Industrial Park, Qiaotou Community, Fuhai Street, Bao'an District, Shenzhen, China
Tel:+86-755 2322 5875 E-mail:cta@cta-test.cn Web:http://www.cta-test.cn

TEST REPORT

Equipment under Test : ePaper Tablet PC, E Ink Tablet PC, 2-in-1 Tablet PC, E Ink Tablet, Color ePaper Tablet PC, Color E Ink Tablet PC, Color 2-in-1 Tablet PC, Color E Ink Table

Model /Type : Tab Mini C

Listed Models : Tab Mini, Tab Mini Plus, Tab Mini Pro, Tab Mini C Plus, Tab Mini C Pro, Tab Mini2, Tab Mini2 C, Tab Mini2 Plus, Tab Mini2 Pro

Applicant : ONYX INTERNATIONAL INC.

Address : Room 101, Building 4, No. 202 Shiyu Road, Nansha District, Guangzhou City, Guangdong Province, China

Manufacturer : ONYX INTERNATIONAL INC.

Address : Room 101, Building 4, No. 202 Shiyu Road, Nansha District, Guangzhou City, Guangdong Province, China

Test Result:	PASS
---------------------	-------------

The test report merely corresponds to the test sample.
It is not permitted to copy extracts of these test result without the written permission of the test laboratory.

Contents

1	<u>TEST STANDARDS</u>	4
2	<u>SUMMARY</u>	5
2.1	General Remarks	5
2.2	Product Description	5
2.3	Equipment Under Test	5
2.4	Short description of the Equipment under Test (EUT)	5
2.5	EUT operation mode	6
2.6	Block Diagram of Test Setup	6
2.7	Related Submittal(s) / Grant (s)	6
2.8	Modifications	6
3	<u>TEST ENVIRONMENT</u>	7
3.1	Address of the test laboratory	7
3.2	Test Facility	7
3.3	Environmental conditions	7
3.4	Summary of measurement results	8
3.5	Statement of the measurement uncertainty	8
3.6	Equipments Used during the Test	9
4	<u>TEST CONDITIONS AND RESULTS.....</u>	10
4.1	AC Power Conducted Emission	10
4.2	Radiated Emission	13
4.3	Maximum Peak Output Power	19
4.4	20dB Bandwidth	20
4.5	Frequency Separation	24
4.6	Number of hopping frequency	26
4.7	Time of Occupancy (Dwell Time)	28
4.8	Out-of-band Emissions	32
4.9	Pseudorandom Frequency Hopping Sequence	41
4.10	Antenna Requirement	42
5	<u>TEST SETUP PHOTOS OF THE EUT</u>	43
6	<u>PHOTOS OF THE EUT</u>	44

1 TEST STANDARDS

The tests were performed according to following standards:

[FCC Rules Part 15.247](#): Frequency Hopping, Direct Spread Spectrum and Hybrid Systems that are in operation within the bands of 902-928 MHz, 2400-2483.5 MHz, and 5725-5850 MHz.

[ANSI C63.10-2013](#): American National Standard for Testing Unlicensed Wireless Devices

2 SUMMARY

2.1 General Remarks

Date of receipt of test sample	:	Mar. 14, 2023
Testing commenced on	:	Mar. 14, 2023
Testing concluded on	:	Mar. 31, 2023

2.2 Product Description

Product Description:	ePaper Tablet PC, E Ink Tablet PC, 2-in-1 Tablet PC, E Ink Tablet, Color ePaper Tablet PC, Color E Ink Tablet PC, Color 2-in-1 Tablet PC, Color E Ink Table
Model/Type reference:	Tab Mini C
Power supply:	DC 3.8V From Battery and DC 5.0V From external circuit
Adapter information (Auxiliary test supplied by test Lab) :	Model: GS-551 Input: AC 100-240V 50/60Hz Output: DC 5V 3A
Hardware version:	BOOX_M4_100_NOVA_AIR2_TABLET_V10
Software version:	TAB8C-2023.03.23
Testing sample ID:	CTA230314001-1# (Engineer sample) CTA230314001-2# (Normal sample)
Bluetooth :	
Supported Type:	Bluetooth BR/EDR
Modulation:	GFSK, $\pi/4$ DQPSK, 8DPSK
Operation frequency:	2402MHz~2480MHz
Channel number:	79
Channel separation:	1MHz
Antenna type:	PIFA antenna
Antenna gain:	2.00 dBi

2.3 Equipment Under Test

Power supply system utilised

Power supply voltage	:	<input type="radio"/> 230V / 50 Hz	<input type="radio"/> 120V / 60Hz
		<input type="radio"/> 12 V DC	<input type="radio"/> 24 V DC
		<input checked="" type="radio"/> Other (specified in blank below)	

DC 3.8V From Battery and DC 5.0V From external circuit

2.4 Short description of the Equipment under Test (EUT)

This is an ePaper Tablet PC, E Ink Tablet PC, 2-in-1 Tablet PC, E Ink Tablet, Color ePaper Tablet PC, Color E Ink Tablet PC, Color 2-in-1 Tablet PC, Color E Ink Table.

For more details, refer to the user's manual of the EUT.

2.5 EUT operation mode

The Applicant provides communication tools software(Engineer mode) to control the EUT for staying in continuous transmitting (Duty Cycle more than 98%) and receiving mode for testing .There are 79 channels provided to the EUT and Channel 00/39/78 were selected to test.

Operation Frequency:

Channel	Frequency (MHz)
00	2402
01	2403
:	:
38	2440
39	2441
40	2442
:	:
77	2479
78	2480

2.6 Block Diagram of Test Setup

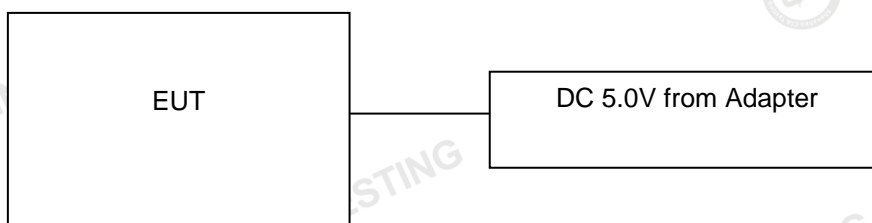

2.7 Related Submittal(s) / Grant (s)

This submittal(s) (test report) is intended for the device filing to comply with Section 15.247 of the FCC Part 15, Subpart C Rules.

2.8 Modifications

No modifications were implemented to meet testing criteria.

3 TEST ENVIRONMENT

3.1 Address of the test laboratory

Shenzhen CTA Testing Technology Co., Ltd.

Room 106, Building 1, Yibaolai Industrial Park, Qiaotou Community, Fuhai Street, Bao'an District, Shenzhen, China

3.2 Test Facility

The test facility is recognized, certified, or accredited by the following organizations:

FCC-Registration No.: 517856 Designation Number: CN1318

Shenzhen CTA Testing Technology Co., Ltd. has been listed on the US Federal Communications Commission list of test facilities recognized to perform electromagnetic emissions measurements.

A2LA-Lab Cert. No.: 6534.01

Shenzhen CTA Testing Technology Co., Ltd. has been listed by American Association for Laboratory Accreditation to perform electromagnetic emission measurement.

ISED#: 27890 CAB identifier: CN0127

Shenzhen CTA Testing Technology Co., Ltd. has been listed by Innovation, Science and Economic Development Canada to perform electromagnetic emission measurement.

The 3m-Semi anechoic test site fulfils CISPR 16-1-4 according to ANSI C63.10 and CISPR 16-1-4:2010.

3.3 Environmental conditions

During the measurement the environmental conditions were within the listed ranges:

Radiated Emission:

Temperature:	24 ° C
Humidity:	45 %
Atmospheric pressure:	950-1050mbar

AC Power Conducted Emission:

Temperature:	25 ° C
Humidity:	46 %
Atmospheric pressure:	950-1050mbar

Conducted testing:

Temperature:	25 ° C
Humidity:	44 %
Atmospheric pressure:	950-1050mbar

Shenzhen CTA Testing Technology Co., Ltd.

Room 106, Building 1, Yibaolai Industrial Park, Qiaotou Community, Fuhai Street, Bao'an District, Shenzhen, China
Tel:+86-755 2322 5875 E-mail:cta@cta-test.cn Web:http://www.cta-test.cn

3.4 Summary of measurement results

Test Specification clause	Test case	Test Mode	Test Channel	Recorded In Report		Test result
§15.247(a)(1)	Carrier Frequency separation	GFSK Π/4DQPSK 8DPSK	<input checked="" type="checkbox"/> Lowest <input checked="" type="checkbox"/> Middle <input checked="" type="checkbox"/> Highest	GFSK Π/4DQPSK 8DPSK	<input checked="" type="checkbox"/> Middle	Compliant
§15.247(a)(1)	Number of Hopping channels	GFSK Π/4DQPSK 8DPSK	<input checked="" type="checkbox"/> Full	GFSK	<input checked="" type="checkbox"/> Full	Compliant
§15.247(a)(1)	Time of Occupancy (dwell time)	GFSK Π/4DQPSK 8DPSK	<input checked="" type="checkbox"/> Lowest <input checked="" type="checkbox"/> Middle <input checked="" type="checkbox"/> Highest	GFSK Π/4DQPSK 8DPSK	<input checked="" type="checkbox"/> Middle	Compliant
§15.247(a)(1)	Spectrum bandwidth of aFHSS system 20dB bandwidth	GFSK Π/4DQPSK 8DPSK	<input checked="" type="checkbox"/> Lowest <input checked="" type="checkbox"/> Middle <input checked="" type="checkbox"/> Highest	GFSK Π/4DQPSK 8DPSK	<input checked="" type="checkbox"/> Lowest <input checked="" type="checkbox"/> Middle <input checked="" type="checkbox"/> Highest	Compliant
§15.247(b)(1)	Maximum output peak power	GFSK Π/4DQPSK 8DPSK	<input checked="" type="checkbox"/> Lowest <input checked="" type="checkbox"/> Middle <input checked="" type="checkbox"/> Highest	GFSK Π/4DQPSK 8DPSK	<input checked="" type="checkbox"/> Lowest <input checked="" type="checkbox"/> Middle <input checked="" type="checkbox"/> Highest	Compliant
§15.247(d)	Band edge compliance conducted	GFSK Π/4DQPSK 8DPSK	<input checked="" type="checkbox"/> Lowest <input checked="" type="checkbox"/> Highest	GFSK Π/4DQPSK 8DPSK	<input checked="" type="checkbox"/> Lowest <input checked="" type="checkbox"/> Highest	Compliant
§15.205	Band edge compliance radiated	GFSK Π/4DQPSK 8DPSK	<input checked="" type="checkbox"/> Lowest <input checked="" type="checkbox"/> Highest	GFSK Π/4DQPSK 8DPSK	<input checked="" type="checkbox"/> Lowest <input checked="" type="checkbox"/> Highest	Compliant
§15.247(d)	TX spurious emissions conducted	GFSK Π/4DQPSK 8DPSK	<input checked="" type="checkbox"/> Lowest <input checked="" type="checkbox"/> Middle <input checked="" type="checkbox"/> Highest	GFSK Π/4DQPSK 8DPSK	<input checked="" type="checkbox"/> Lowest <input checked="" type="checkbox"/> Middle <input checked="" type="checkbox"/> Highest	Compliant
§15.247(d)	TX spurious emissions radiated	GFSK Π/4DQPSK 8DPSK	<input checked="" type="checkbox"/> Lowest <input checked="" type="checkbox"/> Middle <input checked="" type="checkbox"/> Highest	GFSK	<input checked="" type="checkbox"/> Lowest <input checked="" type="checkbox"/> Middle <input checked="" type="checkbox"/> Highest	Compliant
§15.209(a)	TX spurious Emissions radiated Below 1GHz	GFSK Π/4DQPSK 8DPSK	<input checked="" type="checkbox"/> Lowest <input checked="" type="checkbox"/> Middle <input checked="" type="checkbox"/> Highest	GFSK	<input checked="" type="checkbox"/> Middle	Compliant
§15.107(a) §15.207	Conducted Emissions 9KHz-30 MHz	GFSK Π/4DQPSK 8DPSK	<input checked="" type="checkbox"/> Lowest <input checked="" type="checkbox"/> Middle <input checked="" type="checkbox"/> Highest	GFSK	<input checked="" type="checkbox"/> Middle	Compliant

Remark:

1. The measurement uncertainty is not included in the test result.
2. We tested all test mode and recorded worst case in report

3.5 Statement of the measurement uncertainty

The data and results referenced in this document are true and accurate. The reader is cautioned that there may be errors within the calibration limits of the equipment and facilities. The measurement uncertainty was calculated for all measurements listed in this test report acc. to TR-100028-01 "Electromagnetic compatibility and Radio spectrum Matters (ERM); Uncertainties in the measurement of mobile radio equipment characteristics; Part 1" and TR-100028-02 "Electromagnetic compatibility and Radio spectrum Matters (ERM); Uncertainties in the measurement of mobile radio equipment characteristics; Part 2" and is documented in the Shenzhen CTA Testing Technology Co., Ltd. quality system acc. to DIN EN ISO/IEC 17025. Furthermore, component and process variability of devices similar to that tested may result in additional deviation. The manufacturer has the sole responsibility of continued compliance of the device.

Hereafter the best measurement capability for Shenzhen CTA Testing Technology Co., Ltd. :

Test	Range	Measurement Uncertainty	Notes
Radiated Emission	30~1000MHz	4.06 dB	(1)
Radiated Emission	1~18GHz	5.14 dB	(1)
Radiated Emission	18-40GHz	5.38 dB	(1)
Conducted Disturbance	0.15~30MHz	2.14 dB	(1)

- (1) This uncertainty represents an expanded uncertainty expressed at approximately the 95% confidence level using a coverage factor of k=2.

Shenzhen CTA Testing Technology Co., Ltd.

Room 106, Building 1, Yibaolai Industrial Park, Qiaotou Community, Fuhai Street, Bao'an District, Shenzhen, China
Tel:+86-755 2322 5875 E-mail:cta@cta-test.cn Web:http://www.cta-test.cn

3.6 Equipments Used during the Test

Test Equipment	Manufacturer	Model No.	Equipment No.	Calibration Date	Calibration Due Date
LISN	R&S	ENV216	CTA-308	2022/08/03	2023/08/02
LISN	R&S	ENV216	CTA-314	2022/08/03	2023/08/02
EMI Test Receiver	R&S	ESPI	CTA-307	2022/08/03	2023/08/02
EMI Test Receiver	R&S	ESCI	CTA-306	2022/08/03	2023/08/02
Spectrum Analyzer	Agilent	N9020A	CTA-301	2022/08/03	2023/08/02
Spectrum Analyzer	R&S	FSP	CTA-337	2022/08/03	2023/08/02
Vector Signal generator	Agilent	N5182A	CTA-305	2022/08/03	2023/08/02
Analog Signal Generator	R&S	SML03	CTA-304	2022/08/03	2023/08/02
Universal Radio Communication	CMW500	R&S	CTA-302	2022/08/03	2023/08/02
Temperature and humidity meter	Chigo	ZG-7020	CTA-326	2022/08/03	2023/08/02
Ultra-Broadband Antenna	Schwarzbeck	VULB9163	CTA-310	2021/08/07	2024/08/06
Horn Antenna	Schwarzbeck	BBHA 9120D	CTA-309	2021/08/07	2024/08/06
Loop Antenna	Zhinan	ZN30900C	CTA-311	2021/08/07	2024/08/06
Horn Antenna	Beijing Hangwei Dayang	OBH100400	CTA-336	2021/08/07	2024/08/06
Amplifier	Schwarzbeck	BBV 9745	CTA-312	2022/08/03	2023/08/02
Amplifier	Taiwan chengyi	EMC051845B	CTA-313	2022/08/03	2023/08/02
Directional coupler	NARDA	4226-10	CTA-303	2022/08/03	2023/08/02
High-Pass Filter	XingBo	XBLBQ-GTA18	CTA-402	2022/08/03	2023/08/02
High-Pass Filter	XingBo	XBLBQ-GTA27	CTA-403	2022/08/03	2023/08/02
Automated filter bank	Tonscend	JS0806-F	CTA-404	2022/08/03	2023/08/02
Power Sensor	Agilent	U2021XA	CTA-405	2022/08/03	2023/08/02
Amplifier	Schwarzbeck	BBV9719	CTA-406	2022/08/03	2023/08/02

4 TEST CONDITIONS AND RESULTS

4.1 AC Power Conducted Emission

TEST CONFIGURATION

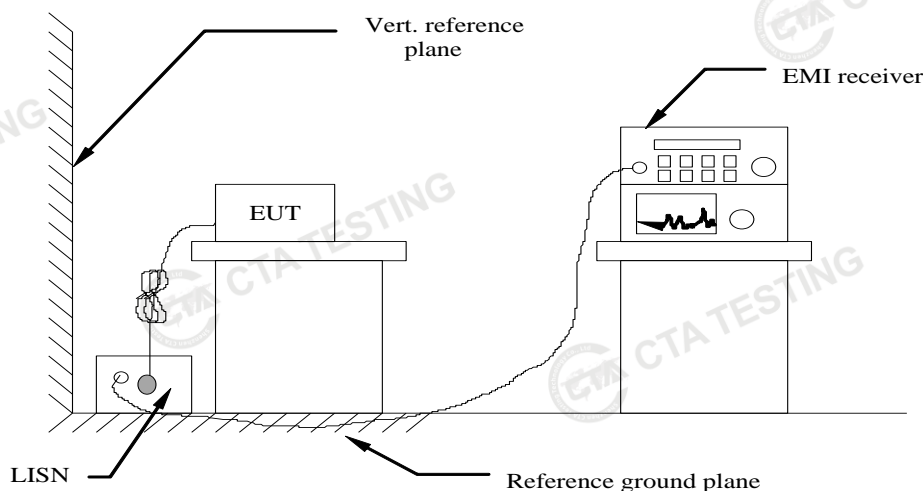

TEST PROCEDURE

- 1 The equipment was set up as per the test configuration to simulate typical actual usage per the user's manual. The EUT is a tabletop system, a wooden table with a height of 0.8 meters is used and is placed on the ground plane as per ANSI C63.10-2013.
- 2 Support equipment, if needed, was placed as per ANSI C63.10-2013
- 3 All I/O cables were positioned to simulate typical actual usage as per ANSI C63.10-2013
- 4 The EUT received power from adapter, the adapter received AC120V/60Hz and AC 240V/60Hz power through a Line Impedance Stabilization Network (LISN) which supplied power source and was grounded to the ground plane.
- 5 All support equipments received AC power from a second LISN, if any.
- 6 The EUT test program was started. Emissions were measured on each current carrying line of the EUT using a spectrum Analyzer / Receiver connected to the LISN powering the EUT. The LISN has two monitoring points: Line 1 (Hot Side) and Line 2 (Neutral Side). Two scans were taken: one with Line 1 connected to Analyzer / Receiver and Line 2 connected to a 50 ohm load; the second scan had Line 1 connected to a 50 ohm load and Line 2 connected to the Analyzer / Receiver.
- 7 Analyzer / Receiver scanned from 150 KHz to 30MHz for emissions in each of the test modes.
- 8 During the above scans, the emissions were maximized by cable manipulation.

AC Power Conducted Emission Limit

For intentional device, according to § 15.207(a) AC Power Conducted Emission Limits is as following :

Frequency range (MHz)	Limit (dBuV)	
	Quasi-peak	Average
0.15-0.5	66 to 56*	56 to 46*
0.5-5	56	46
5-30	60	50

* Decreases with the logarithm of the frequency.

TEST RESULTS

Remark:

1. All modes of GFSK, $\pi/4$ DQPSK and 8DPSK were test at Low, Middle, and High channel; only the worst result of GFSK Middle Channel was reported as below:

Shenzhen CTA Testing Technology Co., Ltd.

Room 106, Building 1, Yibaolai Industrial Park, Qiaotou Community, Fuhai Street, Bao'an District, Shenzhen, China
 Tel:+86-755 2322 5875 E-mail:cta@cta-test.cn Web:http://www.cta-test.cn

2. Both 120 VAC, 50/60 Hz and 240 VAC, 50/60 Hz power supply have been tested, only the worst result of 120 VAC, 60 Hz was reported as below:

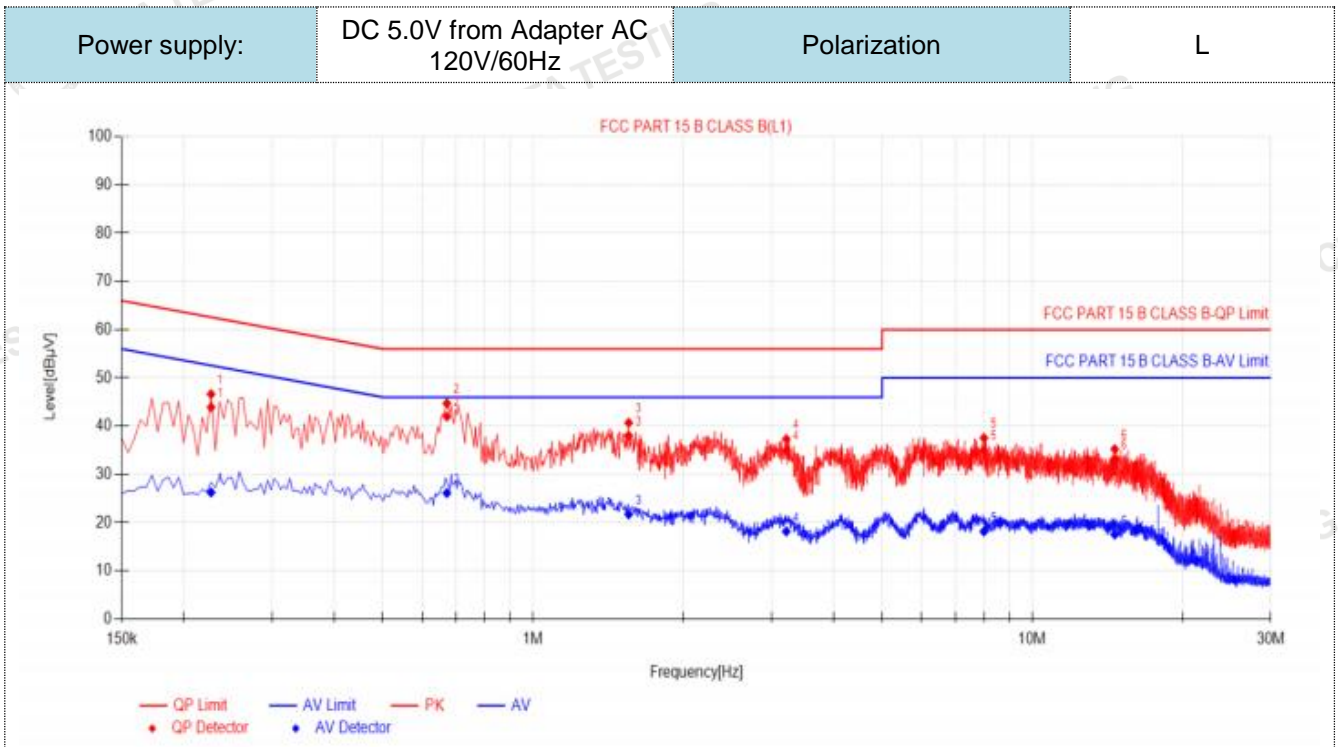

Final Data List

NO.	Freq. [MHz]	Factor [dB]	QP Reading[dB µV]	QP Value [dBµV]	QP Limit [dBµV]	QP Margin [dB]	AV Reading [dBµV]	AV Value [dBµV]	AV Limit [dBµV]	AV Margin [dB]	Verdict
1	0.2265	10.50	33.41	43.91	62.58	18.67	15.75	26.25	52.58	26.33	PASS
2	0.672	10.50	31.49	41.99	56.00	14.01	15.61	26.11	46.00	19.89	PASS
3	1.554	10.50	27.48	37.98	56.00	18.02	11.20	21.70	46.00	24.30	PASS
4	3.2145	10.50	24.48	34.98	56.00	21.02	7.66	18.16	46.00	27.84	PASS
5	7.998	10.50	24.52	35.02	60.00	24.98	7.65	18.15	50.00	31.85	PASS
6	14.613	10.50	22.69	33.19	60.00	26.81	7.01	17.51	50.00	32.49	PASS

Note:1).QP Value (dBµV)= QP Reading (dBµV)+ Factor (dB)

2). Factor (dB)=insertion loss of LISN (dB) + Cable loss (dB)

3). QPMargin(dB) = QP Limit (dBµV) - QP Value (dBµV)

4). AVMargin(dB) = AV Limit (dBµV) - AV Value (dBµV)

Power supply:	DC 5.0V from Adapter AC 120V/60Hz	Polarization	N
---------------	--------------------------------------	--------------	---

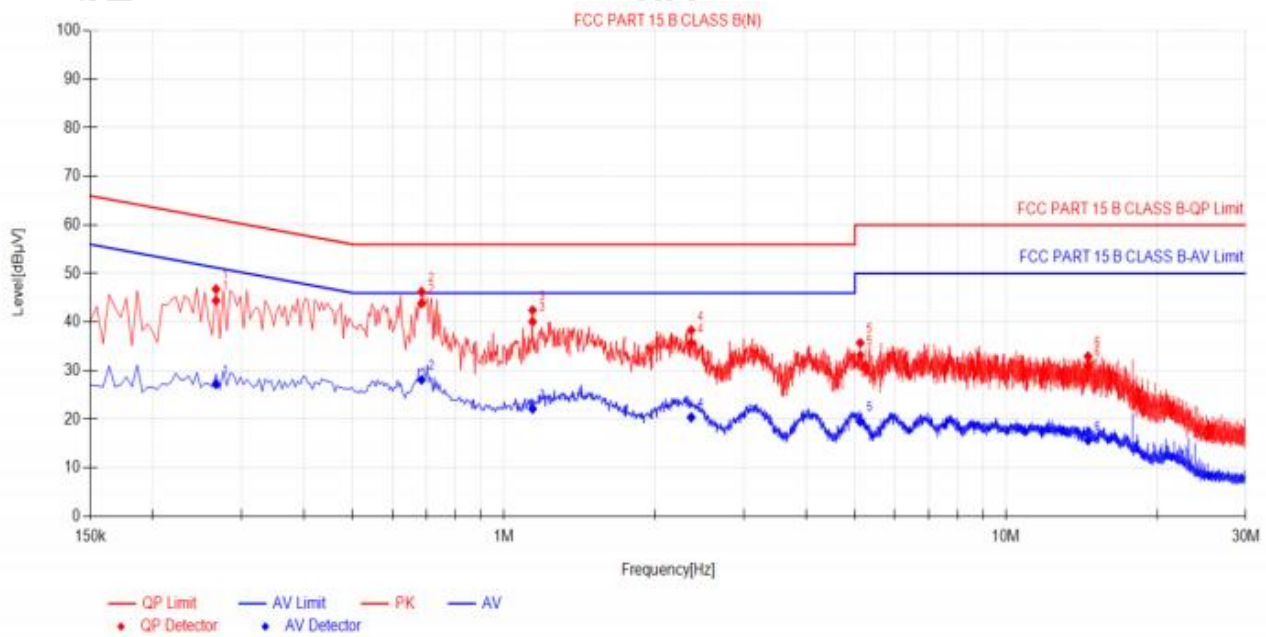

Final Data List											
NO.	Freq. [MHz]	Factor [dB]	QP Reading[dB μV]	QP Value [dBμV]	QP Limit [dBμV]	QP Margin [dB]	AV Reading [dBμV]	AV Value [dBμV]	AV Limit [dBμV]	AV Margin [dB]	Verdict
1	0.267	10.50	33.93	44.43	61.21	16.78	16.71	27.21	51.21	24.00	PASS
2	0.6855	10.50	33.40	43.90	56.00	12.10	17.63	28.13	46.00	17.87	PASS
3	1.14	10.50	29.59	40.09	56.00	15.91	11.63	22.13	46.00	23.87	PASS
4	2.3595	10.50	25.18	35.68	56.00	20.32	9.89	20.39	46.00	25.61	PASS
5	5.1225	10.50	22.66	33.16	60.00	26.84	8.99	19.49	50.00	30.51	PASS
6	14.559	10.50	20.40	30.90	60.00	29.10	5.16	15.66	50.00	34.34	PASS

- Note:1). QP Value (dBμV) = QP Reading (dBμV) + Factor (dB)
 2). Factor (dB) = insertion loss of LISN (dB) + Cable loss (dB)
 3). QPMargin(dB) = QP Limit (dBμV) - QP Value (dBμV)
 4). AVMargin(dB) = AV Limit (dBμV) - AV Value (dBμV)

4.2 Radiated Emission

TEST CONFIGURATION

Frequency range 9 KHz – 30MHz

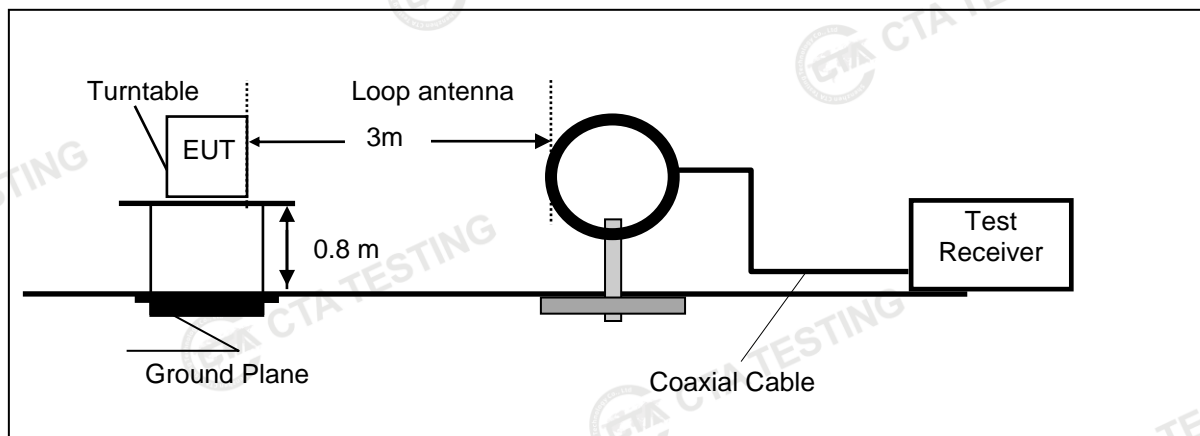

Frequency range 30MHz – 1000MHz

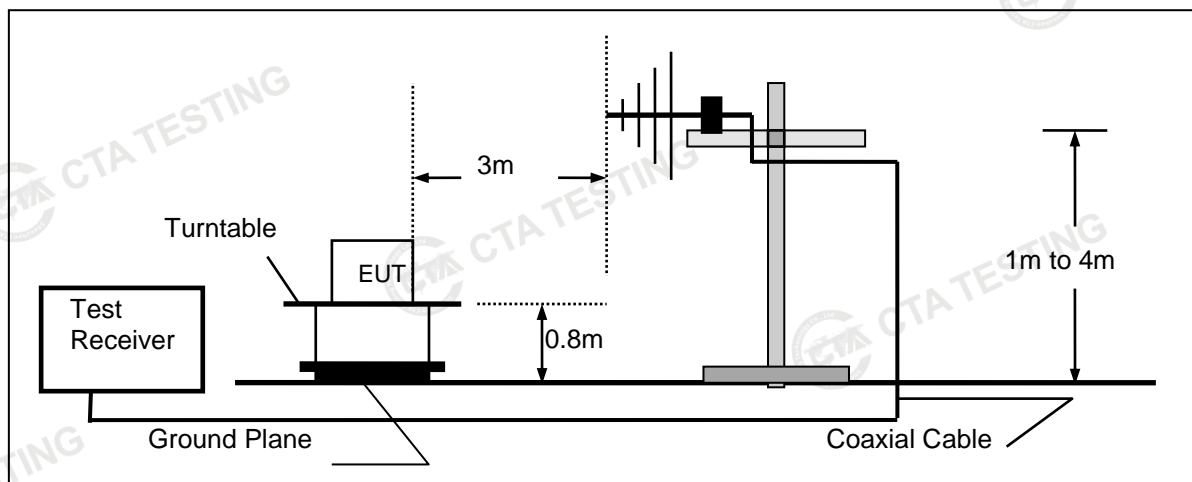

Frequency range above 1GHz-25GHz

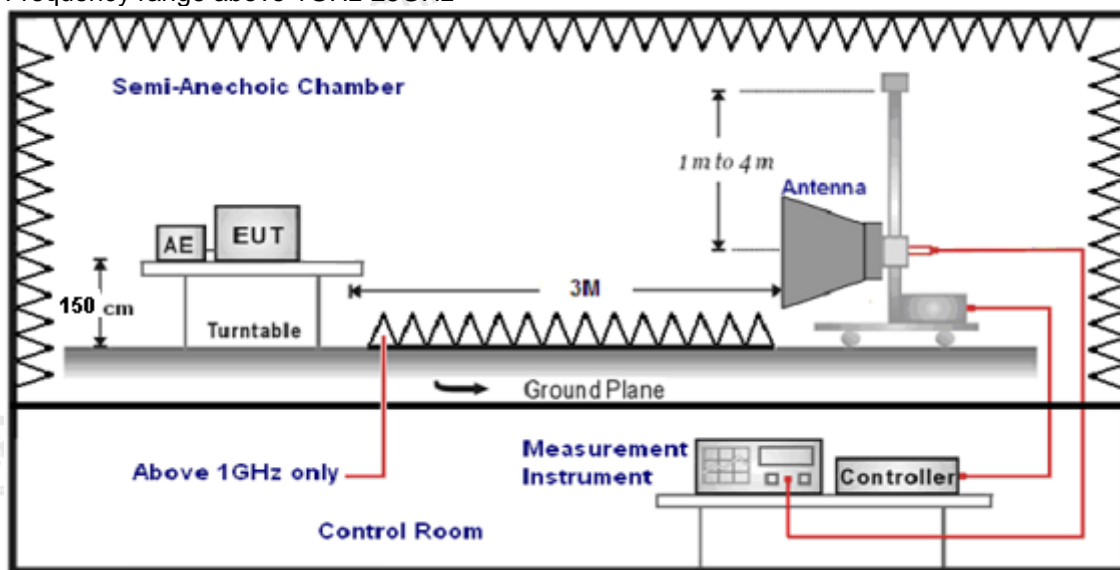

TEST PROCEDURE

1. The EUT was placed on a turn table which is 0.8m above ground plane when testing frequency range 9 KHz –1GHz;the EUT was placed on a turn table which is 1.5m above ground plane when testing frequency range 1GHz – 25GHz.
2. Maximum procedure was performed by raising the receiving antenna from 1m to 4m and rotating the turn table from 0° to 360° to acquire the highest emissions from EUT.
3. And also, each emission was to be maximized by changing the polarization of receiving antenna both horizontal and vertical.
4. Repeat above procedures until all frequency measurements have been completed.
5. Radiated emission test frequency band from 9KHz to 25GHz.
6. The distance between test antenna and EUT as following table states:

Test Frequency range	Test Antenna Type	Test Distance
9KHz-30MHz	Active Loop Antenna	3
30MHz-1GHz	Ultra-Broadband Antenna	3
1GHz-18GHz	Double Ridged Horn Antenna	3
18GHz-25GHz	Horn Antenna	1

7. Setting test receiver/spectrum as following table states:

Test Frequency range	Test Receiver/Spectrum Setting	Detector
9KHz-150KHz	RBW=200Hz/VBW=3KHz, Sweep time=Auto	QP
150KHz-30MHz	RBW=9KHz/VBW=100KHz, Sweep time=Auto	QP
30MHz-1GHz	RBW=120KHz/VBW=1000KHz, Sweep time=Auto	QP
1GHz-40GHz	Peak Value: RBW=1MHz/VBW=3MHz, Sweep time=Auto Average Value: RBW=1MHz/VBW=10Hz, Sweep time=Auto	Peak

Field Strength Calculation

The field strength is calculated by adding the Antenna Factor and Cable Factor and subtracting the Amplifier Gain and Duty Cycle Correction Factor(if any) from the measured reading. The basic equation with a sample calculation is as follows:

$$FS = RA + AF + CL - AG$$

Where FS = Field Strength	CL = Cable Attenuation Factor (Cable Loss)
RA = Reading Amplitude	AG = Amplifier Gain
AF = Antenna Factor	

$$Transd=AF +CL-AG$$

RADIATION LIMIT

For intentional device, according to § 15.209(a), the general requirement of field strength of radiated emission from intentional radiators at a distance of 3 meters shall not exceed the following table. According to § 15.247(d), in any 100kHz bandwidth outside the frequency band in which the EUT is operating, the radio frequency power that is produced by the intentional radiator shall be at least 20dB below that in the100kHz bandwidth within the band that contains the highest level of desired power.

The pre-test have done for the EUT in three axes and found the worst emission at position shown in test setup photos.

Frequency (MHz)	Distance (Meters)	Radiated (dBµV/m)	Radiated (µV/m)
0.009-0.49	3	20log(2400/F(KHz))+40log(300/3)	2400/F(KHz)
0.49-1.705	3	20log(24000/F(KHz))+ 40log(30/3)	24000/F(KHz)
1.705-30	3	20log(30)+ 40log(30/3)	30
30-88	3	40.0	100
88-216	3	43.5	150
216-960	3	46.0	200
Above 960	3	54.0	500

TEST RESULTS

Remark:

1. This test was performed with EUT in X, Y, Z position and the worse case was found when EUT in X position.
2. We measured Radiated Emission at GFSK, π/4 DQPSK and 8DPSK mode from 9 KHz to 25GHz and recorded worst case at GFSK DH5 mode.
3. For below 1GHz testing recorded worst at GFSK DH5 middle channel.
4. Radiated emission test from 9 KHz to 10th harmonic of fundamental was verified, and no emission found except system noise floor in 9 KHz to 30MHz and not recorded in this report.

For 30MHz-1GHz

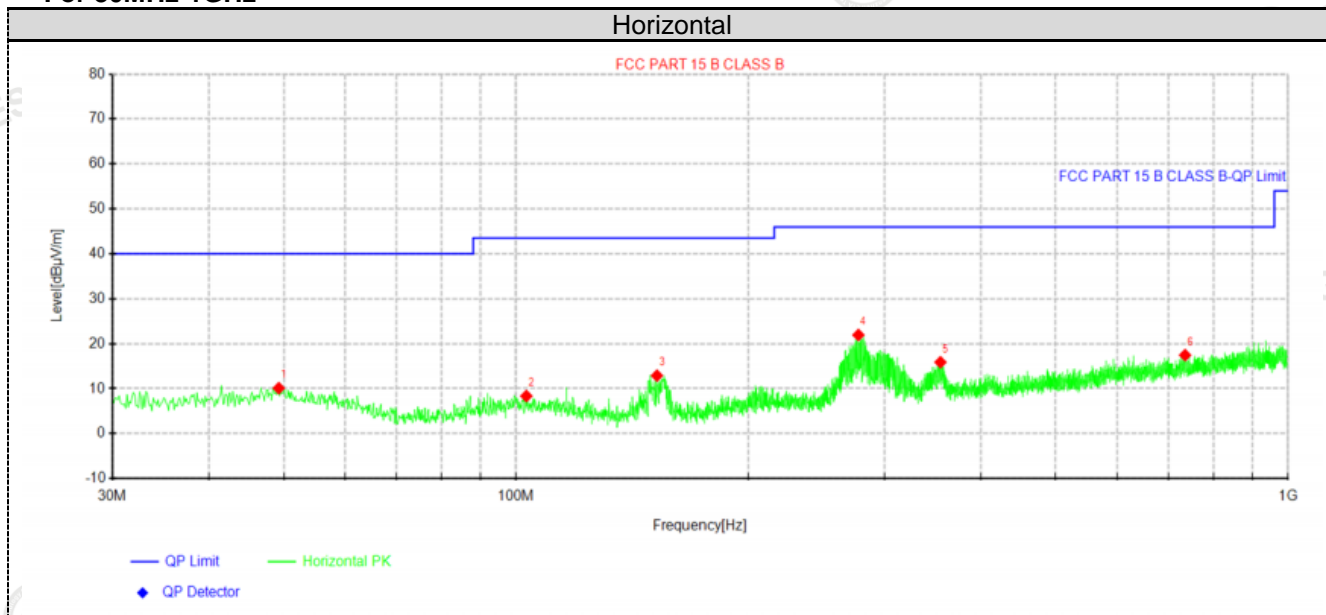

Suspected Data List									
NO.	Freq. [MHz]	Reading [dBµV]	Level [dBµV/m]	Factor [dB/m]	Limit [dBµV/m]	Margin [dB]	Height [cm]	Angle [°]	Polarity
1	49.2788	26.22	10.10	-16.12	40.00	29.90	100	40	Horizontal
2	103.113	26.87	8.36	-18.51	43.50	35.14	100	30	Horizontal
3	152.22	34.62	12.89	-21.73	43.50	30.61	100	30	Horizontal
4	277.592	39.64	21.94	-17.70	46.00	24.06	100	260	Horizontal
5	354.586	31.87	15.87	-16.00	46.00	30.13	100	240	Horizontal
6	735.553	28.48	17.45	-11.03	46.00	28.55	100	70	Horizontal

Note:1). Level (dBµV/m)= Reading (dBµV)+ Factor (dB/m)

2). Factor(dB/m)=Antenna Factor (dB/m) + Cable loss (dB) - Pre Amplifier gain (dB)

3). Margin(dB) = Limit (dBµV/m) - Level (dBµV/m)

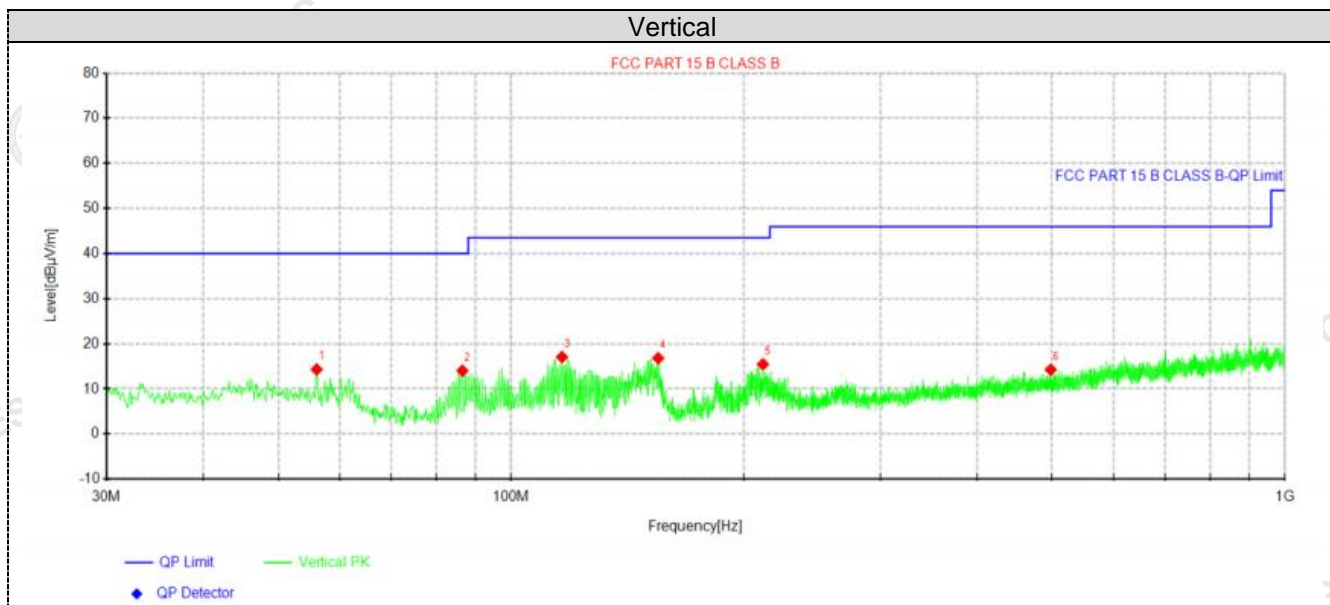

Suspected Data List									
NO.	Freq. [MHz]	Reading [dBµV]	Level [dBµV/m]	Factor [dB/m]	Limit [dBµV/m]	Margin [dB]	Height [cm]	Angle [°]	Polarity
1	56.0688	31.67	14.31	-17.36	40.00	25.69	100	230	Vertical
2	86.5025	34.45	14.03	-20.42	40.00	25.97	100	300	Vertical
3	116.33	36.82	17.06	-19.76	43.50	26.44	100	200	Vertical
4	154.887	38.49	16.80	-21.69	43.50	26.70	100	90	Vertical
5	211.511	34.51	15.45	-19.06	43.50	28.05	100	280	Vertical
6	498.146	28.59	14.26	-14.33	46.00	31.74	100	170	Vertical

Note:1). Level (dBµV/m) = Reading (dBµV) + Factor (dB/m)
 2). Factor (dB/m) = Antenna Factor (dB/m) + Cable loss (dB) - Pre Amplifier gain (dB)
 3). Margin (dB) = Limit (dBµV/m) - Level (dBµV/m)

For 1GHz to 25GHz

Note: GFSK , $\pi/4$ DQPSK and 8DPSK all have been tested, only worse case GFSK is reported.

GFSK (above 1GHz)

Frequency(MHz):			2402		Polarity:		HORIZONTAL		
Frequency (MHz)	Emission Level (dBuV/m)		Limit (dBuV/m)	Margin (dB)	Raw Value (dBuV)	Antenna Factor (dB/m)	Cable Factor (dB)	Pre-amplifier (dB)	Correction Factor (dB/m)
4804.00	60.87	PK	74	13.13	65.14	32.33	5.12	41.72	-4.27
4804.00	45.52	AV	54	8.48	49.79	32.33	5.12	41.72	-4.27
7206.00	53.50	PK	74	20.50	54.02	36.6	6.49	43.61	-0.52
7206.00	42.85	AV	54	11.15	43.37	36.6	6.49	43.61	-0.52

Frequency(MHz):			2402		Polarity:		VERTICAL		
Frequency (MHz)	Emission Level (dBuV/m)		Limit (dBuV/m)	Margin (dB)	Raw Value (dBuV)	Antenna Factor (dB/m)	Cable Factor (dB)	Pre-amplifier (dB)	Correction Factor (dB/m)
4804.00	58.82	PK	74	15.18	63.09	32.33	5.12	41.72	-4.27
4804.00	42.05	AV	54	11.95	46.32	32.33	5.12	41.72	-4.27
7206.00	52.54	PK	74	21.46	53.06	36.6	6.49	43.61	-0.52
7206.00	41.49	AV	54	12.51	42.01	36.6	6.49	43.61	-0.52

Frequency(MHz):			2441		Polarity:		HORIZONTAL		
Frequency (MHz)	Emission Level (dBuV/m)		Limit (dBuV/m)	Margin (dB)	Raw Value (dBuV)	Antenna Factor (dB/m)	Cable Factor (dB)	Pre-amplifier (dB)	Correction Factor (dB/m)
4882.00	61.38	PK	74	12.62	65.26	32.6	5.34	41.82	-3.88
4882.00	45.78	AV	54	8.22	49.66	32.6	5.34	41.82	-3.88
7323.00	54.57	PK	74	19.43	54.68	36.8	6.81	43.72	-0.11
7323.00	43.39	AV	54	10.61	43.50	36.8	6.81	43.72	-0.11

Frequency(MHz):			2441		Polarity:		VERTICAL		
Frequency (MHz)	Emission Level (dBuV/m)		Limit (dBuV/m)	Margin (dB)	Raw Value (dBuV)	Antenna Factor (dB/m)	Cable Factor (dB)	Pre-amplifier (dB)	Correction Factor (dB/m)
4882.00	59.62	PK	74	14.38	63.50	32.6	5.34	41.82	-3.88
4882.00	42.79	AV	54	11.21	46.67	32.6	5.34	41.82	-3.88
7323.00	52.26	PK	74	21.74	52.37	36.8	6.81	43.72	-0.11
7323.00	39.35	AV	54	14.65	39.46	36.8	6.81	43.72	-0.11

Frequency(MHz):			2480		Polarity:		HORIZONTAL		
Frequency (MHz)	Emission Level (dBuV/m)		Limit (dBuV/m)	Margin (dB)	Raw Value (dBuV)	Antenna Factor (dB/m)	Cable Factor (dB)	Pre-amplifier (dB)	Correction Factor (dB/m)
4960.00	60.84	PK	74	13.16	63.92	32.73	5.66	41.47	-3.08
4960.00	44.74	AV	54	9.26	47.82	32.73	5.66	41.47	-3.08
7440.00	55.20	PK	74	18.80	54.75	37.04	7.25	43.84	0.45
7440.00	43.83	PK	54	10.17	43.38	37.04	7.25	43.84	0.45

Frequency(MHz):			2480		Polarity:		VERTICAL		
Frequency (MHz)	Emission Level (dBuV/m)		Limit (dBuV/m)	Margin (dB)	Raw Value (dBuV)	Antenna Factor (dB/m)	Cable Factor (dB)	Pre-amplifier (dB)	Correction Factor (dB/m)
4960.00	58.03	PK	74	15.97	61.11	32.73	5.66	41.47	-3.08
4960.00	43.30	AV	54	10.70	46.38	32.73	5.66	41.47	-3.08
7440.00	53.32	PK	74	20.68	52.87	37.04	7.25	43.84	0.45
7440.00	41.07	PK	54	12.93	40.62	37.04	7.25	43.84	0.45

REMARKS:

Shenzhen CTA Testing Technology Co., Ltd.

Room 106, Building 1, Yibaolai Industrial Park, Qiaotou Community, Fuhai Street, Bao'an District, Shenzhen, China

Tel:+86-755 2322 5875 E-mail:cta@cta-test.cn Web:http://www.cta-test.cn

1. Emission level (dBuV/m) =Raw Value (dBuV)+Correction Factor (dB/m)
2. Correction Factor (dB/m) = Antenna Factor (dB/m)+Cable Factor (dB)- Pre-amplifier
3. Margin value = Limit value- Emission level.
4. -- Mean the PK detector measured value is below average limit.
5. The other emission levels were very low against the limit.

Results of Band Edges Test (Radiated)

Note: GFSK, Pi/4 DQPSK and 8DPSK all have been tested, only worse case GFSK is reported.

GFSK

Frequency(MHz):			2402		Polarity:		HORIZONTAL		
Frequency (MHz)	Emission Level (dBuV/m)		Limit (dBuV/m)	Margin (dB)	Raw Value (dBuV)	Antenna Factor (dB/m)	Cable Factor (dB)	Pre-amplifier (dB)	Correction Factor (dB/m)
2390.00	60.46	PK	74	13.54	70.88	27.42	4.31	42.15	-10.42
2390.00	45.05	AV	54	8.95	55.47	27.42	4.31	42.15	-10.42
Frequency(MHz):			2402		Polarity:		VERTICAL		
Frequency (MHz)	Emission Level (dBuV/m)		Limit (dBuV/m)	Margin (dB)	Raw Value (dBuV)	Antenna Factor (dB/m)	Cable Factor (dB)	Pre-amplifier (dB)	Correction Factor (dB/m)
2390.00	59.48	PK	74	14.52	69.90	27.42	4.31	42.15	-10.42
2390.00	41.74	AV	54	12.26	52.16	27.42	4.31	42.15	-10.42
Frequency(MHz):			2480		Polarity:		HORIZONTAL		
Frequency (MHz)	Emission Level (dBuV/m)		Limit (dBuV/m)	Margin (dB)	Raw Value (dBuV)	Antenna Factor (dB/m)	Cable Factor (dB)	Pre-amplifier (dB)	Correction Factor (dB/m)
2483.50	60.41	PK	74	13.59	70.52	27.7	4.47	42.28	-10.11
2483.50	42.21	AV	54	11.79	52.32	27.7	4.47	42.28	-10.11
Frequency(MHz):			2480		Polarity:		VERTICAL		
Frequency (MHz)	Emission Level (dBuV/m)		Limit (dBuV/m)	Margin (dB)	Raw Value (dBuV)	Antenna Factor (dB/m)	Cable Factor (dB)	Pre-amplifier (dB)	Correction Factor (dB/m)
2483.50	59.80	PK	74	14.20	69.91	27.7	4.47	42.28	-10.11
2483.50	41.05	AV	54	12.95	51.16	27.7	4.47	42.28	-10.11

REMARKS:

1. Emission level (dBuV/m) =Raw Value (dBuV)+Correction Factor (dB/m)
2. Correction Factor (dB/m) = Antenna Factor (dB/m)+Cable Factor (dB)- Pre-amplifier
3. Margin value = Limit value- Emission level.
4. -- Mean the PK detector measured value is below average limit.
5. The other emission levels were very low against the limit.

4.3 Maximum Peak Output Power

Limit

The Maximum Peak Output Power Measurement is 125mW (20.97).

Test Procedure

Remove the antenna from the EUT and then connect a low loss RF cable from the antenna port to the powersensor.

Test Configuration



Test Results

Type	Channel	Output power (dBm)	Limit (dBm)	Result
GFSK	00	0.04	20.97	Pass
	39	0.63		
	78	1.28		
π/4DQPSK	00	1.12	20.97	Pass
	39	1.51		
	78	2.14		
8DPSK	00	0.93	20.97	Pass
	39	1.51		
	78	2.13		

Note: 1.The test results including the cable lose.

4.4 20dB Bandwidth

Limit

For frequency hopping systems operating in the 2400MHz-2483.5MHz no limit for 20dB bandwidth.

Test Procedure

The transmitter output was connected to the spectrum analyzer through an attenuator. The bandwidth of the fundamental frequency was measured by spectrum analyzer with 30 KHz RBW and 100 KHz VBW.

The 20dB bandwidth is defined as the total spectrum the power of which is higher than peak power minus 20dB.

Test Configuration

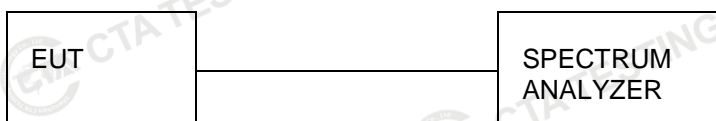

Test Results

Modulation	Channel	20dB bandwidth (MHz)	Result
GFSK	CH00	0.954	Pass
	CH39	1.017	
	CH78	0.981	
π/4DQPSK	CH00	1.284	
	CH39	1.323	
	CH78	1.302	
8DPSK	CH00	1.323	
	CH39	1.284	
	CH78	1.362	

Test plot as follows:

GFSK Modulation

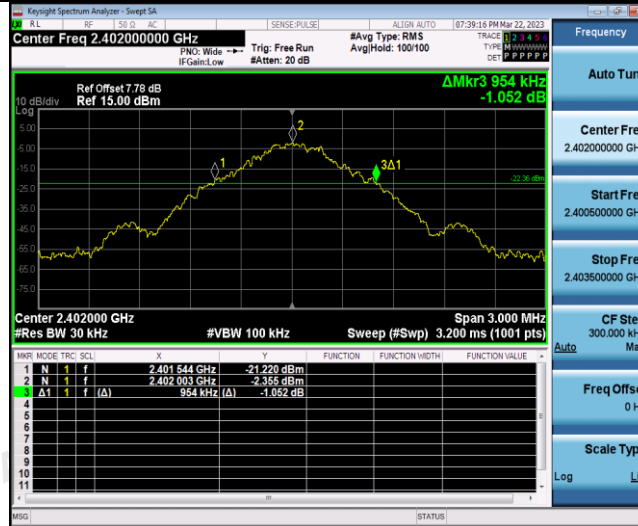

CH00



CH39



CH78

$\pi/4$ DQPSK Modulation

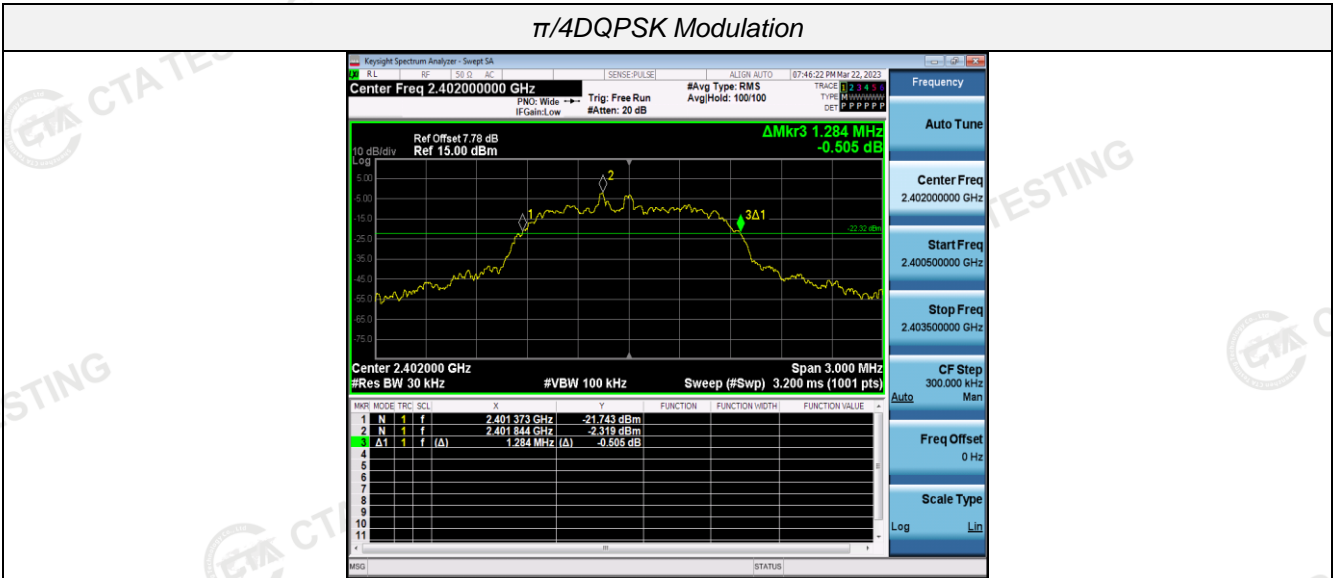

CH00



CH39



CH78

8DPSK Modulation



CH00



CH39



CH78

4.5 Frequency Separation

LIMIT

According to 15.247(a)(1), frequency hopping systems shall have hopping channel carrier frequencies separated by minimum of 25KHz or the $2/3 \times 20\text{dB}$ bandwidth of the hopping channel, whichever is greater.

TEST PROCEDURE

The transmitter output was connected to the spectrum analyzer through an attenuator. The bandwidth of the fundamental frequency was measured by spectrum analyzer with 100 KHz RBW and 300 KHz VBW.

TEST CONFIGURATION



TEST RESULTS

Modulation	Channel	Channel Separation (MHz)	Limit(MHz)	Result
GFSK	CH38	1.004	25KHz or $2/3 \times 20\text{dB}$ bandwidth	Pass
	CH39			
$\pi/4\text{DQPSK}$	CH38	1.280	25KHz or $2/3 \times 20\text{dB}$ bandwidth	Pass
	CH39			
8DPSK	CH38	1.140	25KHz or $2/3 \times 20\text{dB}$ bandwidth	Pass
	CH39			

Note:

We have tested all mode at high, middle and low channel, and recorded worst case at middle

Test plot as follows:

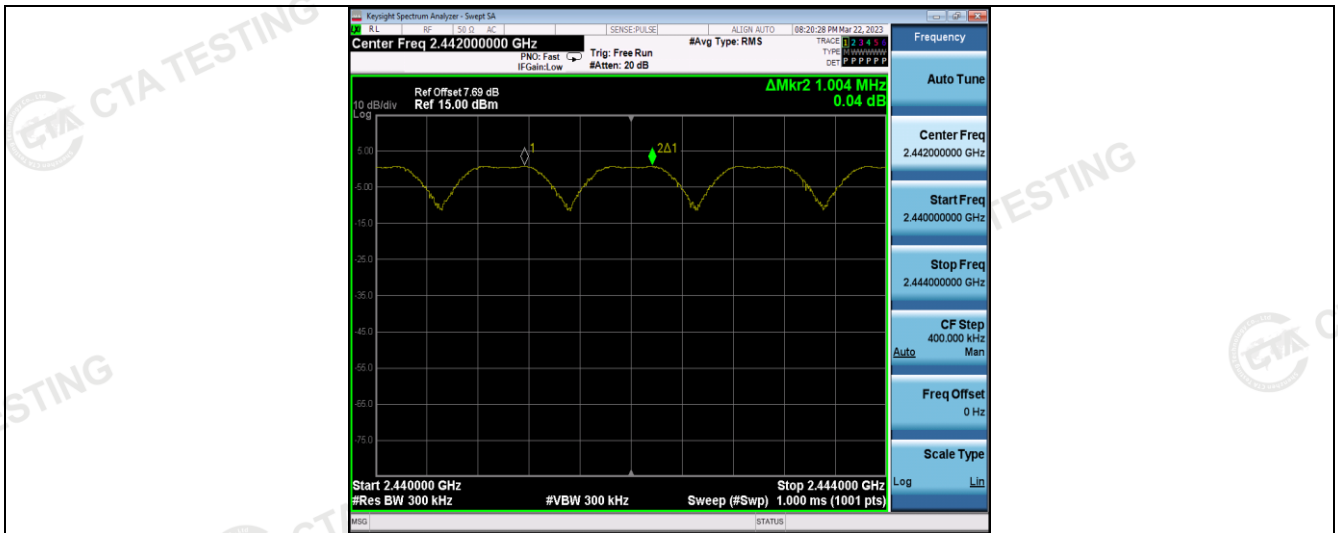

GFSK

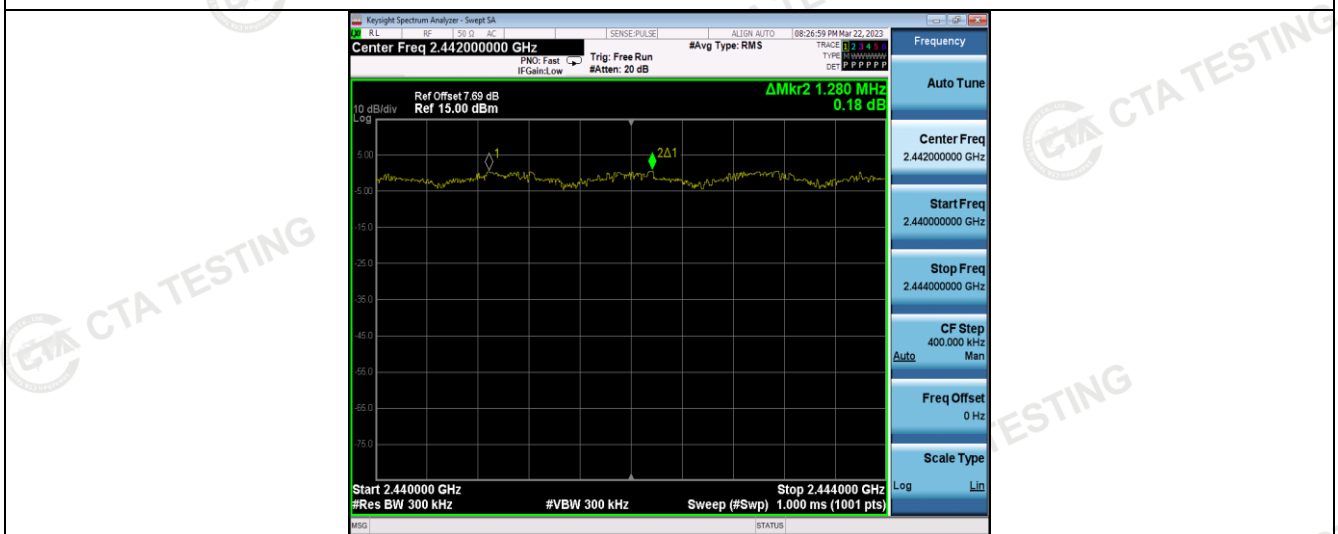

$\pi/4$ DQPSK

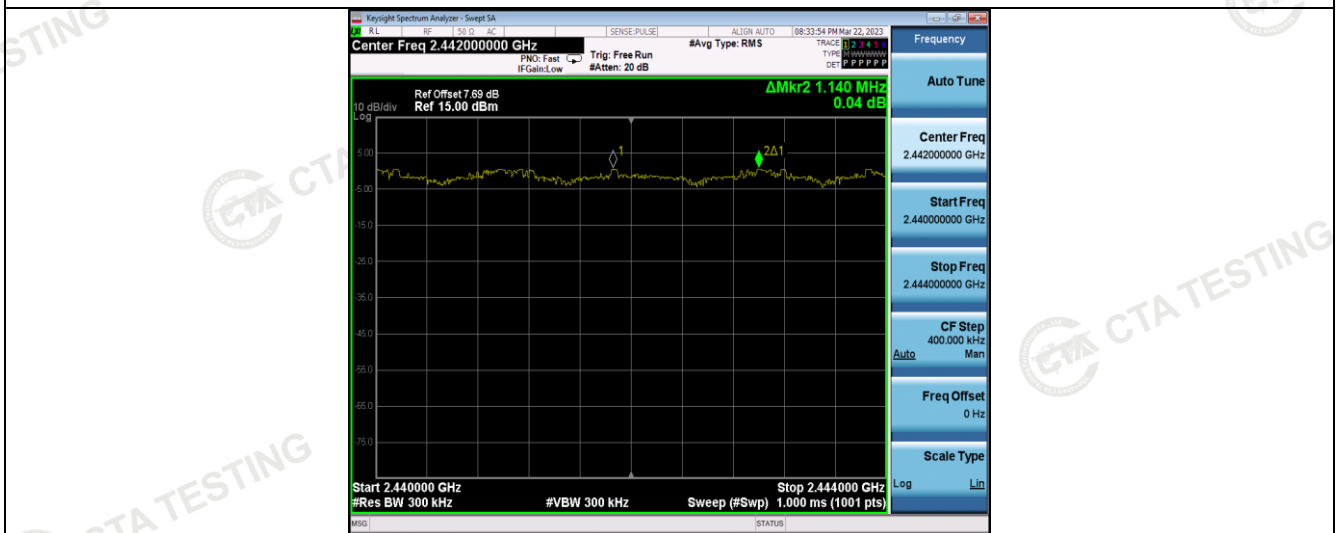

8DPSK

4.6 Number of hopping frequency

Limit

Frequency hopping systems in the 2400–2483.5 MHz band shall use at least 15 channels.

Test Procedure

The transmitter output was connected to the spectrum analyzer through an attenuator. Set spectrum analyzer start 2400MHz to 2483.5MHz with 100 KHz RBW and 300 KHz VBW.

Test Configuration



Test Results

Modulation	Number of Hopping Channel	Limit	Result
GFSK	79	≥15	Pass
$\pi/4$ DQPSK	79		
8DPSK	79		

Test plot as follows:

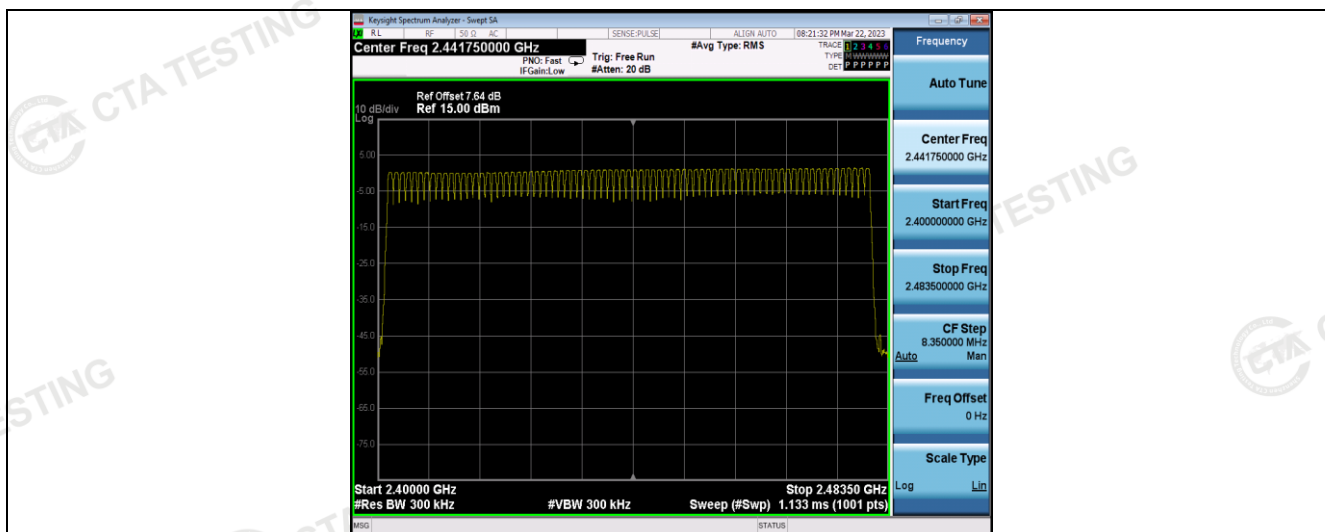

GFSK Modulation

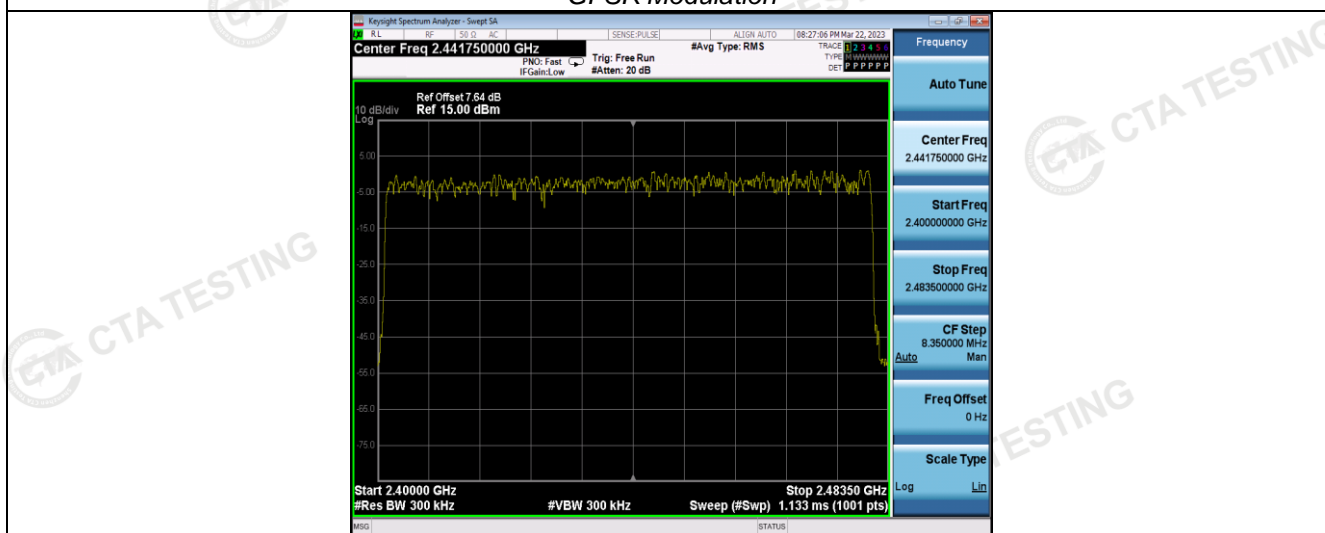

$\pi/4$ DQPSK Modulation

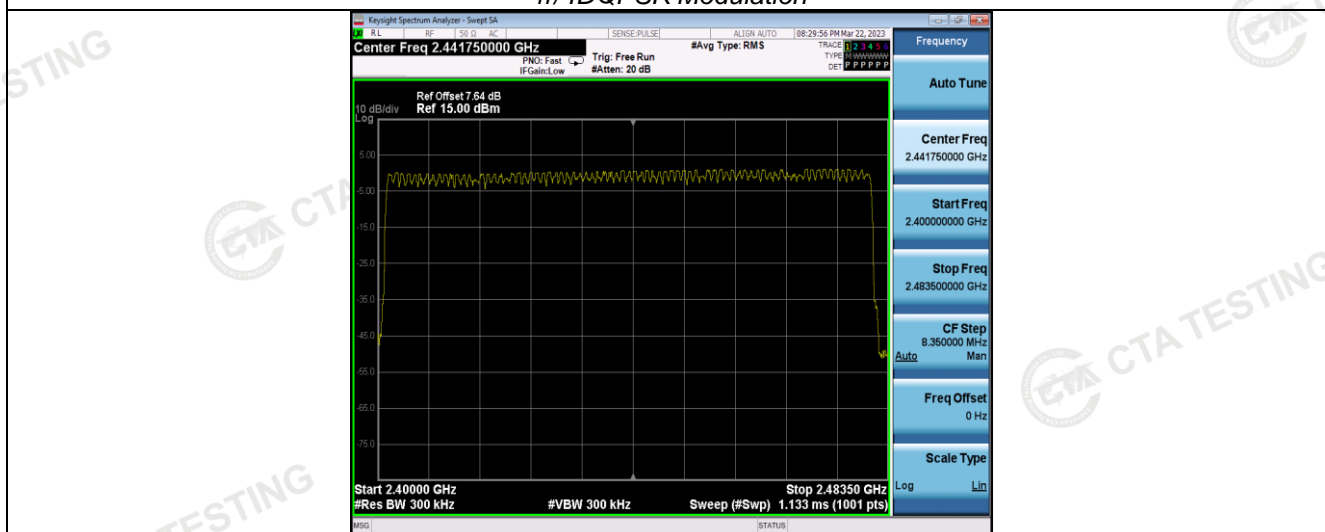

8DPSK Modulation

4.7 Time of Occupancy (Dwell Time)

Limit

The average time of occupancy on any channel shall not be greater than 0.4 seconds within a period of 0.4 seconds multiplied by the number of hopping channels employed.

Test Procedure

The transmitter output was connected to the spectrum analyzer through an attenuator. Set center frequency of spectrum analyzer=operating frequency with 1MHz RBW and 1MHz VBW, Span 0Hz.

Test Configuration



Test Results

Modulation	Packet	Burst time (ms)	Dwell time (s)	Limit (s)	Result
GFSK	DH1	0.36	0.115	0.40	Pass
	DH3	1.62	0.259		
	DH5	2.86	0.305		
π/4DQPSK	2-DH1	0.37	0.118	0.40	Pass
	2-DH3	1.62	0.259		
	2-DH5	2.86	0.305		
8DPSK	3-DH1	0.36	0.115	0.40	Pass
	3-DH3	1.62	0.259		
	3-DH5	2.87	0.306		

Note: We have tested all mode at high, middle and low channel, and recorded worst case at middle channel.

Dwell time = Pulse time (ms) × (1600 ÷ 2 ÷ 79) × 31.6 Second for DH1, 2-DH1, 3-DH1

Dwell time = Pulse time (ms) × (1600 ÷ 4 ÷ 79) × 31.6 Second for DH3, 2-DH3, 3-DH3

Dwell time = Pulse time (ms) × (1600 ÷ 6 ÷ 79) × 31.6 Second for DH5, 2-DH5, 3-DH5

Test plot as follows:

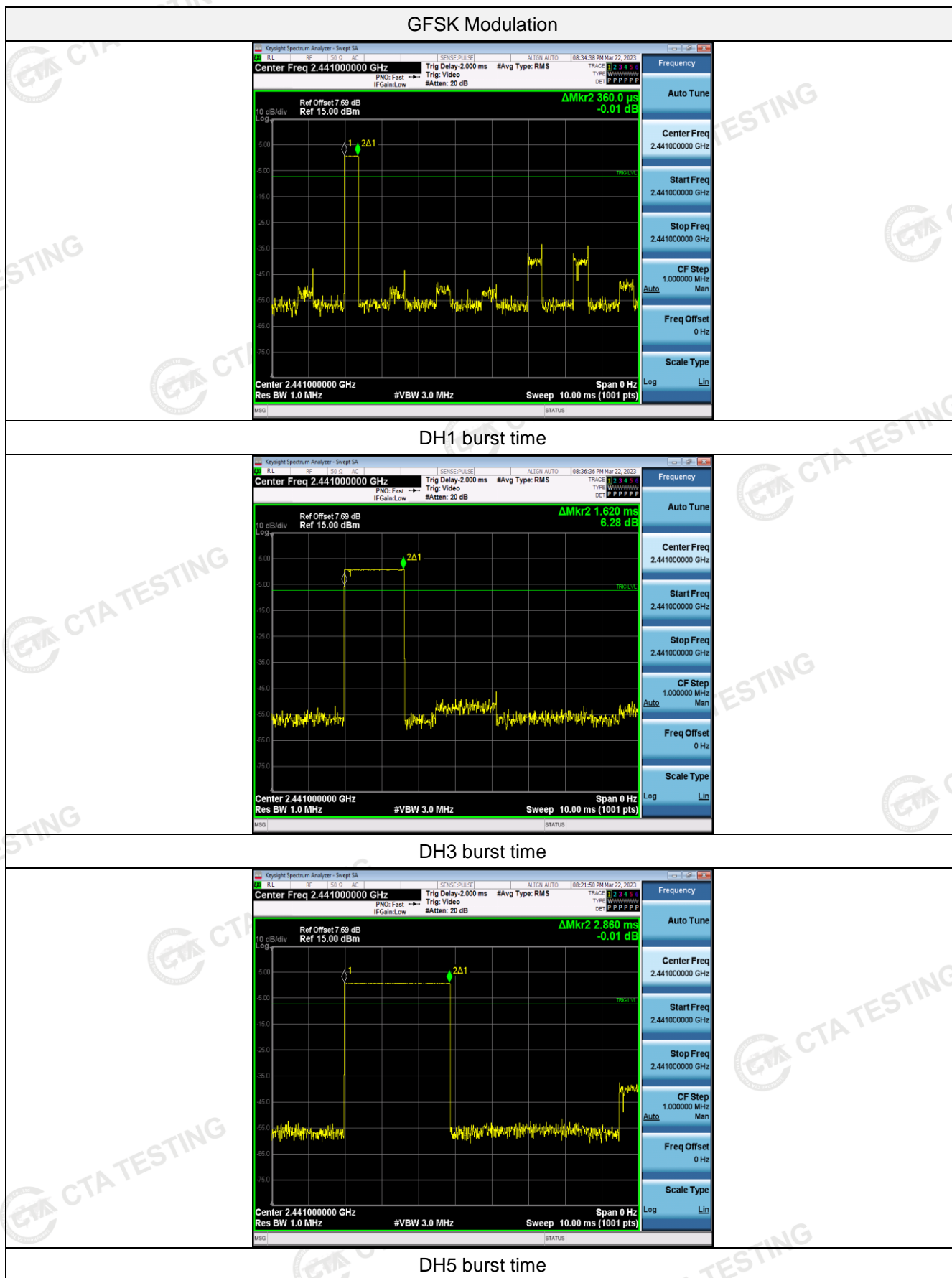

$\pi/4$ DQPSK Modulation



2-DH1 burst time

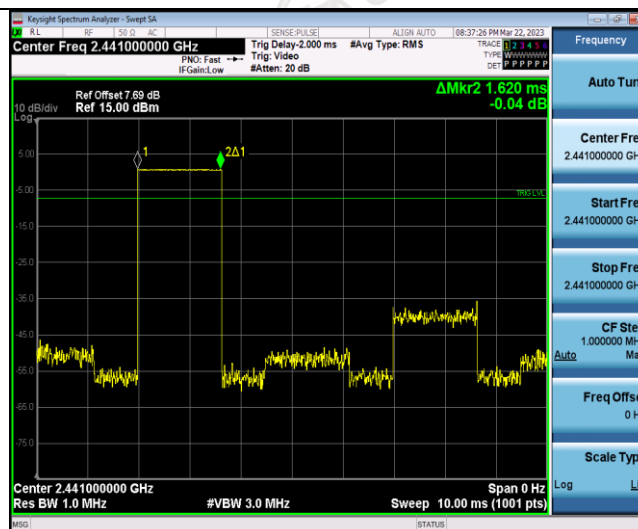

2-DH3 burst time

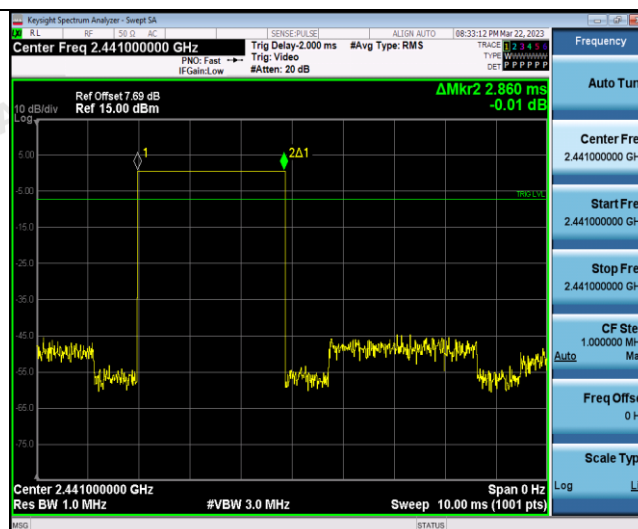

2-DH5 burst time

8DPSK Modulation

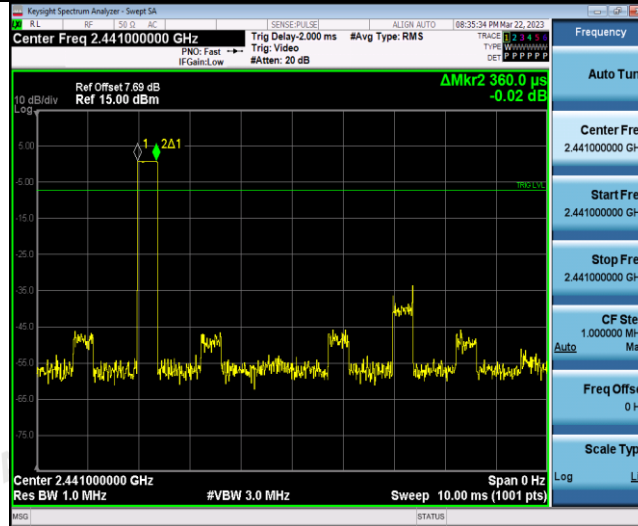

3-DH1 burst time



3-DH3 burst time

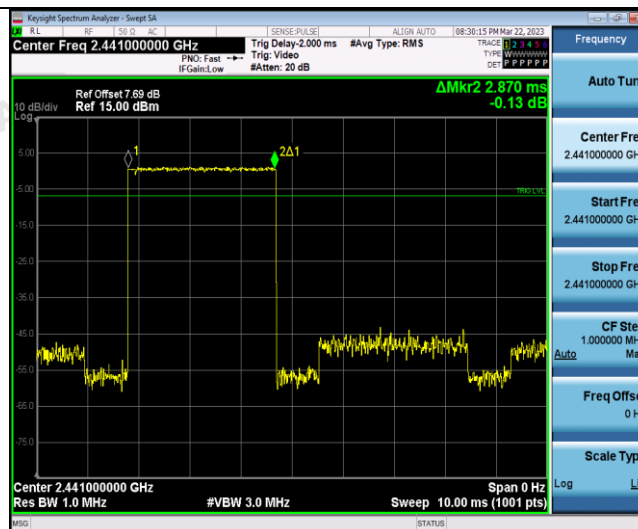

3-DH5 burst time

4.8 Out-of-band Emissions

Limit

In any 100 kHz bandwidth outside the frequency band in which the spread spectrum or digitally modulated intentional radiator is operating, the radio frequency power that is produced by the intentional radiator shall be at least 20 dB below that in the 100 kHz bandwidth within the band that contains the highest level of the desired power, based on either an RF conducted or a radiated measurement, provided the transmitter demonstrates compliance with the peak conducted power limits. If the transmitter complies with the conducted power limits based on the use of RMS averaging over a time interval, as permitted under paragraph (b)(3) of this section, the attenuation required under this paragraph shall be 30 dB instead of 20 dB. Attenuation below the general limits specified in §15.209(a) is not required.

Test Procedure

Connect the transmitter output to spectrum analyzer using a low loss RF cable, and set the spectrum analyzer to RBW=100 kHz, VBW= 300 kHz, peak detector, and max hold. Measurements utilizing these settings are made of the in-band reference level, bandedge and out-of-band emissions.

Test Configuration

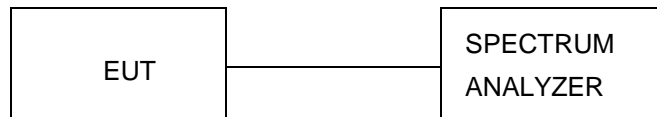

Test Results

Remark: The measurement frequency range is from 30MHz to the 10th harmonic of the fundamental frequency. The lowest, middle and highest channels are tested to verify the spurious emissions and bandedge measurement data.

We measured all conditions (DH1, DH3, DH5) and recorded worst case at DH5

Test plot as follows:

