

TEST REPORT

Product Name : Mobile ePaper, Mobile E ink, Mobile Color ePaper, Mobile Color E ink, Mobile eReader

Brand Name : BOOX

Model : Palma 2

Series Model : BOOX Palma 2 Plus, BOOX Palma 2 Pro, BOOX Palma 2 Lite, BOOX Palma 2 C, BOOX Palma 2 C Plus, BOOX Palma 2 C Pro, BOOX Palma 2 Color, BOOX Palma 2 Color Plus, BOOX Palma 2 Color Pro

FCC ID : XR3-PALMA2

Applicant : **ONYX INTERNATIONAL INC.**

Address : Room 101, Building 4, No. 202 Shiyu Road, Nansha District, Guangzhou City, Guangdong Province, China

Manufacturer : **ONYX INTERNATIONAL INC.**

Address : Room 101, Building 4, No. 202 Shiyu Road, Nansha District, Guangzhou City, Guangdong Province, China

Standard(s) : FCC CFR Title 47 Part 15 Subpart E Section 15.407

Date of Receipt : Sep. 12, 2024

Date of Test : Sep. 13, 2024 ~ Oct. 10, 2024

Issued Date : Oct. 10, 2024

Issued By: **Guangdong Asia Hongke Test Technology Limited**
B1/F, Building 11, Junfeng Industrial Park, Chongqing Road, Heping Community, Fuhai Street,
Bao'an District, Shenzhen, Guangdong, China
Tel.: +86 0755-230967639 Fax.: +86 0755-230967639

Reviewed by: Leon Yi
Leon.yi

Approved by: Sean She
Sean She



Note: This device has been tested and found to comply with the standard(s) listed, this test report merely corresponds to the test sample. It is not permitted to copy extracts of these test result without the written permission of the test laboratory. This report shall not be reproduced except in full, without the written approval of Guangdong Asia Hongke Test Technology Limited. If there is a need to alter or revise this document, the right belongs to Guangdong Asia Hongke Test Technology Limited, and it should give a prior written notice of the revision document. This test report must not be used by the client to claim product endorsement.

Guangdong Asia Hongke Test Technology Limited

B1/F, Building 11, Junfeng Industrial Park, Chongqing Road, Heping Community, Fuhai Street, Bao'an District, Shenzhen, Guangdong, China.



Report Revise Record

Report Version	Issued Date	Notes
M1	Oct. 10, 2024	Initial Release

Contents

1	TEST SUMMARY.....	4
1.1	TEST STANDARDS	4
1.2	TEST SUMMARY	4
1.3	TEST FACILITY	5
1.4	MEASUREMENT UNCERTAINTY	5
2	GENGENERAL INFORMATION	6
2.1	ENVIRONMENTAL CONDITIONS	6
2.2	GENERAL DESCRIPTION OF EUT	6
2.3	DESCRIPTION OF TEST MODES AND TEST FREQUENCY.....	7
2.4	SPECIAL ACCESSORIES	7
2.5	EQUIPMENT LIST FOR THE TEST	8
3	TEST CONDITIONS AND RESULTS	9
3.1	CONDUCTED EMISSIONS TEST	9
3.2	RADIATED EMISSIONS AND BAND EDGE	12
3.3	MAXIMUM CONDUCTED AVERAGE OUTPUT POWER	23
3.4	POWER SPECTRAL DENSITY	25
3.5	EMISSION BANDWIDTH (26DBM BANDWIDTH).....	27
3.6	MINIMUM EMISSION BANDWIDTH (6DBM BANDWIDTH)	28
3.7	FREQUENCY STABILITY	29
3.8	ANTENNA REQUIREMENT.....	30
4	TEST SETUP PHOTOGRAPHS OF EUT	31
5	EXTERNAL PHOTOGRAPHS OF EUT	31
6	INTERNAL PHOTOGRAPHS OF EUT	31

1 TEST SUMMARY

1.1 Test Standards

The tests were performed according to following standards:

[FCC Rules Part 15 Subpart E](#)—Unlicensed National Information Infrastructure Devices.

[ANSI C63.10: 2013](#): American National Standard for Testing Unlicensed Wireless Devices

[KDB 662911 D01 Multiple Transmitter Output v02r01](#) is required to be used for this kind of FCC 15.407 Ull device.

1.2 Test Summary

FCC Requirement		
FCC Part 15.207	AC Power Conducted Emission	PASS
FCC Part 15.407(a)	Emission Bandwidth(26dB Bandwidth)	PASS ^{Note1}
FCC Part 15.407(e)	Minimum Emission Bandwidth(6dB Bandwidth)	PASS ^{Note2}
FCC Part 15.407(a)	Maximum Conducted Output Power	PASS
FCC Part 15.407(a)	Peak Power Spectral Density	PASS
FCC Part 15.407(g)	Frequency Stability	PASS
FCC Part 15.407(b)	Undesirable emission	PASS
FCC Part 15.407(b)/15.205/15.209	Radiated Emissions	PASS
FCC Part 15.203	Antenna Requirement	PASS

Note 1: Apply to Band1, Band2A, Band2C only.

Note 2: Apply to band3 only.

1.3 Test Facility

Test Laboratory:

Guangdong Asia Hongke Test Technology Limited

B1/F, Building 11, Junfeng Industrial Park, Chongqing Road, Heping Community, Fuhai Street, Bao'an District, Shenzhen, Guangdong, China

The test facility is recognized, certified or accredited by the following organizations:

FCC-Registration No.: 251906 Designation Number: CN1376

Guangdong Asia Hongke Test Technology Limited has been registered and fully described in a report filed with the (FCC) Federal Communications Commission. The acceptance letter from the FCC is maintained in our files.

IC —Registration No.: 31737 CAB identifier: CN0165

The 3m Semi-anechoic chamber of Guangdong Asia Hongke Test Technology Limited has been registered by Certification and Engineering Bureau of Industry Canada for radio equipment testing with Registration No.: 31737

A2LA-Lab Cert. No.: 7133.01

Guangdong Asia Hongke Test Technology Limited has been accredited by A2LA for technical competence in the field of electrical testing, and proved to be in compliance with ISO/IEC 17025: 2017 General Requirements for the Competence of Testing and Calibration Laboratories and any additional program requirements in the identified field of testing.

1.4 Measurement uncertainty

The data and results referenced in this document are true and accurate. The reader is cautioned that there may be errors within the calibration limits of the equipment and facilities. The measurement uncertainty was calculated for all measurements listed in this test report according to CISPR 16 - 4 “Specification for radio disturbance and immunity measuring apparatus and methods – Part 4: Uncertainty in EMC Measurements” and is documented in the Guangdong Asia Hongke Test Technology Limited’s quality system according to DIN EN ISO/IEC 17025. Furthermore, component and process variability of devices similar to that tested may result in additional deviation. The manufacturer has the sole responsibility of continued compliance of the device.

Hereafter the best measurement capability for Asia Hongke laboratory is reported:

Test	Measurement Uncertainty	Notes
Power Line Conducted Emission	150KHz~30MHz ±1.20 dB	(1)
Radiated Emission	9KHz~30Hz ±3.10dB	(1)
Radiated Emission	9KHz~1GHz ±3.75dB	(1)
Radiated Emission	1GHz~18GHz ±3.88 dB	(1)
Radiated Emission	18GHz~40GHz ±3.88dB	(1)
RF power, conducted	30MHz~6GHz ±0.16dB	(1)
RF power density, conducted	±0.24dB	(1)
Spurious emissions, conducted	±0.21dB	(1)
Temperature	±1°C	(1)
Humidity	±3%	(1)
DC and low frequency voltages	±1.5%	(1)
Time	±2%	(1)
Duty cycle	±2%	(1)

The report uncertainty of measurement $y \pm U$, where expanded uncertainty U is based on a standard uncertainty Multiplied by a coverage factor of $k=2$, providing a level of confidence of approximately 95%

2 GENGGENERAL INFORMATION

2.1 Environmental conditions

During the measurement the environmental conditions were within the listed ranges:

Normal Temperature:	25°C
Relative Humidity:	55 %
Air Pressure:	101 kPa

2.2 General Description of EUT

Product Name:	Mobile ePaper, Mobile E ink, Mobile Color ePaper, Mobile Color E ink, Mobile eReader			
Model/Type reference:	Palma 2			
Serial Model:	BOOX Palma 2 Plus, BOOX Palma 2 Pro, BOOX Palma 2 Lite, BOOX Palma 2 C, BOOX Palma 2 C Plus, BOOX Palma 2 C Pro, BOOX Palma 2 Color, BOOX Palma 2 Color Plus, BOOX Palma 2 Color Pro			
Power Supply:	DC 3.87V from battery			
Hardware Version:	N/A			
Software Version:	N/A			
Sample(s) Status:	AiTSZ-240912003-1(Normal sample) AiTSZ-240912003-2(Engineer sample)			
5G WIFI:				
Supported type:	20MHz system	40MHz system	80MHz system	160MHz system
	802.11a 802.11n 802.11ac	802.11n 802.11ac	802.11ac	N/A
Operation frequency:	5180-5240MHz 5745-5825MHz	5190-5230MHz 5755-5795MHz	5210MHz 5775MHz	N/A
Modulation:	OFDM	OFDM	OFDM	N/A
Channel number:	9	4	2	N/A
Channel separation:	20MHz	40MHz	80MHz	N/A
Antenna type:	FPC antenna			
Antenna gain:	2.0 dBi			
Remark: The above DUT's information was declared by manufacturer. For more detailed features description, please refer to the manufacturer's specifications or the User's Manual.				

2.3 Description of Test Modes and Test Frequency

The Applicant provides communication tools software to control the EUT for staying in continuous transmitting (Duty Cycle more than 98%) and receiving mode for testing.

All test performed at the low, middle and high of operational frequency range of each mode.

.Operation Frequency List:

Operating band	20MHz		40MHz		80MHz	
	Channel	Frequency (MHz)	Channel	Frequency (MHz)	Channel	Frequency (MHz)
U-NII 1 (5150MHz-5250MHz)	36	5180	38	5190	42	5210
	40	5200				
	44	5220	46	5230		
	48	5240				
U-NII 3 (5725MHz-5850MHz)	149	5745	151	5755	155	5775
	153	5765				
	157	5785	159	5795		
	161	5805				
	165	5825				

Note:

1. "--"Means no channel(s) available any more.
2. The line display in grey is those Channels/Frequencies select to test in this report for each operation mode.

Data Rate Used:

Preliminary tests were performed in different data rate to find the worst radiated emission. The data rate shown in the table below is the worst-case rate with respect to the specific test item. Investigation has been done on all the possible configurations for searching the worst cases. The following table is a list of the test modes shown in this test report.

Test Items	Mode	Data Rate
Maximum Conducted Output Power	802.11a SISO	6Mbps
Power Spectral Density	802.11n(HT20) SISO	MCS0
Emission Bandwidth(26dBm Bandwidth)	802.11n(HT40) SISO	MCS0
Minimum Emission Bandwidth(6dBm Bandwidth)	802.11ac(VHT20) SISO	MCS0
Undesirable emission	802.11ac(VHT40) SISO	MCS0
Frequency Stability	802.11ac(VHT80) SISO	MCS0

Power setting during the test:

During testing, Channel & Power Controlling Software provided by the customer was used to control the operating channel as well as the output power level. The RF output power selection is for the setting of RF output power expected by the customer and is going to be fixed on the firmware of the final end product.

Power Parameters:

Test Software Version	Qualcomm Radio Control Tool		
Test Frequency	Lowest	Middle	Highest
UNII Band 1	Default	Default	Default
UNII Band 3	Default	Default	Default

2.4 Special Accessories

Follow auxiliary equipment(s) test with EUT that provided by the manufacturer or laboratory is listed as follow:

Description	Manufacturer	Model	Serial No.	Provided by	Other
Adapter	HNT	HNT-QC530	/	Test lab	/
/	/	/	/	/	/

2.5 Equipment List for the Test

No	Test Equipment	Manufacturer	Model No	Serial No	Cal. Date	Cal. Due Date
1	Spectrum Analyzer	R&S	FSV40	101470	2024.09.07	2025.09.06
2	Spectrum Analyzer	Keysight	N9020A	MY51280643	2024.09.07	2025.09.06
3	EMI Measuring Receiver	R&S	ESR	101660	2024.09.07	2025.09.06
4	Low Noise Pre-Amplifier	HP	HP8447E	1937A01855	2024.09.07	2025.09.06
5	Low Noise Pre-Amplifier	Tsj	MLA-0120-A02-34	2648A04738	2024.09.07	2025.09.06
6	Passive Loop	ETS	6512	00165355	2024.09.03	2026.09.06
7	TRILOG Super Broadband test Antenna	SCHWARZBECK	VULB9160	9160-3206	2024.08.28	2027.08.27
8	Broadband Horn Antenna	SCHWARZBECK	BBHA9120D	452	2024.08.28	2027.08.27
9	SHF-EHF Horn Antenna 15-40GHZ	SCHWARZBECK	BBHA9170	BBHA9170367d	2024.08.28	2027.08.27
10	EMI Measuring Receiver	R&S	ESR	101160	2024.09.12	2025.09.11
11	LISN	SCHWARZBECK	NNLK 8129	8130179	2023.10.29	2024.10.28
12	Pulse Limiter	R&S	ESH3-Z2	102789	2024.09.12	2025.09.11
13	Pro.Temp&Humi.chamber	MENTEK	MHP-150-1C	MAA08112501	2024.09.07	2025.09.06
14	RF Automatic Test system	MW	MW100-RFCB	21033016	2024.09.07	2025.09.06
15	Signal Generator	Agilent	N5182A	MY50143009	2024.09.07	2025.09.06
16	Power sensor	Agilent	U2021XA	MY55130004	2024.09.07	2025.09.06
17	Wideband Radio communication tester	R&S	CMW500	1201.0002K50	2024.09.07	2025.09.06
18	RF Automatic Test system	MW	MW100-RFCB	21033016	2024.09.07	2025.09.06
19	DC power supply	ZHAOXIN	RXN-305D-2	28070002559	N/A	N/A
20	RE Software	EZ	EZ-EMC_RE	Ver.AIT-03A	N/A	N/A
21	CE Software	EZ	EZ-EMC_CE	Ver.AIT-03A	N/A	N/A
22	RF Software	MW	MTS 8310	2.0.0.0	N/A	N/A
23	temporary antenna connector(Note)	NTS	R001	N/A	N/A	N/A

Note: The temporary antenna connector is soldered on the PCB board in order to perform conducted tests and this temporary antenna connector is listed in the equipment list.

3 TEST CONDITIONS AND RESULTS

3.1 Conducted Emissions Test

LIMIT

Frequency range (MHz)	Limit (dBuV)	
	Quasi-peak	Average
0.15-0.5	66 to 56*	56 to 46*
0.5-5	56	46
5-30	60	50

* Decreases with the logarithm of the frequency.

TEST CONFIGURATION

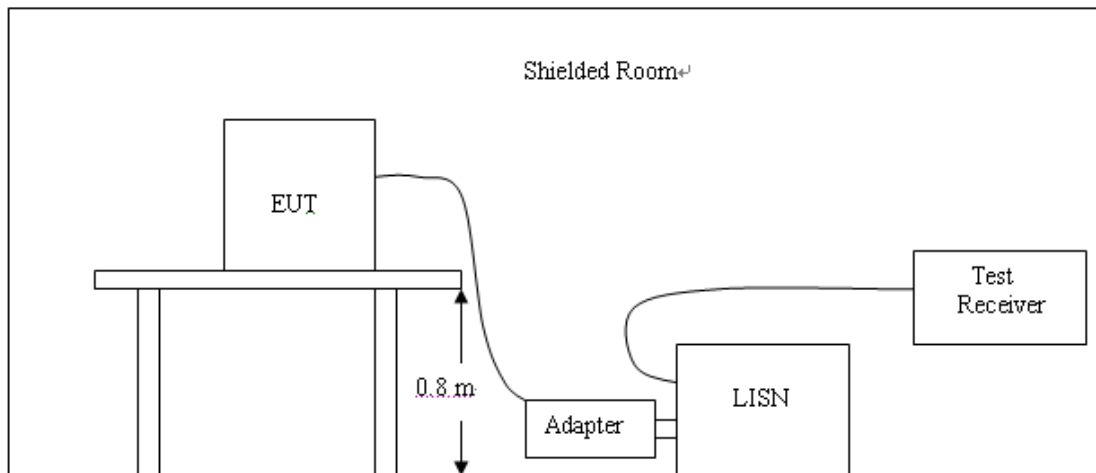

TEST PROCEDURE

1. The equipment was set up as per the test configuration to simulate typical actual usage per the user's manual. The EUT is a tabletop system; a wooden table with a height of 0.8 meters is used and is placed on the ground plane as per ANSI C63.10:2013.
2. Support equipment, if needed, was placed as per ANSI C63.10:2013.
3. All I/O cables were positioned to simulate typical actual usage as per ANSI C63.10:2013.
4. The adapter received AC120V/60Hz power through a Line Impedance Stabilization Network (LISN) which supplied power source and was grounded to the ground plane.
5. All support equipments received AC power from a second LISN, if any.
6. The EUT test program was started. Emissions were measured on each current carrying line of the EUT using a spectrum Analyzer / Receiver connected to the LISN powering the EUT. The LISN has two monitoring points: Line 1 (Hot Side) and Line 2 (Neutral Side). Two scans were taken: one with Line 1 connected to Analyzer / Receiver and Line 2 connected to a 50 ohm load; the second scan had Line 1 connected to a 50 ohm load and Line 2 connected to the Analyzer / Receiver.
7. Analyzer / Receiver scanned from 150 KHz to 30MHz for emissions in each of the test modes.
8. During the above scans, the emissions were maximized by cable manipulation.

TEST RESULTS

1. Pre-scan all modes of IEEE 802.11a/n(HT20)/n(HT40)/ac(VHT20)/ac (VHT40) /ac (VHT80) at Low, Middle, and High channel; only the worst result of was reported as below:
2. Both 120 VAC, 50/60 Hz and 240 VAC, 50/60 Hz power supply have been tested, only the worst result of 120 VAC, 60 Hz was reported as below:

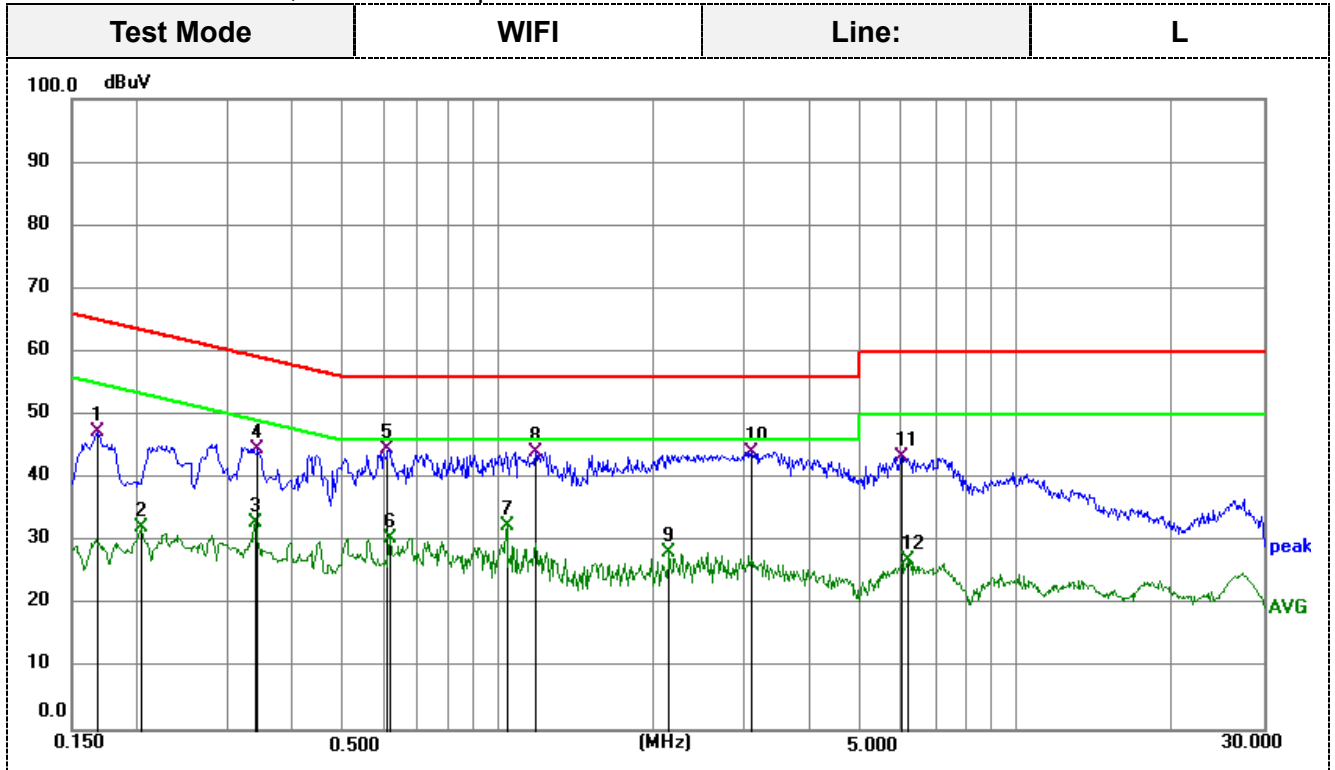

Remark: Correct Factor = Insertion loss of LISN + Cable loss + Insertion loss of Pulse Limiter;
 Measurement Result = Reading Level +Correct Factor;
 Margin = Measurement Result- Limit

No.	Frequency (MHz)	Reading (dBuV)	Correct (dB)	Result (dBuV)	Limit (dBuV)	Margin (dB)	Remark
1	0.1680	36.52	10.67	47.19	65.06	-17.87	QP
2	0.2040	21.42	10.70	32.12	53.45	-21.33	AVG
3	0.3390	22.06	10.70	32.76	49.23	-16.47	AVG
4	0.3427	33.82	10.69	44.51	59.14	-14.63	QP
5	0.6134	33.88	10.69	44.57	56.00	-11.43	QP
6	0.6180	19.67	10.69	30.36	46.00	-15.64	AVG
7	1.0410	21.68	10.64	32.32	46.00	-13.68	AVG
8	1.1805	33.40	10.67	44.07	56.00	-11.93	QP
9	2.1345	17.35	10.78	28.13	46.00	-17.87	AVG
10	3.0794	33.26	10.79	44.05	56.00	-11.95	QP
11	6.0224	32.29	11.03	43.32	60.00	-16.68	QP
12	6.1665	15.91	11.03	26.94	50.00	-23.06	AVG

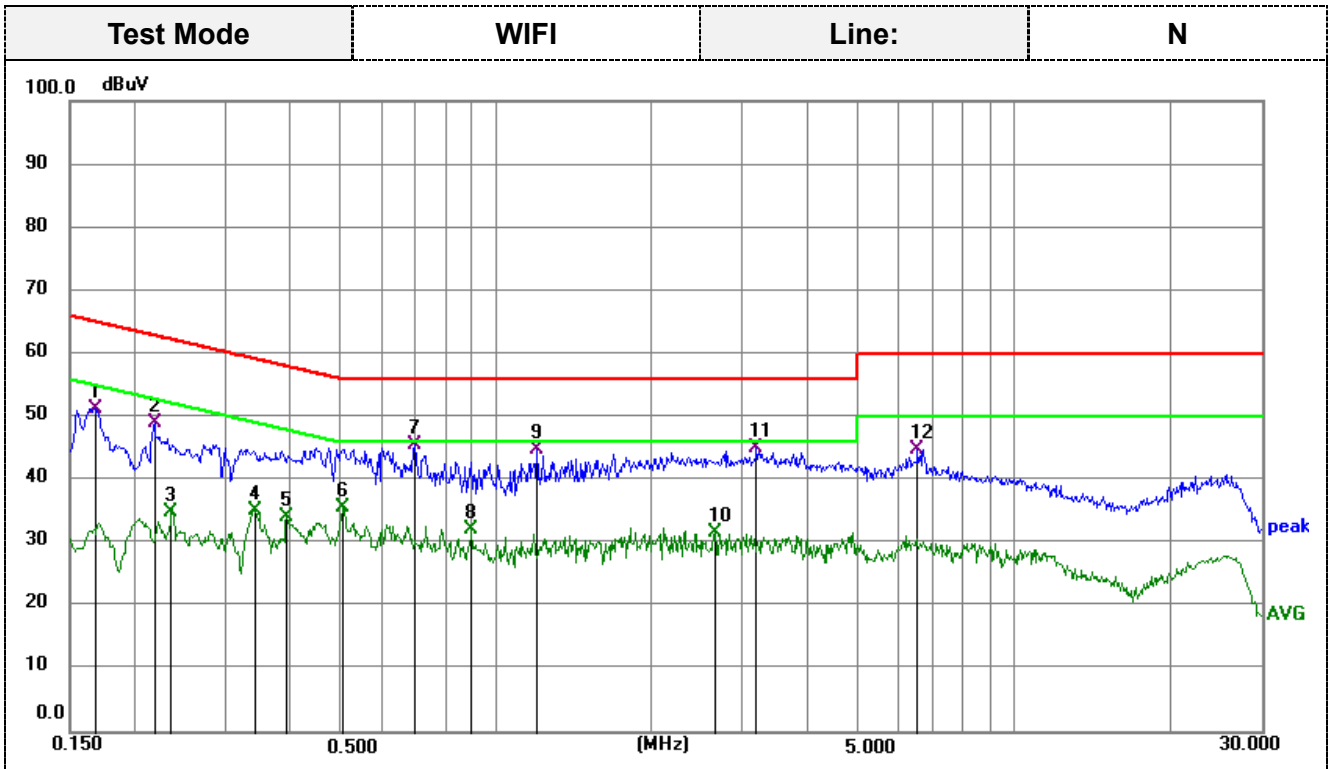

Remark: Correct Factor = Insertion loss of LISN + Cable loss + Insertion loss of Pulse Limiter;
 Measurement Result = Reading Level + Correct Factor;
 Margin = Measurement Result - Limit

No.	Frequency (MHz)	Reading (dBuV)	Correct (dB)	Result (dBuV)	Limit (dBuV)	Margin (dB)	Remark
1	0.1675	40.65	10.67	51.32	65.08	-13.76	QP
2	0.2174	38.21	10.69	48.90	62.92	-14.02	QP
3	0.2353	24.05	10.69	34.74	52.26	-17.52	AVG
4	0.3427	24.54	10.68	35.22	49.14	-13.92	AVG
5	0.3930	23.53	10.69	34.22	48.00	-13.78	AVG
6	0.5050	24.88	10.69	35.57	46.00	-10.43	AVG
7	0.6990	34.74	10.67	45.41	56.00	-10.59	QP
8	0.8970	21.54	10.65	32.19	46.00	-13.81	AVG
9	1.2030	34.02	10.66	44.68	56.00	-11.32	QP
10	2.6430	20.85	10.79	31.64	46.00	-14.36	AVG
11	3.1875	34.36	10.79	45.15	56.00	-10.85	QP
12	6.5220	33.80	11.01	44.81	60.00	-15.19	QP

3.2 Radiated Emissions and Band Edge

Limit

The maximum emissions outside of the frequency bands of operation shall be attenuated in accordance with the following limits:

- (1) For transmitters operating in the 5.15-5.25 GHz band: All emissions outside of the 5.15-5.35 GHz band shall not exceed an e.i.r.p. of -27 dBm/MHz.
- (2) For transmitters operating in the 5.25-5.35 GHz band: All emissions outside of the 5.15-5.35 GHz band shall not exceed an e.i.r.p. of -27 dBm/MHz.
- (3) For transmitters operating in the 5.47-5.725 GHz band: All emissions outside of the 5.47-5.725 GHz band shall not exceed an e.i.r.p. of -27 dBm/MHz.
- (4) For transmitters operating in the 5.725-5.85 GHz band: All emissions shall be limited to a level of -27 dBm/MHz at 75 MHz or more above or below the band edge increasing linearly to 10 dBm/MHz at 25 MHz above or below the band edge, and from 25 MHz above or below the band edge increasing linearly to a level of 15.6 dBm/MHz at 5 MHz above or below the band edge, and from 5 MHz above or below the band edge increasing linearly to a level of 27 dBm/MHz at the band edge.

Undesirable emission limits

Requirement	Limit(EIRP)	Limit (Field strength at 3m) ^{Note1}
15.407(b)(1)	PK:-27(dBm/MHz)	PK:68.2(dBμV/m)
15.407(b)(2)		
15.407(b)(3)		
15.407(b)(4)		

Note1: The following formula is used to convert the equipment isotropic radiated power (eirp) to field strength:

$$E = \frac{1000000\sqrt{30P}}{3} \mu\text{V/m, where P is the eirp (Watts)}$$

- (5) Unwanted emissions below 1 GHz must comply with the general field strength limits set forth in §15.209
- (6) In addition, radiated emissions which fall in the restricted bands, as defined in §15.205(a), must also comply with the radiated emission limits specified in §15.209(a)

Radiated emission limits

Frequency (MHz)	Distance (Meters)	Radiated (dBμV/m)	Radiated (μV/m)
0.009-0.49	3	20log(2400/F(KHz))+40log(300/3)	2400/F(KHz)
0.49-1.705	3	20log(24000/F(KHz))+ 40log(30/3)	24000/F(KHz)
1.705-30	3	20log(30)+ 40log(30/3)	30
30-88	3	40.0	100
88-216	3	43.5	150
216-960	3	46.0	200
Above 960	3	54.0	500

TEST CONFIGURATION

(A) Radiated Emission Test Set-Up, Frequency Below 30MHz

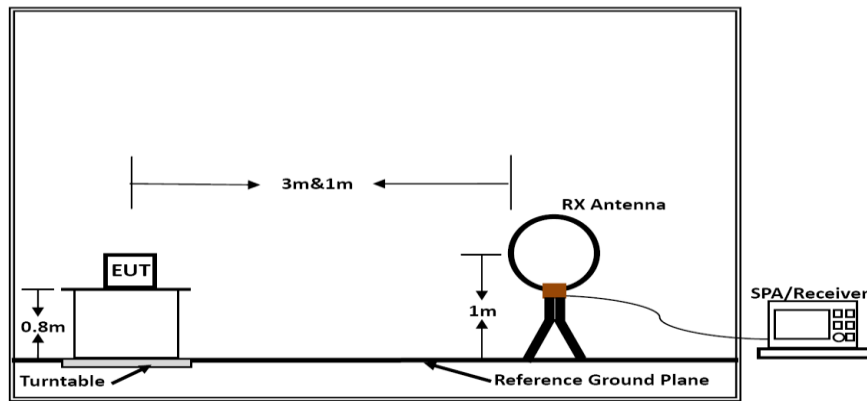

Below 30MHz

(B) Radiated Emission Test Set-Up, Frequency below 1000MHz

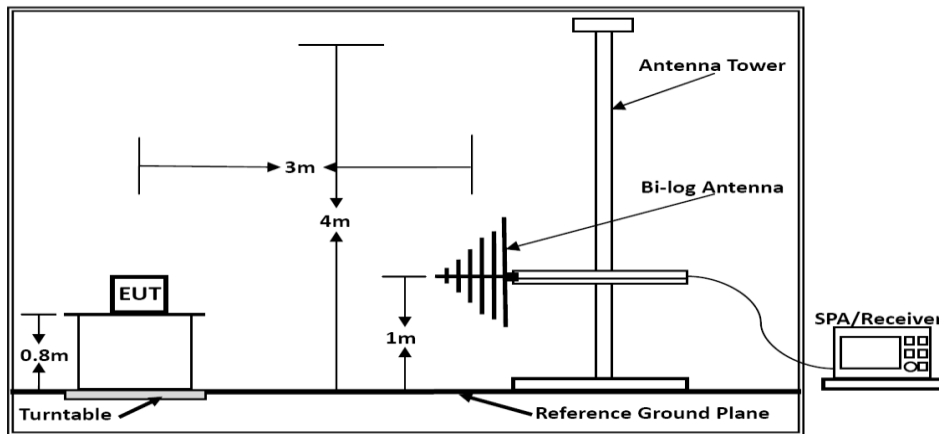

Below 1GHz

(C) Radiated Emission Test Set-Up, Frequency above 1000MHz

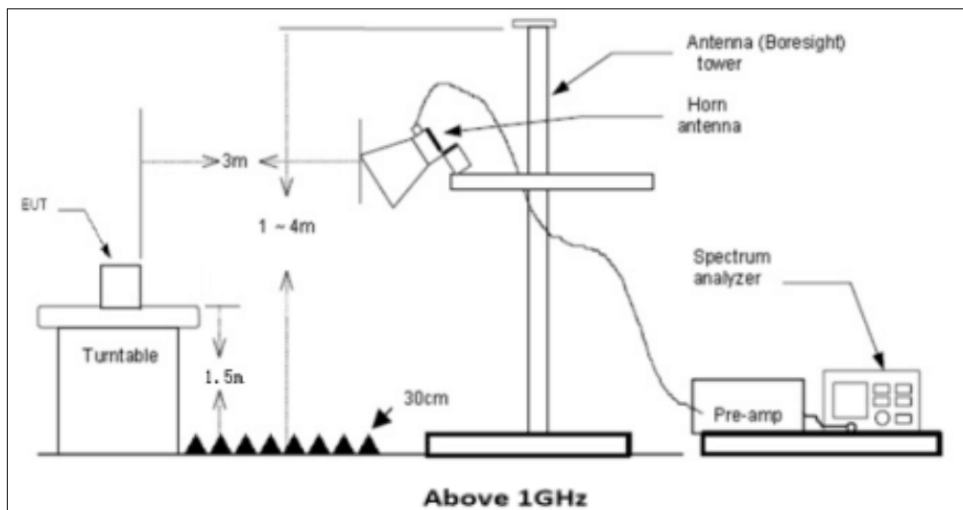

Above 1GHz

Test Procedure

1. Below 1GHz measurement the EUT is placed on a turntable which is 0.8m above ground plane, and above 1GHz measurement EUT was placed on a low permittivity and low loss tangent turn table which is 1.5m above ground plane.
2. Maximum procedure was performed by raising the receiving antenna from 1m to 4m and rotating the turn table from 0°C to 360°C to acquire the highest emissions from EUT
3. And also, each emission was to be maximized by changing the polarization of receiving antenna both horizontal and vertical.
4. Repeat above procedures until all frequency measurements have been completed.
5. Radiated emission test frequency band from 9KHz to 25GHz.
6. The distance between test antenna and EUT as following table states:

Test Frequency range	Test Antenna Type	Test Distance
9KHz-30MHz	Active Loop Antenna	3
30MHz-1GHz	Bilog Antenna	3
1GHz-18GHz	Horn Antenna	3
18GHz-25GHz	Horn Antenna	1

7. Setting test receiver/spectrum as following table states:

Test Frequency range	Test Receiver/Spectrum Setting	Detector
9KHz-150KHz	RBW=200Hz/VBW=3KHz, Sweep time=Auto	QP
150KHz-30MHz	RBW=9KHz/VBW=100KHz, Sweep time=Auto	QP
30MHz-1GHz	RBW=120KHz/VBW=1000KHz, Sweep time=Auto	QP
1GHz-40GHz	Peak Value: RBW=1MHz/VBW=3MHz, Sweep time=Auto Average Value: RBW=1MHz/VBW=10Hz, Sweep time=Auto	Peak

TEST RESULTS

Remark:

1. All WIFI operation modes have been tested for below 1GHz test, only the worst case 802.11a low channel of U-NII 1 band was recorded.
2. All WIFI operation modes have been tested for above 1GHz test, only the worst case 802.11a was recorded.
3. All WIFI operation modes have been tested for U-NII 3 bandedge test, only the worst case of 802.11n(HT20) mode was recorded.
4. Radiated emission test from 9 KHz to 10th harmonic of fundamental was verified, and no emission found except system noise floor in 9 KHz to 30MHz and not recorded in this report.

For 30MHz-1GHz

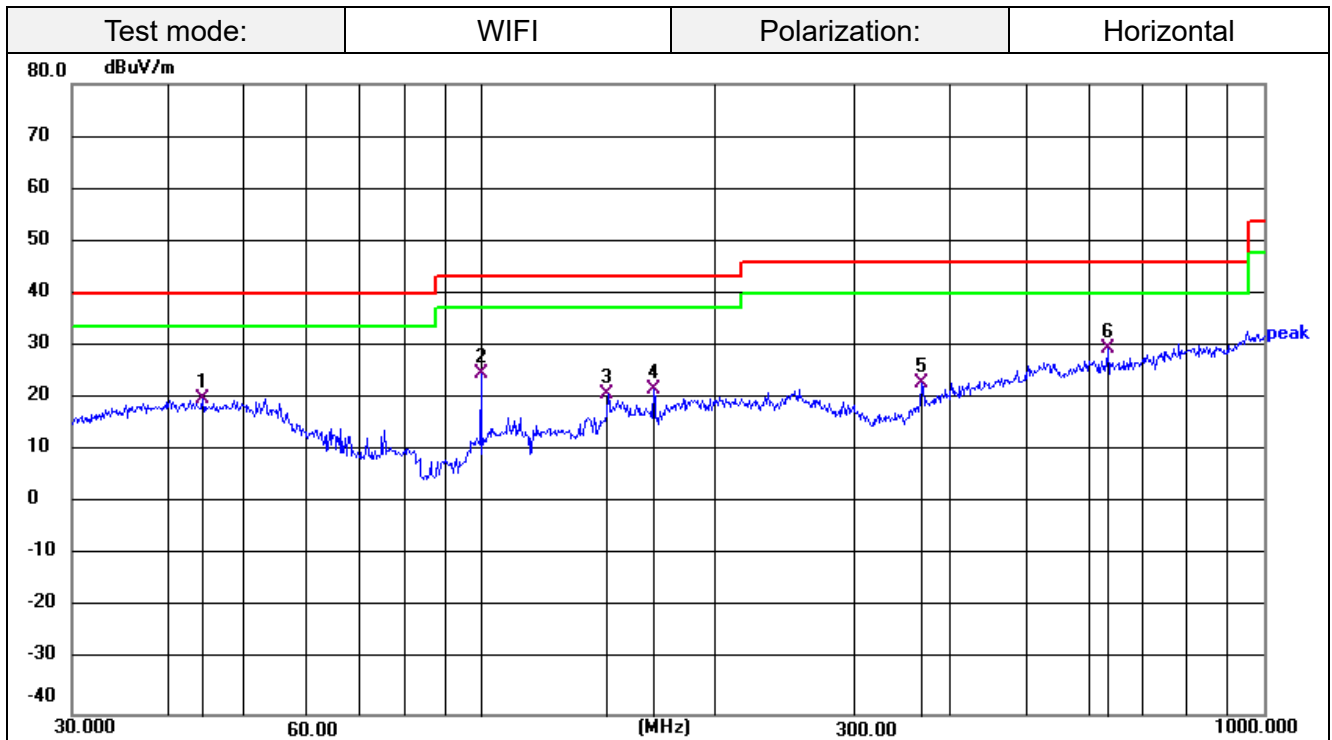

Remark:
 Emission Level = Reading + Factor;
 Factor = Antenna Factor + Cable Loss – Pre-amplifier;
 Margin= Emission Level - Limit.

No.	Frequency (MHz)	Reading (dBuV)	Factor (dB/m)	Level (dBuV/m)	Limit (dBuV/m)	Margin (dB)	Det.
1	44.1781	36.96	-16.67	20.29	40.00	-19.71	QP
2	99.9651	45.21	-20.32	24.89	43.50	-18.61	QP
3	145.7332	37.89	-16.86	21.03	43.50	-22.47	QP
4	166.6511	38.57	-16.74	21.83	43.50	-21.67	QP
5	366.6623	38.52	-15.31	23.21	46.00	-22.79	QP
6	633.3518	38.65	-9.07	29.58	46.00	-16.42	QP

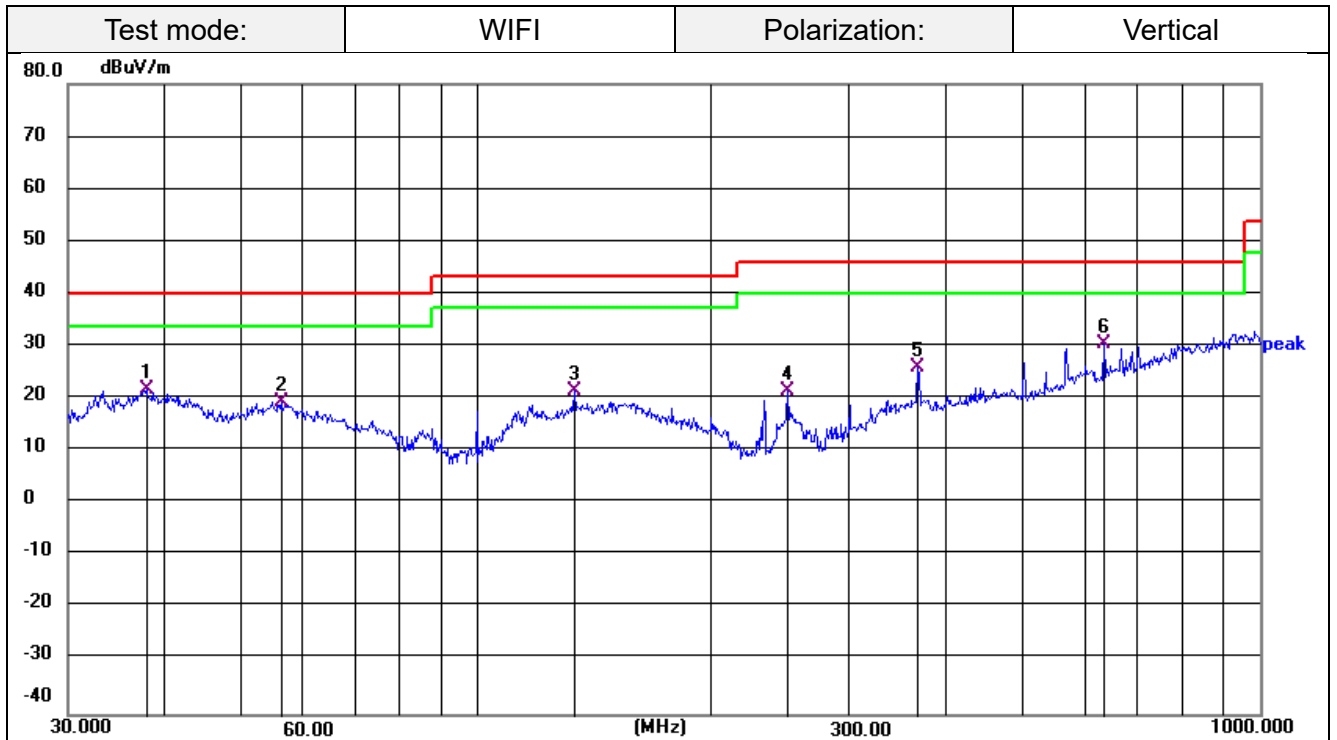

Remark:

Emission Level = Reading + Factor;
 Factor = Antenna Factor + Cable Loss – Pre-amplifier;
 Margin= Emission Level - Limit.

No.	Frequency (MHz)	Reading (dBuV)	Factor (dB/m)	Level (dBuV/m)	Limit (dBuV/m)	Margin (dB)	Det.
1	37.8286	38.81	-16.77	22.04	40.00	-17.96	QP
2	56.2220	36.78	-17.10	19.68	40.00	-20.32	QP
3	133.3262	39.15	-17.58	21.57	43.50	-21.93	QP
4	250.0817	40.30	-18.58	21.72	46.00	-24.28	QP
5	366.6623	41.42	-15.31	26.11	46.00	-19.89	QP
6	633.3518	39.74	-9.07	30.67	46.00	-15.33	QP

For 1GHz to 40GHz

Remark: All WIFI operation modes have been tested for above 1GHz test, only the worst case 802.11a mode was recorded as below:

U-NII 1 @ 802.11a mode (above 1GHz)

Tested Channel	Frequency (MHz)	Meter Reading (dBμV)	Factor (dB/m)	Emission Level (dBμV/m)	Limit (dBuV/m)	Margin (dB)	ANT Pol	Detector Mode
36 (5180MHz)	5150	53.39	-6.33	47.06	68.20	-21.14	V	PK
	10360	54.79	3.87	50.92	68.20	-17.28	V	PK
	--	--	--	--	--	--	--	--
40 (5200MHz)	10400	56.26	4.22	52.04	68.20	-16.16	V	PK
	--	--	--	--	--	--	--	--
48 (5240MHz)	5350.5	43.66	-5.81	49.47	68.20	-18.73	V	PK
	10480	58.10	3.77	54.33	68.20	-13.87	V	PK
	10480.00	41.22	3.77	44.99	54.00	-9.01	V	AV

Tested Channel	Frequency (MHz)	Meter Reading (dBμV)	Factor (dB/m)	Emission Level (dBμV/m)	Limit (dBuV/m)	Margin (dB)	ANT Pol	Detector Mode
36 (5180MHz)	5150	53.83	-6.33	47.50	68.20	-20.70	H	PK
	10360	52.80	3.87	48.93	68.20	-19.27	H	PK
	--	--	--	--	--	--	--	--
40 (5200MHz)	10400	55.38	4.22	51.16	68.20	-17.04	H	PK
	--	--	--	--	--	--	--	--
48 (5240MHz)	5350.5	43.65	-5.81	49.46	68.20	-18.74	H	PK
	10480	57.50	3.77	53.73	68.20	-14.47	H	PK
	--	--	--	--	--	--	--	--

REMARKS:

1. Emission level (dBuV/m) = Meter Reading(dBuV)+ Factor (dB/m)
2. Factor (dB/m) = Antenna Factor (dB/m)+Cable Factor (dB)-Pre-amplifier Factor
3. Margin value = Emission level- Limit value.
4. --Other emission levels are attenuated 20dB below the limit and not recorded in report.
5. RBW1MHz VBW3MHz Peak detector is for PK value; RBW 1MHz VBW10Hz Peak detector is for AV value.

U-NII 3 @ 802.11a mode (above 1GHz)

Tested Channel	Frequency (MHz)	Meter Reading (dBμV)	Factor (dB/m)	Emission Level (dBμV/m)	Limit (dBuV/m)	Margin (dB)	ANT Pol	Detector Mode
149 (5745MHz)	11490	53.51	4.83	58.34	68.20	-9.86	V	PK
	11490	49.07	4.83	45.31	54.00	-8.69	V	AV
	--	--	--	--	--	--	--	--
157 (5785MHz)	11570	52.23	5.45	57.68	68.20	-10.52	V	PK
	11570	49.20	5.45	43.69	54.00	-10.31	V	AV
	--	--	--	--	--	--	--	--
165 (5825MHz)	11650	58.19	4.64	62.83	68.20	-5.37	V	PK
	11650	50.81	4.64	48.78	54.00	-5.22	V	AV
	--	--	--	--	--	--	--	--

Tested Channel	Frequency (MHz)	Meter Reading (dBμV)	Factor (dB/m)	Emission Level (dBμV/m)	Limit (dBuV/m)	Margin (dB)	ANT Pol	Detector Mode
149 (5745MHz)	11490	53.33	4.83	58.16	68.20	-10.04	H	PK
	11490	39.85	4.83	44.68	54.00	-9.32	H	AV
	--	--	--	--	--	--	--	--
157 (5785MHz)	11570	51.51	5.45	56.96	68.20	-11.24	H	PK
	11570	37.70	5.45	43.15	54.00	-10.85	H	AV
	--	--	--	--	--	--	--	--
165 (5825MHz)	11650	57.30	4.64	61.94	68.20	-6.26	H	PK
	11650	43.27	4.64	47.91	54.00	-6.09	H	AV
	--	--	--	--	--	--	--	--

REMARKS:

1. Emission level (dBuV/m) = Meter Reading (dBuV) + Factor (dB/m)
2. Factor (dB/m) = Antenna Factor (dB/m) + Cable Factor (dB) - Pre-amplifier Factor
3. Margin value = Emission level - Limit value.
4. --Other emission levels are attenuated 20dB below the limit and not recorded in report.
5. RBW 1MHz VBW 3MHz Peak detector is for PK value; RBW 1MHz VBW 10Hz Peak detector is for AV value.

Band Edge Test Plots of U-NII 3

U-NII 3 @ 802.11n(HT40) mode

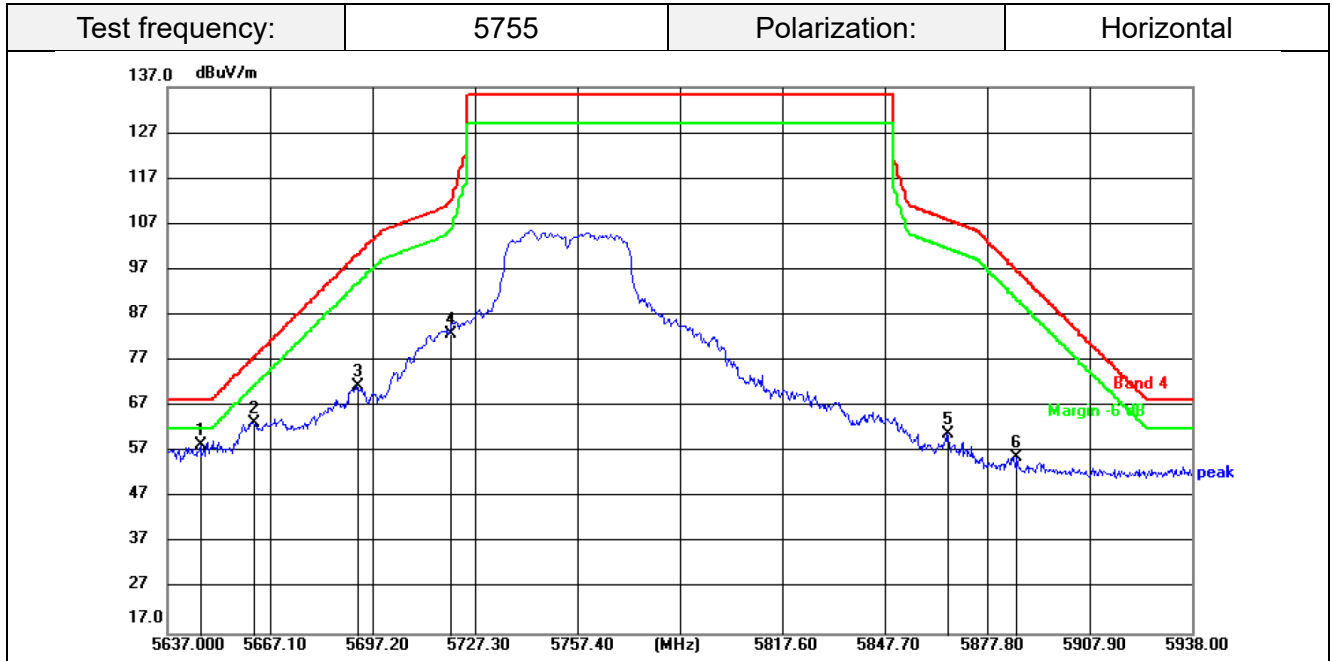

Remark:

Emission Level = Reading + Factor;

Factor = Antenna Factor + Cable Loss – Pre-amplifier;

Margin= Emission Level - Limit.

No.	Frequency (MHz)	Reading (dBuV)	Factor (dB/m)	Level (dBuV/m)	Limit (dBuV/m)	Margin (dB)	Det.
1	5645.895	53.64	4.85	58.49	68.2	-9.71	PK
2	5662.171	58.82	4.63	63.45	77.21	-13.76	PK
3	5692.765	67.37	4.22	71.59	99.84	-28.25	PK
4	5720.000	78.49	4.40	82.89	110.8	-27.91	PK
5	5866.136	54.79	6.16	60.95	107.68	-46.73	PK
6	5886.535	49.49	6.37	55.86	96.67	-40.81	PK

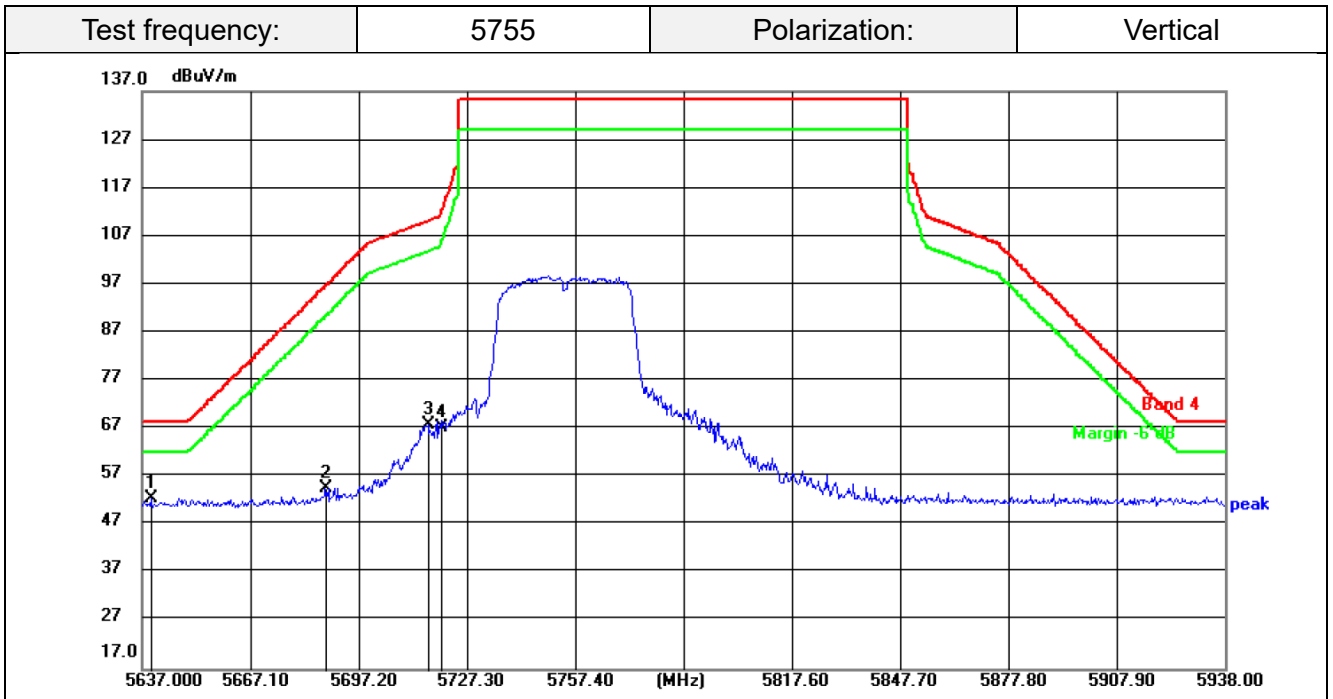

Remark:
 Emission Level = Reading + Factor;
 Factor = Antenna Factor + Cable Loss – Pre-amplifier;
 Margin= Emission Level - Limit.

No.	Frequency (MHz)	Reading (dBuV)	Factor (dB/m)	Level (dBuV/m)	Limit (dBuV/m)	Margin (dB)	Det.
1	5639.635	47.75	4.93	52.68	68.2	-15.52	PK
2	5688.025	50.51	4.29	54.80	96.33	-41.53	PK
3	5716.725	63.61	4.35	67.96	109.88	-41.92	PK
4	5720.000	62.99	4.40	67.39	110.8	-43.41	PK

U-NII 3 @ 802.11n(HT40) mode

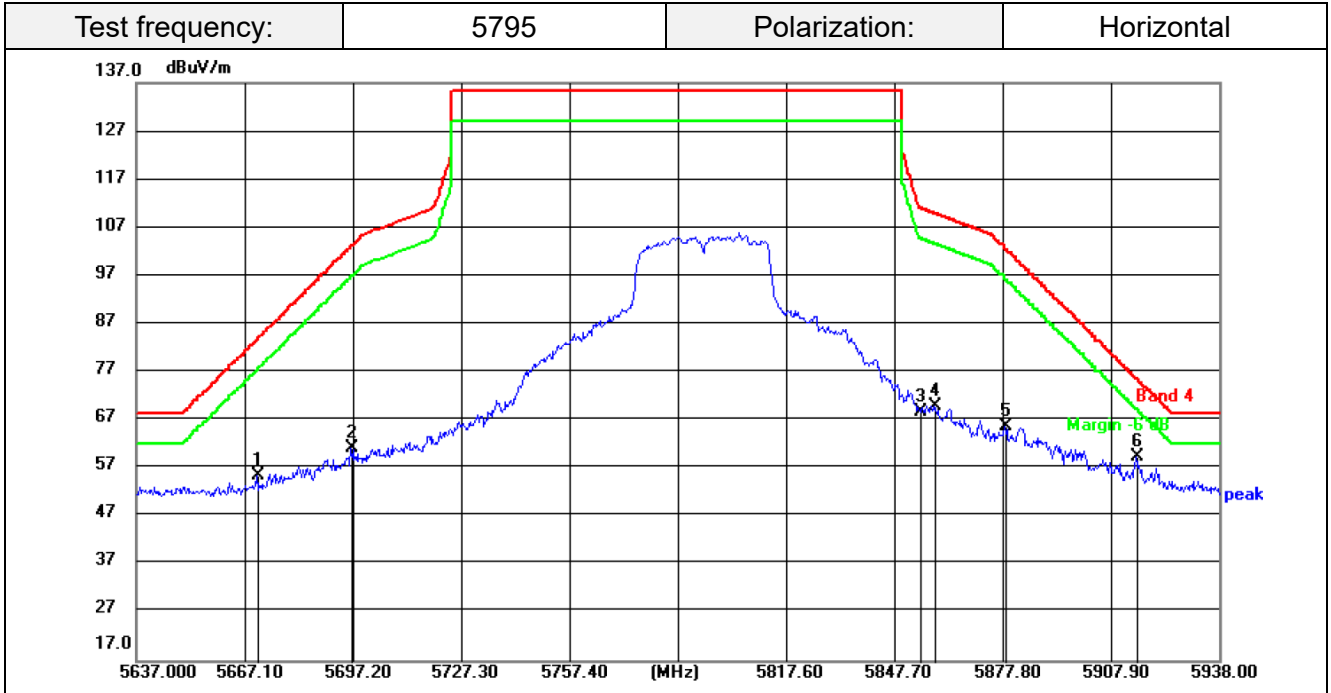

Remark:
 Emission Level = Reading + Factor;
 Factor = Antenna Factor + Cable Loss – Pre-amplifier;
 Margin= Emission Level - Limit.

No.	Frequency (MHz)	Reading (dBuV)	Factor (dB/m)	Level (dBuV/m)	Limit (dBuV/m)	Margin (dB)	Det.
1	5670.486	50.93	4.52	55.45	83.36	-27.91	PK
2	5696.673	57.15	4.17	61.32	102.74	-41.42	PK
3	5855.000	62.78	6.05	68.83	110.8	-41.97	PK
4	5858.875	64.02	6.09	70.11	109.72	-39.61	PK
5	5875.815	59.59	6.26	65.85	102.6	-36.75	PK
6	5915.011	53.29	6.27	59.56	75.59	-16.03	PK

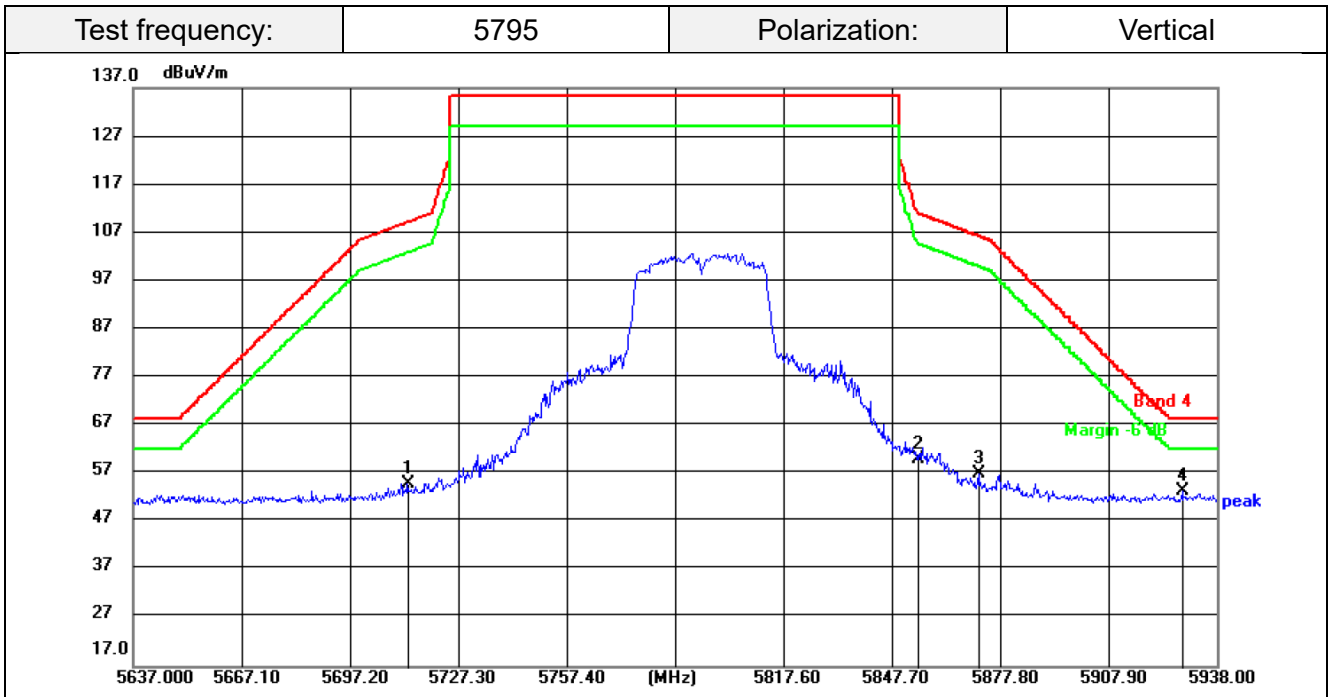

Remark:

Emission Level = Reading + Factor;
 Factor = Antenna Factor + Cable Loss – Pre-amplifier;
 Margin= Emission Level - Limit.

No.	Frequency (MHz)	Reading (dBuV)	Factor (dB/m)	Level (dBuV/m)	Limit (dBuV/m)	Margin (dB)	Det.
1	5713.415	50.69	4.31	55.00	108.96	-53.96	PK
2	5855.000	54.14	6.05	60.19	110.8	-50.61	PK
3	5872.005	50.79	6.22	57.01	106.04	-49.03	PK
4	5928.555	47.43	6.05	53.48	68.2	-14.72	PK

3.3 Maximum Conducted Average Output Power

Limit

FCC requirement:

For the band 5.15-5.25 GHz.

- (i) For an outdoor access point operating in the band 5.15-5.25 GHz, the maximum conducted output power over the frequency band of operation shall not exceed 1 W provided the maximum antenna gain does not exceed 6 dBi.
- (ii) For an indoor access point operating in the band 5.15-5.25 GHz, the maximum conducted output power over the frequency band of operation shall not exceed 1 W provided the maximum antenna gain does not exceed 6 dBi.
- (iii) For fixed point-to-point access points operating in the band 5.15-5.25 GHz, the maximum conducted output power over the frequency band of operation shall not exceed 1 W.
- (iv) For client devices in the 5.15-5.25 GHz band, the maximum conducted output power over the frequency band of operation shall not exceed 250 mW provided the maximum antenna gain does not exceed 6 dBi.

For the 5.25-5.35 GHz and 5.47-5.725 GHz bands, the maximum conducted output power over the frequency bands of operation shall not exceed the lesser of 250 mW or $11 \text{ dBm} + 10 \log B$, where B is the 26 dB emission bandwidth in megahertz.

For the band 5.725-5.85 GHz, the maximum conducted output power over the frequency band of operation shall not exceed 1 W

IC requirement:

Frequency band 5150-5250 MHz

For OEM devices installed in vehicles, the maximum e.i.r.p. shall not exceed 30 mW or $1.76 + 10 \log_{10} B$, dBm, whichever is less.

For other devices, the maximum e.i.r.p. shall not exceed 200 mW or $10 + 10 \log_{10} B$, dBm, whichever power is less. B is the 99% emission bandwidth in megahertz.

Frequency band 5250-5350 MHz

For OEM devices installed in vehicles, the maximum e.i.r.p. shall not exceed 30 mW or $1.76 + 10 \log_{10} B$, dBm, whichever is less. Devices shall implement TPC in order to have the capability to operate at least 3 dB below the maximum permitted e.i.r.p. of 30 mW.

Devices, other than devices installed in vehicles, shall comply with the following:

- a) The maximum conducted output power shall not exceed 250 mW or $11 + 10 \log_{10} B$, dBm, whichever is less. The power spectral density shall not exceed 11 dBm in any 1.0 MHz band;
- b) The maximum e.i.r.p. shall not exceed 1.0 W or $17 + 10 \log_{10} B$, dBm, whichever is less. B is the 99% emission bandwidth in megahertz. Note that devices with a maximum e.i.r.p. greater than 500 mW shall implement TPC in order to have the capability to operate at least 6 dB below the maximum permitted e.i.r.p. of 1 W.

Frequency bands 5470-5600 MHz and 5650-5725 MHz

The maximum conducted output power shall not exceed 250 mW or $11 + 10 \log_{10} B$, dBm, whichever is less.

The maximum e.i.r.p. shall not exceed 1.0 W or $17 + 10 \log_{10} B$, dBm, whichever is less. B is the 99% emission bandwidth in megahertz.

Frequency band 5725-5850 MHz

The maximum conducted output power shall not exceed 1 W.

Test Procedure

Remove the antenna from the EUT and then connect a low loss RF cable from the antenna port to the Spectrum Analyzer.

Test Configuration

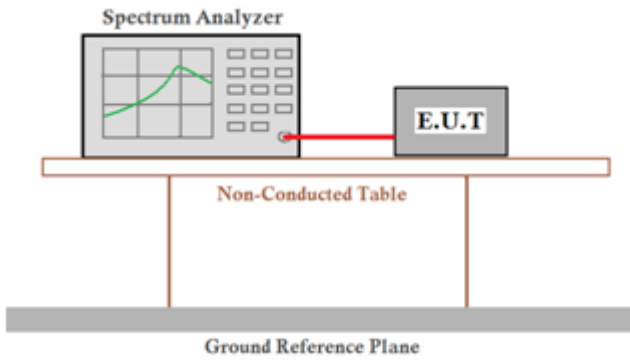

Test Results

Pass **Not Applicable**

Note:

For test data, please refer to Appendix RF test data for 5G WIFI.

3.4 Power Spectral Density

Limit

FCC requirement:

For the band 5.15-5.25 GHz.

- (i) For an outdoor access point operating in the band 5.15 - 5.25 GHz, the maximum power spectral density shall not exceed 17 dBm in any 1 MHz band. ^{note1}
- (ii) For an indoor access point operating in the band 5.15 - 5.25 GHz, the maximum power spectral density shall not exceed 17 dBm in any 1 MHz band. ^{note1}
- (iii) For fixed point-to-point access points operating in the band 5.15 - 5.25 GHz, transmitters that employ a directional antenna gain greater than 23 dBi, a 1 dB reduction in maximum power spectral density is required for each 1 dB of antenna gain in excess of 23 dBi.
- (iv) For mobile and portable client devices in the 5.15 - 5.25 GHz band, the maximum power spectral density shall not exceed 11 dBm in any 1 MHz band. ^{note1}

For the 5.25-5.35 GHz and 5.47-5.725 GHz bands

The maximum power spectral density shall not exceed 11 dBm in any 1 megahertz band.

For the band 5.725 - 5.85 GHz

The maximum power spectral density shall not exceed 30 dBm in any 500 kHz band. ^{note1, note2}

Note1: If transmitting antennas of directional gain greater than 6 dBi are used, the peak power spectral density shall be reduced by the amount in dB that the directional gain of the antenna exceeds 6 dBi.

Note2: Fixed point - to-point U-NII devices operating in this band may employ transmitting antennas with directional gain greater than 6 dBi without any corresponding reduction in transmitter conducted power. Fixed, point-to-point operations exclude the use of point-to-multipoint systems, omnidirectional applications, and multiple collocated transmitters transmitting the same information.

IC requirement:

For the band 5.15-5.25 GHz.

The e.i.r.p. spectral density shall not exceed 10 dBm in any 1.0 MHz band.

Frequency band 5250-5350 MHz

The power spectral density shall not exceed 11 dBm in any 1.0 MHz band

Frequency bands 5470-5600 MHz and 5650-5725 MHz

The power spectral density shall not exceed 11 dBm in any 1.0 MHz band.

For the band 5.725 - 5.85 GHz

The maximum power spectral density shall not exceed 30 dBm in any 500 kHz band. ^{note1, note2}

Note1: If transmitting antennas of directional gain greater than 6 dBi are used, the peak power spectral density shall be reduced by the amount in dB that the directional gain of the antenna exceeds 6 dBi.

Note2: Fixed point - to-point U-NII devices operating in this band may employ transmitting antennas with directional gain greater than 6 dBi without any corresponding reduction in transmitter conducted power. Fixed, point-to-point operations exclude the use of point-to-multipoint systems, omnidirectional applications, and multiple collocated transmitters transmitting the same information.

Test Procedure

1. Use this procedure when the maximum peak conducted output power in the fundamental emission is used to demonstrate compliance.
2. Set the RBW = 1MHz for U-NII 1, U-NII 2A, U-NII C band and 510KHz for U-NII 3 band.
3. Set the VBW $\geq 3 \times$ RBW.
4. Set the span to encompass the entire EBW.
5. Detector = RMS.
6. Sweep time = auto couple.
7. Trace mode = max hold.
8. Allow trace to fully stabilize.
9. Use the peak marker function to determine the maximum power level.

Test Configuration

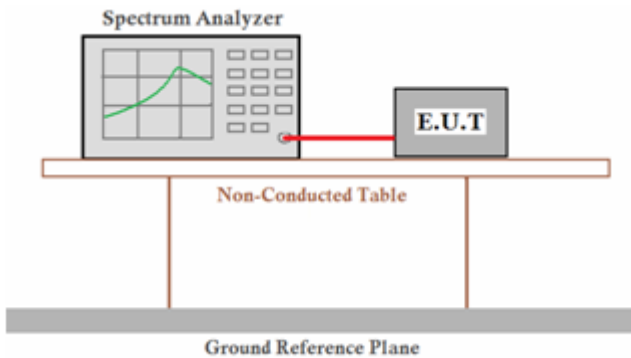

Test Results

Pass **Not Applicable**

Note:

For test data, please refer to Appendix RF test data for 5G WIFI.

3.5 Emission Bandwidth (26dBm Bandwidth)

Limit

N/A

Test Procedure

1. Set resolution bandwidth (RBW) = approximately 1 % of the EBW.
2. Set the video bandwidth (VBW) > RBW.
3. Detector = Peak.
4. Trace mode = Max hold.
5. Measure the maximum width of the emission that is 26 dB down from the peak of the emission. Compare this with the RBW setting of the analyzer. Readjust RBW and repeat measurement as needed until the RBW / EBW ratio is approximately 1 %.

Test Configuration

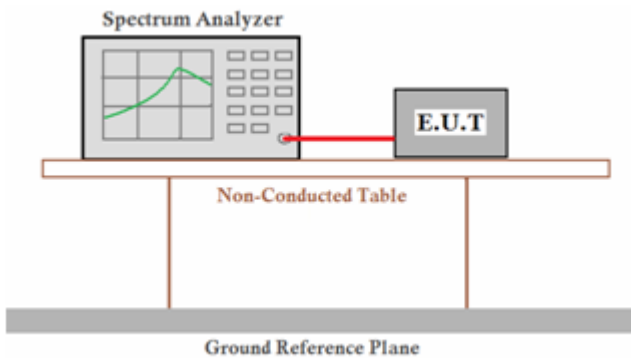

Test Results

Pass **Not Applicable**

Note:

For test data, please refer to Appendix RF test data for 5G WIFI.

3.6 Minimum Emission Bandwidth (6dBm Bandwidth)

Limit

Within the 5.725-5.85 GHz band, the minimum 6 dB bandwidth of U-NII devices shall be at least 500 kHz.

Test Procedure

1. Set resolution bandwidth (RBW) = 100 kHz
2. Set the video bandwidth 3 x RBW.
3. Detector = Peak.
4. Trace mode = Max hold.
5. Measure the maximum width of the emission that is constrained by the frequencies associated with the two outermost amplitude points (upper and lower frequencies) that are attenuated by 6 dB relative to the maximum level measured in the fundamental emission.

Test Configuration

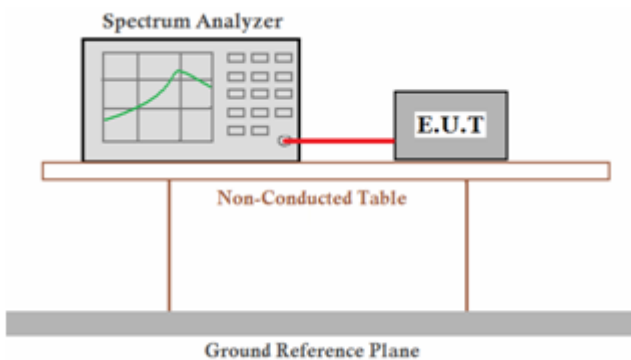

Test Results

Pass Not Applicable

Note:

For test data, please refer to Appendix RF test data for 5G WIFI.

3.7 Frequency Stability

LIMIT

Manufacturers of U-NII devices are responsible for ensuring frequency stability such that an emission is maintained within the band of operation under all conditions of normal operation as specified in the users manual.

TEST CONFIGURATION

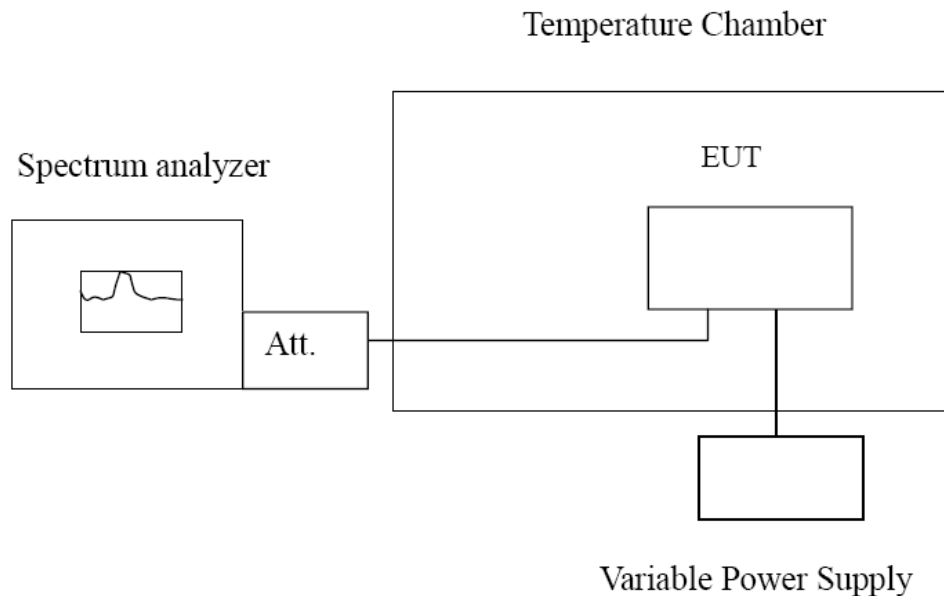

TEST PROCEDURE

Frequency Stability under Temperature Variations:

The equipment under test was connected to an external AC or DC power supply and input rated voltage. RF output was connected to a frequency counter or spectrum analyzer via feed through attenuators. The EUT was placed inside the temperature chamber. Set the spectrum analyzer RBW low enough to obtain the desired frequency resolution and measure EUT 20°C operating frequency as reference frequency. Turn EUT off and set the chamber temperature to -30°C. After the temperature stabilized for approximately 30 minutes recorded the frequency. Repeat step measure with 10°C increased per stage until the highest temperature of +50°C reached.

Frequency Stability under Voltage Variations:

Set chamber temperature to 20°C. Use a variable AC power supply / DC power source to power the EUT and set the voltage to rated voltage. Set the spectrum analyzer RBW low enough to obtain the desired frequency resolution and recorded the frequency. Reduce the input voltage to specify extreme voltage variation ($\pm 15\%$) and endpoint, record the maximum frequency change.

TEST RESULTS

Pass Not Applicable

Note:

For test data, please refer to Appendix RF test data for 5G WIFI.

3.8 Antenna Requirement

Standard Applicable

For intentional device, according to FCC 47 CFR Section 15.203:

An intentional radiator shall be designed to ensure that no antenna other than that furnished by the responsible party shall be used with the device. The use of a permanently attached antenna or of an antenna that uses a unique coupling to the intentional radiator, the manufacturer may design the unit so that a broken antenna can be replaced by the user, but the use of a standard antenna jack or electrical connector is prohibited.

Test Result:

The maximum gain of antenna was 2.0dBi.

4 Test Setup Photographs of EUT

Please refer to separated files for Test Setup Photos of the EUT.

5 External Photographs of EUT

Please refer to separated files for External Photos of the EUT.

6 Internal Photographs of EUT

Please refer to separated files for Internal Photos of the EUT.

******* End of Report *******