



Shenzhen Global Test Service Co.,Ltd.

No.7-101 and 8A-104, Building 7 and 8, DCC Cultural and Creative Garden, No.98, Pingxin North Road, Shangmugu Community, Pinghu Street, Longgang District, Shenzhen, Guangdong

FCC PART 15 SUBPART C TEST REPORT

FCC PART 15 SUBPART E 15.407

Report Reference No.....: GTS20210601011-1-2

FCC ID..... : XR3-NOVAIR

Compiled by
(position+printed name+signature)...: File administrators Jimmy Wang

Supervised by
(position+printed name+signature)...: Test Engineer Aaron Tan



Approved by
(position+printed name+signature)...: Manager Jason Hu

Date of issue.....: June 02, 2021

Representative Laboratory Name .: Shenzhen Global Test Service Co.,Ltd.

Address.....: No.7-101 and 8A-104, Building 7 and 8, DCC Cultural and Creative Garden, No.98, Pingxin North Road, Shangmugu Community, Pinghu Street, Longgang District, Shenzhen, Guangdong, China

Applicant's name.....: ONYX INTERNATIONAL INC

Address: Room 301-6, 10 Honglou Street, Liwan District, Guangzhou City, Guangdong Province, China

Test specification

Standard.....: **FCC Part 15 Subpart E 15.407**

TRF Originator.....: Shenzhen Global Test Service Co.,Ltd.

Master TRF.....: Dated 2014-12

Shenzhen Global Test Service Co.,Ltd. All rights reserved.

This publication may be reproduced in whole or in part for non-commercial purposes as long as the Shenzhen Global Test Service Co.,Ltd. is acknowledged as copyright owner and source of the material. Shenzhen Global Test Service Co.,Ltd. takes no responsibility for and will not assume liability for damages resulting from the reader's interpretation of the reproduced material due to its placement and context.

Test item description Smart E Ink Tablet, ePaper Tablet, E-bag Tablet, E-book Tablet, E-reader Tablet, Eyes protection E Ink Tablet, E-paper Tablet, Color E Ink Tablet, Color ePaper Tablet

Trade Mark.....: BOOX

Manufacturer.....: ONYX INTERNATIONAL INC.

Model/Type reference.....: Nova Air

Listed Models: Nova Air Plus, Nova Air Pro, Nova Air Lite, Nova Air S, Nova Air Color, Nova Air Color Plus, Nova Air Color Pro

Ratings.....: 5V==2A

Modulation.....: OFDM

Hardware version.....: BOOX_M2_NOVA_AIR_V1.0

Software version.....: V1.0

Frequency.....: From 5180MHz-5240MHz, 5745MHz-5825MHz

Result.....: **PASS**

TEST REPORT

Test Report No. :	GTS20210601011-1-2	June 02, 2021
		Date of issue

Equipment under Test : Smart E Ink Tablet, ePaper Tablet, E-bag Tablet, E-book Tablet, E-reader Tablet, Eyes protection E Ink Tablet, E-paper Tablet, Color E Ink Tablet, Color ePaper Tablet

Model /Type : Nova Air

Listed Models : Nova Air Plus, Nova Air Pro, Nova Air Lite, Nova Air S, Nova Air Color, Nova Air Color Plus, Nova Air Color Pro

Applicant : **ONYX INTERNATIONAL INC.**

Address : Room 301-6, 10 Honglou Street, Liwan District, Guangzhou City, Guangdong Province, China

Manufacturer : **ONYX INTERNATIONAL INC.**

Address : Building 4#, 202 Shiyu Road, Dongchong Town, Nansha District, Guangzhou City, Guangdong Province, China

Test Result:	PASS
---------------------	-------------

The test report merely corresponds to the test sample.

It is not permitted to copy extracts of these test result without the written permission of the test laboratory.

Contents

<u>1</u>	<u>TEST STANDARDS</u>	<u>4</u>
<u>2</u>	<u>SUMMARY</u>	<u>5</u>
2.1	General Remarks	5
2.2	Product Description	5
2.3	Test Sample	5
2.4	Equipment Under Test	5
2.5	Short description of the Equipment under Test (EUT)	5
2.6	EUT operation mode	6
2.7	Block Diagram of Test Setup	6
2.8	Special Accessories	6
2.9	Related Submittal(s) / Grant (s)	6
2.10	Modifications	6
<u>3</u>	<u>TEST ENVIRONMENT</u>	<u>7</u>
3.1	Address of the test laboratory	7
3.2	Test Facility	7
3.3	Environmental conditions	7
3.4	Test Description	8
3.5	Statement of the measurement uncertainty	8
3.6	Equipments Used during the Test	9
<u>4</u>	<u>TEST CONDITIONS AND RESULTS.....</u>	<u>10</u>
4.1	AC Power Conducted Emission	10
4.2	Radiated Emissions	13
4.3	Maximum Conducted Average Output Power	19
4.4	Power Spectral Density	21
4.5	Emission Bandwidth (26dBm Bandwidth)	28
4.6	Minimum Emission Bandwidth (6dBm Bandwidth)	32
4.7	Frequency Stability	36
<u>5</u>	<u>TEST SETUP PHOTOS OF THE EUT</u>	<u>38</u>
<u>6</u>	<u>PHOTOS OF THE EUT</u>	<u>39</u>

1 TEST STANDARDS

The tests were performed according to following standards:

[FCC Rules Part 15 Subpart E](#)—Unlicensed National Information Infrastructure Devices

[ANSI C63.10-2013](#): American National Standard for Testing Unlicensed Wireless Devices

[KDB789033 D02](#): General UNII Test Procedures New Rules v01r02

2 SUMMARY

2.1 General Remarks

Date of receipt of test sample	:	Apr. 19, 2021
Testing commenced on	:	Apr. 20, 2021
Testing concluded on	:	May 20, 2021

2.2 Product Description

Product Description:	Smart E Ink Tablet, ePaper Tablet, E-bag Tablet, E-book Tablet, E-reader Tablet, Eyes protection E Ink Tablet, E-paper Tablet, Color E Ink Tablet, Color ePaper Tablet			
Model:	Nova Air			
Power supply:	DC 3.8V from battery			
Sample ID:	GTS20210601011-1-1#/ GTS20210601011-1-2#			
WIFI				
Supported type:	20MHz system	40MHz system	80MHz system	160MHz system
	802.11a 802.11n 802.11ac	802.11n 802.11ac	802.11ac	N/A
Operation frequency:	5180MHz-5240MHz 5745MHz-5825MHz	5190MHz-5230MHz 5755MHz-5795MHz	5210MHz 5775MHz	N/A
Modulation:	OFDM	OFDM	OFDM	N/A
Channel number:	9	4	2	N/A
Channel separation:	20MHz	40MHz	80MHz	N/A
Antenna type:	FPC antenna			
Antenna gain:	1.0dBi			

2.3 Test Sample

The application provides 2 samples to meet requirement.

Sample Number	Description
GTS20210601011-1-1#	Engineer sample – continuous transmit
GTS20210601011-1-2#	Normal sample – Intermittent transmit

2.4 Equipment Under Test

Power supply system utilised

Power supply voltage	:	<input type="radio"/> 230V / 50 Hz	<input type="radio"/> 120V / 60Hz
		<input type="radio"/> 12 V DC	<input type="radio"/> 24 V DC
		<input checked="" type="radio"/> Other (specified in blank below)	

DC 3.8V from battery

2.5 Short description of the Equipment under Test (EUT)

This is a Smart E Ink Tablet.

For more details, refer to the user's manual of the EUT.

2.6 EUT operation mode

The Applicant provides communication tools software (QRCT3) to control the EUT for staying in continuous transmitting (Duty Cycle more than 98%) and receiving mode for testing. All test performed at the low, middle and high of operational frequency range of each mode.

Operation Frequency List WIFI on 5G Band:

Operating band	20MHz		40MHz		80MHz	
	Channel	Frequency (MHz)	Channel	Frequency (MHz)	Channel	Frequency (MHz)
U-NII 1 (5150MHz-5250MHz)	36	5180	38	5190	42	5210
	40	5200				
	44	5220	46	5230		
	48	5240				
U-NII 3 (5725MHz-5850MHz)	149	5745	151	5755	155	5775
	153	5765	159	5795		
	157	5785				
	161	5805	--	--	--	--
	165	5825	--	--	--	--

Note: The line display in grey is those Channels/Frequencies select to test in this report for each operation mode.

2.7 Block Diagram of Test Setup

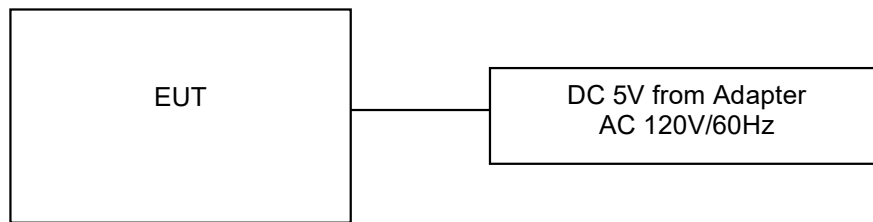

2.8 Special Accessories

Follow auxiliary equipment(s) test with EUT that provided by the manufacturer or laboratory is listed as follow:

Description	Manufacturer	Model	Technical Parameters	Certificate	Provided by
AC-DC Adapter	MOSO	EP-TA20CBC	Input:AC100-240V-50/60Hz, 0.5A Output:DC 5V,3A	FCC	Laboratory
/	/	/	/	/	/
/	/	/	/	/	/
/	/	/	/	/	/

2.9 Related Submittal(s) / Grant (s)

This submittal(s) (test report) is intended to comply with Section 15.407 of the FCC Part 15, Subpart E Rules.

2.10 Modifications

No modifications were implemented to meet testing criteria.

3 TEST ENVIRONMENT

3.1 Address of the test laboratory

Shenzhen Global Test Service Co.,Ltd.

No.7-101 and 8A-104, Building 7 and 8, DCC Cultural and Creative Garden, No.98, Pingxin North Road, Shangmugu Community, Pinghu Street, Longgang District, Shenzhen, Guangdong

The 3m-Semi anechoic test site fulfils CISPR 16-1-4 according to ANSI C63.4:2014 and CISPR 16-1-4:2010 SVSWR requirement for radiated emission above 1GHz.

3.2 Test Facility

The test facility is recognized, certified, or accredited by the following organizations:

FCC-Registration No.: 165725 Designation Number: CN1234

Shenzhen Global Test Service Co.,Ltd EMC Laboratory has been registered and fully described in a report filed with the (FCC) Federal Communications Commission. The acceptance letter from the FCC is maintained in our files.

A2LA-Lab Cert. No.: 4758.01

Shenzhen Global Test Service Co.,Ltd. EMC Laboratory has been accredited by A2LA for technical competence in the field of electrical testing, and proved to be in compliance with ISO/IEC 17025: 2005 General Requirements for the Competence of Testing and Calibration Laboratories and any additional program requirements in the identified field of testing.

CNAS-Lab Code: L8169

Shenzhen Global Test Service Co.,Ltd. has been assessed and proved to be in compliance with CNAS-CL01 Accreditation Criteria for Testing and Calibration Laboratories (identical to ISO/IEC 17025: 2005 General Requirements) for the Competence of Testing and Calibration Laboratories. Date of Registration: Dec. 11, 2015. Valid time is until Dec. 10, 2024.

3.3 Environmental conditions

During the measurement the environmental conditions were within the listed ranges:

Temperature:	15-35 ° C
Humidity:	30-60 %
Atmospheric pressure:	950-1050mbar

3.4 Test Description

FCC Requirement		
FCC Part 15.207	AC Power Conducted Emission	PASS
FCC Part 15.407(a)	Emission Bandwidth(26dBm Bandwidth)	PASS ^{Note1}
FCC Part 15.407(e)	Minimum Emission Bandwidth(6dBm Bandwidth)	PASS ^{Note2}
FCC Part 15.407(a)	Maximum Conducted Output Power	PASS
FCC Part 15.407(a)	Peak Power Spectral Density	PASS
FCC Part 15.407(g)	Frequency Stability	PASS
FCC Part 15.407(b)	Undesirable emission	PASS
FCC Part 15.407(b)/15.205/15.209	Radiated Emissions	PASS
FCC Part 15.407(h)	Dynamic Frequency Selection	N/A ^{Note 3}
FCC Part 15.203/15.247(b)	Antenna Requirement	PASS

Note 1: Apply to U-NII 1, U-NII 2A, and U-NII 2C band.

Note 2: Apply to U-NII 3 band only.

Note 3: This device not work in DFS band.

Data Rate Used:

Preliminary tests were performed in different data rate to find the worst radiated emission. The data rate shown in the table below is the worst-case rate with respect to the specific test item. Investigation has been done on all the possible configurations for searching the worst cases. The following table is a list of the test modes shown in this test report.

Test Items	Mode	Data Rate
Maximum Conducted Output Power Power Spectral Density Emission Bandwidth(26dBm Bandwidth) Minimum Emission Bandwidth(6dBm Bandwidth) Undesirable emission Frequency Stability	11a/OFDM	6 Mbps
	11n(20MHz),11ac(20MHz)/OFDM	7.2 Mbps
	11n(40MHz),11ac(40MHz)/OFDM	15.0Mbps
	11ac(80MHz)/OFDM	65.0Mbps

3.5 Statement of the measurement uncertainty

The data and results referenced in this document are true and accurate. The reader is cautioned that there may be errors within the calibration limits of the equipment and facilities. The measurement uncertainty was calculated for all measurements listed in this test report acc. to CISPR 16 - 4 „Specification for radio disturbance and immunity measuring apparatus and methods – Part 4: Uncertainty in EMC Measurements“ and is documented in the Shenzhen Global Test Service Co.,Ltd quality system acc. to DIN EN ISO/IEC 17025. Furthermore, component and process variability of devices similar to that tested may result in additional deviation. The manufacturer has the sole responsibility of continued compliance of the device.

Hereafter the best measurement capability for Shenzhen GTS laboratory is reported:

Test	Range	Measurement Uncertainty	Notes
Radiated Emission	30~1000MHz	4.10 dB	(1)
Radiated Emission	1~18GHz	4.32 dB	(1)
Radiated Emission	18-40GHz	5.54 dB	(1)
Conducted Disturbance	0.15~30MHz	3.12 dB	(1)

(1) This uncertainty represents an expanded uncertainty expressed at approximately the 95% confidence level using a coverage factor of k=2.

3.6 Equipments Used during the Test

Test Equipment	Manufacturer	Model No.	Serial No.	Calibration Date	Calibration Due Date
LISN	R&S	ENV216	3560.6550.08	2020/09/19	2021/09/18
LISN	R&S	ESH2-Z5	893606/008	2020/09/19	2021/09/18
EMI Test Receiver	R&S	ESPI3	101841-cd	2020/09/19	2021/09/18
EMI Test Receiver	R&S	ESCI7	101102	2020/09/19	2021/09/18
Spectrum Analyzer	Agilent	N9020A	MY48010425	2020/09/19	2021/09/18
Spectrum Analyzer	R&S	FSV40	100019	2020/09/19	2021/09/18
Vector Signal generator	Agilent	N5181A	MY49060502	2020/09/19	2021/09/18
Spectrum Analyzer	Agilent	E4421B	3610AO1069	2020/09/19	2021/09/18
Climate Chamber	ESPEC	EL-10KA	A20120523	2020/09/19	2021/09/18
Controller	EM Electronics	Controller EM 1000	N/A	N/A	N/A
Horn Antenna	Schwarzbeck	BBHA 9120D	01622	2020/09/19	2021/09/18
Active Loop Antenna	Beijing Da Ze Technology Co.,Ltd.	ZN30900C	15006	2020/10/11	2021/10/10
Bilog Antenna	Schwarzbeck	VULB9163	000976	2020/05/25	2022/05/24
Broadband Horn Antenna	SCHWARZBECK	BBHA 9170	791	2020/09/19	2021/09/18
Amplifier	Schwarzbeck	BBV 9743	#202	2020/09/19	2021/09/18
Amplifier	Schwarzbeck	BBV9179	9719-025	2020/09/19	2021/09/18
Amplifier	EMCI	EMC051845B	980355	2020/09/19	2021/09/18
Temperature/Humidity Meter	Gangxing	CTH-608	02	2020/09/19	2021/09/18
High-Pass Filter	K&L	9SH10-2700/X12750-O/O	KL142031	2020/09/19	2021/09/18
High-Pass Filter	K&L	41H10-1375/U12750-O/O	KL142032	2020/09/19	2021/09/18
RF Cable(below 1GHz)	HUBER+SUHNER	RG214	RE01	2020/09/19	2021/09/18
RF Cable(above 1GHz)	HUBER+SUHNER	RG214	RE02	2020/09/19	2021/09/18
Data acquisition card	Agilent	U2531A	TW53323507	2020/09/19	2021/09/18
Power Sensor	Agilent	U2021XA	MY5365004	2020/09/19	2021/09/18
Test Control Unit	Tonscend	JS0806-1	178060067	2020/06/19	2021/06/18
Automated filter bank	Tonscend	JS0806-F	19F8060177	2020/06/19	2021/06/18
EMI Test Software	Tonscend	JS1120-1	Ver 2.6.8.0518	/	/
EMI Test Software	Tonscend	JS1120-3	Ver 2.5.77.0418	/	/
EMI Test Software	Tonscend	JS32-CE	Ver 2.5	/	/
EMI Test Software	Tonscend	JS32-RE	Ver 2.5.1.8	/	/

Note: The Cal.Interval was one year.

4 TEST CONDITIONS AND RESULTS

4.1 AC Power Conducted Emission

TEST CONFIGURATION

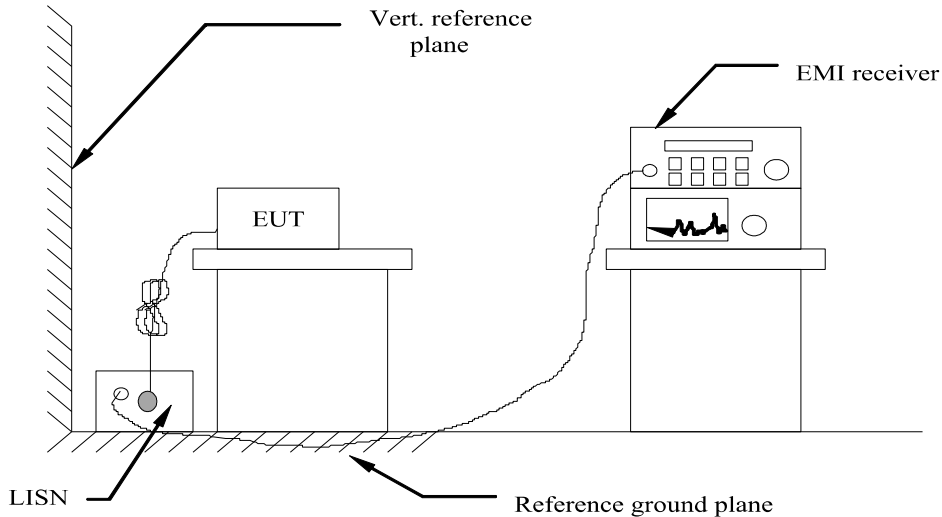

TEST PROCEDURE

- 1 The equipment was set up as per the test configuration to simulate typical actual usage per the user's manual. The EUT is a tabletop system, a wooden table with a height of 0.8 meters is used and is placed on the ground plane as per ANSI C63.10-2013.
- 2 Support equipment, if needed, was placed as per ANSI C63.10-2013
- 3 All I/O cables were positioned to simulate typical actual usage as per ANSI C63.10-2013
- 4 The EUT received DC 12V power from adapter, the adapter received AC120V/60Hz and AC 240V/60Hz power through a Line Impedance Stabilization Network (LISN) which supplied power source and was grounded to the ground plane.
- 5 All support equipments received AC power from a second LISN, if any.
- 6 The EUT test program was started. Emissions were measured on each current carrying line of the EUT using a spectrum Analyzer / Receiver connected to the LISN powering the EUT. The LISN has two monitoring points: Line 1 (Hot Side) and Line 2 (Neutral Side). Two scans were taken: one with Line 1 connected to Analyzer / Receiver and Line 2 connected to a 50 ohm load; the second scan had Line 1 connected to a 50 ohm load and Line 2 connected to the Analyzer / Receiver.
- 7 Analyzer / Receiver scanned from 150 KHz to 30MHz for emissions in each of the test modes.
- 8 During the above scans, the emissions were maximized by cable manipulation.

AC Power Conducted Emission Limit

For intentional device, according to § 15.207(a) AC Power Conducted Emission Limits is as following :

Frequency range (MHz)	Limit (dBuV)	
	Quasi-peak	Average
0.15-0.5	66 to 56*	56 to 46*
0.5-5	56	46
5-30	60	50

* Decreases with the logarithm of the frequency.

TEST RESULTS

Temperature	22.8°C	Humidity	56%
Test Engineer	Moon Tan	Configurations	WLAN 5G

Remark:

- All modes of 802.11a/n were tested at Low, Middle, and High channel; only the worst result of 802.11a CH36 was reported as below:
- Both 120 VAC, 50/60 Hz and 240 VAC, 50/60 Hz power supply have been tested, only the worst result of 120 VAC, 60 Hz was reported as below:

Power supply:	AC 120V/60Hz(adapter)	Polarization	L
---------------	-----------------------	--------------	---

Test Graph

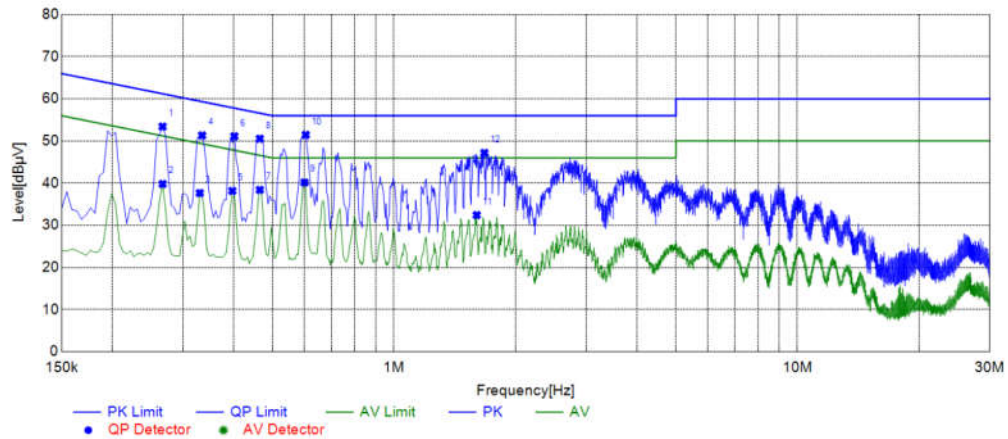

Suspected List

NO.	Frequency [MHz]	Reading [dBµV]	Factor [dB]	Result [dBµV]	Limit [dBµV]	Margin [dB]	Detector	Line	Remark
1	0.2670	43.42	10.00	53.42	61.21	7.79	PK	L1	PASS
2	0.2670	29.82	10.00	39.82	51.21	11.39	AV	L1	PASS
3	0.3300	27.67	9.99	37.66	49.45	11.79	AV	L1	PASS
4	0.3345	41.34	9.99	51.33	59.34	8.01	PK	L1	PASS
5	0.3975	28.13	10.03	38.16	47.91	9.75	AV	L1	PASS
6	0.4020	41.09	10.03	51.12	57.81	6.69	PK	L1	PASS
7	0.4650	28.36	10.05	38.41	46.60	8.19	AV	L1	PASS
8	0.4650	40.50	10.05	50.55	56.60	6.05	PK	L1	PASS
9	0.6000	30.09	10.06	40.15	46.00	5.85	AV	L1	PASS
10	0.6045	41.39	10.06	51.45	56.00	4.55	PK	L1	PASS
11	1.6035	22.31	10.12	32.43	46.00	13.57	AV	L1	PASS
12	1.6755	37.04	10.13	47.17	56.00	8.83	PK	L1	PASS

Note:1. Result (dBµV) = Reading (dBµV) + Factor (dB).

2. Factor (dB) = Cable loss (dB) + LISN Factor (dB).

Power supply:	AC 120V/60Hz(adapter)	Polarization	N
---------------	-----------------------	--------------	---

Test Graph

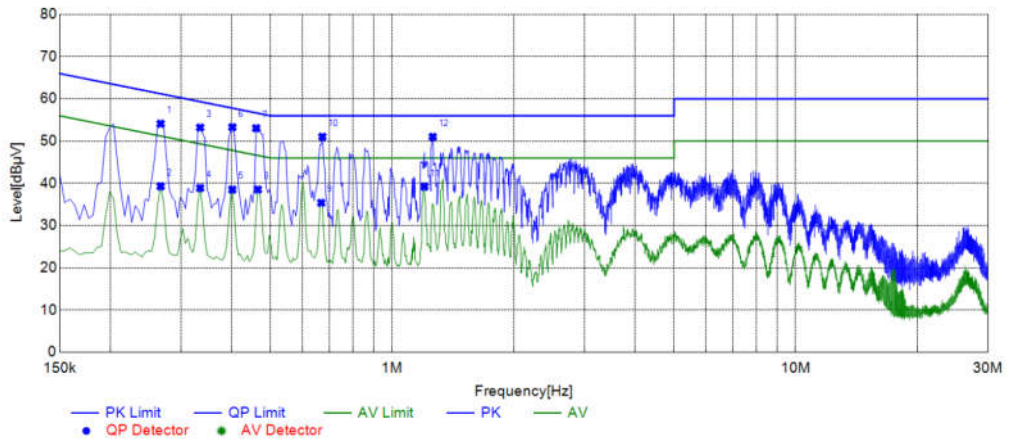

Suspected List

NO.	Frequency [MHz]	Reading [dBµV]	Factor [dB]	Result [dBµV]	Limit [dBµV]	Margin [dB]	Detector	Line	Remark
1	0.2670	44.13	10.00	54.13	61.21	7.08	PK	N	PASS
2	0.2670	29.30	10.00	39.30	51.21	11.91	AV	N	PASS
3	0.3345	43.22	9.99	53.21	59.34	6.13	PK	N	PASS
4	0.3345	28.91	9.99	38.90	49.34	10.44	AV	N	PASS
5	0.4020	28.48	10.03	38.51	47.81	9.30	AV	N	PASS
6	0.4020	43.25	10.03	53.28	57.81	4.53	PK	N	PASS
7	0.4605	43.01	10.05	53.06	56.68	3.62	PK	N	PASS
8	0.4650	28.50	10.05	38.55	46.60	8.05	AV	N	PASS
9	0.6675	25.34	10.05	35.39	46.00	10.61	AV	N	PASS
10	0.6720	40.97	10.05	51.02	56.00	4.98	PK	N	PASS
11	1.2030	29.13	10.09	39.22	46.00	6.78	AV	N	PASS
12	1.2615	40.91	10.09	51.00	56.00	5.00	PK	N	PASS

Note:1. Result (dBµV) = Reading (dBµV) + Factor (dB).
 2. Factor (dB) = Cable loss (dB) + LISN Factor (dB).

4.2 Radiated Emissions

Limit

The maximum emissions outside of the frequency bands of operation shall be attenuated in accordance with the following limits:

- (1) For transmitters operating in the 5.15-5.25 GHz band: All emissions outside of the 5.15-5.35 GHz band shall not exceed an e.i.r.p. of -27 dBm/MHz.
- (2) For transmitters operating in the 5.25-5.35 GHz band: All emissions outside of the 5.15-5.35 GHz band shall not exceed an e.i.r.p. of -27 dBm/MHz.
- (3) For transmitters operating in the 5.47-5.725 GHz band: All emissions outside of the 5.47-5.725 GHz band shall not exceed an e.i.r.p. of -27 dBm/MHz.
- (4) For transmitters operating in the 5.725-5.85 GHz band: All emissions shall be limited to a level of -27 dBm/MHz at 75 MHz or more above or below the band edge increasing linearly to 10 dBm/MHz at 25 MHz above or below the band edge, and from 25 MHz above or below the band edge increasing linearly to a level of 15.6 dBm/MHz at 5 MHz above or below the band edge, and from 5 MHz above or below the band edge increasing linearly to a level of 27 dBm/MHz at the band edge.

Undesirable emission limits

Requirement	Limit(EIRP)	Limit (Field strength at 3m) <small>Note1</small>
15.407(b)(1)	PK:-27(dBm/MHz)	PK:68.2(dBµV/m)
15.407(b)(2)		
15.407(b)(3)		
15.407(b)(4)		

Note1: The following formula is used to convert the equipment isotropic radiated power (eirp) to field strength:

$$E = \frac{1000000\sqrt{30P}}{3} \mu\text{V/m, where P is the eirp (Watts)}$$

- (5) Unwanted emissions below 1 GHz must comply with the general field strength limits set forth in §15.209
- (6) In addition, radiated emissions which fall in the restricted bands, as defined in §15.205(a), must also comply with the radiated emission limits specified in §15.209(a)

Radiated emission limits

Frequency (MHz)	Distance (Meters)	Radiated (dBµV/m)	Radiated (µV/m)
0.009-0.49	3	20log(2400/F(KHz))+40log(300/3)	2400/F(KHz)
0.49-1.705	3	20log(24000/F(KHz))+ 40log(30/3)	24000/F(KHz)
1.705-30	3	20log(30)+ 40log(30/3)	30
30-88	3	40.0	100
88-216	3	43.5	150
216-960	3	46.0	200
Above 960	3	54.0	500

TEST CONFIGURATION

(A) Radiated Emission Test Set-Up, Frequency Below 30MHz

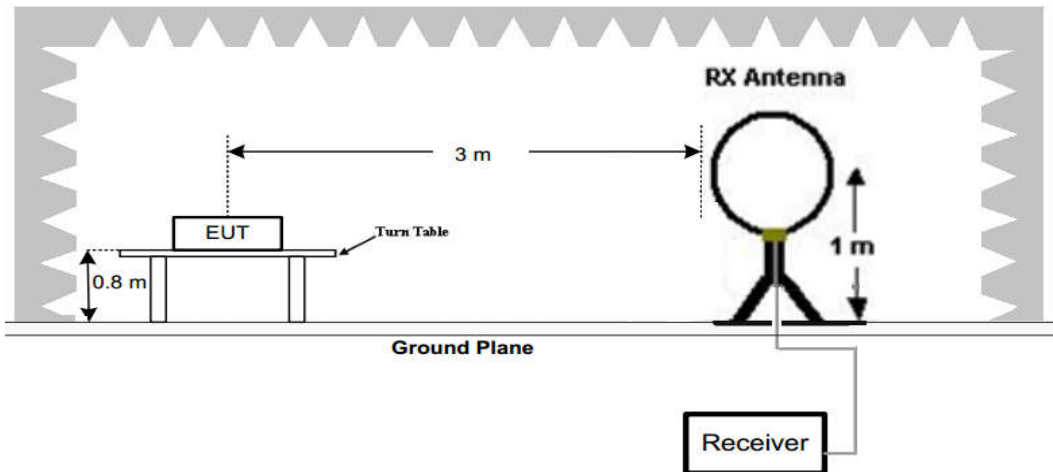

(B) Radiated Emission Test Set-Up, Frequency below 1000MHz

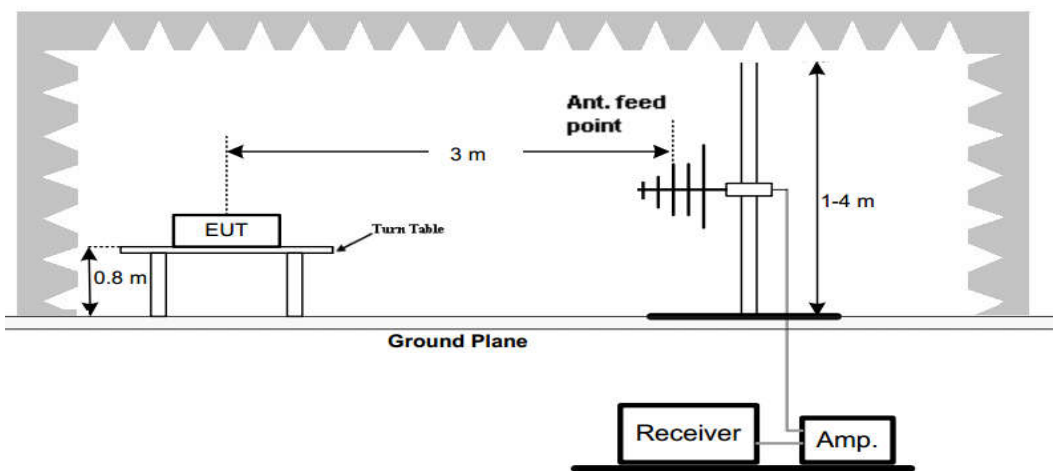

(C) Radiated Emission Test Set-Up, Frequency above 1000MHz

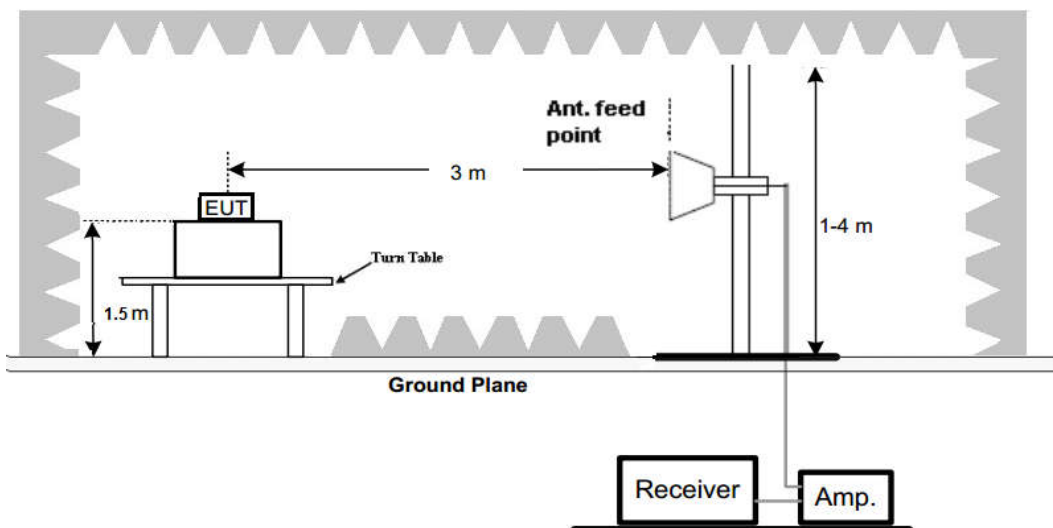

Test Procedure

- Below 1GHz measurement the EUT is placed on a turntable which is 0.8m above ground plane, and above 1GHz measurement EUT was placed on a low permittivity and low loss tangent turn table which is 1.5m above ground plane.
- Maximum procedure was performed by raising the receiving antenna from 1m to 4m and rotating the turn table from 0° to 360° to acquire the highest emissions from EUT
- And also, each emission was to be maximized by changing the polarization of receiving antenna both horizontal and vertical.
- Repeat above procedures until all frequency measurements have been completed.
- Radiated emission test frequency band from 9KHz to 40GHz.
- The distance between test antenna and EUT as following table states:

Test Frequency range	Test Antenna Type	Test Distance
9KHz-30MHz	Active Loop Antenna	3
30MHz-1GHz	Bilog Antenna	3
1GHz-18GHz	Horn Antenna	3
18GHz-25GHz	Horn Antenna	1

- Setting test receiver/spectrum as following table states:

Test Frequency range	Test Receiver/Spectrum Setting	Detector
9KHz-150KHz	RBW=200Hz/VBW=3KHz, Sweep time=Auto	QP
150KHz-30MHz	RBW=9KHz/VBW=100KHz, Sweep time=Auto	QP
30MHz-1GHz	RBW=120KHz/VBW=1000KHz, Sweep time=Auto	QP
1GHz-40GHz	Peak Value: RBW=1MHz/VBW=3MHz, Sweep time=Auto Average Value: RBW=1MHz/VBW=10Hz, Sweep time=Auto	Peak

TEST RESULTS

Temperature	22.8°C	Humidity	56%
Test Engineer	Moon Tan	Configurations	WLAN 5G

Remark:

- This test was performed with EUT in X, Y, Z position and the worse case was found when EUT in X position.
- All 802.11a / 802.11n (HT20) / 802.11n (HT40) modes have been tested for below 1GHz test, only the worst case 802.11a low channel of U-NII 1 band was recorded.
- All 802.11a / 802.11n (HT20) / 802.11n (HT40) modes have been tested for above 1GHz test, only the worst case 802.11a was recorded.
- Radiated emission test from 9 KHz to 10th harmonic of fundamental was verified, and no emission found except system noise floor in 9 KHz to 30MHz and not recorded in this report

For 30MHz-1GHz

Horizontal

Test Graph

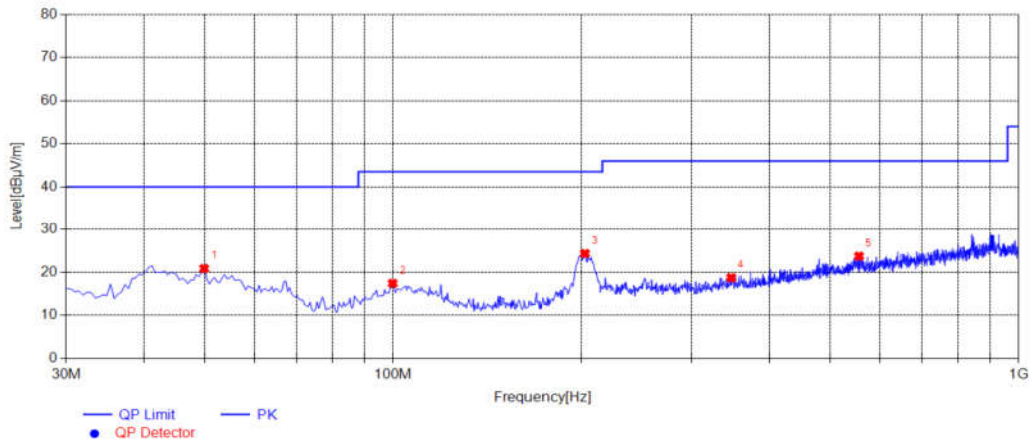

Suspected List

NO.	Frequency [MHz]	Reading [dBµV/m]	Factor [dB]	Result [dBµV/m]	Limit [dBµV/m]	Margin [dB]	Height [cm]	Angle [°]	Detector	Polarity	Remark
1	49.8850	27.46	-6.58	20.88	40.00	19.12	100	310	PK	Horizontal	PASS
2	99.8400	25.92	-8.49	17.43	43.50	26.07	100	350	PK	Horizontal	PASS
3	202.6600	33.64	-9.29	24.35	43.50	19.15	100	10	PK	Horizontal	PASS
4	347.1900	24.72	-5.99	18.73	46.00	27.27	100	40	PK	Horizontal	PASS
5	555.7400	26.63	-2.89	23.74	46.00	22.26	100	290	PK	Horizontal	PASS

Vertical

Test Graph

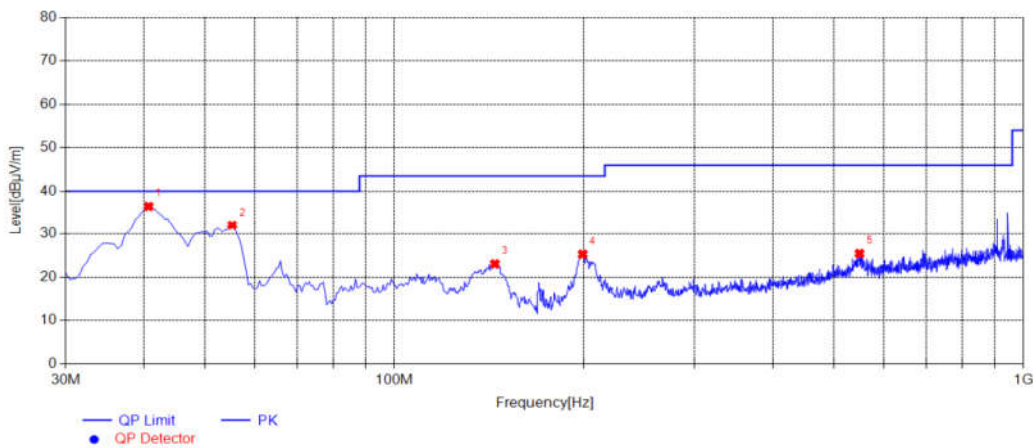

Suspected List

NO.	Frequency [MHz]	Reading [dBµV/m]	Factor [dB]	Result [dBµV/m]	Limit [dBµV/m]	Margin [dB]	Height [cm]	Angle [°]	Detector	Polarity	Remark
1	40.6700	43.83	-7.32	36.51	40.00	3.49	100	320	PK	Vertical	PASS
2	55.2200	39.52	-7.41	32.11	40.00	7.89	100	30	PK	Vertical	PASS
3	144.4600	35.54	-12.48	23.06	43.50	20.44	100	190	PK	Vertical	PASS
4	199.2650	34.44	-9.14	25.30	43.50	18.20	100	240	PK	Vertical	PASS
5	548.9500	28.50	-3.05	25.45	46.00	20.55	100	260	PK	Vertical	PASS

Note:1. Result (dBµV/m) = Reading(dBµV/m) + Factor (dB) .

2. Factor (dB) = Antenna Factor (dB/m) + Cable loss (dB) - Pre Amplifier gain (dB).

For 1GHz to 25GHz

Note: All 802.11a / 802.11n (HT20) /802.11n (HT40) modes have been tested for above 1GHz test, only the worst case 802.11a was recorded.

U-NII 1 & 802.11a Mode (above 1GHz)

Tested Channel	Frequency (MHz)	Emission Level (dBuV/m)	Detector Mode	ANT Pol	Limit (dBuV/m)	Margin (dB)	Raw Value (dBuV)	Antenna Factor (dB/m)	Cable Factor (dB)	Pre amplifier (dB)	Correction Factor (dB/m)
36.00 (5180MHz)	5150.00	55.35	PK	H	68.20	12.85	48.07	34.44	7.12	34.28	7.28
	5150.00	45.91	AV	H	54.00	8.09	38.63	34.44	7.12	34.28	7.28
	10360.00	50.47	PK	H	68.20	17.73	34.74	39.20	11.45	34.92	15.73
	--	--	--	--	--	--	--	--	--	--	--
40.00 (5200MHz)	10400.00	50.95	PK	H	68.20	17.25	35.14	39.22	11.48	34.89	15.81
	--	--	--	--	--	--	--	--	--	--	--
48.00 (5240MHz)	5350.50	46.63	PK	H	68.20	21.57	39.60	34.23	7.36	34.56	7.03
	10480.00	49.91	PK	H	68.20	18.29	32.76	39.41	11.83	34.09	17.15
	--	--	--	--	--	--	--	--	--	--	--

Tested Channel	Frequency (MHz)	Emission Level (dBuV/m)	Detector Mode	ANT Pol	Limit (dBuV/m)	Margin (dB)	Raw Value (dBuV)	Antenna Factor (dB/m)	Cable Factor (dB)	Pre amplifier (dB)	Correction Factor (dB/m)
36.00 (5180MHz)	5150.00	53.23	PK	V	68.20	14.97	45.95	34.44	7.12	34.28	7.28
	5150.00	46.71	AV	V	54.00	7.29	39.43	34.44	7.12	34.28	7.28
	10360.00	51.07	PK	V	68.20	17.13	35.34	39.20	11.45	34.92	15.73
	--	--	--	--	--	--	--	--	--	--	--
40.00 (5200MHz)	10400.00	50.14	PK	V	68.20	18.06	34.33	39.22	11.48	34.89	15.81
	--	--	--	--	--	--	--	--	--	--	--
48.00 (5240MHz)	5350.50	50.20	PK	V	68.20	18.00	43.17	34.23	7.36	34.56	7.03
	10480.00	51.95	PK	V	68.20	16.25	34.80	39.41	11.83	34.09	17.15
	--	--	--	--	--	--	--	--	--	--	--

U-NII 3 & 802.11a Mode (above 1GHz)

Tested Channel	Frequency (MHz)	Emission Level (dBuV/m)	Detector Mode	ANT Pol	Limit (dBuV/m)	Margin (dB)	Raw Value (dBuV)	Antenna Factor (dB/m)	Cable Factor (dB)	Pre amplifier (dB)	Correction Factor (dB/m)
	5720.00	50.52	PK	H	68.20	17.68	43.24	34.44	7.12	34.28	7.28
149.00 (5745MHz)	5720.00	46.69	AV	H	54.00	7.31	35.18	37.64	9.28	35.41	11.51
	11490.00	49.61	PK	H	68.20	18.59	31.35	39.69	12.90	34.33	18.26
	--	--	--	--	--	--	--	--	--	--	--
157.00 (5785MHz)	11570.00	50.07	PK	H	68.20	18.13	31.62	39.71	13.05	34.31	18.45
	--	--	--	--	--	--	--	--	--	--	--
48.00 (5825MHz)	5855.00	50.61	PK	H	68.20	17.59	39.07	37.64	9.28	35.38	11.54
	11650.00	51.13	PK	H	68.20	17.07	32.51	39.73	13.19	34.30	18.62
	--	--	--	--	--	--	--	--	--	--	--

Tested Channel	Frequency (MHz)	Emission Level (dBuV/m)	Detector Mode	ANT Pol	Limit (dBuV/m)	Margin (dB)	Raw Value (dBuV)	Antenna Factor (dB/m)	Cable Factor (dB)	Pre amplifier (dB)	Correction Factor (dB/m)
	5720.00	51.38	PK	V	68.20	16.82	44.10	34.44	7.12	34.28	7.28
149.00 (5745MHz)	5720.00	46.39	AV	V	54.00	7.61	34.88	37.64	9.28	35.41	11.51
	11490.00	48.80	PK	V	68.20	19.40	30.54	39.69	12.90	34.33	18.26
	--	--	--	--	--	--	--	--	--	--	--
157.00 (5785MHz)	11570.00	50.45	PK	V	68.20	17.75	32.00	39.71	13.05	34.31	18.45
	--	--	--	--	--	--	--	--	--	--	--
48.00 (5825MHz)	5855.00	51.59	PK	V	68.20	16.61	40.05	37.64	9.28	35.38	11.54
	11650.00	52.15	PK	V	68.20	16.05	33.53	39.73	13.19	34.30	18.62
	--	--	--	--	--	--	--	--	--	--	--

REMARKS:

1. Emission level (dBuV/m) =Raw Value (dBuV)+Correction Factor (dB/m)
2. Correction Factor (dB/m) = Antenna Factor (dB/m)+Cable Factor (dB)-Pre-amplifier Factor
3. Margin value = Limit value- Emission level.
4. -- Mean the other emission levels were very low against the limit.
5. RBW1MHz VBW3MHz Peak detector is for PK value; RBW 1MHz VBW10Hz Peak detector is

for AV value.

6. Worst case data at 6Mbps at IEEE 802.11a; MCS0 at IEEE 802.11n HT20, IEEE 802.11n HT40, IEEE 802.11ac VHT20 ,IEEE 802.11ac VHT40 and IEEE 802.11ac VHT80;

4.3 Maximum Conducted Average Output Power

Limit

For the band 5.15-5.25 GHz.

(i) For an outdoor access point operating in the band 5.15-5.25 GHz, the maximum conducted output power over the frequency band of operation shall not exceed 1 W provided the maximum antenna gain does not exceed 6 dBi.

(ii) For an indoor access point operating in the band 5.15-5.25 GHz, the maximum conducted output power over the frequency band of operation shall not exceed 1 W provided the maximum antenna gain does not exceed 6 dBi.

(iii) For fixed point-to-point access points operating in the band 5.15-5.25 GHz, the maximum conducted output power over the frequency band of operation shall not exceed 1 W.

(iv) For client devices in the 5.15-5.25 GHz band, the maximum conducted output power over the frequency band of operation shall not exceed 250 mW provided the maximum antenna gain does not exceed 6 dBi.

For the 5.25-5.35 GHz and 5.47-5.725 GHz bands, the maximum conducted output power over the frequency bands of operation shall not exceed the lesser of 250 mW or $11 \text{ dBm} + 10 \log B$, where B is the 26 dB emission bandwidth in megahertz.

For the band 5.725-5.85 GHz, the maximum conducted output power over the frequency band of operation shall not exceed 1 W

Test Procedure

Remove the antenna from the EUT and then connect a low loss RF cable from the antenna port to the power sensor.

Test Configuration

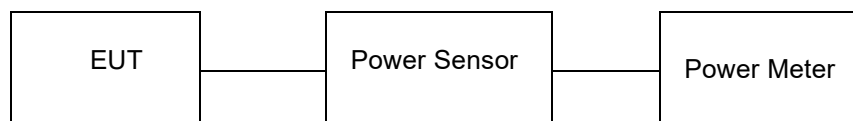

Test Results

Temperature	22.8°C	Humidity	56%
Test Engineer	Moon Tan	Configurations	WLAN 5G

U-NII 1

Type	Channel	Output power (dBm)	Limit (dBm)	Result
802.11a	36	7.00	23.98	Pass
	40	6.60		
	48	6.54		
802.11n(HT20)	36	6.85	23.98	Pass
	40	6.45		
	48	6.38		
802.11n(HT40)	38	7.47	23.98	Pass
	46	7.21		
802.11ac(HT20)	36	6.88	23.98	Pass
	40	6.55		
	48	6.39		
802.11ac(HT40)	38	7.49	23.98	Pass
	46	7.16		
802.11ac(HT80)	42	7.10	23.98	Pass

U-NII 3

Type	Channel	Output power (dBm)	Limit (dBm)	Result
802.11a	149	7.44	30.00	Pass
	157	6.89		
	165	6.72		
802.11n(HT20)	149	7.32	30.00	Pass
	157	6.78		
	165	6.57		
802.11n(HT40)	151	7.21	30.00	Pass
	159	7.27		
802.11ac(HT20)	149	7.45	30.00	Pass
	157	6.78		
	165	6.61		
802.11ac(HT40)	151	7.30	30.00	Pass
	159	7.23		
802.11ac(HT80)	155	6.98	30.00	Pass

4.4 Power Spectral Density

Limit

(1) For the band 5.15 - 5.25 GHz.

(i) For an outdoor access point operating in the band 5.15 - 5.25 GHz, the maximum power spectral density shall not exceed 17 dBm in any 1 MHz band.^{note1}

(ii) For an indoor access point operating in the band 5.15 - 5.25 GHz, the maximum power spectral density shall not exceed 17 dBm in any 1 MHz band.^{note1}

(iii) For fixed point-to-point access points operating in the band 5.15 - 5.25 GHz, transmitters that employ a directional antenna gain greater than 23 dBi, a 1 dB reduction in maximum power spectral density is required for each 1 dB of antenna gain in excess of 23 dBi.

(iv) For mobile and portable client devices in the 5.15 - 5.25 GHz band, the maximum power spectral density shall not exceed 11 dBm in any 1 MHz band.^{note1}

(2) For the 5.25 - 5.35 GHz and 5.47 - 5.725 GHz bands, the peak power spectral density shall not exceed 11 dBm in any 1 MHz band.^{note1}

(3) For the band 5.725 - 5.85 GHz, the maximum power spectral density shall not exceed 30 dBm in any 500 kHz band.^{note1, note2}

Note1: If transmitting antennas of directional gain greater than 6 dBi are used, the peak power spectral density shall be reduced by the amount in dB that the directional gain of the antenna exceeds 6 dBi.

Note2: Fixed point - to-point U-NII devices operating in this band may employ transmitting antennas with directional gain greater than 6 dBi without any corresponding reduction in transmitter conducted power. Fixed, point-to-point operations exclude the use of point-to-multipoint systems, omnidirectional applications, and multiple collocated transmitters transmitting the same information.

Test Procedure

1. Use this procedure when the maximum peak conducted output power in the fundamental emission is used to demonstrate compliance.
2. Set the RBW = 1MHz for U-NII 1, U-NII 2A, U-NII C band and 510KHz for U-NII 3 band.
3. Set the VBW $\geq 3 \times$ RBW.
4. Set the span to encompass the entire EBW.
5. Detector = peak.
6. Sweep time = auto couple.
7. Trace mode = max hold.
8. Allow trace to fully stabilize.
9. Use the peak marker function to determine the maximum power level.

Test Configuration

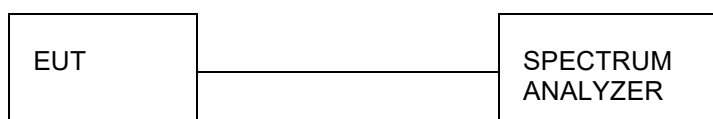

Test Results

Temperature	22.8°C	Humidity	56%
Test Engineer	Moon Tan	Configurations	WLAN 5G

Type	Bands	Channel	Power Spectral Density (dBm/MHz)	Limit (dBm/MHz)	Result
802.11a	U-NII 1	36	-3.51	11	Pass
		40	-3.86		
		48	-3.95		
802.11n (HT20)	U-NII 1	36	-4.00		
		40	-4.47		
		48	-4.48		
802.11n (HT40)	U-NII 1	38	-6.14		
		46	-6.40		
802.11ac (HT20)	U-NII 1	36	-3.86		
		40	-4.04		
		48	-4.36		
802.11ac (HT40)	U-NII 1	38	-6.32		
		46	-6.61		
802.11ac (HT80)	U-NII 1	42	-10.06		

Type	Bands	Channel	Power Spectral Density (dBm/500KHz)	Limit (dBm/500KHz)	Result
802.11a	U-NII 3	149	-5.24	30	Pass
		157	-6.24		
		165	-6.28		
802.11n (HT20)	U-NII 3	149	-6.06		
		157	-6.74		
		165	-6.85		
802.11n (HT40)	U-NII 3	151	-8.35		
		159	-9.35		
802.11ac (HT20)	U-NII 3	149	-5.80		
		157	-6.65		
		165	-6.89		
802.11ac (HT40)	U-NII 3	151	-8.35		
		159	-8.94		
802.11ac (HT80)	U-NII 3	155	-11.99		

Note:

1. $P.S.D(dBm/500KHz) = P.S.D(dBm/300KHz) + 10 \log(500 \text{ kHz}/300KHz)$.
2. RBW Factor is compensated in the graph.
3. Measured output power at difference data rate for each mode and recorded worst case for each mode.
4. Test results including cable loss;
5. Worst case data at 6Mbps at IEEE 802.11a; MCS0 at IEEE 802.11n HT20, IEEE 802.11n HT40, IEEE 802.11ac VHT20, IEEE 802.11ac VHT40 and IEEE 802.11ac VHT80;

Test plot as follows:

802.11a

U-NII 1

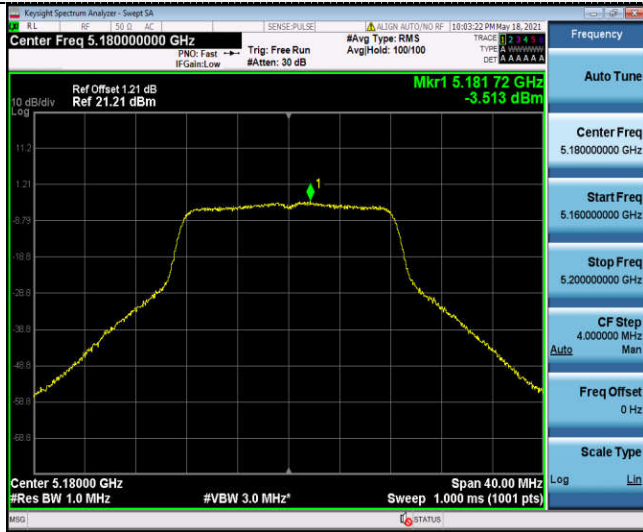

U-NII 3



CH36



CH149



CH40



CH157



CH48

CH165

802.11n(HT20)

U-NII 1



U-NII 3



CH36

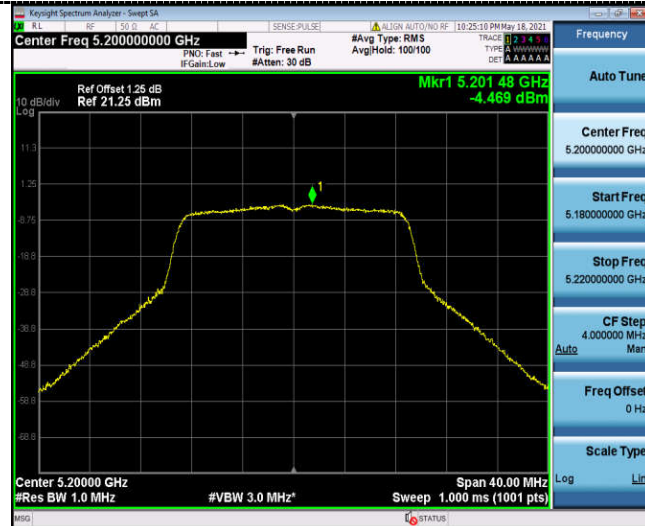

CH149

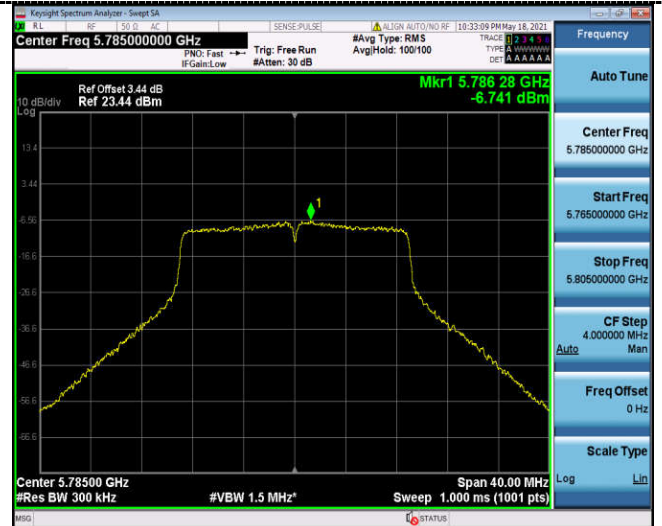

CH40



CH157



CH48

CH165

802.11n(HT40)

U-NII 1

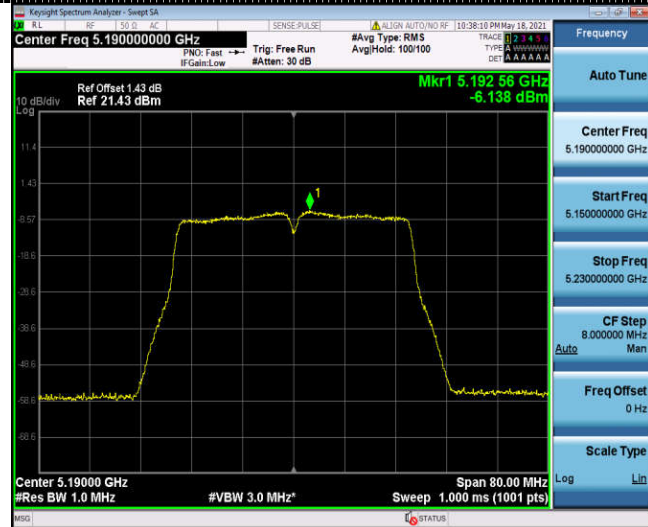

U-NII 3



CH38

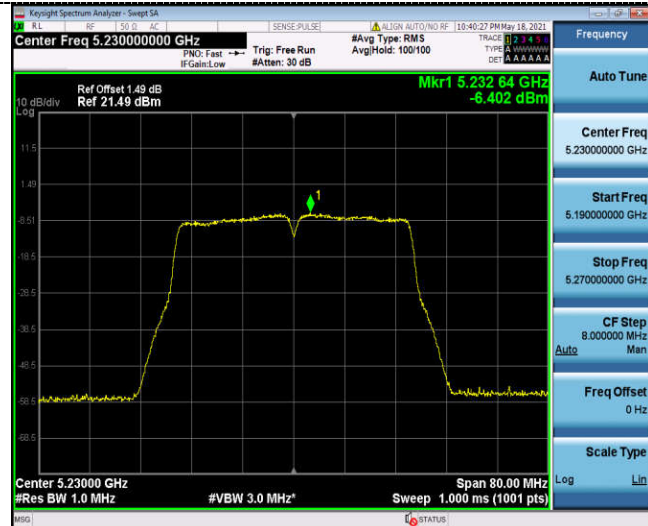

CH151

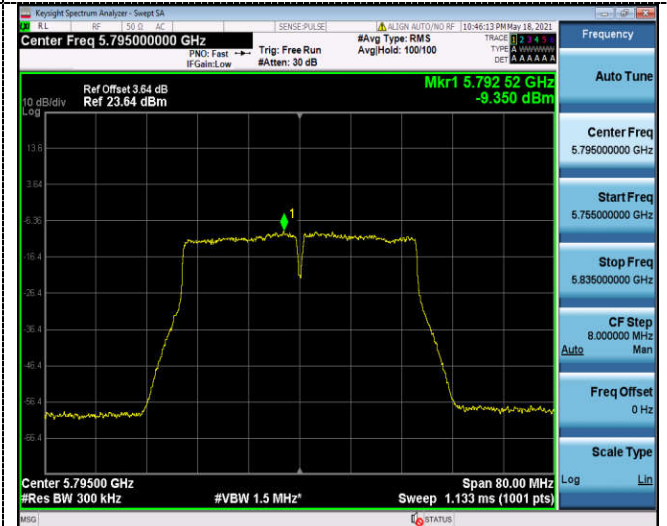

CH46

CH159

802.11ac(HT20)

U-NII 1

U-NII 3

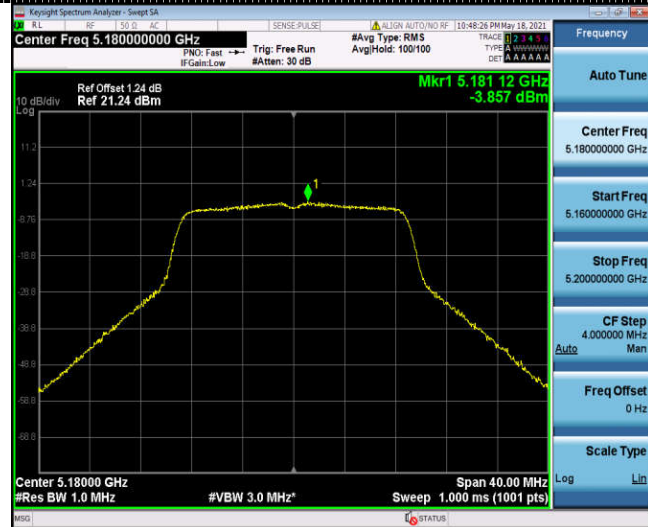

CH36

CH149

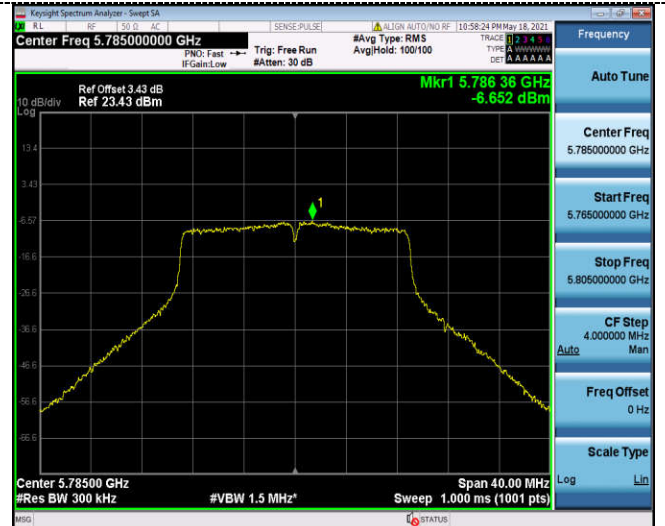

CH40

CH157



CH48

CH165

802.11ac(HT40)

U-NII 1

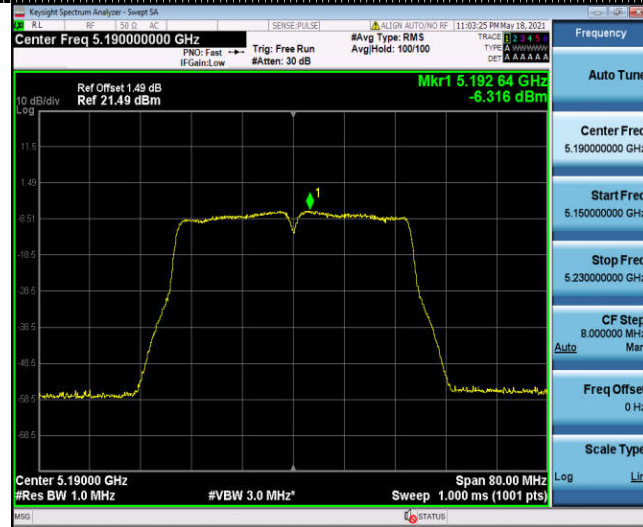

U-NII 3



CH38



CH151



CH46

CH159

802.11ac(HT80)

U-NII 1

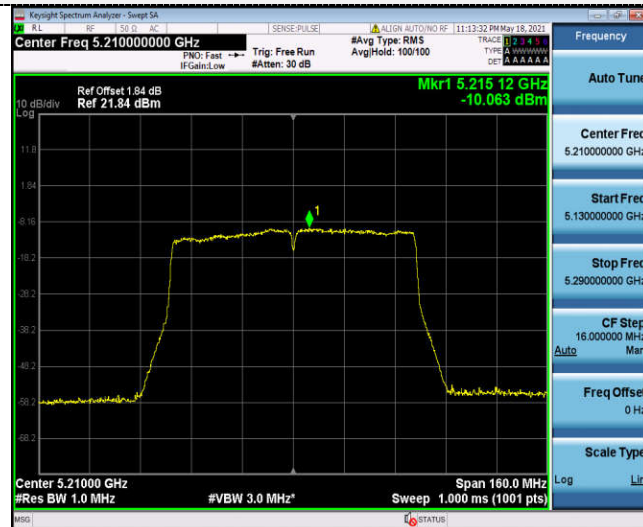

U-NII 3



CH42

CH155

4.5 Emission Bandwidth (26dBm Bandwidth)

Limit

N/A

Test Procedure

1. Set resolution bandwidth (RBW) = approximately 1 % of the EBW.
2. Set the video bandwidth (VBW) > RBW.
3. Detector = Peak.
4. Trace mode = Max hold.
5. Measure the maximum width of the emission that is 26 dB down from the peak of the emission. Compare this with the RBW setting of the analyzer. Readjust RBW and repeat measurement as needed until the RBW / EBW ratio is approximately 1 %.

Test Configuration

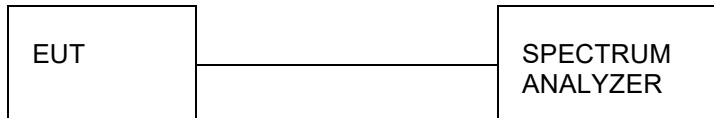

Test Results

Temperature	22.8°C	Humidity	56%
Test Engineer	Moon Tan	Configurations	WLAN 5G

Type	Bands	Channel	26dB Bandwidth (MHz)	Limit (MHz)	Result
802.11a	U-NII 1	36	22.920	N/A	Pass
		40	22.600		
		48	22.760		
802.11n(HT20)	U-NII 1	36	23.280		
		40	23.560		
		48	23.480		
802.11n(HT40)	U-NII 1	38	41.520		
		46	41.440		
802.11ac(HT20)	U-NII 1	36	23.320		
		40	23.680		
		48	22.880		
802.11ac(HT40)	U-NII 1	38	41.280		
		46	41.520		
802.11ac(HT80)	U-NII 1	42	83.040		

Test plot as follows:

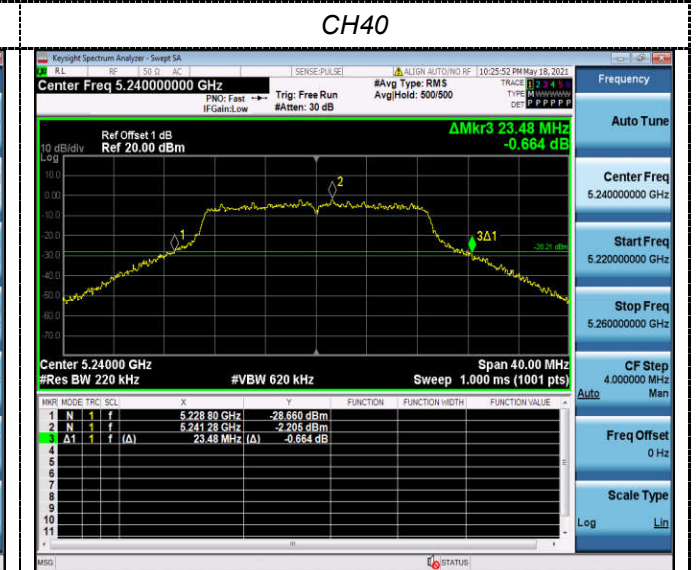
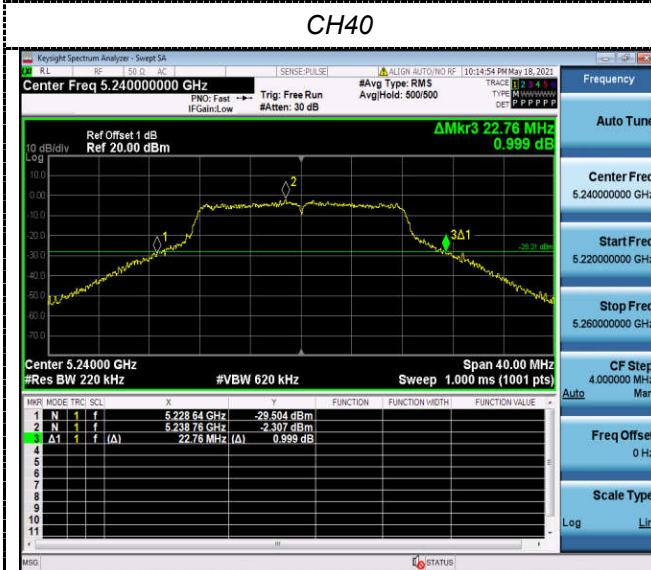
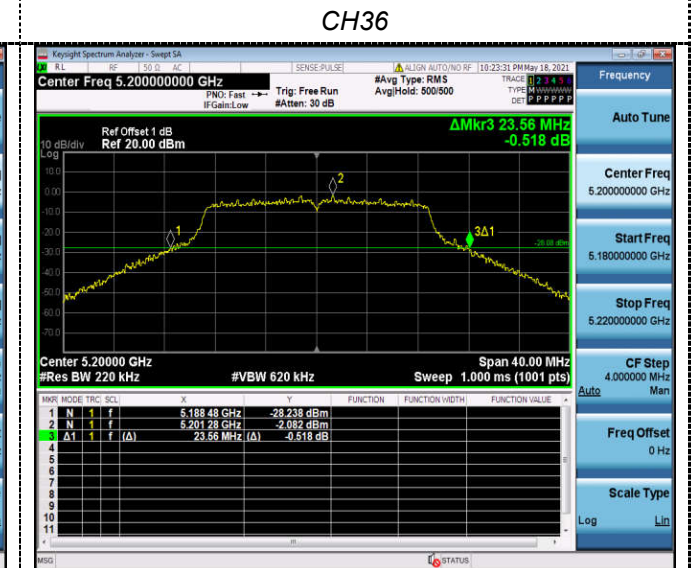
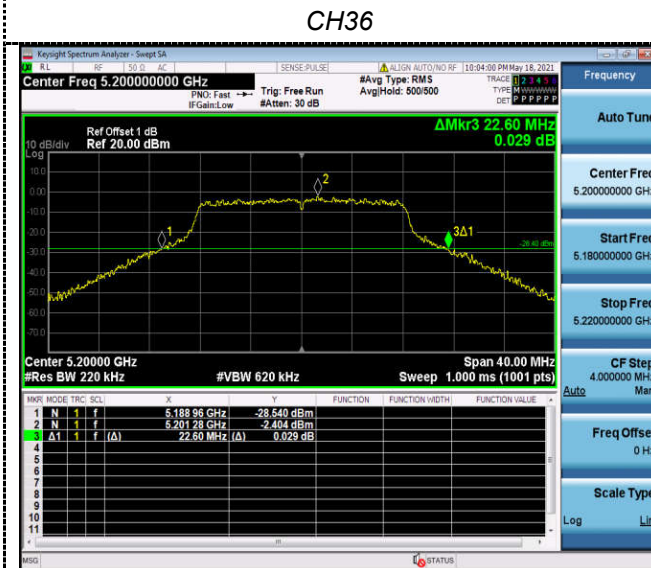
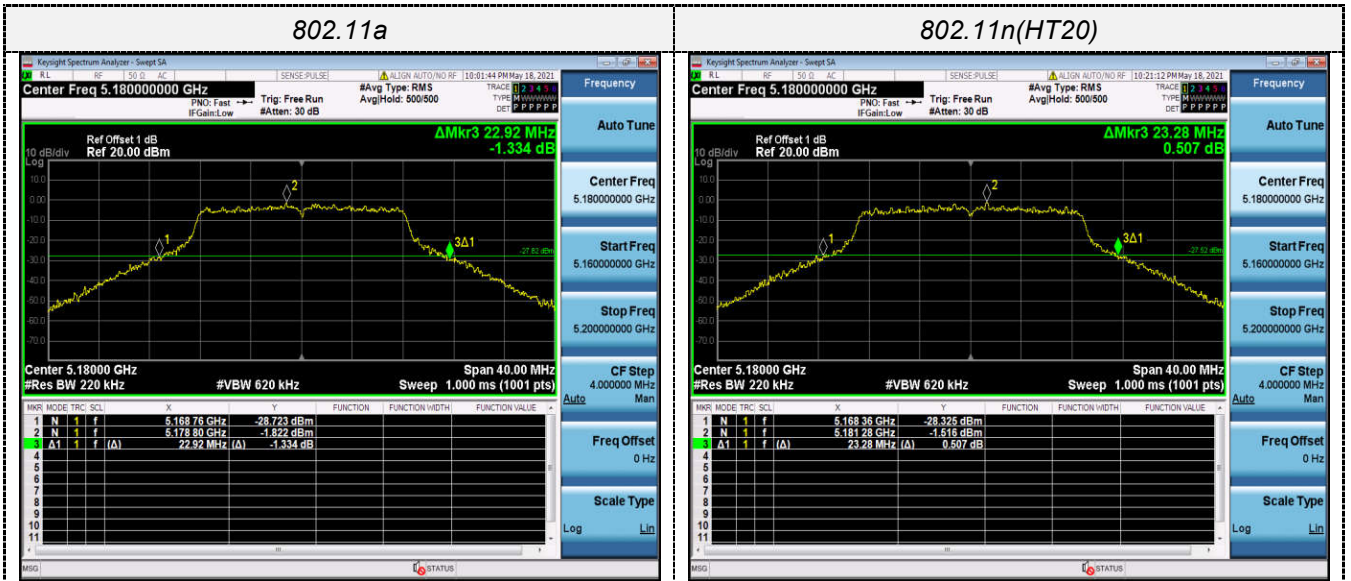

CH48

CH48

802.11n(HT40)



802.11ac(HT20)



CH38

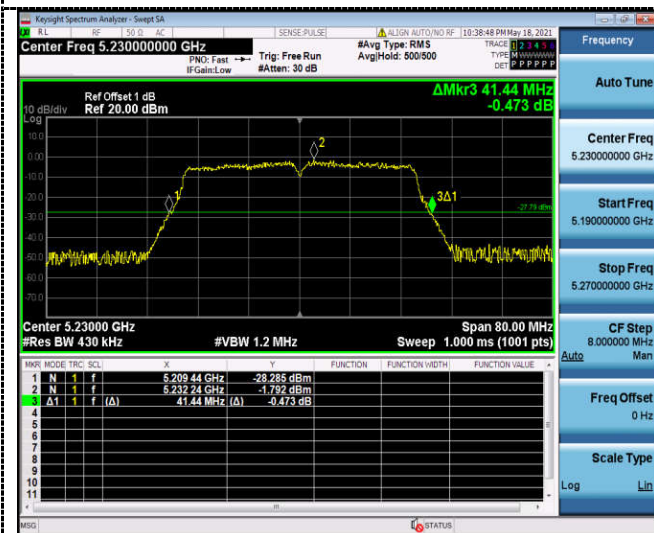

CH36

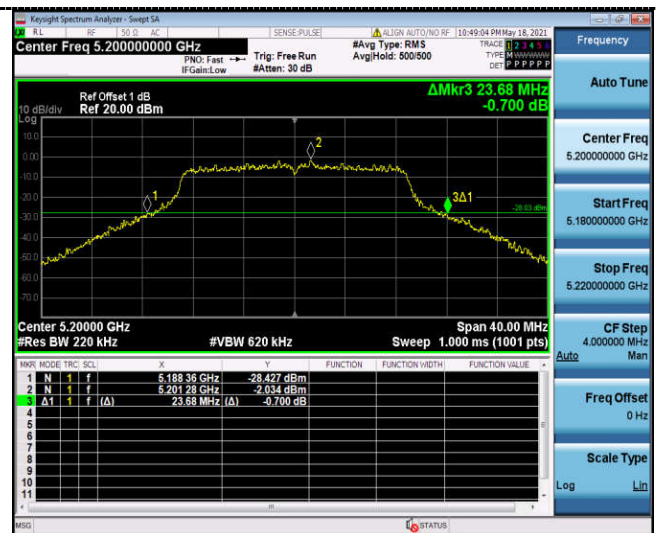

CH46

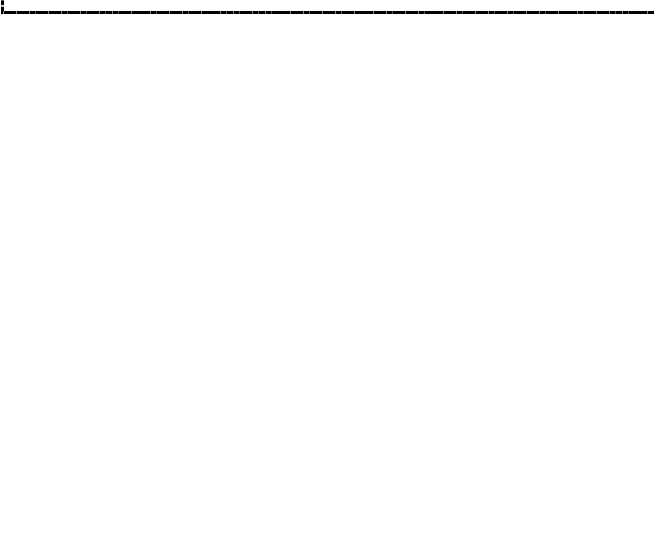

CH40

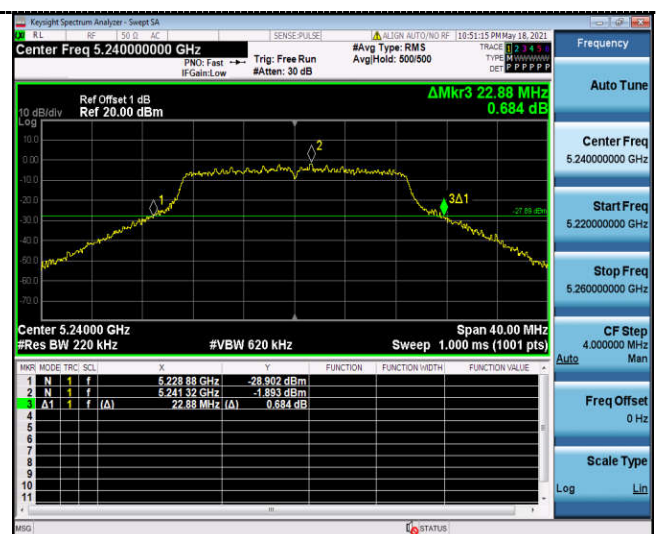

CH48

802.11ac(HT40)

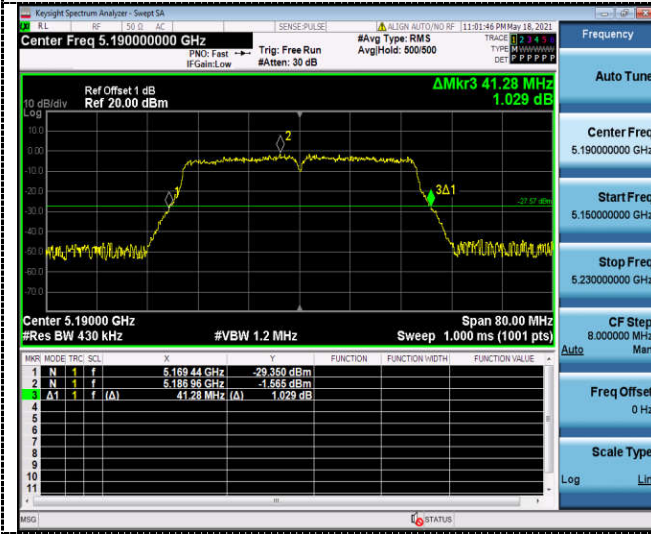

802.11ac(HT80)



CH38

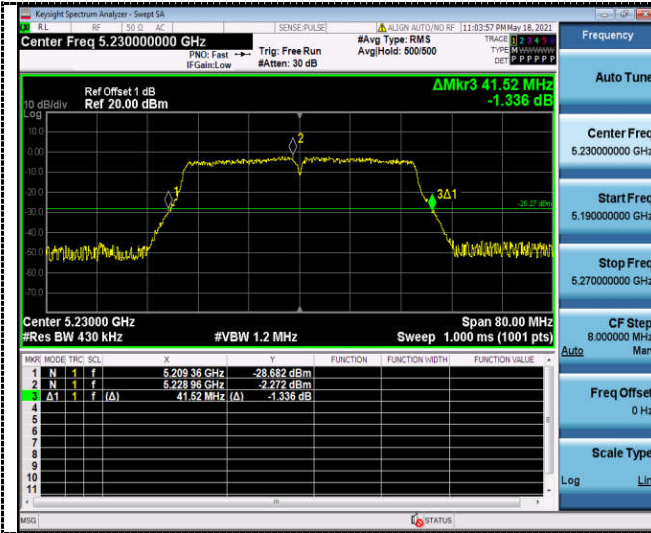

CH46

CH42

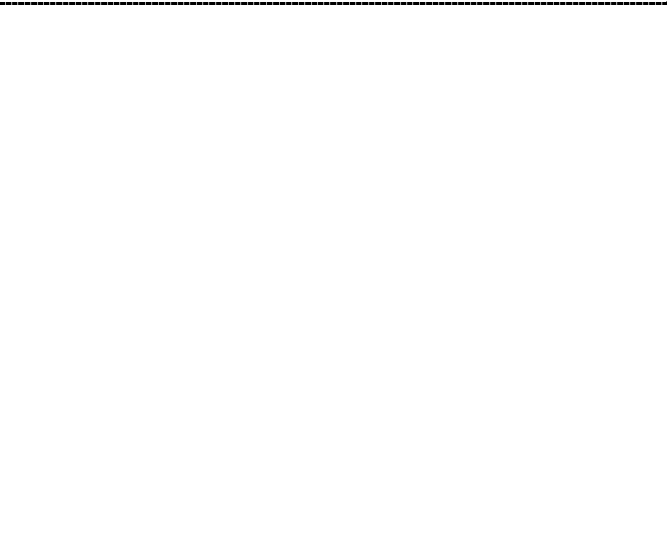

4.6 Minimum Emission Bandwidth (6dBm Bandwidth)

Limit

Within the 5.725-5.85 GHz band, the minimum 6 dB bandwidth of U-NII devices shall be at least 500 kHz.

Test Procedure

1. Set resolution bandwidth (RBW) = 100 kHz
2. Set the video bandwidth 3 x RBW.
3. Detector = Peak.
4. Trace mode = Max hold.
5. Measure the maximum width of the emission that is constrained by the frequencies associated with the two outermost amplitude points (upper and lower frequencies) that are attenuated by 6 dB relative to the maximum level measured in the fundamental emission.

Test Configuration

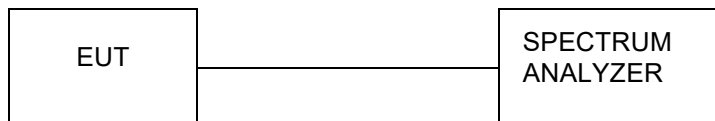

Test Results

Temperature	22.8°C	Humidity	56%
Test Engineer	Moon Tan	Configurations	WLAN 5G

Type	Bands	Channel	6dB Bandwidth (MHz)	Limit (KHz)	Result
802.11a	U-NII 3	149	15.600	≥500KHz	Pass
		157	16.320		
		165	16.040		
802.11n(HT20)	U-NII 3	149	16.200		
		157	15.800		
		165	15.480		
802.11n(HT40)	U-NII 3	151	36.160		
		159	36.080		
802.11ac(HT20)	U-NII 3	149	16.640		
		157	16.240		
		165	15.840		
802.11ac(HT40)	U-NII 3	151	36.000		
		159	36.240		
802.11ac(HT80)	U-NII 3	155	75.840		

Test plot as follows:

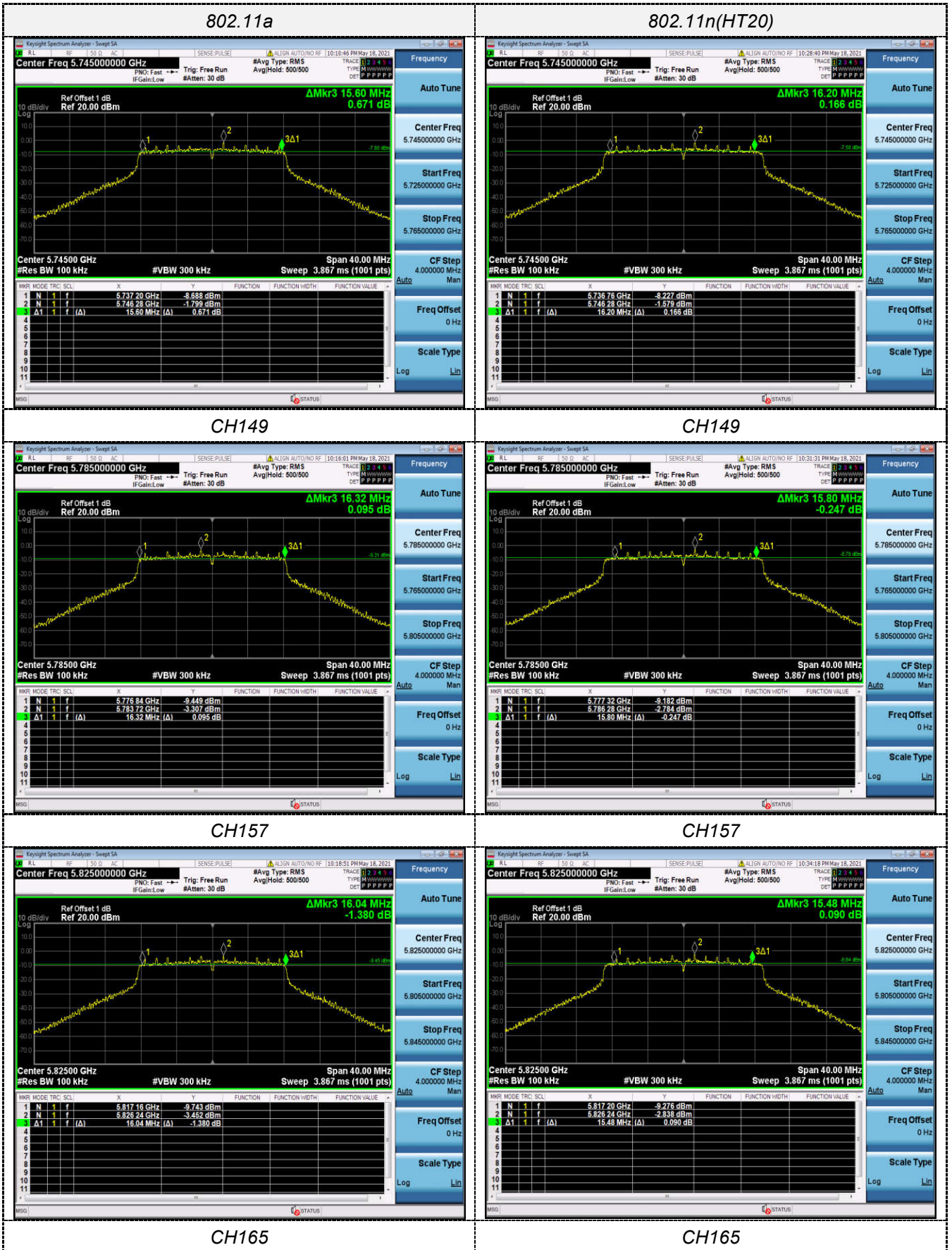

802.11n(HT40)

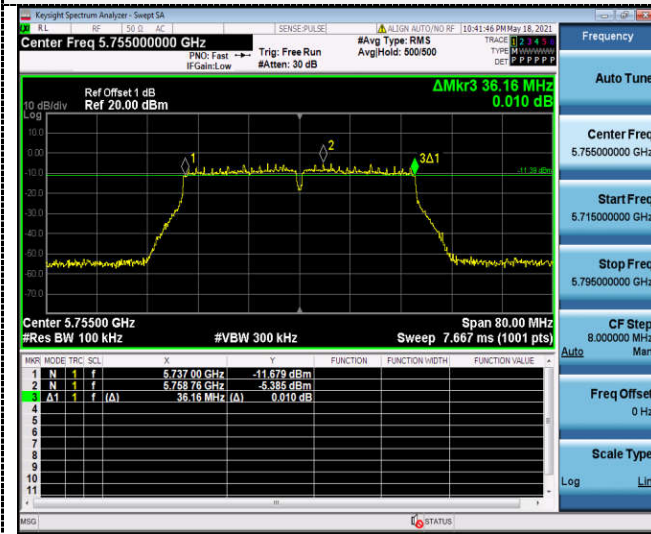

802.11ac(HT20)

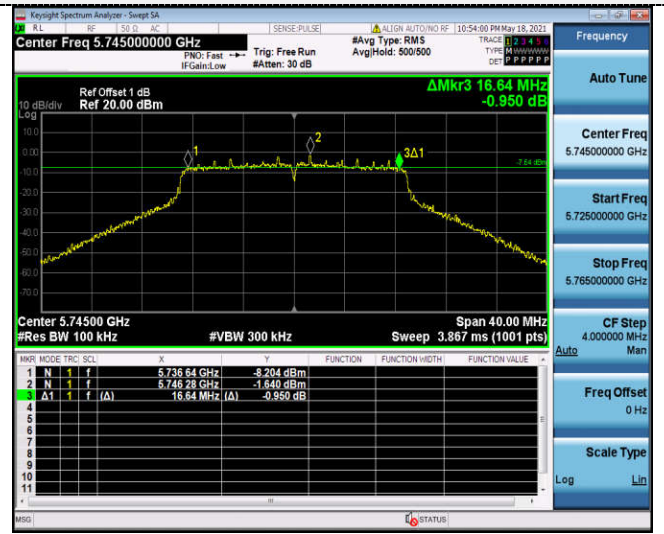

CH151

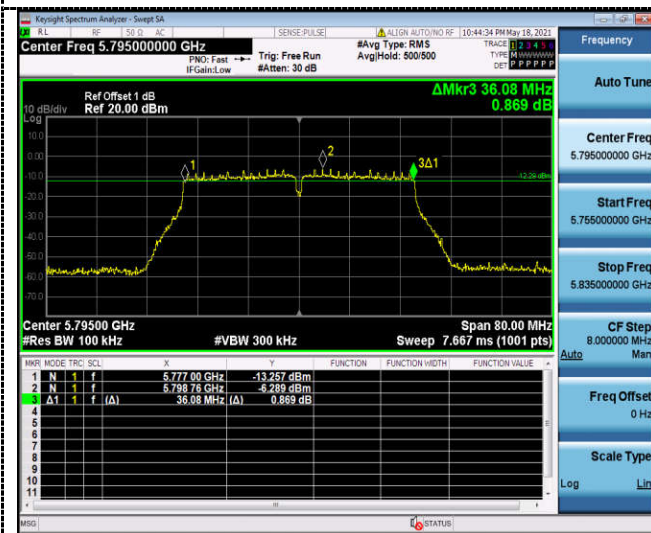

CH149



CH159

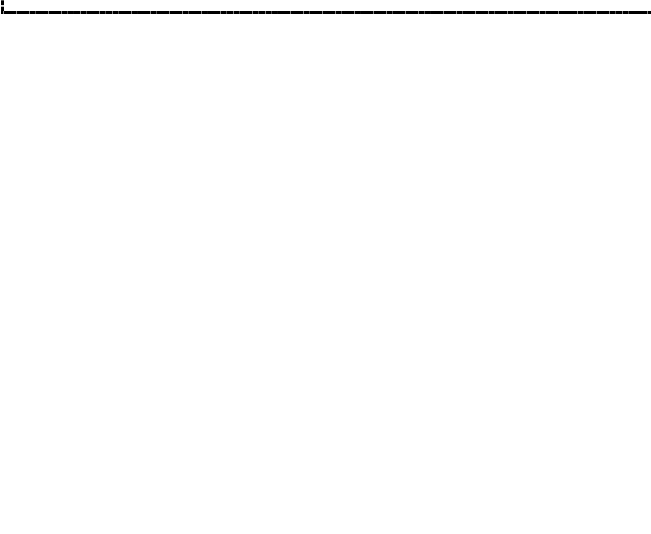

CH157



CH165



802.11ac(HT40)

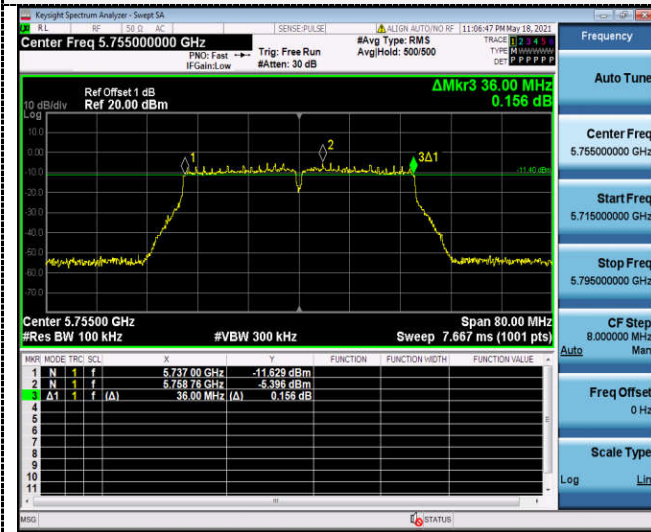

802.11ac(HT80)

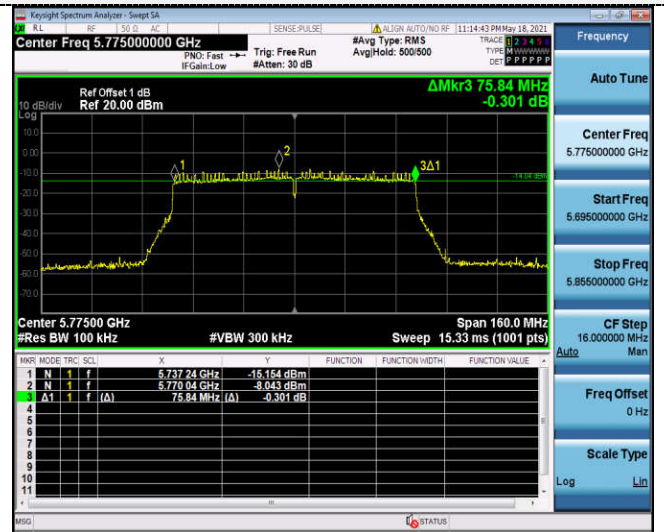

CH151

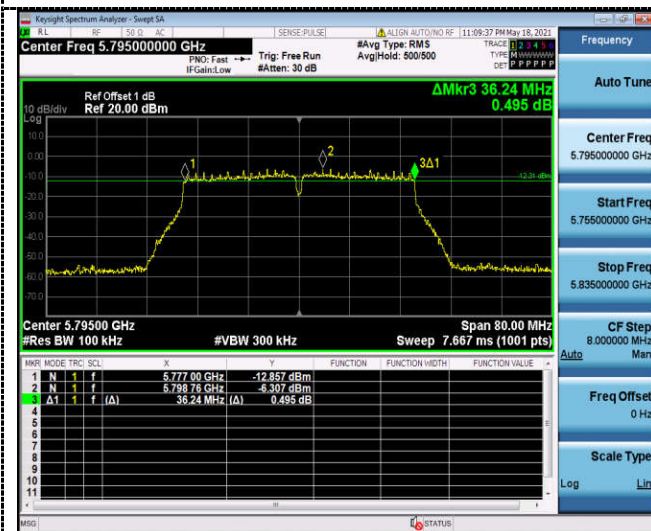

CH155



CH159



4.7 Frequency Stability

LIMIT

Manufacturers of U-NII devices are responsible for ensuring frequency stability such that an emission is maintained within the band of operation under all conditions of normal operation as specified in the users manual.

TEST CONFIGURATION

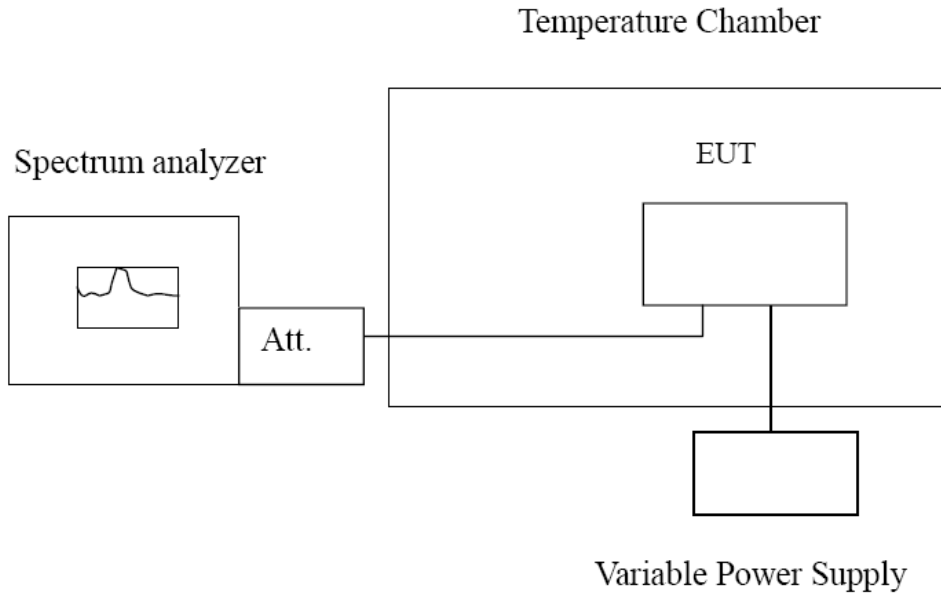

TEST PROCEDURE

Frequency Stability under Temperature Variations:

The equipment under test was connected to an external AC or DC power supply and inputted voltage. RF output was connected to a frequency counter or spectrum analyzer via feed through attenuators. The EUT was placed inside the temperature chamber. Set the spectrum analyzer RBW low enough to obtain the desired frequency resolution and measure EUT 20°C operating frequency as reference frequency. Turn EUT off and set the chamber temperature to -30°C. After the temperature stabilized for approximately 30 minutes recorded the frequency. Repeat step measure with 10°C increased per stage until the highest temperature of +50°C reached.

Frequency Stability under Voltage Variations:

Set chamber temperature to 20°C. Use a variable AC power supply / DC power source to power the EUT and set the voltage to rated voltage. Set the spectrum analyzer RBW low enough to obtain the desired frequency resolution and recorded the frequency. Reduce the input voltage to specify extreme voltage variation (± 15%) and endpoint, record the maximum frequency change.

TEST RESULTS

Temperature	22.8°C	Humidity	56%
Test Engineer	Moon Tan	Configurations	WLAN 5G

Record worst case as below:

Reference Frequency: 802.11ac channel=36 frequency=5180MHz					
Voltage (V)	Temperature (°C)	Frequency error		Limit (ppm)	Result
		Hz	ppm		
3.80	-30	98.12	0.019	Within the band of operation	Pass
	-20	87.34	0.017		
	-10	54.02	0.010		
	0	93.89	0.018		
	10	68.98	0.013		
	20	66.44	0.013		
	30	73.73	0.014		
	40	51.44	0.010		
4.37	25	69.84	0.013		
3.23	25	53.80	0.010		

Reference Frequency: 802.11ac channel=149 frequency=5745MHz					
Voltage (V)	Temperature (°C)	Frequency error		Limit (ppm)	Result
		Hz	ppm		
3.80	-30	40.04	0.007	Within the band of operation	Pass
	-20	31.23	0.005		
	-10	46.85	0.008		
	0	96.37	0.017		
	10	90.91	0.016		
	20	55.62	0.010		
	30	31.26	0.005		
	40	88.52	0.015		
4.37	25	62.24	0.011		
3.23	25	66.92	0.012		

5 Test Setup Photos of the EUT

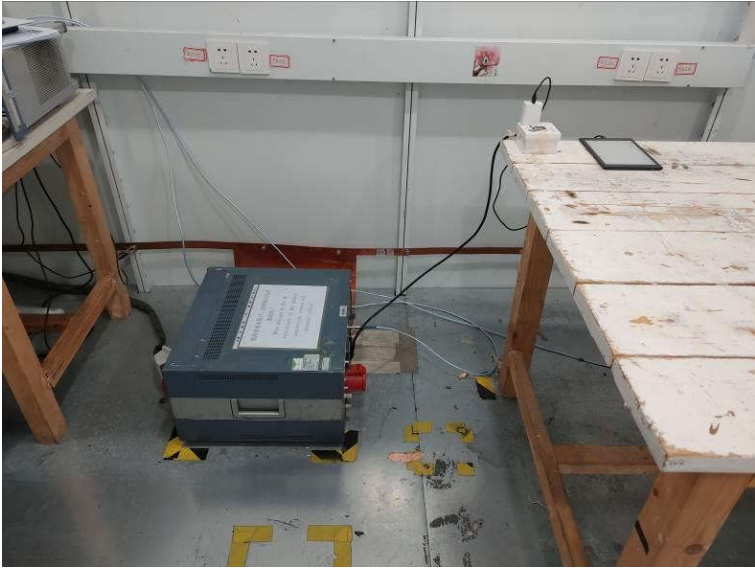

6 Photos of the EUT

Reference to the test report No. GTS20210601011-1-1

***** End of Report *****