



Shenzhen Global Test Service Co.,Ltd.

No.7-101 and 8A-104, Building 7 and 8, DCC Cultural and Creative Garden, No.98, Pingxin North Road, Shangmugu Community, Pinghu Street, Longgang District, Shenzhen, Guangdong

FCC PART 15 SUBPART C TEST REPORT

FCC PART 15.247

Report Reference No......: **GTS20200828013-1-4-1**

FCC ID.....: **XR3-NOTE3**

Compiled by

(position+printed name+signature)..: File administrators Jimmy Wang

Supervised by

(position+printed name+signature)..: Test Engineer Aaron Tan



Approved by

(position+printed name+signature)..: Manager Jason Hu

Date of issue.....: Aug. 28, 2020

Representative Laboratory Name .: **Shenzhen Global Test Service Co.,Ltd.**

Address.....: No.7-101 and 8A-104, Building 7 and 8, DCC Cultural and Creative Garden, No.98, Pingxin North Road, Shangmugu Community, Pinghu Street, Longgang District, Shenzhen, Guangdong, China

Applicant's name.....: **ONYX INTERNATIONAL INC.**

Address: ROOM C301, BUILDING 2, #21 HEJING SOUTH ROAD, LIWAN DISTRICT, GUANGZHOU, China

Test specification

Standard.....: **FCC Part 15.247**

TRF Originator.....: Shenzhen Global Test Service Co.,Ltd.

Master TRF.....: Dated 2014-12

Shenzhen Global Test Service Co.,Ltd. All rights reserved.

This publication may be reproduced in whole or in part for non-commercial purposes as long as the Shenzhen Global Test Service Co.,Ltd. is acknowledged as copyright owner and source of the material. Shenzhen Global Test Service Co.,Ltd. takes no responsibility for and will not assume liability for damages resulting from the reader's interpretation of the reproduced material due to its placement and context.

Test item description

Smart E Ink Tablet, ePaper Tablet, E-bag Tablet, E-book Tablet, E-reader Tablet, Eyes protection E Ink Tablet, E-paper Tablet, Color E Ink Tablet, Color ePaper Tablet

Trade Mark

BOOX

Manufacturer.....: **ONYX INTERNATIONAL INC.**

Model/Type reference.....: Note3

Listed Models: See next page

Ratings

5V---3A

Modulation

CCK/DSSS, OFDM

Hardware version

BOOX_M2_NOTE3_V0.2

Software version

V1.0

Frequency.....: From 2412MHz-2462MHz

Result.....: **PASS**

TEST REPORT

Test Report No. :	GTS20200828013-1-4-1	Aug. 28, 2020
		Date of issue

Equipment under Test : Smart E Ink Tablet, ePaper Tablet, E-bag Tablet, E-book Tablet, E-reader Tablet, Eyes protection E Ink Tablet, E-paper Tablet, Color E Ink Tablet, Color ePaper Tablet

Model /Type : Note3

Listed Models : Note3 Color, Note3 Pro, Note3 Plus, Note3 Lite, Note3 Color Plus, Note3 Color Pro

Applicant : **ONYX INTERNATIONAL INC.**

Address : Room 301, No.215,Qiaozhongzhong Road, Liwan District, Guangzhou, Guangdong Province, China

Manufacturer : **ONYX INTERNATIONAL INC.**

Address : Room 301, No.215,Qiaozhongzhong Road, Liwan District, Guangzhou, Guangdong Province, China

Test Result:	PASS
---------------------	-------------

The test report merely corresponds to the test sample.
 It is not permitted to copy extracts of these test result without the written permission of the test laboratory.

Contents

<u>1</u>	<u>TEST STANDARDS</u>	<u>4</u>
<u>2</u>	<u>SUMMARY</u>	<u>5</u>
2.1	General Remarks	5
2.2	Product Description	5
2.3	Test Sample	5
2.4	Equipment Under Test	5
2.5	Short description of the Equipment under Test (EUT)	5
2.6	EUT operation mode	6
2.7	Block Diagram of Test Setup	6
2.8	Special Accessories	6
2.9	Related Submittal(s) / Grant (s)	6
2.10	Modifications	6
<u>3</u>	<u>TEST ENVIRONMENT</u>	<u>7</u>
3.1	Address of the test laboratory	7
3.2	Test Facility	7
3.3	Environmental conditions	7
3.4	Test Description	8
3.5	Statement of the measurement uncertainty	9
3.6	Equipments Used during the Test	9
<u>4</u>	<u>TEST CONDITIONS AND RESULTS.....</u>	<u>11</u>
4.1	AC Power Conducted Emission	11
4.2	Radiated Emission	14
4.3	Maximum Conducted Output Power	21
4.4	Power Spectral Density	22
4.5	6dB Bandwidth	25
4.6	Out-of-band Emissions	28
4.7	Antenna Requirement	37
<u>5</u>	<u>TEST SETUP PHOTOS OF THE EUT</u>	<u>38</u>
<u>6</u>	<u>PHOTOS OF THE EUT</u>	<u>39</u>

1 TEST STANDARDS

The tests were performed according to following standards:

[FCC Rules Part 15.247](#): Frequency Hopping, Direct Spread Spectrum and Hybrid Systems that are in operation within the bands of 902-928 MHz, 2400-2483.5 MHz, and 5725-5850 MHz.

[ANSI C63.10-2013](#): American National Standard for Testing Unlicensed Wireless Devices

[KDB558074 D01 V05r02](#): Guidance for Compliance Measurements on Digital Transmission Systems (DTS) ,Frequency Hopping Spread Spectrum System(HFSS), and Hybrid System Devices Operating Under §15.247 of The FCC rules.

2 SUMMARY

2.1 General Remarks

Date of receipt of test sample	:	July 25, 2020
Testing commenced on	:	July 26, 2020
Testing concluded on	:	Aug. 20, 2020

2.2 Product Description

Product Description:	Smart E Ink Tablet, ePaper Tablet, E-bag Tablet, E-book Tablet, E-reader Tablet, Eyes protection E Ink Tablet, E-paper Tablet, Color E Ink Tablet, Color ePaper Tablet
Model/Type reference:	Note3
Power supply:	DC 3.8V from battery
Sample ID:	GTS20200828013-1-4-1#/ GTS20200828013-1-4-2#
WIFI	
Supported type:	802.11b/802.11g/802.11n(H20)/802.11n(H40)
Modulation:	802.11b: DSSS 802.11g/802.11n(H20)/ 802.11n(H40): OFDM
Operation frequency:	802.11b/802.11g/802.11n(H20): 2412MHz~2462MHz 802.11n(H40): 2422MHz~2452MHz
Channel number:	802.11b/802.11g/802.11n(H20): 11 802.11n(H40): 7
Channel separation:	5MHz
Antenna type:	FPC antenna
Antenna gain:	2.0 dBi

2.3 Test Sample

The application provides 2 samples to meet requirement.

Sample Number	Description
GTS20200828013-1-4-1#	Engineer sample – continuous transmit
GTS20200828013-1-4-2#	Normal sample – Intermittent transmit

2.4 Equipment Under Test

Power supply system utilised

Power supply voltage	:	<input type="radio"/> 230V / 50 Hz	<input type="radio"/> 120V / 60Hz
		<input type="radio"/> 12 V DC	<input type="radio"/> 24 V DC
		<input checked="" type="radio"/> Other (specified in blank below)	

DC 3.8V from battery

2.5 Short description of the Equipment under Test (EUT)

This is a Smart E Ink Tablet.

For more details, refer to the user's manual of the EUT.

2.6 EUT operation mode

The application provider specific test software(QRCT) to control sample in continuous TX and RX (Duty Cycle >98%) for testing meet KDB558074 test requirement.

IEEE 802.11b/g/n: Thirteen channels are provided to the EUT.

Channel	Frequency(MHz)	Channel	Frequency(MHz)
1	2412	8	2447
2	2417	9	2452
3	2422	10	2457
4	2427	11	2462
5	2432		
6	2437		
7	2442		

2.7 Block Diagram of Test Setup

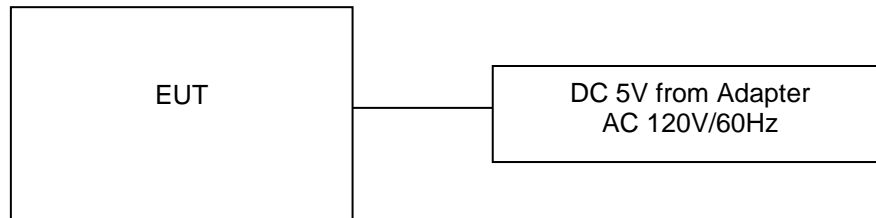

2.8 Special Accessories

Follow auxiliary equipment(s) test with EUT that provided by the manufacturer or laboratory is listed as follow:

Description	Manufacturer	Model	Technical Parameters	Certificate	Provided by
AC-DC Adapter	MOSO	EP-TA20CBC	Input:AC100-240V-50/60Hz, 0.5A Output:DC 5V,3A	FCC	Laboratory
/	/	/	/	/	/
/	/	/	/	/	/
/	/	/	/	/	/

2.9 Related Submittal(s) / Grant (s)

This submittal(s) (test report) is intended for the EUT filing to comply with Section 15.247 of the FCC Part 15, Subpart C Rules.

2.10 Modifications

No modifications were implemented to meet testing criteria.

3 TEST ENVIRONMENT

3.1 Address of the test laboratory

Shenzhen Global Test Service Co.,Ltd.

No.7-101 and 8A-104, Building 7 and 8, DCC Cultural and Creative Garden, No.98, Pingxin North Road, Shangmugu Community, Pinghu Street, Longgang District, Shenzhen, Guangdong

The 3m-Semi anechoic test site fulfils CISPR 16-1-4 according to ANSI C63.4:2014 and CISPR 16-1-4:2010 SVSWR requirement for radiated emission above 1GHz.

3.2 Test Facility

The test facility is recognized, certified, or accredited by the following organizations:

FCC-Registration No.: 165725

Shenzhen Global Test Service Co.,Ltd EMC Laboratory has been registered and fully described in a report filed with the (FCC) Federal Communications Commission. The acceptance letter from the FCC is maintained in our files.

A2LA-Lab Cert. No.: 4758.01

Shenzhen Global Test Service Co.,Ltd. EMC Laboratory has been accredited by A2LA for technical competence in the field of electrical testing, and proved to be in compliance with ISO/IEC 17025: 2005 General Requirements for the Competence of Testing and Calibration Laboratories and any additional program requirements in the identified field of testing.

CNAS-Lab Code: L8169

Shenzhen Global Test Service Co.,Ltd. has been assessed and proved to be in compliance with CNAS-CL01 Accreditation Criteria for Testing and Calibration Laboratories (identical to ISO/IEC 17025: 2005 General Requirements) for the Competence of Testing and Calibration Laboratories. Date of Registration: Dec. 11, 2015. Valid time is until Dec. 10, 2024.

3.3 Environmental conditions

During the measurement the environmental conditions were within the listed ranges:

Temperature:	15-35 ° C
Humidity:	30-60 %
Atmospheric pressure:	950-1050mbar

3.4 Test Description

Test Specification clause	Test case	Test Sample	Test Mode	Test Channel	Recorded In Report		Test result
§15.247(e)	Power spectral density	GTS2020082 8013-1-4-1#	802.11b 802.11g 802.11n(HT)20 802.11n(HT)40	Lowest Middle Highest	802.11b 802.11g 802.11n(HT)20 802.11n(HT)40	Lowest Middle Highest	complies
§15.247(a)(2)	Spectrum bandwidth – 6 dB bandwidth	GTS2020082 8013-1-4-1#	802.11b 802.11g 802.11n(HT)20 802.11n(HT)40	Lowest Middle Highest	802.11b 802.11g 802.11n(HT)20 802.11n(HT)40	Lowest Middle Highest	complies
§15.247(b)(1)	Maximum output power	GTS2020082 8013-1-4-1#	802.11b 802.11g 802.11n(HT)20 802.11n(HT)40	Lowest Middle Highest	802.11b 802.11g 802.11n(HT)20 802.11n(HT)40	Lowest Middle Highest	complies
§15.247(d)	Band edge compliance conducted	GTS2020082 8013-1-4-1#	802.11b 802.11g 802.11n(HT)20 802.11n(HT)40	Lowest Highest	802.11b 802.11g 802.11n(HT)20 802.11n(HT)40	Lowest Highest	complies
§15.205	Band edge compliance radiated	GTS2020082 8013-1-4-1#	802.11b 802.11g 802.11n(HT)20 802.11n(HT)40	Lowest Highest	802.11b	Lowest Highest	complies
§15.247(d)	TX spurious emissions conducted	GTS2020082 8013-1-4-1#	802.11b 802.11g 802.11n(HT)20 802.11n(HT)40	Lowest Middle Highest	802.11b 802.11g 802.11n(HT)20 802.11n(HT)40	Lowest Middle Highest	complies
§15.247(d)	TX spurious emissions radiated	GTS2020082 8013-1-4-1#	802.11b 802.11g 802.11n(HT)20 802.11n(HT)40	Lowest Middle Highest	802.11b	Lowest Middle Highest	complies
§15.209(a)	TX spurious Emissions radiated Below 1GHz	GTS2020082 8013-1-4-2#	802.11b 802.11g 802.11n(HT)20 802.11n(HT)40	Lowest Middle Highest	802.11b	Lowest	complies
§15.107(a) §15.207	Conducted Emissions < 30 MHz	GTS2020082 8013-1-4-2#	802.11b 802.11g 802.11n(HT)20 802.11n(HT)40	Lowest Middle Highest	802.11b	Highest	complies

Data Rate Used:

Preliminary tests were performed in different data rate to find the worst radiated emission. The data rate shown in the table below is the worst-case rate with respect to the specific test item. Investigation has been done on all the possible configurations for searching the worst cases. The following table is a list of the test modes shown in this test report.

Test Items	Mode	Data Rate	Channel
Maximum Peak Conducted Output Power Power Spectral Density 6dB Bandwidth Spurious RF conducted emission Radiated Emission 9KHz~1GHz& Radiated Emission 1GHz~10 th Harmonic	11b/DSSS	1 Mbps	1/6/11
	11g/OFDM	6 Mbps	1/6/11
	11n(20MHz)/OFDM	6.5Mbps	1/6/11
	11n(40MHz)/OFDM	13.5Mbps	3/6/9
Band Edge	11b/DSSS	1 Mbps	1/11
	11g/OFDM	6 Mbps	1/11
	11n(20MHz)/OFDM	6.5Mbps	1/11
	11n(40MHz)/OFDM	13.5Mbps	3/9

3.5 Statement of the measurement uncertainty

The data and results referenced in this document are true and accurate. The reader is cautioned that there may be errors within the calibration limits of the equipment and facilities. The measurement uncertainty was calculated for all measurements listed in this test report acc. to CISPR 16 - 4 „Specification for radio disturbance and immunity measuring apparatus and methods – Part 4: Uncertainty in EMC Measurements“ and is documented in the Shenzhen Global Test Service Co.,Ltd quality system acc. to DIN EN ISO/IEC 17025. Furthermore, component and process variability of devices similar to that tested may result in additional deviation. The manufacturer has the sole responsibility of continued compliance of the device.

Hereafter the best measurement capability for Shenzhen GTS laboratory is reported:

Test	Range	Measurement Uncertainty	Notes
Radiated Emission	30~1000MHz	4.10 dB	(1)
Radiated Emission	1~18GHz	4.32 dB	(1)
Radiated Emission	18~40GHz	5.54 dB	(1)
Conducted Disturbance	0.15~30MHz	3.12 dB	(1)

(1) This uncertainty represents an expanded uncertainty expressed at approximately the 95% confidence level using a coverage factor of $k=2$.

3.6 Equipments Used during the Test

Test Equipment	Manufacturer	Model No.	Serial No.	Calibration Date	Calibration Due Date
LISN	R&S	ENV216	3560.6550.08	2019/09/20	2020/09/19
LISN	R&S	ESH2-Z5	893606/008	2019/09/20	2020/09/19
EMI Test Receiver	R&S	ESPI3	101841-cd	2019/09/20	2020/09/19
EMI Test Receiver	R&S	ESCI7	101102	2019/09/20	2020/09/19
Spectrum Analyzer	Agilent	N9020A	MY48010425	2019/09/20	2020/09/19
Spectrum Analyzer	Agilent	E4407B	MY45132751	2019/09/20	2020/09/19
Spectrum Analyzer	R&S	FSV40	100019	2019/09/20	2020/09/19
Vector Signal generator	Agilent	N5181A	MY49060502	2019/09/20	2020/09/19
Signal generator	Agilent	E4421B	3610AO1069	2019/09/20	2020/09/19
Climate Chamber	ESPEC	EL-10KA	A20120523	2019/09/20	2020/09/19
Controller	EM Electronics	Controller EM 1000	N/A	N/A	N/A
Horn Antenna	Schwarzbeck	BBHA 9120D	01622	2019/09/23	2020/09/22
Active Loop Antenna	Beijing Da Ze Technology Co.,Ltd.	ZN30900C	15006	2019/10/12	2020/10/11
Bilog Antenna	Schwarzbeck	VULB9163	000976	2020/05/24	2021/05/23
Broadband Horn Antenna	SCHWARZBECK	BBHA 9170	791	2019/09/20	2020/09/19
Amplifier	Schwarzbeck	BBV 9743	#202	2019/09/20	2020/09/19
Amplifier	Schwarzbeck	BBV9179	9719-025	2019/09/20	2020/09/19
Amplifier	EMCI	EMC051845B	980355	2019/09/20	2020/09/19
Temperature/Humidity Meter	Gangxing	CTH-608	02	2019/09/20	2020/09/19
High-Pass Filter	K&L	9SH10-2700/X12750-O/O	KL142031	2019/09/20	2020/09/19
High-Pass Filter	K&L	41H10-1375/U12750-O/O	KL142032	2019/09/20	2020/09/19
RF Cable(below 1GHz)	HUBER+SUHNER	RG214	RE01	2019/09/20	2020/09/19
RF Cable(above	HUBER+SUHNER	RG214	RE02	2019/09/20	2020/09/19

1GHz)					
Data acquisition card	Agilent	U2531A	TW53323507	2019/09/20	2020/09/19
Power Sensor	Agilent	U2021XA	MY5365004	2019/09/20	2020/09/19
Test Control Unit	Tonscend	JS0806-1	178060067	2020/06/18	2021/06/17
Automated filter bank	Tonscend	JS0806-F	19F8060177	2020/06/18	2021/06/17
EMI Test Software	Tonscend	JS1120-1	Ver 2.6.8.0518	/	/
EMI Test Software	Tonscend	JS1120-3	Ver 2.5.77.0418	/	/
EMI Test Software	Tonscend	JS32-CE	Ver 2.5	/	/
EMI Test Software	Tonscend	JS32-RE	Ver 2.5.1.8	/	/

Note: The Cal.Interval was one year.

4 TEST CONDITIONS AND RESULTS

4.1 AC Power Conducted Emission

TEST CONFIGURATION

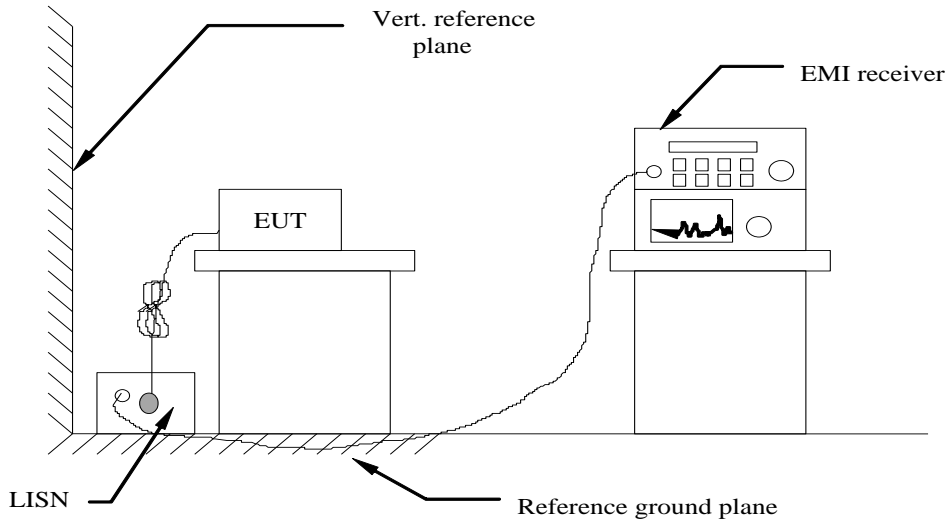

TEST PROCEDURE

- 1 The equipment was set up as per the test configuration to simulate typical actual usage per the user's manual. The EUT is a tabletop system, a wooden table with a height of 0.8 meters is used and is placed on the ground plane as per ANSI C63.10-2013.
- 2 Support equipment, if needed, was placed as per ANSI C63.10-2013
- 3 All I/O cables were positioned to simulate typical actual usage as per ANSI C63.10-2013
- 4 The EUT received DC 12V power from adapter, the adapter received AC120V/60Hz and AC 240V/60Hz power through a Line Impedance Stabilization Network (LISN) which supplied power source and was grounded to the ground plane.
- 5 All support equipments received AC power from a second LISN, if any.
- 6 The EUT test program was started. Emissions were measured on each current carrying line of the EUT using a spectrum Analyzer / Receiver connected to the LISN powering the EUT. The LISN has two monitoring points: Line 1 (Hot Side) and Line 2 (Neutral Side). Two scans were taken: one with Line 1 connected to Analyzer / Receiver and Line 2 connected to a 50 ohm load; the second scan had Line 1 connected to a 50 ohm load and Line 2 connected to the Analyzer / Receiver.
- 7 Analyzer / Receiver scanned from 150 KHz to 30MHz for emissions in each of the test modes.
- 8 During the above scans, the emissions were maximized by cable manipulation.

AC Power Conducted Emission Limit

For intentional device, according to § 15.207(a) AC Power Conducted Emission Limits is as following :

Frequency range (MHz)	Limit (dBuV)	
	Quasi-peak	Average
0.15-0.5	66 to 56*	56 to 46*
0.5-5	56	46
5-30	60	50

* Decreases with the logarithm of the frequency.

TEST RESULTS

Temperature	22.8°C	Humidity	56%
Test Engineer	Moon Tan	Configurations	WLAN2.4G

Remark:

- All modes of 802.11b/g/n were tested at Low, Middle, and High channel; only the worst result of 802.11b CH11 was reported as below:
- Both 120 VAC, 50/60 Hz and 240 VAC, 50/60 Hz power supply have been tested, only the worst result of 120 VAC, 60 Hz was reported as below:.

Power supply:	AC 120V/60Hz(adapter)	Polarization	L
---------------	-----------------------	--------------	---

Test Graph

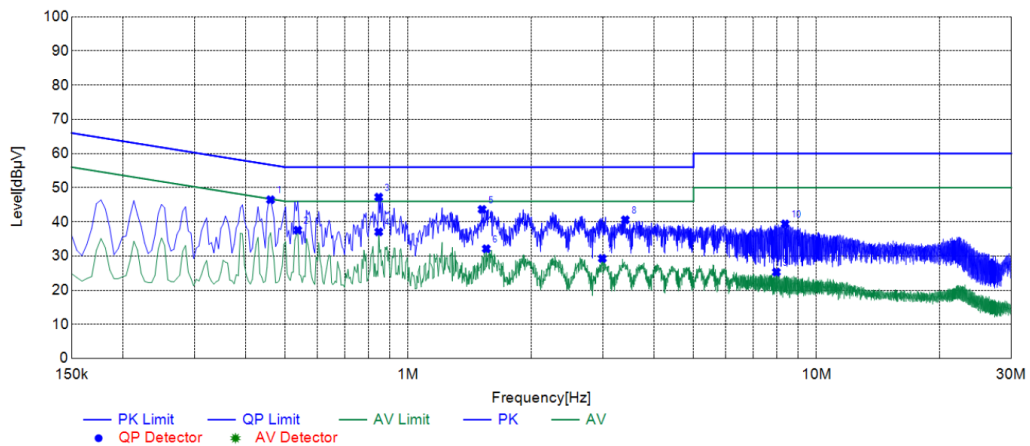

Suspected List									
NO.	Frequency [MHz]	Reading [dBµV]	Factor [dB]	Result [dBµV]	Limit [dBµV]	Margin [dB]	Detector	Line	Remark
1	0.4605	36.41	10.05	46.46	56.68	10.22	PK	L1	PASS
2	0.5370	27.50	10.06	37.56	46.00	8.44	AV	L1	PASS
3	0.8475	37.16	10.07	47.23	56.00	8.77	PK	L1	PASS
4	0.8475	26.98	10.07	37.05	46.00	8.95	AV	L1	PASS
5	1.5180	33.52	10.11	43.63	56.00	12.37	PK	L1	PASS
6	1.5540	21.99	10.12	32.11	46.00	13.89	AV	L1	PASS
7	2.9895	18.98	10.29	29.27	46.00	16.73	AV	L1	PASS
8	3.4035	30.26	10.33	40.59	56.00	15.41	PK	L1	PASS
9	7.9755	14.66	10.62	25.28	50.00	24.72	AV	L1	PASS
10	8.3805	28.75	10.64	39.39	60.00	20.61	PK	L1	PASS

Note:1. Result (dBµV) = Reading (dBµV) + Factor (dB).
 2. Factor (dB) = Cable loss (dB) + LISN Factor (dB).

Power supply:

AC 120V/60Hz(adapter)

Polarization

N

Test Graph

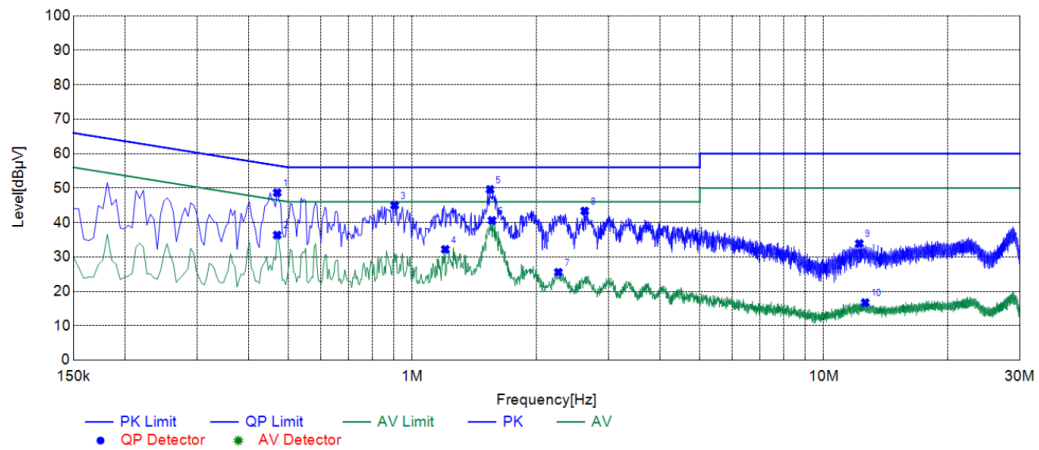

Suspected List

NO.	Frequency [MHz]	Reading [dBµV]	Factor [dB]	Result [dBµV]	Limit [dBµV]	Margin [dB]	Detector	Line	Remark
1	0.4695	38.59	10.05	48.64	56.52	7.88	PK	N	PASS
2	0.4695	26.29	10.05	36.34	46.52	10.18	AV	N	PASS
3	0.9060	34.91	10.06	44.97	56.00	11.03	PK	N	PASS
4	1.2030	22.10	10.09	32.19	46.00	13.81	AV	N	PASS
5	1.5450	39.47	10.11	49.58	56.00	6.42	PK	N	PASS
6	1.5630	30.47	10.12	40.59	46.00	5.41	AV	N	PASS
7	2.2650	15.35	10.19	25.54	46.00	20.46	AV	N	PASS
8	2.6250	33.08	10.24	43.32	56.00	12.68	PK	N	PASS
9	12.2055	23.03	10.86	33.89	60.00	26.11	PK	N	PASS
10	12.6150	5.84	10.89	16.73	50.00	33.27	AV	N	PASS

Note:1. Result (dBµV) = Reading (dBµV) + Factor (dB).

2. Factor (dB) = Cable loss (dB) + LISN Factor (dB).

4.2 Radiated Emission

TEST CONFIGURATION

Frequency range 9 KHz – 30MHz

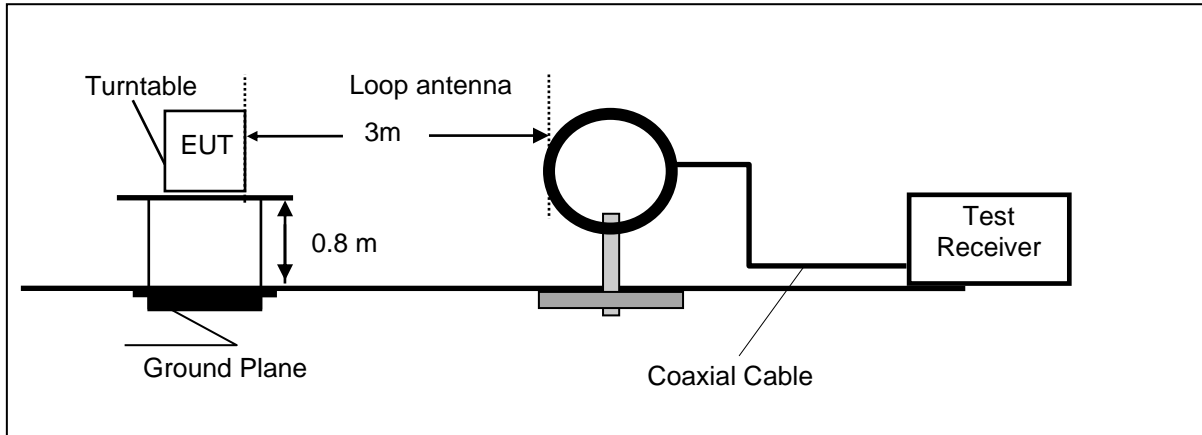

Frequency range 30MHz – 1000MHz

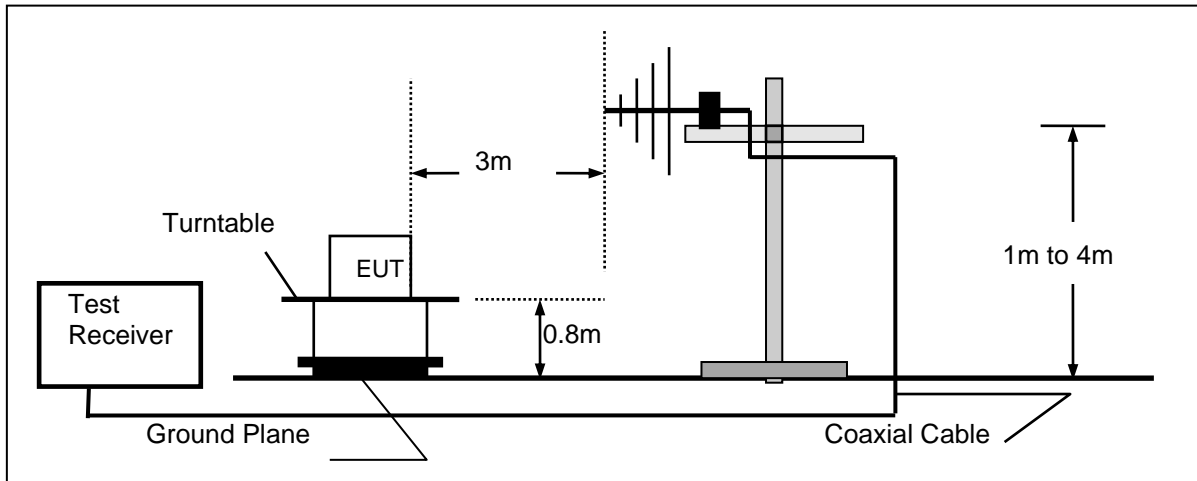

Frequency range above 1GHz-25GHz

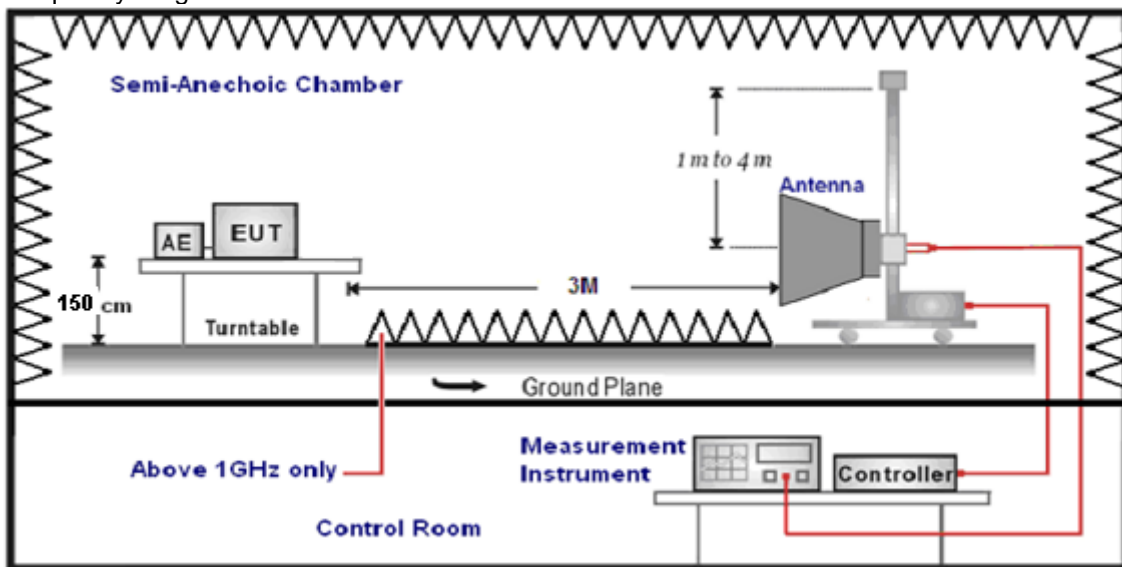

TEST PROCEDURE

1. The EUT was placed on a turn table which is 0.8m above ground plane when testing frequency range 9 KHz –1GHz;the EUT was placed on a turn table which is 1.5m above ground plane when testing frequency range 1GHz – 25GHz.
2. Maximum procedure was performed by raising the receiving antenna from 1m to 4m and rotating the turn table from 0° to 360° to acquire the highest emissions from EUT.
3. And also, each emission was to be maximized by changing the polarization of receiving antenna both horizontal and vertical.
4. Repeat above procedures until all frequency measurements have been completed.
5. Radiated emission test frequency band from 9KHz to 25GHz.
6. The distance between test antenna and EUT as following table states:

Test Frequency range	Test Antenna Type	Test Distance
9KHz-30MHz	Active Loop Antenna	3
30MHz-1GHz	Ultra-Broadband Antenna	3
1GHz-18GHz	Double Ridged Horn Antenna	3
18GHz-25GHz	Horn Antenna	1

7. Setting test receiver/spectrum as following table states:

Test Frequency range	Test Receiver/Spectrum Setting	Detector
9KHz-150KHz	RBW=200Hz/VBW=3KHz, Sweep time=Auto	QP
150KHz-30MHz	RBW=9KHz/VBW=100KHz, Sweep time=Auto	QP
30MHz-1GHz	RBW=120KHz/VBW=1000KHz, Sweep time=Auto	QP
1GHz-40GHz	Peak Value: RBW=1MHz/VBW=3MHz, Sweep time=Auto Average Value: RBW=1MHz/VBW=10Hz, Sweep time=Auto	Peak

Field Strength Calculation

The field strength is calculated by adding the Antenna Factor and Cable Factor and subtracting the Amplifier Gain and Duty Cycle Correction Factor(if any) from the measured reading. The basic equation with a sample calculation is as follows:

$$FS = RA + AF + CL - AG$$

Where FS = Field Strength	CL = Cable Attenuation Factor (Cable Loss)
RA = Reading Amplitude	AG = Amplifier Gain
AF = Antenna Factor	

$$Transd=AF +CL-AG$$

RADIATION LIMIT

For intentional device, according to § 15.209(a), the general requirement of field strength of radiated emission from intentional radiators at a distance of 3 meters shall not exceed the following table. According to § 15.247(d), in any 100kHz bandwidth outside the frequency band in which the EUT is operating, the radio frequency power that is produced by the intentional radiator shall be at least 20dB below that in the100kHz bandwidth within the band that contains the highest level of desired power.

The pre-test have done for the EUT in three axes and found the worst emission at position shown in test setup photos.

Frequency (MHz)	Distance (Meters)	Radiated (dBµV/m)	Radiated (µV/m)
0.009-0.49	3	20log(2400/F(KHz))+40log(300/3)	2400/F(KHz)
0.49-1.705	3	20log(24000/F(KHz))+ 40log(30/3)	24000/F(KHz)
1.705-30	3	20log(30)+ 40log(30/3)	30
30-88	3	40.0	100
88-216	3	43.5	150
216-960	3	46.0	200
Above 960	3	54.0	500

TEST RESULTS

Temperature	22.8°C	Humidity	56%
Test Engineer	Moon Tan	Configurations	WLAN2.4G

Remark:

1. This test was performed with EUT in X, Y, Z position and the worse case was found when EUT in X position.
2. All three channels (lowest/middle/highest) of each mode were measured below 1GHz and recorded worst case at 802.11b low channel.
3. All three channels (lowest/middle/highest) of each mode were measured above 1GHz and recorded worst case at 802.11b mode.
4. Radiated emission test from 9 KHz to 10th harmonic of fundamental was verified, and no emission found except system noise floor in 9 KHz to 30MHz and not recorded in this report.

For 30MHz-1GHz

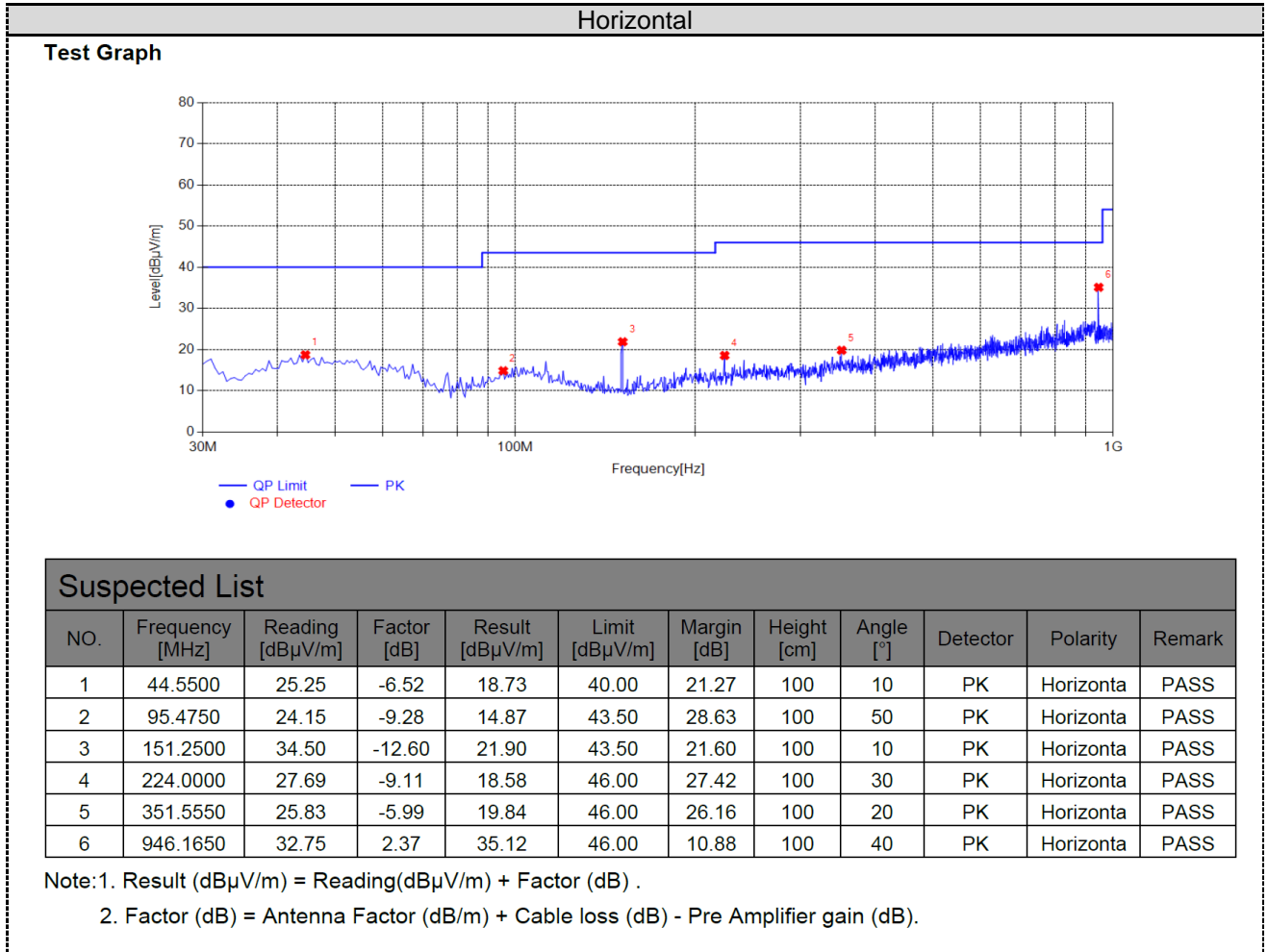

Suspected List

NO.	Frequency [MHz]	Reading [dBµV/m]	Factor [dB]	Result [dBµV/m]	Limit [dBµV/m]	Margin [dB]	Height [cm]	Angle [°]	Detector	Polarity	Remark
1	44.5500	25.25	-6.52	18.73	40.00	21.27	100	10	PK	Horizontal	PASS
2	95.4750	24.15	-9.28	14.87	43.50	28.63	100	50	PK	Horizontal	PASS
3	151.2500	34.50	-12.60	21.90	43.50	21.60	100	10	PK	Horizontal	PASS
4	224.0000	27.69	-9.11	18.58	46.00	27.42	100	30	PK	Horizontal	PASS
5	351.5550	25.83	-5.99	19.84	46.00	26.16	100	20	PK	Horizontal	PASS
6	946.1650	32.75	2.37	35.12	46.00	10.88	100	40	PK	Horizontal	PASS

Note:1. Result (dBµV/m) = Reading(dBµV/m) + Factor (dB) .

2. Factor (dB) = Antenna Factor (dB/m) + Cable loss (dB) - Pre Amplifier gain (dB).

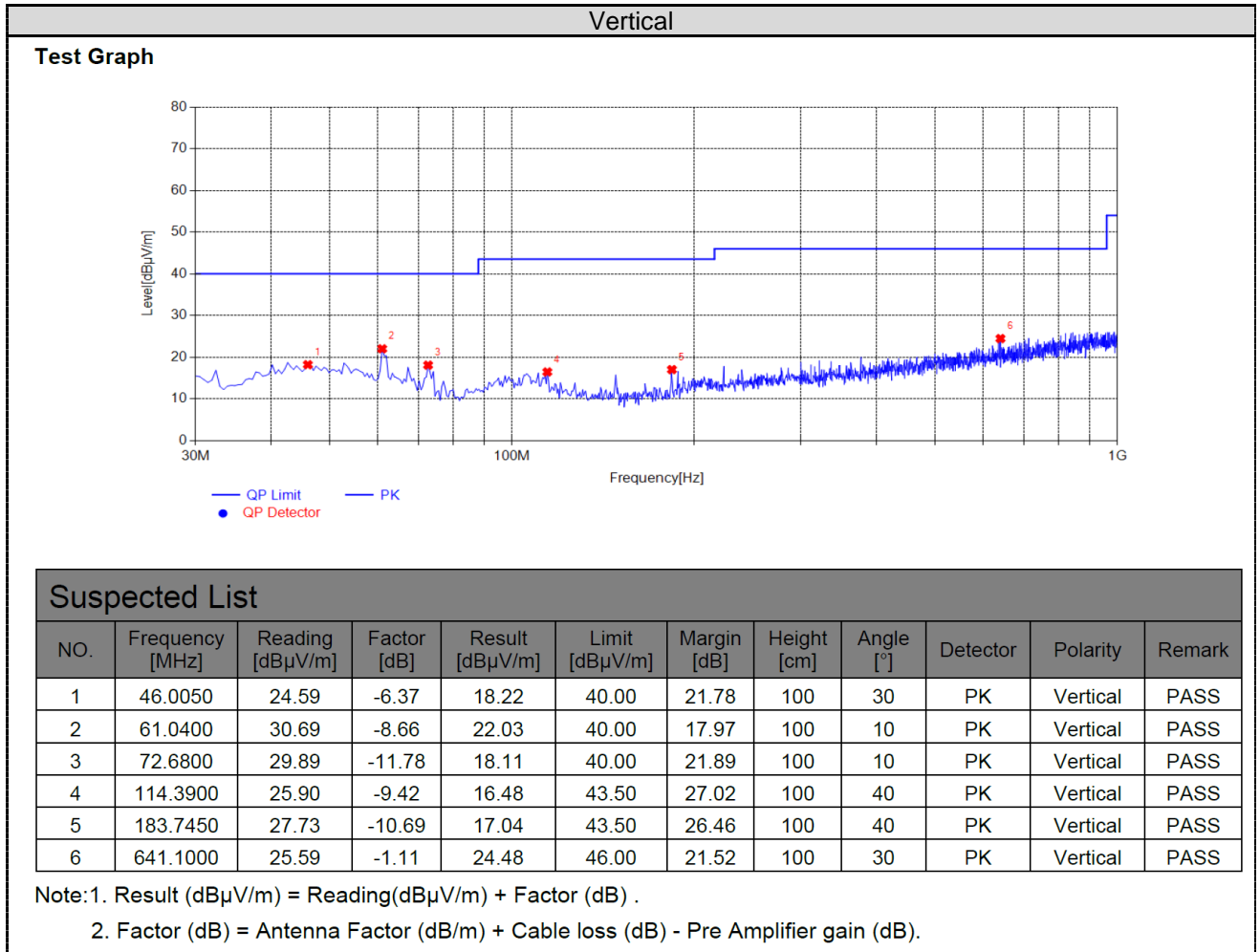

For 1GHz to 25GHz

Note: 802.11b/802.11g/802.11n (H20)/802.11n (H40) all have been tested, only worse case 802.11b mode 1Mbps is reported

Frequency(MHz):			2412		Polarity:			HORIZONTAL	
Frequency (MHz)	Emission Level (dBuV/m)		Limit (dBuV/m)	Margin (dB)	Raw Value (dBuV)	Antenna Factor (dB/m)	Cable Factor (dB)	Pre-amplifier (dB)	Correction Factor (dB/m)
4824.00	50.75	PK	74	23.25	49.96	30.28	7.01	36.50	0.79
4824.00	--	AV	54	--	--	--	--	--	--
7236.00	47.81	PK	74	26.19	37.61	36.59	8.91	35.30	10.20
7236.00	--	AV	54	--	--	--	--	--	--

Frequency(MHz):			2412		Polarity:			VERTICAL	
Frequency (MHz)	Emission Level (dBuV/m)		Limit (dBuV/m)	Margin (dB)	Raw Value (dBuV)	Antenna Factor (dB/m)	Cable Factor (dB)	Pre-amplifier (dB)	Correction Factor (dB/m)
4824.00	52.25	PK	74	21.75	51.46	30.28	7.01	36.50	0.79
4824.00	--	AV	54	--	--	--	--	--	--
7236.00	48.31	PK	74	25.69	38.11	36.59	8.91	35.30	10.20
7236.00	--	AV	54	--	--	--	--	--	--

Frequency(MHz):			2437		Polarity:			HORIZONTAL	
Frequency (MHz)	Emission Level (dBuV/m)		Limit (dBuV/m)	Margin (dB)	Raw Value (dBuV)	Antenna Factor (dB/m)	Cable Factor (dB)	Pre-amplifier (dB)	Correction Factor (dB/m)
4874.00	50.30	PK	74	23.70	48.82	30.36	7.62	36.50	1.48
4874.00	--	AV	54	--	--	--	--	--	--
7311.00	47.49	PK	74	26.51	37.34	36.61	8.84	35.30	10.15
7311.00	--	AV	54	--	--	--	--	--	--

Frequency(MHz):			2437		Polarity:			VERTICAL	
Frequency (MHz)	Emission Level (dBuV/m)		Limit (dBuV/m)	Margin (dB)	Raw Value (dBuV)	Antenna Factor (dB/m)	Cable Factor (dB)	Pre-amplifier (dB)	Correction Factor (dB/m)
4874.00	51.70	PK	74	22.30	50.22	30.36	7.62	36.50	1.48
4874.00	--	AV	54	--	--	--	--	--	--
7311.00	48.89	PK	74	25.11	38.74	36.61	8.84	35.30	10.15
7311.00	--	AV	54	--	--	--	--	--	--

Frequency(MHz):			2462		Polarity:			HORIZONTAL	
Frequency (MHz)	Emission Level (dBuV/m)		Limit (dBuV/m)	Margin (dB)	Raw Value (dBuV)	Antenna Factor (dB/m)	Cable Factor (dB)	Pre-amplifier (dB)	Correction Factor (dB/m)
4924.00	52.28	PK	74	21.72	50.11	30.43	7.94	36.20	2.17
4924.00	--	AV	54	--	--	--	--	--	--
7386.00	49.37	PK	74	24.63	39.44	36.78	8.45	35.30	9.93
7386.00	--	AV	54	--	--	--	--	--	--

Frequency(MHz):			2462		Polarity:			VERTICAL	
Frequency (MHz)	Emission Level (dBuV/m)		Limit (dBuV/m)	Margin (dB)	Raw Value (dBuV)	Antenna Factor (dB/m)	Cable Factor (dB)	Pre-amplifier (dB)	Correction Factor (dB/m)
4924.00	53.28	PK	74	20.72	51.11	30.43	7.94	36.20	2.17
4924.00	--	AV	54	--	--	--	--	--	--
7386.00	50.17	PK	74	23.83	40.24	36.78	8.45	35.30	9.93
7386.00	--	AV	54	--	--	--	--	--	--

REMARKS:

1. Emission level (dBuV/m) =Raw Value (dBuV)+Correction Factor (dB/m)
2. Correction Factor (dB/m) = Antenna Factor (dB/m)+Cable Factor (dB)-Pre-amplifier Factor
3. Margin value = Limit value- Emission level.
4. -- Mean the PK detector measured value is below average limit.
5. The other emission levels were very low against the limit.
6. RBW1MHz VBW3MHz Peak detector is for PK value; RBW 1MHz VBW10Hz Peak detector is for AV value.

Results of Band Edges Test (Radiated)

Note: 802.11b/802.11g/802.11n (H20) /802.11n (H40) all have been tested, only worse case 802.11b is reported.

Frequency(MHz):			2412		Polarity:			HORIZONTAL	
Frequency (MHz)	Emission Level (dBuV/m)		Limit (dBuV/m)	Margin (dB)	Raw Value (dBuV)	Antenna Factor (dB/m)	Cable Factor (dB)	Pre-amplifier (dB)	Correction Factor (dB/m)
2390.00	47.51	PK	74	26.49	52.92	27.49	3.32	36.22	-5.41
2390.00	--	AV	54	--	--	--	--	--	--
2400.00	49.89	PK	74	24.11	55.15	27.55	3.41	36.22	-5.26
2400.00	--	AV	54	--	--	--	--	--	--

Frequency(MHz):			2412		Polarity:			VERTICAL	
Frequency (MHz)	Emission Level (dBuV/m)		Limit (dBuV/m)	Margin (dB)	Raw Value (dBuV)	Antenna Factor (dB/m)	Cable Factor (dB)	Pre-amplifier (dB)	Correction Factor (dB/m)
2390.00	49.11	PK	74	24.89	54.52	27.49	3.32	36.22	-5.41
2390.00	--	AV	54	--	--	--	--	--	--
2400.00	51.09	PK	74	22.91	56.35	27.55	3.41	36.22	-5.26
2400.00	--	AV	54	--	--	--	--	--	--

Frequency(MHz):			2462		Polarity:			HORIZONTAL	
Frequency (MHz)	Emission Level (dBuV/m)		Limit (dBuV/m)	Margin (dB)	Raw Value (dBuV)	Antenna Factor (dB/m)	Cable Factor (dB)	Pre-amplifier (dB)	Correction Factor (dB/m)
2483.50	49.22	PK	74	24.78	54.73	27.45	3.38	36.34	-5.51
2483.50	--	AV	54	--	--	--	--	--	--
2500.00	47.15	PK	74	26.85	52.62	27.41	3.47	36.35	-5.47
2500.00	--	AV	54	--	--	--	--	--	--

Frequency(MHz):			2462		Polarity:			VERTICAL	
Frequency (MHz)	Emission Level (dBuV/m)		Limit (dBuV/m)	Margin (dB)	Raw Value (dBuV)	Antenna Factor (dB/m)	Cable Factor (dB)	Pre-amplifier (dB)	Correction Factor (dB/m)
2483.50	50.82	PK	74	23.18	56.33	27.45	3.38	36.34	-5.51
2483.50	--	AV	54	--	--	--	--	--	--
2500.00	48.55	PK	74	25.45	54.02	27.41	3.47	36.35	-5.47
2500.00	--	AV	54	--	--	--	--	--	--

REMARKS:

1. Emission level (dBuV/m) =Raw Value (dBuV)+Correction Factor (dB/m)
2. Correction Factor (dB/m) = Antenna Factor (dB/m)+Cable Factor (dB)-Pre-amplifier Factor
3. Margin value = Limit value- Emission level.
4. -- Mean the PK detector measured value is below average limit.
5. The other emission levels were very low against the limit.
6. RBW1MHz VBW3MHz Peak detector is for PK value; RBW 1MHz VBW10Hz Peak detector is for AV value.

4.3 Maximum Conducted Output Power

Limit

The Maximum Peak Output Power Measurement is 30dBm.

Test Procedure

Remove the antenna from the EUT and then connect a low loss RF cable from the antenna port to the power sensor.

Test Configuration

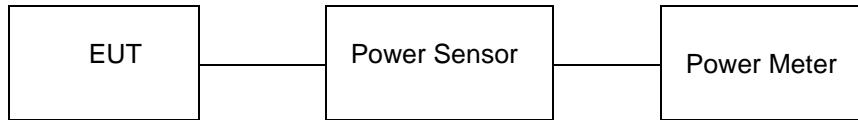

Test Results

Temperature	22.8°C	Humidity	56%
Test Engineer	Moon Tan	Configurations	WLAN2.4G

WIFI

Type	Channel	Output power PK (dBm)	Limit (dBm)	Result
802.11b	01	9.10	30.00	Pass
	06	9.21		
	11	9.14		
802.11g	01	8.74	30.00	Pass
	06	8.85		
	11	8.70		
802.11n(HT20)	01	8.41	30.00	Pass
	06	8.89		
	11	8.95		
802.11n(HT40)	03	8.05	30.00	Pass
	06	8.22		
	09	8.18		

Note: 1.The test results including the cable lose.

4.4 Power Spectral Density

Limit

For digitally modulated systems, the power spectral density conducted from the intentional radiator to the antenna shall not be greater than 8 dBm in any 3 kHz band during any time interval of continuous transmission.

Test Procedure

1. Use this procedure when the maximum peak conducted output power in the fundamental emission is used to demonstrate compliance.
2. Set the RBW \geq 3 kHz.
3. Set the VBW \geq 3 \times RBW.
4. Set the span to 1.5 times the DTS channel bandwidth.
5. Detector = peak.
6. Sweep time = auto couple.
7. Trace mode = max hold.
8. Allow trace to fully stabilize.
9. Use the peak marker function to determine the maximum power level.
10. If measured value exceeds limit, reduce RBW (no less than 3 kHz) and repeat.
11. The resulting peak PSD level must be 8dBm.

Test Configuration

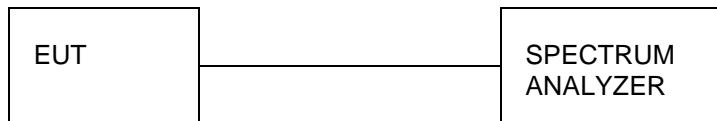

Test Results

Temperature	22.8°C	Humidity	56%
Test Engineer	Moon Tan	Configurations	WLAN2.4G

WIFI

Type	Channel	Power Spectral Density (dBm/3KHz)	Limit (dBm/3KHz)	Result
802.11b	01	-16.06	8.00	Pass
	06	-14.61		
	11	-14.50		
802.11g	01	-17.04	8.00	Pass
	06	-17.16		
	11	-18.52		
802.11n(HT20)	01	-17.60	8.00	Pass
	06	-17.98		
	11	-18.45		
802.11n(HT40)	03	-18.32	8.00	Pass
	06	-18.10		
	09	-18.52		

Test plot as follows:

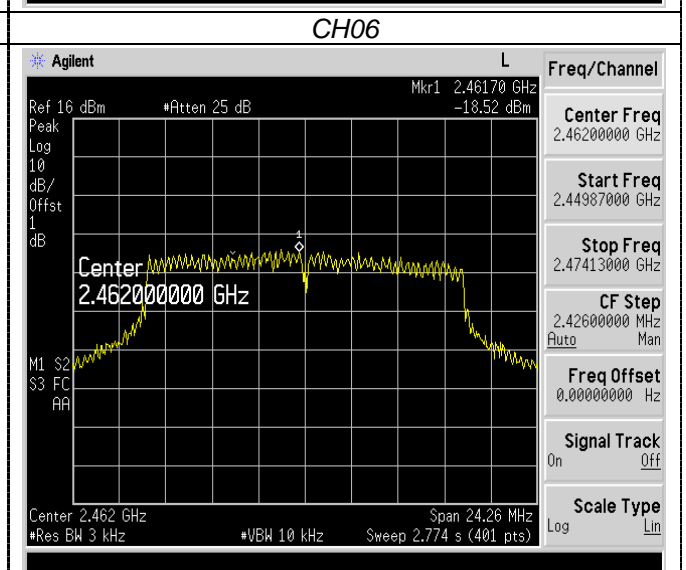
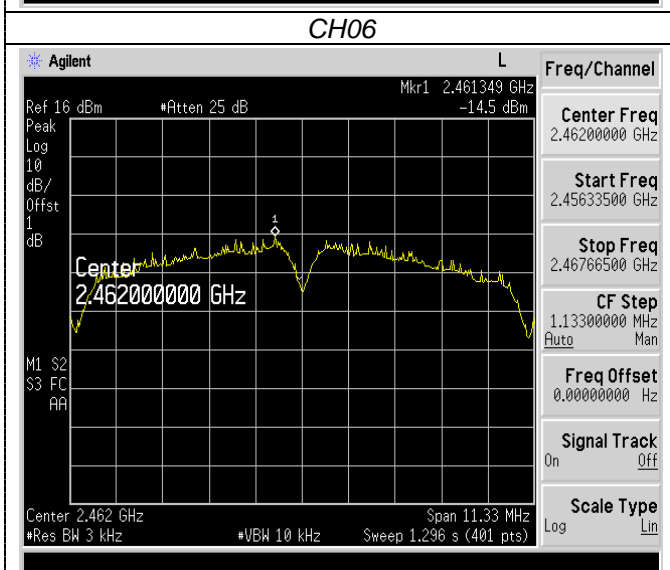
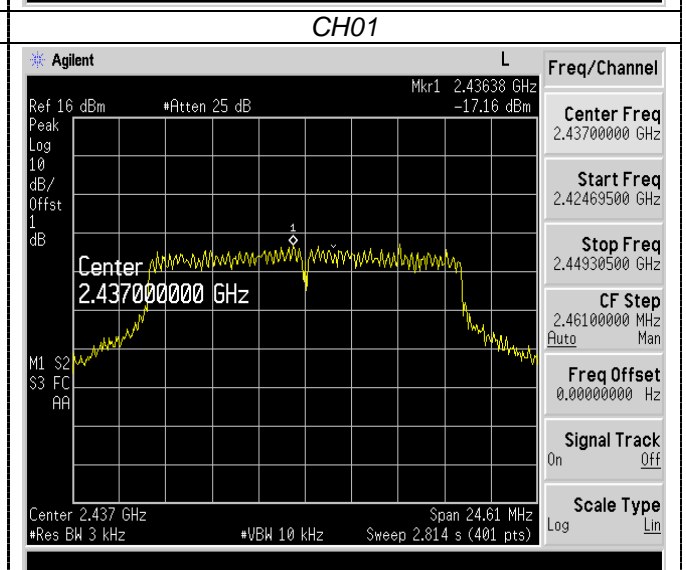
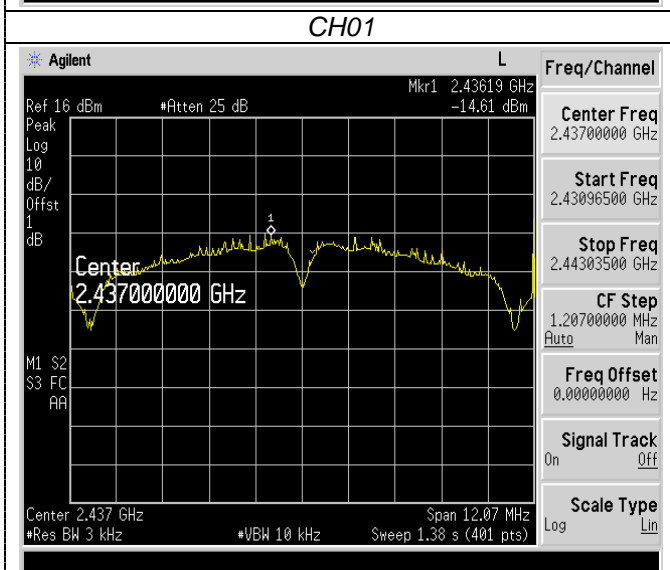
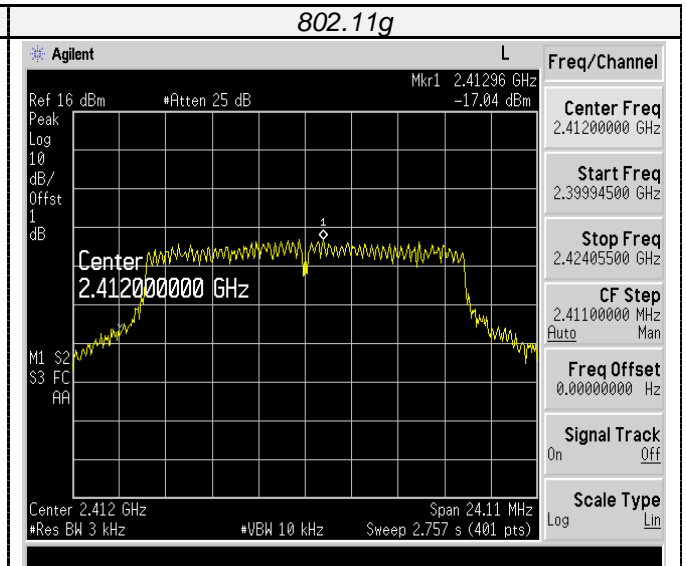
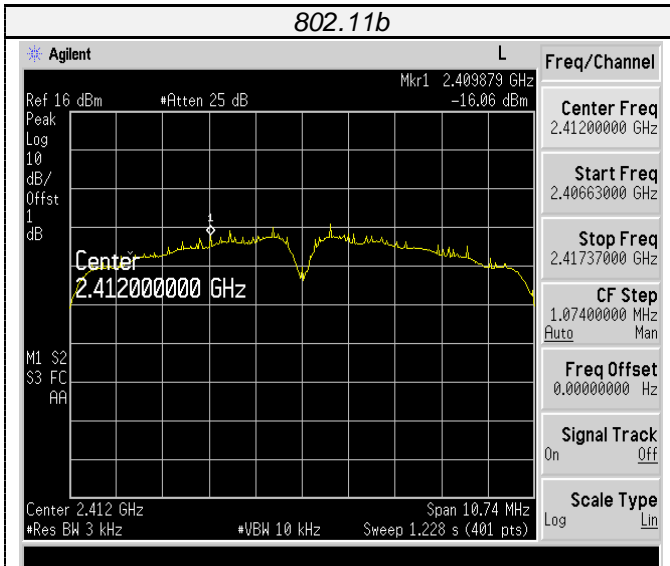

CH11

CH11

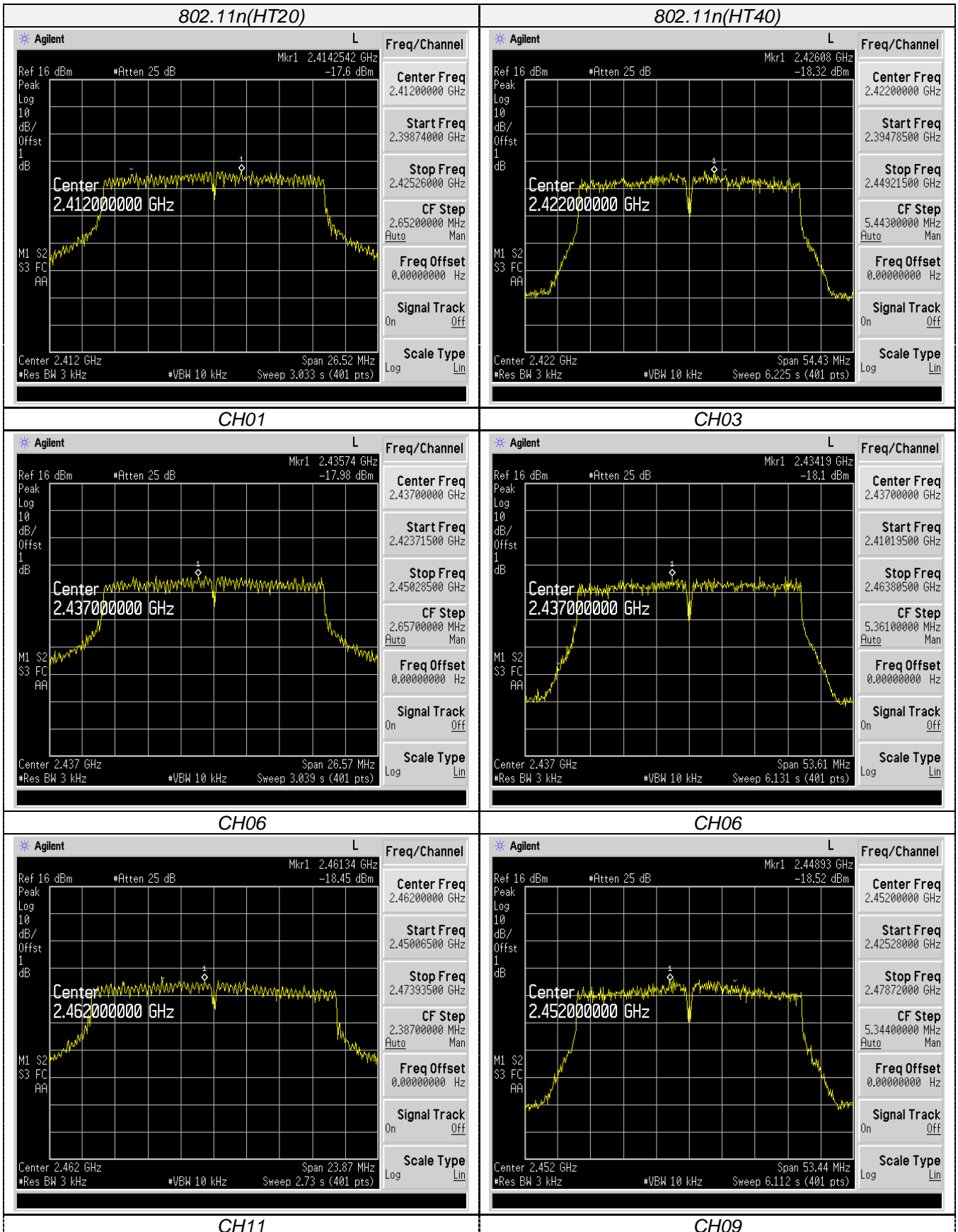

4.5 6dB Bandwidth

Limit

For digital modulation systems, the minimum 6 dB bandwidth shall be at least 500 kHz

Test Procedure

The transmitter output was connected to the spectrum analyzer through an attenuator. The bandwidth of the fundamental frequency was measured by spectrum analyzer with 100 KHz RBW and 300 KHz VBW. The 6dB bandwidth is defined as the total spectrum the power of which is higher than peak power minus 6dB.

Test Configuration

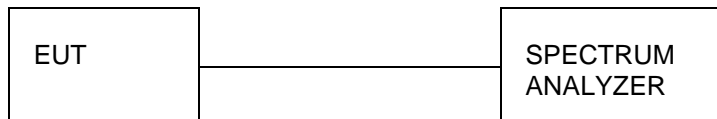

Test Results

Temperature	22.8°C	Humidity	56%
Test Engineer	Moon Tan	Configurations	WLAN2.4G

WIFI

Type	Channel	6dB Bandwidth (MHz)	99% OBW (MHz)	Limit (KHz)	Result
802.11b	01	7.161	12.7070	≥500	Pass
	06	8.046	12.7161		
	11	7.556	12.6056		
802.11g	01	16.076	16.4487	≥500	Pass
	06	16.408	16.4883		
	11	16.176	16.4192		
802.11n(HT20)	01	17.677	17.7152	≥500	Pass
	06	17.715	17.6942		
	11	15.910	17.6421		
802.11n(HT40)	03	36.286	36.0623	≥500	Pass
	06	35.741	36.1774		
	09	35.627	36.0216		

Test plot as follows:

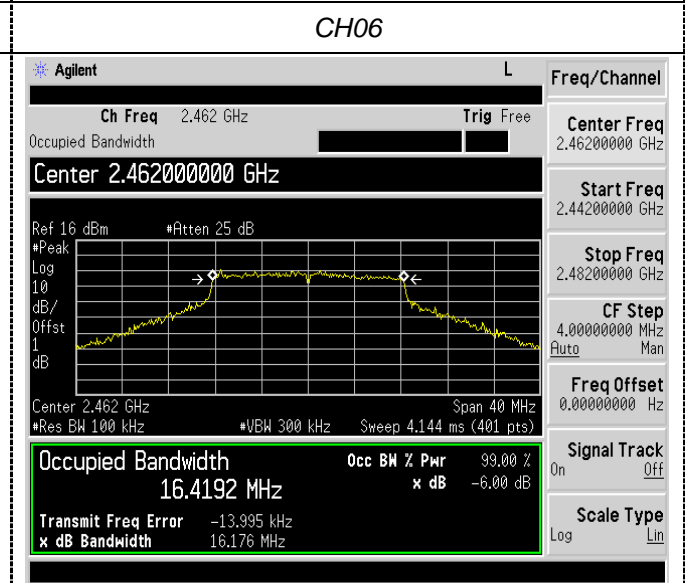
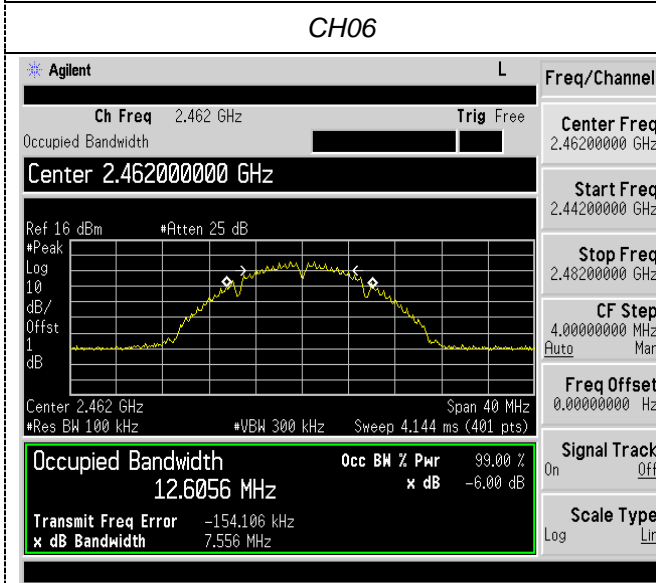
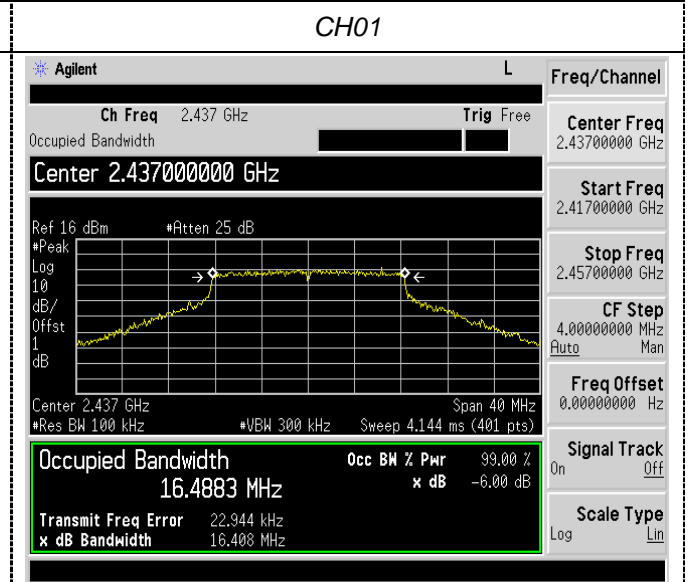
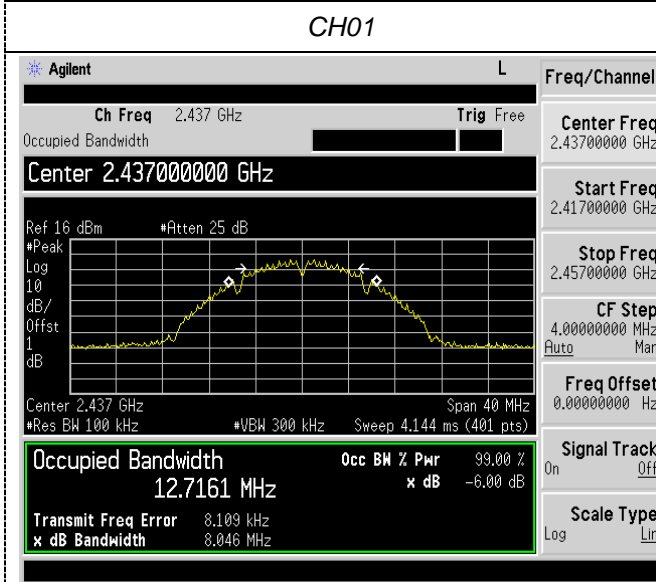
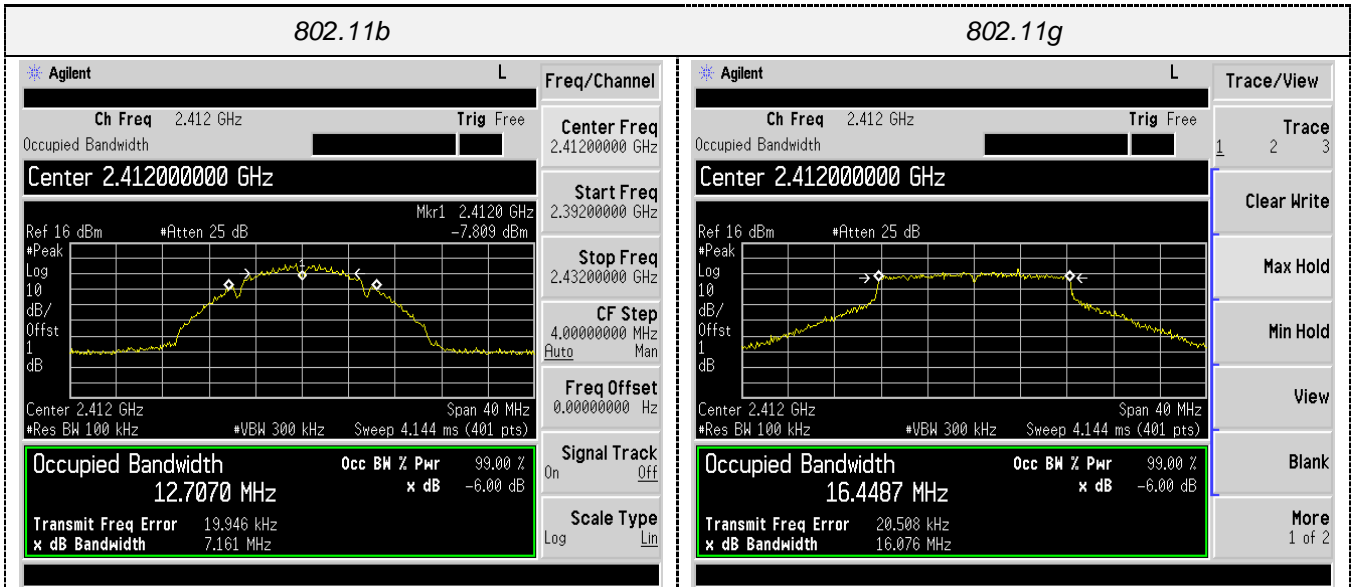

CH11

CH11

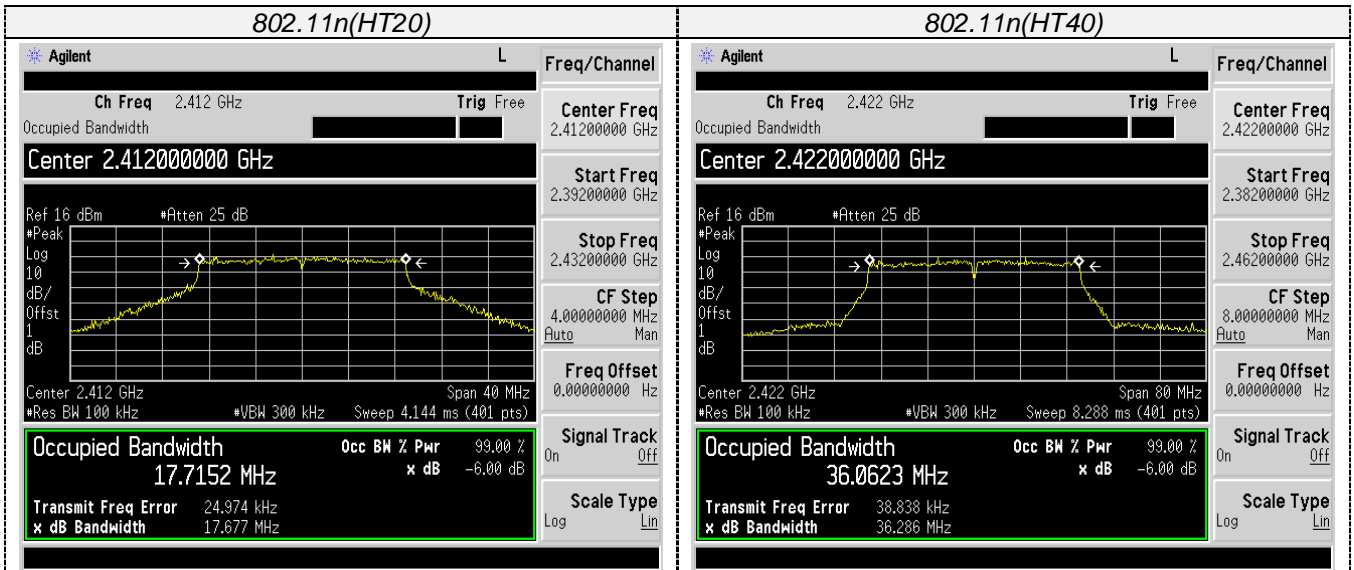

CH01

CH03

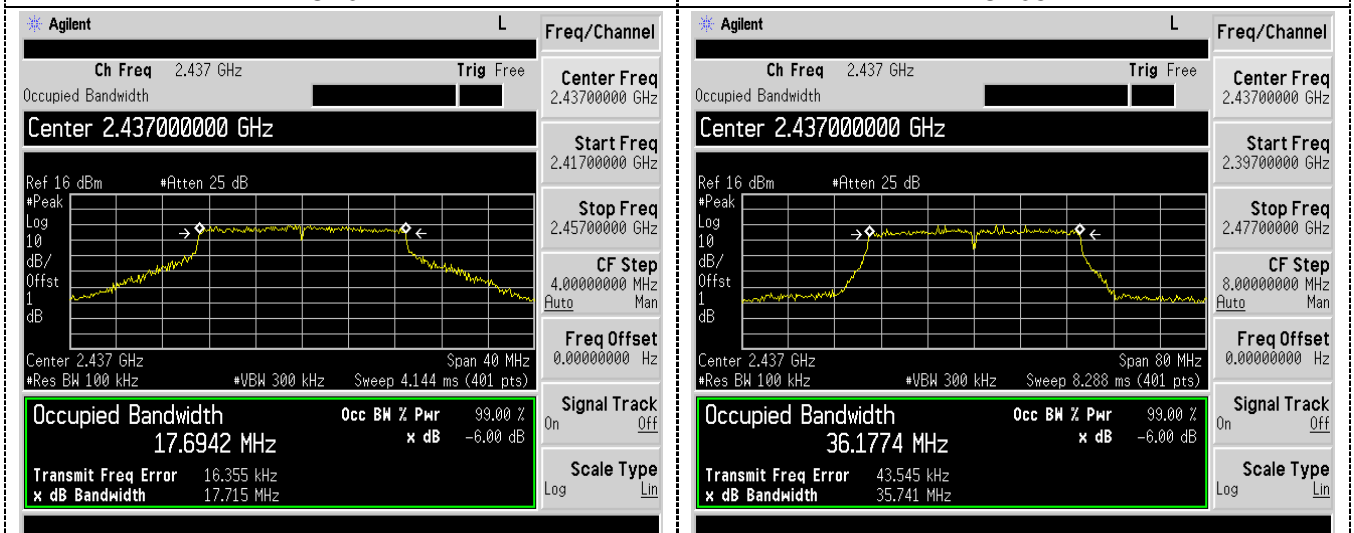

CH06

CH06



CH11

CH09

4.6 Out-of-band Emissions

Limit

In any 100 kHz bandwidth outside the frequency band in which the spread spectrum or digitally modulated intentional radiator is operating, the radio frequency power that is produced by the intentional radiator shall be at least 20 dB below that in the 100 kHz bandwidth within the band that contains the highest level of the desired power, based on either an RF conducted or a radiated measurement, provided the transmitter demonstrates compliance with the peak conducted power limits. If the transmitter complies with the conducted power limits based on the use of RMS averaging over a time interval, as permitted under paragraph (b)(3) of this section, the attenuation required under this paragraph shall be 30 dB instead of 20 dB. Attenuation below the general limits specified in §15.209(a) is not required.

Test Procedure

Connect the transmitter output to spectrum analyzer using a low loss RF cable, and set the spectrum analyzer to RBW=100 kHz, VBW= 300 kHz, peak detector , and max hold. Measurements utilizing these setting are made of the in-band reference level, bandedge and out-of-band emissions.

Test Configuration

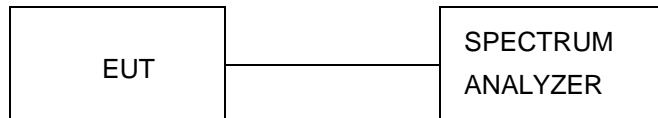

Test Results

Temperature	22.8°C	Humidity	56%
Test Engineer	Moon Tan	Configurations	WLAN2.4G

Remark: The measurement frequency range is from 30MHz to the 10th harmonic of the fundamental frequency. The lowest, middle and highest channels are tested to verify the spurious emissions and bandage measurement data.

Test plot as follows:

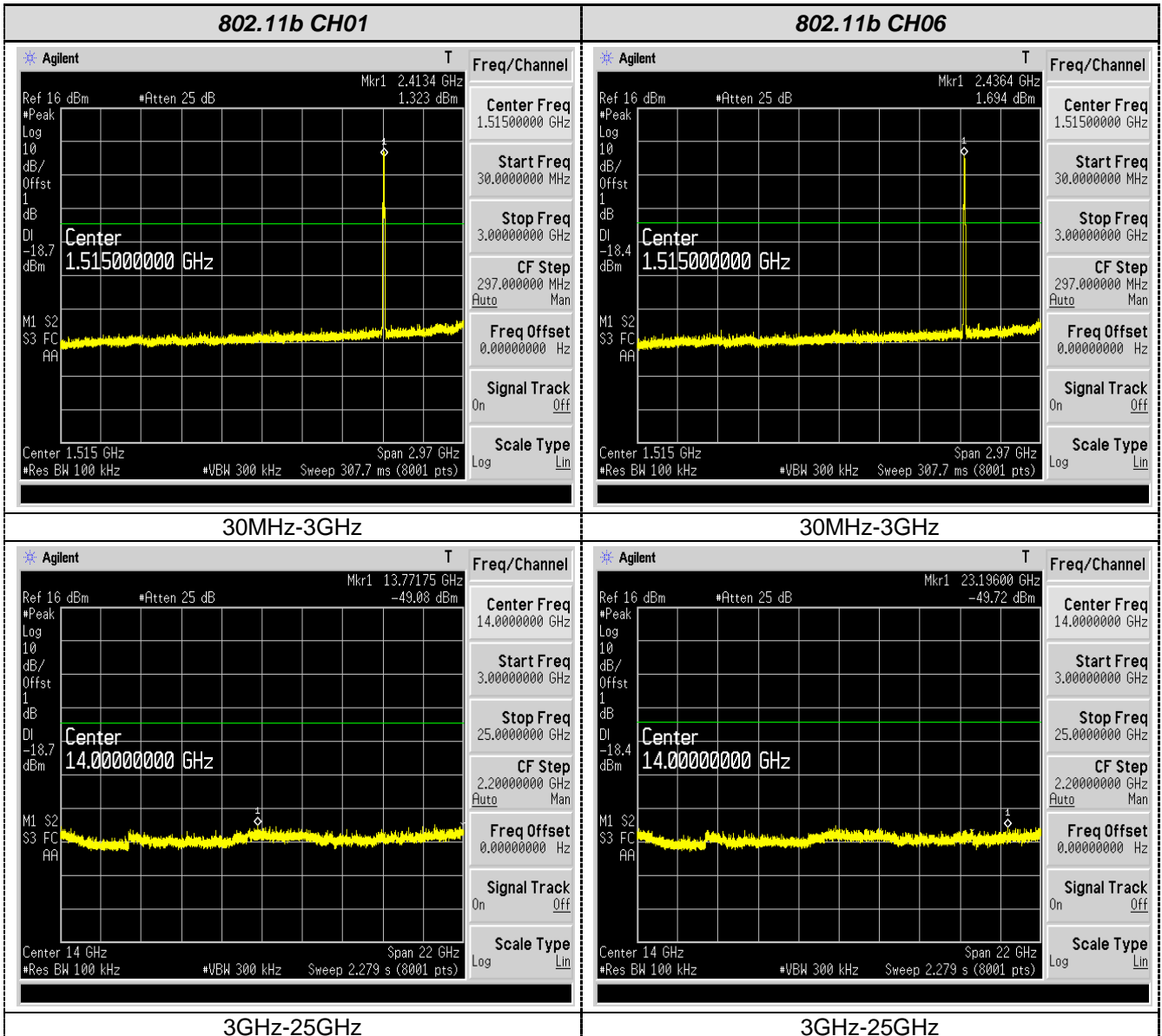

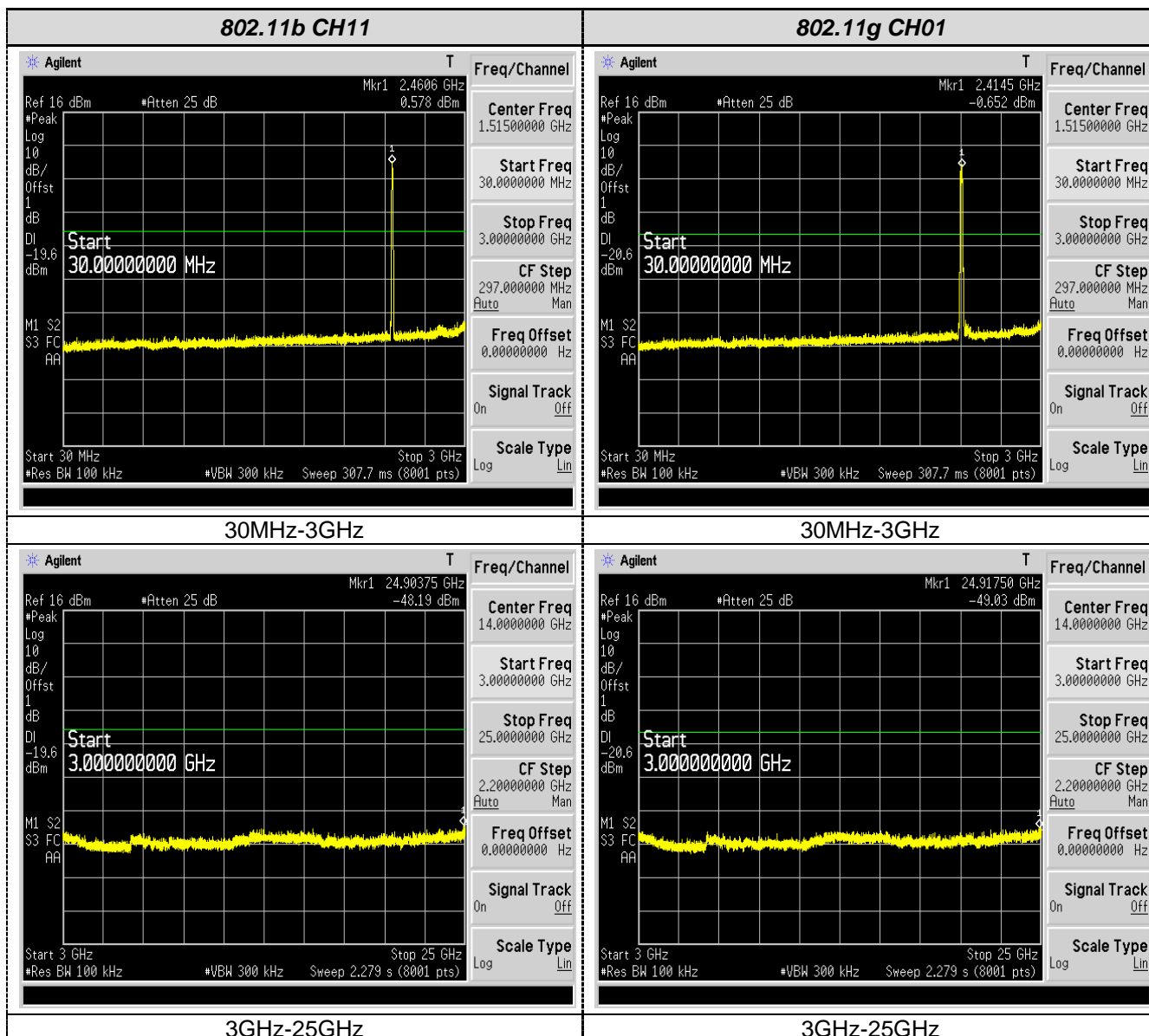

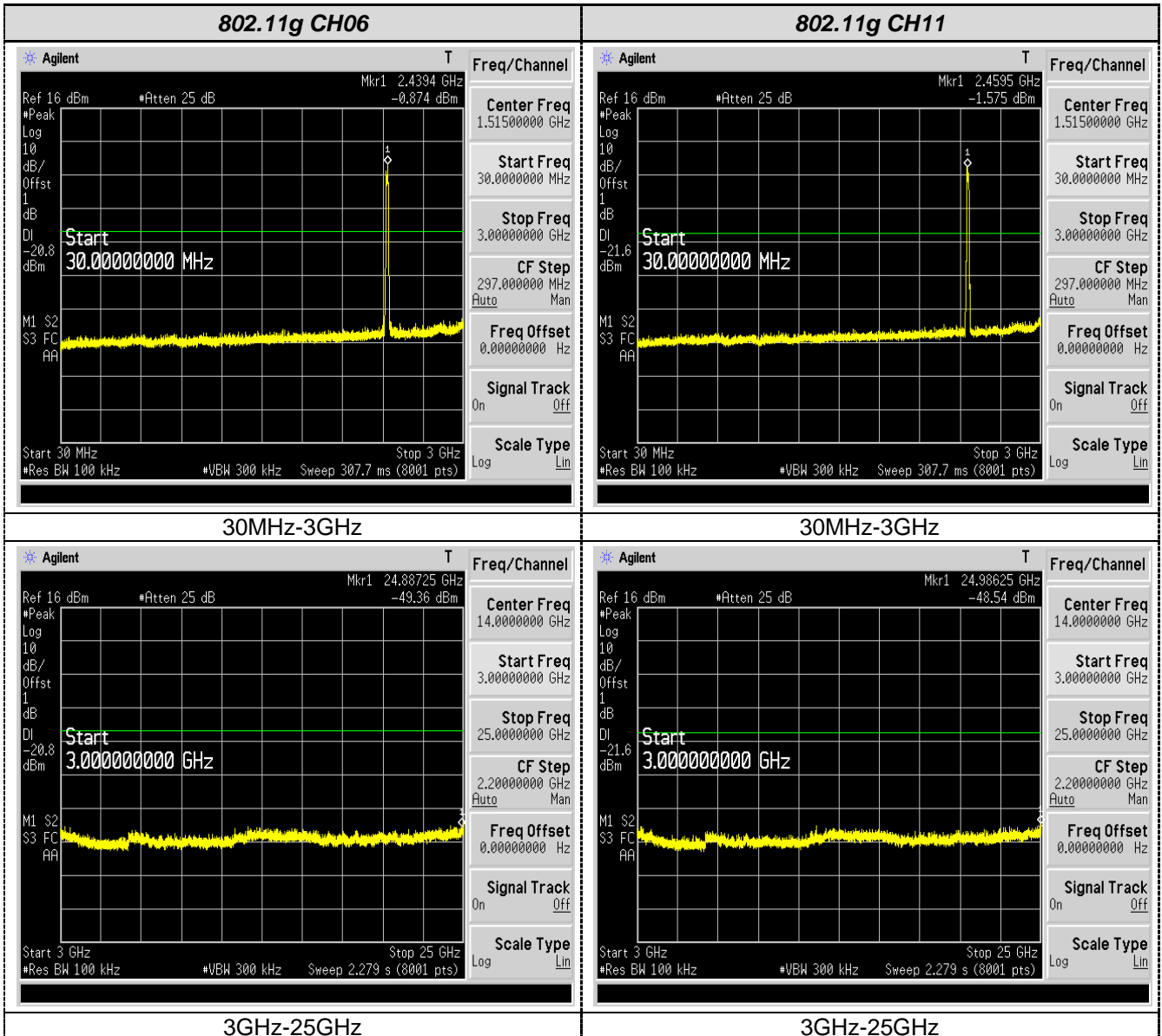

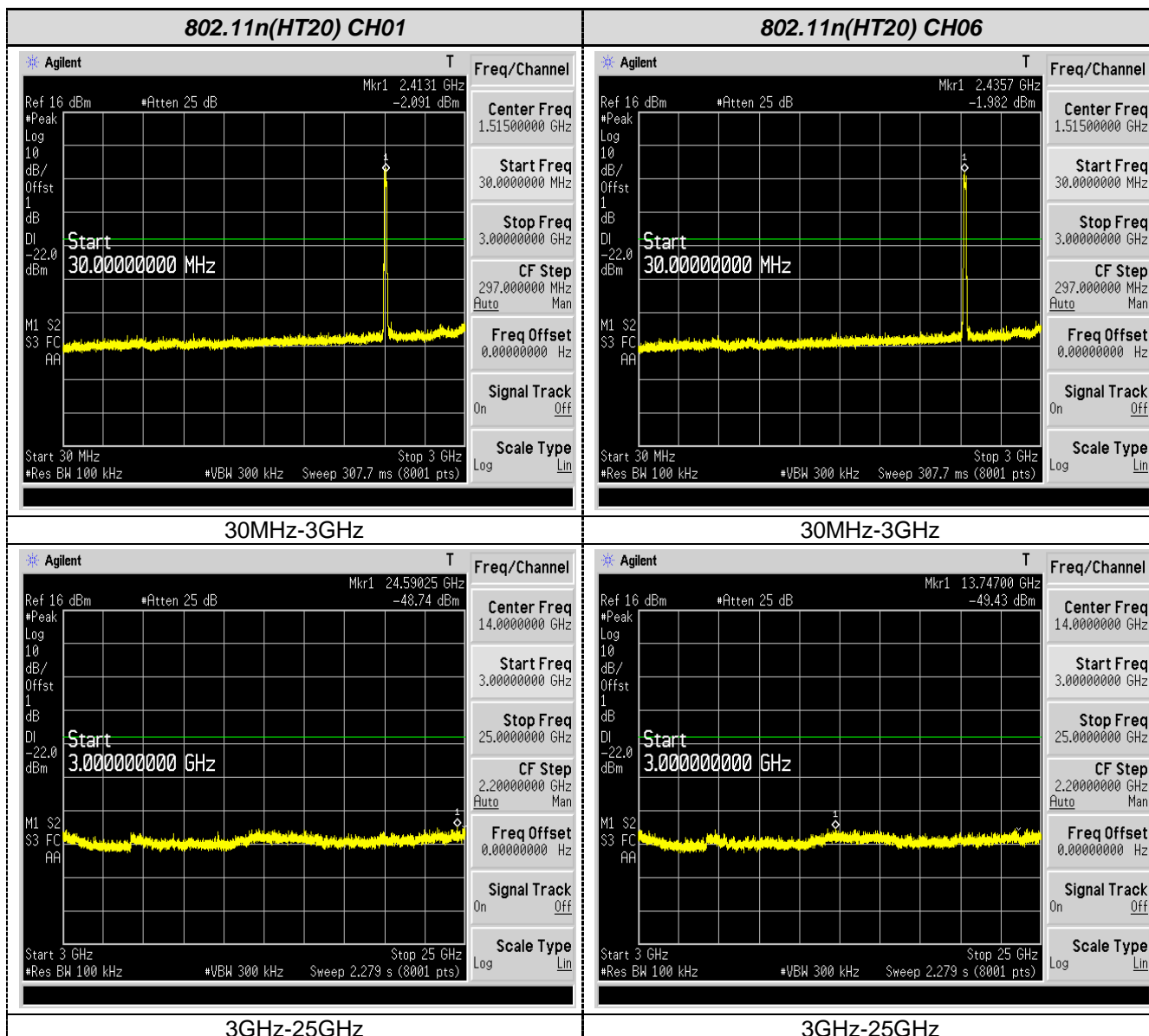

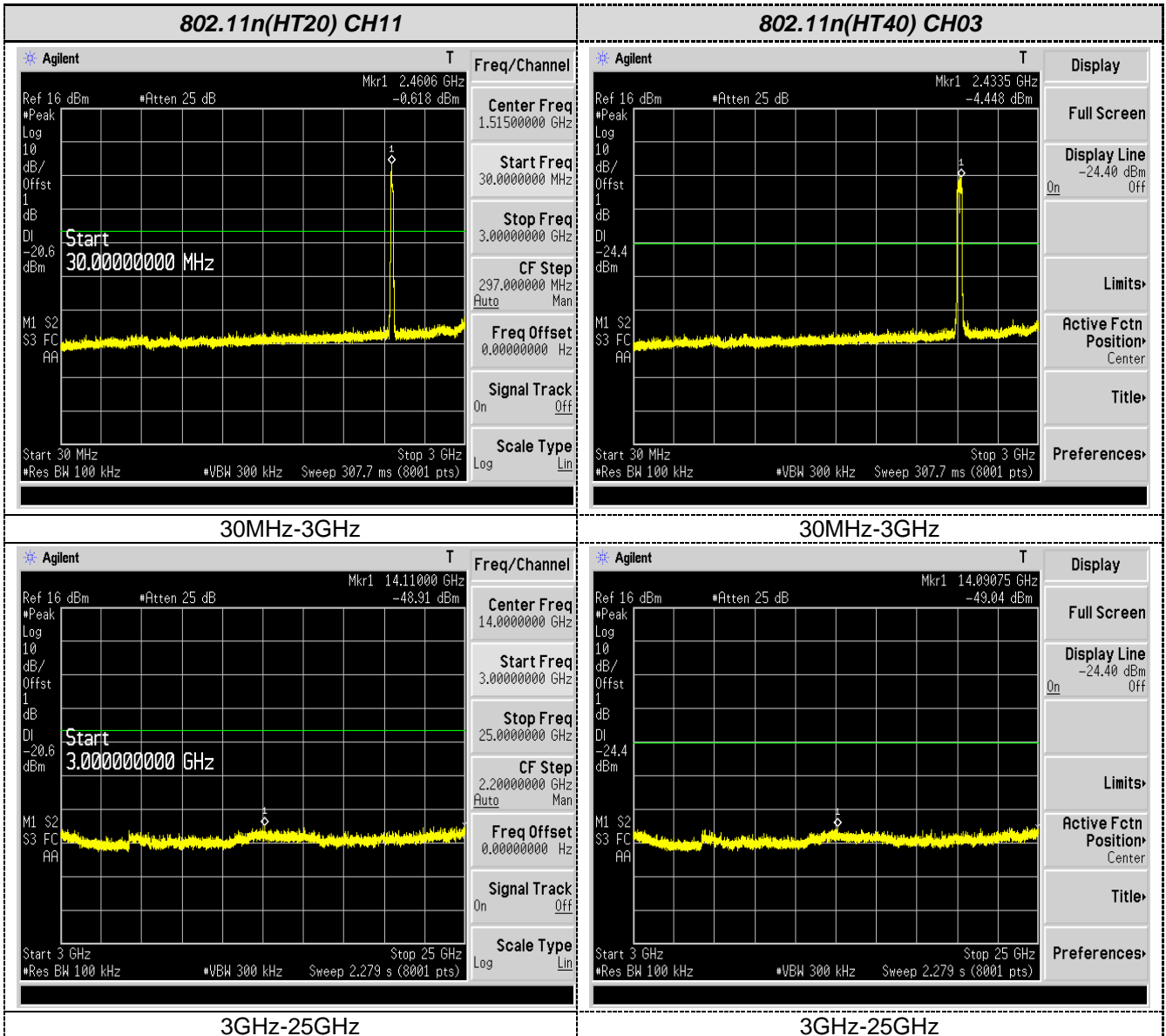

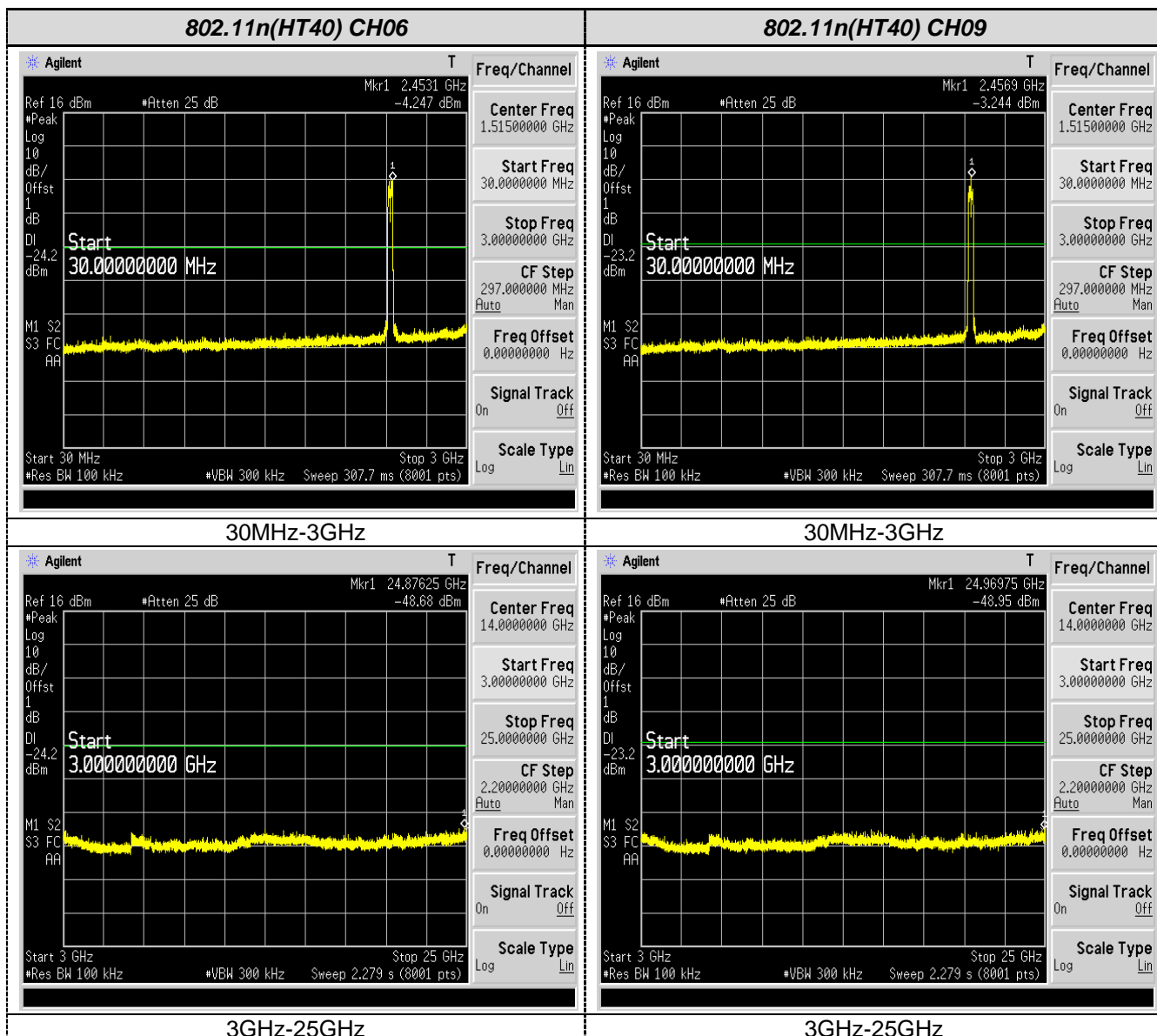

Band-edge Measurements for RF Conducted Emissions:

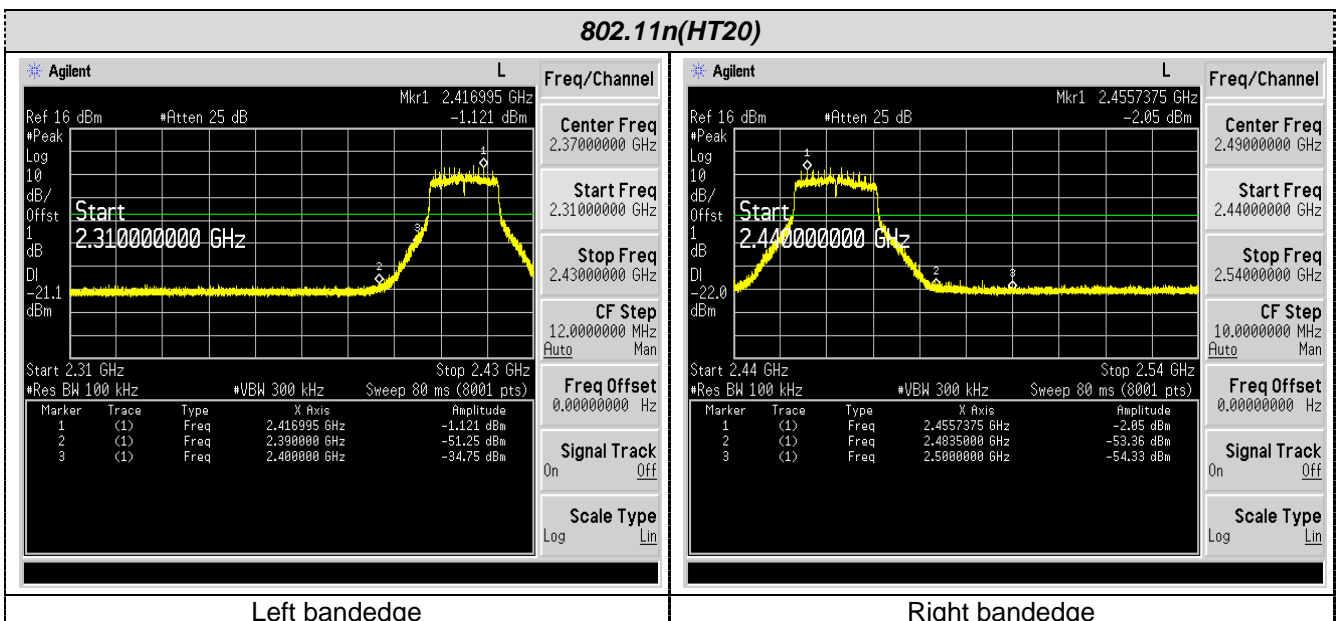
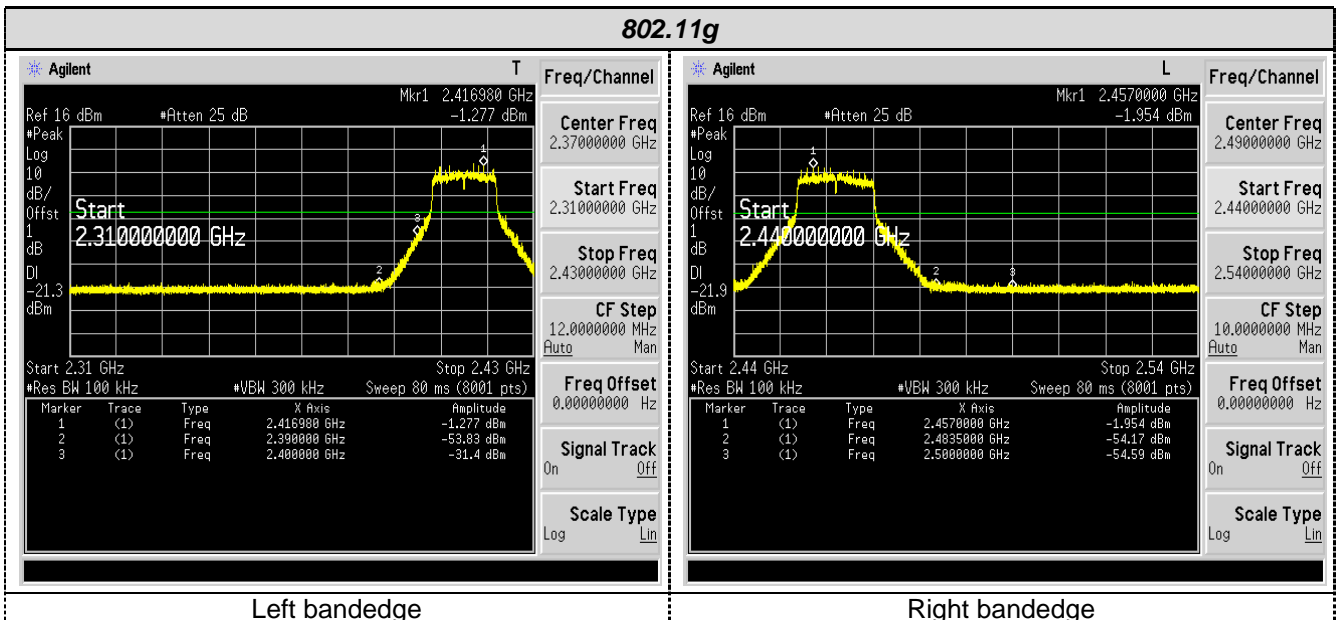
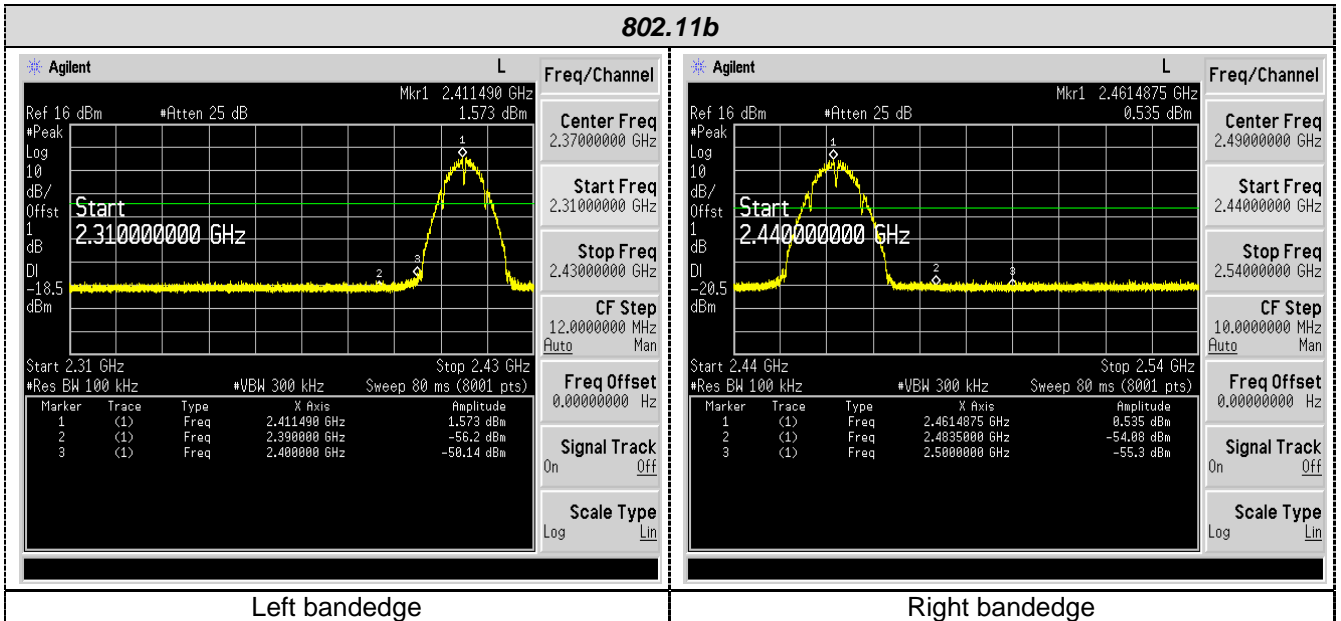

802.11n(HT40)

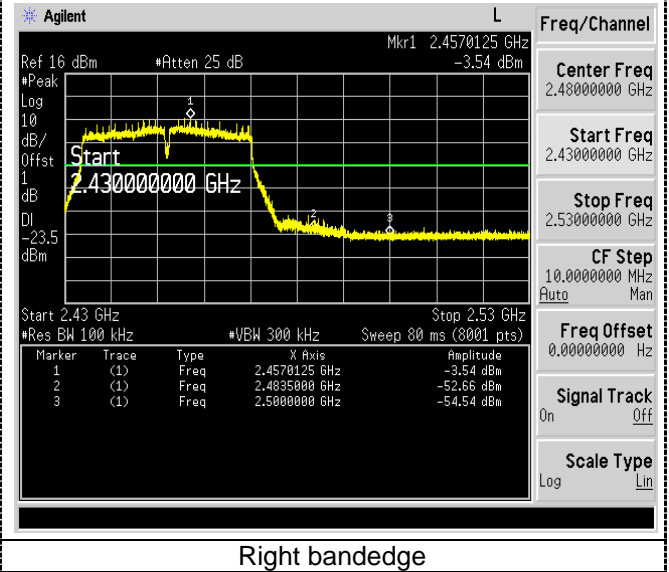
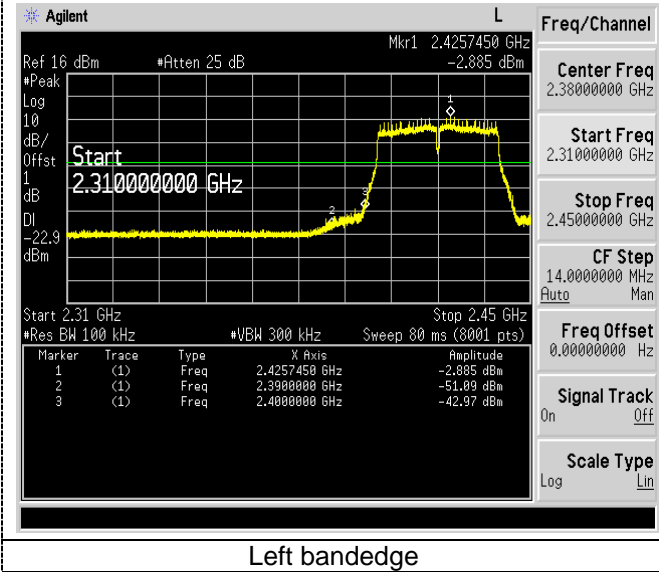

4.7 Antenna Requirement

Standard Applicable

For intentional device, according to FCC 47 CFR Section 15.203:

An intentional radiator shall be designed to ensure that no antenna other than that furnished by the responsible party shall be used with the device. The use of a permanently attached antenna or of an antenna that uses a unique coupling to the intentional radiator, the manufacturer may design the unit so that a broken antenna can be replaced by the user, but the use of a standard antenna jack or electrical connector is prohibited

FCC CFR Title 47 Part 15 Subpart C Section 15.247(c) (1) (I):

(i) Systems operating in the 2400-2483.5 MHz band that is used exclusively for fixed. Point-to-point operations may employ transmitting antennas with directional gain greater than 6dBi provided the maximum conducted output power of the intentional radiator is reduced by 1 dB for every 3 dB that the directional gain of the antenna exceeds 6dBi.

Test Result:

The maximum gain of antenna was 2.0dBi for 2.4GHz WIFI.

5 Test Setup Photos of the EUT

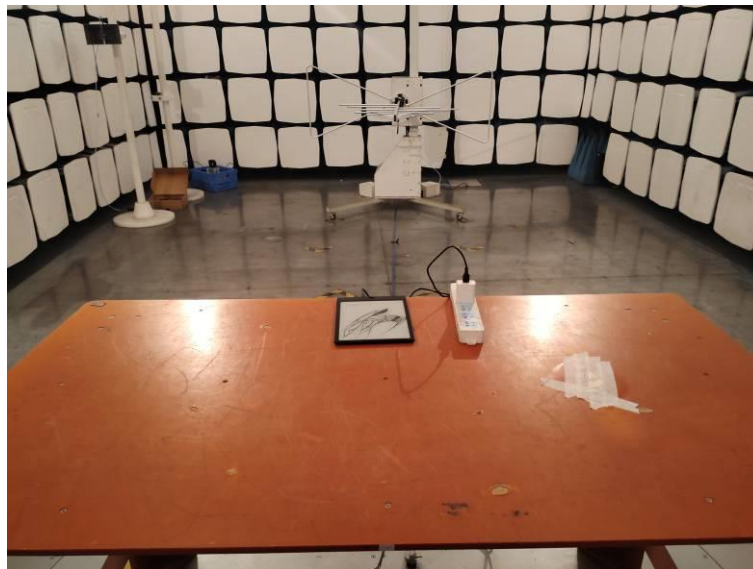
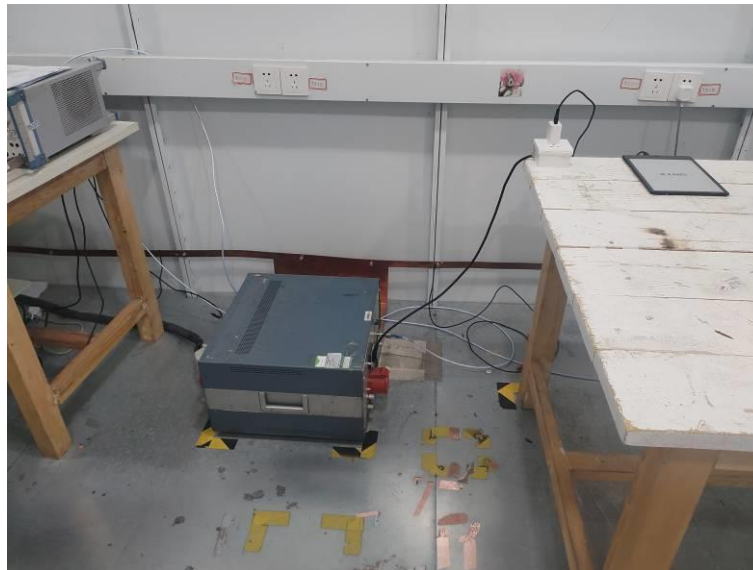

6 Photos of the EUT

External Photos of EUT

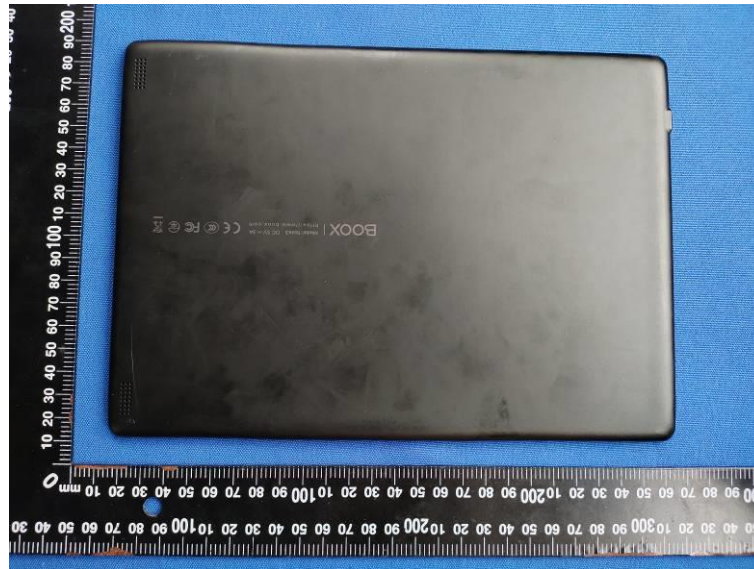

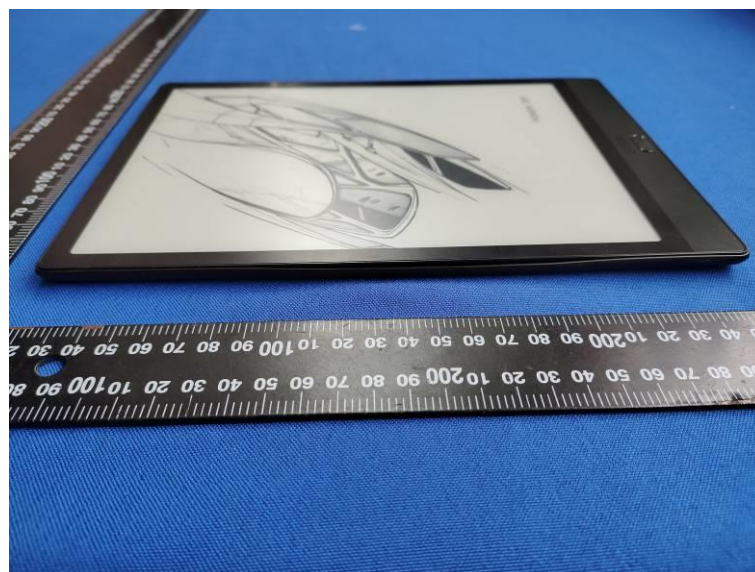

Internal Photos

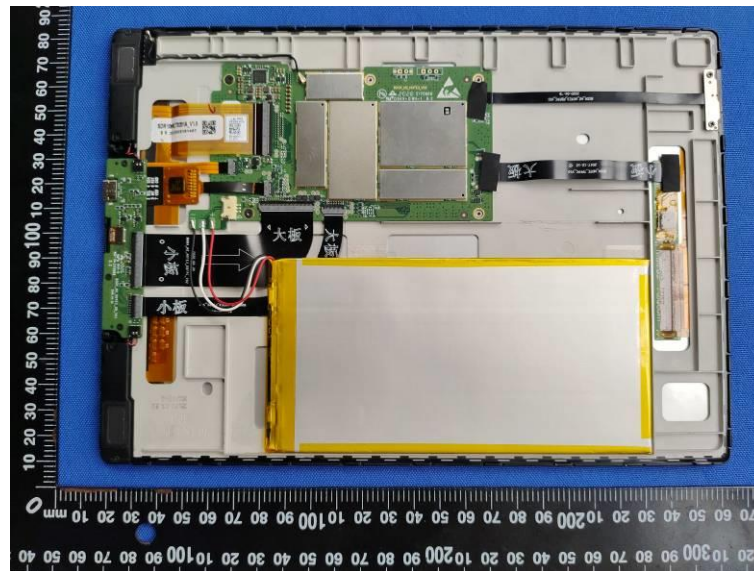
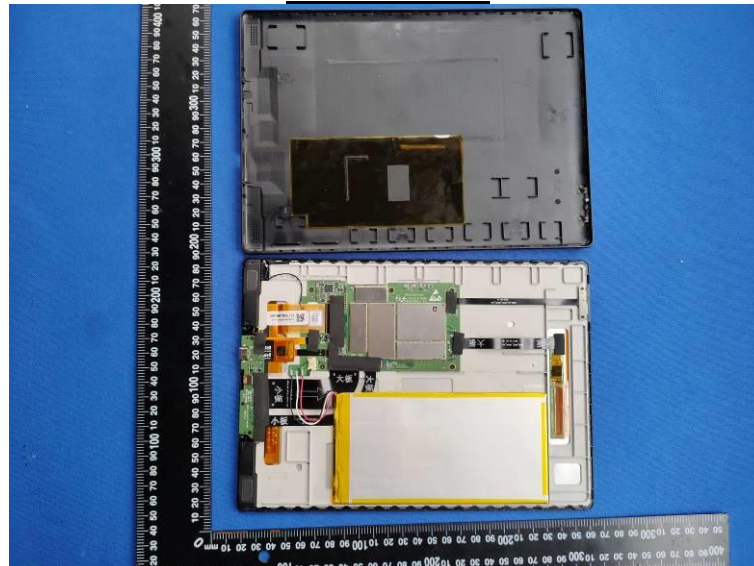

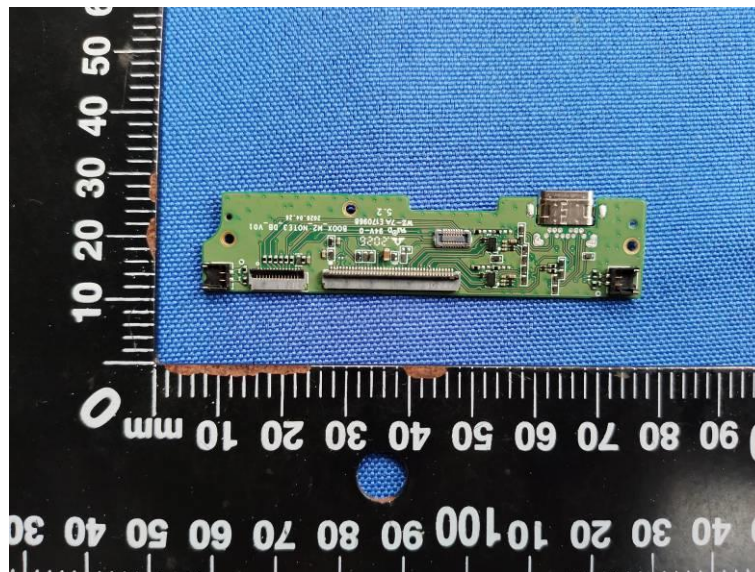
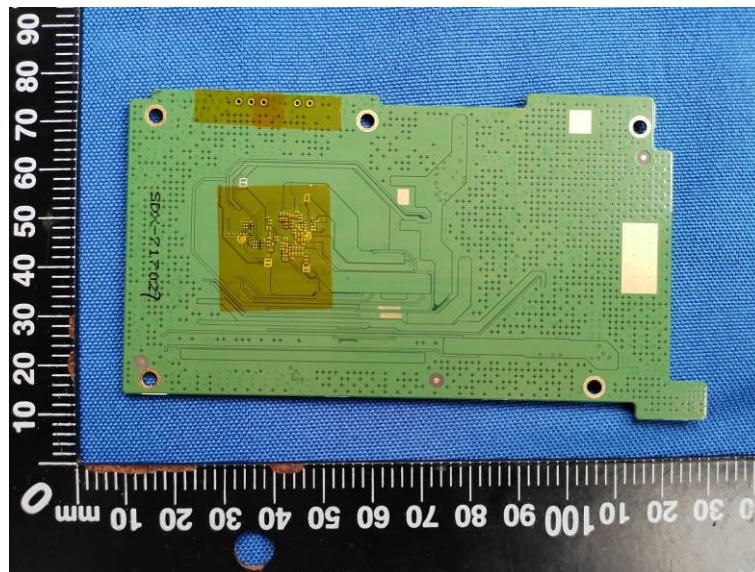
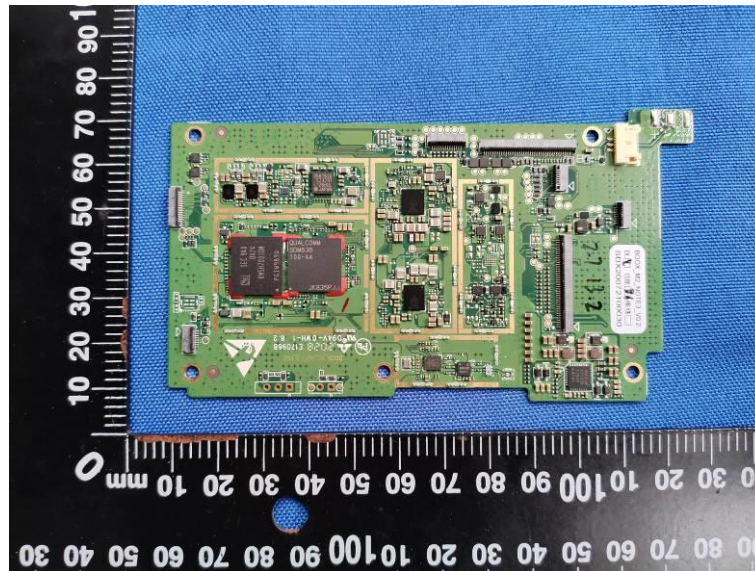

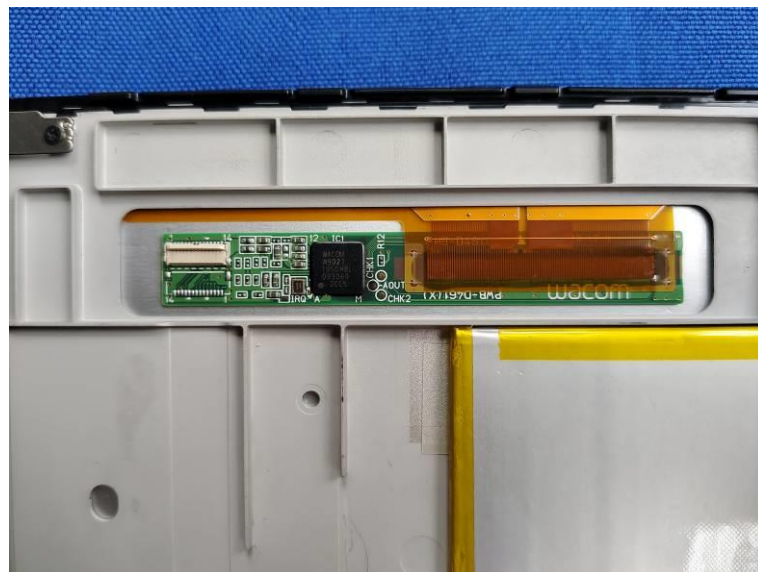
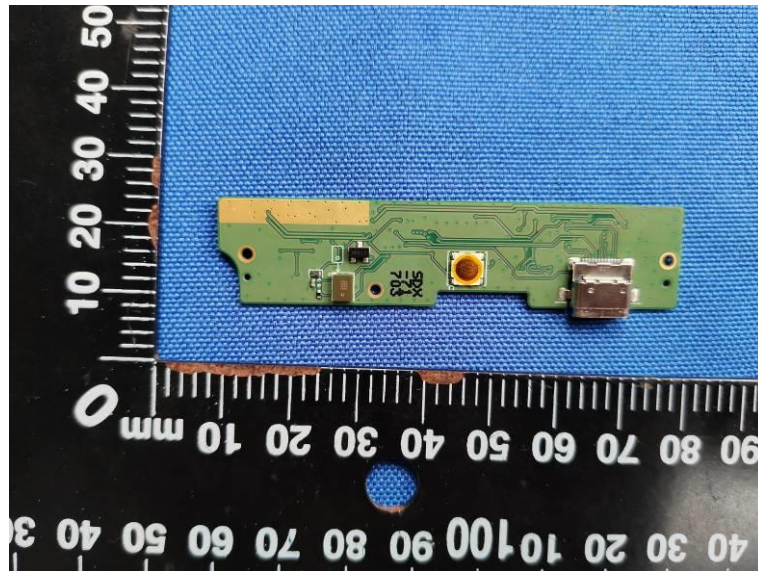

***** End of Report *****