



MEASUREMENT REPORT

FCC PART 15.247 WLAN 802.11b/g/n

FCC ID: XR3-KEPLER3026
APPLICANT: ONYX INTERNATIONAL INC.
Application Type: Certification
Product: E-reader
Model No.: Kepler
Series Model: Monte Cristo 2, Kepler plus, Kepler Pro, Kepler Lite
FCC Classification: (DTS) Digital Transmission System
FCC Rule Part(s): Part 15.247
Test Procedure(s): ANSI C63.10-2013, KDB 558074 D01v04
Test Date: June 1~3, 2017

Test By : *Kevin Ker*
(Peter Ker)
Reviewed By : *Paddy Chen*
(Paddy Chen)
Approved By : *Chenz Ker*
(Chenz Ker)



The test results relate only to the samples tested.

This equipment has been shown to be capable of compliance with the applicable technical standards as indicated in the measurement report and was tested in accordance with the measurement procedures specified in ANSI C63.4-2014. Test results reported herein relate only to the item(s) tested.

The test report shall not be reproduced except in full without the written approval of MRT Technology (Taiwan) Co., Ltd.

Revision History

Report No.	Version	Description	Issue Date	Note
1705TW0116-U4	1.0	Original Report	2017-06-08	

CONTENTS

Description	Page
§2.1033 General Information	5
1. INTRODUCTION	6
1.1. Scope.....	6
1.2. MRT Test Location.....	6
2. PRODUCT INFORMATION	7
2.1. Equipment Description	7
2.2. Working Frequencies for this Report	8
2.3. Test Mode.....	9
2.4. Test Software	9
2.5. Test Configuration.....	10
2.6. EMI Suppression Device(s)/Modifications	10
2.7. Labeling Requirements	10
3. DESCRIPTION of TEST	11
3.1. Evaluation Procedure	11
3.2. AC Line Conducted Emissions	11
3.3. Radiated Emissions	12
4. ANTENNA REQUIREMENTS.....	13
5. TEST EQUIPMENT CALIBRATION DATE.....	14
6. MEASUREMENT UNCERTAINTY.....	15
7. TEST RESULT	16
7.1. Summary.....	16
7.2. 6dB Bandwidth Measurement	17
7.2.1. Test Limit.....	17
7.2.2. Test Procedure used	17
7.2.3. Test Setting	17
7.2.4. Test Setup.....	17
7.2.5. Test Result	18
7.3. Output Power Measurement.....	21
7.3.1. Test Limit.....	21
7.3.2. Test Procedure Used.....	21
7.3.3. Test Setting	21
7.3.4. Test Setup.....	21
7.3.5. Test Result of Output Power	22
7.4. Power Spectral Density Measurement	23
7.4.1. Test Limit.....	23
7.4.2. Test Procedure Used.....	23
7.4.3. Test Setting	23
7.4.4. Test Setup.....	23
7.4.5. Test Result	24
7.5. Out-of-Band Spurious Emissions Emissions Measurement.....	27

7.5.1.	Test Limit	27
7.5.2.	Test Procedure Used	27
7.5.3.	Test Settintg	27
7.5.4.	Test Setup	27
7.5.5.	Test Result	28
7.6.	Radiated Spurious Emission Measurement.....	37
7.6.1.	Test Limit	37
7.6.2.	Test Procedure Used	37
7.6.3.	Test Setting	37
7.6.4.	Test Setup	39
7.6.5.	Test Result	41
7.7.	Radiated Restricted Band Edge Measurement.....	71
7.7.1.	Test Limit	71
7.7.2.	Test Procedure Used	71
7.7.3.	Test Setting	71
7.7.4.	Test Setup	73
7.7.5.	Test Result	74
7.8.	AC Conducted Emissions Measurement	90
7.8.1.	Test Limit	90
7.8.2.	Test Setup	90
7.8.3.	Test Result	91
8.	CONCLUSION	93
	Appendix A - Test Photograph	94
	Appendix B - External Photograph	96
	Appendix C - Internal Photograph	101

§2.1033 General Information

Applicant	ONYX INTERNATIONAL INC.
Applicant Address	Room 102, 3rd Floor, No. 38 HongLou Road, LiWan District, GuangZhou, China
Manufacturer	ONYX INTERNATIONAL INC.
Manufacturer Address	Room 102, 3rd Floor, No. 38 HongLou Road, LiWan District, GuangZhou, China
Test Site	MRT Technology (Taiwan) Co., Ltd
Test Site Address	No. 38, Fuxing Second Rd., Guishan Dist., Taoyuan City 333, Taiwan (R.O.C)
MRT FCC Registration No.	291082
FCC Rule Part(s)	Part 15.247
Model No.	Kepler
FCC ID	XR3-KEPLER3026
Test Device Serial No.	N/A <input type="checkbox"/> Production <input checked="" type="checkbox"/> Pre-Production <input type="checkbox"/> Engineering

Test Facility / Accreditations

1. MRT facility is a FCC registered (Reg. No. 291082) test facility with the site description report on file and is designated by the FCC as an Accredited Test Film.
2. MRT facility is an IC registered (MRT Reg. No. 21723-1) test laboratory with the site description on file at Industry Canada.
3. MRT Lab is accredited to ISO 17025 by the Taiwan Accreditation Foundation (TAF Cert. No. 3261) in EMC, Telecommunications and Radio testing for FCC, Industry Taiwan, EU and TELEC Rules.

1. INTRODUCTION

1.1. Scope

Measurement and determination of electromagnetic emissions (EMC) of radio frequency devices including intentional and/or unintentional radiators for compliance with the technical rules and regulations of the Federal Communications Commission and the Industry Canada Certification and Engineering Bureau.

1.2. MRT Test Location

The map below shows the location of the MRT LABORATORY, its proximity to the Taoyuan City. These measurement tests were conducted at the MRT Technology (Taiwan) Co., Ltd. Facility located at No.38, Fuxing 2nd Rd., Guishan Dist., Taoyuan City 33377, Taiwan (R.O.C).

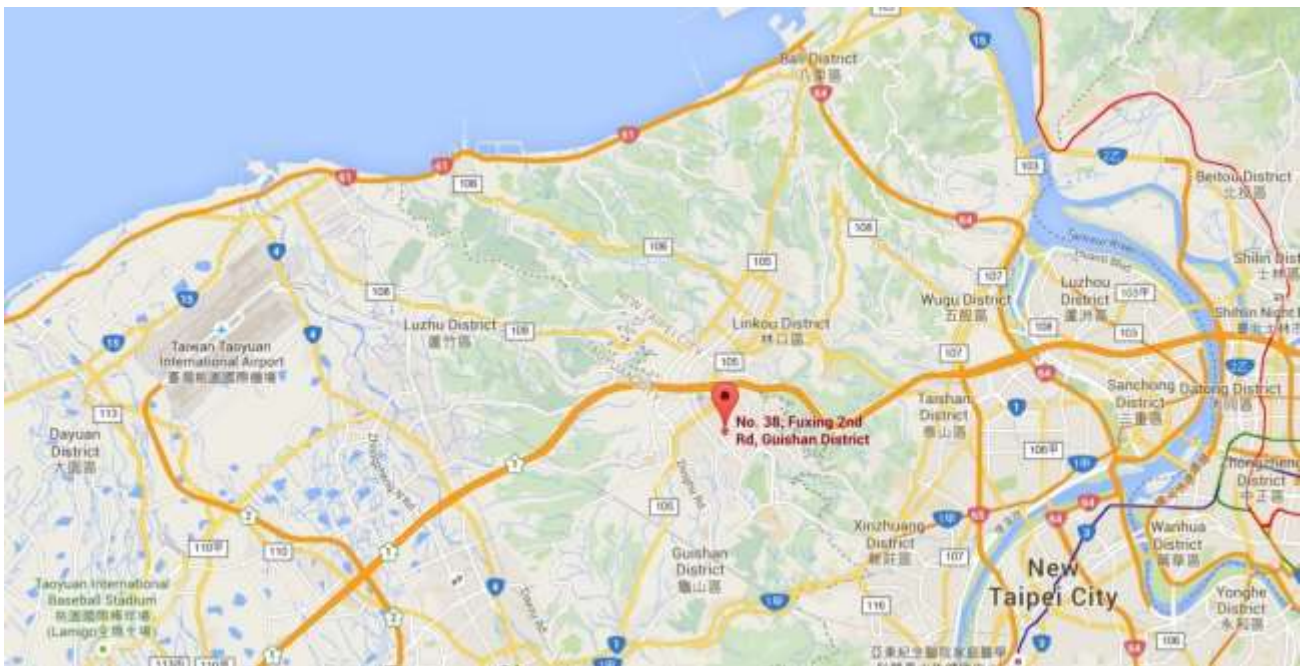

2. PRODUCT INFORMATION

2.1. Equipment Description

Product Name	E-reader
FCC ID	XR3-KEPLER3026
Model No.	Kepler
Series Model:	Monte Cristo 2, Kepler plus, Kepler Pro, Kepler Lite
Supports Radios Spec.	WLAN : 2.4G : 802.11b/g/n-20/n-40; WPAN : Bluetooth V4.0
Wi-Fi Specification	802.11b/g/n
Frequency Range	2.4GHz: For 802.11b/g/n-20M/n-40: 2412 ~ 2462 MHz For 802.11n-40: 2422 ~ 2452 MHz
2.4GHz Maximum Output Power	802.11b: 10.93dBm 802.11g: 13.44dBm 802.11n-20M: 13.73dBm 802.11n-40M: 13.65dBm
Type of Modulation	802.11b: DSSS, DBPSK, DQPSK, CCK 802.11g/n-20M/n-40M: OFDM, BPSK, QPSK, 16QAM, 64QAM

Note : Model Difference: The different of models only for marketing different client, the other was the same.

2.2. Working Frequencies for this Report

Technology	Frequency (MHz)	Modulation	channel Spacing (MHz)	Data Rate (Mbps)	Number of Channels
802.11b	2412~2462	DSSS (CCK, DQPSK, DBPSK)	5	1 ~11	11
802.11g	2412~2462	OFDM (BPSK, QPSK, 16QAM, 64QAM)	5	6 ~54	11
802.11n-20M	2412~2462	OFDM (BPSK, QPSK, 16QAM, 64QAM)	5	7.2-72.2	11
802.11n-40M	2422~2452	OFDM (BPSK, QPSK, 16QAM, 64QAM)	5	15-150	7

802.11b/g/n-20M

Channel	Frequency	Channel	Frequency	Channel	Frequency
01	2412 MHz	02	2417 MHz	03	2422 MHz
04	2427 MHz	05	2432 MHz	06	2437 MHz
07	2442 MHz	08	2447 MHz	09	2452 MHz
10	2457 MHz	11	2462 MHz	--	--

802.11n-40M

Channel	Frequency	Channel	Frequency	Channel	Frequency
03	2422 MHz	04	2427 MHz	05	2432 MHz
06	2437 MHz	07	2442 MHz	08	2447 MHz
09	2452 MHz	--	--	--	--

2.3. Test Mode

Test Mode	Mode 1: Transmit by 802.11b
	Mode 2: Transmit by 802.11g
	Mode 3: Transmit by 802.11n-20M
	Mode 4: Transmit by 802.11n-40M
	Mode 5: Receive by 802.11n-20M

Note :

1. Regarding to the operation frequency, the lowest, middle and highest frequency are selected to perform the test.

2.4. Test Software

The test utility software used during testing was “REALTEK WLAN Test Ver:1.0.6”.

2.5. Test Configuration

This device was tested per the guidance of ANSI C63.10-2013 and DA 00-705. ANSI C63.10-2013 was used to reference the appropriate EUT setup for radiated spurious emissions testing and AC line conducted testing.

2.6. EMI Suppression Device(s)/Modifications

No EMI suppression device(s) were added and/or no modifications were made during testing.

2.7. Labeling Requirements

Per 2.1074 & 15.19; Docket 95-19

The label shall be permanently affixed at a conspicuous location on the device; instruction manual or pamphlet supplied to the user and be readily visible to the purchaser at the time of purchase. However, when the device is so small wherein placement of the label with specified statement is not practical, only the FCC ID must be displayed on the device per Section 15.19(a)(5). Please see attachment for FCC ID label and label location.

3. DESCRIPTION of TEST

3.1. Evaluation Procedure

The measurement procedures described in the American National Standard for Testing Unlicensed Wireless Devices (ANSI C63.10-2013), and the guidance provided in KDB 558074 D01v04 were used in the measurement of the device.

Deviation from measurement procedure.....None

3.2. AC Line Conducted Emissions

The line-conducted facility is located inside an 9'x4'x3' shielded enclosure. A 1m x 2m wooden table 80cm high is placed 40cm away from the vertical wall and 80cm away from the sidewall of the shielded room. Two 10kHz-30MHz, 50Ω/50uH Line-Impedance Stabilization Networks (LISNs) are bonded to the shielded room floor. Power to the LISNs is filtered by external high-current high-insertion loss power line filters. These filters attenuate ambient signal noise from entering the measurement lines. These filters are also bonded to the shielded enclosure.

The EUT is powered from one LISN and the support equipment is powered from the second LISN. All interconnecting cables more than 1 meter were shortened to a 1 meter length by non-inductive bundling (serpentine fashion) and draped over the back edge of the test table. All cables were at least 40cm above the horizontal reference ground-plane. Power cables for support equipment were routed down to the second LISN while ensuring that that cables were not draped over the second LISN.

Sufficient time for the EUT, support equipment, and test equipment was allowed in order for them to warm up to their normal operating condition. The RF output of the LISN was connected to the receiver and exploratory measurements were made to determine the frequencies producing the maximum emission from the EUT. The receiver was scanned from 150kHz to 30MHz. The detector function was set to peak mode for exploratory measurements while the bandwidth of the analyzer was set to 9kHz. The EUT, support equipment, and interconnecting cables were arranged and manipulated to maximize each emission. Each emission was also maximized by varying: power lines, the mode of operation or data exchange speed, or support equipment which determined the worst-case emission. Once the worst case emissions have been identified, the one EUT cable configuration/arrangement and mode of operation that produced these emissions are used for final measurements on the same test site. The analyzer is set to CISPR quasi-peak and average detectors with a 9kHz resolution bandwidth for final measurements.

An extension cord was used to connect to a single LISN which powered by EUT. The extension cord was calibrated with LISN, the impedance and insertion loss are compliance with the requirements as stated in ANSI C63.10-2013.

Line conducted emissions test results are shown in Section 7.8.

3.3. Radiated Emissions

The radiated test facilities consisted of an indoor 3 meter semi-anechoic chamber used for final measurements and exploratory measurements, when necessary. The measurement area is contained within the semi-anechoic chamber which is shielded from any ambient interference. For measurements above 1GHz absorbers are arranged on the floor between the turn table and the antenna mast in such a way so as to maximize the reduction of reflections. For measurements below 1GHz, the absorbers are removed. A MF Model 210SS turntable is used for radiated measurement. It is a continuously rotatable, remote controlled, metallic turntable and 2 meters (6.56 ft.) in diameter. The turn table is flush with the raised floor of the chamber in order to maintain its function as a ground plane. An 80cm high PVC support structure is placed on top of the turntable. For all measurements, the spectrum was scanned through all EUT azimuths and from 1 to 4 meter receive antenna height using a broadband antenna from 30MHz up to the upper frequency shown in 15.33(b)(1) depending on the highest frequency generated or used in the device or on which the device operates or tunes. For frequencies above 1GHz, linearly polarized double ridge horn antennas were used. For frequencies below 30MHz, a calibrated loop antenna was used. When exploratory measurements were necessary, they were performed at 1 meter test distance inside the semi-anechoic chamber using broadband antennas, broadband amplifiers, and spectrum analyzers to determine the frequencies and modes producing the maximum emissions. Sufficient time for the EUT, support equipment, and test equipment was allowed in order for them to warm up to their normal operating condition. The test set-up for frequencies below 1GHz was placed on top of the 0.8 meter high, 1 x 1.5 meter table; and test set-up for frequencies 1-40GHz was placed on top of the 1.5 meter high, 1 x 1.5 meter table. The EUT, support equipment, and interconnecting cables were arranged and manipulated to maximize each emission. Appropriate precaution was taken to ensure that all emissions from the EUT were maximized and investigated. The system configuration, clock speed, mode of operation or video resolution, if applicable, turntable azimuth, and receive antenna height was noted for each frequency found.

Final measurements were made in the semi-anechoic chamber using calibrated, linearly polarized broadband and horn antennas. The test setup was configured to the setup that produced the worst case emissions. The spectrum analyzer was set to investigate all frequencies required for testing to compare the highest radiated disturbances with respect to the specified limits. The turntable containing the EUT was rotated through 360 degrees and the height of the receive antenna was varied 1 to 4 meters and stopped at the azimuth and height producing the maximum emission. Each emission was maximized by changing the orientation of the EUT through three orthogonal planes and changing the polarity of the receive antenna, which produced the worst-case emissions.

According to 3dB Beam-Width of horn antenna, the horn antenna should be always directed to the EUT when rising height.

Radiated emissions test results are shown in Section 7.6 & 7.7 .

4. ANTENNA REQUIREMENTS

Excerpt from §15.203 of the FCC Rules/Regulations:

“An intentional radiator antenna shall be designed to ensure that no antenna other than that furnished by the responsible party can be used with the device. The use of a permanently attached antenna or of an antenna that uses a unique coupling to the intentional radiator shall be considered sufficient to comply with the provisions of this section.”

- The antenna of the **E-READER**, is permanently attached.
- There are no provisions for connection to an external antenna.

Conclusion:

The EUT unit complies with the requirement of §15.203.

Antenna List

No.	Manufacturer	Part No.	Antenna Type	Peak Gain
1	ONYX International Inc.	Kepler	FPCB	1.45dBi

5. TEST EQUIPMENT CALIBRATION DATE

Conducted Emissions – SR2

Instrument	Manufacturer	Type No.	Asset No.	Cali. Interval	Cali. Due Date
Two-Line V-Network	R&S	ENV216	MRTTWA00019	1 year	2018.03.15
Cable	Rosnol	N1C50-RG400- B1C50-500CM	MRTTWE00013	1 year	2018.05.19
EMI Test Receiver	R&S	ESR3	MRTTWA00009	1 year	2018.03.16

Radiated Emissions – AC1

Instrument	Manufacturer	Type No.	Asset No.	Cali. Interval	Cali. Due Date
Broadband TRILOG Antenna	SCHWARZBECK	VULB 9162	MRTTWA00001	1 year	2018.05.14
EMI Test Receiver	R&S	ESR3	MRTTWA00009	1 year	2018.03.16
Active Loop Antenna	Schwarzbeck	FMZB 1519B	MRTTWA00002	1 year	2018.04.13
Broadband Horn antenna	SCHWARZBECK	BBHA 9120D	MRTTWA00003	1 year	2018.04.17
Breitband Hornantenna	Schwarzbeck	BBHA 9170	MRTTWA00004	1 year	2018.4.24
Broadband Amplifier	Schwarzbeck	BBV 9721	MRTTWA00006	1 year	2018.4.24
Broadband Preamplifier	SCHWARZBECK	BBV 9718	MRTTWA00005	1 year	2018.4.19
Cable	HUBERSUHNER	SF106	MRTTWA00010	1 year	2018.05.19
Cable	Rosnol	K1K50-UP0264- K1K50-4M	MRTTWA00012	1 year	2018.05.19
Broadband TRILOG Antenna	SCHWARZBECK	VULB 9162	MRTTWA00001	1 year	2018.05.14

Conducted Test Equipment – SR2

Instrument	Manufacturer	Type No.	Asset No.	Cali. Interval	Cali. Due Date
Spectrum Analyzer	KEYSIGHT	N9010A	MRTTWA00012	1 year	2017.07.10
USB Wideband Power Sensor	KEYSIGHT	U2021XA	MRTTWA00015	1 year	2018.03.19

Test Software

Software	Version	Function
e3	9.160520a	EMI Test Software
EMI	V3	EMI Test Software

6. MEASUREMENT UNCERTAINTY

Where relevant, the following test uncertainty levels have been estimated for tests performed on the EUT as specified in CISPR 16-4-2. This uncertainty represents an expanded uncertainty expressed at approximately the 95% confidence level using a coverage factor of $k = 2$.

AC Conducted Emission Measurement – SR2
Measuring Uncertainty for a Level of Confidence of 95% ($U=2Uc(y)$): 150kHz~30MHz: 2.42dB
Conducted Measurement– SR1
Measuring Uncertainty for a Level of Confidence of 95% ($U=2Uc(y)$): 1.3dB
Radiated Emission Measurement – AC1
Measuring Uncertainty for a Level of Confidence of 95% ($U=2Uc(y)$): Horizontal: 9K~30MHz: 4.14dB 30MHz~1GHz: 4.22dB 1GHz~40GHz: 4.05dB Vertical: 9K~30MHz: 4.14dB 30MHz~1GHz: 3.37dB 1GHz~40GHz: 4.08dB

7. TEST RESULT

7.1. Summary

Product Name: E-reader
FCC ID: XR3-KEPLER3026
FCC Classification: (DTS) Digital Transmission System
Data Rate(s) Tested: 1Mbps ~ 11Mbps (b); 6Mbps ~ 54Mbps (g);
6.5/7.2Mbps ~ 130/144.4Mbps (n-20M/n-40M);

FCC Part Section(s)	Test Description	Test Limit	Test Condition	Test Result	Reference
15.247(a)(2)	6dB Bandwidth	$\geq 500\text{kHz}$	Conducted	Pass	Section 7.2
15.247(b)(3)	Output Power	$\leq 30.00\text{dBm}$		Pass	Section 7.3
15.247(e)	Power Spectral Density	$\leq 8.00\text{dBm}/3\text{kHz}$		Pass	Section 7.4
15.247(d)	Out-of-Band Emissions	Conducted $\geq 20\text{dBc}$		Pass	Section 7.5
15.205 15.209	Spurious Emission	$< \text{FCC } 15.209 \text{ limits}$	Radiated	Pass	Section 7.6
15.205 15.209	Band Edge Measurement	$\cong 74\text{dBuV/m(Peak)}$ $\cong 54\text{dBuV/m(Average)}$		Pass	Section 7.7
15.207	AC Conducted Emissions 150kHz - 30MHz	$< \text{FCC } 15.207 \text{ limits}$	Line Conducted	Pass	Section 7.8

Notes:

- 1) All modes of operation and data rates were investigated. For radiated emission test, every axis (X, Y, Z) was also verified. The test results shown in the following sections represent the worst case emissions.
- 2) The analyzer plots shown in this section were all taken with a correction table loaded into the analyzer. The correction table was used to account for the losses of the cables and attenuators used as part of the system to connect the EUT to the analyzer at all frequencies of interest.
- 3) All antenna port conducted emissions testing was performed on a test bench with the antenna port of the EUT connected to the spectrum analyzer through calibrated cables and attenuators.

7.2. 6dB Bandwidth Measurement

7.2.1. Test Limit

The minimum 6dB bandwidth shall be at least 500 kHz.

7.2.2. Test Procedure used

KDB 558074 D01v04- Section 8.2 Option 2

7.2.3. Test Setting

1. The Spectrum's automatic bandwidth measurement capability was used to perform the 6dB bandwidth measurement. The "X" dB bandwidth parameter was set to $X = 6$. The bandwidth measurement was not influenced by any intermediate power nulls in the fundamental emission.
2. Set RBW = 100 kHz
3. VBW $\geq 3 \times$ RBW
4. Detector = Peak
5. Trace mode = max hold
6. Sweep = auto couple
7. Allow the trace was allowed to stabilize

7.2.4. Test Setup

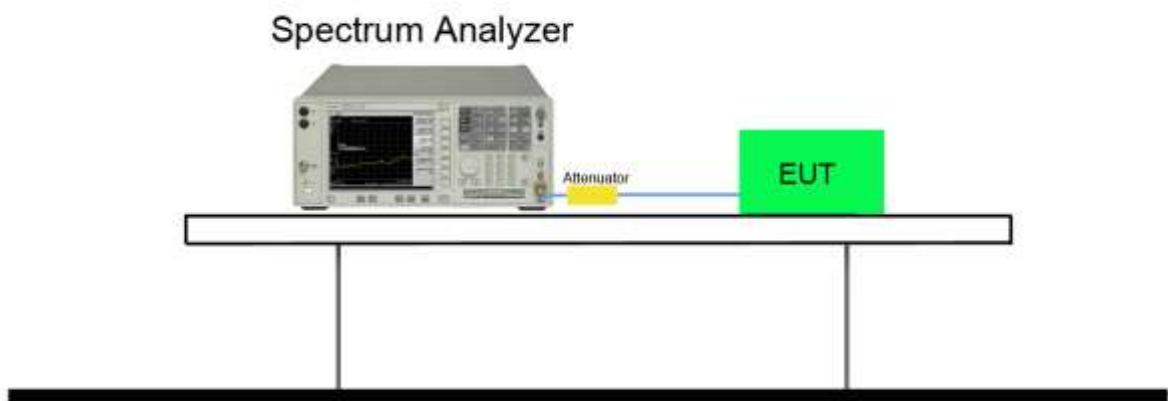

7.2.5. Test Result

Test Mode	Channel No.	Frequency (MHz)	6dB Bandwidth (MHz)	99% Bandwidth (MHz)	Limit (MHz)	Result
802.11b	01	2412	10.09	15.34	≥ 0.5	Pass
802.11b	06	2437	10.10	15.4	≥ 0.5	Pass
802.11b	11	2462	10.10	15.4	≥ 0.5	Pass
802.11g	01	2412	16.37	16.54	≥ 0.5	Pass
802.11g	06	2437	16.4	16.55	≥ 0.5	Pass
802.11g	11	2462	16.38	16.52	≥ 0.5	Pass
802.11n-20M	01	2412	17.62	17.72	≥ 0.5	Pass
802.11n-20M	06	2437	17.59	17.71	≥ 0.5	Pass
802.11n-20M	11	2462	17.6	17.68	≥ 0.5	Pass
802.11n-40M	03	2422	35.81	35.99	≥ 0.5	Pass
802.11n-40M	06	2437	35.44	35.99	≥ 0.5	Pass
802.11n-40M	09	2452	35.96	35.5	≥ 0.5	Pass

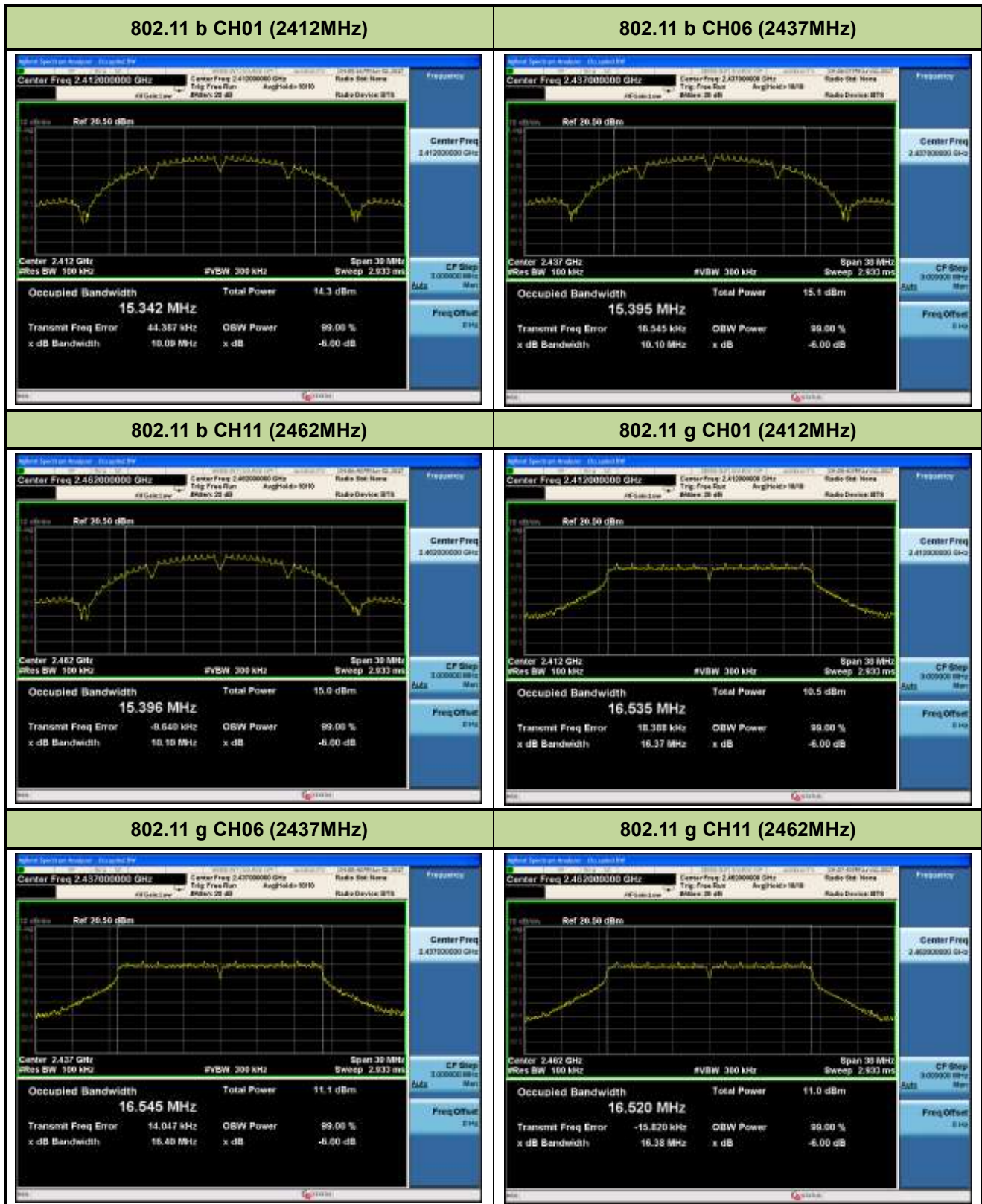

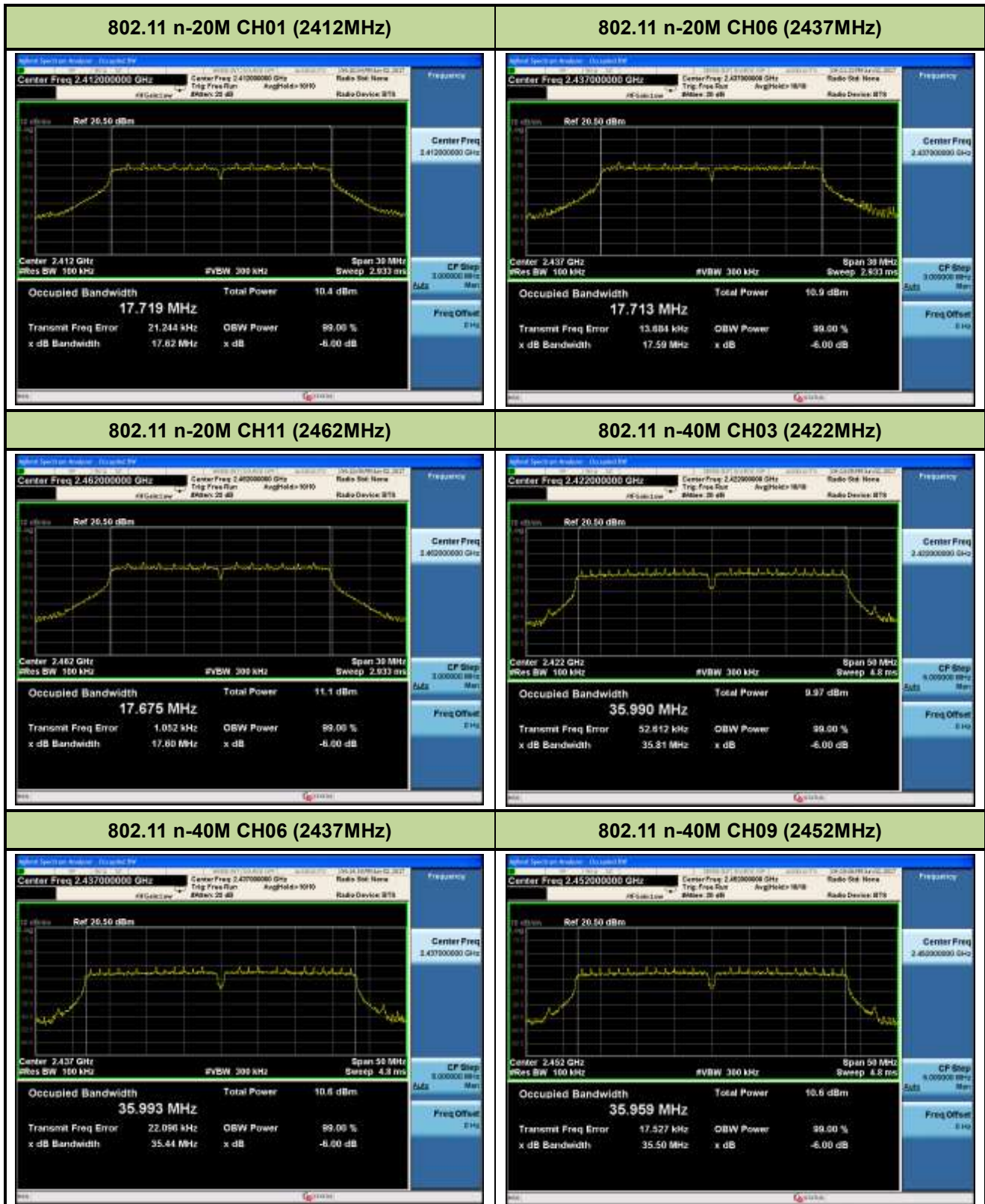

7.3. Output Power Measurement

7.3.1. Test Limit

The maximum out power shall be less 1 Watt (30dBm).

7.3.2. Test Procedure Used

KDB 558074 D01v04 - Section 9.1.2 & 9.2.3.2

7.3.3. Test Setting

Peak Power Measurement

The maximum peak conducted output power may be measured using a broadband peak RF power meter. The power meter shall have a video bandwidth that is greater than or equal to the DTS bandwidth and shall utilize a fast-responding diode detector.

Average Power Measurement

Average power measurements were performed only when the EUT was transmitting at its maximum power control level using a broadband power meter with a pulse sensor. The power meter implemented triggering and gating capabilities which were set up such that power measurements were recorded only during the ON time of the transmitter. The trace was averaged over 100 traces to obtain the final measured average power.

7.3.4. Test Setup

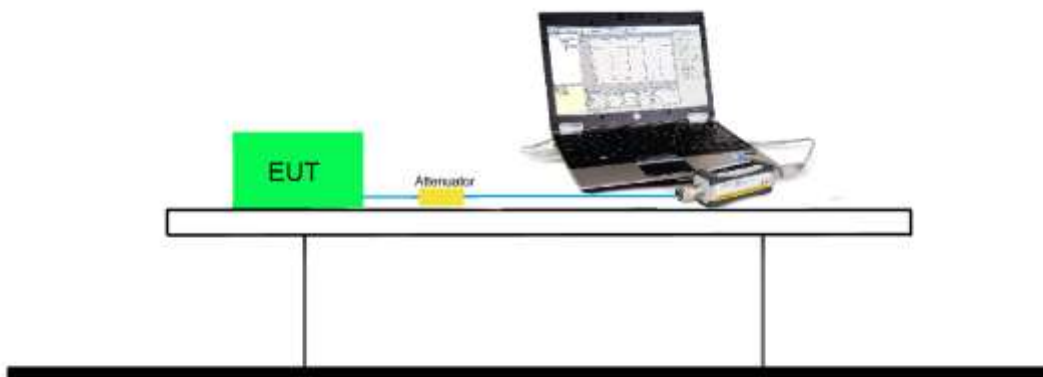

7.3.5. Test Result of Output Power

2.4GHz 802.11b RF Output Power (dBm)											
Channel No.	Frequency (MHz)	Average Power For different Data Rate (Mbps)				Peak Power	Required Limit				
		1	2	5.5	11						
01	2412	8.18	--	--	--	10.25	1Watt= 30 dBm				
06	2437	8.91	8.71	8.72	8.74	10.93	1Watt= 30 dBm				
11	2462	8.74	--	--	--	10.72	1Watt= 30 dBm				
2.4GHz 802.11g RF Output Power (dBm)											
Channel No.	Frequency (MHz)	Average Power For different Data Rate (Mbps)								Peak Power	Required Limit
		6	9	12	18	24	36	48	54		
01	2412	7.9	--	--	--	--	--	--	--	13.17	1Watt= 30 dBm
06	2437	7.85	7.72	7.61	7.73	7.64	7.71	7.62	7.76	13.41	1Watt= 30 dBm
11	2462	8.26	--	--	--	--	--	--	--	13.44	1Watt= 30 dBm
2.4GHz 802.11n-20M RF Output Power (dBm)											
Channel No.	Frequency (MHz)	Average Power For different Data Rate (Mbps)								Peak Power	Required Limit
		MCS0	MCS1	MCS2	MCS3	MCS4	MCS5	MCS6	MCS7		
01	2412	7.92	--	--	--	--	--	--	--	13.12	1Watt= 30 dBm
06	2437	8.68	8.27	8.36	8.29	8.41	8.34	8.35	8.47	13.73	1Watt= 30 dBm
11	2462	8.81	--	--	--	--	--	--	--	13.69	1Watt= 30 dBm
2.4GHz 802.11n-40M RF Output Power (dBm)											
Channel No.	Frequency (MHz)	Average Power For different Data Rate (Mbps)								Peak Power	Required Limit
		MCS0	MCS1	MCS2	MCS3	MCS4	MCS5	MCS6	MCS7		
03	2422	7.78	--	--	--	--	--	--	--	13.44	1Watt= 30 dBm
06	2437	8.21	8.13	8.04	7.87	7.95	7.96	7.91	7.92	13.65	1Watt= 30 dBm
09	2452	8.27	--	--	--	--	--	--	--	13.54	1Watt= 30 dBm

Note: Output power = Reading value on power meter + cable loss ◦

7.4. Power Spectral Density Measurement

7.4.1. Test Limit

The maximum permissible power spectral density is 8dBm in any 3 kHz band.

7.4.2. Test Procedure Used

KDB 558074 D01v04 - Section 10.2 Method PKPSD

7.4.3. Test Setting

This procedure shall be used if maximum peak conducted output power was used to demonstrate compliance, and is optional if the maximum conducted (average) output power was used to demonstrate compliance.

- a) Set analyzer center frequency to DTS channel center frequency.
- b) Set the span to 1.5 times the DTS bandwidth.
- c) Set the RBW to: 3 kHz.
- d) Set the VBW $\geq 3 \times$ RBW.
- e) Detector = peak.
- f) Sweep time = auto couple.
- g) Trace mode = max hold.
- h) Allow trace to fully stabilize.
- i) Use the peak marker function to determine the maximum amplitude level within the RBW.

7.4.4. Test Setup

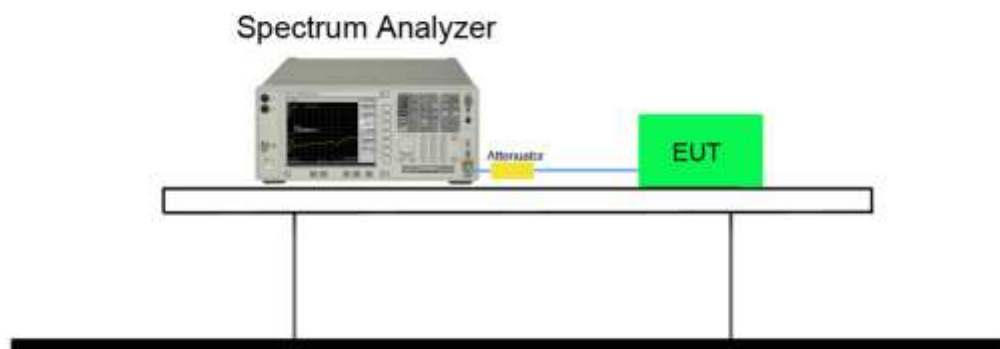

7.4.5. Test Result

Test Mode	Channel No.	Freq. (MHz)	PSD (dBm)	Limit (dBm)	Result
11b	1	2412	-16.18	≤ 8	Pass
11b	6	2437	-15.26	≤ 8	Pass
11b	11	2462	-15.57	≤ 8	Pass
11g	1	2412	-22.00	≤ 8	Pass
11g	6	2437	-20.96	≤ 8	Pass
11g	11	2462	-20.73	≤ 8	Pass
11n-20M	1	2412	-21.89	≤ 8	Pass
11n-20M	6	2437	-22.11	≤ 8	Pass
11n-20M	11	2462	-21.49	≤ 8	Pass
11n-40M	3	2422	-25.95	≤ 8	Pass
11n-40M	6	2437	-23.52	≤ 8	Pass
11n-40M	9	2452	-24.12	≤ 8	Pass

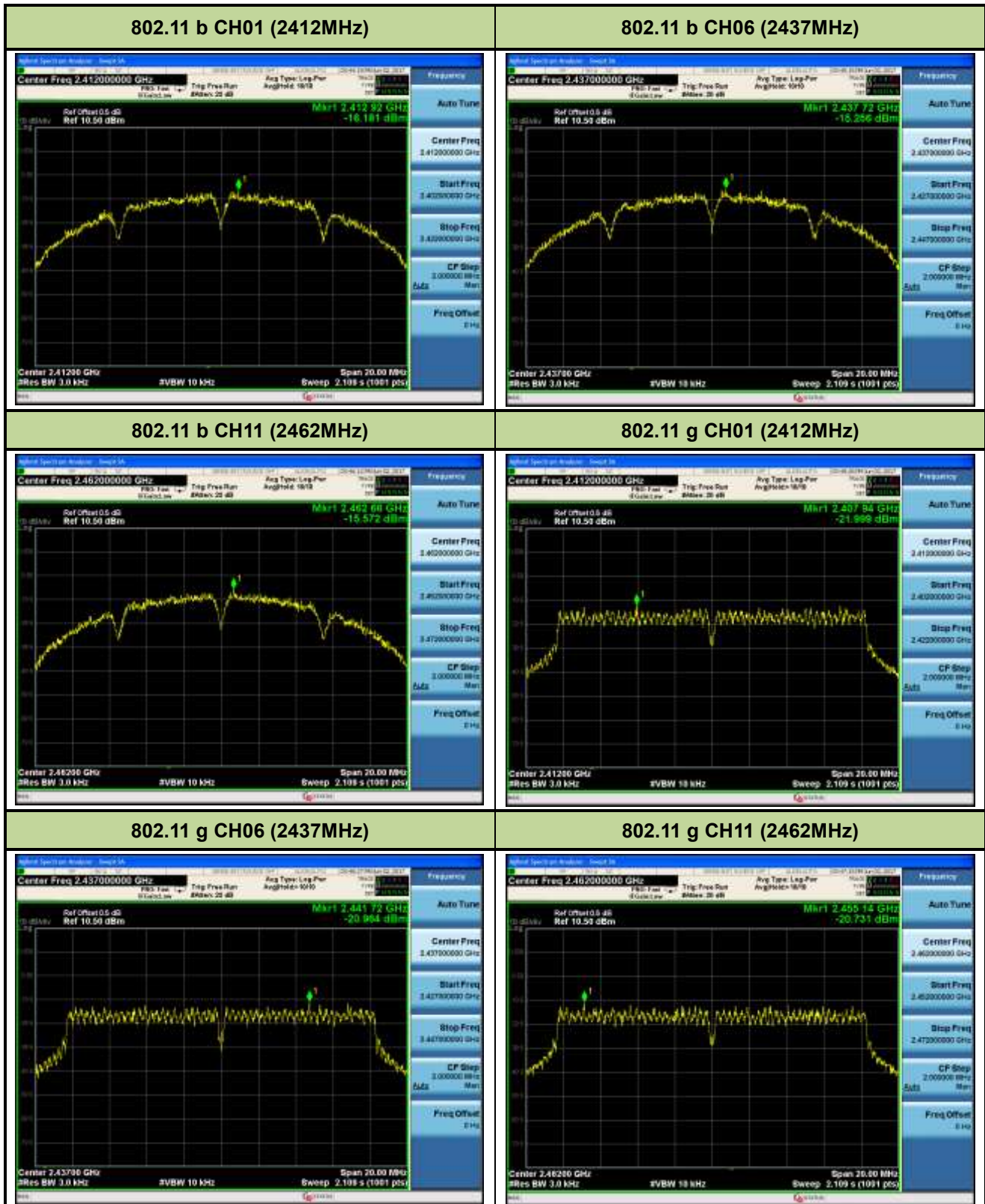

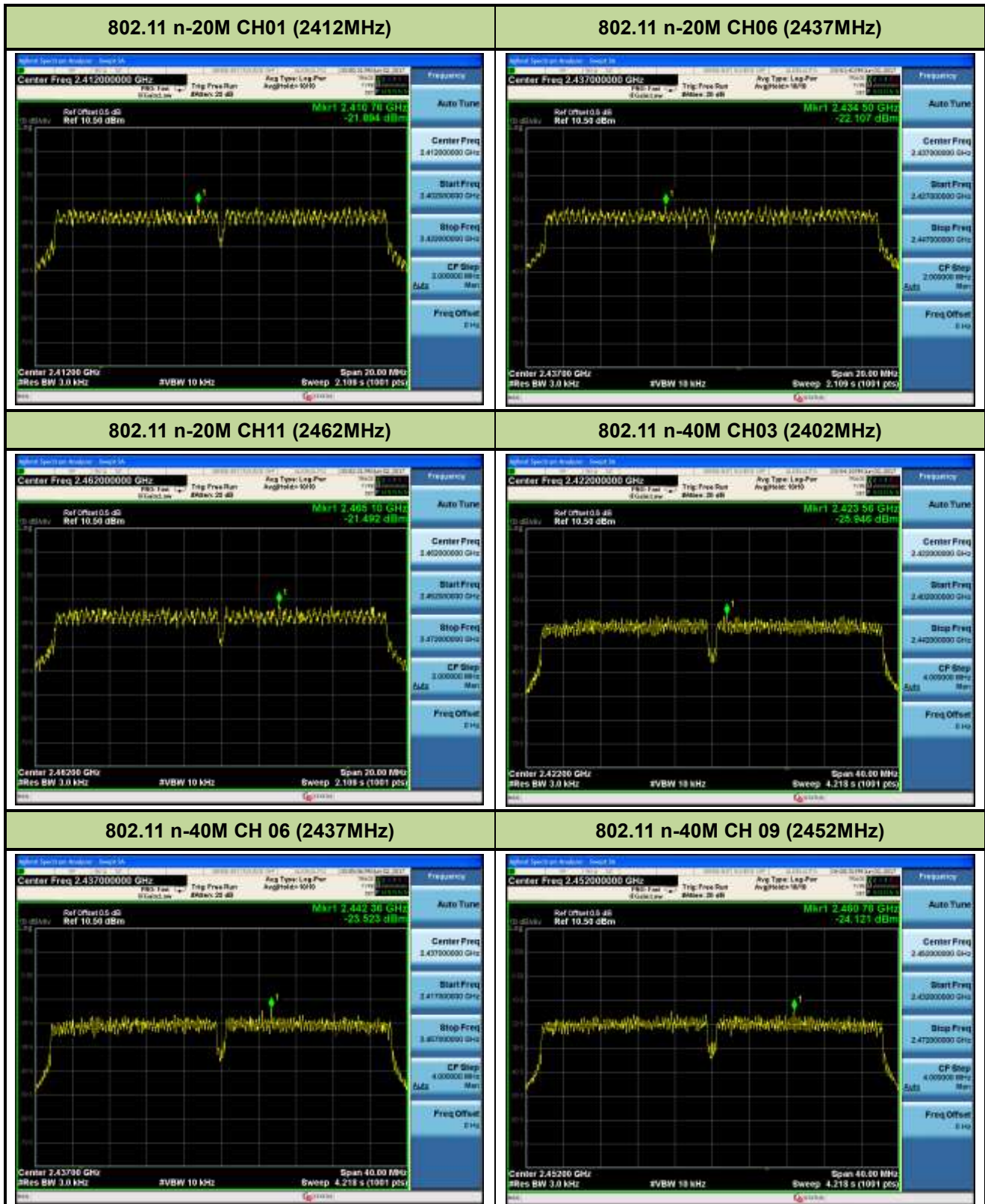

7.5. Out-of-Band Spurious Emissions Emissions Measurement

7.5.1. Test Limit

In any 100 kHz bandwidth outside the frequency band in which the spread spectrum or digitally modulated intentional radiator is operating, the radio frequency power that is produced by the intentional radiator shall be at least 20 dB below that in the 100 kHz bandwidth within the band that contains the highest level of the desired power, based on RF conducted measurement, provided the transmitter demonstrates compliance with the peak conducted power limits.

7.5.2. Test Procedure Used

KDB 558074 D01v04- Section 11.1 & 11.2

7.5.3. Test Setting

- (a) Set instrument center frequency to DTS channel center frequency
- (b) Set the span to ≥ 1.5 times the DTS bandwidth
- (c) Set the RBW = 100 kHz
- (d) Set the VBW $\geq 3 \times$ RBW
- (e) Detector = peak
- (f) Sweep time = auto couple
- (g) Trace mode = max hold
- (h) Allow trace to fully stabilize

7.5.4. Test Setup

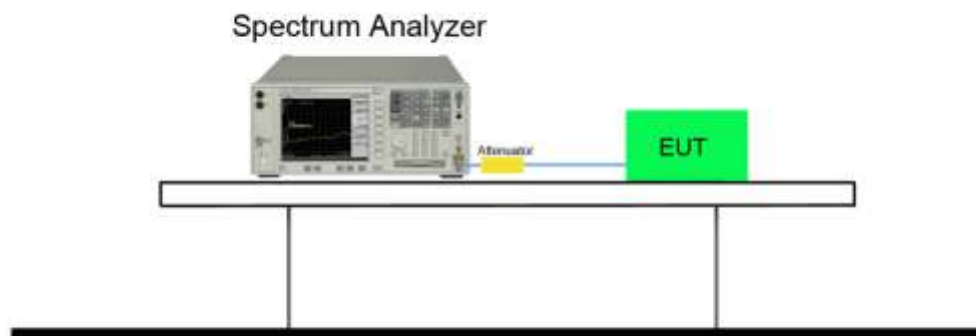

7.5.5. Test Result

Test Mode	Channel No.	Frequency (MHz)	Limit	Result
802.11b	01	2412	20dBc	Pass
802.11b	06	2437	20dBc	Pass
802.11b	11	2462	20dBc	Pass
802.11g	01	2412	20dBc	Pass
802.11g	06	2437	20dBc	Pass
802.11g	11	2462	20dBc	Pass
802.11n-20M	01	2412	20dBc	Pass
802.11n-20M	06	2437	20dBc	Pass
802.11n-20M	11	2462	20dBc	Pass
802.11n-40M	03	2422	20dBc	Pass
802.11n-40M	06	2437	20dBc	Pass
802.11n-40M	09	2452	20dBc	Pass

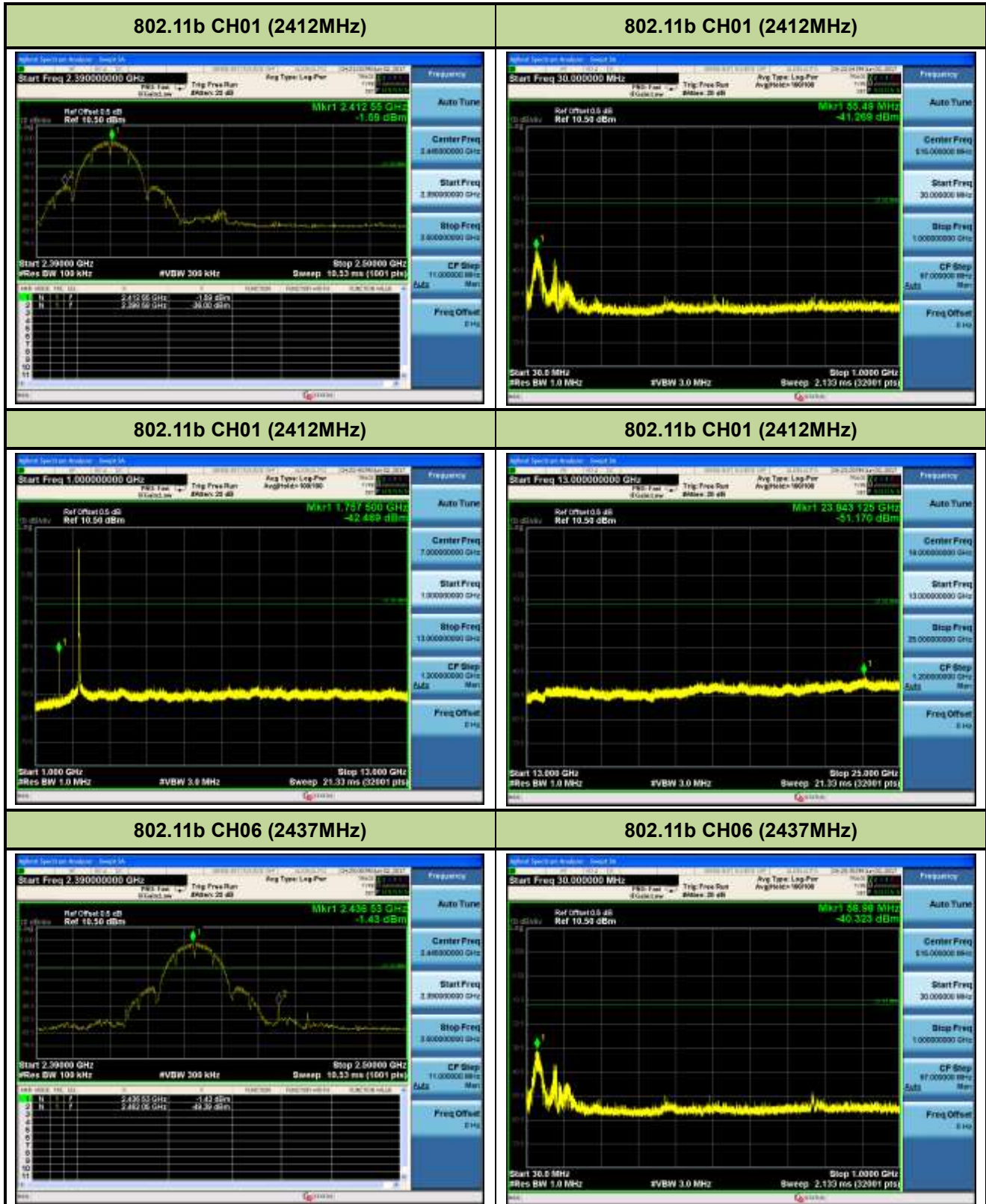

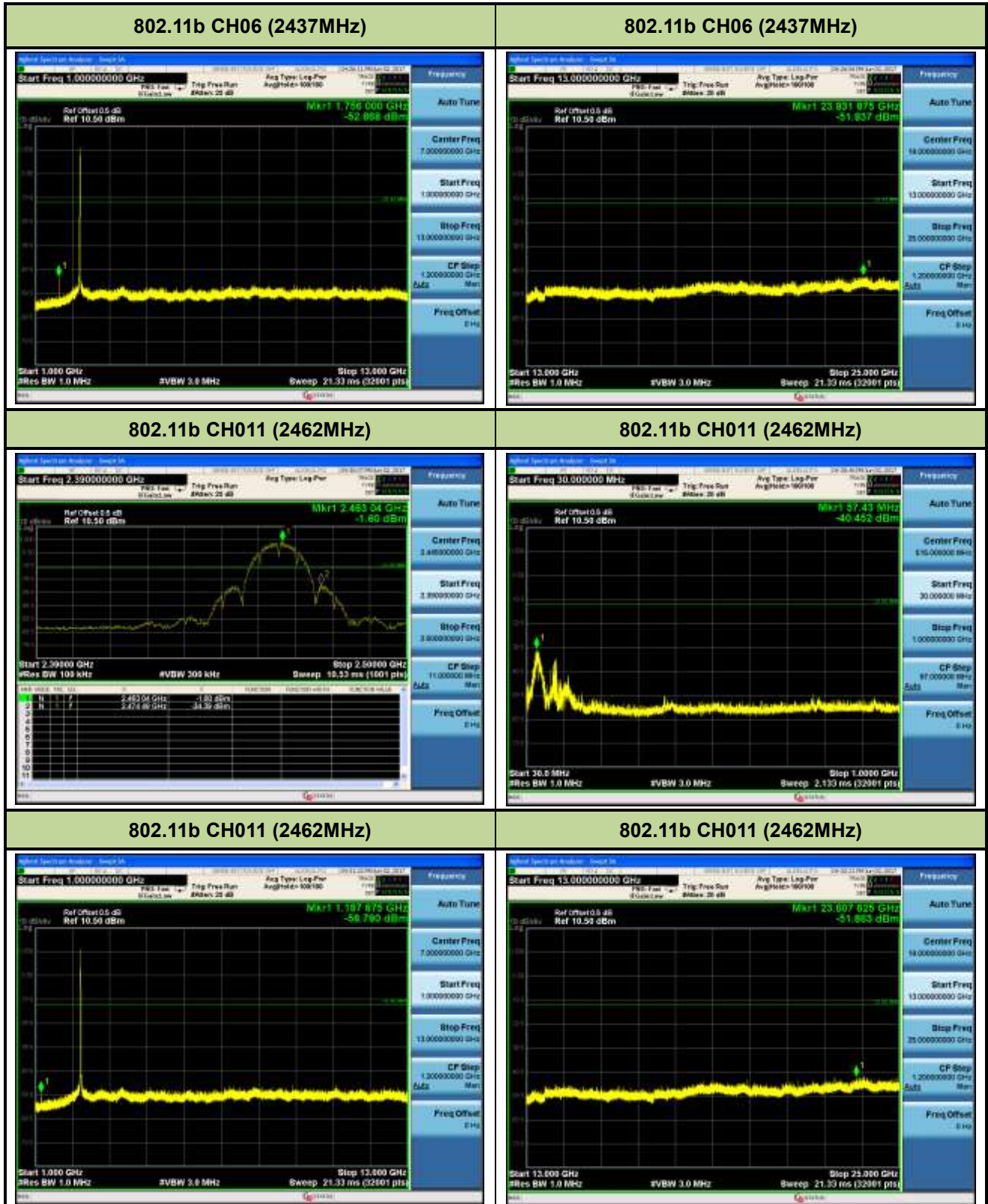

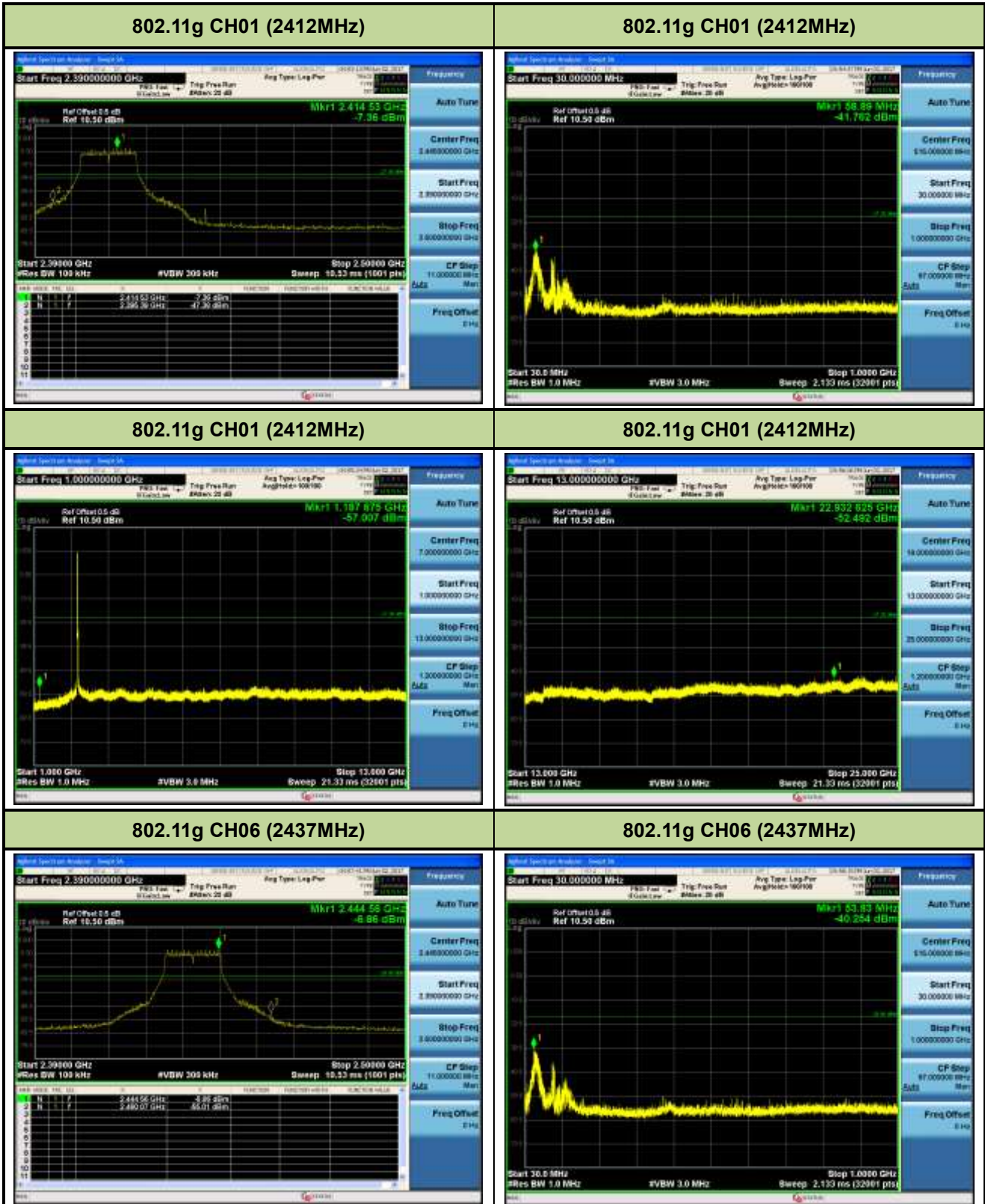

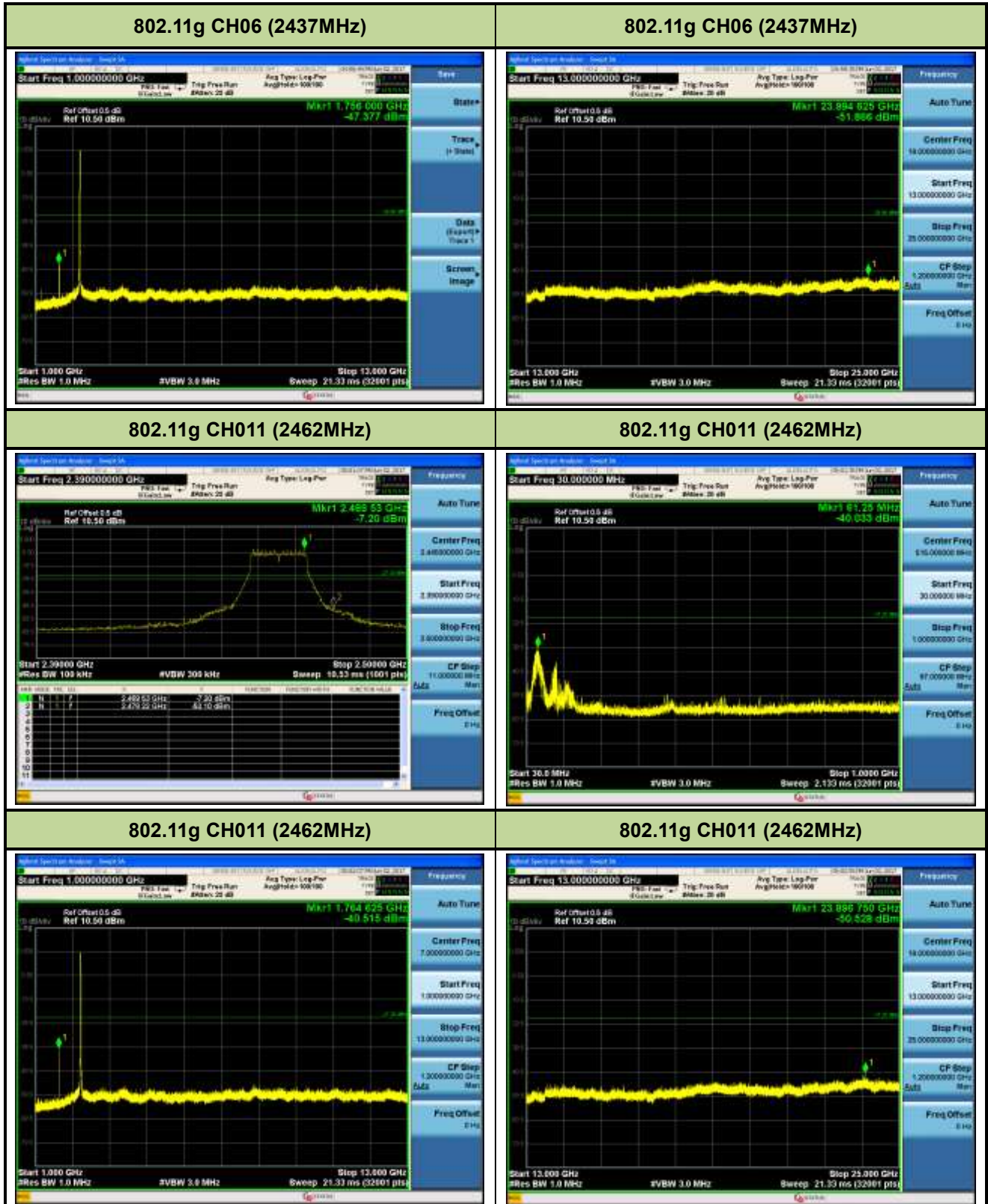

802.11n-20M CH01 (2412MHz)



802.11n-20M CH01 (2412MHz)



802.11n-20M CH01 (2412MHz)

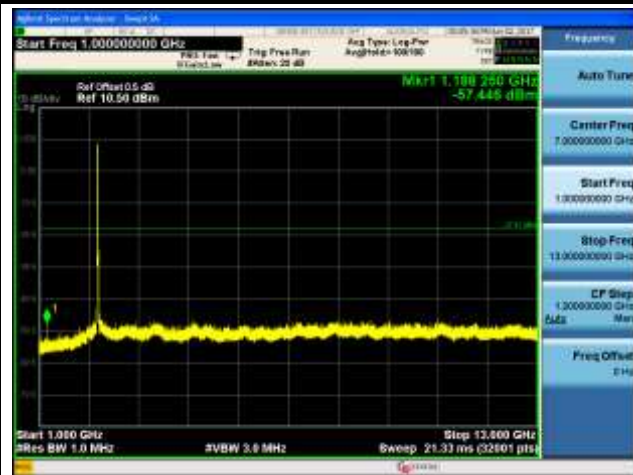

802.11n-20M CH01 (2412MHz)



802.11n-20M CH06 (2437MHz)

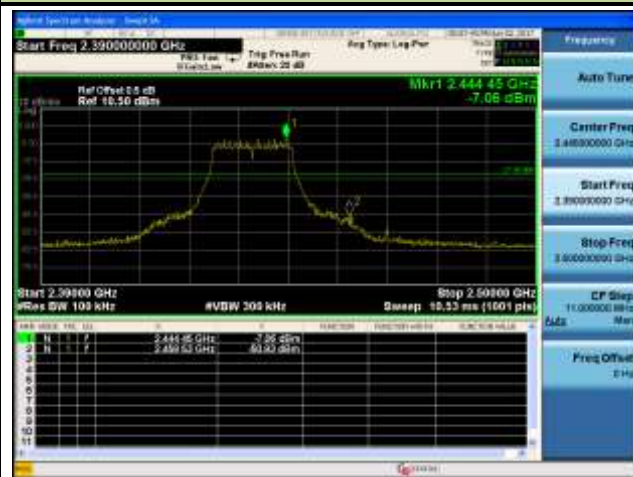

802.11n-20M CH06 (2437MHz)



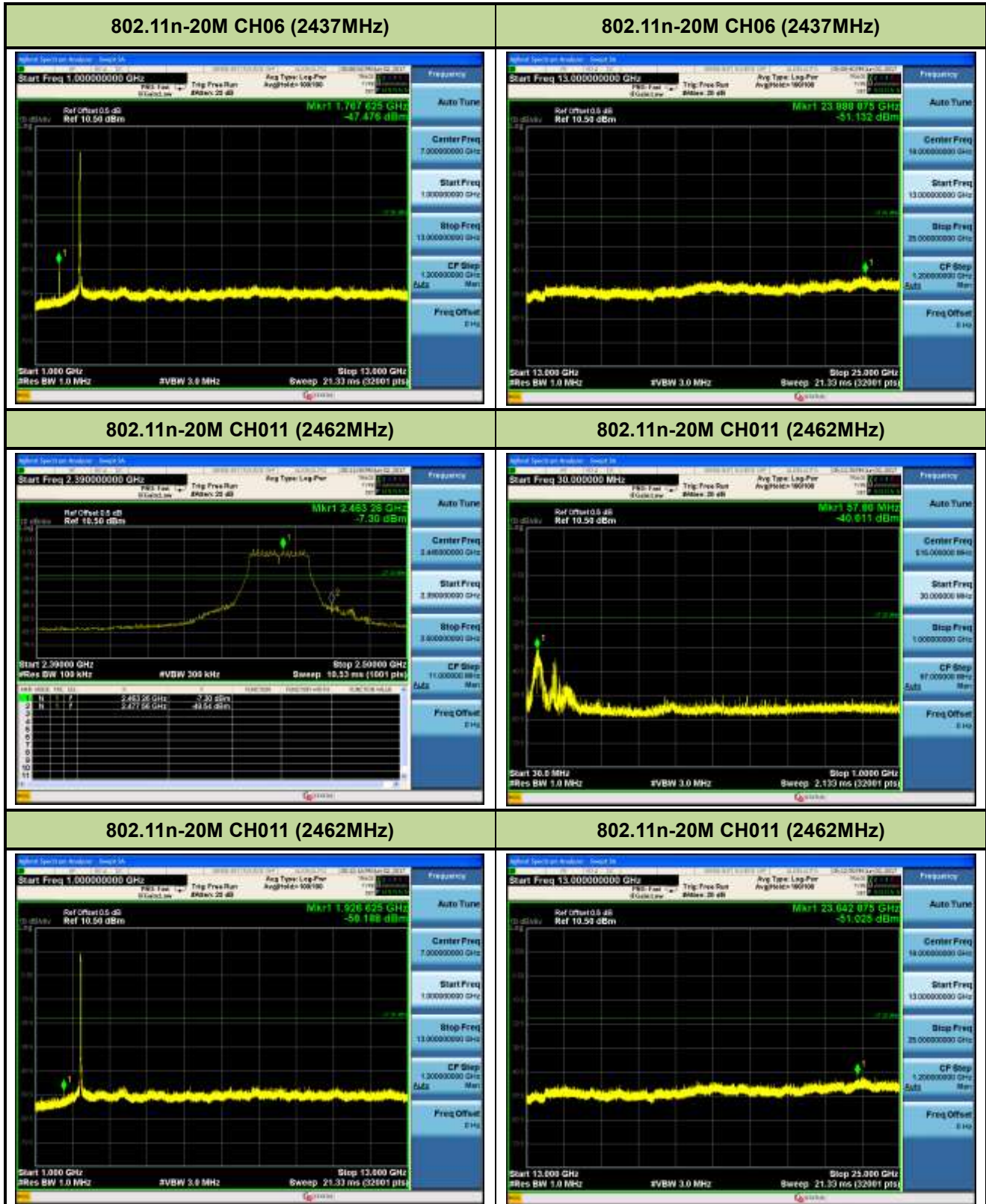

802.11n-40M CH03 (2422MHz)



802.11n-40M CH03 (2422MHz)



802.11n-40M CH03 (2422MHz)

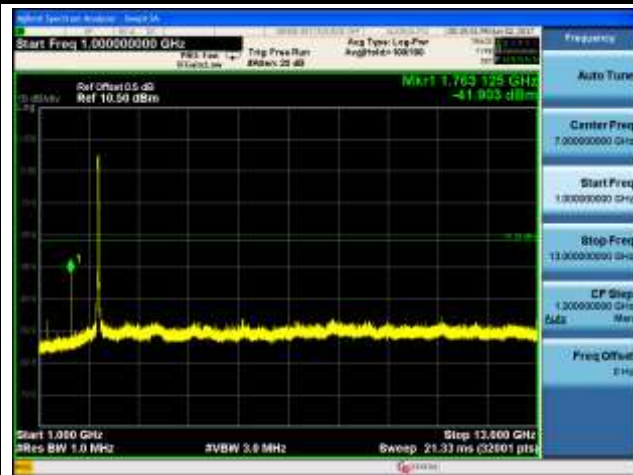

802.11n-40M CH03 (2422MHz)



802.11n-40M CH06 (2437MHz)



802.11n-40M CH06 (2437MHz)



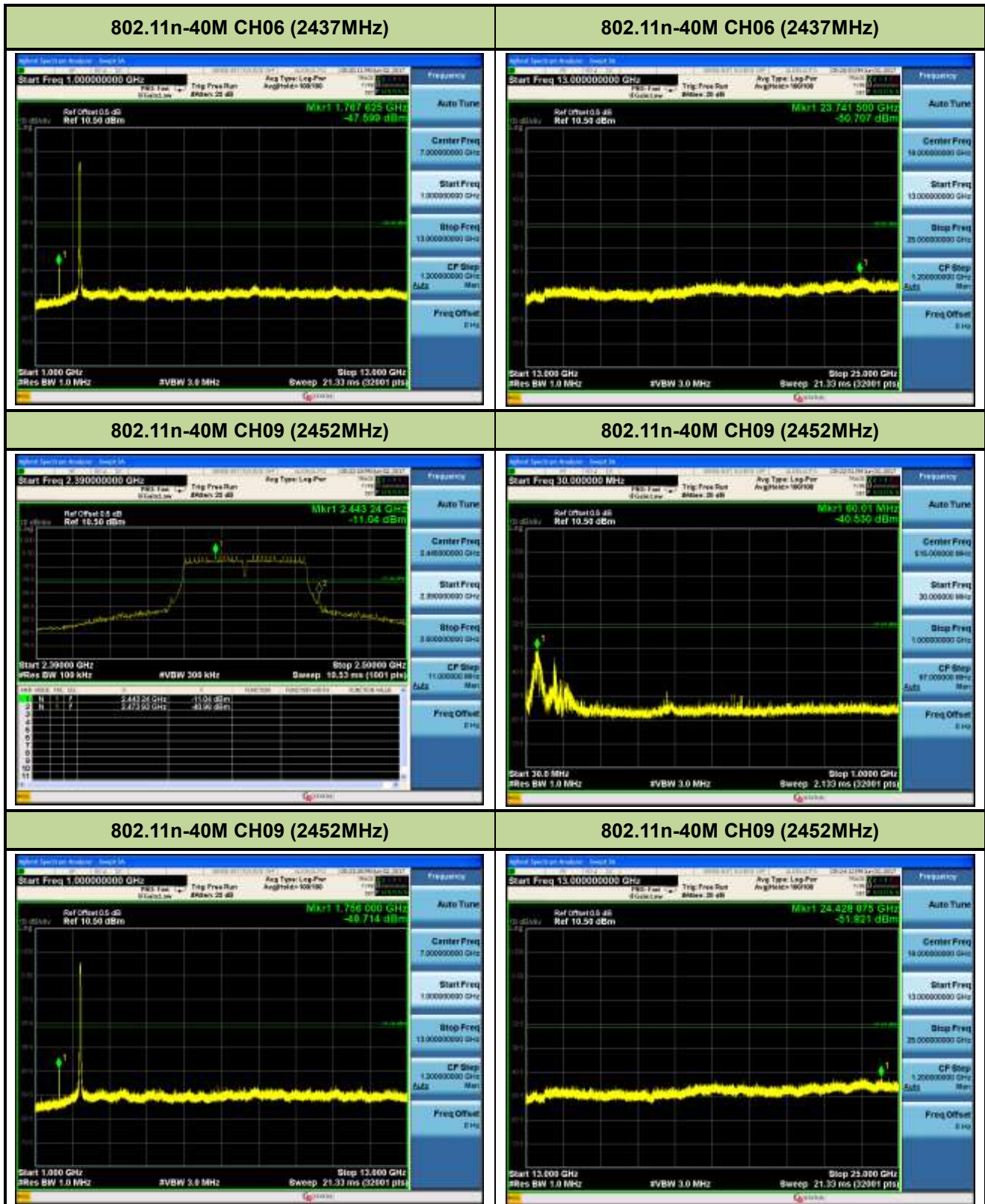

7.6. Radiated Spurious Emission Measurement

7.6.1. Test Limit

All out of band emissions appearing in a restricted band as specified in Section 15.205 of the Title 47 CFR must not exceed the limits shown in Table per Section 15.209.

FCC Part 15 Subpart C Paragraph 15.209		
Frequency [MHz]	Field Strength [V/m]	Measured Distance [Meters]
0.009 - 0.490	2400/F (kHz)	300
0.490 - 1.705	24000/F (kHz)	30
1.705 - 30	30	30
30 - 88	100	3
88 - 216	150	3
216 - 960	200	3
Above 960	500	3

7.6.2. Test Procedure Used

KDB 558074 D01v04- Section 12.2.3 (quasi-peak measurements)

KDB 558074 D01v04- Section 12.2.4 (peak power measurements)

KDB 558074 D01v04- Section 12.2.5 (average power measurements)

7.6.3. Test Setting

Peak Field Strength Measurements

1. Analyzer center frequency was set to the frequency of the radiated spurious emission of interest
2. RBW = as specified in Table 1
3. VBW = 3MHz
4. Detector = peak
5. Sweep time = auto couple

6. Trace mode = max hold

7. Trace was allowed to stabilize

Table 1 - RBW as a function of frequency

Frequency	RBW
9 ~ 150 kHz	200 ~ 300 Hz
0.15 ~ 30 MHz	9 ~ 10 kHz
30 ~ 1000 MHz	100 ~ 120 kHz
> 1000 MHz	1 MHz

Average Field Strength Measurements

1. Analyzer center frequency was set to the frequency of the radiated spurious emission of interest

2. RBW = 1MHz

3. VBW \geq 1/T

4. De As an alternative, the instrument may be set to linear detector mode. Ensure that video filtering is applied in linear voltage domain (rather than in a log or dB domain). Some instruments require linear display mode in order to accomplish this. Others have a setting for Average-VBW Type, which can be set to “Voltage” regardless of the display mode

5. Detector = Peak

6. Sweep time = auto

7. Trace mode = max hold

8. Allow max hold to run for at least 50 times (1/duty cycle) traces

7.6.4. Test Setup

9kHz ~ 30MHz Test Setup:

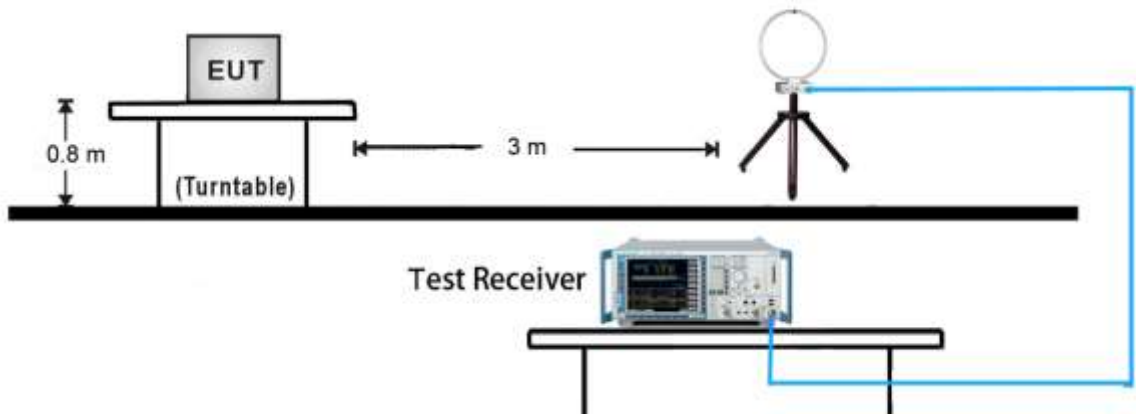

30MHz ~ 1GHz Test Setup:

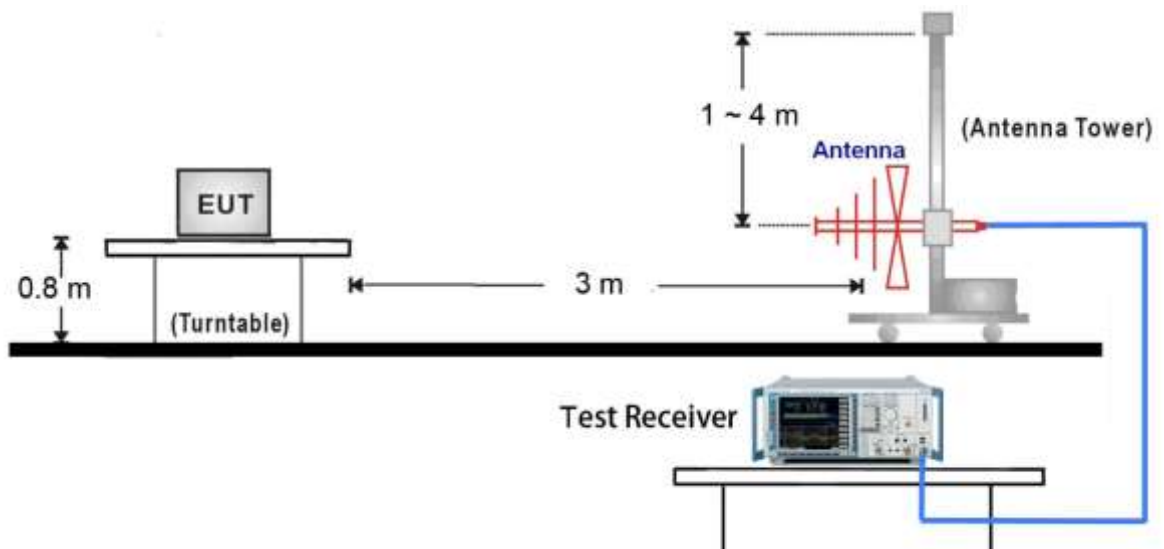

1GHz ~ 18GHz Test Setup:

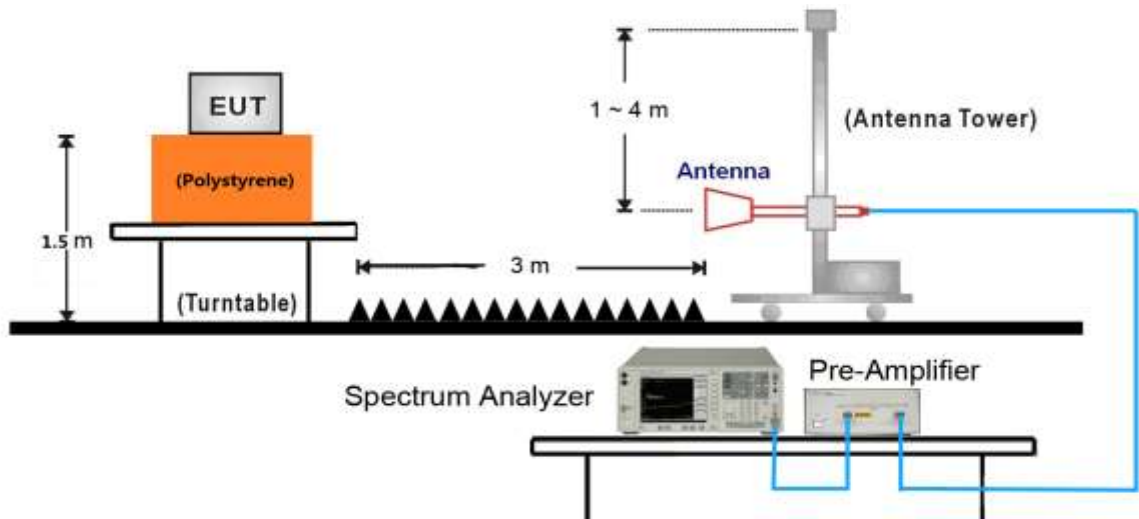

18GHz ~25GHz Test Setup:

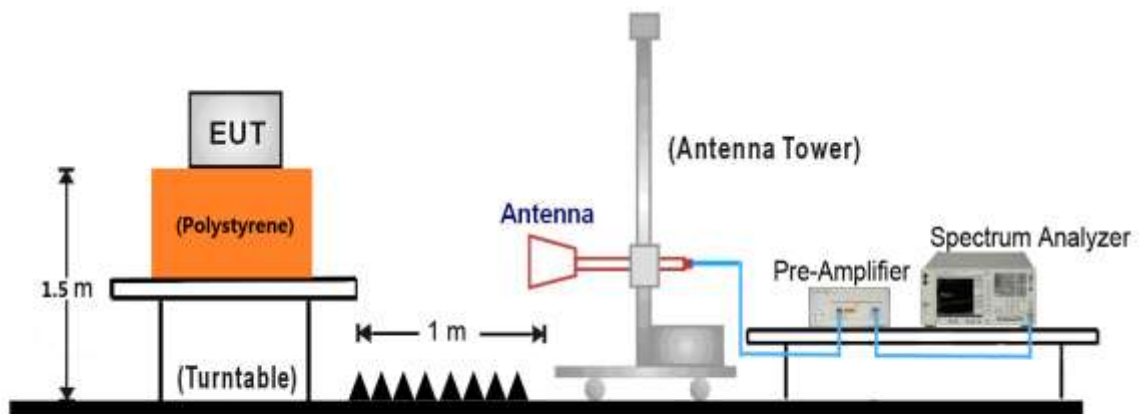

7.6.5. Test Result

EUT	E-READER	Test Date	2017/06/01
Factor	VULB 9162 (30MHz~8GHz)	Temp. / Humidity	25°C / 60%
Polarity	Horizontal	Site / Engineer	AC1 / Peter
Test Mode	MODE3_n-20M-CH06	Test Voltage	AC 120V/60Hz

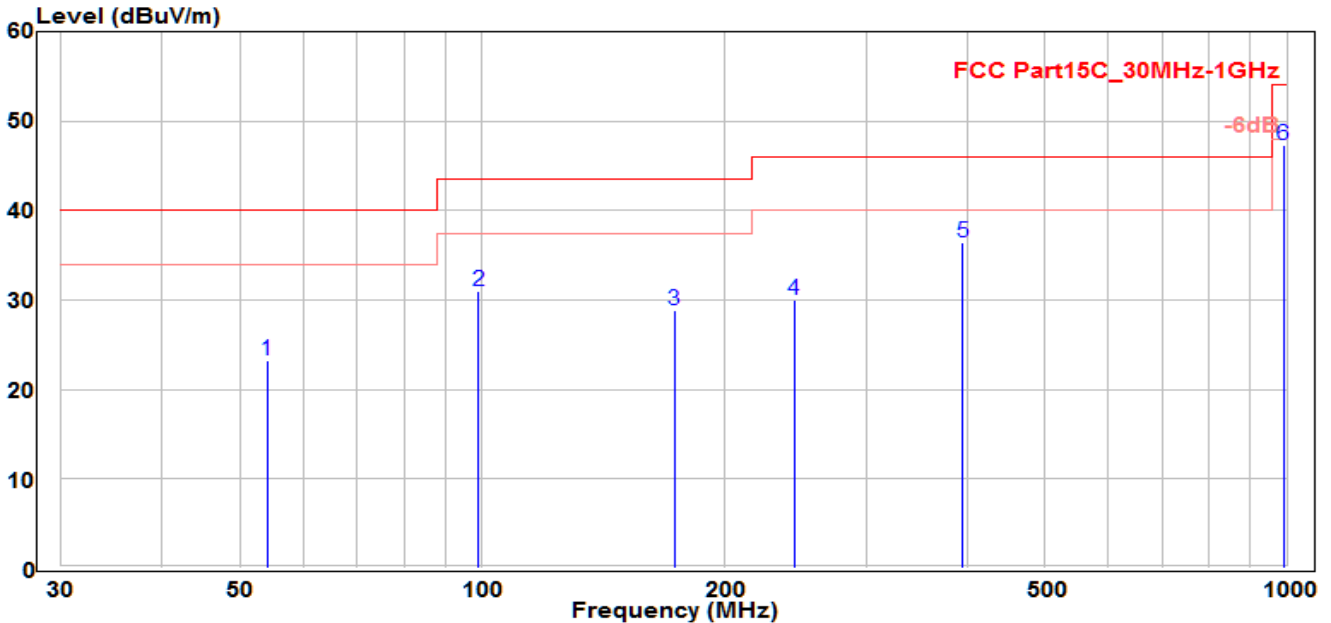

No	Frequency (MHz)	Reading (dBuV)	C.F (dB)	Measurement (dBuV/m)	Margin (dB)	Limit (dBuV)	Height (cm)	Angle (deg)	Remark (QP/PK/AV)
1	54.038	8.4	14.89	23.29	-16.71	40	100	400	QP
2	99.052	17.84	13.12	30.96	-12.54	43.5	120	300	QP
3	173.196	18.32	10.54	28.86	-14.64	43.5	160	5	QP
4	243.946	16.32	13.69	30.01	-15.99	46	110	120	QP
5	395.993	19.5	16.86	36.36	-9.64	46	150	390	QP
6	* 989.997	22.11	25.25	47.36	-6.64	54	190	60	QP

Note :

- " * " means the worst value in this measurement data ◦
- Measure Level (dBuV/m) = Reading Level (dBuV) + Factor (dB) ◦
- Factor (dB) = Cable Loss (dB) + Antenna Factor (dB/m) ◦
- The emission levels of other frequencies are very lower than the limit and not show in test report ◦
- Other channel/mode was also verified. The test results shown represent the worst case emissions ◦
- No emission found between lowest internal used/generated frequency to 30MHz ◦

EUT	E-READER	Test Date	2017/06/01
Factor	VULB 9162 (30MHz~8GHz)	Temp. / Humidity	25°C / 60%
Polarity	Vertical	Site / Engineer	AC1 / Peter
Test Mode	MODE3_n-20M-CH06	Test Voltage	AC 120V/60Hz

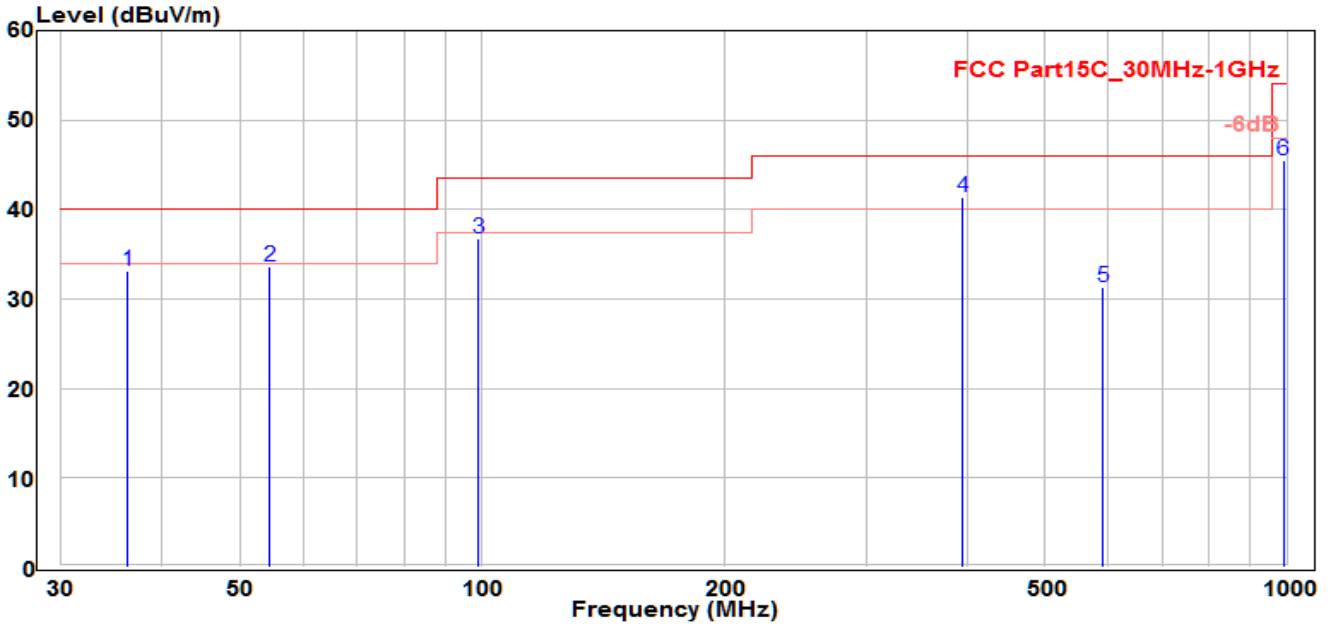

No	Frequency (MHz)	Reading (dBuV)	C.F (dB)	Measurement (dBuV/m)	Margin (dB)	Limit (dBuV)	Height (cm)	Angle (deg)	Remark (QP/PK/AV)
1	36.275	20.11	12.96	33.07	-6.93	40	100	150	QP
2	* 54.523	18.75	14.86	33.61	-6.39	40	120	360	QP
3	98.991	23.61	13.12	36.73	-6.77	43.5	160	30	QP
4	395.993	24.5	16.86	41.36	-4.64	46	160	-5	QP
5	591.539	11.09	20.19	31.28	-14.72	46	110	10	QP
6	989.876	20.28	25.25	45.53	-8.47	54	100	400	QP

Note :

- "*" means the worst value in this measurement data ◦
- Measure Level (dBuV/m) = Reading Level (dBuV) + Factor (dB) ◦
- Factor (dB) = Cable Loss (dB) + Antenna Factor (dB/m) ◦
- The emission levels of other frequencies are very lower than the limit and not show in test report ◦
- Other channel/mode was also verified. The test results shown represent the worst case emissions ◦
- No emission found between lowest internal used/generated frequency to 30MHz ◦

EUT	E-READER	Test Date	2017/06/01
Factor	VULB 9162 (30MHz~8GHz)	Temp. / Humidity	25°C / 60%
Polarity	Horizontal	Site / Engineer	AC1 / Peter
Test Mode	MODE5_n-20M-CH06	Test Voltage	AC 120V/60Hz

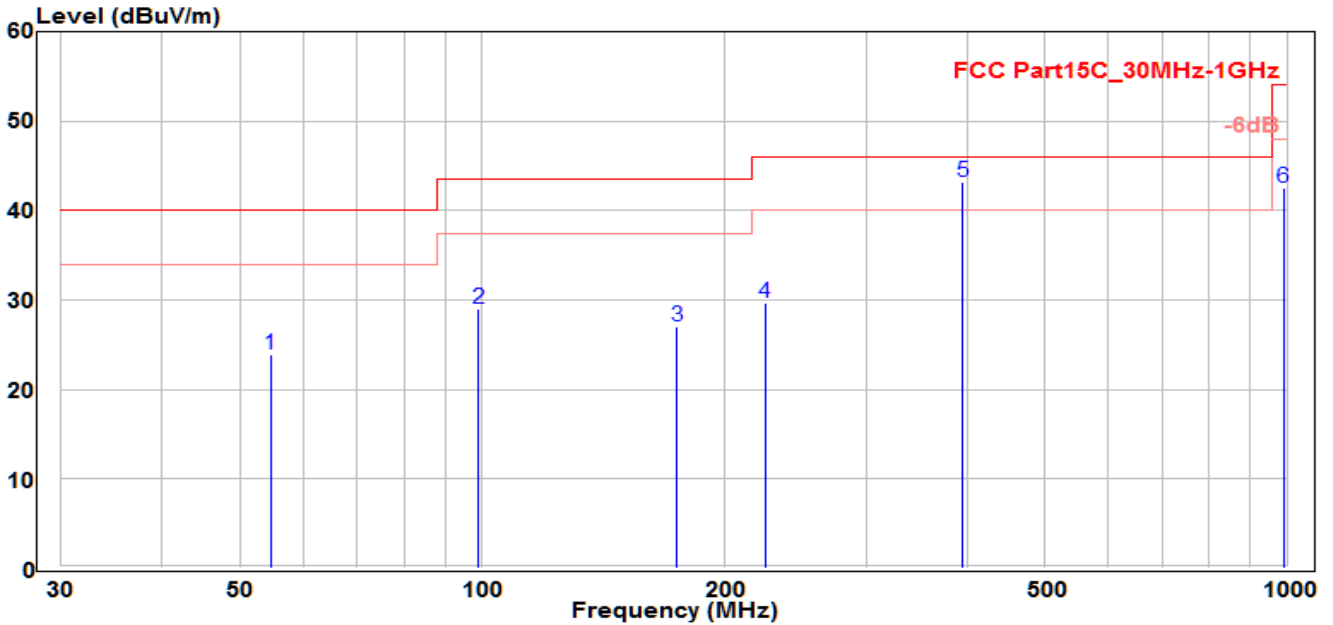

No	Frequency (MHz)	Reading (dBuV)	C.F (dB)	Measurement (dBuV/m)	Margin (dB)	Limit (dBuV)	Height (cm)	Angle (deg)	Remark (QP/PK/AV)
1	54.553	9	14.86	23.86	-16.14	40	120	50	QP
2	98.931	15.83	13.11	28.94	-14.56	43.5	100	10	QP
3	174.863	16.49	10.63	27.12	-16.38	43.5	150	360	QP
4	224.576	16.64	12.97	29.61	-16.39	46	170	20	QP
5	* 395.993	26.3	16.86	43.16	-2.84	46	165	-5	QP
6	989.269	17.29	25.24	42.53	-11.47	54	140	140	QP

Note :

- " * " means the worst value in this measurement data °
- Measure Level (dBuV/m) = Reading Level (dBuV) + Factor (dB) °
- Factor (dB) = Cable Loss (dB) + Antenna Factor (dB/m) °
- The emission levels of other frequencies are very lower than the limit and not show in test report °
- Other channel/mode was also verified. The test results shown represent the worst case emissions °
- No emission found between lowest internal used/generated frequency to 30MHz °

EUT	E-READER	Test Date	2017/06/01
Factor	VULB 9162 (30MHz~8GHz)	Temp. / Humidity	25°C / 60%
Polarity	Vertical	Site / Engineer	AC1 / Peter
Test Mode	MODE5_n-20M-CH06	Test Voltage	AC 120V/60Hz

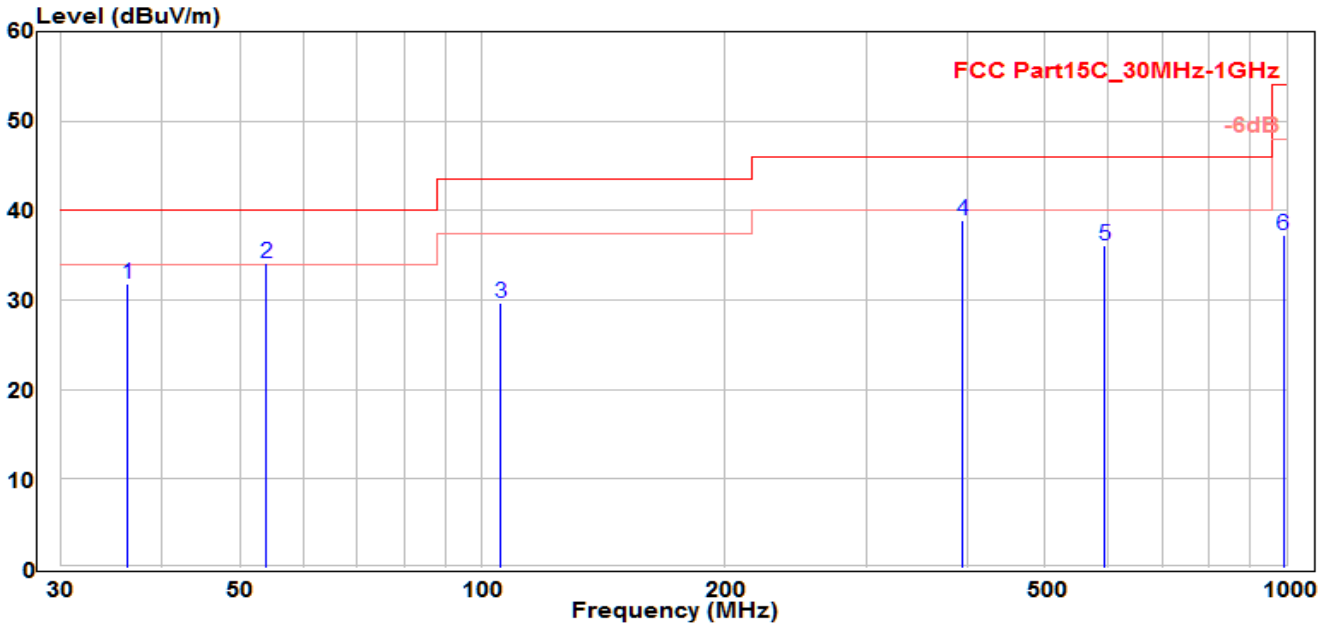

No	Frequency (MHz)	Reading (dBuV)	C.F (dB)	Measurement (dBuV/m)	Margin (dB)	Limit (dBuV)	Height (cm)	Angle (deg)	Remark (QP/PK/AV)
1	36.275	18.79	12.96	31.75	-8.25	40	100	200	QP
2	* 53.947	19.3	14.89	34.19	-5.81	40	150	360	QP
3	105.448	16.23	13.39	29.62	-13.88	43.5	190	400	QP
4	395.993	22.1	16.86	38.96	-7.04	46	155	340	QP
5	593.934	15.86	20.23	36.09	-9.91	46	100	10	QP
6	990.27	12	25.25	37.25	-16.75	54	110	110	QP

Note :

- "*" means the worst value in this measurement data °
- Measure Level (dBuV/m) = Reading Level (dBuV) + Factor (dB) °
- Factor (dB) = Cable Loss (dB) + Antenna Factor (dB/m) °
- The emission levels of other frequencies are very lower than the limit and not show in test report °
- Other channel/mode was also verified. The test results shown represent the worst case emissions °
- No emission found between lowest internal used/generated frequency to 30MHz °

EUT	E-READER	Test Date	2017/06/02
Factor	BBHA 9120D (1GHz~18GHz)	Temp. / Humidity	25°C / 60%
Polarity	Horizontal	Site / Engineer	AC1 / Peter
Test Mode	MODE1_b-CH01	Test Voltage	AC 120V/60Hz

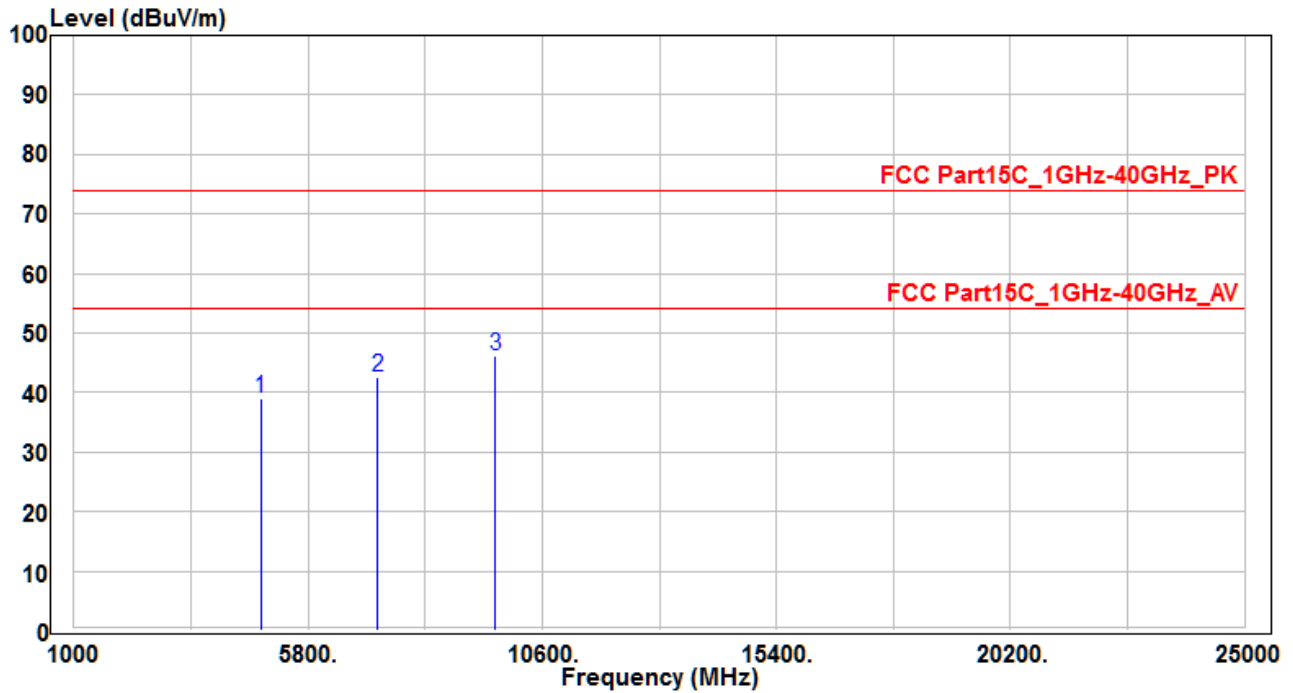

No	Frequency (MHz)	Reading (dBuV)	C.F (dB)	Measurement (dBuV/m)	Margin (dB)	Limit (dBuV)	Height (cm)	Angle (deg)	Remark (QP/PK/AV)
1	4824	35.3	3.67	38.97	-35.03	74	100	4824	Peak
2	7236	30.39	12.19	42.58	-31.42	74	100	7236	Peak
3	* 9648	30.51	15.67	46.18	-27.82	74	100	9648	Peak

Note :

- " * " means the worst value in this measurement data °
- Measure Level (dBuV/m) = Reading Level (dBuV) + Factor (dB) °
- Factor (dB) = Cable Loss (dB) + Antenna Factor (dB/m) °
- The emission levels of other frequencies are very lower than the limit and not show in test report °

EUT	E-READER	Test Date	2017/06/02
Factor	BBHA 9120D (1GHz~18GHz)	Temp. / Humidity	25°C / 60%
Polarity	Vertical	Site / Engineer	AC1 / Peter
Test Mode	MODE1_b-CH01	Test Voltage	AC 120V/60Hz

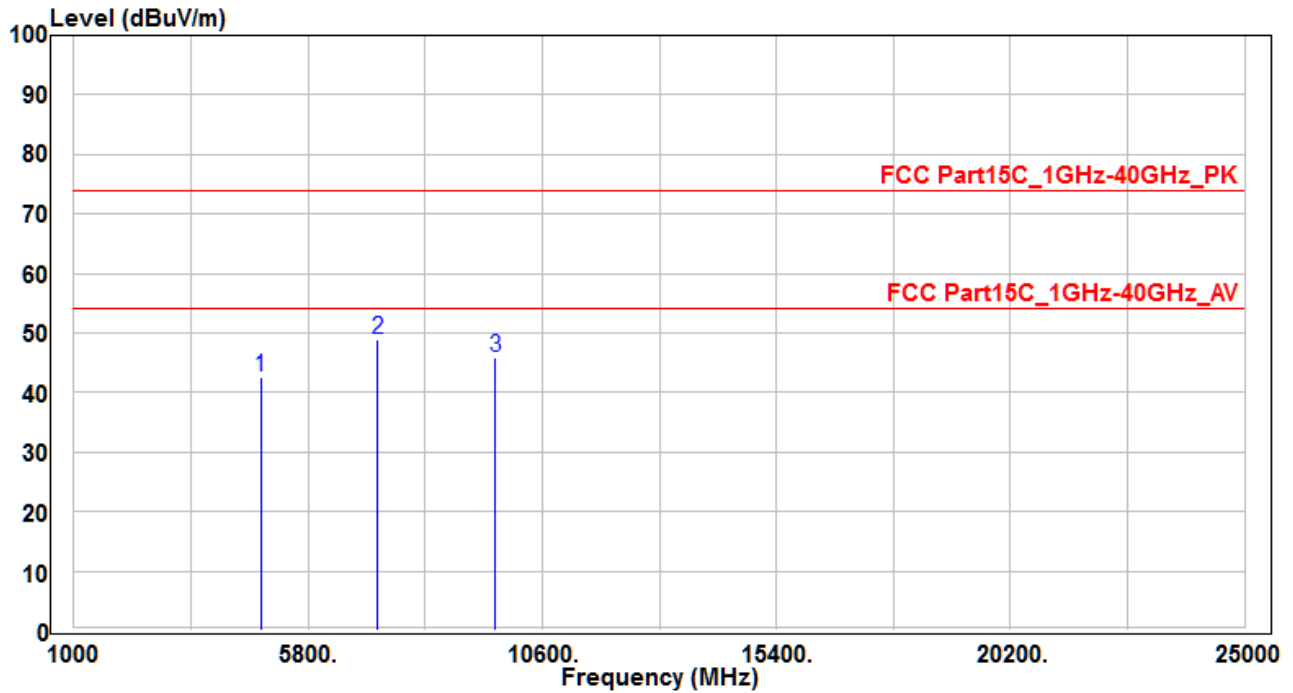

No	Frequency (MHz)	Reading (dBuV)	C.F (dB)	Measurement (dBuV/m)	Margin (dB)	Limit (dBuV)	Height (cm)	Angle (deg)	Remark (QP/PK/AV)
1	4824	38.83	3.67	42.5	-31.5	74	100	400	Peak
2	*	36.69	12.19	48.88	-25.12	74	100	400	Peak
3	9648	30.18	15.67	45.85	-28.15	74	100	400	Peak

Note :

- "*" means the worst value in this measurement data °
- Measure Level (dBμV/m) = Reading Level (dBμV) + Factor (dB) °
- Factor (dB) = Cable Loss (dB) + Antenna Factor (dB/m) °
- The emission levels of other frequencies are very lower than the limit and not show in test report °

EUT	E-READER	Test Date	2017/06/02
Factor	BBHA 9120D (1GHz~18GHz)	Temp. / Humidity	25°C / 60%
Polarity	Horizontal	Site / Engineer	AC1 / Peter
Test Mode	MODE1_b-CH06	Test Voltage	AC 120V/60Hz

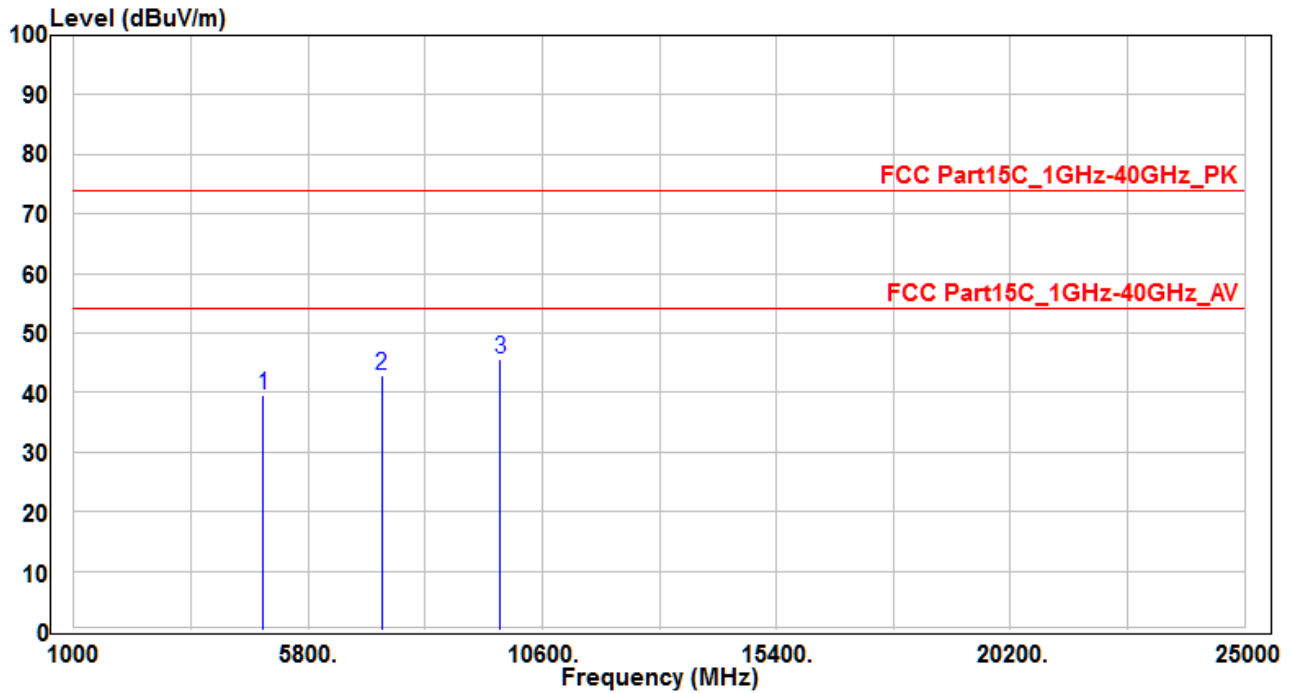

No	Frequency (MHz)	Reading (dBuV)	C.F (dB)	Measurement (dBuV/m)	Margin (dB)	Limit (dBuV)	Height (cm)	Angle (deg)	Remark (QP/PK/AV)
1	4874	35.91	3.65	39.56	-34.44	74	100	400	Peak
2	7311	30.41	12.34	42.75	-31.25	74	100	400	Peak
3	* 9748	29.59	16.02	45.61	-28.39	74	100	400	Peak

Note :

- "*" means the worst value in this measurement data °
- Measure Level (dBuV/m) = Reading Level (dBuV) + Factor (dB) °
- Factor (dB) = Cable Loss (dB) + Antenna Factor (dB/m) °
- The emission levels of other frequencies are very lower than the limit and not show in test report °

EUT	E-READER	Test Date	2017/06/02
Factor	BBHA 9120D (1GHz~18GHz)	Temp. / Humidity	25°C / 60%
Polarity	Vertical	Site / Engineer	AC1 / Peter
Test Mode	MODE1_b-CH06	Test Voltage	AC 120V/60Hz

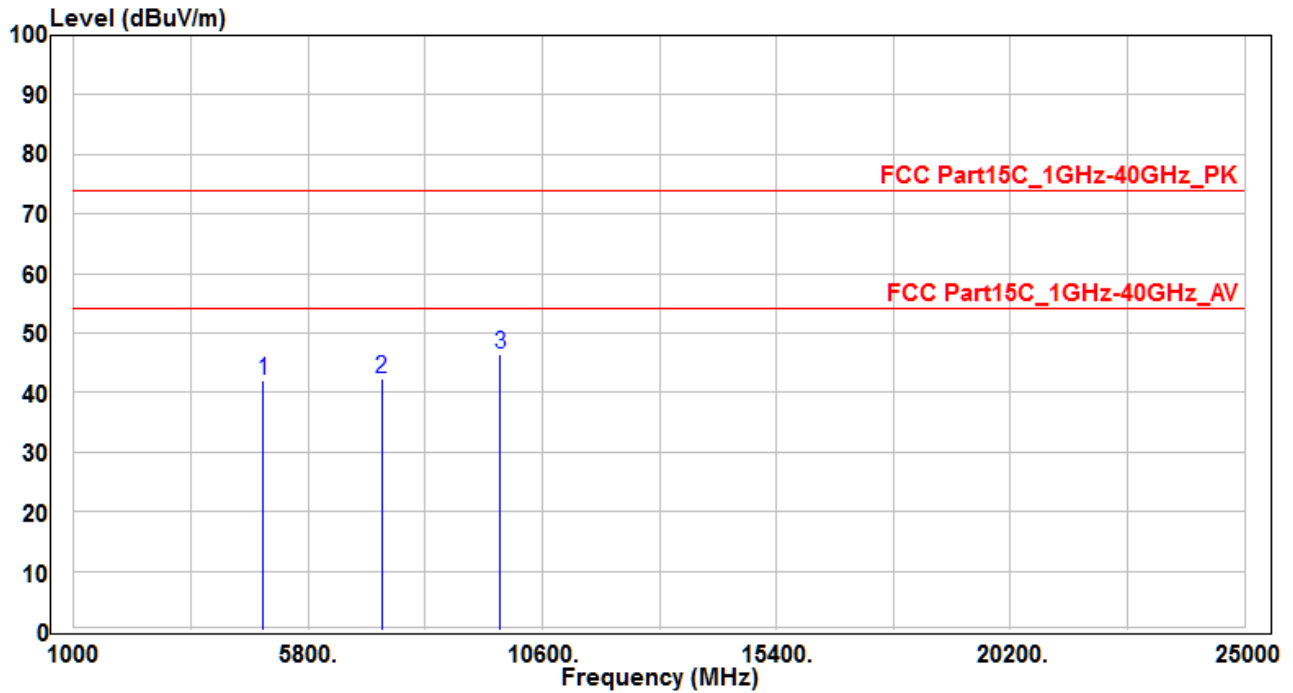

No	Frequency (MHz)	Reading (dBuV)	C.F (dB)	Measurement (dBuV/m)	Margin (dB)	Limit (dBuV)	Height (cm)	Angle (deg)	Remark (QP/PK/AV)
1	4874	38.36	3.65	42.01	-31.99	74	100	400	Peak
2	7311	29.99	12.34	42.33	-31.67	74	100	400	Peak
3	* 9748	30.32	16.02	46.34	-27.66	74	100	400	Peak

Note :

1. " * " means the worst value in this measurement data °
2. Measure Level (dBuV/m) = Reading Level (dBuV) + Factor (dB) °
3. Factor (dB) = Cable Loss (dB) + Antenna Factor (dB/m) °
4. The emission levels of other frequencies are very lower than the limit and not show in test report °

EUT	E-READER	Test Date	2017/06/02
Factor	BBHA 9120D (1GHz~18GHz)	Temp. / Humidity	25°C / 60%
Polarity	Horizontal	Site / Engineer	AC1 / Peter
Test Mode	MODE1_b-CH11	Test Voltage	AC 120V/60Hz

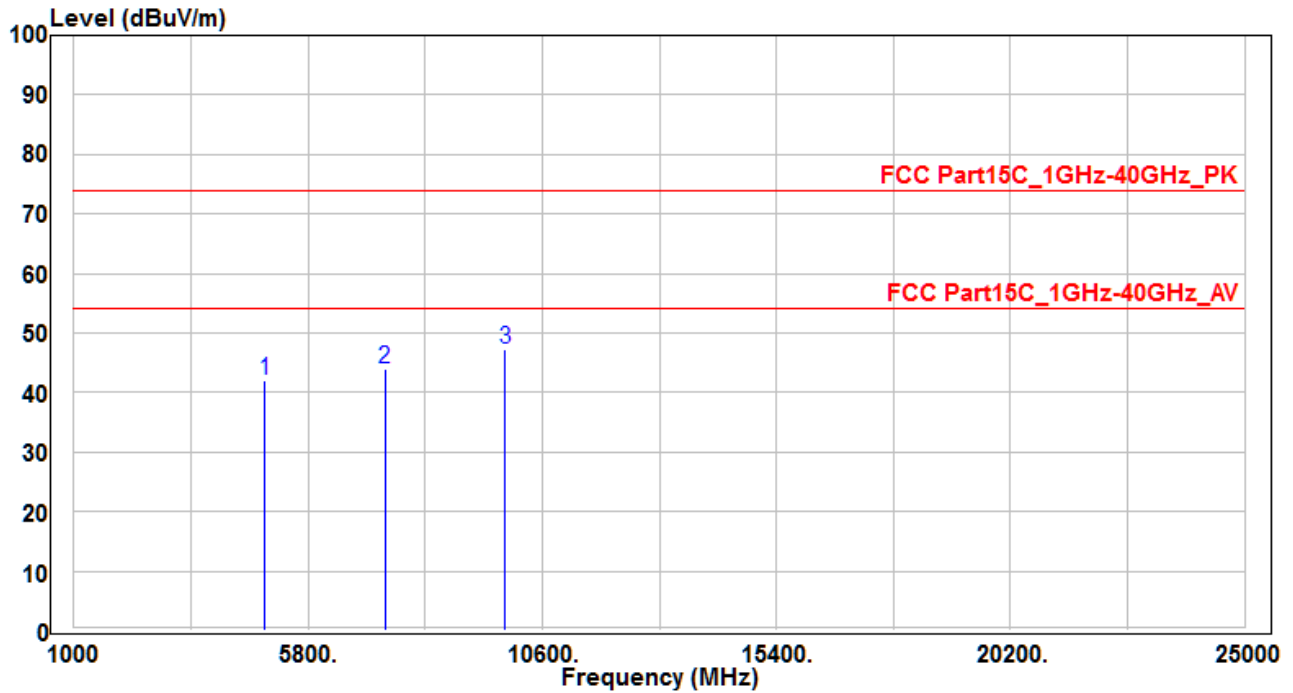

No	Frequency (MHz)	Reading (dBuV)	C.F (dB)	Measurement (dBuV/m)	Margin (dB)	Limit (dBuV)	Height (cm)	Angle (deg)	Remark (QP/PK/AV)
1	4924	38.49	3.65	42.14	-31.86	74	100	400	Peak
2	7386	31.37	12.53	43.9	-30.1	74	100	400	Peak
3	* 9848	30.9	16.34	47.24	-26.76	74	100	400	Peak

Note :

- "*" means the worst value in this measurement data °
- Measure Level (dBuV/m) = Reading Level (dBuV) + Factor (dB) °
- Factor (dB) = Cable Loss (dB) + Antenna Factor (dB/m) °
- The emission levels of other frequencies are very lower than the limit and not show in test report °

EUT	E-READER	Test Date	2017/06/02
Factor	BBHA 9120D (1GHz~18GHz)	Temp. / Humidity	25°C / 60%
Polarity	Vertical	Site / Engineer	AC1 / Peter
Test Mode	MODE1_b-CH11	Test Voltage	AC 120V/60Hz

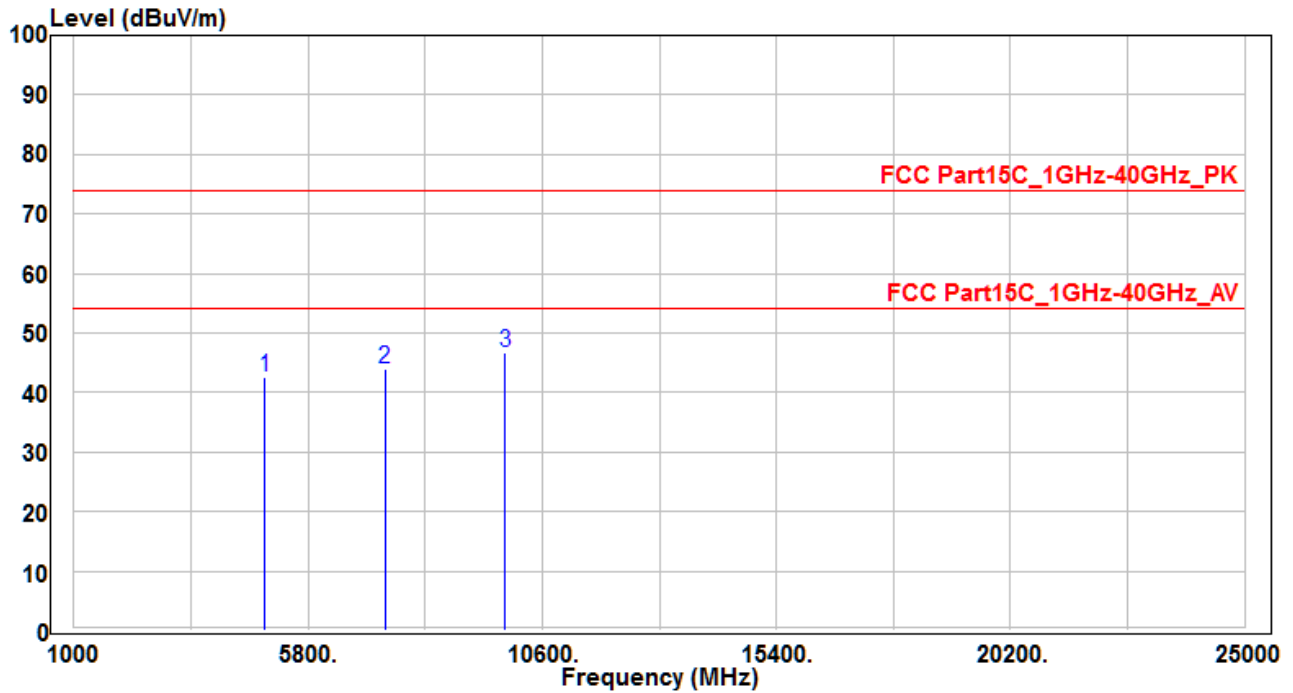

No	Frequency (MHz)	Reading (dBuV)	C.F (dB)	Measurement (dBuV/m)	Margin (dB)	Limit (dBuV)	Height (cm)	Angle (deg)	Remark (QP/PK/AV)
1	4924	39.05	3.65	42.7	-31.3	74	100	400	Peak
2	7386	31.54	12.53	44.07	-29.93	74	100	400	Peak
3	* 9848	30.37	16.34	46.71	-27.29	74	100	400	Peak

Note :

5. " * " means the worst value in this measurement data °
6. Measure Level (dBμV/m) = Reading Level (dBμV) + Factor (dB) °
7. Factor (dB) = Cable Loss (dB) + Antenna Factor (dB/m) °
8. The emission levels of other frequencies are very lower than the limit and not show in test report °

EUT	E-READER	Test Date	2017/06/02
Factor	BBHA 9120D (1GHz~18GHz)	Temp. / Humidity	25°C / 60%
Polarity	Horizontal	Site / Engineer	AC1 / Peter
Test Mode	MODE2_g-CH01	Test Voltage	AC 120V/60Hz

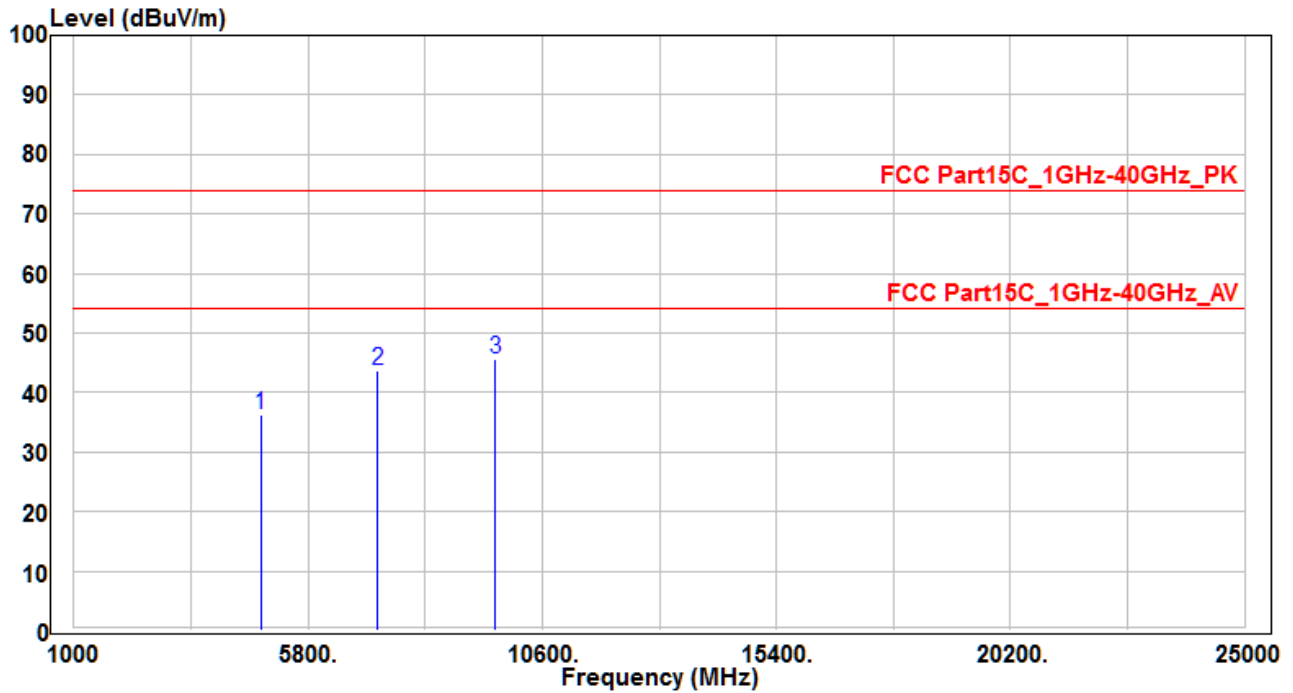

No	Frequency (MHz)	Reading (dBuV)	C.F (dB)	Measurement (dBuV/m)	Margin (dB)	Limit (dBuV)	Height (cm)	Angle (deg)	Remark (QP/PK/AV)
1	4824	32.73	3.67	36.4	-37.6	74	100	400	Peak
2	7236	31.46	12.19	43.65	-30.35	74	100	400	Peak
3	* 9648	29.98	15.67	45.65	-28.35	74	100	400	Peak

Note :

- " * " means the worst value in this measurement data °
- Measure Level (dBuV/m) = Reading Level (dBuV) + Factor (dB) °
- Factor (dB) = Cable Loss (dB) + Antenna Factor (dB/m) °
- The emission levels of other frequencies are very lower than the limit and not show in test report °

EUT	E-READER	Test Date	2017/06/02
Factor	BBHA 9120D (1GHz~18GHz)	Temp. / Humidity	25°C / 60%
Polarity	Vertical	Site / Engineer	AC1 / Peter
Test Mode	MODE2_g-CH01	Test Voltage	AC 120V/60Hz

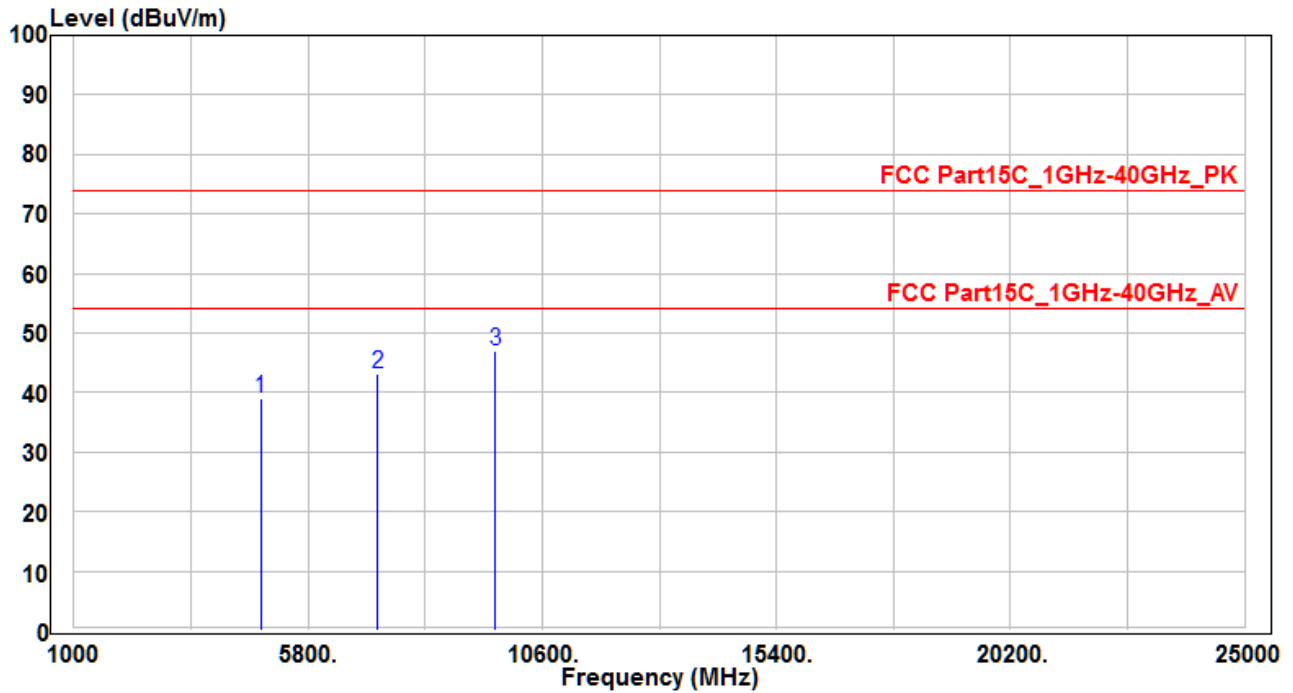

No	Frequency (MHz)	Reading (dBuV)	C.F (dB)	Measurement (dBuV/m)	Margin (dB)	Limit (dBuV)	Height (cm)	Angle (deg)	Remark (QP/PK/AV)
1	4824	35.32	3.67	38.99	-35.01	74	100	400	Peak
2	7236	30.95	12.19	43.14	-30.86	74	100	400	Peak
3	9648	31.23	15.67	46.9	-27.1	74	100	400	Peak

Note :

- " * " means the worst value in this measurement data °
- Measure Level (dBμV/m) = Reading Level (dBμV) + Factor (dB) °
- Factor (dB) = Cable Loss (dB) + Antenna Factor (dB/m) °
- The emission levels of other frequencies are very lower than the limit and not show in test report °

EUT	E-READER	Test Date	2017/06/02
Factor	BBHA 9120D (1GHz~18GHz)	Temp. / Humidity	25°C / 60%
Polarity	Horizontal	Site / Engineer	AC1 / Peter
Test Mode	MODE2_g-CH06	Test Voltage	AC 120V/60Hz

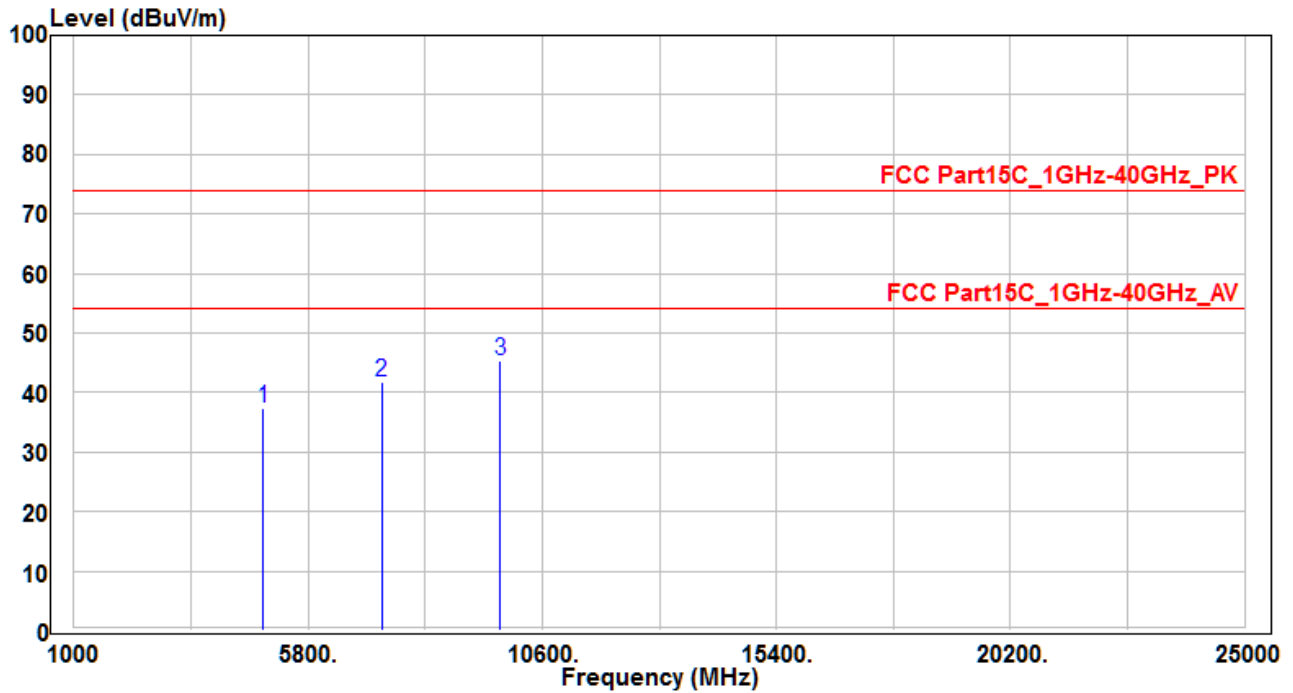

No	Frequency (MHz)	Reading (dBuV)	C.F (dB)	Measurement (dBuV/m)	Margin (dB)	Limit (dBuV)	Height (cm)	Angle (deg)	Remark (QP/PK/AV)
1	4874	33.74	3.65	37.39	-36.61	74	100	400	Peak
2	7311	29.35	12.34	41.69	-32.31	74	100	400	Peak
3	* 9748	29.28	16.02	45.3	-28.7	74	100	400	Peak

Note :

- " * " means the worst value in this measurement data °
- Measure Level (dBuV/m) = Reading Level (dBuV) + Factor (dB) °
- Factor (dB) = Cable Loss (dB) + Antenna Factor (dB/m) °
- The emission levels of other frequencies are very lower than the limit and not show in test report °

EUT	E-READER	Test Date	2017/06/02
Factor	BBHA 9120D (1GHz~18GHz)	Temp. / Humidity	25°C / 60%
Polarity	Vertical	Site / Engineer	AC1 / Peter
Test Mode	MODE2_g-CH06	Test Voltage	AC 120V/60Hz

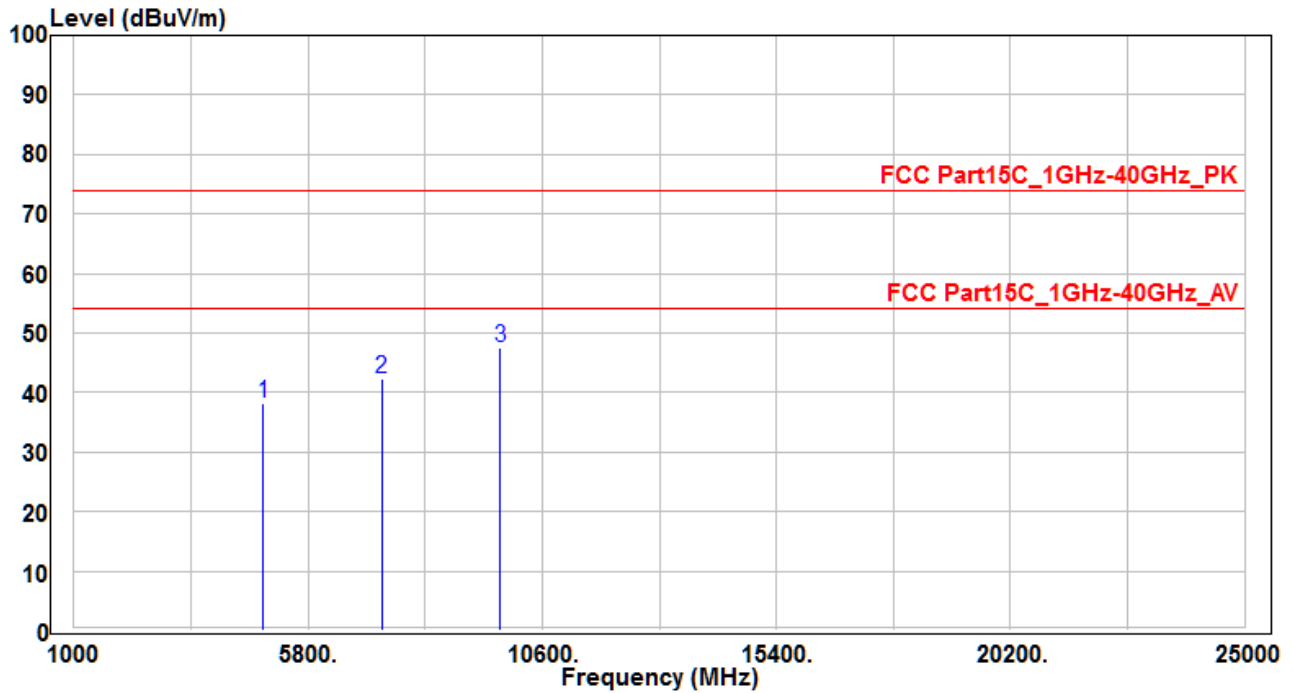

No	Frequency (MHz)	Reading (dBuV)	C.F (dB)	Measurement (dBuV/m)	Margin (dB)	Limit (dBuV)	Height (cm)	Angle (deg)	Remark (QP/PK/AV)
1	4874	34.6	3.65	38.25	-35.75	74	100	400	Peak
2	7311	30.05	12.34	42.39	-31.61	74	100	400	Peak
3	* 9748	31.57	16.02	47.59	-26.41	74	100	400	Peak

Note :

- " * " means the worst value in this measurement data °
- Measure Level (dBuV/m) = Reading Level (dBuV) + Factor (dB) °
- Factor (dB) = Cable Loss (dB) + Antenna Factor (dB/m) °
- The emission levels of other frequencies are very lower than the limit and not show in test report °

EUT	E-READER	Test Date	2017/06/02
Factor	BBHA 9120D (1GHz~18GHz)	Temp. / Humidity	25°C / 60%
Polarity	Horizontal	Site / Engineer	AC1 / Peter
Test Mode	MODE2_g-CH11	Test Voltage	AC 120V/60Hz

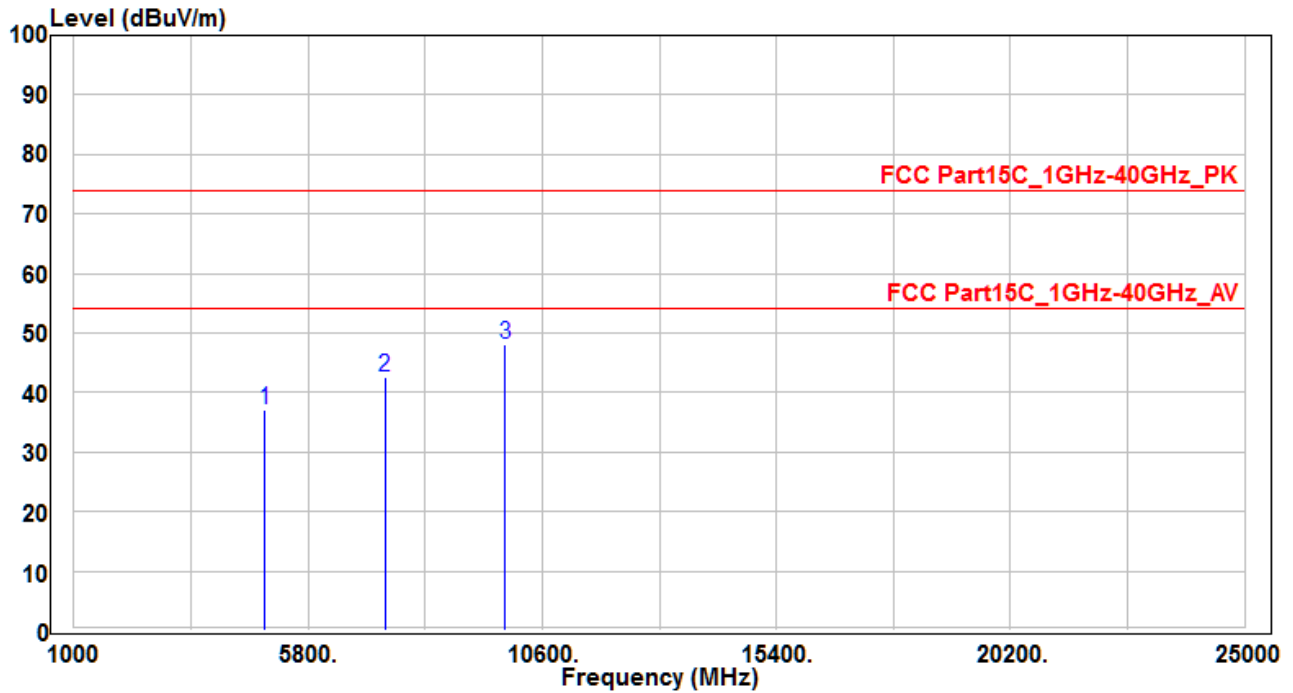

No	Frequency (MHz)	Reading (dBuV)	C.F (dB)	Measurement (dBuV/m)	Margin (dB)	Limit (dBuV)	Height (cm)	Angle (deg)	Remark (QP/PK/AV)
1	4924	33.45	3.65	37.1	-36.9	74	100	400	Peak
2	7386	29.98	12.53	42.51	-31.49	74	100	400	Peak
3	* 9848	31.8	16.34	48.14	-25.86	74	100	400	Peak

Note :

- " * " means the worst value in this measurement data °
- Measure Level (dBμV/m) = Reading Level (dBμV) + Factor (dB) °
- Factor (dB) = Cable Loss (dB) + Antenna Factor (dB/m) °
- The emission levels of other frequencies are very lower than the limit and not show in test report °

EUT	E-READER	Test Date	2017/06/02
Factor	BBHA 9120D (1GHz~18GHz)	Temp. / Humidity	25°C / 60%
Polarity	Vertical	Site / Engineer	AC1 / Peter
Test Mode	MODE2_g-CH11	Test Voltage	AC 120V/60Hz

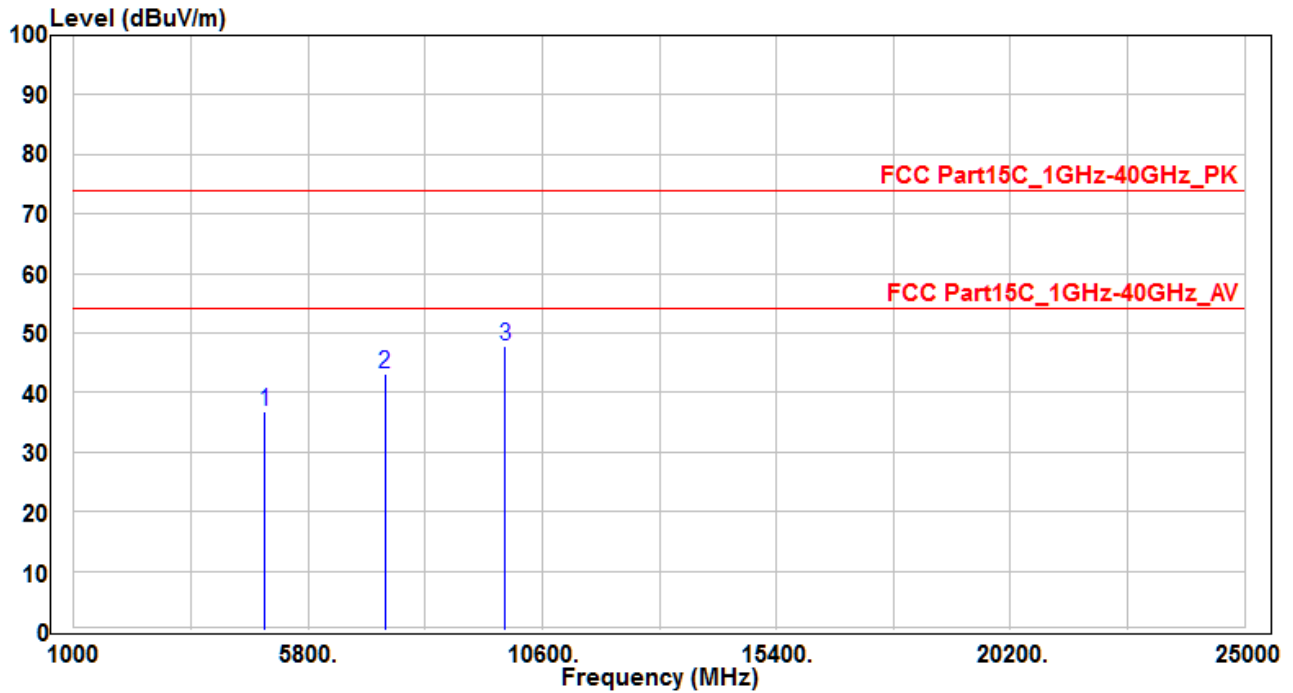

No	Frequency (MHz)	Reading (dBuV)	C.F (dB)	Measurement (dBuV/m)	Margin (dB)	Limit (dBuV)	Height (cm)	Angle (deg)	Remark (QP/PK/AV)
1	4924	33.23	3.65	36.88	-37.12	74	100	400	Peak
2	7386	30.48	12.53	43.01	-30.99	74	100	400	Peak
3	* 9848	31.48	16.34	47.82	-26.18	74	100	400	Peak

Note :

- " * " means the worst value in this measurement data °
- Measure Level (dBuV/m) = Reading Level (dBuV) + Factor (dB) °
- Factor (dB) = Cable Loss (dB) + Antenna Factor (dB/m) °
- The emission levels of other frequencies are very lower than the limit and not show in test report °

EUT	E-READER	Test Date	2017/06/02
Factor	BBHA 9120D (1GHz~18GHz)	Temp. / Humidity	25°C / 60%
Polarity	Horizontal	Site / Engineer	AC1 / Peter
Test Mode	MODE3_n-20M-CH01	Test Voltage	AC 120V/60Hz

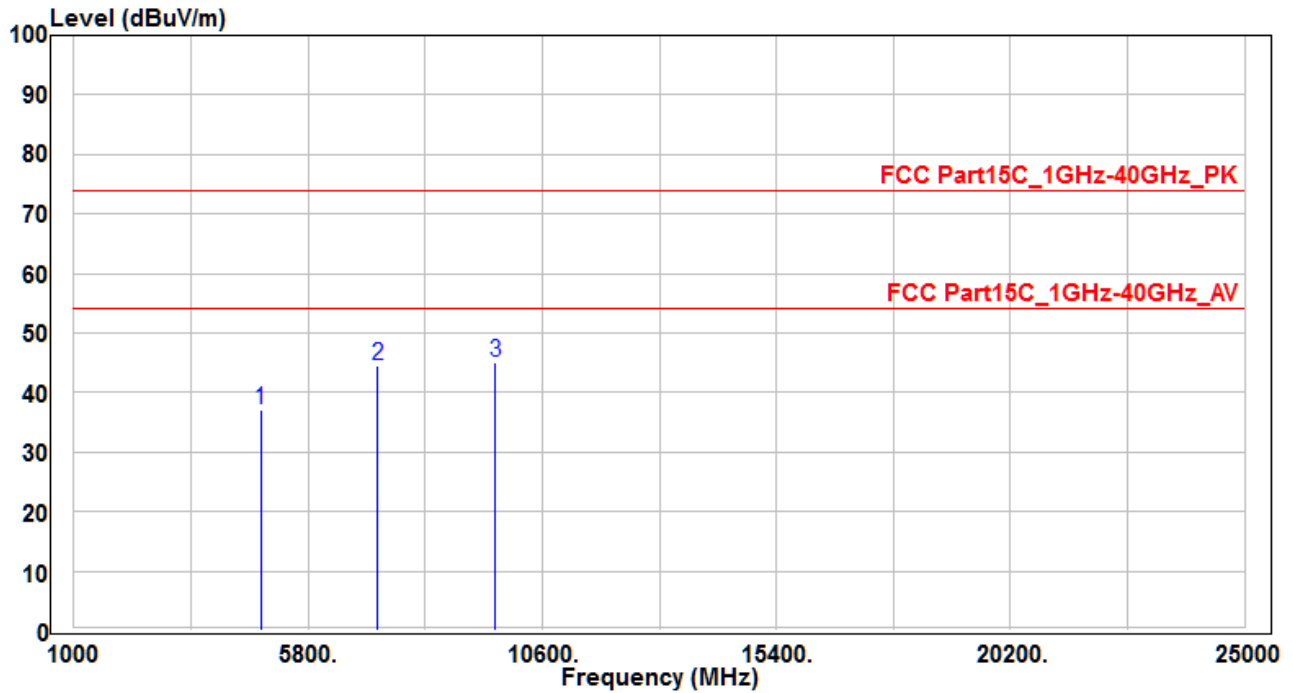

No	Frequency (MHz)	Reading (dBuV)	C.F (dB)	Measurement (dBuV/m)	Margin (dB)	Limit (dBuV)	Height (cm)	Angle (deg)	Remark (QP/PK/AV)
1	4824	33.4	3.67	37.07	-36.93	74	100	400	Peak
2	* 7236	32.39	12.19	44.58	-29.42	74	100	400	Peak
3	9648	29.49	15.67	45.16	-28.84	74	100	400	Peak

Note :

- "*" means the worst value in this measurement data °
- Measure Level (dBuV/m) = Reading Level (dBuV) + Factor (dB) °
- Factor (dB) = Cable Loss (dB) + Antenna Factor (dB/m) °
- The emission levels of other frequencies are very lower than the limit and not show in test report °

EUT	E-READER	Test Date	2017/06/02
Factor	BBHA 9120D (1GHz~18GHz)	Temp. / Humidity	25°C / 60%
Polarity	Vertical	Site / Engineer	AC1 / Peter
Test Mode	MODE3_n-20M-CH01	Test Voltage	AC 120V/60Hz

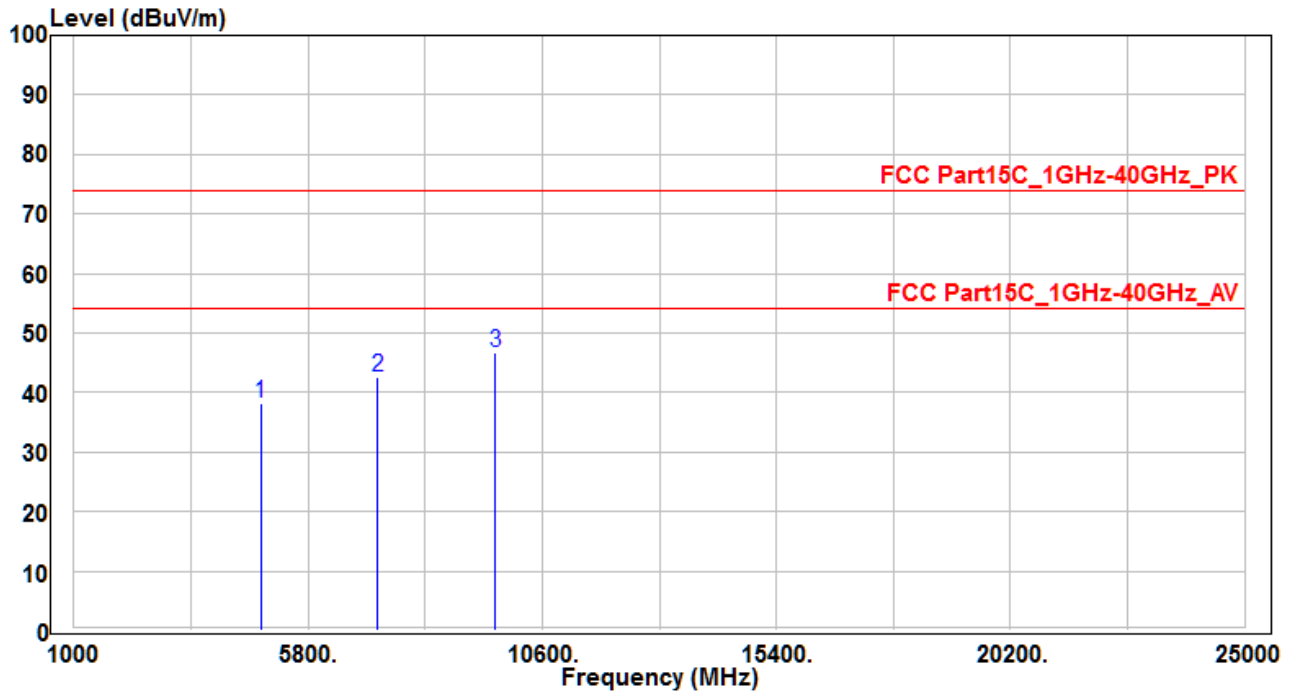

No	Frequency (MHz)	Reading (dBuV)	C.F (dB)	Measurement (dBuV/m)	Margin (dB)	Limit (dBuV)	Height (cm)	Angle (deg)	Remark (QP/PK/AV)
1	4824	34.63	3.67	38.3	-35.7	74	100	400	Peak
2	7236	30.28	12.19	42.47	-31.53	74	100	400	Peak
3	9648	31.17	15.67	46.84	-27.16	74	100	400	Peak

Note :

- " * " means the worst value in this measurement data °
- Measure Level (dBuV/m) = Reading Level (dBuV) + Factor (dB) °
- Factor (dB) = Cable Loss (dB) + Antenna Factor (dB/m) °
- The emission levels of other frequencies are very lower than the limit and not show in test report °

EUT	E-READER	Test Date	2017/06/02
Factor	BBHA 9120D (1GHz~18GHz)	Temp. / Humidity	25°C / 60%
Polarity	Horizontal	Site / Engineer	AC1 / Peter
Test Mode	MODE3_n-20M-CH06	Test Voltage	AC 120V/60Hz

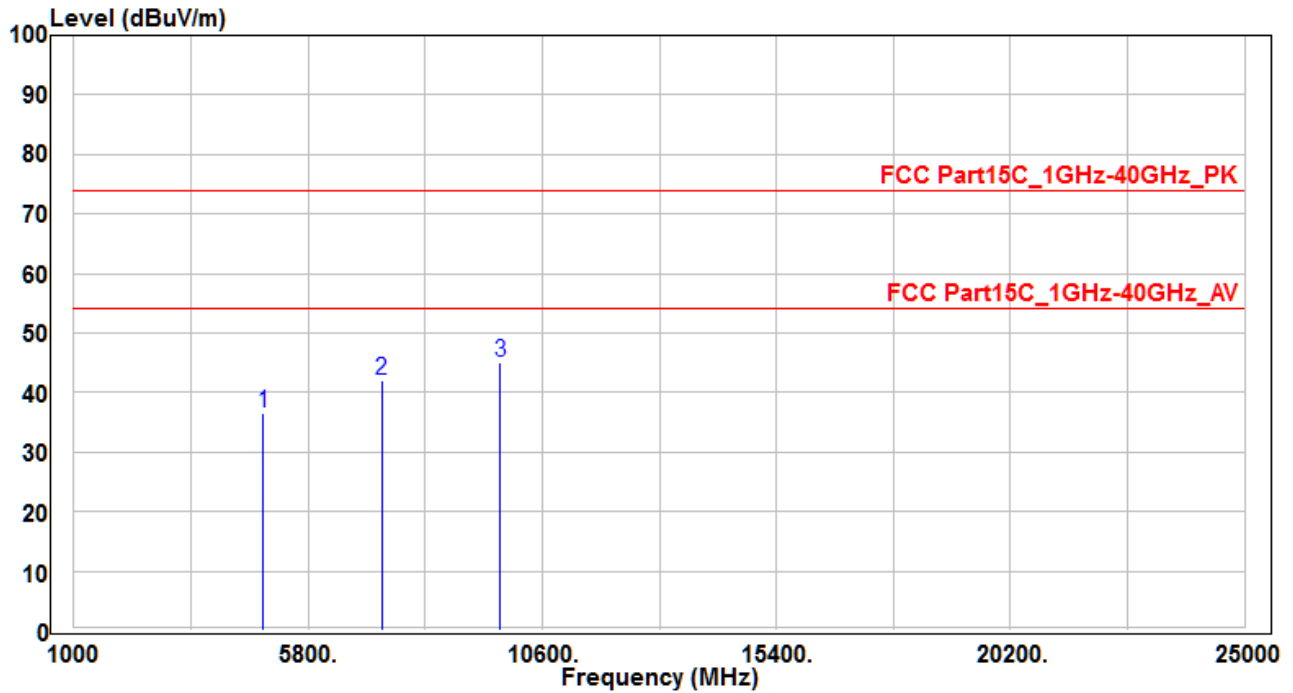

No	Frequency (MHz)	Reading (dBuV)	C.F (dB)	Measurement (dBuV/m)	Margin (dB)	Limit (dBuV)	Height (cm)	Angle (deg)	Remark (QP/PK/AV)
1	4874	32.97	3.65	36.62	-37.38	74	100	400	Peak
2	7311	29.76	12.34	42.1	-31.9	74	100	400	Peak
3	* 9748	29.05	16.02	45.07	-28.93	74	100	400	Peak

Note :

- " * " means the worst value in this measurement data °
- Measure Level (dBuV/m) = Reading Level (dBuV) + Factor (dB) °
- Factor (dB) = Cable Loss (dB) + Antenna Factor (dB/m) °
- The emission levels of other frequencies are very lower than the limit and not show in test report °

EUT	E-READER	Test Date	2017/06/02
Factor	BBHA 9120D (1GHz~18GHz)	Temp. / Humidity	25°C / 60%
Polarity	Vertical	Site / Engineer	AC1 / Peter
Test Mode	MODE3_n-20M-CH06	Test Voltage	AC 120V/60Hz

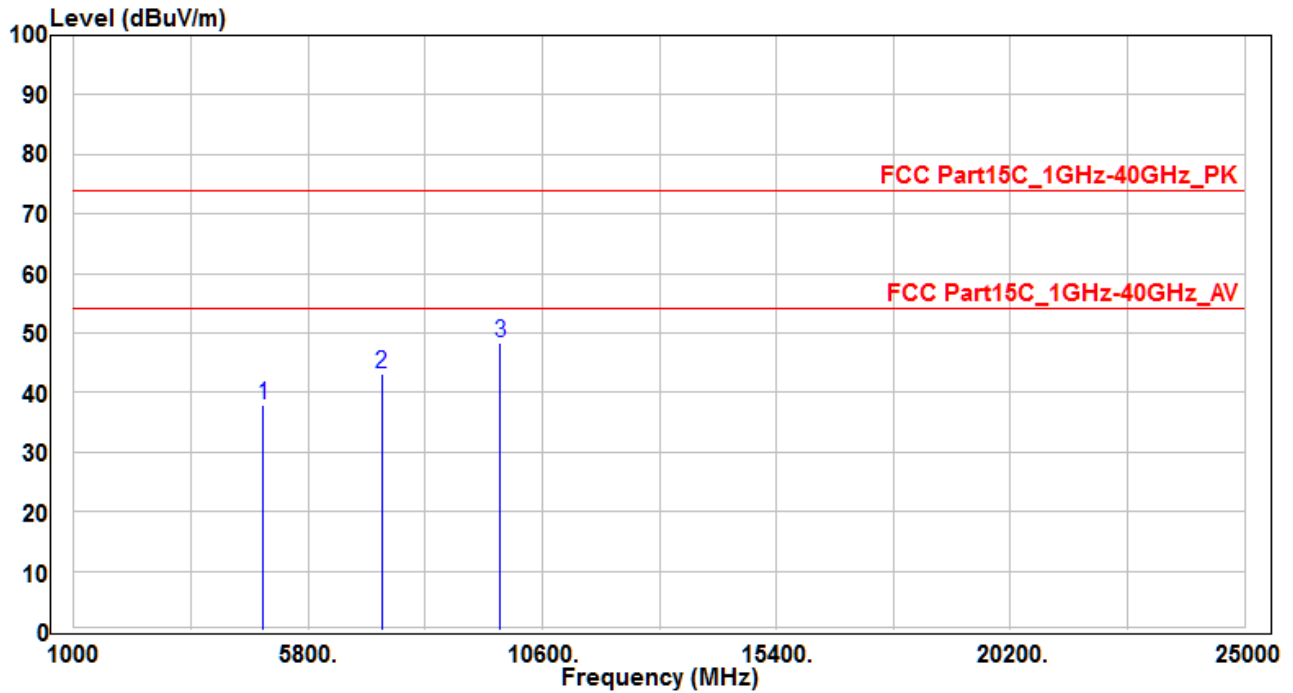

No	Frequency (MHz)	Reading (dBuV)	C.F (dB)	Measurement (dBuV/m)	Margin (dB)	Limit (dBuV)	Height (cm)	Angle (deg)	Remark (QP/PK/AV)
1	4874	34.2	3.65	37.85	-36.15	74	100	400	Peak
2	7311	30.92	12.34	43.26	-30.74	74	100	400	Peak
3	* 9748	32.4	16.02	48.42	-25.58	74	100	400	Peak

Note :

- " * " means the worst value in this measurement data °
- Measure Level (dBuV/m) = Reading Level (dBuV) + Factor (dB) °
- Factor (dB) = Cable Loss (dB) + Antenna Factor (dB/m) °
- The emission levels of other frequencies are very lower than the limit and not show in test report °

EUT	E-READER	Test Date	2017/06/02
Factor	BBHA 9120D (1GHz~18GHz)	Temp. / Humidity	25°C / 60%
Polarity	Horizontal	Site / Engineer	AC1 / Peter
Test Mode	MODE3_n-20M-CH11	Test Voltage	AC 120V/60Hz

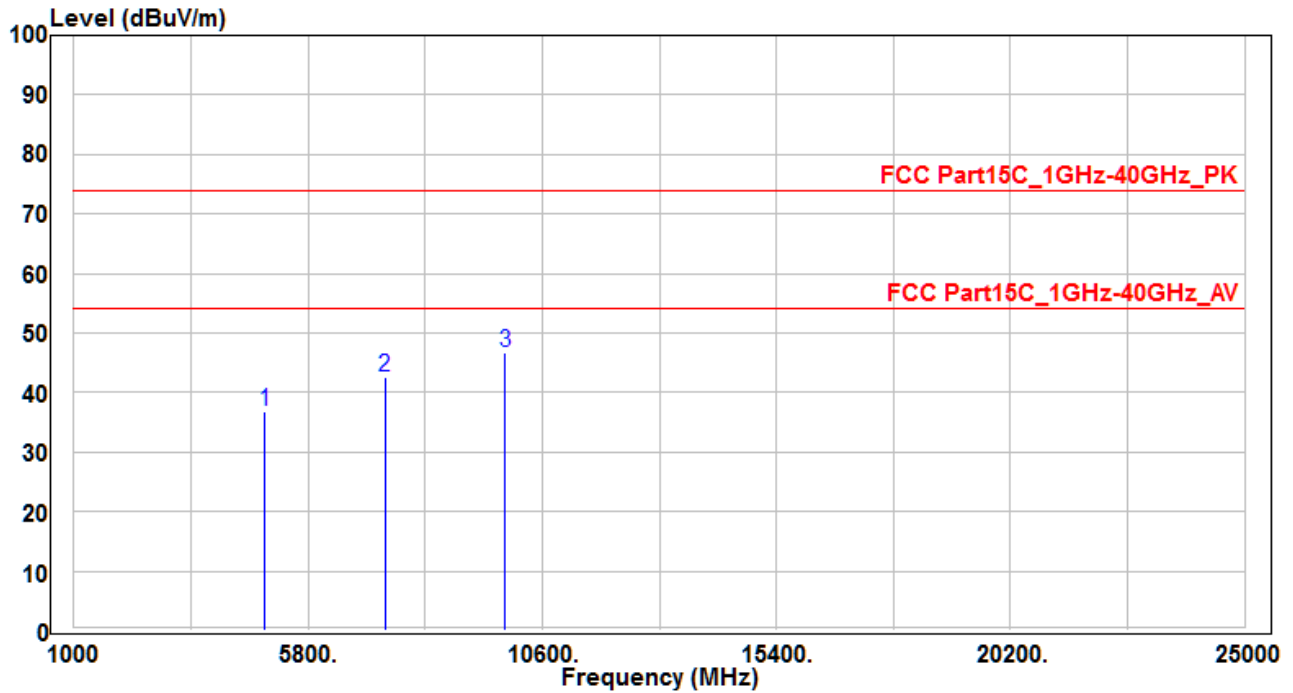

No	Frequency (MHz)	Reading (dBuV)	C.F (dB)	Measurement (dBuV/m)	Margin (dB)	Limit (dBuV)	Height (cm)	Angle (deg)	Remark (QP/PK/AV)
1	4924	33.16	3.65	36.81	-37.19	74	100	400	Peak
2	7386	30.07	12.53	42.6	-31.4	74	100	400	Peak
3	* 9848	30.39	16.34	46.73	-27.27	74	100	400	Peak

Note :

- " * " means the worst value in this measurement data °
- Measure Level (dBμV/m) = Reading Level (dBμV) + Factor (dB) °
- Factor (dB) = Cable Loss (dB) + Antenna Factor (dB/m) °
- The emission levels of other frequencies are very lower than the limit and not show in test report °

EUT	E-READER	Test Date	2017/06/02
Factor	BBHA 9120D (1GHz~18GHz)	Temp. / Humidity	25°C / 60%
Polarity	Vertical	Site / Engineer	AC1 / Peter
Test Mode	MODE3_n-20M-CH11	Test Voltage	AC 120V/60Hz

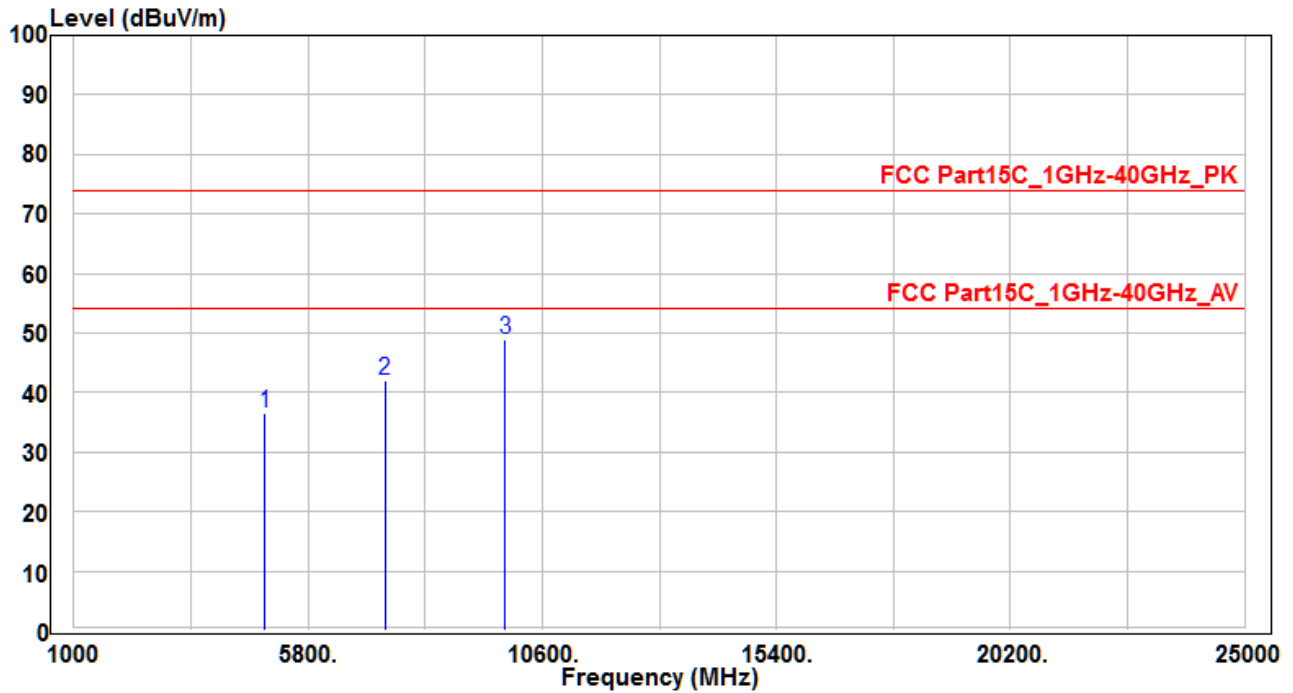

No	Frequency (MHz)	Reading (dBuV)	C.F (dB)	Measurement (dBuV/m)	Margin (dB)	Limit (dBuV)	Height (cm)	Angle (deg)	Remark (QP/PK/AV)
1	4924	32.77	3.65	36.42	-37.58	74	100	400	Peak
2	7386	29.62	12.53	42.15	-31.85	74	100	400	Peak
3	* 9848	32.69	16.34	49.03	-24.97	74	100	400	Peak

Note :

- " * " means the worst value in this measurement data °
- Measure Level (dBuV/m) = Reading Level (dBuV) + Factor (dB) °
- Factor (dB) = Cable Loss (dB) + Antenna Factor (dB/m) °
- The emission levels of other frequencies are very lower than the limit and not show in test report °

EUT	E-READER	Test Date	2017/06/02
Factor	BBHA 9120D (1GHz~18GHz)	Temp. / Humidity	25°C / 60%
Polarity	Horizontal	Site / Engineer	AC1 / Peter
Test Mode	MODE4_n-40M-CH03	Test Voltage	AC 120V/60Hz

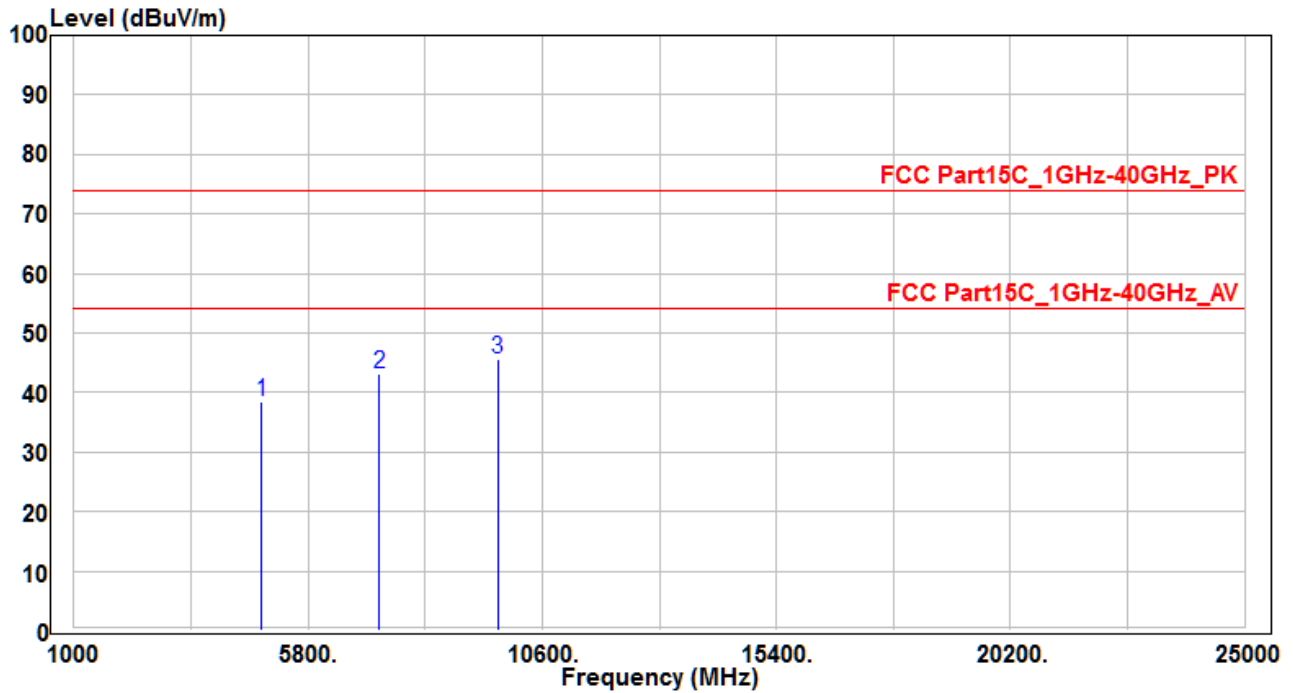

No	Frequency (MHz)	Reading (dBuV)	C.F (dB)	Measurement (dBuV/m)	Margin (dB)	Limit (dBuV)	Height (cm)	Angle (deg)	Remark (QP/PK/AV)
1	4844	34.66	3.68	38.34	-35.66	74	100	400	Peak
2	7266	30.99	12.25	43.24	-30.76	74	100	400	Peak
3	* 9688	29.9	15.81	45.71	-28.29	74	100	400	Peak

Note :

- " * " means the worst value in this measurement data °
- Measure Level (dBuV/m) = Reading Level (dBuV) + Factor (dB) °
- Factor (dB) = Cable Loss (dB) + Antenna Factor (dB/m) °
- The emission levels of other frequencies are very lower than the limit and not show in test report °

EUT	E-READER	Test Date	2017/06/02
Factor	BBHA 9120D (1GHz~18GHz)	Temp. / Humidity	25°C / 60%
Polarity	Vertical	Site / Engineer	AC1 / Peter
Test Mode	MODE4_n-40M-CH03	Test Voltage	AC 120V/60Hz

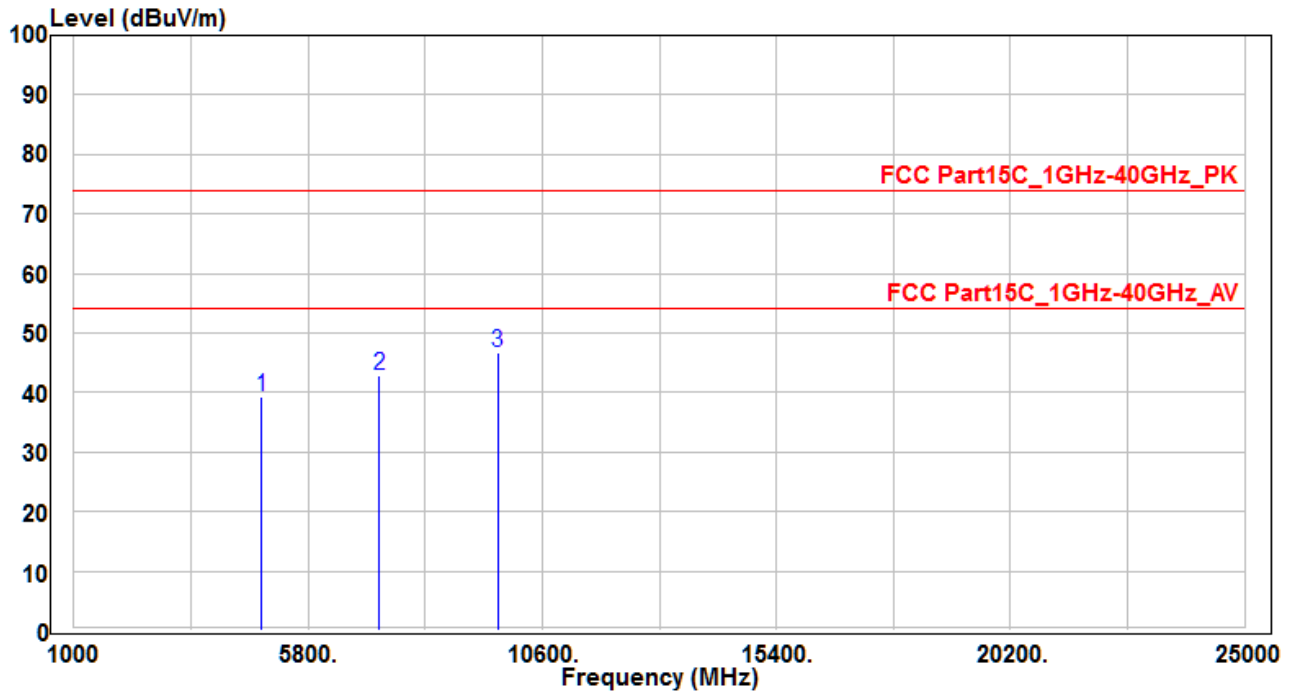

No	Frequency (MHz)	Reading (dBuV)	C.F (dB)	Measurement (dBuV/m)	Margin (dB)	Limit (dBuV)	Height (cm)	Angle (deg)	Remark (QP/PK/AV)
1	4844	35.54	3.68	39.22	-34.78	74	100	400	Peak
2	7266	30.75	12.25	43	-31	74	100	400	Peak
3	* 9688	30.97	15.81	46.78	-27.22	74	100	400	Peak

Note :

- " * " means the worst value in this measurement data °
- Measure Level (dBuV/m) = Reading Level (dBuV) + Factor (dB) °
- Factor (dB) = Cable Loss (dB) + Antenna Factor (dB/m) °
- The emission levels of other frequencies are very lower than the limit and not show in test report °

EUT	E-READER	Test Date	2017/06/02
Factor	BBHA 9120D (1GHz~18GHz)	Temp. / Humidity	25°C / 60%
Polarity	Horizontal	Site / Engineer	AC1 / Peter
Test Mode	MODE4_n-40M-CH06	Test Voltage	AC 120V/60Hz

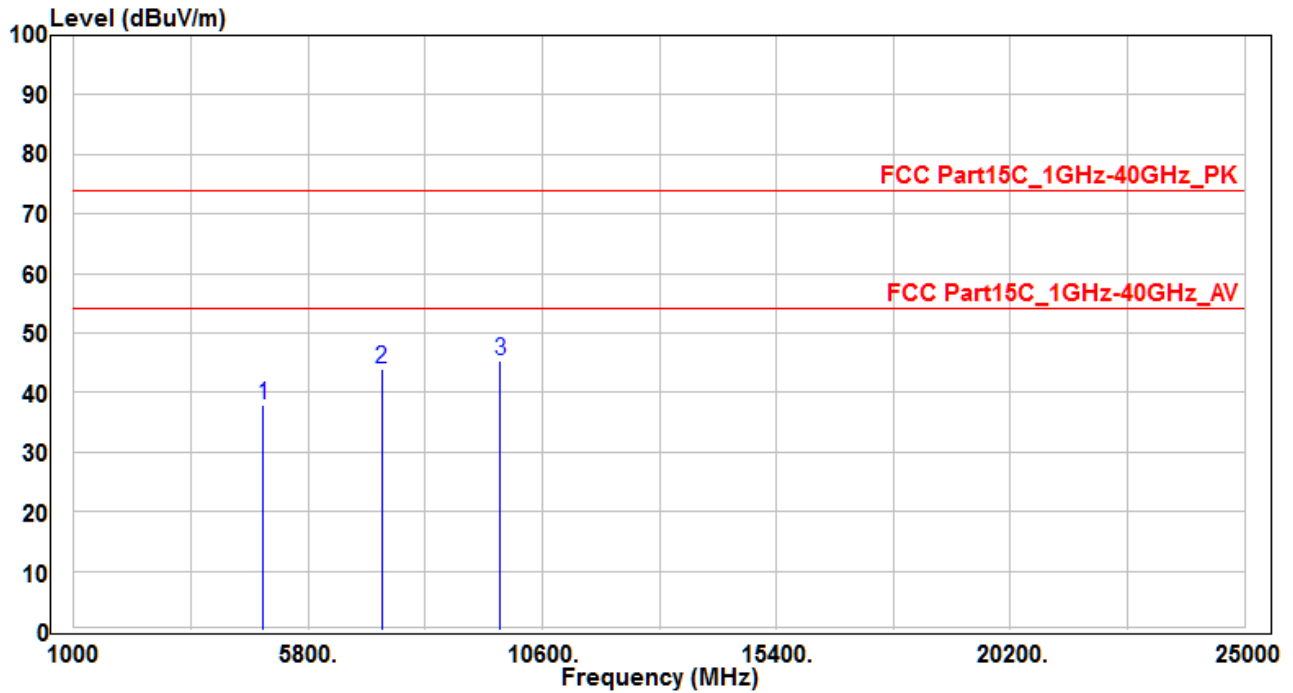

No	Frequency (MHz)	Reading (dBuV)	C.F (dB)	Measurement (dBuV/m)	Margin (dB)	Limit (dBuV)	Height (cm)	Angle (deg)	Remark (QP/PK/AV)
1	4874	34.37	3.65	38.02	-35.98	74	100	400	Peak
2	7311	31.74	12.34	44.08	-29.92	74	100	400	Peak
3	* 9748	29.26	16.02	45.28	-28.72	74	100	400	Peak

Note :

- " * " means the worst value in this measurement data °
- Measure Level (dBuV/m) = Reading Level (dBuV) + Factor (dB) °
- Factor (dB) = Cable Loss (dB) + Antenna Factor (dB/m) °
- The emission levels of other frequencies are very lower than the limit and not show in test report °

EUT	E-READER	Test Date	2017/06/02
Factor	BBHA 9120D (1GHz~18GHz)	Temp. / Humidity	25°C / 60%
Polarity	Vertical	Site / Engineer	AC1 / Peter
Test Mode	MODE4_n-40M-CH06	Test Voltage	AC 120V/60Hz

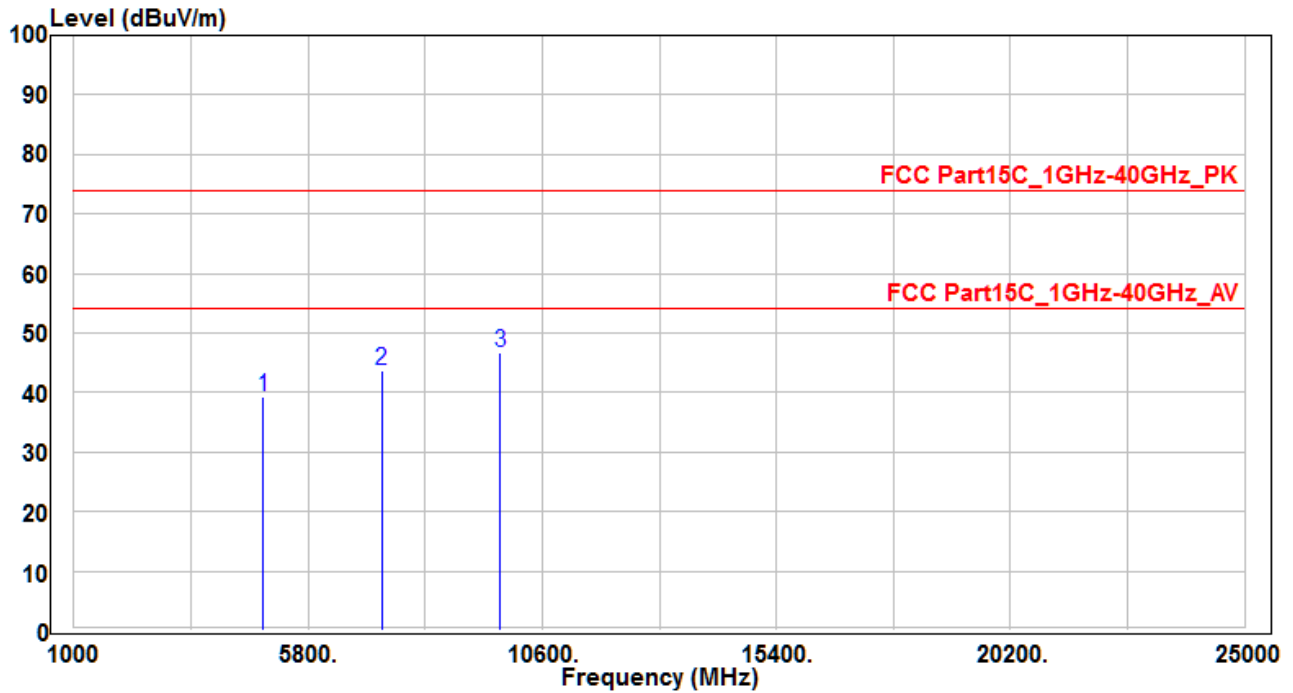

No	Frequency (MHz)	Reading (dBuV)	C.F (dB)	Measurement (dBuV/m)	Margin (dB)	Limit (dBuV)	Height (cm)	Angle (deg)	Remark (QP/PK/AV)
1	4874	35.78	3.65	39.43	-34.57	74	100	400	Peak
2	7311	31.42	12.34	43.76	-30.24	74	100	400	Peak
3	* 9748	30.65	16.02	46.67	-27.33	74	100	400	Peak

Note :

- " * " means the worst value in this measurement data °
- Measure Level (dBuV/m) = Reading Level (dBuV) + Factor (dB) °
- Factor (dB) = Cable Loss (dB) + Antenna Factor (dB/m) °
- The emission levels of other frequencies are very lower than the limit and not show in test report °

EUT	E-READER	Test Date	2017/06/02
Factor	BBHA 9120D (1GHz~18GHz)	Temp. / Humidity	25°C / 60%
Polarity	Horizontal	Site / Engineer	AC1 / Peter
Test Mode	MODE4_n-40M-CH09	Test Voltage	AC 120V/60Hz

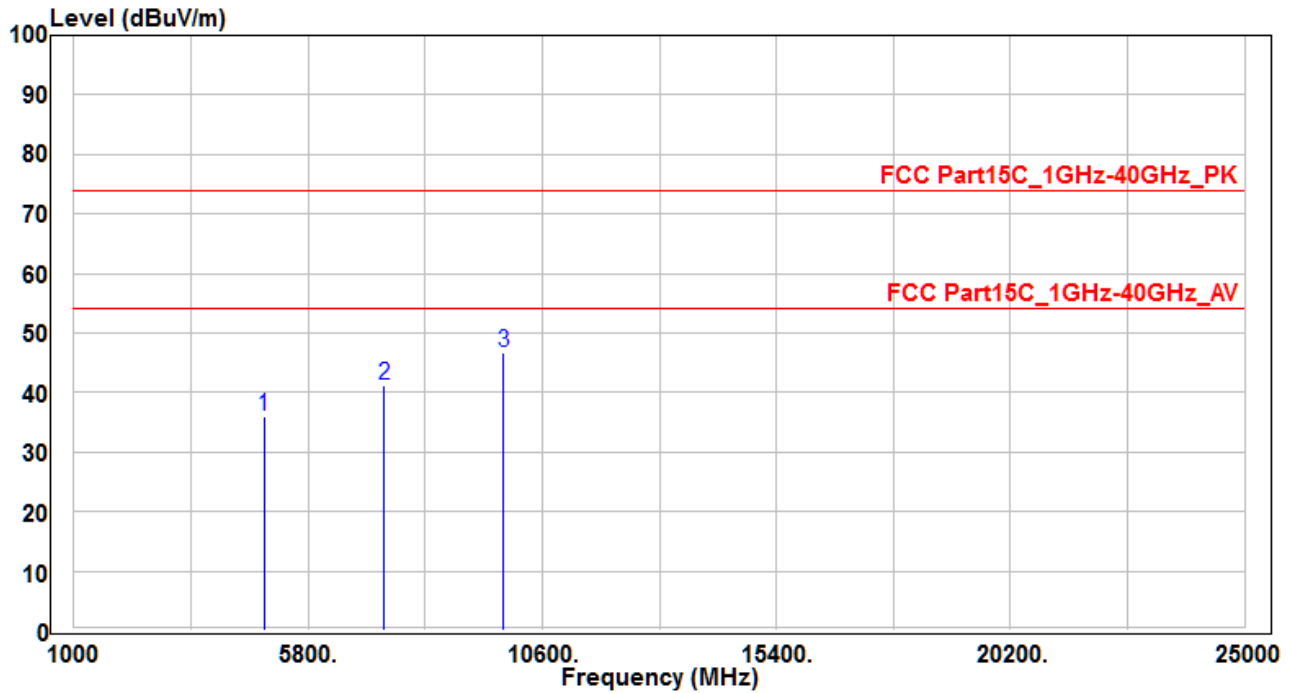

No	Frequency (MHz)	Reading (dBuV)	C.F (dB)	Measurement (dBuV/m)	Margin (dB)	Limit (dBuV)	Height (cm)	Angle (deg)	Remark (QP/PK/AV)
1	4904	32.31	3.64	35.95	-38.05	74	100	400	Peak
2	7356	28.84	12.44	41.28	-32.72	74	100	400	Peak
3	* 9808	30.45	16.24	46.69	-27.31	74	100	400	Peak

Note :

- " * " means the worst value in this measurement data °
- Measure Level (dBuV/m) = Reading Level (dBuV) + Factor (dB) °
- Factor (dB) = Cable Loss (dB) + Antenna Factor (dB/m) °
- The emission levels of other frequencies are very lower than the limit and not show in test report °

EUT	E-READER	Test Date	2017/06/02
Factor	BBHA 9120D (1GHz~18GHz)	Temp. / Humidity	25°C / 60%
Polarity	Vertical	Site / Engineer	AC1 / Peter
Test Mode	MODE4_n-40M-CH09	Test Voltage	AC 120V/60Hz

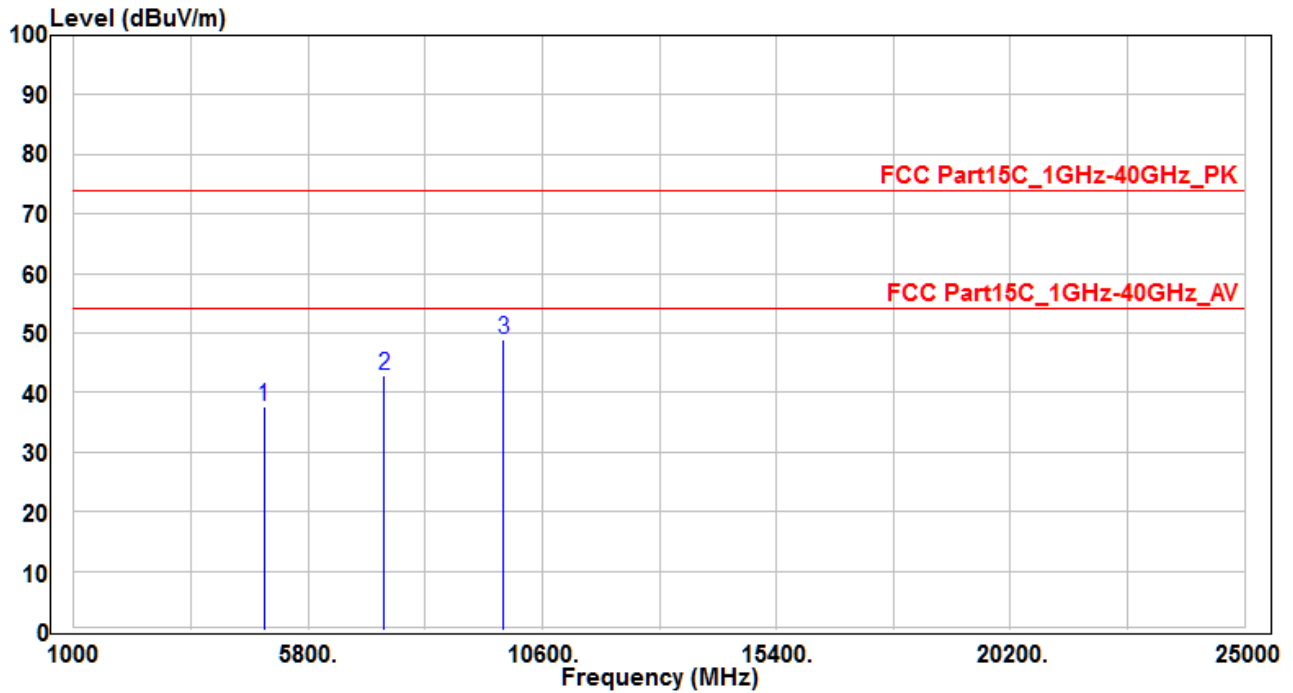

No	Frequency (MHz)	Reading (dBuV)	C.F (dB)	Measurement (dBuV/m)	Margin (dB)	Limit (dBuV)	Height (cm)	Angle (deg)	Remark (QP/PK/AV)
1	4904	34.11	3.64	37.75	-36.25	74	100	400	Peak
2	7356	30.4	12.44	42.84	-31.16	74	100	400	Peak
3	* 9808	32.58	16.24	48.82	-25.18	74	100	400	Peak

Note :

- " * " means the worst value in this measurement data °
- Measure Level (dBuV/m) = Reading Level (dBuV) + Factor (dB) °
- Factor (dB) = Cable Loss (dB) + Antenna Factor (dB/m) °
- The emission levels of other frequencies are very lower than the limit and not show in test report °

EUT	E-READER	Test Date	2017/06/02
Factor	BBHA 9120D (1GHz~18GHz)	Temp. / Humidity	25°C / 60%
Polarity	Horizontal	Site / Engineer	AC1 / Peter
Test Mode	MODE5_n-20M-CH06	Test Voltage	AC 120V/60Hz

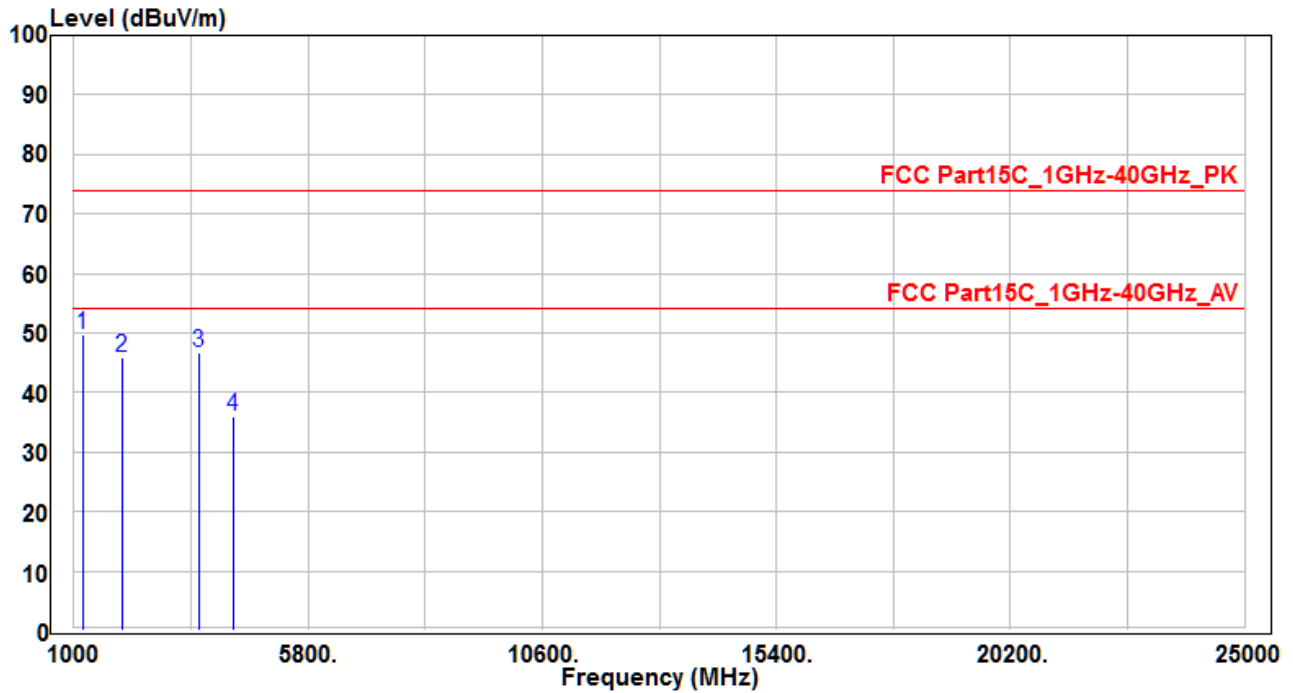

No		Frequency (MHz)	Reading (dBuV)	C.F (dB)	Measurement (dBuV/m)	Margin (dB)	Limit (dBuV)	Height (cm)	Angle (deg)	Remark (QP/PK/AV)
1	*	1187.87	56.17	-6.43	49.74	-24.26	74	100	400	Peak
2		1979.84	49.98	-4.21	45.77	-28.23	74	100	400	Peak
3		3564.54	46.94	-0.19	46.75	-27.25	74	100	400	Peak
4		4259.77	34.62	1.4	36.02	-37.98	74	100	400	Peak

Note :

1. " * " means the worst value in this measurement data ◦
2. Measure Level (dBuV/m) = Reading Level (dBuV) + Factor (dB) ◦
3. Factor (dB) = Cable Loss (dB) + Antenna Factor (dB/m) ◦
4. The emission levels of other frequencies are very lower than the limit and not show in test report ◦

EUT	E-READER	Test Date	2017/06/02
Factor	BBHA 9120D (1GHz~18GHz)	Temp. / Humidity	25°C / 60%
Polarity	Vertical	Site / Engineer	AC1 / Peter
Test Mode	MODE5_n-20M-CH06	Test Voltage	AC 120V/60Hz

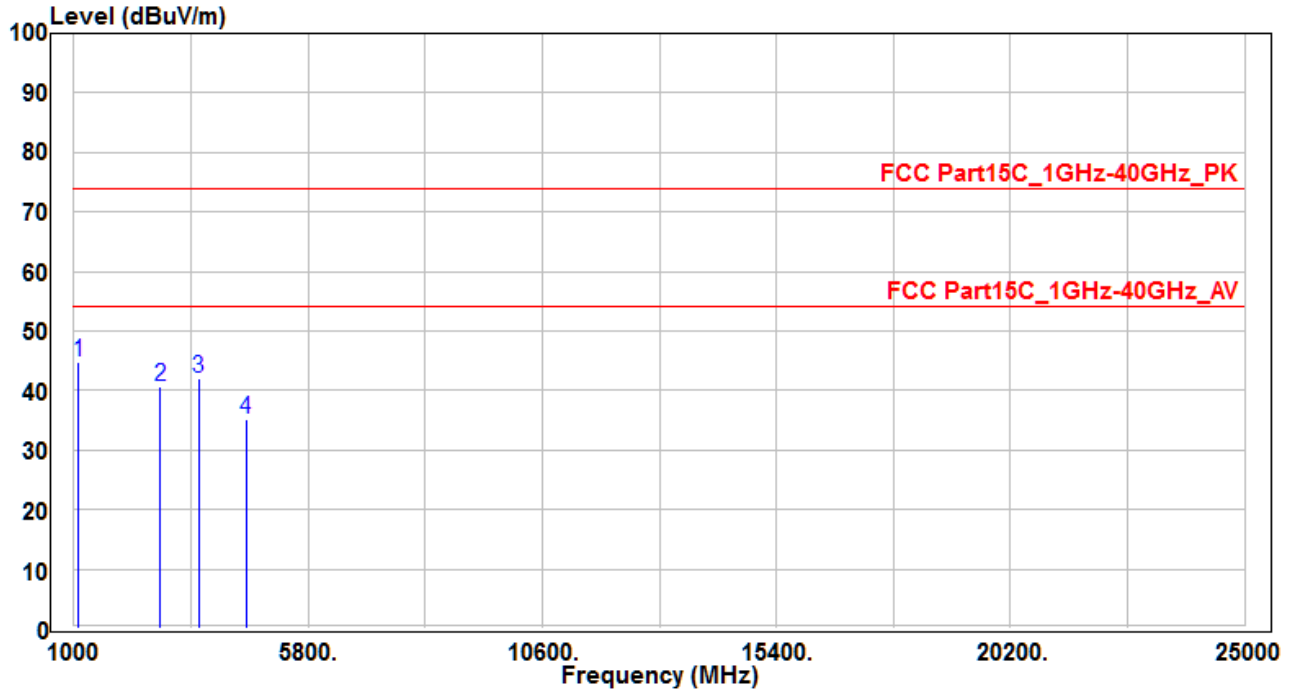

No		Frequency (MHz)	Reading (dBuV)	C.F (dB)	Measurement (dBuV/m)	Margin (dB)	Limit (dBuV)	Height (cm)	Angle (deg)	Remark (QP/PK/AV)
1	*	1088.87	52.14	-7.24	44.9	-29.1	74	100	400	Peak
2		2771.82	43.01	-2.22	40.79	-33.21	74	100	400	Peak
3		3563.79	42.26	-0.19	42.07	-31.93	74	100	400	Peak
4		4537.26	32.44	2.77	35.21	-38.79	74	100	400	Peak

Note :

- "*" means the worst value in this measurement data ◦
- Measure Level (dBuV/m) = Reading Level (dBuV) + Factor (dB) ◦
- Factor (dB) = Cable Loss (dB) + Antenna Factor (dB/m) ◦
- The emission levels of other frequencies are very lower than the limit and not show in test report ◦

7.7. Radiated Restricted Band Edge Measurement

7.7.1. Test Limit

All out of band emissions appearing in a restricted band as specified in Section 15.205 of the Title 47 CFR must not exceed the limits shown in Table per Section 15.209.

FCC Part 15 Subpart C Paragraph 15.209		
Frequency [MHz]	Field Strength [V/m]	Measured Distance [Meters]
0.009 - 0.490	2400/F (kHz)	300
0.490 - 1.705	24000/F (kHz)	30
1.705 – 30	30	30
30 – 88	100	3
88 – 216	150	3
216 – 960	200	3
Above 960	500	3

7.7.2. Test Procedure Used

ANSI C63.10-2013 - Section 11.12.1

7.7.3. Test Setting

Peak Field Strength Measurements

8. Analyzer center frequency was set to the frequency of the radiated spurious emission of interest
9. RBW = as specified in Table 1
10. VBW = 3 * RBW
11. Detector = peak
12. Sweep time = auto couple
13. Trace mode = max hold

14. Trace was allowed to stabilize

Table 1 - RBW as a function of frequency

Frequency	RBW
9 ~ 150 kHz	200 ~ 300 Hz
0.15 ~ 30 MHz	9 ~ 10 kHz
30 ~ 1000 MHz	100 ~ 120 kHz
> 1000 MHz	1 MHz

Average Field Strength Measurements

9. Analyzer center frequency was set to the frequency of the radiated spurious emission of interest
10. RBW = 1MHz
11. VBW $\geq 1/T$
12. De As an alternative, the instrument may be set to linear detector mode. Ensure that video filtering is applied in linear voltage domain (rather than in a log or dB domain). Some instruments require linear display mode in order to accomplish this. Others have a setting for Average-VBW Type, which can be set to "Voltage" regardless of the display mode
13. Detector = Peak
14. Sweep time = auto
15. Trace mode = max hold
16. Allow max hold to run for at least 50 times (1/duty cycle) traces

7.7.4. Test Setup

1GHz ~ 18GHz Test Setup:

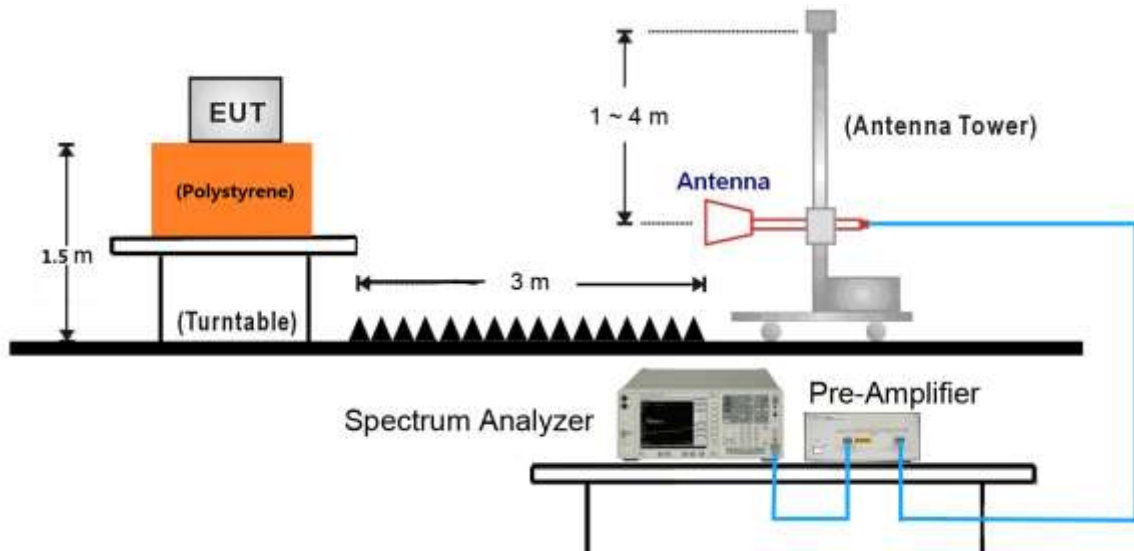

18GHz ~40GHz Test Setup:

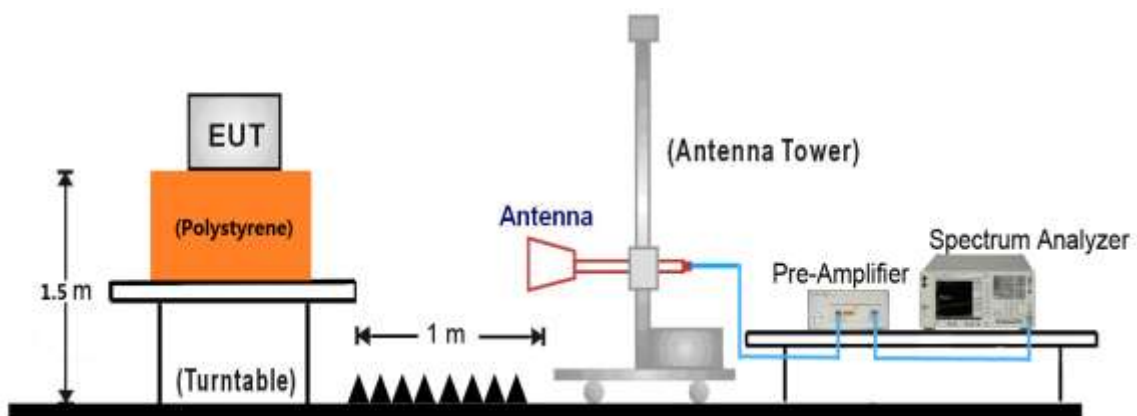

7.7.5. Test Result

EUT	E-READER	Test Date	2017/06/01
Factor	BBHA 9120D (1GHz~18GHz)	Temp. / Humidity	21°C / 57%
Polarity	Horizontal	Site / Engineer	AC1 / Peter
Test Mode	MODE1_b-CH01	Test Voltage	AC 120V/60Hz

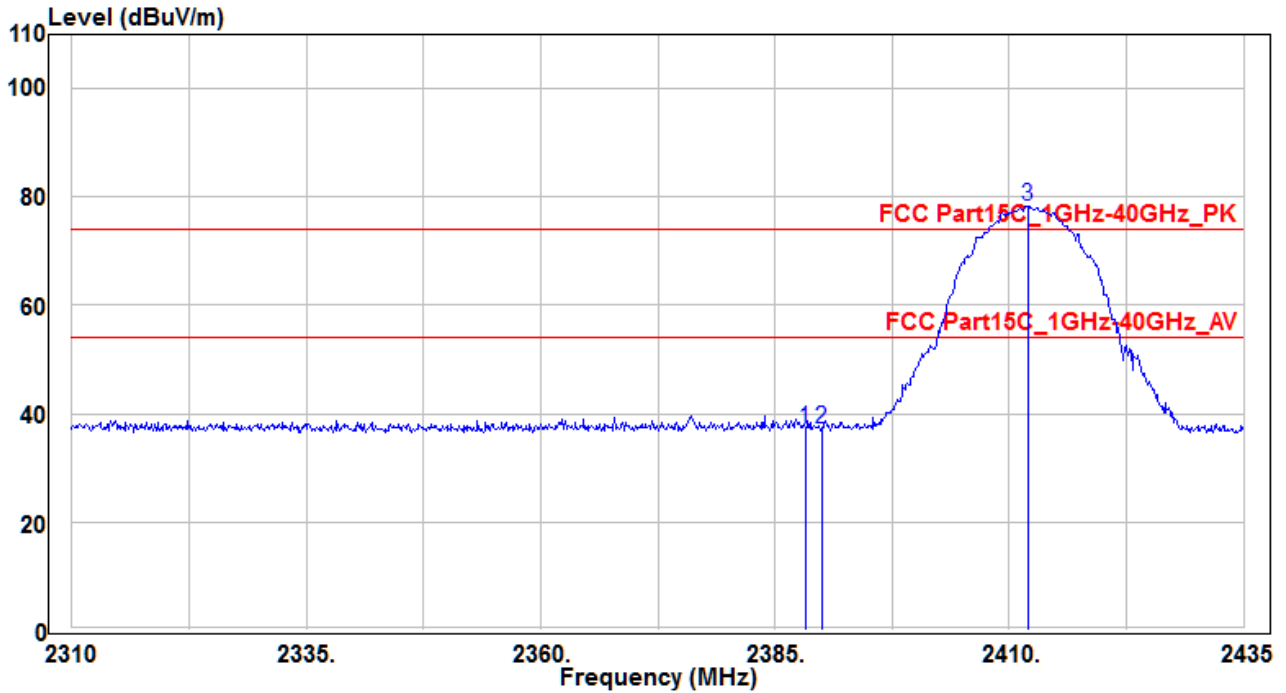

No	Frequency (MHz)	Reading (dBuV)	C.F (dB)	Measurement (dBuV/m)	Margin (dB)	Limit (dBuV)	Height (cm)	Angle (deg)	Remark (QP/PK/AV)	
1	*	2388.25	39.09	-1.83	37.26	-36.74	74	170	190	Peak
2		2390	39.05	-1.84	37.21	-36.79	74	170	190	Peak
3		2412	80.18	-1.92	78.26	4.26	74	170	190	Peak

Note :

1. " * " means the worst value in this measurement data ◦
2. C.F (Correction Factor) = Antenna Factor (dB)+ Cable Loss (dB) – Preamplifier(dB) ◦
3. Measurement (dBuV/m) = Reading(dBuV) + C.F (Correction Factor) ◦

EUT	E-READER	Test Date	2017/06/01
Factor	BBHA 9120D (1GHz~18GHz)	Temp. / Humidity	21°C / 57%
Polarity	Vertical	Site / Engineer	AC1 / Peter
Test Mode	MODE1_b-CH01	Test Voltage	AC 120V/60Hz

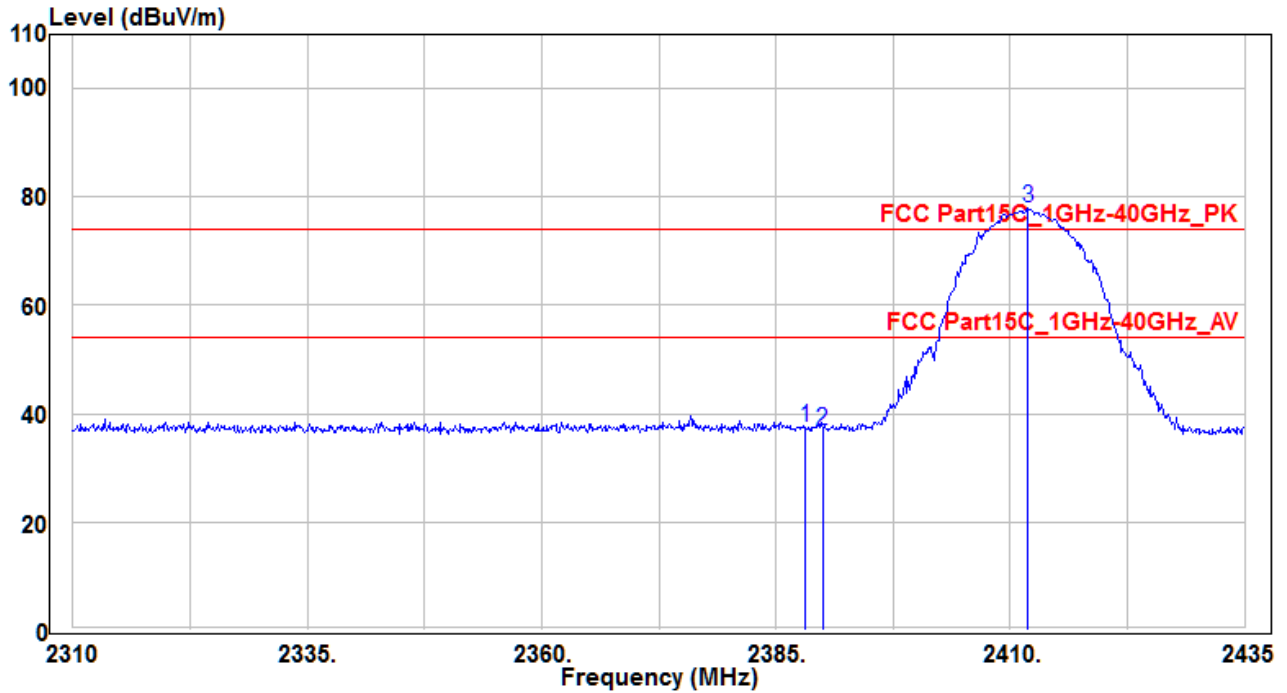

No	Frequency (MHz)	Reading (dBuV)	C.F (dB)	Measurement (dBuV/m)	Margin (dB)	Limit (dBuV)	Height (cm)	Angle (deg)	Remark (QP/PK/AV)	
1	*	2388.125	39.46	-1.83	37.63	-36.37	74	155	330	Peak
2		2390	38.62	-1.84	36.78	-37.22	74	155	330	Peak
3		2411.875	79.76	-1.92	77.84	3.84	74	155	330	Peak

Note :

1. " * " means the worst value in this measurement data °
2. C.F (Correction Factor) = Antenna Factor (dB)+ Cable Loss (dB) – Preamplifier(dB) °
3. Measurement (dBuV/m) = Reading(dBuV) + C.F (Correction Factor) °

EUT	E-READER	Test Date	2017/06/01
Factor	BBHA 9120D (1GHz~18GHz)	Temp. / Humidity	21°C / 57%
Polarity	Horizontal	Site / Engineer	AC1 / Peter
Test Mode	MODE1_b-CH11	Test Voltage	AC 120V/60Hz

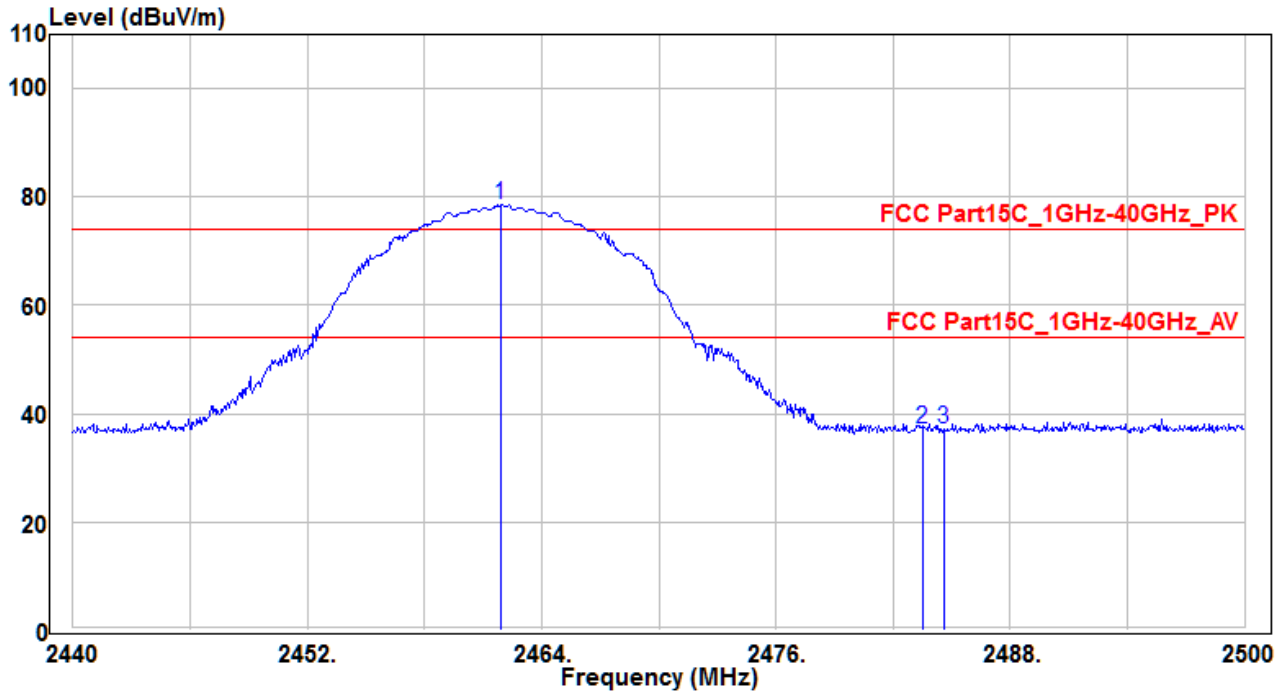

No	Frequency (MHz)	Reading (dBuV)	C.F (dB)	Measurement (dBuV/m)	Margin (dB)	Limit (dBuV)	Height (cm)	Angle (deg)	Remark (QP/PK/AV)
1	2461.9	80.72	-2.08	78.64	4.64	74	190	185	Peak
2	2483.5	39.24	-2.08	37.16	-36.84	74	190	185	Peak
3	* 2484.58	39.25	-2.08	37.17	-36.83	74	190	185	Peak

Note :

- "*" means the worst value in this measurement data °
- C.F (Correction Factor) = Antenna Factor (dB)+ Cable Loss (dB) – Preamplifier(dB) °
- Measurement (dBuV/m) = Reading(dBuV) + C.F (Correction Factor) °

EUT	E-READER	Test Date	2017/06/01
Factor	BBHA 9120D (1GHz~18GHz)	Temp. / Humidity	21°C / 57%
Polarity	Vertical	Site / Engineer	AC1 / Peter
Test Mode	MODE1_b-CH11	Test Voltage	AC 120V/60Hz

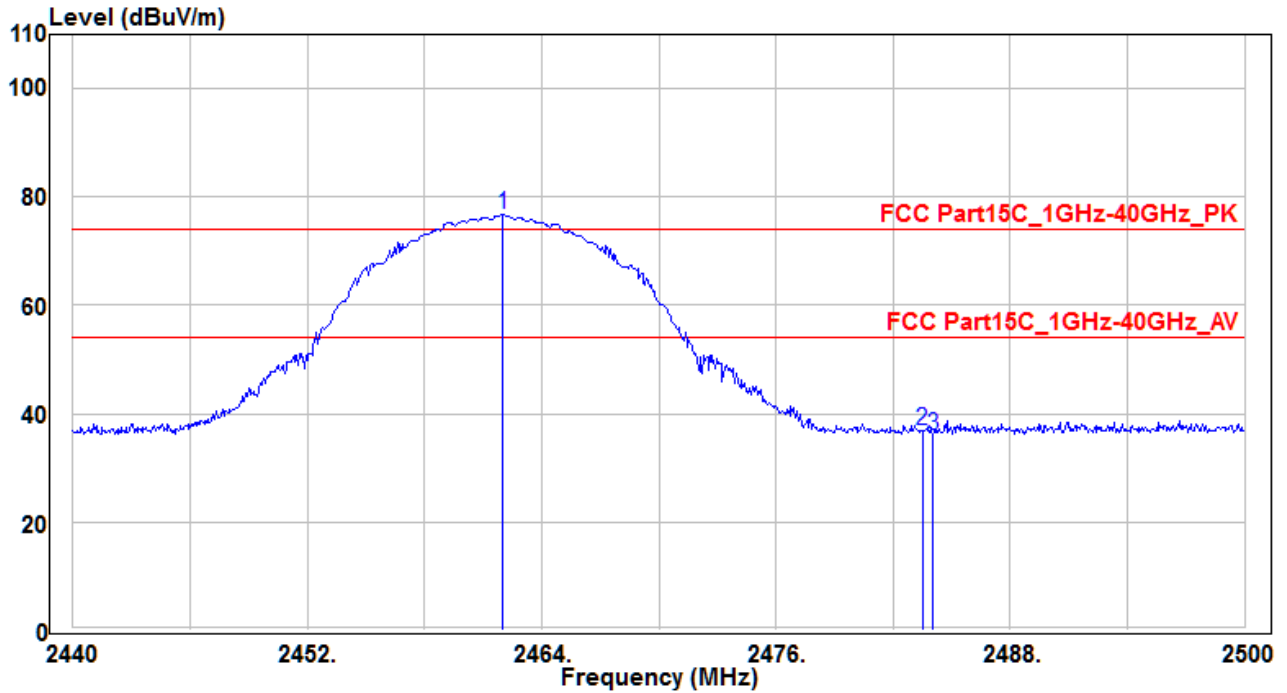

No	Frequency (MHz)	Reading (dBuV)	C.F (dB)	Measurement (dBuV/m)	Margin (dB)	Limit (dBuV)	Height (cm)	Angle (deg)	Remark (QP/PK/AV)
1	2462.02	78.82	-2.08	76.74	2.74	74	150	300	Peak
2	* 2483.5	38.81	-2.08	36.73	-37.27	74	150	300	Peak
3	2484.04	38.14	-2.08	36.06	-37.94	74	150	300	Peak

Note :

- "*" means the worst value in this measurement data °
- C.F (Correction Factor) = Antenna Factor (dB)+ Cable Loss (dB) – Preamplifier(dB) °
- Measurement (dBuV/m) = Reading(dBuV) + C.F (Correction Factor) °

EUT	E-READER	Test Date	2017/06/01
Factor	BBHA 9120D (1GHz~18GHz)	Temp. / Humidity	21°C / 57%
Polarity	Horizontal	Site / Engineer	AC1 / Peter
Test Mode	MODE2_g-CH01	Test Voltage	AC 120V/60Hz

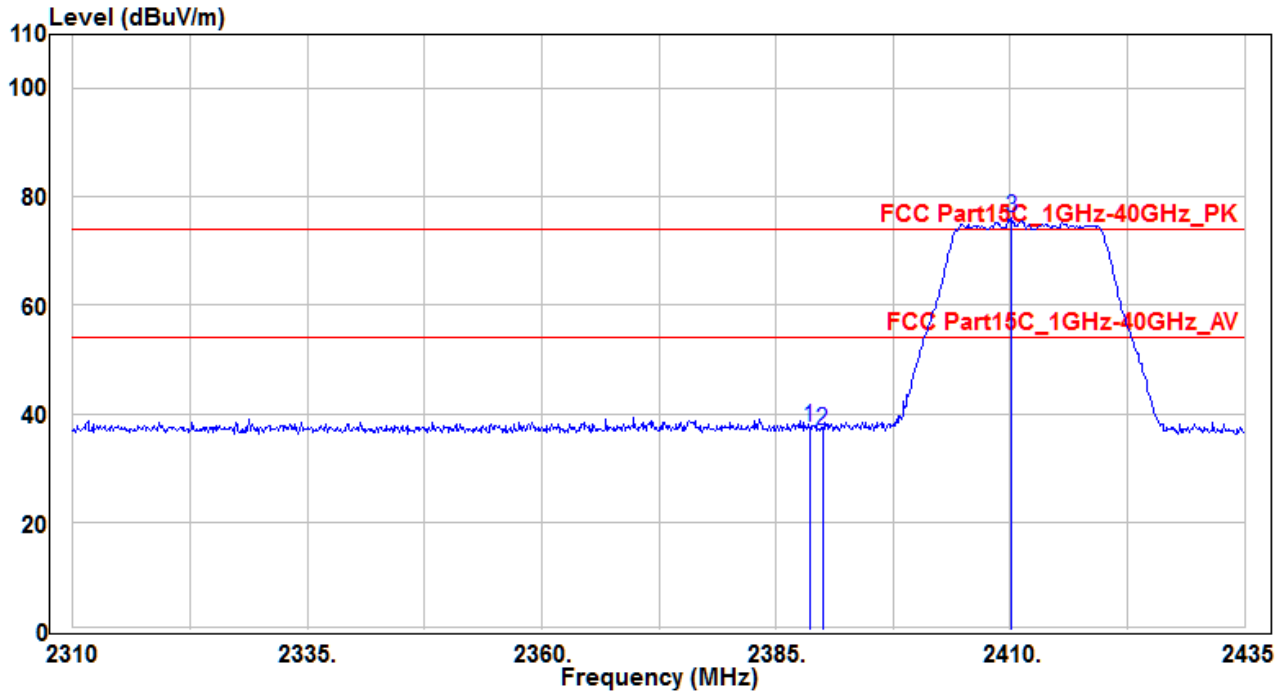

No	Frequency (MHz)	Reading (dBuV)	C.F (dB)	Measurement (dBuV/m)	Margin (dB)	Limit (dBuV)	Height (cm)	Angle (deg)	Remark (QP/PK/AV)	
1	*	2388.625	39.32	-1.83	37.49	-36.51	74	170	190	Peak
2		2390	38.85	-1.84	37.01	-36.99	74	170	190	Peak
3		2410.125	78.1	-1.91	76.19	2.19	74	170	190	Peak

Note :

1. " * " means the worst value in this measurement data ◦
2. C.F (Correction Factor) = Antenna Factor (dB)+ Cable Loss (dB) – Preamplifier(dB) ◦
3. Measurement (dBuV/m) = Reading(dBuV) + C.F (Correction Factor) ◦

EUT	E-READER	Test Date	2017/06/01
Factor	BBHA 9120D (1GHz~18GHz)	Temp. / Humidity	21°C / 57%
Polarity	Vertical	Site / Engineer	AC1 / Peter
Test Mode	MODE2_g-CH01	Test Voltage	AC 120V/60Hz

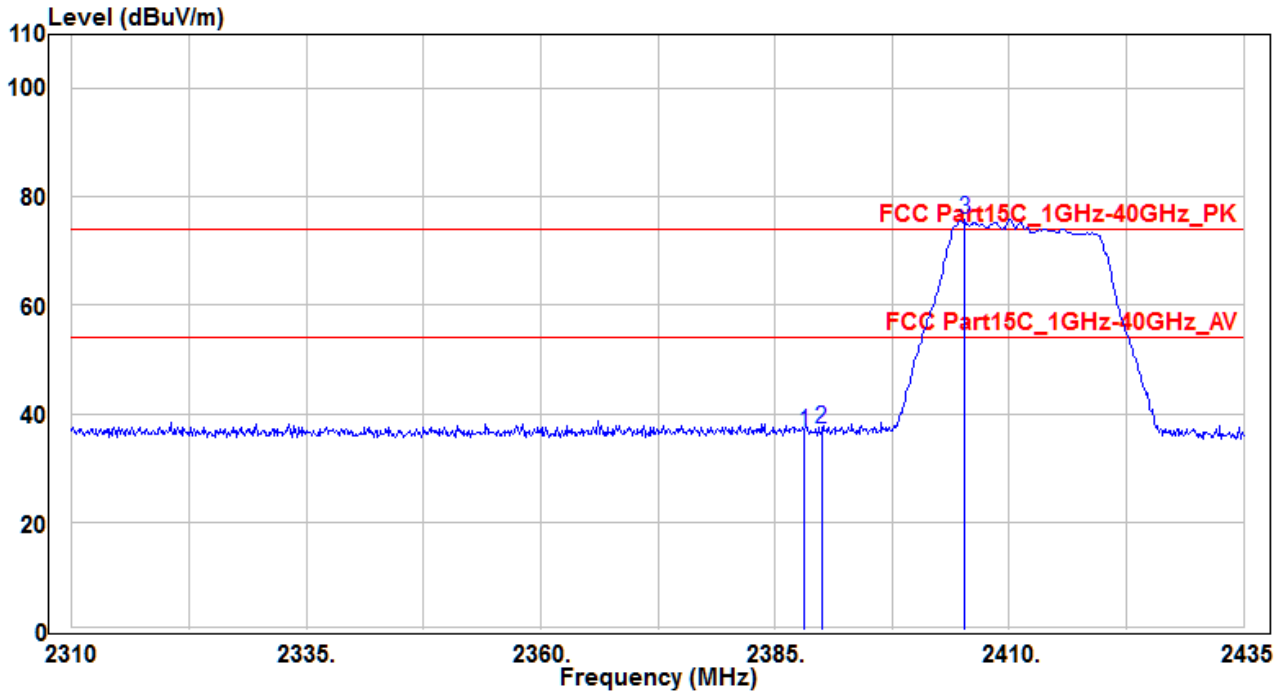

No	Frequency (MHz)	Reading (dBuV)	C.F (dB)	Measurement (dBuV/m)	Margin (dB)	Limit (dBuV)	Height (cm)	Angle (deg)	Remark (QP/PK/AV)
1	2388.125	38.3	-1.83	36.47	-37.53	74	150	330	Peak
2	* 2390	39.14	-1.84	37.3	-36.7	74	150	330	Peak
3	2405.25	77.76	-1.88	75.88	1.88	74	150	330	Peak

Note :

1. " * " means the worst value in this measurement data °
2. C.F (Correction Factor) = Antenna Factor (dB)+ Cable Loss (dB) – Preamplifier(dB) °
3. Measurement (dBuV/m) = Reading(dBuV) + C.F (Correction Factor) °

EUT	E-READER	Test Date	2017/06/01
Factor	BBHA 9120D (1GHz~18GHz)	Temp. / Humidity	21°C / 57%
Polarity	Horizontal	Site / Engineer	AC1 / Peter
Test Mode	MODE2_g-CH11	Test Voltage	AC 120V/60Hz

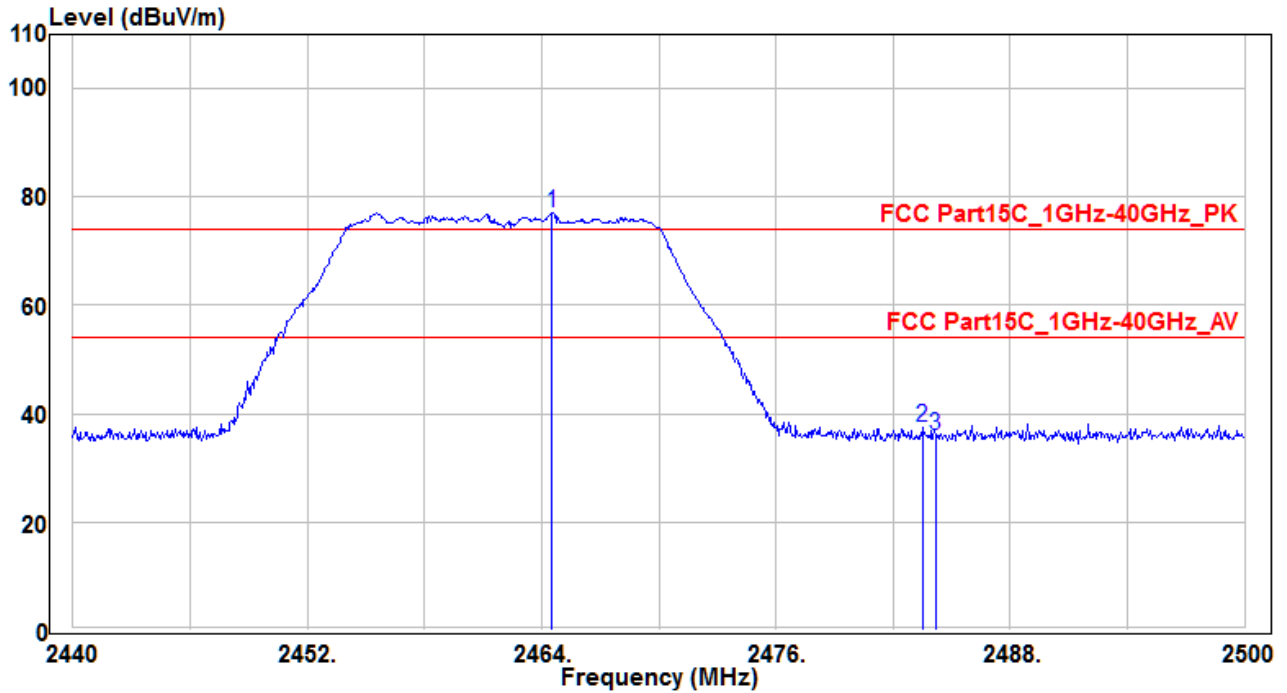

No	Frequency (MHz)	Reading (dBuV)	C.F (dB)	Measurement (dBuV/m)	Margin (dB)	Limit (dBuV)	Height (cm)	Angle (deg)	Remark (QP/PK/AV)
1	2464.54	79.01	-2.07	76.94	2.94	74	180	200	Peak
2	* 2483.5	39.59	-2.08	37.51	-36.49	74	180	200	Peak
3	2484.16	38.03	-2.08	35.95	-38.05	74	180	200	Peak

Note :

1. " * " means the worst value in this measurement data ◦
2. C.F (Correction Factor) = Antenna Factor (dB)+ Cable Loss (dB) – Preamplifier(dB) ◦
3. Measurement (dBuV/m) = Reading(dBuV) + C.F (Correction Factor) ◦

EUT	E-READER	Test Date	2017/06/01
Factor	BBHA 9120D (1GHz~18GHz)	Temp. / Humidity	21°C / 57%
Polarity	Vertical	Site / Engineer	AC1 / Peter
Test Mode	MODE2_g-CH11	Test Voltage	AC 120V/60Hz

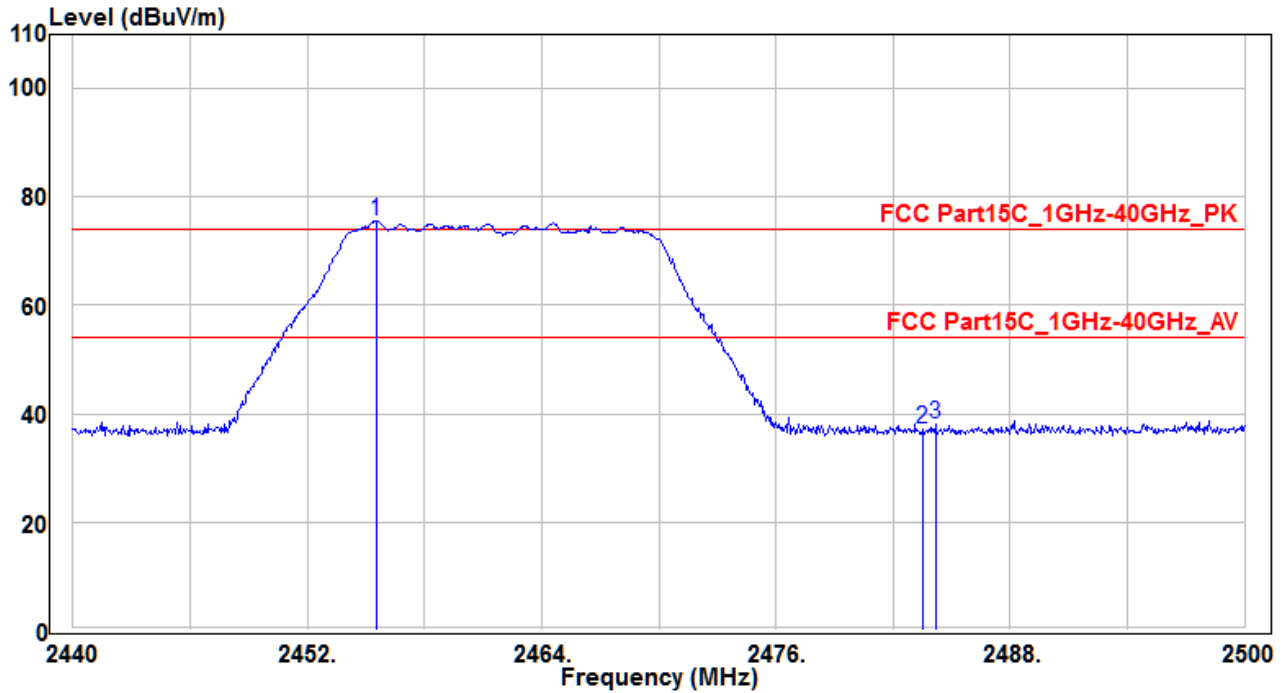

No	Frequency (MHz)	Reading (dBuV)	C.F (dB)	Measurement (dBuV/m)	Margin (dB)	Limit (dBuV)	Height (cm)	Angle (deg)	Remark (QP/PK/AV)
1	2455.54	77.73	-2.07	75.66	1.66	74	150	320	Peak
2	2483.5	39.29	-2.08	37.21	-36.79	74	150	320	Peak
3	* 2484.16	40.31	-2.08	38.23	-35.77	74	150	320	Peak

Note :

1. " * " means the worst value in this measurement data ◦
2. C.F (Correction Factor) = Antenna Factor (dB)+ Cable Loss (dB) – Preamplifier(dB) ◦
3. Measurement (dBuV/m) = Reading(dBuV) + C.F (Correction Factor) ◦

EUT	E-READER	Test Date	2017/06/01
Factor	BBHA 9120D (1GHz~18GHz)	Temp. / Humidity	21°C / 57%
Polarity	Horizontal	Site / Engineer	AC1 / Peter
Test Mode	MODE3_n-20M-CH01	Test Voltage	AC 120V/60Hz

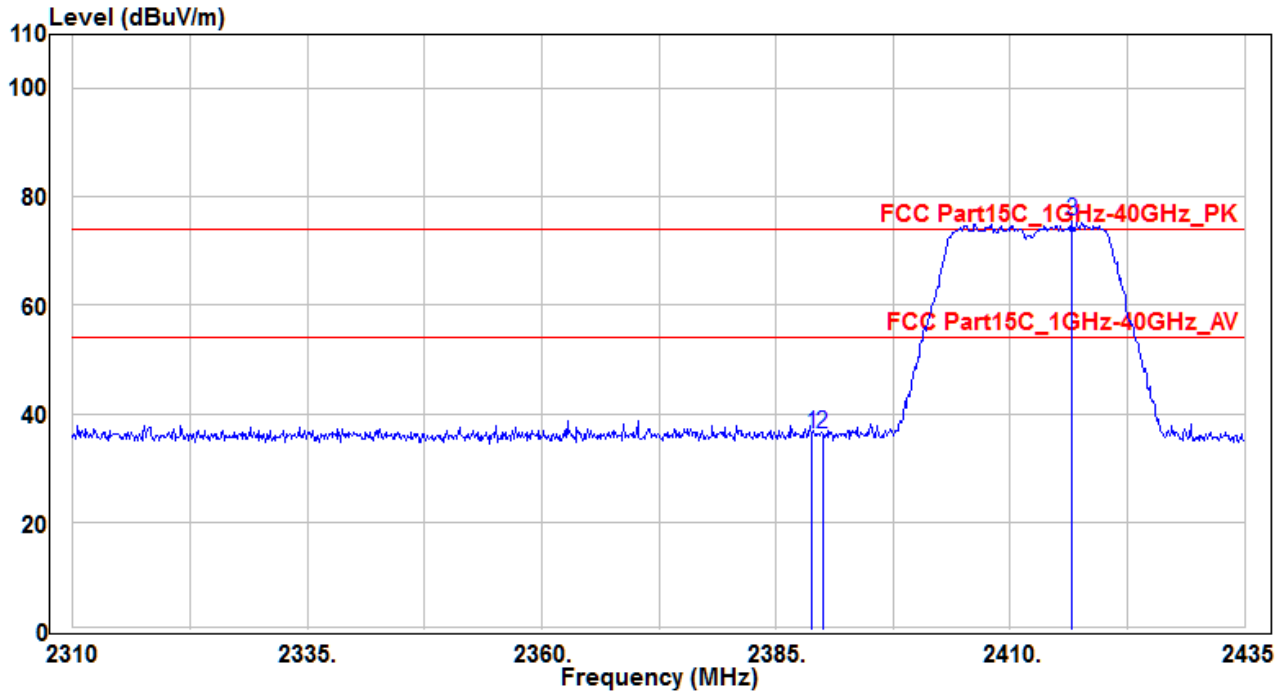

No	Frequency (MHz)	Reading (dBuV)	C.F (dB)	Measurement (dBuV/m)	Margin (dB)	Limit (dBuV)	Height (cm)	Angle (deg)	Remark (QP/PK/AV)
1	2388.875	38.02	-1.83	36.19	-37.81	74	160	280	Peak
2	* 2390	38.13	-1.84	36.29	-37.71	74	160	280	Peak
3	2416.625	77.61	-1.94	75.67	1.67	74	160	280	Peak

Note :

- " * " means the worst value in this measurement data ◦
- C.F (Correction Factor) = Antenna Factor (dB)+ Cable Loss (dB) – Preamplifier(dB) ◦
- Measurement (dBuV/m) = Reading(dBuV) + C.F (Correction Factor) ◦

EUT	E-READER	Test Date	2017/06/01
Factor	BBHA 9120D (1GHz~18GHz)	Temp. / Humidity	21°C / 57%
Polarity	Vertical	Site / Engineer	AC1 / Peter
Test Mode	MODE3_n-20M-CH01	Test Voltage	AC 120V/60Hz

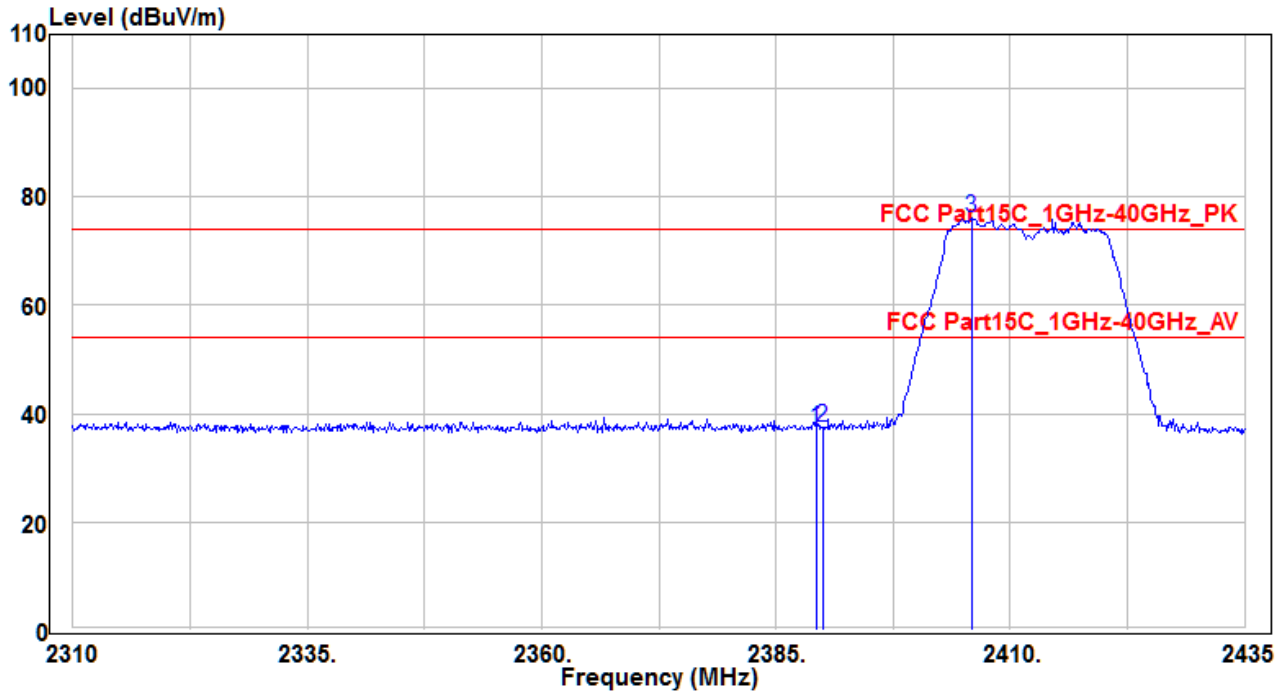

No	Frequency (MHz)	Reading (dBuV)	C.F (dB)	Measurement (dBuV/m)	Margin (dB)	Limit (dBuV)	Height (cm)	Angle (deg)	Remark (QP/PK/AV)
1	2389.25	39.14	-1.83	37.31	-36.69	74	150	330	Peak
2	* 2390	39.27	-1.84	37.43	-36.57	74	150	330	Peak
3	2405.875	77.93	-1.89	76.04	2.04	74	150	330	Peak

Note :

- "*" means the worst value in this measurement data °
- C.F (Correction Factor) = Antenna Factor (dB)+ Cable Loss (dB) – Preamplifier(dB) °
- Measurement (dBuV/m) = Reading(dBuV) + C.F (Correction Factor) °

EUT	E-READER	Test Date	2017/06/01
Factor	BBHA 9120D (1GHz~18GHz)	Temp. / Humidity	21°C / 57%
Polarity	Horizontal	Site / Engineer	AC1 / Peter
Test Mode	MODE3_n-20M-CH11	Test Voltage	AC 120V/60Hz

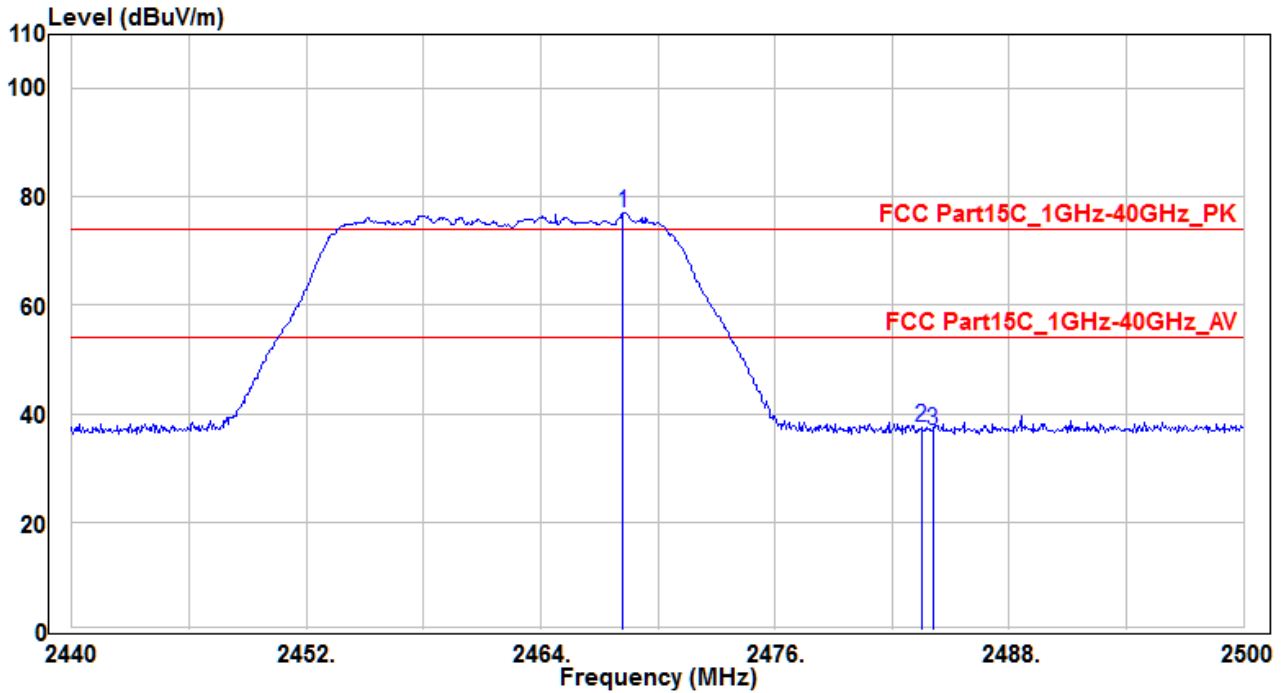

No	Frequency (MHz)	Reading (dBuV)	C.F (dB)	Measurement (dBuV/m)	Margin (dB)	Limit (dBuV)	Height (cm)	Angle (deg)	Remark (QP/PK/AV)
1	2468.2	79.16	-2.08	77.08	3.08	74	150	300	Peak
2	* 2483.5	39.45	-2.08	37.37	-36.63	74	150	300	Peak
3	2484.1	38.88	-2.08	36.8	-37.2	74	150	300	Peak

Note :

- "*" means the worst value in this measurement data °
- C.F (Correction Factor) = Antenna Factor (dB)+ Cable Loss (dB) – Preamplifier(dB) °
- Measurement (dBuV/m) = Reading(dBuV) + C.F (Correction Factor) °

EUT	E-READER	Test Date	2017/06/01
Factor	BBHA 9120D (1GHz~18GHz)	Temp. / Humidity	21°C / 57%
Polarity	Vertical	Site / Engineer	AC1 / Peter
Test Mode	MODE3_n-20M-CH11	Test Voltage	AC 120V/60Hz

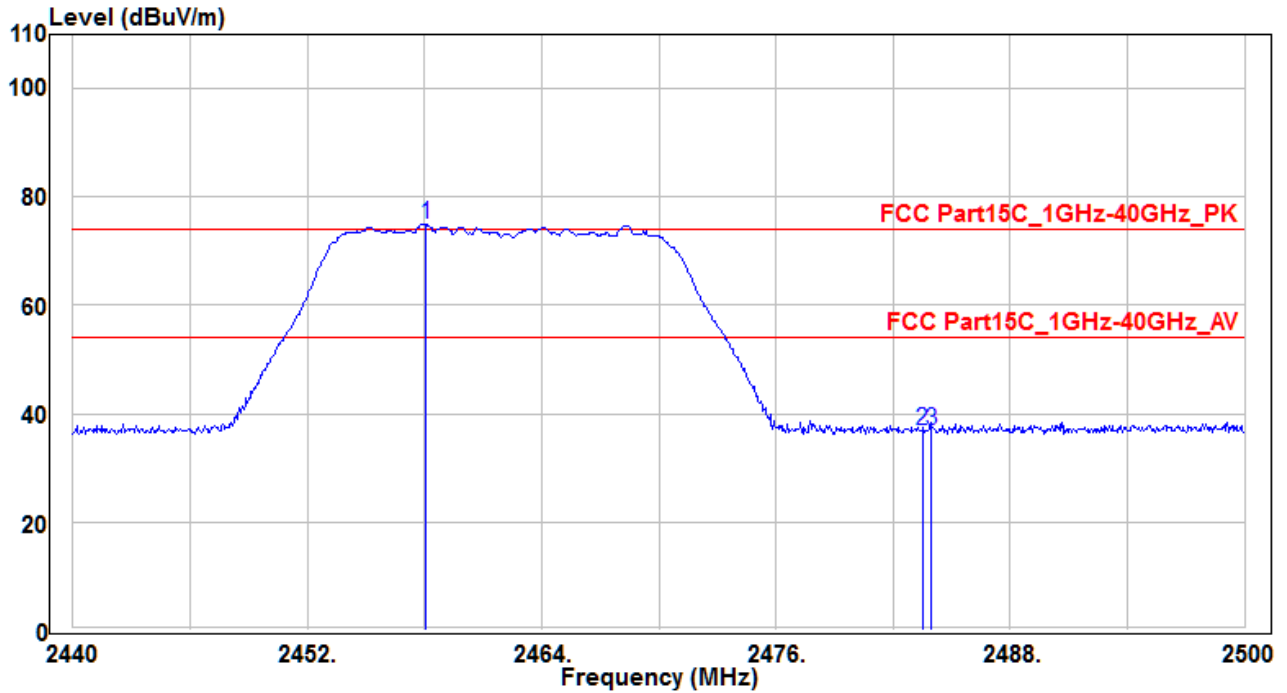

No	Frequency (MHz)	Reading (dBuV)	C.F (dB)	Measurement (dBuV/m)	Margin (dB)	Limit (dBuV)	Height (cm)	Angle (deg)	Remark (QP/PK/AV)
1	2458.06	77.08	-2.08	75	1	74	180	340	Peak
2	2483.5	38.88	-2.08	36.8	-37.2	74	180	340	Peak
3	* 2483.98	39.11	-2.08	37.03	-36.97	74	180	340	Peak

Note :

1. " * " means the worst value in this measurement data °
2. C.F (Correction Factor) = Antenna Factor (dB)+ Cable Loss (dB) – Preamplifier(dB) °
3. Measurement (dBuV/m) = Reading(dBuV) + C.F (Correction Factor) °

EUT	E-READER	Test Date	2017/06/01
Factor	BBHA 9120D (1GHz~18GHz)	Temp. / Humidity	21°C / 57%
Polarity	Horizontal	Site / Engineer	AC1 / Peter
Test Mode	MODE4_n-40M-CH03	Test Voltage	AC 120V/60Hz

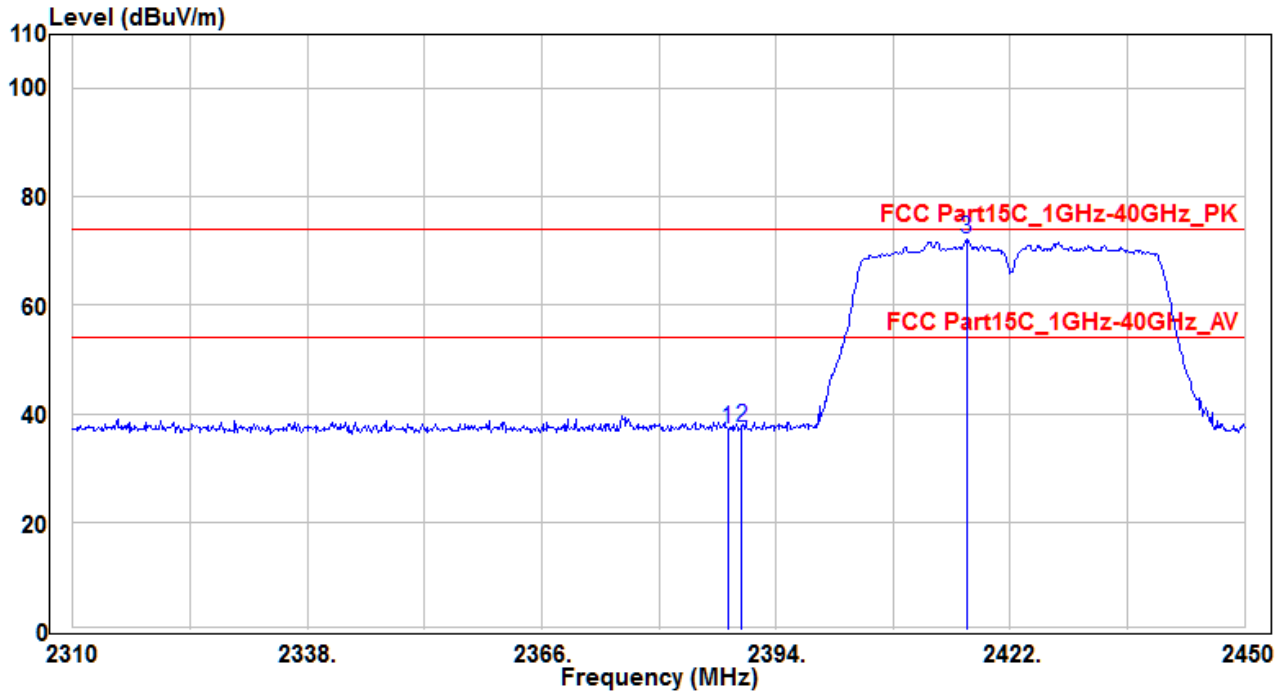

No	Frequency (MHz)	Reading (dBuV)	C.F (dB)	Measurement (dBuV/m)	Margin (dB)	Limit (dBuV)	Height (cm)	Angle (deg)	Remark (QP/PK/AV)
1	2388.26	39.06	-1.83	37.23	-36.77	74	185	185	Peak
2	* 2389.94	39.43	-1.84	37.59	-36.41	74	185	185	Peak
3	2416.82	74.04	-1.94	72.1	-1.9	74	185	185	Peak

Note :

1. " * " means the worst value in this measurement data ◦
2. C.F (Correction Factor) = Antenna Factor (dB)+ Cable Loss (dB) – Preamplifier(dB) ◦
3. Measurement (dBuV/m) = Reading(dBuV) + C.F (Correction Factor) ◦

EUT	E-READER	Test Date	2017/06/01
Factor	BBHA 9120D (1GHz~18GHz)	Temp. / Humidity	21°C / 57%
Polarity	Vertical	Site / Engineer	AC1 / Peter
Test Mode	MODE4_n-40M-CH03	Test Voltage	AC 120V/60Hz

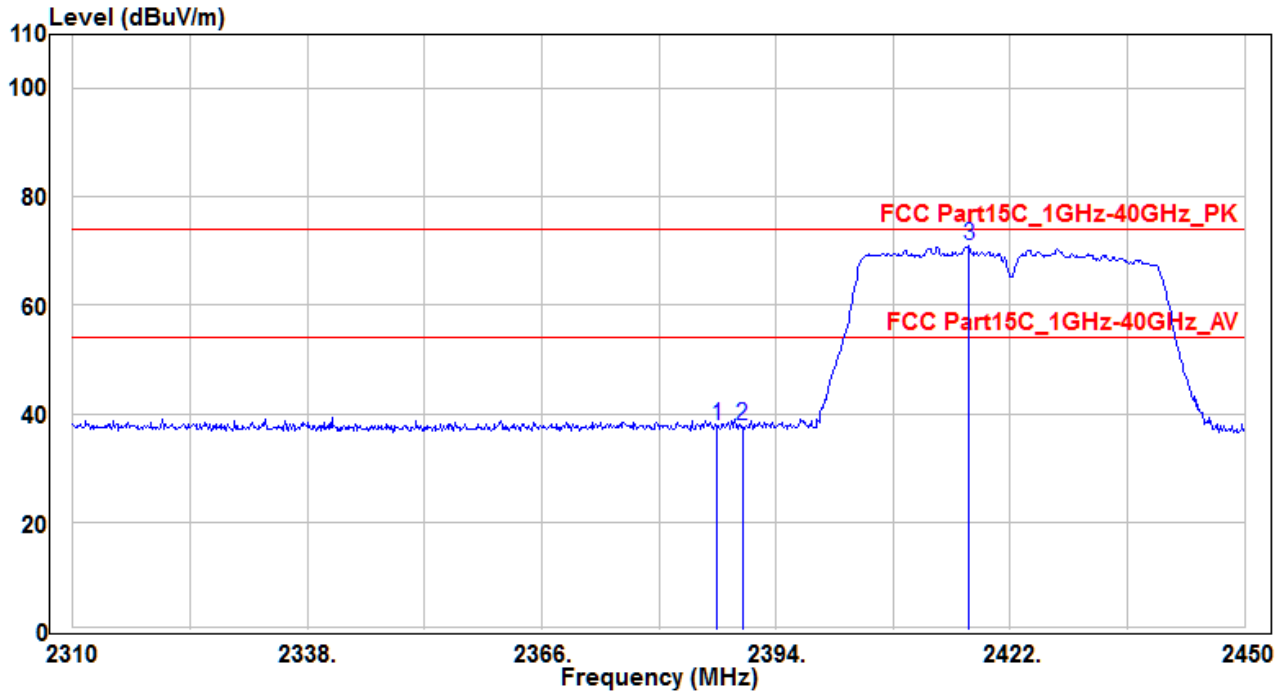

No	Frequency (MHz)	Reading (dBuV)	C.F (dB)	Measurement (dBuV/m)	Margin (dB)	Limit (dBuV)	Height (cm)	Angle (deg)	Remark (QP/PK/AV)	
1	*	2387	39.64	-1.84	37.8	-36.2	74	150	280	Peak
2		2390	39.48	-1.84	37.64	-36.36	74	150	280	Peak
3		2417.1	72.82	-1.94	70.88	-3.12	74	150	280	Peak

Note :

1. " * " means the worst value in this measurement data ◦
2. C.F (Correction Factor) = Antenna Factor (dB)+ Cable Loss (dB) – Preamplifier(dB) ◦
3. Measurement (dBuV/m) = Reading(dBuV) + C.F (Correction Factor) ◦

EUT	E-READER	Test Date	2017/06/01
Factor	BBHA 9120D (1GHz~18GHz)	Temp. / Humidity	21°C / 57%
Polarity	Horizontal	Site / Engineer	AC1 / Peter
Test Mode	MODE4_n-40M-CH09	Test Voltage	AC 120V/60Hz

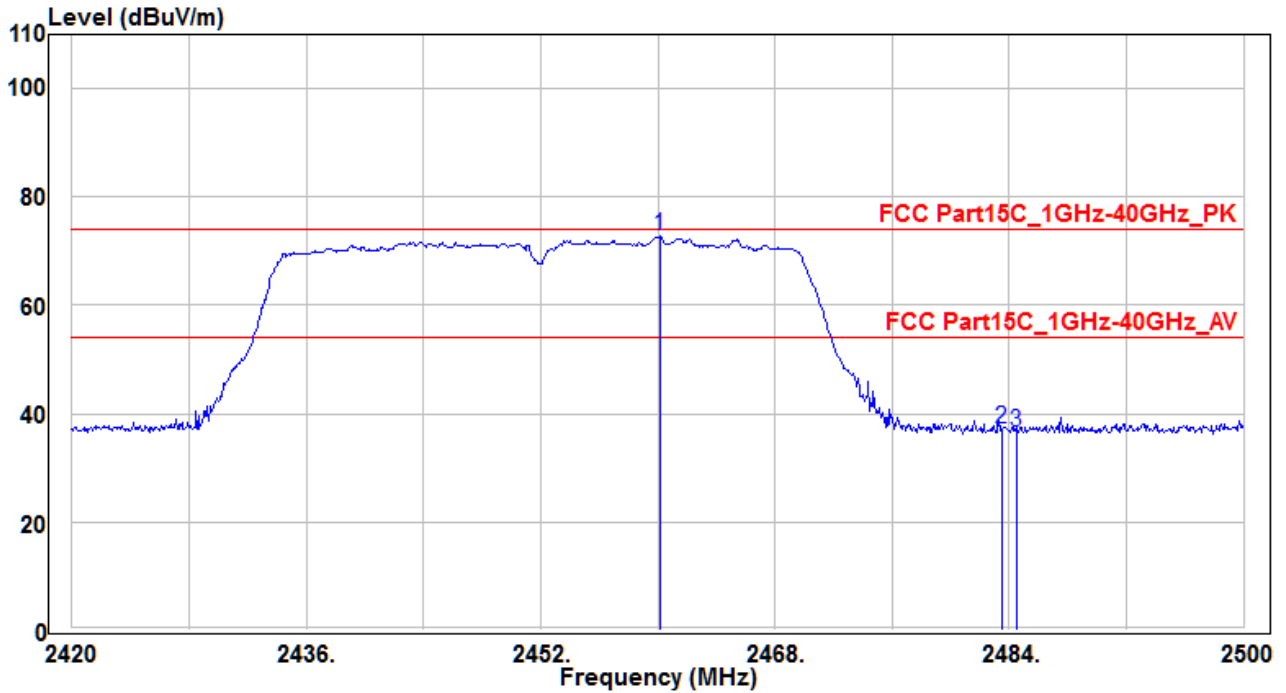

No	Frequency (MHz)	Reading (dBuV)	C.F (dB)	Measurement (dBuV/m)	Margin (dB)	Limit (dBuV)	Height (cm)	Angle (deg)	Remark (QP/PK/AV)
1	2460.16	74.77	-2.07	72.7	-1.3	74	165	185	Peak
2	* 2483.5	39.22	-2.08	37.14	-36.86	74	165	185	Peak
3	2484.48	38.79	-2.08	36.71	-37.29	74	165	185	Peak

Note :

1. " * " means the worst value in this measurement data ◦
2. C.F (Correction Factor) = Antenna Factor (dB)+ Cable Loss (dB) – Preamplifier(dB) ◦
3. Measurement (dBuV/m) = Reading(dBuV) + C.F (Correction Factor) ◦

EUT	E-READER	Test Date	2017/06/01
Factor	BBHA 9120D (1GHz~18GHz)	Temp. / Humidity	21°C / 57%
Polarity	Vertical	Site / Engineer	AC1 / Peter
Test Mode	MODE4_n-40M-CH09	Test Voltage	AC 120V/60Hz

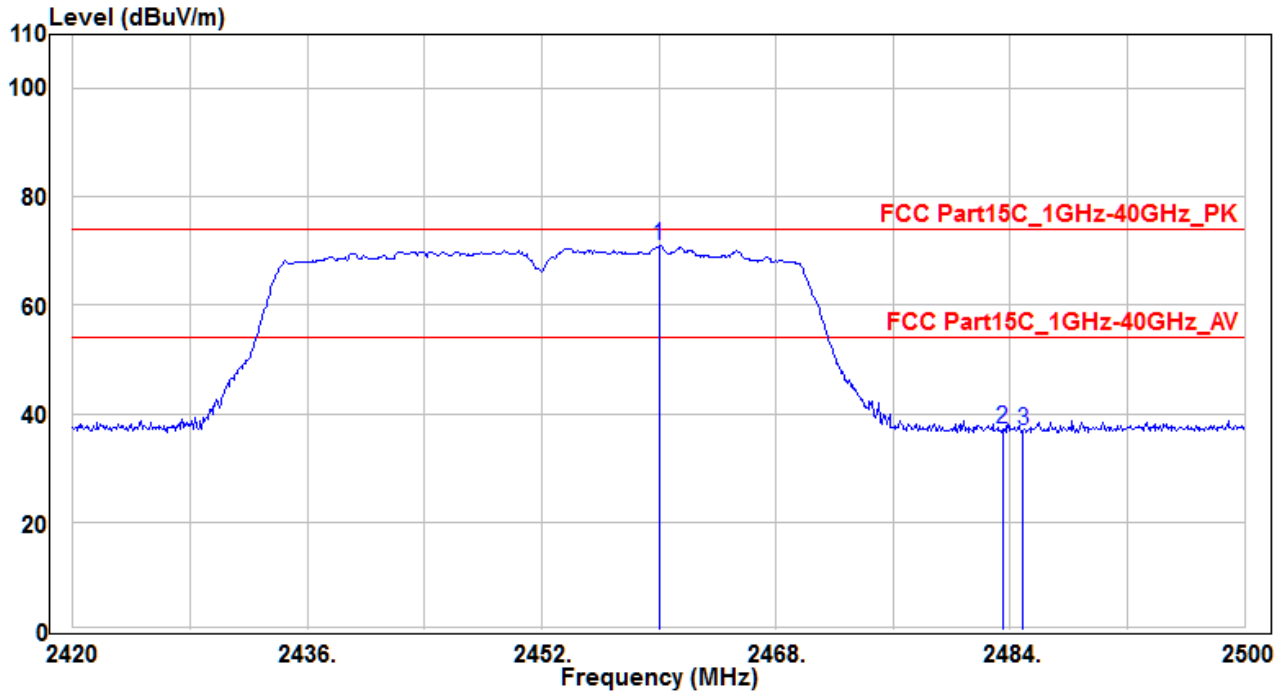

No	Frequency (MHz)	Reading (dBuV)	C.F (dB)	Measurement (dBuV/m)	Margin (dB)	Limit (dBuV)	Height (cm)	Angle (deg)	Remark (QP/PK/AV)
1	2460	73.04	-2.07	70.97	-3.03	74	175	300	Peak
2	* 2483.5	39.21	-2.08	37.13	-36.87	74	175	300	Peak
3	2484.88	39.07	-2.08	36.99	-37.01	74	175	300	Peak

Note :

1. " * " means the worst value in this measurement data ◦
2. C.F (Correction Factor) = Antenna Factor (dB)+ Cable Loss (dB) – Preamplifier(dB) ◦
3. Measurement (dBuV/m) = Reading(dBuV) + C.F (Correction Factor) ◦

7.8. AC Conducted Emissions Measurement

7.8.1. Test Limit

FCC Part 15 Subpart C Paragraph 15.207 / RSS-Gen Limits		
Frequency (MHz)	QP (dB μ V)	Average (dB μ V)
0.15 - 0.50	66 - 56	56 - 46
0.50 - 5.0	56	46
5.0 - 30	60	50

Note 1: The lower limit shall apply at the transition frequencies.

Note 2: The limit decreases linearly with the logarithm of the frequency in the range 0.15MHz to 0.5MHz.

7.8.2. Test Setup

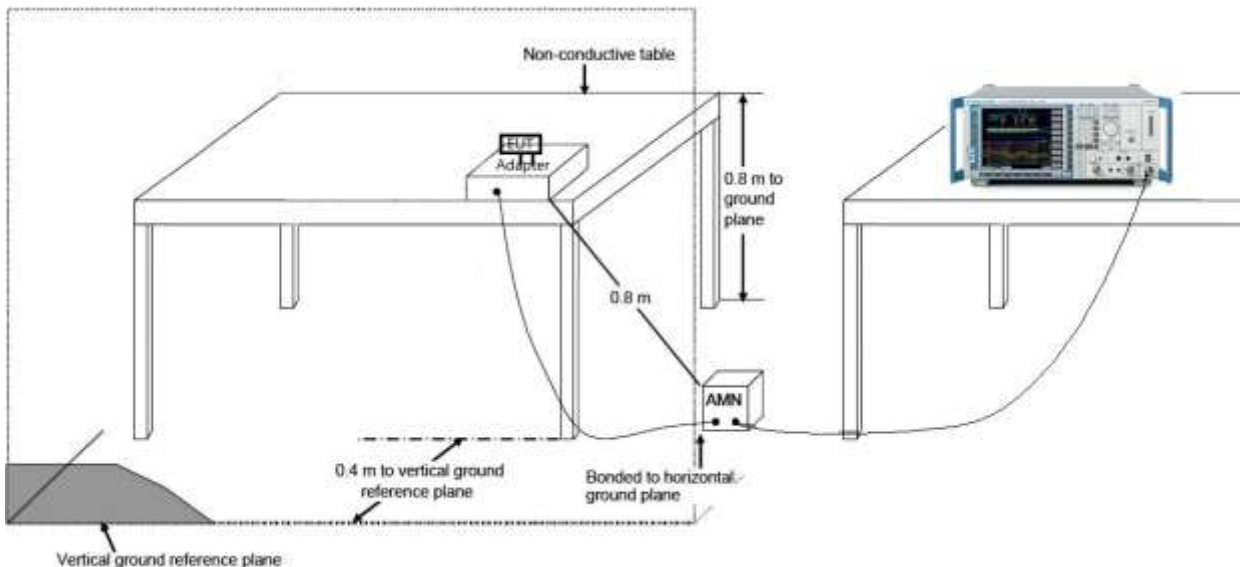

7.8.3. Test Result

EUT	E-READER	Test Date	2017/06/03
Factor	CE_ENV216-L1 (Filter ON)	Temp. / Humidity	24°C / 55%
Polarity	Line1	Site / Engineer	SR2 / Peter
Test Mode	MODE3_n-20M-CH06	Test Voltage	AC120V/60Hz

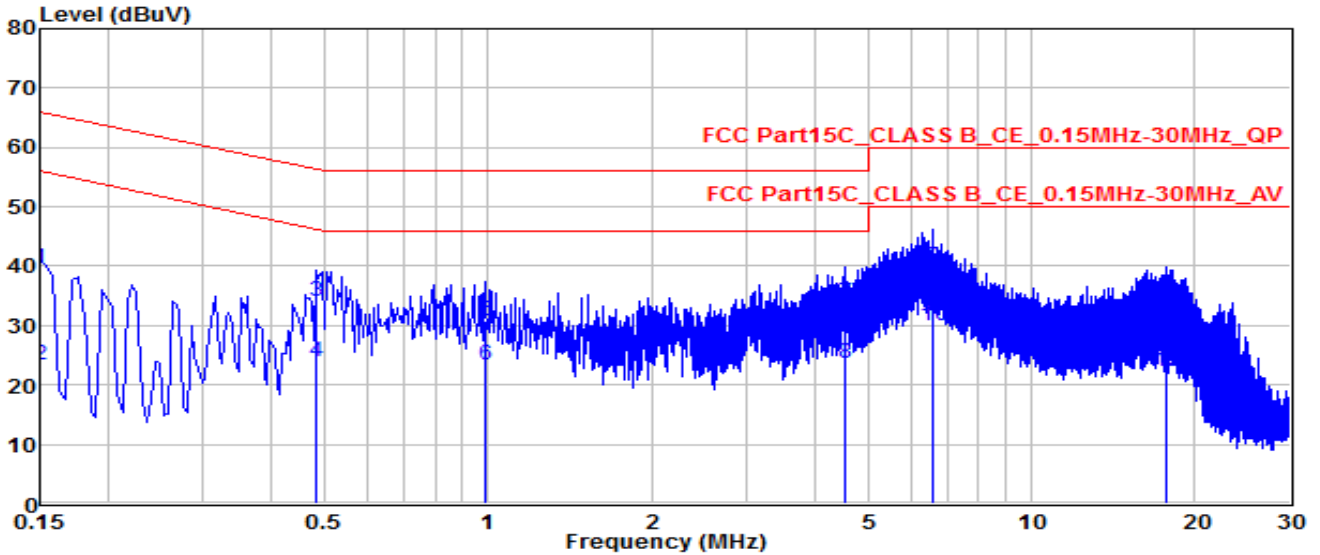

No		Frequency (MHz)	Reading (dBuV)	C.F (dB)	Measurement (dBuV)	Margin (dB)	Limit (dBuV)	Remark (QP/PK/AV)
1		0.15	29.78	9.77	39.55	-26.45	66	QP
2		0.15	13.53	9.77	23.3	-32.7	56	Average
3		0.48297	24.12	10.08	34.2	-22.09	56.29	QP
4		0.48297	13.91	10.08	23.99	-22.3	46.29	Average
5		0.98692	20.94	9.9	30.84	-25.16	56	QP
6		0.98692	13.57	9.9	23.47	-22.53	46	Average
7		4.528	23.95	9.77	33.72	-22.28	56	QP
8		4.528	13.9	9.77	23.67	-22.33	46	Average
9	*	6.611	30.11	9.78	39.89	-20.11	60	QP
10	*	6.611	20.09	9.78	29.87	-20.13	50	Average
11		17.667	23.52	9.99	33.51	-26.49	60	QP
12		17.667	12.25	9.99	22.24	-27.76	50	Average

Note :

1. "*" means the worst value in this measurement data .
2. C.F (Correction Factor) = Factor (dB)+ Cable Loss (dB) .
3. Measurement (dBuV) = Reading(dBuV)+ C.F (Correction Factor) .
4. Other mode was also verified. The test results shown represent the worst case emissions .

EUT	E-READER	Test Date	2017/06/03
Factor	CE_ENV216-N (Filter ON)	Temp. / Humidity	24°C / 55%
Polarity	Neutral	Site / Engineer	SR2 / Peter
Test Mode	MODE3_n-20M-CH06	Test Voltage	AC120V/60Hz

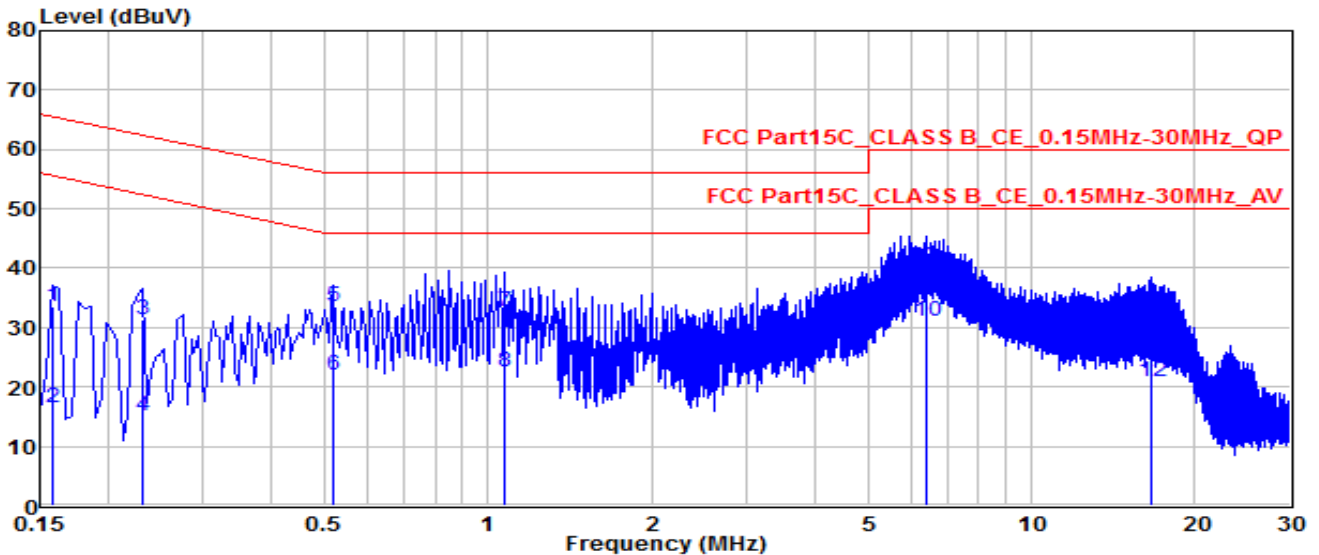

No	Frequency (MHz)	Reading (dBuV)	C.F (dB)	Measurement (dBuV)	Margin (dB)	Limit (dBuV)	Remark (QP/PK/AV)
1	0.159	23.5	10.05	33.55	-31.97	65.52	QP
2	0.159	6.49	10.05	16.54	-38.98	55.52	Average
3	0.23099	21.26	9.95	31.21	-31.2	62.41	QP
4	0.23099	5.09	9.95	15.04	-37.37	52.41	Average
5	0.51896	23.47	10.11	33.58	-22.42	56	QP
6	0.51896	11.85	10.11	21.96	-24.04	46	Average
7	1.072	22.96	9.88	32.84	-23.16	56	QP
8	1.072	12.54	9.88	22.42	-23.58	46	Average
9	*	6.44	9.8	40.2	-19.8	60	QP
10	*	21.22	9.8	31.02	-18.98	50	Average
11	16.704	21.51	10.02	31.53	-28.47	60	QP
12	16.704	10.95	10.02	20.97	-29.03	50	Average

Note :

- "*" means the worst value in this measurement data .
- C.F (Correction Factor) = Factor (dB)+ Cable Loss (dB) .
- Measurement (dBuV) = Reading(dBuV)+ C.F (Correction Factor) .
- Other channel was also verified. The test results shown represent the worst case emissions .

8. CONCLUSION

The data collected relate only the item(s) tested and show that the **E-READER, FCC ID: XR3-KEPLER3026** is in compliance with Part 15C of the FCC Rules.