

FCC AND IC CERTIFICATION TEST REPORT

FOR

Applicant	:	Fender Musical Instruments
Address	:	17600 North Perimeter Drive, Suite 100, Scottsdale, AZ85255 USA
Equipment under Test	:	Portable Audio Amplifier System
Model No.	:	PASSPORT EVENT SERIES 2
Type No,	:	PR 845
Trade Mark	:	FENDER
FCC ID	:	XQWPE2PR845
IC	:	8690A-PE2PR845
Manufacturer	:	Fender Musical Instruments
Address	:	17600 North Perimeter Drive, Suite 100, Scottsdale, AZ85255 USA

Issued By: Dongguan Dongdian Testing Service Co., Ltd.

Add: No. 17, Zongbu Road 2, Songshan Lake Sci&Tech, Industry Park, Dongguan
City, Guangdong Province, China, 523808

Tel: +86-0769-38826678, **E-mail:** ddt@dgddt.com, <http://www.dgddt.com>

TABLE OF CONTENTS

	Test report declares.....	4
1.	Summary of test results	6
2.	General test information.....	7
2.1.	Description of EUT	7
2.2.	Accessories of EUT	7
2.3.	Assistant equipment used for test.....	7
2.4.	Block diagram of EUT configuration for test.....	8
2.5.	Test environment conditions.....	8
2.6.	Deviations of test standard	8
2.7.	Test laboratory	8
2.8.	Measurement uncertainty	9
3.	Equipment used during test.....	10
4.	6 dB Bandwidth and 99% Bandwidth	11
4.1.	Block diagram of test setup	11
4.2.	Limits	11
4.3.	Test Procedure.....	11
4.4.	Test Result	11
4.5.	Original test data	12
5.	Maximum Peak Output Power	14
5.1.	Block diagram of test setup	14
5.2.	Limits	14
5.3.	Test Procedure.....	14
5.4.	Test Result	14
5.5.	Original test data	15
6.	Power Spectral Density.....	16
6.1.	Block diagram of test setup	16
6.2.	Limits	16
6.3.	Test Procedure.....	16
6.4.	Test Result	16
6.5.	Original test data	17
7.	Band Edge Compliance (conducted method)	18
7.1.	Block diagram of test setup	18
7.2.	Limits	18
7.3.	Test Procedure.....	18
7.4.	Test Result	19
7.5.	Original test data	19

8.	Radiated emission	20
8.1.	Block diagram of test setup	20
8.2.	Limit.....	21
8.3.	Test Procedure.....	22
8.4.	Test result.....	24
9.	RF Conducted Spurious Emissions.....	28
9.1.	Block diagram of test setup	28
9.2.	Limits	28
9.3.	Test Procedure.....	28
9.4.	Test Result	29
9.5.	Original test data	29
10.	Emissions in restricted frequency bands.....	33
10.1.	Block diagram of test setup	33
10.2.	Limit.....	33
10.3.	Test Procedure.....	33
10.4.	Test result.....	33
11.	Power Line Conducted Emission.....	38
11.1.	Block diagram of test setup	38
11.2.	Power Line Conducted Emission Limits	38
11.3.	Test Procedure.....	38
11.4.	Test Result	39
12.	Antenna Requirements	42
12.1.	Limit.....	42
12.2.	Result	42

TEST REPORT DECLARE

Applicant	:	Fender Musical Instruments
Address	:	17600 North Perimeter Drive, Suite 100, Scottsdale, AZ85255 USA
Equipment under Test	:	Portable Audio Amplifier System
Model No.	:	PASSPORT EVENT SERIES 2
Trade mark	:	FENDER
Manufacturer	:	Fender Musical Instruments
Address	:	17600 North Perimeter Drive, Suite 100, Scottsdale, AZ85255 USA

Test Standard Used:

FCC Rules and Regulations Part 15 Subpart C, RSS-247 Issue 2 February 2017.

Test procedure used:

ANSI C63.10:2013, RSS-Gen Issue 5, Apr. 2018

We Declare:

The equipment described above is tested by Dongguan Dongdian Testing Service Co., Ltd. and in the configuration tested the equipment complied with the standards specified above. The test results are contained in this test report and Dongguan Dongdian Testing Service Co., Ltd. is assumed of full responsibility for the accuracy and completeness of these tests.

After test and evaluation, our opinion is that the equipment provided for test compliance with the requirement of the above FCC&IC standards.

Report No:	DDT-R19090702-1E5		
Date of Receipt:	Sep. 09, 2019	Date of Test:	Sep. 09, 2019 ~ Sep. 17, 2019

Prepared By:

Emily Wang
Emily Wang/Engineer

Approved By:

Damon Hu/EMC Manager

Note: This report applies to above tested sample only. This report shall not be reproduced in parts without written approval of Dongguan Dongdian Testing Service Co., Ltd.

Revision history

Rev.	Revisions	Issue Date	Revised By
---	Initial issue	Sep. 17, 2019	

1. Summary of test results

The EUT have been tested according to the applicable standards as referenced below.		
Description of Test Item	Standard	Results
6dB Bandwidth and 99% Bandwidth	FCC Part 15: 15.247 ANSI C63.10:2013 RSS-247 Issue 2	PASS
Peak Output Power	FCC Part 15: 15.247 ANSI C63.10:2013 RSS-247 Issue 2	PASS
Power Spectral Density	FCC Part 15:15.247 ANSI C63.10:2013 RSS-247 Issue 2	PASS
Band Edge Compliance (conducted method)	FCC Part 15: 15.209 FCC Part 15: 15.247 ANSI C63.10: 2013 RSS-247 Issue 2 RSS-Gen Issue 5	PASS
Radiation Emission	FCC Part 15: 15.247 ANSI C63.10:2013 RSS-247 Issue 2 RSS-Gen Issue 5	PASS
RF Conducted Spurious Emissions	FCC Part 15: 15.209 FCC Part 15: 15.247 ANSI C63.10: 2013 RSS-247 Issue 2 RSS-Gen Issue 5	PASS
Emission in restricted frequency bands	FCC Part 15: 15.209 FCC Part 15: 15.247 ANSI C63.10: 2013 RSS-247 Issue 2 RSS-Gen Issue 5	PASS
Power Line Conducted Emission	FCC Part 15: 15.207 ANSI C63.10: 2013 RSS-Gen Issue 5	PASS
Antenna requirement	FCC Part 15: 15.203 RSS-Gen Issue 5	PASS

2. General test information

2.1. Description of EUT

EUT* Name	: Portable Audio Amplifier System
Model Number	: PASSPORT EVENT SERIES 2
EUT function description	: Please reference user manual of this device
Power supply	: AC 100-120V, 50/60Hz or AC 220-240V, 50/60Hz
Radio Specification	: Bluetooth V5.0
Operation frequency	: 2402 MHz-2480 MHz
Modulation	: GFSK
Data rate	: 1Mbps
Antenna Type	: Integral PCB antenna, maximum PK gain: -1.08 dBi
Sample Type	: Series production

Note: EUT is the ab. of equipment under test.

Channel information					
Channel	Frequency (MHz)	Channel	Frequency (MHz)	Channel	Frequency (MHz)
0	2402	14	2430	28	2458
1	2404	15	2432	29	2460
2	2406	16	2434	30	2462
3	2408	17	2436	31	2464
4	2410	18	2438	32	2466
5	2412	19	2440	33	2468
6	2414	20	2442	34	2470
7	2416	21	2444	35	2472
8	2418	22	2446	36	2474
9	2420	23	2448	37	2476
10	2422	24	2450	38	2478
11	2424	25	2452	39	2480
12	2426	26	2454		
13	2428	27	2456		

2.2. Accessories of EUT

Description of Accessories	Manufacturer	Model number	Description	Remark
/	/	/	/	/

2.3. Assistant equipment used for test

Assistant equipment	Manufacturer	Model number	EMC Compliance	SN
Notebook	Lenovo Beijing Co. Ltd.	ThinkPad	FCC/CE	TP00015A

2.4. Block diagram of EUT configuration for test



Test software: BlueTest3.EXE

The test software was used to control EUT work in Continuous Tx mode, and select test channel, wireless mode as below table:

Tested mode, channel, information			
Mode	Setting Tx Power	Channel	Frequency (MHz)
GFSK	/	CH0	2402
	/	CH19	2440
	/	CH39	2480

2.5. Test environment conditions

During the measurement the environmental conditions were within the listed ranges:

Temperature range:	21-25 °C
Humidity range:	40-75%
Pressure range:	86-106 kPa

2.6. Deviations of test standard

No Deviation.

2.7. Test laboratory

Dongguan Dongdian Testing Service Co., Ltd

Add: No. 17, Zongbu Road 2, Songshan Lake Sci&Tech, Industry Park, Dongguan City, Guangdong Province, China, 523808

Tel: +86-0769-38826678, <http://www.dgddt.com>, Email: ddt@dgddt.com

CNAS Accreditation No. L6451; A2LA Accreditation No. 3870.01

FCC Designation Number: CN1182; FCC Test Firm Registration Number: 540522

Industry Canada site registration number: 10288A-1

2.8. Measurement uncertainty

Test Item	Uncertainty
Bandwidth	1.1%
Peak Output Power (Conducted) (Spectrum analyzer)	0.86 dB (10 MHz ≤ f < 3.6 GHz); 1.38 dB (3.6 GHz ≤ f < 8 GHz)
Peak Output Power (Conducted) (Power Sensor)	0.74 dB
Power Spectral Density	0.74 dB (10 MHz ≤ f < 3.6 GHz); 1.38 dB (3.6 GHz ≤ f < 8 GHz)
Frequencies Stability	6.7 × 10 ⁻⁸ (Antenna couple method) 5.5 × 10 ⁻⁸ (Conducted method)
Conducted spurious emissions	0.86 dB (10 MHz ≤ f < 3.6 GHz); 1.40 dB (3.6 GHz ≤ f < 8 GHz) 1.66 dB (8 GHz ≤ f < 22 GHz)
Uncertainty for radio frequency (RBW < 20 kHz)	3 × 10 ⁻⁸
Temperature	0.4 °C
Humidity	2 %
Uncertainty for Radiation Emission test (30 MHz-1 GHz)	4.70 dB (Antenna Polarize: V) 4.84 dB (Antenna Polarize: H)
Uncertainty for Radiation Emission test (1 GHz-40 GHz)	4.10 dB (1-6 GHz) 4.40 dB (6 GHz-18 GHz) 3.54 dB (18 GHz-26 GHz) 4.30 dB (26 GHz-40 GHz)
Uncertainty for Power line conduction emission test	3.32 dB (150 kHz-30 MHz)

Note: This uncertainty represents an expanded uncertainty expressed at approximately the 95% confidence level using a coverage factor of k=2.

3. Equipment used during test

Equipment	Manufacturer	Model No.	Serial No.	Last Cal.	Cal. Interval
RF Connected Test (Tonscend RF Measurement System)					
Spectrum analyzer	R&S	FSU26	200071	Oct. 12, 2018	1 Year
Wideband Radio Communication tester	R&S	CMW500	117491	Jun. 25, 2019	1 Year
Vector Signal Generator	Agilent	E8267D	US49060192	Oct. 12, 2018	1 Year
Vector Signal Generator	Agilent	N5182A	MY48180737	Jun. 25, 2019	1 Year
Power Sensor	Agilent	U2021XA	MY55150010	Jun. 28, 2019	1 Year
Power Sensor	Agilent	U2021XA	MY55150011	Jun. 28, 2019	1 Year
DC Power Source	MATRIS	MPS-3005L-3	D813058W	Jun. 25, 2019	1 Year
RF Cable	Micable	C10-01-01-1	100309	Oct. 21, 2018	1 Year
Temp&Humi Programmable	ZHIXIANG	ZXGDJS-150L	ZX170110-A	Oct. 21, 2018	1 Year
Test Software	JS Tonscend	JS1120-3	Ver.2.7	N/A	N/A
Radiation 1#chamber					
EMI Test Receiver	R&S	ESU8	100316	Oct. 12, 2018	1 Year
Spectrum analyzer	Agilent	E4447A	MY50180031	Jun. 25, 2019	1 Year
Trilog Broadband Antenna	Schwarzbeck	VULB9163	9163-462	Nov. 09, 2018	1 Year
Active Loop antenna	Schwarzbeck	FMZB-1519	1519-038	Oct. 20, 2018	1 Year
Double Ridged Horn Antenna	R&S	HF907	100276	Nov. 16, 2018	1 Year
Broad Band Horn Antenna	Schwarzbeck	BBHA 9170	790	Oct. 25, 2018	1 Year
Pre-amplifier	A.H.	PAM-0118	360	Oct. 12, 2018	1 Year
Pre-amplifier	TERA-MW	TRLA-0040 G35	101303	Oct. 12, 2018	1 Year
RF Cable	HUBSER	CP-X2+ CP-X1	W11.03+ W12.02	Oct. 21, 2018	1 Year
RF Cable	N/A	SMAJ-SMA J-1M+ 11M	17070133+17070131	Nov. 08, 2018	1 Year
MI Cable	HUBSER	C10-01-01-1 M	1091629	Oct. 21, 2018	1 Year
Test software	Audix	E3	V 6.11111b	N/A	N/A
Power Line Conducted Emissions Test					
EMI Test Receiver	R&S	ESU8	100316	Oct. 21, 2018	1 Year
LISN 1	R&S	ENV216	101109	Oct. 21, 2018	1 Year
LISN 2	R&S	ESH2-Z5	100309	Oct. 21, 2018	1 Year
Pulse Limiter	R&S	ESH3-Z2	101242	Oct. 21, 2018	1 Year
CE Cable 1	HUBSER	N/A	W10.01	Oct. 21, 2018	1 Year
Test software	Audix	E3	V 6.11111b	N/A	N/A

4. 6 dB Bandwidth and 99% Bandwidth

4.1. Block diagram of test setup

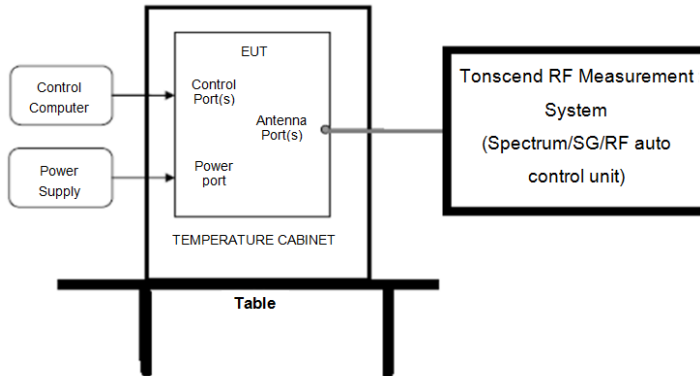

4.2. Limits

For direct sequence systems, the minimum 6dB bandwidth shall be at least 500 kHz

4.3. Test Procedure

- (1) Connect EUT's antenna output to spectrum analyzer by RF cable.
- (2) 99% Bandwidth set the spectrum analyzer as follows:

RBW:	30 kHz
VBW:	100 kHz
Detector Mode:	Peak
Sweep time:	auto
Trace mode	Max hold

- (3) 6 dB Bandwidth set the spectrum analyzer as follows:

RBW:	100 kHz
VBW:	300 kHz
Detector Mode:	Peak
Sweep time:	auto
Trace mode	Max hold

- (4) Allow the trace to stabilize, measure the 6 dB and 99% bandwidth of signal.

4.4. Test Result

Mode	Channel	99% bandwidth Result (MHz)	6 dB bandwidth Result (MHz)	6 dB width Limit (MHz)	Conclusion
GFSK	CH0	1.02	0.696	>0.5	PASS
	CH19	1.02	0.692	>0.5	PASS
	CH39	1.02	0.700	>0.5	PASS

4.5. Original test data

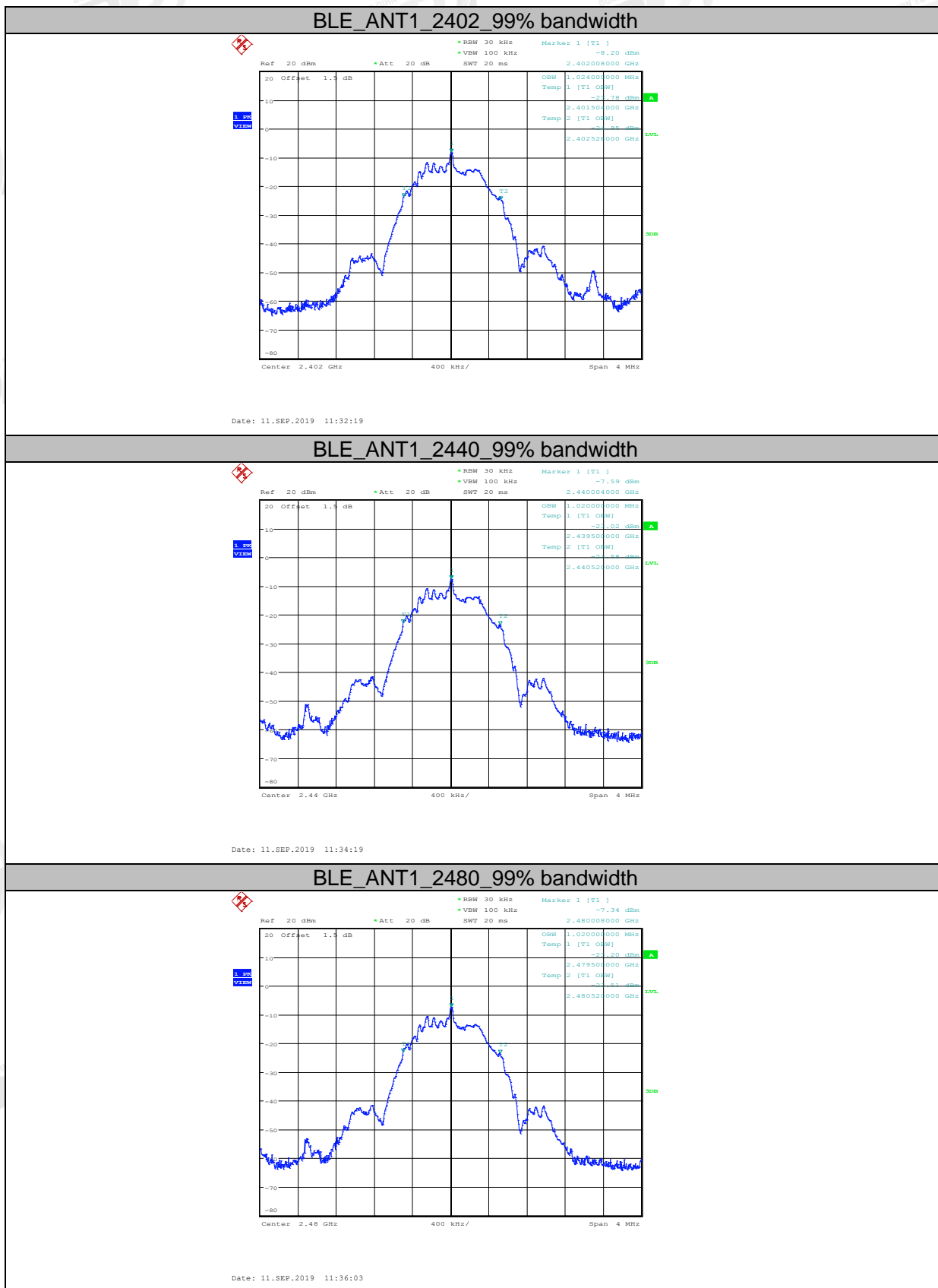

BLE_ANT1_2402_6 dB bandwidth

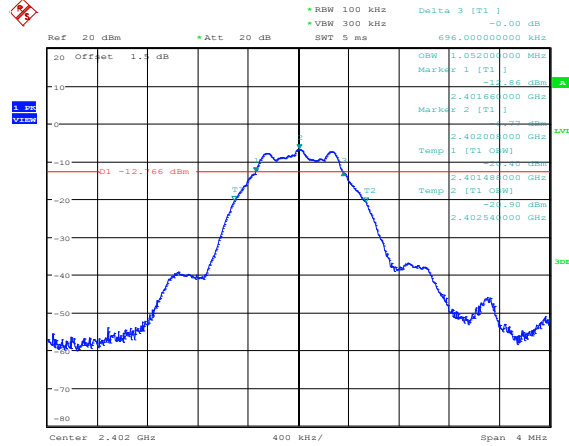

Date: 11.SEP.2019 11:32:08

BLE_ANT1_2440_6 dB bandwidth

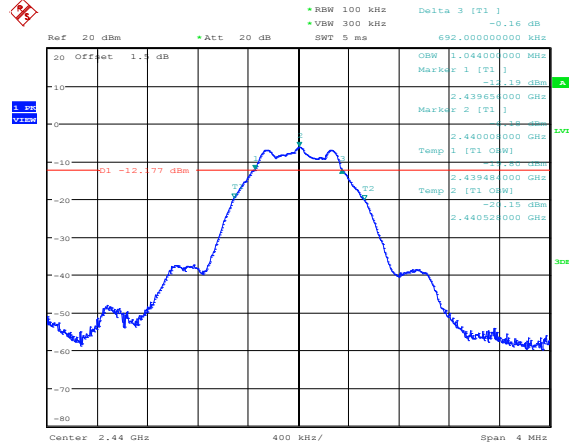

Date: 11.SEP.2019 11:34:08

BLE_ANT1_2480_6 dB bandwidth

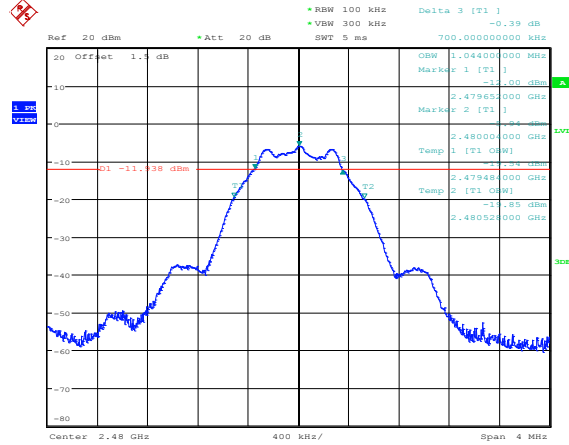

Date: 11.SEP.2019 11:35:52

5. Maximum Peak Output Power

5.1. Block diagram of test setup

Same with 4.1

5.2. Limits

For systems using digital modulation in the 902-928 MHz, 2400-2483.5 MHz, and 5725-5850 MHz bands: 1 Watt. If transmitting antennas of directional gain greater than 6dBi are used, the conducted output power from the intentional radiator shall be reduced below the stated values as appropriate, by the amount in dB that the directional gain of the antenna exceeds 6dBi.

5.3. Test Procedure

(1) Connect EUT's antenna output to spectrum analyzer by RF cable.

(2) Set the spectrum analyzer as follows:

RBW:	≥DTS bandwidth
VBW:	≥3 x RBW
Span	≥3 x RBW
Detector Mode:	Peak
Sweep time:	auto
Trace mode	Max hold

(3) Allow the trace to stabilize, Use the instrument's band/channel power measurement function with the band limits set equal to the DTS bandwidth edges measure out the PK output power.

5.4. Test Result

Mode	Freq. (MHz)	Peak Output Power (dBm)	Limit (dBm)	Conclusion
GFSK	2402	-6.16	30	PASS
	2440	-5.55	30	PASS
	2480	-5.35	30	PASS

5.5. Original test data

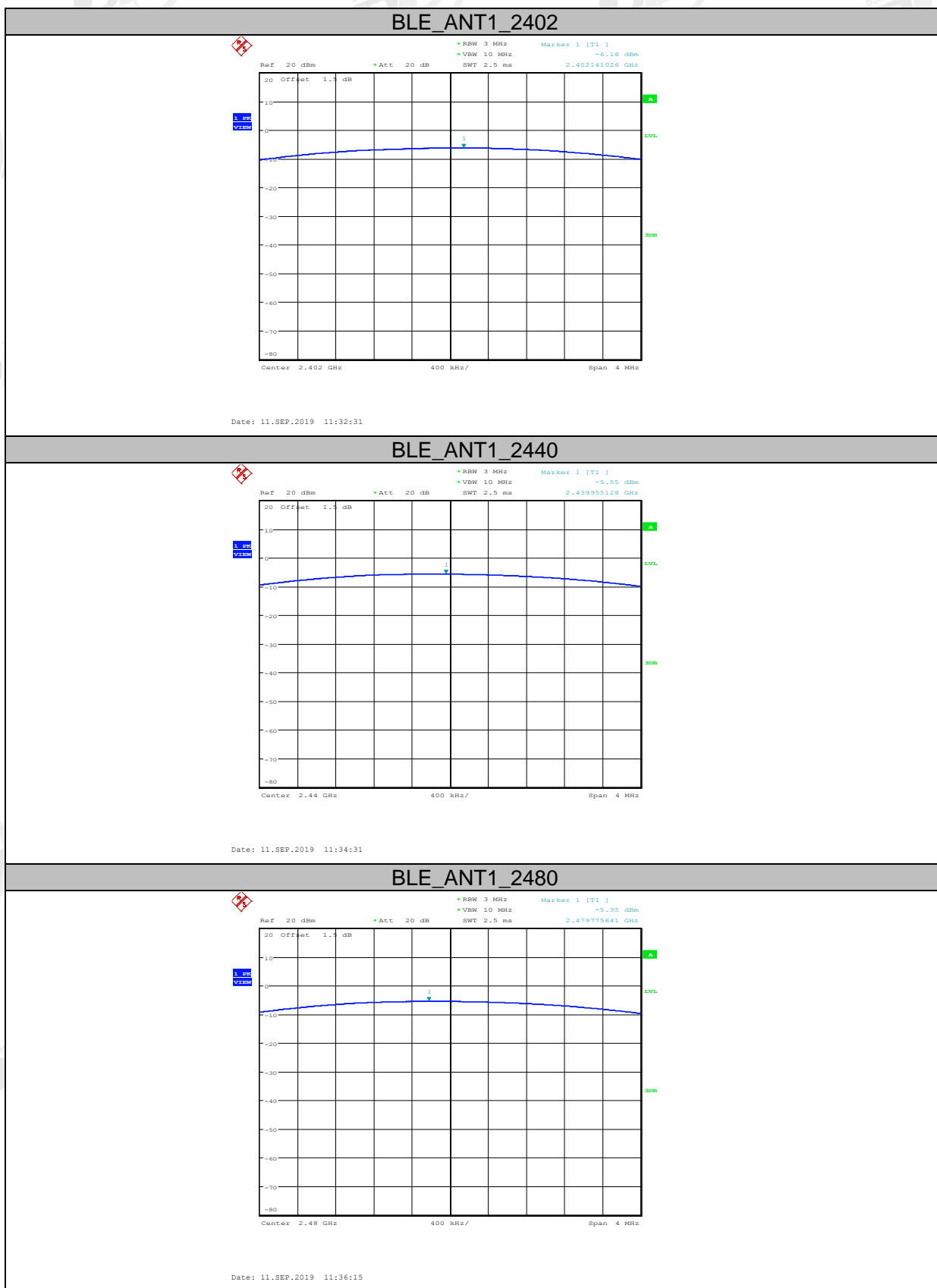

6. Power Spectral Density

6.1. Block diagram of test setup

Same with 4.1

6.2. Limits

For digitally modulated systems, the power spectral density conducted from the intentional radiator to the antenna shall not be greater than 8dBm in any 3 kHz band during any time interval of continuous transmission.

6.3. Test Procedure

- (1) Connect EUT's antenna output to spectrum analyzer by RF cable.
- (2) Set the spectrum analyzer as follows:

Center frequency	DTS Channel center frequency
RBW:	$3 \text{ kHz} \leq \text{RBW} \leq 100 \text{ kHz}$
VBW:	$\geq 3\text{RBW}$
Span	1.5 times the DTS bandwidth
Detector Mode:	Peak
Sweep time:	auto
Trace mode	Max hold

- (3) Allow the trace to stabilize, use the peak marker function to determine the maximum amplitude level within the RBW.
- (4) If measured value exceeds limit, reduce RBW (no less than 3 kHz) and repeat.

6.4. Test Result

EUT Set Mode	Antenna	Channel	Result (dBm/3 kHz)
GFSK	ANT1	CH0	-22.43
	ANT1	CH19	-21.72
	ANT1	CH39	-21.60
Limit: <8 dBm/3 kHz			Conclusion: PASS

6.5. Original test data

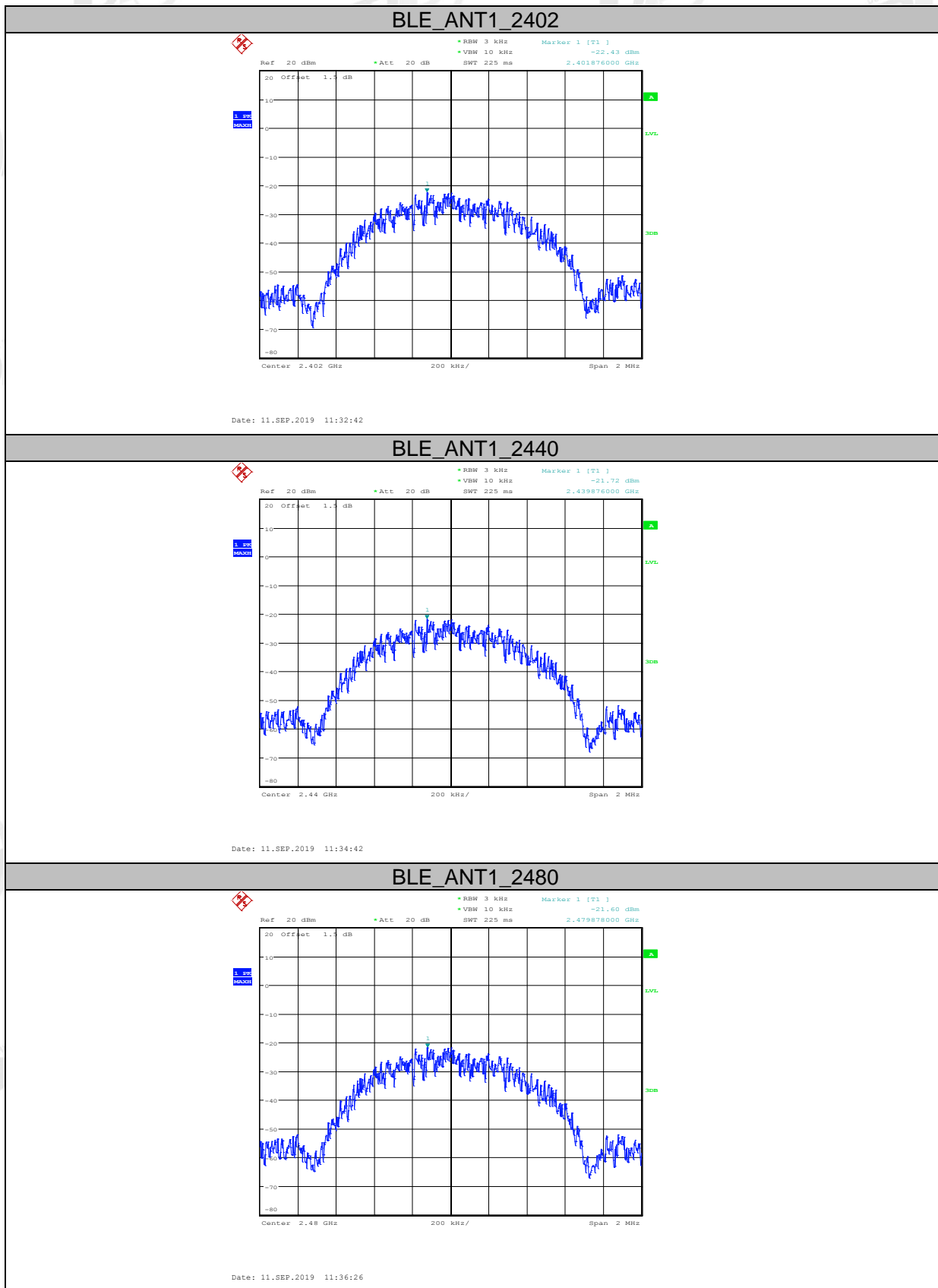

7. Band Edge Compliance (conducted method)

7.1. Block diagram of test setup

Same with 4.1

7.2. Limits

In any 100kHz bandwidth outside the frequency bands in which the spread spectrum intentional radiator is operating, the radio frequency power that is produced by the intentional radiator shall be at least 20dB below that in the 100kHz bandwidth within the band that contains the highest level of the desired power.

7.3. Test Procedure

(1) Connect EUT's antenna output to spectrum analyzer by RF cable.

(2) Establish a reference level by using the following procedure:

Center frequency	DTS Channel center frequency
RBW:	100 kHz
VBW:	300 kHz
Span	1.5 times the DTS bandwidth
Detector Mode:	Peak
Sweep time:	auto
Trace mode	Max hold

(3) Allow the trace to stabilize, use the peak marker function to determine the maximum peak power level to establish the reference level.

(4) Set the spectrum analyzer as follows:

RBW:	100 kHz
VBW:	300 kHz
Span	Encompass frequency range to be measured
Number of measurement points	$\geq \text{span}/\text{RBW}$
Detector Mode:	Peak
Sweep time:	auto
Trace mode	Max hold

(5) Allow the trace to stabilize, use the peak marker function to determine the maximum amplitude of all unwanted emissions outside of the authorized frequency band

7.4. Test Result

EUT Set Mode	CH or Frequency	Measured Range	Result (dBm)
GFSK	CH0	2.310 GHz-2.410 GHz	PASS
	CH39	2.470 GHz-2.570 GHz	PASS

7.5. Original test data

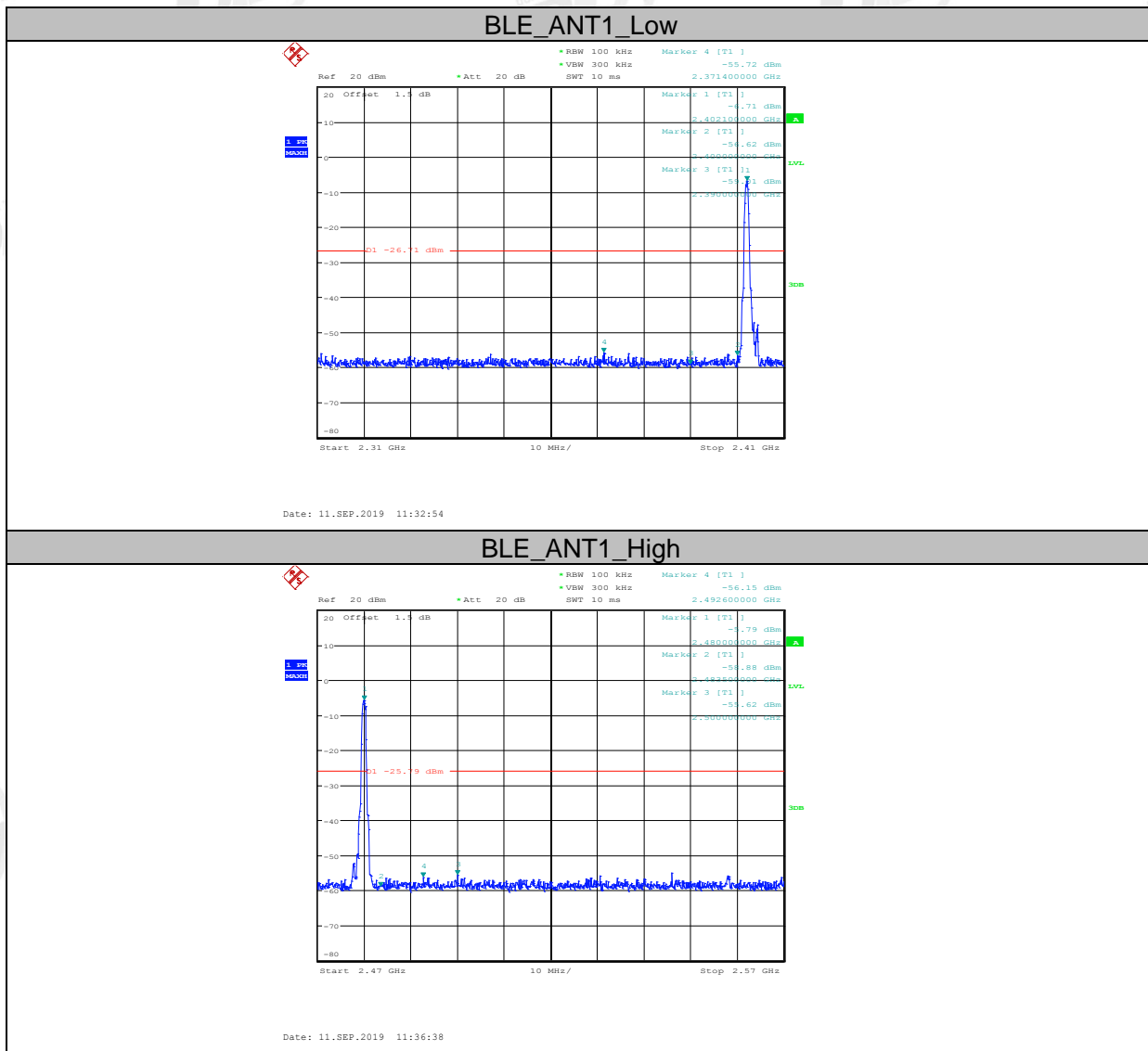

8. Radiated emission

8.1. Block diagram of test setup

In 3m Anechoic Chamber Test Setup Diagram for 9kHz-30MHz

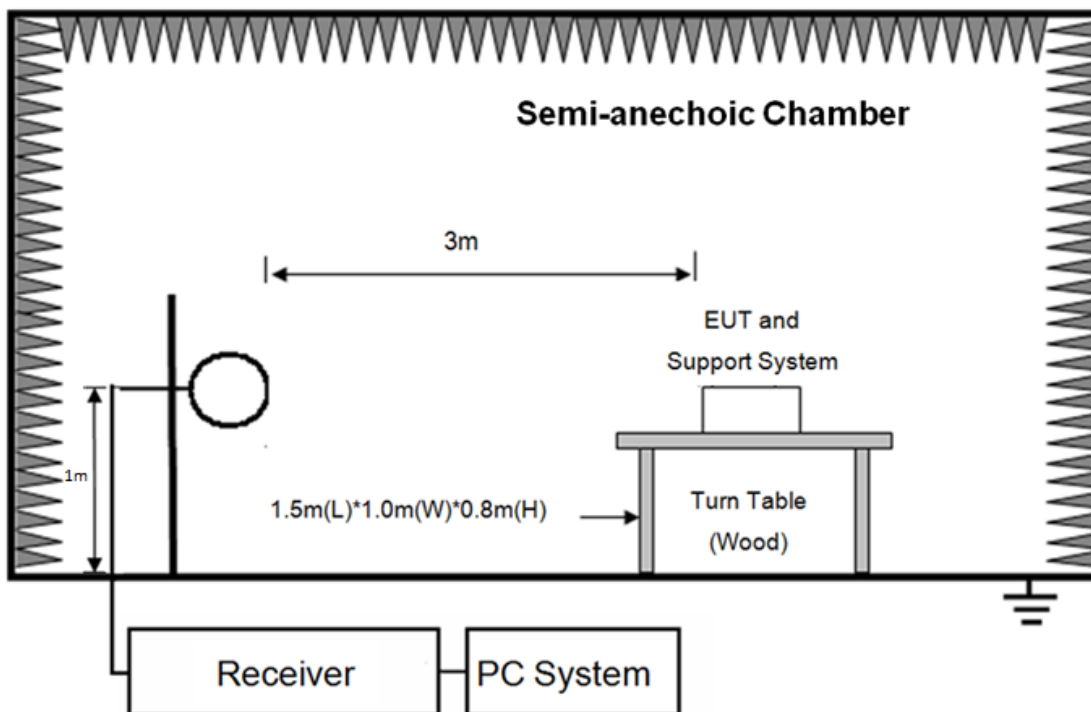

In 3m Anechoic Chamber Test Setup Diagram for 30MHz-1GHz

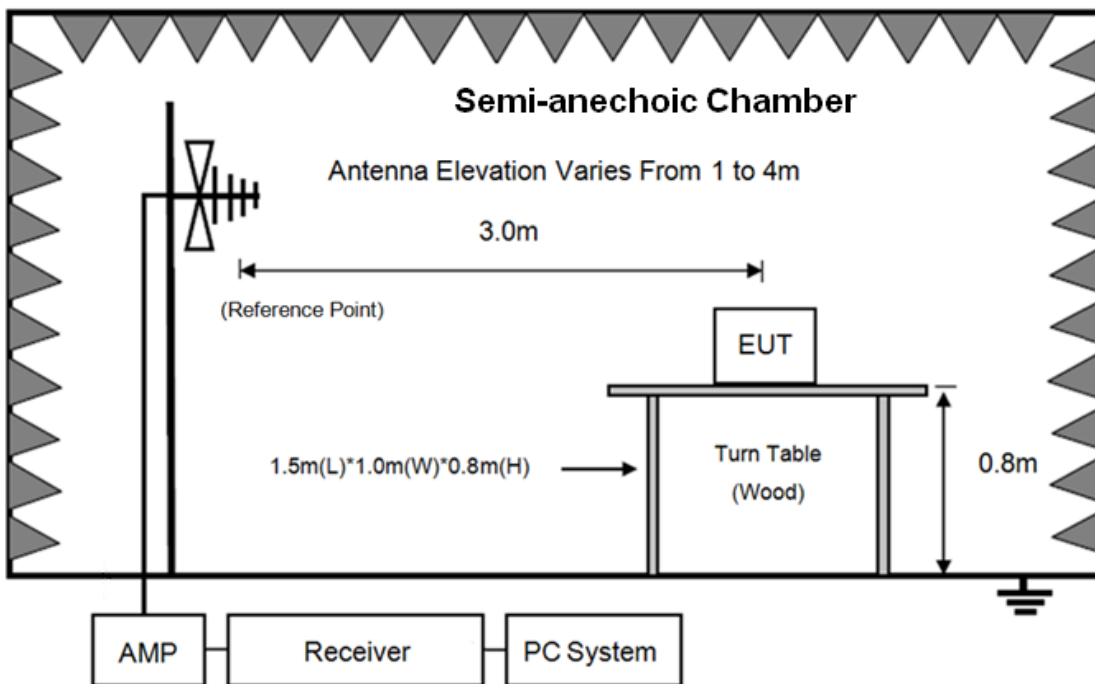

In 3m Anechoic Chamber Test Setup Diagram for frequency above 1GHz

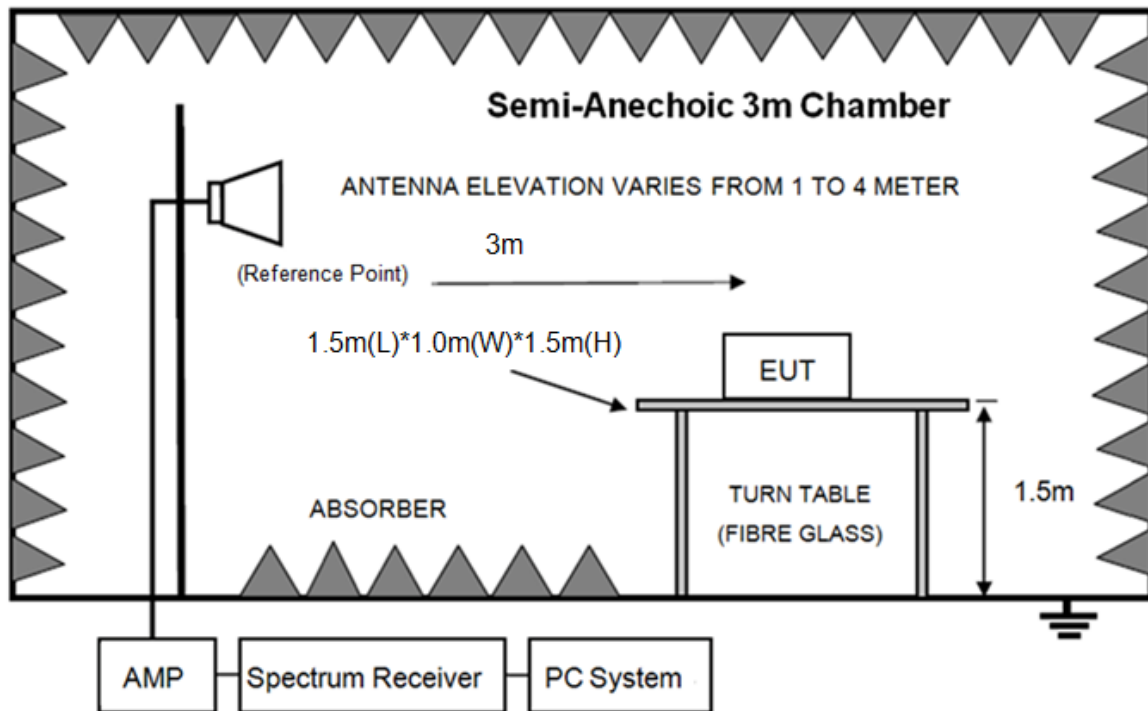

Note: For harmonic emissions test an appropriate high pass filter was inserted in the input port of AMP.

8.2. Limit

8.2.1 FCC 15.205 Restricted frequency band

MHz	MHz	MHz	GHz
0.090-0.110	16.42-16.423	399.9-410	4.5-5.15
0.495-0.505	16.69475-16.69525	608-614	5.35-5.46
2.1735-2.1905	16.80425-16.80475	960-1240	7.25-7.75
4.125-4.128	25.5-25.67	1300-1427	8.025-8.5
4.1772&4.17775	37.5-38.25	1435-1626.5	9.0-9.2
4.2072&4.20775	73-74.6	1645.5-1646.5	9.3-9.5
6.215-6.218	74.8-75.2	1660-1710	10.6-12.7
6.26775-6.26825	108-121.94	1718.8-1722.2	13.25-13.4
6.31175-6.31225	123-138	2200-2300	14.47-14.5
8.291-8.294	149.9-150.05	2310-2390	15.35-16.2
8.362-8.366	156.52475-156.52525	2483.5-2500	17.7-21.4
8.37625-8.38675	156.7-156.9	2690-2900	22.01-23.12
8.41425-8.41475	162.0125-167.17	3260-3267	23.6-24.0
12.29-12.293	167.72-173.2	3332-3339	31.2-31.8
12.51975-12.52025	240-285	3345.8-3358	36.43-36.5
12.57675-12.57725	322-335.4	3600-4400	(?)
13.36-13.41			

8.2.2 FCC 15.209 Limit.

FREQUENCY MHz	DISTANCE Meters	FIELD STRENGTHS LIMIT	
		$\mu\text{V}/\text{m}$	$\text{dB}(\mu\text{V})/\text{m}$
0.009 ~ 0.490	300	2400/F(kHz)	67.6-20log(F)
0.490 ~ 1.705	30	24000/F(kHz)	87.6-20log(F)
1.705 ~ 30.0	30	30	29.54
30 ~ 88	3	100	40.0
88 ~ 216	3	150	43.5
216 ~ 960	3	200	46.0
960 ~ 1000	3	500	54.0
Above 1000	3	74.0 $\text{dB}(\mu\text{V})/\text{m}$ (Peak) 54.0 $\text{dB}(\mu\text{V})/\text{m}$ (Average)	

Note: (1) The emission limits shown in the above table are based on measurements employing a CISPR QP detector except for the frequency bands 9-90 kHz, 110-490 kHz and above 1000 MHz. Radiated emissions limits in these three bands are based on measurements employing an average detector.

(2) At frequencies below 30 MHz, measurement may be performed at a distance closer than that specified, and the limit at closer measurement distance can be extrapolated by below formula:

$$\text{Limit}_{3\text{m}}(\text{dB}\mu\text{V}/\text{m}) = \text{Limit}_{30\text{m}}(\text{dB}\mu\text{V}/\text{m}) + 40\text{Log}(30\text{m}/3\text{m})$$

8.2.3 Limit for this EUT

All the emissions appearing within 15.205 restricted frequency bands shall not exceed the limits shown in 15.209, all the other emissions shall be at least 20dB below the fundamental emissions or comply with 15.209 limits.

8.3. Test Procedure

(1) EUT was placed on a non-metallic table, 80 cm above the ground plane inside a semi-anechoic chamber for below 1 G and 150 cm above the ground plane inside a semi-anechoic chamber for above 1 G.

(2) Test antenna was located 3m from the EUT on an adjustable mast, and the antenna used as below table.

Test frequency range	Test antenna used	Test antenna distance
9 kHz-30 MHz	Active Loop antenna	3m
30 MHz-1 GHz	Trilog Broadband Antenna	3m
1 GHz-18 GHz	Double Ridged Horn Antenna(1GHz-18GHz)	3m
18 GHz-40 GHz	Horn Antenna (18 GHz-40 GHz)	1m

According ANSI C63.10:2013 clause 6.4.4.2 and 6.5.3, for measurements below 30 MHz, the loop antenna was positioned with its plane vertical from the EUT and rotated about its vertical axis for maximum response at each azimuth position around the EUT. And the loop antenna also be positioned with its plane horizontal at the specified distance from the EUT. The center of the

loop is 1 m above the ground. for measurement above 30MHz, the Trilog Broadband Antenna or Horn Antenna was located 3m from EUT, Measurements were made with the antenna positioned in both the horizontal and vertical planes of Polarization, and the measurement antenna was varied from 1 m to 4 m. in height above the reference ground plane to obtain the maximum signal strength.

(3) Below pre-scan procedure was first performed in order to find prominent frequency spectrum radiated emissions from 9 kHz to 25 GHz:

(a) Scanning the peak frequency spectrum with the antenna specified in step (3), and the EUT was rotated 360 degree, the antenna height was varied from 1m to 4m (Except loop antenna, it's fixed 1m above ground.)

(b) Change work frequency or channel of device if practicable.

(c) Change modulation type of device if practicable.

(d) Change power supply range from 85% to 115% of the rated supply voltage

(e) Rotated EUT though three orthogonal axes to determine the attitude of EUT arrangement produces highest emissions.

Spectrum frequency from 9kHz to 25 GHz (tenth harmonic of fundamental frequency) was investigated, and no any obvious emission were detected from 9kHz to 30 MHz and 18 GHz to 25 GHz, so below final test was performed with frequency range from 30 MHz to 18 GHz.

(4) For final emissions measurements at each frequency of interest, the EUT was rotated and the antenna height was varied between 1m and 4m in order to maximize the emission. Measurements in both horizontal and vertical polarities were made and the data was recorded. In order to find the maximum emission, the relative positions of equipments and all of the interface cables were changed according to ANSI C63.10:2013 on Radiated Emission test.

(5) The emissions from 9 kHz to 1 GHz were measured based on CISPR QP detector except for the frequency bands 9-90 kHz, 110-490 kHz, for emissions from 9 kHz-90 kHz,110 kHz-490 kHz and above 1 GHz were measured based on average detector, for emissions above 1GHz, peak emissions also be measured and need comply with Peak limit.

(6) The emissions from 9 kHz to 1 GHz, QP or average values were measured with EMI receiver with below RBW

Frequency band	RBW
9 kHz-150 kHz	200 Hz
150 kHz-30 MHz	9 kHz
30 MHz-1 GHz	120 kHz

(7) For emissions above 1 GHz, both Peak and Average level were measured with Spectrum Analyzer, and the RBW is set at 1 MHz, VBW is set at 3 MHz for Peak measure; RBW is set at 1 MHz, VBW is set at 10 Hz for Average measure (according ANSI C63.10:2013 clause 4.1.4.2.2 procedure for average measure).

8.4. Test result

PASS. (See below detailed test result)

All the emissions except fundamental emission from 9 kHz to 25 GHz were comply with 15.209 limit.

Note1: According exploratory test no any obvious emission was detected from 9kHz to 30MHz and 18 GHz to 25 GHz, so the final test was performed with frequency range from 30MHz to 18 GHz and recorded in below.

Note2: For emissions below 1 GHz, according exploratory explorer test, when change Tx mode and channel, have no distinct influence on emissions level, so for emissions below 1 GHz, the final test was only performed with EUT working in GFSK, Tx 2480 MHz mode.

Note3: For emissions above 1 GHz. If peak results comply with AV limit, AV Result is deemed to comply with AV limit.

Radiated Emission test (below 1GHz) TR-4-E-009 Radiated Emission Test Result

Test Site : DDT 3m Chamber 1# Test Date : 2019-09-09 EUT : Portable Audio Amplifier System Power Supply : AC 240V/60Hz Condition : Temp:24.5°C,Humi:55%,Press:101.4kPa Memo :	D:\2019 RE1# Report Data\Q19090702-1E PASSPORT\FCC BELOW1G.EM6 Tested By : Talent Model Number : PASSPORT EVENT SERIES 2 Test Mode : Tx mode Antenna/Distance : 2018 VULB 9163 1#/3m/HORIZONTAL
--	---

Data: 3

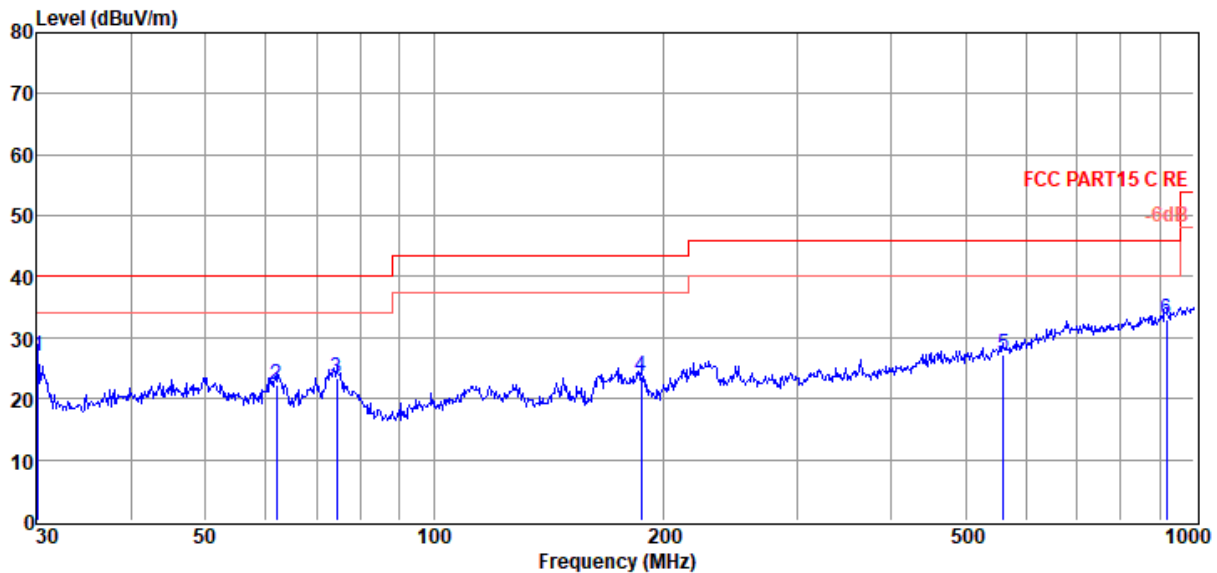

Item (Mark)	Freq. (MHz)	Read Level (dBμV)	Antenna Factor (dB/m)	Cable Loss (dB)	Result Level (dBμV/m)	Limit Line (dBμV/m)	Over Limit (dB)	Detector	Polarization
1	30.11	12.15	11.13	3.64	26.92	40.00	-13.08	QP	HORIZONTAL
2	62.00	7.35	11.00	3.97	22.32	40.00	-17.68	QP	HORIZONTAL
3	74.40	10.08	9.23	4.05	23.36	40.00	-16.64	QP	HORIZONTAL
4	187.10	8.84	9.91	4.76	23.51	43.50	-19.99	QP	HORIZONTAL
5	560.69	3.25	17.98	5.98	27.21	46.00	-18.79	QP	HORIZONTAL
6	919.29	4.06	21.92	7.01	32.99	46.00	-13.01	QP	HORIZONTAL

- Note: 1. Result Level = Read Level + Antenna Factor + Cable loss.
 2. If Peak Result complies with QP limit, QP Result is deemed to comply with QP limit.
 3. Test setup: RBW: 120 kHz, VBW: 300 kHz, Sweep time: auto.

TR-4-E-009 Radiated Emission Test Result

Test Site : DDT 3m Chamber 1#

D:\2019 RE1# Report Data\Q19090702-1E PASSPORT\FCC BELOW1G.EM6

Test Date : 2019-09-09

Tested By : Talent

EUT : Portable Audio Amplifier System

Model Number : PASSPORT EVENT SERIES 2

Power Supply : AC 240V/60Hz

Test Mode : Tx mode

Condition : Temp:24.5°C,Humi:55%,Press:101.4kPa

Antenna/Distance : 2018 VULB 9163 1#/3m/VERTICAL

Memo :

Data: 4

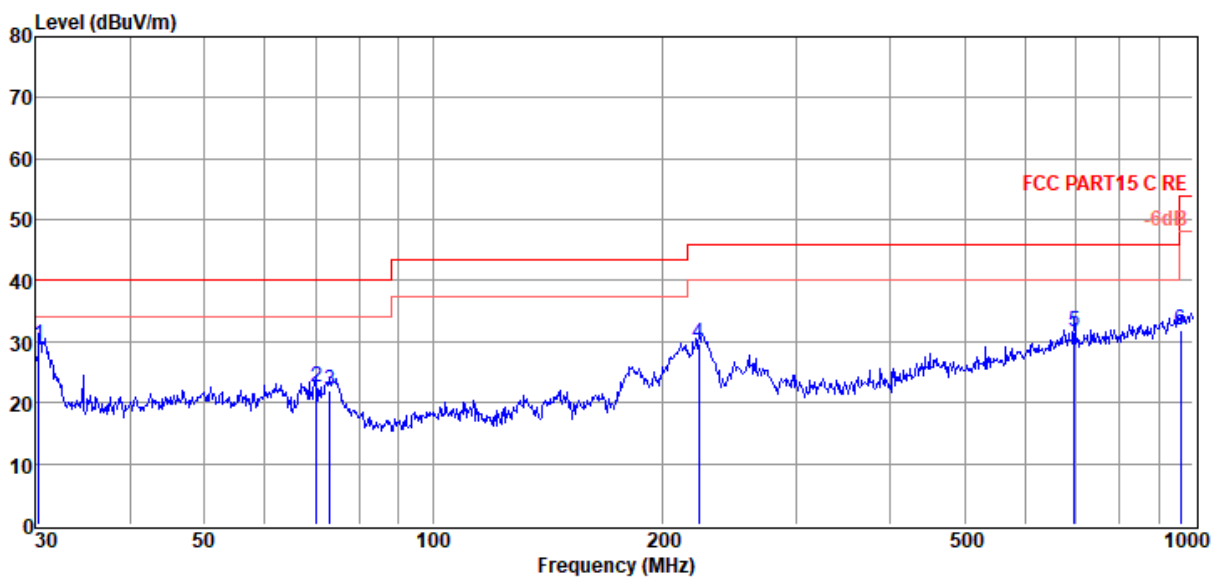

Item (Mark)	Freq. (MHz)	Read Level (dBμV)	Antenna Factor (dB/m)	Cable Loss (dB)	Result Level (dBμV/m)	Limit Line (dBμV/m)	Over Limit (dB)	Detector	Polarization
1	30.32	14.61	11.18	3.64	29.43	40.00	-10.57	QP	VERTICAL
2	70.34	8.94	9.48	4.02	22.44	40.00	-17.56	QP	VERTICAL
3	73.10	8.69	9.31	4.04	22.04	40.00	-17.96	QP	VERTICAL
4	223.73	12.69	12.12	4.90	29.71	46.00	-16.29	QP	VERTICAL
5	696.86	5.32	20.05	6.37	31.74	46.00	-14.26	QP	VERTICAL
6	962.16	2.52	22.40	7.06	31.98	54.00	-22.02	QP	VERTICAL

Note: 1. Result Level = Read Level + Antenna Factor + Cable loss.

2. If Peak Result complies with QP limit, QP Result is deemed to comply with QP limit.

3. Test setup: RBW: 120 kHz, VBW: 300 kHz, Sweep time: auto.

Radiated Emission test (above 1GHz)

Freq. (MHz)	Read level (dB μ V)	Antenna Factor (dB/m)	PRM Factor (dB)	Cable Loss (dB)	Result Level (dB μ V/m)	Limit (dB μ V/m)	Margin (dB)	Detector type	Polarization
GFSK Tx mode 2402MHz									
4808.00	47.73	33.79	44.24	5.52	42.80	74.00	-31.20	Peak	HORIZONTAL
7205.00	46.53	35.73	43.43	6.40	45.23	74.00	-28.77	Peak	HORIZONTAL
8786.00	47.33	36.80	43.52	7.80	48.41	74.00	-25.59	Peak	HORIZONTAL
10350.00	47.71	37.61	44.00	8.83	50.15	74.00	-23.85	Peak	HORIZONTAL
12679.00	46.69	38.17	43.40	10.19	51.65	74.00	-22.35	Peak	HORIZONTAL
13971.00	45.32	40.13	43.11	11.09	53.43	74.00	-20.57	Peak	HORIZONTAL
4808.00	47.84	33.79	44.24	5.52	42.91	74.00	-31.09	Peak	VERTICAL
7205.00	45.91	35.73	43.43	6.40	44.61	74.00	-29.39	Peak	VERTICAL
8854.00	47.59	36.80	43.55	7.84	48.68	74.00	-25.32	Peak	VERTICAL
10435.00	48.20	37.66	43.97	8.85	50.74	74.00	-23.26	Peak	VERTICAL
12560.00	46.95	38.12	43.43	10.00	51.64	74.00	-22.36	Peak	VERTICAL
13954.00	45.32	40.09	43.11	11.08	53.38	74.00	-20.62	Peak	VERTICAL
GFSK Tx mode 2440MHz									
4876.00	47.02	33.83	44.22	5.54	42.17	74.00	-31.83	Peak	HORIZONTAL
7324.00	44.65	35.80	43.38	6.54	43.61	74.00	-30.39	Peak	HORIZONTAL
10384.00	46.77	37.63	43.99	8.84	49.25	74.00	-24.75	Peak	HORIZONTAL
12016.00	46.33	38.00	43.56	9.13	49.90	74.00	-24.10	Peak	HORIZONTAL
12985.00	46.80	38.29	43.33	10.69	52.45	74.00	-21.55	Peak	HORIZONTAL
14039.00	45.18	40.21	43.10	11.10	53.39	74.00	-20.61	Peak	HORIZONTAL
4876.00	47.41	33.83	44.22	5.54	42.56	74.00	-31.44	Peak	VERTICAL
7324.00	45.39	35.80	43.38	6.54	44.35	74.00	-29.65	Peak	VERTICAL
9755.00	47.95	37.26	43.99	8.54	49.76	74.00	-24.24	Peak	VERTICAL
10996.00	47.34	37.50	43.82	9.00	50.02	74.00	-23.98	Peak	VERTICAL
13750.00	45.50	39.61	43.16	11.00	52.95	74.00	-21.05	Peak	VERTICAL
17354.00	34.64	43.53	41.53	11.17	47.81	54.00	-6.19	Average	VERTICAL
17354.00	44.73	43.53	41.53	11.17	57.90	74.00	-16.10	Peak	VERTICAL
GFSK Tx mode 2480MHz									
4961.00	48.28	33.88	44.21	5.57	43.52	74.00	-30.48	Peak	HORIZONTAL
7443.00	44.73	35.87	43.33	6.68	43.95	74.00	-30.05	Peak	HORIZONTAL
9789.00	46.73	37.28	44.00	8.57	48.58	74.00	-25.42	Peak	HORIZONTAL
11234.00	46.44	38.02	43.76	9.02	49.72	74.00	-24.28	Peak	HORIZONTAL
13461.00	46.56	38.95	43.22	10.89	53.18	74.00	-20.82	Peak	HORIZONTAL
17541.00	34.14	43.77	41.43	11.38	47.86	54.00	-6.14	Average	HORIZONTAL
17541.00	43.32	43.77	41.43	11.38	57.04	74.00	-16.96	Peak	HORIZONTAL
4961.00	49.00	33.88	44.21	5.57	44.24	74.00	-29.76	Peak	VERTICAL
7443.00	44.21	35.87	43.33	6.68	43.43	74.00	-30.57	Peak	VERTICAL
8871.00	48.05	36.80	43.56	7.85	49.14	74.00	-24.86	Peak	VERTICAL
11744.00	46.45	38.30	43.62	9.07	50.20	74.00	-23.80	Peak	VERTICAL
13750.00	45.64	39.61	43.16	11.00	53.09	74.00	-20.91	Peak	VERTICAL
17541.00	34.12	43.77	41.43	11.38	47.84	54.00	-6.16	Average	VERTICAL
17541.00	43.72	43.77	41.43	11.38	57.44	74.00	-16.56	Peak	VERTICAL
Result: Pass									

Note: 1. Result Level = Read Level + Antenna Factor + Cable loss - PRM Factor.

2. For emissions above 1GHz. If peak results comply with AV limit, AV Result is deemed to comply with AV limit.

9. RF Conducted Spurious Emissions

9.1. Block diagram of test setup

Same as section 4.1

9.2. Limits

In any 100 kHz bandwidth outside the frequency bands in which the spread spectrum intentional radiator is operating, the radio frequency power that is produced by the intentional radiator shall be at least 20dB below that in the 100 kHz bandwidth within the band that contains the highest level of the desired power.

9.3. Test Procedure

(1) Connect EUT's antenna output to spectrum analyzer by RF cable.

(2) Establish a reference level by using the following procedure:

Center frequency	Test frequency
RBW:	100 kHz
VBW:	300 kHz
Span	Wide enough to capture the peak level of the in-band emission
Detector Mode:	Peak
Sweep time:	auto
Trace mode	Max hold

(3) Allow the trace to stabilize, use the peak marker function to determine the maximum peak power level to establish the reference level.

(4) Set the spectrum analyzer as follows:

RBW:	100 kHz
VBW:	300 kHz
Span	Encompass frequency range to be measured
Number of measurement points	$\geq \text{span}/\text{RBW}$
Detector Mode:	Peak
Sweep time:	auto
Trace mode	Max hold

(5) Allow the trace to stabilize, use the peak marker function to determine the maximum amplitude of all unwanted emissions outside of the authorized frequency band

9.4. Test Result

Mode	Freq. (MHz)	Conclusion
GFSK	2402	PASS
	2440	PASS
	2480	PASS

9.5. Original test data

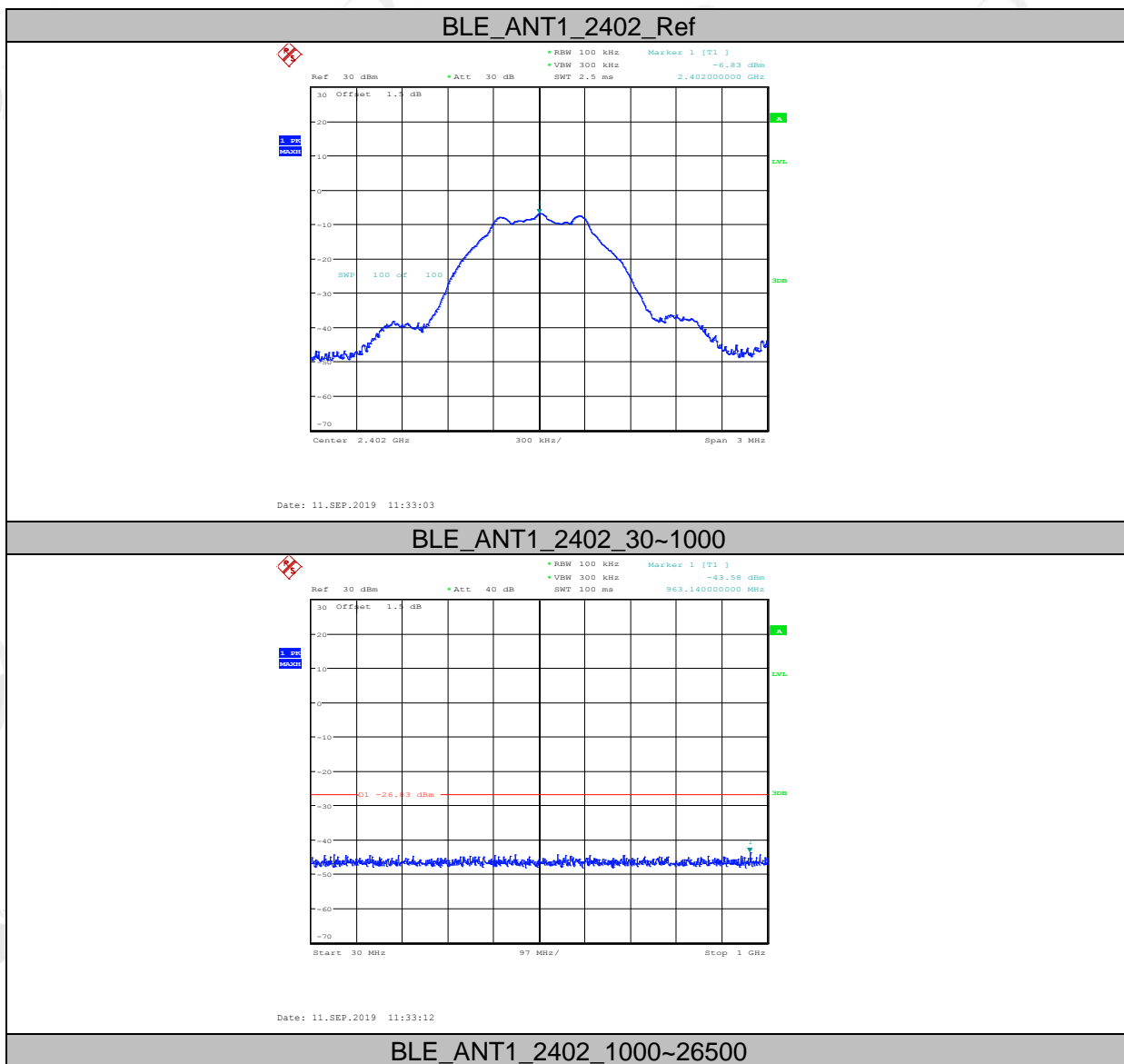

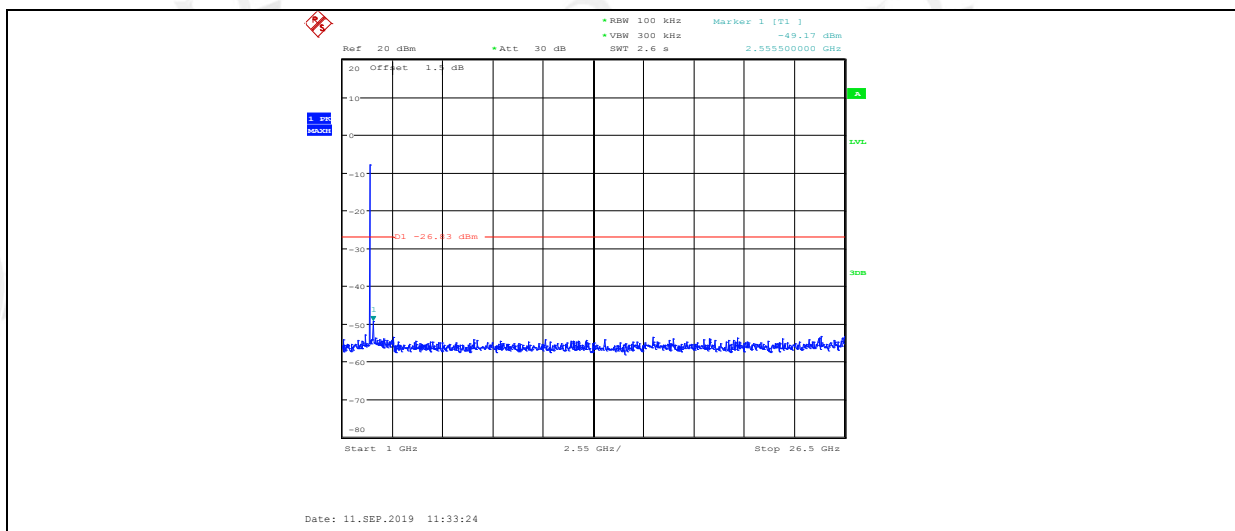

BLE_ANT1_2440_Ref

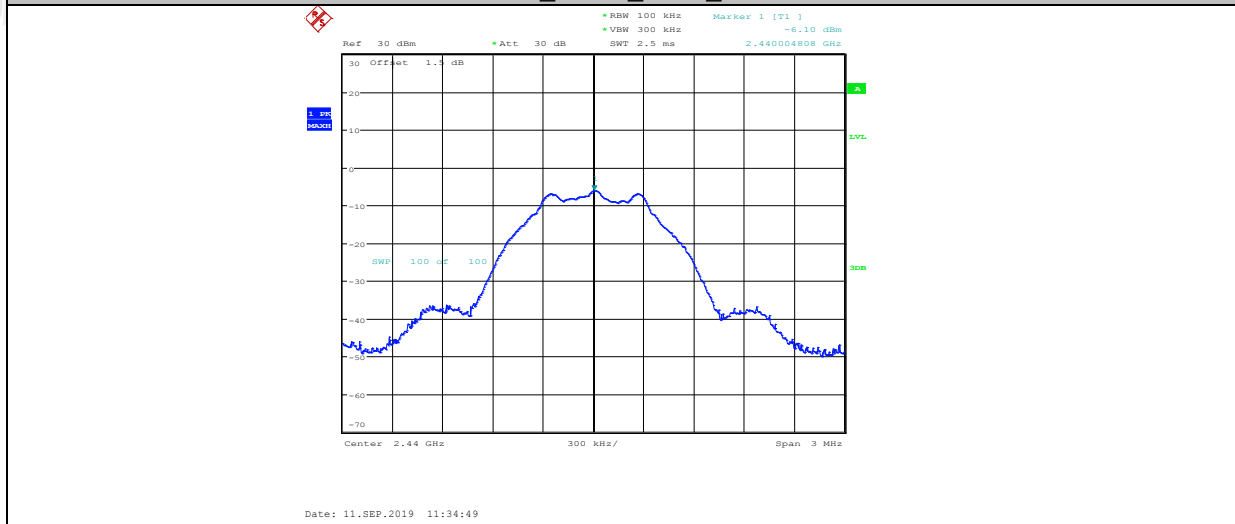

BLE_ANT1_2440_30~1000

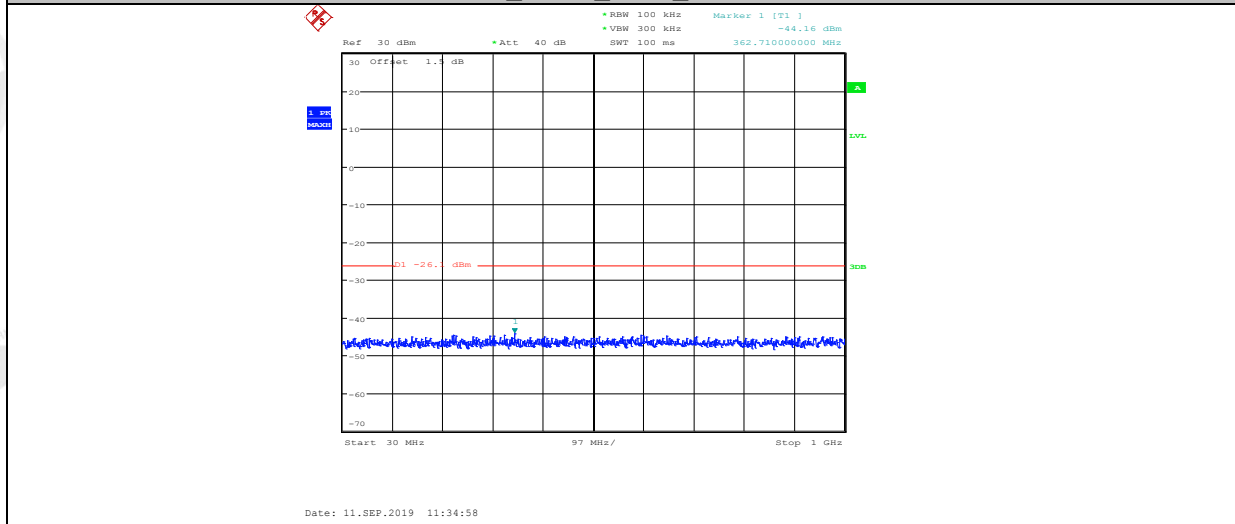

BLE_ANT1_2440_1000~26500

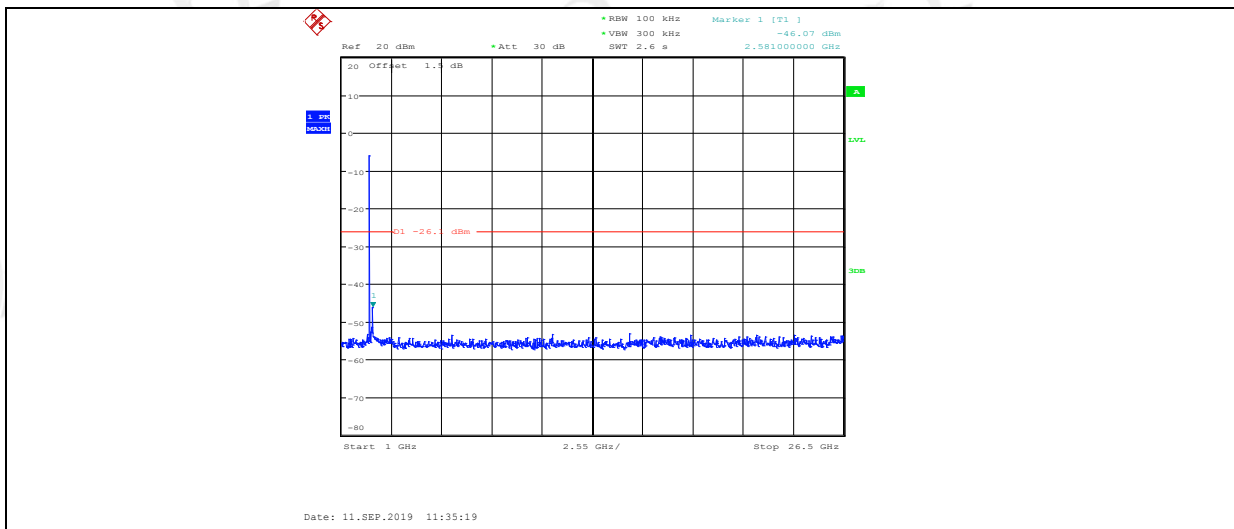

BLE_ANT1_2480_Ref

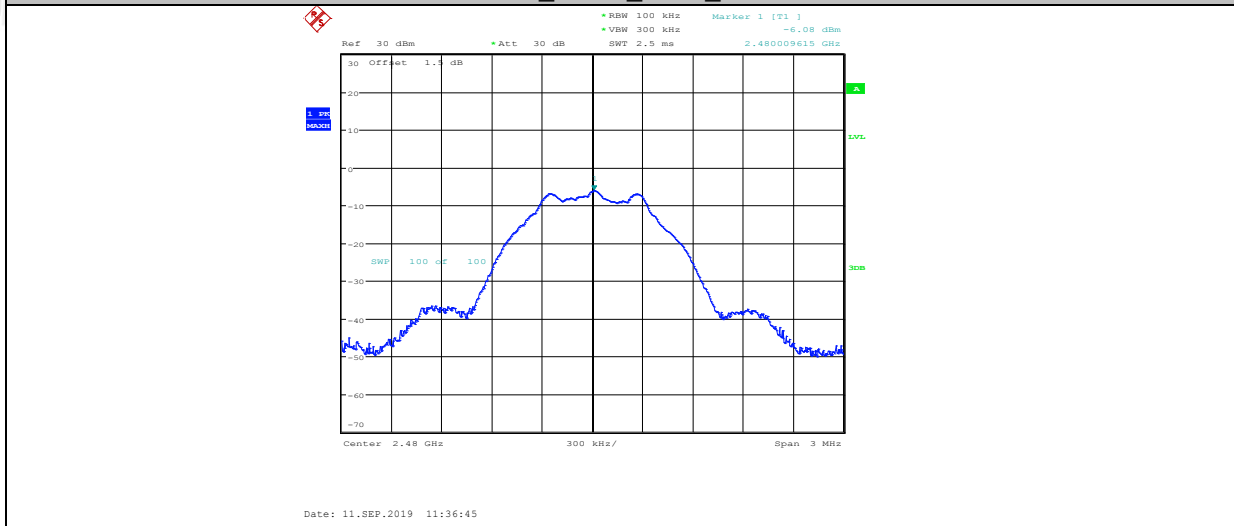

BLE_ANT1_2480_30~1000

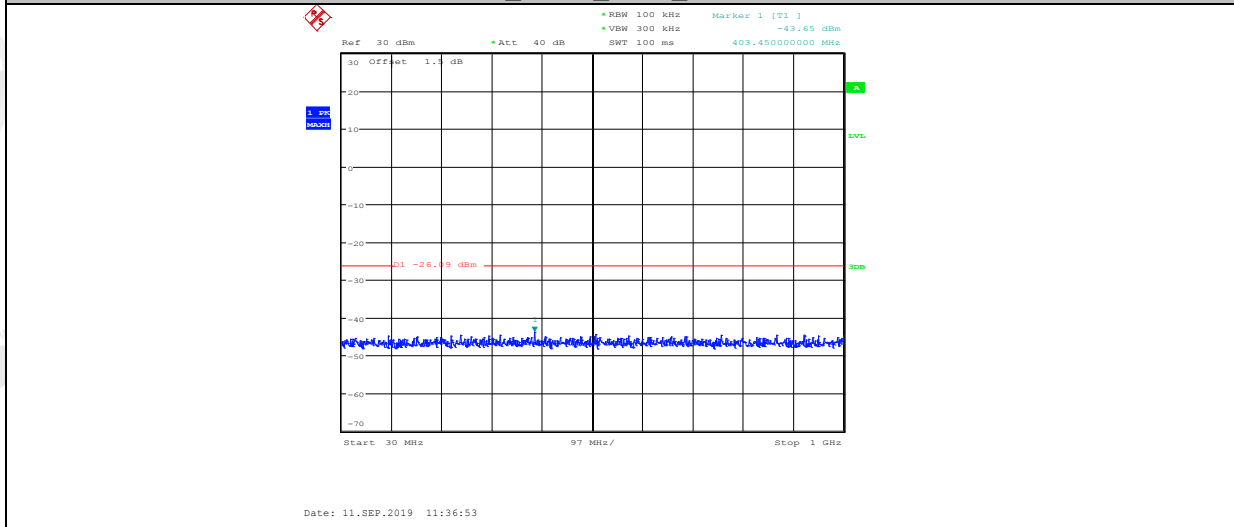

BLE_ANT1_2480_1000~26500

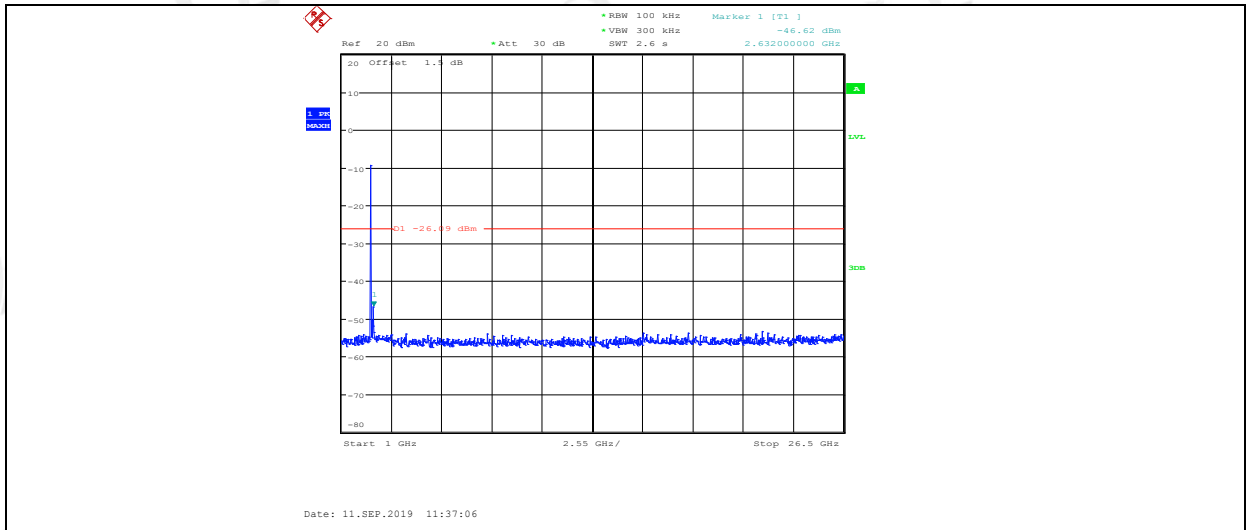

10. Emissions in restricted frequency bands

10.1. Block diagram of test setup

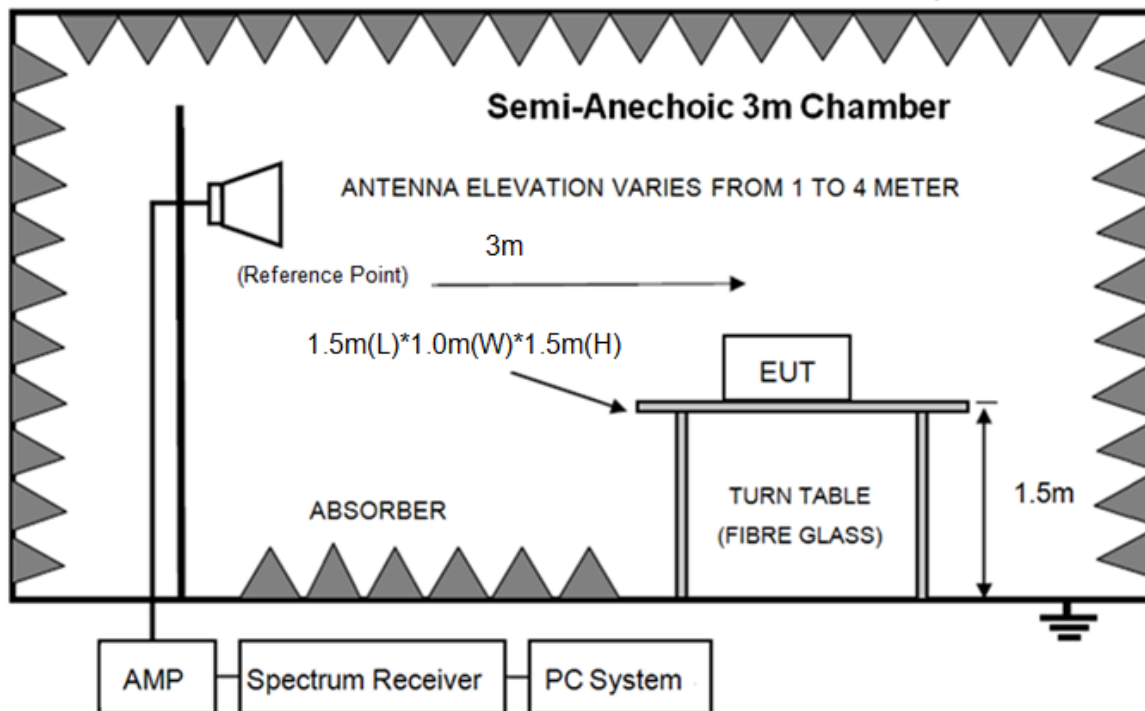

10.2. Limit

All restriction band should comply with 15.209, other emission should be at least 20dB below the fundamental.

10.3. Test Procedure

Same with clause 8.3 except change investigated frequency range from 2310 MHz to 2410 MHz and 2475 MHz to 2500 MHz.

Remark: All restriction band have been tested, and only the worst case is shown in report.

10.4. Test result

PASS. (See below detailed test result)

TR-4-E-009 Radiated Emission Test Result

Test Site : DDT 3m Chamber 1# **D:\2019 RE1# Report Data\Q19090702-1E PASSPORT\FCC ABOVE 1G.EM6**
Test Date : 2019-09-17 **Tested By** : Emily
EUT : Portable Audio Amplifier System **Model Number** : PASSPORT EVENT SERIES 2
Power Supply : AC 240V/60Hz **Test Mode** : Tx mode
Condition : Temp:24.5°C,Humi:55%,Press:100.1kPa **Antenna/Distance** : 2018 HF 907/3m/VERTICAL
Memo : BLE 2402

Data: 21

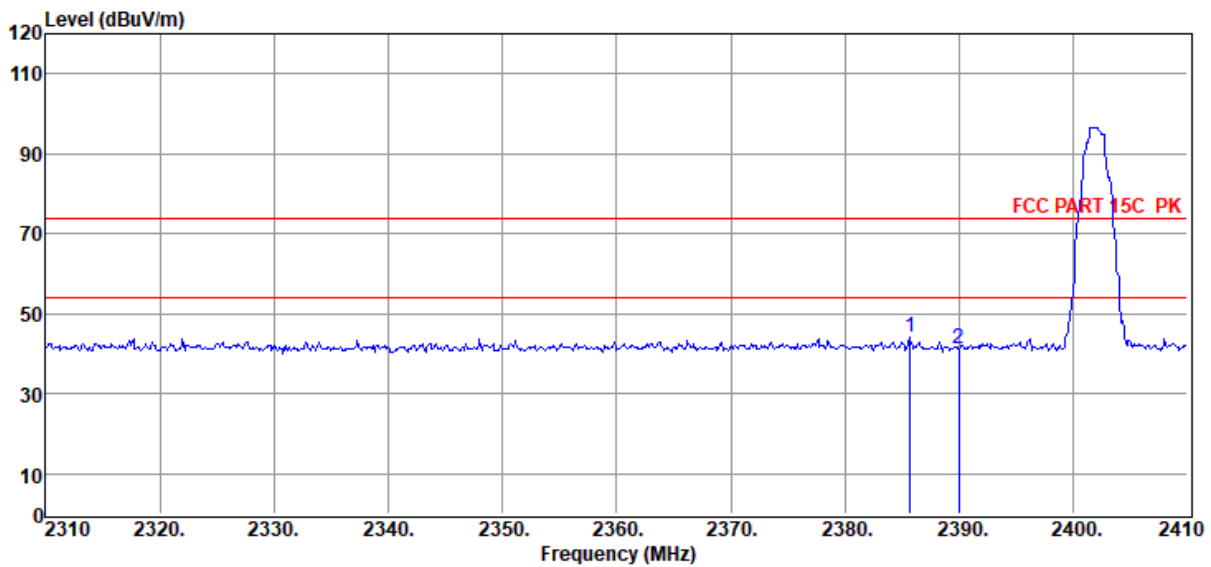

Item (Mark)	Freq. (MHz)	Read Level (dBμV)	Antenna Factor (dB/m)	PRM Factor (dB)	Cable Loss (dB)	Result Level (dBμV/m)	Limit Line (dBμV/m)	Over Limit (dB)	Detector	Polarization
1	2385.70	55.50	29.09	44.17	3.72	44.14	74.00	-29.86	Peak	VERTICAL
2	2390.00	52.54	29.10	44.18	3.73	41.19	74.00	-32.81	Peak	VERTICAL

Note: 1. Result Level = Read Level + Antenna Factor + Cable loss - PRM Factor.
 2. If Peak Result complies with AV limit, AV Result is deemed to comply with AV limit.
 3. Test setup: RBW: 1 MHz, VBW: 3 MHz, Sweep time: auto.

TR-4-E-009 Radiated Emission Test Result

Test Site : DDT 3m Chamber 1# **D:\2019 RE1# Report Data\Q19090702-1E PASSPORT\FCC ABOVE 1G.EM6**
Test Date : 2019-09-17 **Tested By** : Emily
EUT : Portable Audio Amplifier System **Model Number** : PASSPORT EVENT SERIES 2
Power Supply : AC 240V/60Hz **Test Mode** : Tx mode
Condition : Temp:24.5°C,Humi:55%,Press:100.1kPa **Antenna/Distance** : 2018 HF 907/3m/HORIZONTAL
Memo : BLE 2402

Data: 22

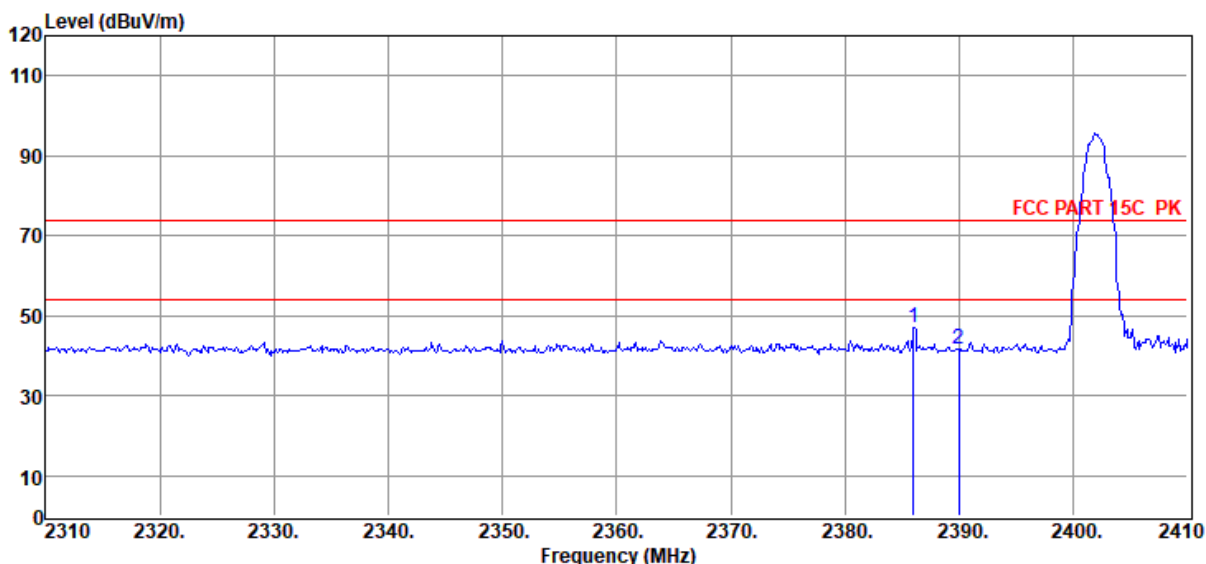

Item (Mark)	Freq. (MHz)	Read Level (dBμV)	Antenna Factor (dB/m)	PRM Factor (dB)	Cable Loss (dB)	Result Level (dBμV/m)	Limit Line (dBμV/m)	Over Limit (dB)	Detector	Polarization
1	2386.00	58.51	29.09	44.17	3.72	47.15	74.00	-26.85	Peak	HORIZONTAL
2	2390.00	53.06	29.10	44.18	3.73	41.71	74.00	-32.29	Peak	HORIZONTAL

Note: 1. Result Level = Read Level + Antenna Factor + Cable loss - PRM Factor.
 2. If Peak Result complies with AV limit, AV Result is deemed to comply with AV limit.
 3. Test setup: RBW: 1 MHz, VBW: 3 MHz, Sweep time: auto.

TR-4-E-009 Radiated Emission Test Result

Test Site : DDT 3m Chamber 1#

D:\2019 RE1# Report Data\Q19090702-1E PASSPORT\FCC ABOVE 1G.EM6

Test Date : 2019-09-17

Tested By : Emily

EUT : Portable Audio Amplifier System

Model Number : PASSPORT EVENT SERIES 2

Power Supply : AC 240V/60Hz

Test Mode : Tx mode

Condition : Temp:24.5°C,Humi:55%,Press:100.1kPa

Antenna/Distance : 2018 HF 907/3m/HORIZONTAL

Memo : BLE 2480

Data: 23

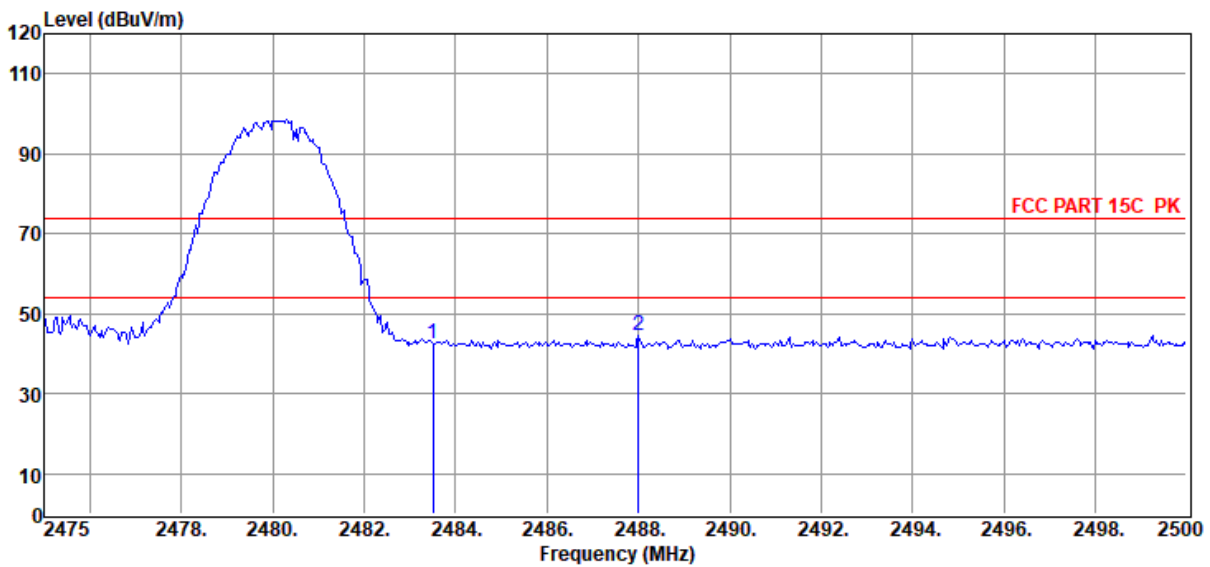

Item (Mark)	Freq. (MHz)	Read Level (dBμV)	Antenna Factor (dB/m)	PRM Factor (dB)	Cable Loss (dB)	Result Level (dBμV/m)	Limit Line (dBμV/m)	Over Limit (dB)	Detector	Polarization
1	2483.50	53.51	29.27	44.21	3.87	42.44	74.00	-31.56	Peak	HORIZONTAL
2	2488.00	55.60	29.28	44.22	3.87	44.53	74.00	-29.47	Peak	HORIZONTAL

- Note: 1. Result Level = Read Level + Antenna Factor + Cable loss - PRM Factor.
 2. If Peak Result complies with AV limit, AV Result is deemed to comply with AV limit.
 3. Test setup: RBW: 1 MHz, VBW: 3 MHz, Sweep time: auto.

TR-4-E-009 Radiated Emission Test Result

Test Site : DDT 3m Chamber 1# D:\2019 RE1# Report Data\Q19090702-1E PASSPORT\FCC ABOVE 1G.EM6
Test Date : 2019-09-17 **Tested By** : Emily
EUT : Portable Audio Amplifier System **Model Number** : PASSPORT EVENT SERIES 2
Power Supply : AC 240V/60Hz **Test Mode** : Tx mode
Condition : Temp:24.5°C,Humi:55%,Press:100.1kPa **Antenna/Distance** : 2018 HF 907/3m/VERTICAL
Memo : BLE 2480

Data: 24

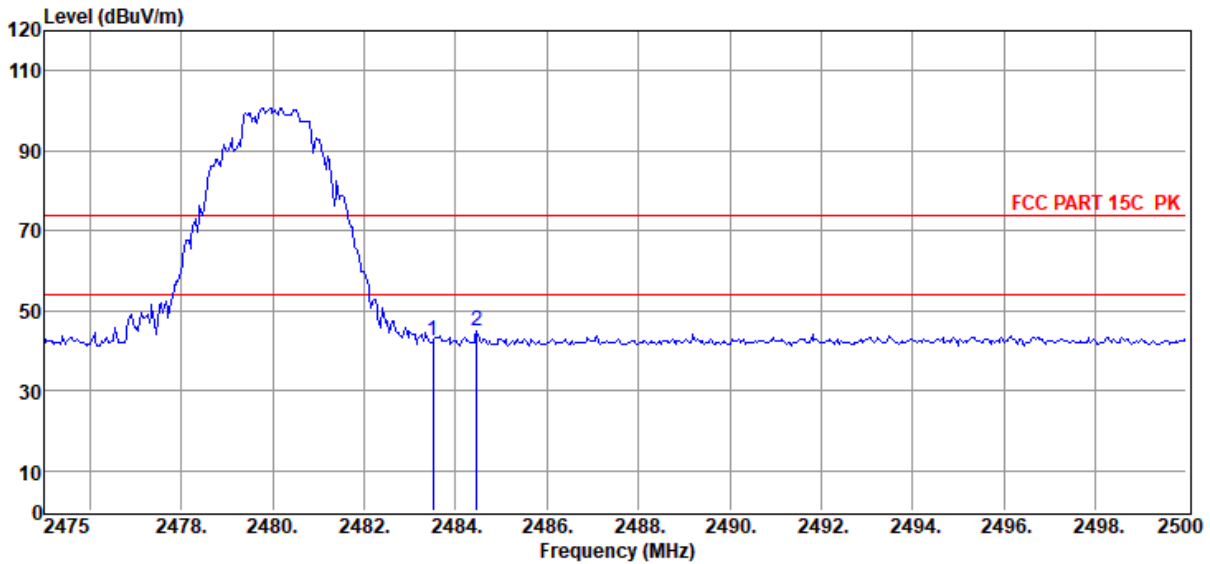

Item (Mark)	Freq. (MHz)	Read Level (dBμV)	Antenna Factor (dB/m)	PRM Factor (dB)	Cable Loss (dB)	Result Level (dBμV/m)	Limit Line (dBμV/m)	Over Limit (dB)	Detector	Polarization
1	2483.50	53.42	29.27	44.21	3.87	42.35	74.00	-31.65	Peak	VERTICAL
2	2484.46	55.90	29.27	44.21	3.87	44.83	74.00	-29.17	Peak	VERTICAL

Note: 1. Result Level = Read Level + Antenna Factor + Cable loss - PRM Factor.
 2. If Peak Result complies with AV limit, AV Result is deemed to comply with AV limit.
 3. Test setup: RBW: 1 MHz, VBW: 3 MHz, Sweep time: auto.

11. Power Line Conducted Emission

11.1. Block diagram of test setup

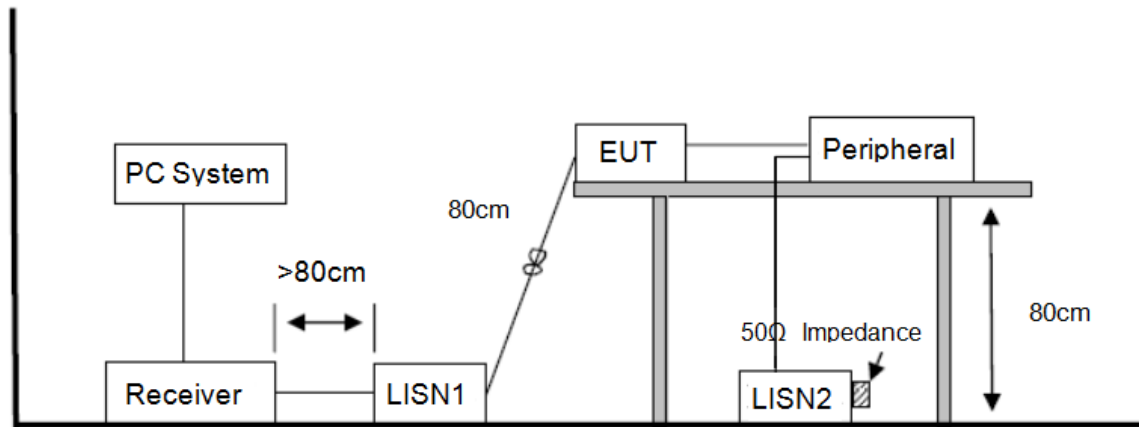

11.2. Power Line Conducted Emission Limits

Frequency	Quasi-Peak Level dB(μ V)	Average Level dB(μ V)
150 kHz ~ 500 kHz	66 ~ 56*	56 ~ 46*
500 kHz ~ 5 MHz	56	46
5 MHz ~ 30 MHz	60	50

Note 1: * Decreasing linearly with logarithm of frequency.

Note 2: The lower limit shall apply at the transition frequencies.

11.3. Test Procedure

The EUT and Support equipment, if needed, were put placed on a non-metallic table, 80cm above the ground plane.

Configuration EUT to simulate typical usage as described in clause 2.4 and test equipment as described in clause 10.2 of this report.

All I/O cables were positioned to simulate typical actual usage as per ANSI C63.10.

All support equipment power received from a second LISN.

Emissions were measured on each current carrying line of the EUT using an EMI Test Receiver connected to the LISN powering the EUT.

The Receiver scanned from 150 kHz to 30 MHz for emissions in each of the test modes.

During the above scans, the emissions were maximized by cable manipulation.

The test mode(s) described in clause 2.4 were scanned during the preliminary test.

After the preliminary scan, we found the test mode producing the highest emission level.

The EUT configuration and worse cable configuration of the above highest emission levels were recorded for reference of the final test.

EUT and support equipment were set up on the test bench as per the configuration with highest emission level in the preliminary test.

A scan was taken on both power lines, Neutral and Line, recording at least the six highest emissions.

Emission frequency and amplitude were recorded into a computer in which correction factors were used to calculate the emission level and compare reading to the applicable limit.

The test data of the worst-case condition(s) was recorded.

The bandwidth of test receiver is set at 9 kHz.

11.4. Test Result

PASS. (See below detailed test result)

Note1: All emissions not reported below are too low against the prescribed limits.

Note2: "----" means Peak detection; "-----" means Average detection

Note3: Pre-test AC conducted emission at both voltage AC 120V/60Hz and AC 240V/60Hz, recorded worse case.

TR-4-E-010 Conducted Emission Test Result

Test Site : DDT 1# Shield Room D:\2019 CE report data\Q19090702-1E\20190911 CE.EM6
Test Date : 2019-09-11 **Tested By** : Telamon
EUT : Portable Audio Amplifier System **Model Number** : PASSPORT EVENT SERIES 2
Power Supply : AC 120V/60Hz **Test Mode** : Tx mode
Condition : Temp:24.5°C,Humi:55%,Press:100.1kPa **LISN** : 2018 ENV216/LINE
Memo :

Data: 38

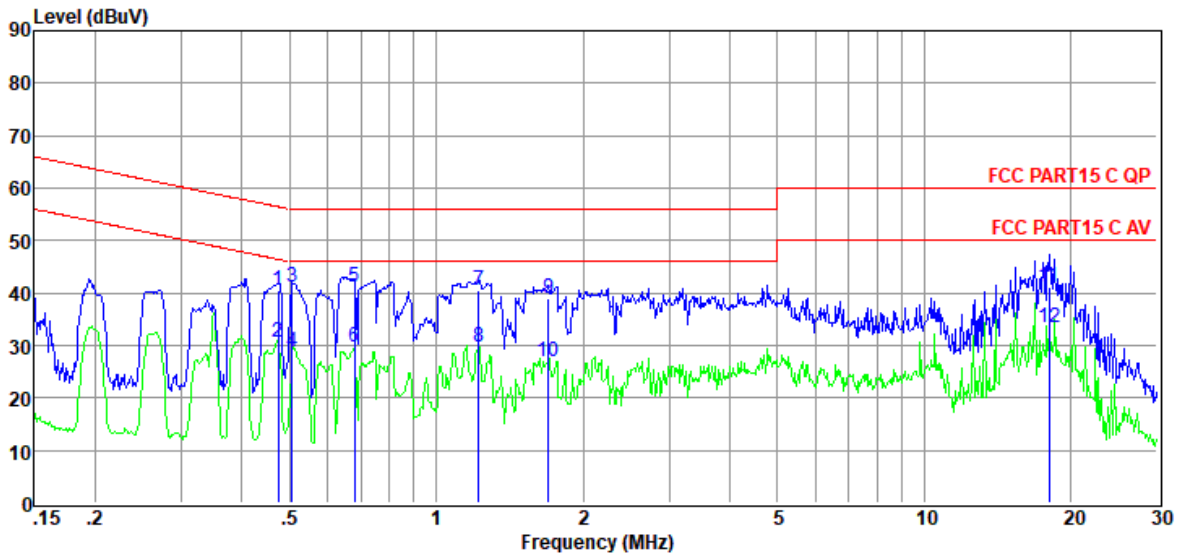

Item (Mark)	Freq. (MHz)	Read Level (dBμV)	LISN Factor (dB)	Cable Loss (dB)	Pulse Limiter Factor (dB)	Result Level (dBμV)	Limit Line (dBμV)	Over Limit (dB)	Detector	Phase
1	0.47	21.01	9.64	0.02	9.86	40.53	56.45	-15.92	QP	LINE
2	0.47	11.00	9.64	0.02	9.86	30.52	46.45	-15.93	Average	LINE
3	0.51	21.66	9.64	0.02	9.86	41.18	56.00	-14.82	QP	LINE
4	0.51	9.39	9.64	0.02	9.86	28.91	46.00	-17.09	Average	LINE
5	0.68	21.71	9.64	0.04	9.86	41.25	56.00	-14.75	QP	LINE
6	0.68	10.10	9.64	0.04	9.86	29.64	46.00	-16.36	Average	LINE
7	1.22	20.87	9.64	0.09	9.87	40.47	56.00	-15.53	QP	LINE
8	1.22	10.21	9.64	0.09	9.87	29.81	46.00	-16.19	Average	LINE
9	1.70	19.40	9.65	0.07	9.87	38.99	56.00	-17.01	QP	LINE
10	1.70	7.46	9.65	0.07	9.87	27.05	46.00	-18.95	Average	LINE
11	18.04	21.16	10.03	0.06	9.94	41.19	60.00	-18.81	QP	LINE
12	18.04	13.22	10.03	0.06	9.94	33.25	50.00	-16.75	Average	LINE

- Note: 1. Result Level = Read Level + LISN Factor + Pulse Limiter Factor + Cable loss.
 2. If QP Result complies with AV limit, AV Result is deemed to comply with AV limit.
 3. Test setup: RBW: 200 Hz (9 kHz—150 kHz), 9 kHz (150 kHz—30 MHz).
 4. Step size: 80Hz (0.009MHz-0.15MHz), 4 kHz (0.15MHz-30MHz), Scan time: auto.

TR-4-E-010 Conducted Emission Test Result

Test Site : DDT 1# Shield Room D:\2019 CE report data\Q19090702-1E\20190911 CE.EM6
Test Date : 2019-09-11 **Tested By** : Telamon
EUT : Portable Audio Amplifier System **Model Number** : PASSPORT EVENT SERIES 2
Power Supply : AC 120V/60Hz **Test Mode** : Tx mode
Condition : Temp:24.5°C,Humi:55%,Press:100.1kPa **LISN** : 2018 ENV216/NEUTRAL
Memo :

Data: 40

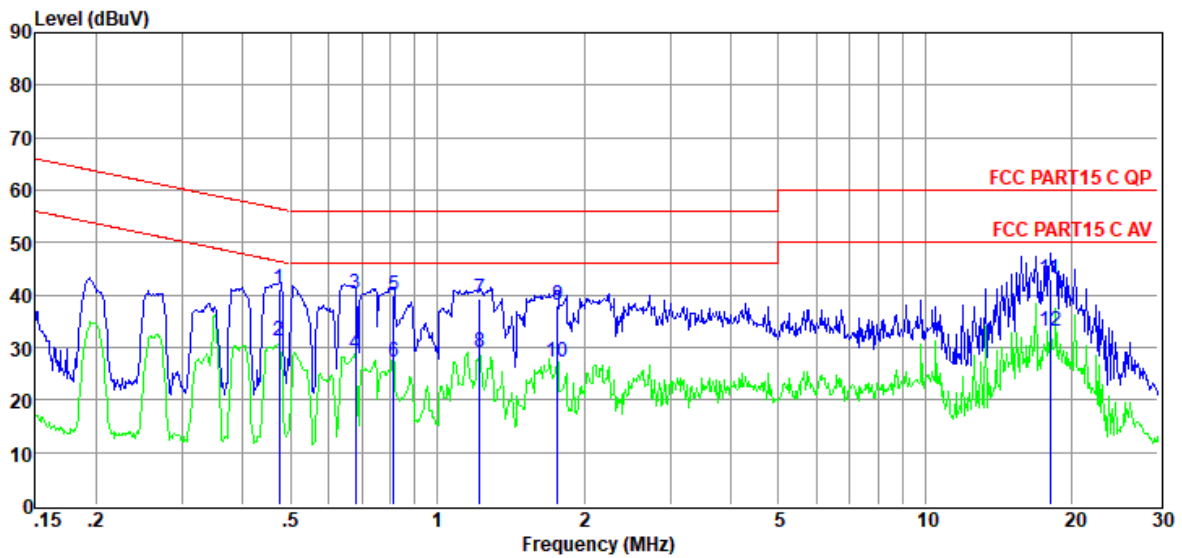

Item (Mark)	Freq. (MHz)	Read Level (dBμV)	LISN Factor (dB)	Cable Loss (dB)	Pulse Limiter Factor (dB)	Result Level (dBμV)	Limit Line (dBμV)	Over Limit (dB)	Detector	Phase
1	0.47	21.59	9.64	0.02	9.86	41.11	56.45	-15.34	QP	NEUTRAL
2	0.47	11.69	9.64	0.02	9.86	31.21	46.45	-15.24	Average	NEUTRAL
3	0.68	20.76	9.64	0.04	9.86	40.30	56.00	-15.70	QP	NEUTRAL
4	0.68	9.18	9.64	0.04	9.86	28.72	46.00	-17.28	Average	NEUTRAL
5	0.81	20.33	9.64	0.06	9.86	39.89	56.00	-16.11	QP	NEUTRAL
6	0.81	7.51	9.64	0.06	9.86	27.07	46.00	-18.93	Average	NEUTRAL
7	1.22	19.77	9.65	0.09	9.87	39.38	56.00	-16.62	QP	NEUTRAL
8	1.22	9.38	9.65	0.09	9.87	28.99	46.00	-17.01	Average	NEUTRAL
9	1.76	18.41	9.67	0.06	9.87	38.01	56.00	-17.99	QP	NEUTRAL
10	1.76	7.63	9.67	0.06	9.87	27.23	46.00	-18.77	Average	NEUTRAL
11	18.04	22.84	10.10	0.06	9.94	42.94	60.00	-17.06	QP	NEUTRAL
12	18.04	12.99	10.10	0.06	9.94	33.09	50.00	-16.91	Average	NEUTRAL

- Note: 1. Result Level = Read Level + LISN Factor + Pulse Limiter Factor + Cable loss.
 2. If QP Result complies with AV limit, AV Result is deemed to comply with AV limit.
 3. Test setup: RBW: 200 Hz (9 kHz—150 kHz), 9 kHz (150 kHz—30 MHz).
 4. Step size: 80Hz (0.009MHz-0.15MHz), 4 kHz (0.15MHz-30MHz), Scan time: auto.

12. Antenna Requirements

12.1. Limit

For intentional device, according to FCC 47 CFR Section 15.203, an intentional radiator shall be designed to ensure that no antenna other than that furnished by the responsible party shall be used with the device. And according to FCC 47 CFR Section 15.247 (b), if transmitting antennas of directional gain greater than 6dBi are used, the power shall be reduced by the amount in dB that the directional gain of the antenna exceeds 0.47 dBi.

12.2. Result

The antennas used for this product is integrated antenna and that no antenna other than that furnished by the responsible party shall be used with the device, the maximum peak gain of the transmit antenna is only -1.08 dBi.

END OF REPORT