

FCC AND ISED CERTIFICATION TEST REPORT

FOR

Applicant	:	Fender Musical Instruments
Address	:	17600 N. Perimeter Dr., Suite 100, Scottsdale, AZ 85255 USA
Equipment under Test	:	Portable Audio Amplifier System (W/BK32881)
Model No.	:	PASSPORT CONFERENCE SERIES 2
Type No.	:	PR 844
Trade Mark	:	FENDER
FCC ID	:	XQWPC2PR844BK
IC	:	8690A-PC2PR844BK
Manufacturer	:	Fender Musical Instruments
Address	:	17600 N. Perimeter Dr., Suite 100, Scottsdale, AZ 85255 USA

Issued By: Dongguan Dongdian Testing Service Co., Ltd.

Add.: No. 17, Zongbu Road 2, Songshan Lake Sci&Tech, Industry Park,
Dongguan City, Guangdong Province, China, 523808

Tel.: +86-0769-38826678, **E-mail:** ddt@dgddt.com, <http://www.dgddt.com>

REPORT

Table of Contents

	Test report declares.....	4
1.	Summary of Test Results.....	6
2.	General Test Information	7
2.1.	Description of EUT	7
2.2.	Accessories of EUT.....	8
2.3.	Assistant equipment used for test.....	8
2.4.	Block diagram of EUT configuration for test	8
2.5.	Deviations of test standard.....	8
2.6.	Test environment conditions	9
2.7.	Test laboratory	9
2.8.	Measurement uncertainty.....	9
3.	Equipment Used During Test.....	10
4.	Maximum Peak Output Power	11
4.1.	Block diagram of test setup.....	11
4.2.	Limits	11
4.3.	Test procedure	11
4.4.	Test result.....	12
4.5.	Original test data	12
5.	20 dB Bandwidth and 99% Bandwidth.....	16
5.1.	Block diagram of test setup.....	16
5.2.	Limits	16
5.3.	Test procedure	16
5.4.	Test result.....	16
5.5.	Original test data	17
6.	Carrier Frequency Separation.....	23
6.1.	Block diagram of test setup.....	23
6.2.	Limits	23
6.3.	Test procedure	23
6.4.	Test result.....	23
6.5.	Original test data	24
7.	Number of Hopping Channel	25
7.1.	Block diagram of test setup.....	25
7.2.	Limits	25
7.3.	Test procedure	25
7.4.	Test result.....	25
7.5.	Original test data	26
8.	Dwell Time.....	27

8.1.	Block diagram of test setup.....	27
8.2.	Limits	27
8.3.	Test procedure	27
8.4.	Test result.....	27
8.5.	Original test data	28
9.	Band Edge Compliance (Conducted Method)	34
9.1.	Block diagram of test setup.....	34
9.2.	Limit.....	34
9.3.	Test procedure	34
9.4.	Test result.....	34
9.5.	Original test data	35
10.	Radiated Emission	39
10.1.	Block diagram of test setup.....	39
10.2.	Limit.....	40
10.3.	Test Procedure.....	42
10.4.	Test result.....	43
11.	RF Conducted Spurious Emissions	52
11.1.	Block diagram of test setup.....	52
11.2.	Limits	52
11.3.	Test procedure	52
11.4.	Test result.....	53
11.5.	Original test data	53
12.	Band Edge Compliance (Radiated Method)	63
12.1.	Block diagram of test setup.....	63
12.2.	Limit.....	63
12.3.	Test Procedure.....	63
12.4.	Test result.....	63
13.	Power Line Conducted Emission	76
13.1.	Block diagram of test setup.....	76
13.2.	Power Line Conducted Emission Limits	76
13.3.	Test Procedure.....	76
13.4.	Test Result	77
14.	Antenna Requirements	80
1.1.	Limit.....	80
1.2.	Result	80
15.	Test Setup Photograph	81
16.	Photos of the EUT.....	83

Test Report Declare

Applicant	:	Fender Musical Instruments
Address	:	17600 N. Perimeter Dr., Suite 100, Scottsdale, AZ 85255 USA
Equipment under Test	:	Portable Audio Amplifier System (W/BK32881)
Model No.	:	PASSPORT CONFERENCE SERIES 2
Type No.	:	PR 844
Trade Mark	:	FENDER
Manufacturer	:	Fender Musical Instruments
Address	:	17600 N. Perimeter Dr., Suite 100, Scottsdale, AZ 85255 USA

Test Standard Used:

FCC Rules and Regulations Part 15 Subpart C, RSS-247 Issue 2 February 2017

Test Procedure Used:

ANSI C63.10:2013, RSS-Gen Issue 5, Apr. 2018, Amendment 2 (February 2021)

We Declare:

The equipment described above is tested by Dongguan Dongdian Testing Service Co., Ltd. and in the configuration tested the equipment complied with the standards specified above. The test results are contained in this test report and Dongguan Dongdian Testing Service Co., Ltd. is assumed of full responsibility for the accuracy and completeness of these tests.

After test and evaluation, our opinion is that the equipment provided for test compliance with the requirement of the above FCC&ISED standards.

Report No.:	DDT-R22102518-2E01		
Date of Receipt:	Nov. 03, 2022	Date of Test:	Nov. 03, 2022 ~ Dec. 10, 2022

Prepared By:

Jacky Huang
Jacky Huang/Engineer

Approved By:



Damon Hu/EMC Manager

Note: This report applies to above tested sample only. This report shall not be reproduced in parts without written approval of Dongguan Dongdian Testing Service Co., Ltd.

Revision History

Rev.	Revisions	Issue Date	Revised By
---	Initial issue	Dec. 12, 2022	

1. Summary of Test Results

Description of Test Item	Standard	Results
Maximum Peak Output Power	FCC Part 15: 15.247(b)(1) ANSI C63.10:2013 RSS-247 Issue 2	Pass
20 dB Bandwidth and 99% Bandwidth	FCC Part 15: 15.247(a)(1) ANSI C63.10:2013 RSS-Gen 6.7	Pass
Carrier Frequency Separation	FCC Part 15: 15.247(a)(1) ANSI C63.10:2013 RSS-247 Issue 2	Pass
Number of Hopping Channel	FCC Part 15: 15.247(a)(1)(iii) ANSI C63.10:2013 RSS-247 Issue 2	Pass
Dwell Time	FCC Part 15: 15.247(a)(1)(iii) ANSI C63.10:2013 RSS-247 Issue 2	Pass
Radiated Emission	FCC Part 15: 15.209 FCC Part 15: 15.247(d) ANSI C63.10:2013 RSS-247 Issue 2 RSS-Gen Issue 5	Pass
Band Edge Compliance	FCC Part 15: 15.247(d) ANSI C63.10:2013 RSS-247 Issue 2 RSS-Gen Issue 5	Pass
Power Line Conducted Emissions	FCC Part 15: 15.207 ANSI C63.10:2013 RSS-Gen Issue 5	Pass
Antenna Requirement	FCC Part 15: 15.203 RSS-Gen Issue 5	Pass

2. General Test Information

2.1. Description of EUT

EUT* Name	: Portable Audio Amplifier System (W/BK32881)
Model Number	: PASSPORT CONFERENCE SERIES 2
EUT Function Description	: Please reference user manual of this device
Power Supply	: AC 100-120V, 50/60Hz
Radio Specification	: Bluetooth V5.2
Operation Frequency	: 2402 MHz - 2480 MHz
Modulation	: GFSK, $\pi/4$ -DQPSK, 8DPSK
Data Rate	: 1 Mbps, 2 Mbps, 3 Mbps
Antenna Type	: FPC antenna, maximum PK gain: -4.49 dBi
Sample Number	: S22102518-06

Note: EUT is the ab. of equipment under test.

Channel information					
Channel	Frequency (MHz)	Channel	Frequency (MHz)	Channel	Frequency (MHz)
0	2402	27	2429	54	2456
1	2403	28	2430	55	2457
2	2404	29	2431	56	2458
3	2405	30	2432	57	2459
4	2406	31	2433	58	2460
5	2407	32	2434	59	2461
6	2408	33	2435	60	2462
7	2409	34	2436	61	2463
8	2410	35	2437	62	2464
9	2411	36	2438	63	2465
10	2412	37	2439	64	2466
11	2413	38	2440	65	2467
12	2414	39	2441	66	2468
13	2415	40	2442	67	2469
14	2416	41	2443	68	2470
15	2417	42	2444	69	2471
16	2418	43	2445	70	2472
17	2419	44	2446	71	2473
18	2420	45	2447	72	2474
19	2421	46	2448	73	2475
20	2422	47	2449	74	2476
21	2423	48	2450	75	2477
22	2424	49	2451	76	2478
23	2425	50	2452	77	2479
24	2426	51	2453	78	2480
25	2427	52	2454		
26	2428	53	2455		

2.2. Accessories of EUT

Description of Accessories	Manufacturer	Model number	Serial No.	Other
AC cable	N/A	N/A	N/A	Length: 1.90m, unshielded
Audio cable	N/A	N/A	N/A	Length: 4.90m, unshielded
Audio cable	N/A	N/A	N/A	Length: 4.90m, unshielded

2.3. Assistant equipment used for test

Assistant equipment	Manufacturer	Model number	Serial No.	other
N/A	N/A	N/A	N/A	N/A

2.4. Block diagram of EUT configuration for test



The pathloss of external cable: 0.5 dB (According to the manufacturer's claims)

Test software: BK32xx RF Test_V1.8.2

The test software was used to control EUT work in Continuous Tx mode, and select test channel, wireless mode as below table.

Tested mode, channel, information			
Mode	Setting Tx Power	Channel	Frequency (MHz)
GFSK hopping on Tx mode	0	CH0 to CH78	2402 to 2480
$\pi/4$ -DQPSK hopping on Tx mode	0	CH0 to CH78	2402 to 2480
8DPSK hopping on Tx mode	0	CH0 to CH78	2402 to 2480
GFSK hopping off Tx mode	0	CH0	2402
	0	CH39	2441
	0	CH78	2480
$\pi/4$ -DQPSK hopping off Tx mode	0	CH0	2402
	0	CH39	2441
	0	CH78	2480
8DPSK hopping on Tx mode	0	CH0	2402
	0	CH39	2441
	0	CH78	2480

2.5. Deviations of test standard

No deviation.

2.6. Test environment conditions

During the measurement the environmental conditions were within the listed ranges:

Temperature range:	+15°C to +35 °C
Humidity range:	20-75%
Pressure range:	86-106 kPa

2.7. Test laboratory

Dongguan Dongdian Testing Service Co., Ltd.

Add.: No. 17, Zongbu Road 2, Songshan Lake Sci&Tech, Industry Park, Dongguan City, Guangdong Province, China, 523808.

Tel.: +86-0769-38826678, <http://www.dgddt.com>, Email: ddt@dgddt.com.

CNAS Accreditation No. L6451; A2LA Accreditation Number: 3870.01

FCC Designation Number: CN1182, Test Firm Registration Number: 540522

Innovation, Science and Economic Development Canada Site Registration Number: 10288A

Conformity Assessment Body identifier: CN0048

VCCI facility registration number: C-20087, T-20088, R-20123, R-20155, G-20118

2.8. Measurement uncertainty

Test Item	Uncertainty
Bandwidth	1.1%
Peak Output Power (Conducted) (Spectrum Analyzer)	0.86 dB (10 MHz ≤ f < 3.6 GHz);
	1.38 dB (3.6 GHz ≤ f < 8 GHz)
Peak Output Power (Conducted) (Power Sensor)	0.74 dB
Power Spectral Density	0.74 dB (10 MHz ≤ f < 3.6 GHz);
	1.38 dB (3.6 GHz ≤ f < 8 GHz)
Frequencies Stability	6.7 x 10 ⁻⁸ (Antenna couple method)
	5.5 x 10 ⁻⁸ (Conducted method)
Conducted Spurious Emissions	0.86 dB (10 MHz ≤ f < 3.6 GHz);
	1.40 dB (3.6 GHz ≤ f < 8 GHz)
	1.66 dB (8 GHz ≤ f < 26.5 GHz)
Uncertainty for Radio Frequency (RBW<20 KHz)	3x10 ⁻⁸
Temperature	0.4 °C
Humidity	2 %
Uncertainty for Radiation Emission Test (9kHz -30 Mhz)	3.44 dB
Uncertainty for Radiation Emission Test (30 Mhz-1 Ghz)	4.70 dB (Antenna Polarize: V)
	4.84 dB (Antenna Polarize: H)
Uncertainty for Radiation Emission Test (1 Ghz-40 Ghz)	4.10 dB (1-6 GHz)
	4.40 dB (6 GHz-18 GHz)
	3.54 dB (18 GHz-26 GHz)
	4.30 dB (26 GHz-40 GHz)
Uncertainty for Power Line Conduction Emission Test	3.32 dB (150 kHz-30 MHz)

Note: This uncertainty represents an expanded uncertainty expressed at approximately the 95% confidence level using a coverage factor of k=2.

3. Equipment Used During Test

Equipment	Manufacturer	Model No.	Serial No.	Last Cal.	Cal. Interval
☑RF Connected Test (Tonscend RF Measurement System 3#)					
SPECTRUM ANALYZER	R&S	FSV40	101407	Jul. 21, 2022	1 Year
Wideband Radio Communication tester	R&S	CMW500	117491	May 18, 2022	1 Year
Vector Signal Generator	Agilent	N5182A	MY19060405	May 18, 2022	1 Year
Vector Signal Generator	Agilent	N5182A	MY48180912	May 18, 2022	1 Year
RF Control Unit	Tonscend	JS0806-2	DDT-ZC01449	May 18, 2022	1 Year
Temp&Humi Programmable	ZHIXIANG	ZXGDJS-150L	ZX170110-A	May 26, 2022	1 Year
Test Software	JS Tonscend	JS1120-3	Ver.2.6.77.0518	N/A	N/A
☑Radiation 3#chamber					
EMI Test Receiver	R&S	ESU	100472	May 18, 2022	1 Year
Spectrum analyzer	Agilent	E4447A	MY50180031	May 18, 2022	1 Year
Active Loop antenna	Schwarzbeck	FMZB-1519	1519-038	Sep. 29, 2022	1 Year
Trilog Broadband Antenna	Schwarzbeck	VULB 9163	01429	Jul. 22, 2022	1 Year
Double Ridged Horn Antenna	Schwarzbeck	BBHA 9120 D	02468	Sep. 29, 2022	1 Year
Broad Band Horn Antenna	Schwarzbeck	BBHA 9170	790	May 06, 2022	1 Year
Pre-amplifier	COM-POWER	PAM-118A	18040084	Aug. 17, 2022	1 Year
Pre-amplifier	COM-POWER	PAM-840A	461369	Apr. 11, 2022	1 Year
RE Cable	N/A	W23.02 CP1-X2 + W23.09 AP1-X8+ JCT26S-NJ-NJ -1.5M+ JCT26S-NJ-NJ -1.5M	4.5M+8M+1.5M +1.5M	Aug.17, 2022	1 Year
RF Cable	Yuhu Technology	JCTB810-NJ-NJ-9M	21123964	May. 19,2022	1 Year
RF Cable	Yuhu Technology	ZT26S-SMAJ-SMAJ-1M	21073466	Aug.17, 2022	1 Year
Test software	Tonscend	JS32-RE	V 5.0.0.1	N/A	N/A
Test software	Audix	E3	V 6.1.1.1	N/A	N/A
☑Power Line Conducted Emissions Test 1#					
Test Receiver	R&S	ESCI	100551	Aug. 26, 2022	1 Year
LISN 1	R&S	ENV216	101109	Aug. 26, 2022	1 Year
LISN 2	R&S	ESH2-Z5	100309	Aug. 26, 2022	1 Year
Pulse Limiter	R&S	ESH3-Z2	101242	Aug. 26, 2022	1 Year
CE Cable 1	HUBSER	N/A	W10.01	Aug. 26, 2022	1 Year
Test software	Audix	E3	V 6.11111b	N/A	N/A

4. Maximum Peak Output Power

4.1. Block diagram of test setup

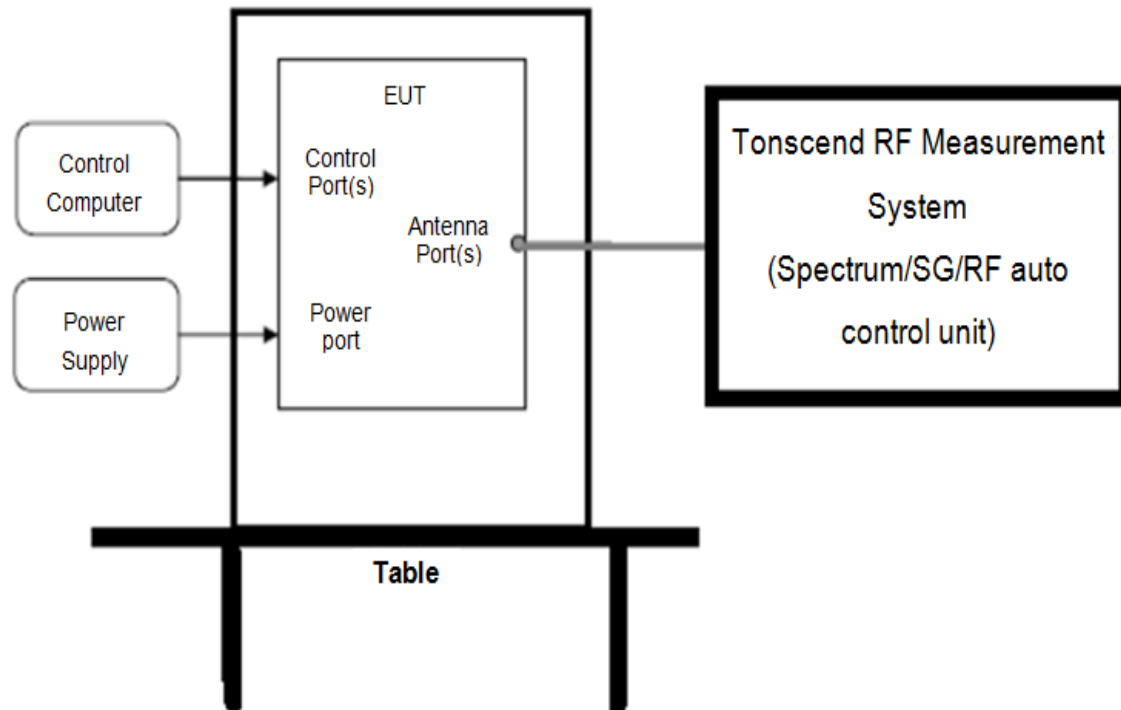

4.2. Limits

For frequency hopping systems operating in the 2400-2483.5 MHz band employing at least 75 non-overlapping hopping channels, and all frequency hopping systems in the 5725-5850 MHz band: 1 watt. For all other frequency hopping systems in the 2400-2483.5 MHz band: 0.125 watts, the e.i.r.p shall not exceed 4W.

4.3. Test procedure

- (1) Connect EUT's antenna output to spectrum analyzer by RF cable.
- (2) Measure the maximum conducted output power of EUT by spectrum analyzer with PK detector and RBW=3 MHz (above 20 dB bandwidth of measured signal), VBW=10 MHz

Note:

- 1.The attenuator loss was inputted into spectrum analyzer as amplitude offset.
- 2.The pathloss of external cable: 0.5dB (According to the manufacturer's claims).

4.4. Test result

Test Mode	Antenna	Frequency [MHz]	Conducted Peak Power [dBm]	Conducted Limit [dBm]	Verdict
GFSK	Ant1	2402	-13.34	≤21	Pass
		2441	-13.65	≤21	Pass
		2480	-13.15	≤21	Pass
π/4-DQPSK	Ant1	2402	-13.45	≤21	Pass
		2441	-13.84	≤21	Pass
		2480	-13.32	≤21	Pass
8DPSK	Ant1	2402	-13.45	≤21	Pass
		2441	-13.82	≤21	Pass
		2480	-13.31	≤21	Pass

Test Mode	Antenna	Frequency (MHz)	EIRP (dBm)	Limit (dBm)	Verdict
GFSK	ANT1	2402	-17.83	≤36	Pass
	ANT1	2441	-18.14	≤36	Pass
	ANT1	2480	-17.64	≤36	Pass
π/4-DQPSK	ANT1	2402	-17.94	≤36	Pass
	ANT1	2441	-18.33	≤36	Pass
	ANT1	2480	-17.81	≤36	Pass
8DPSK	ANT1	2402	-17.94	≤36	Pass
	ANT1	2441	-18.31	≤36	Pass
	ANT1	2480	-17.80	≤36	Pass

Note: EIRP (dBm)=Conducted Output Power (dBm)+ Antenna Gain (dBi)

4.5. Original test data

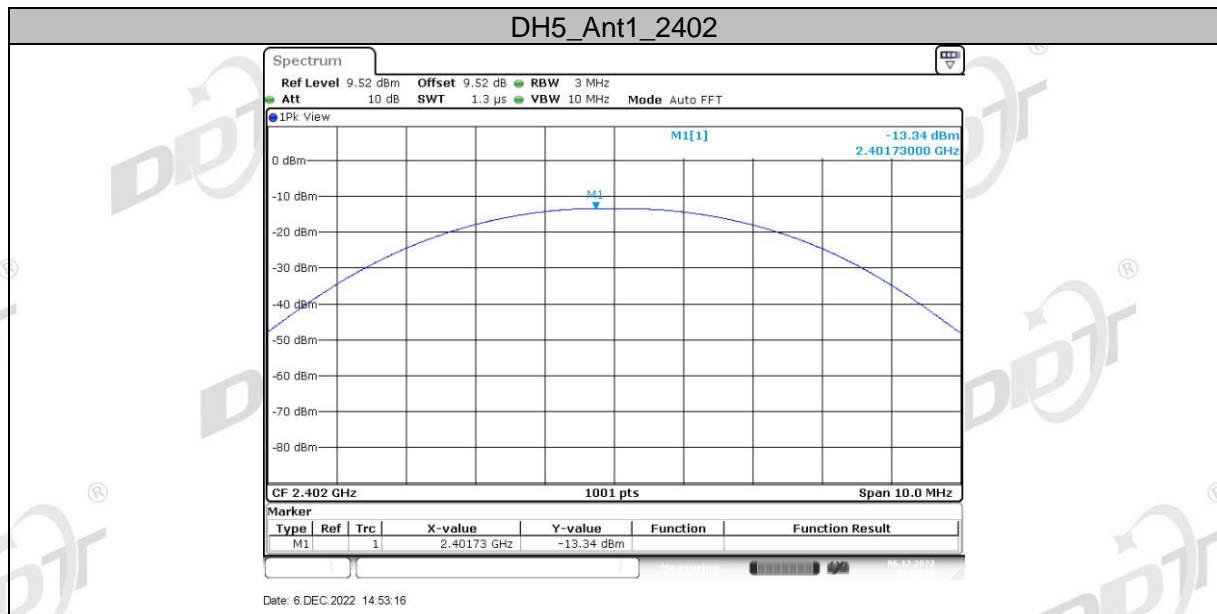

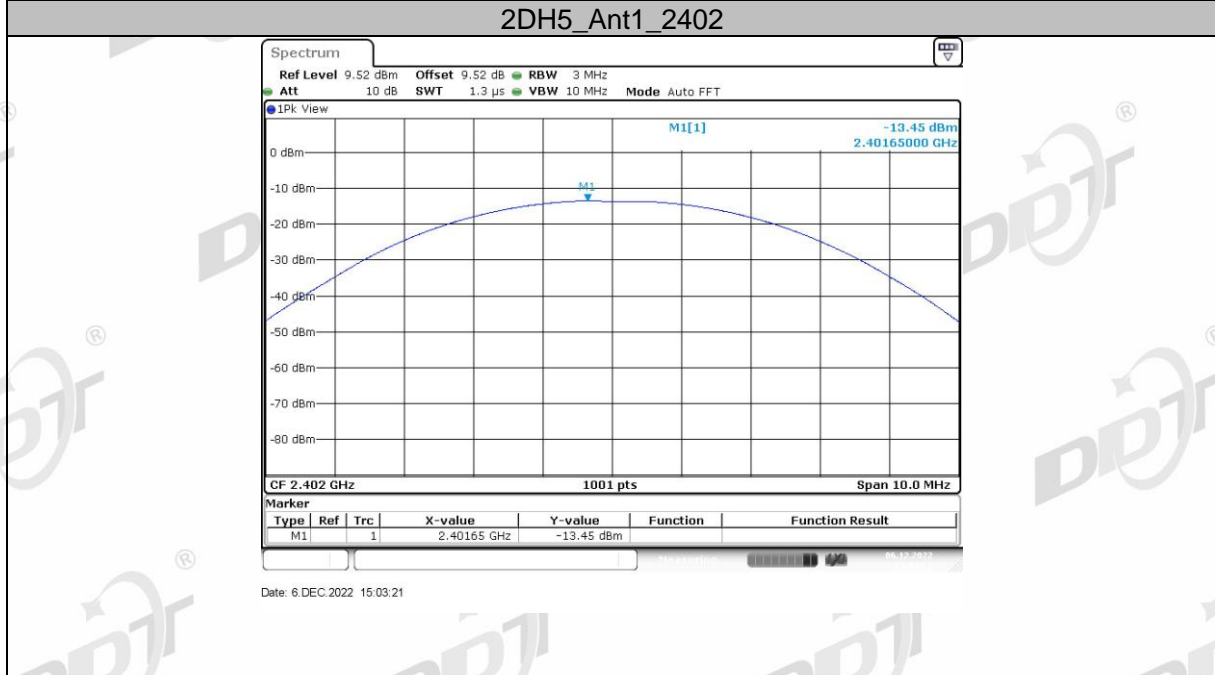
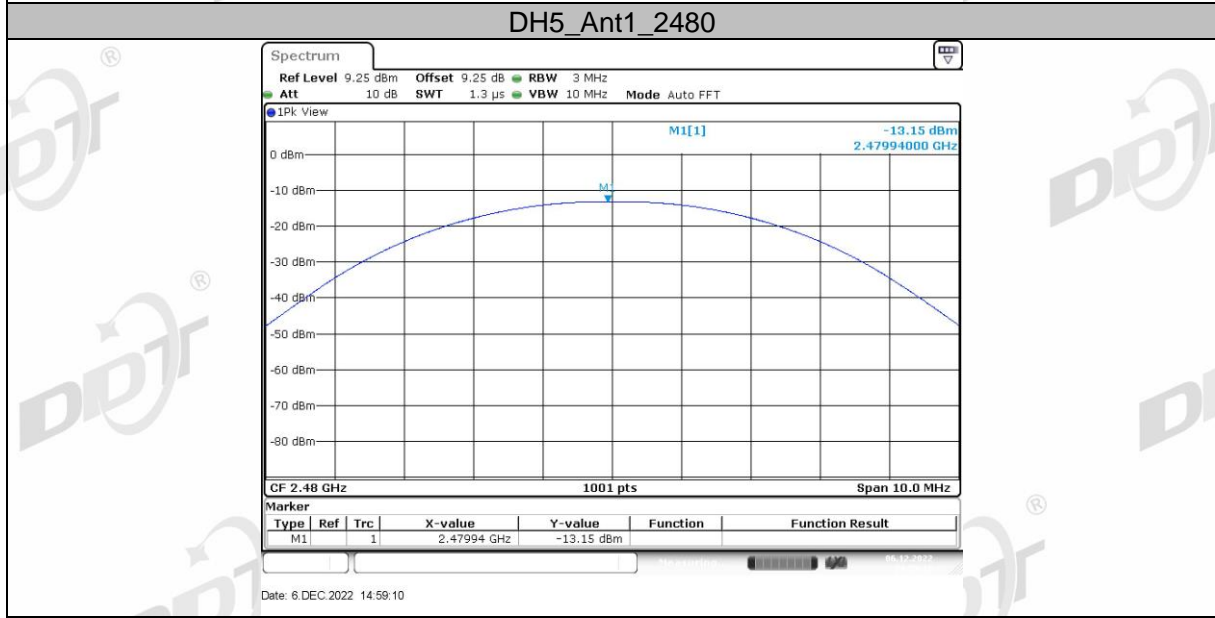
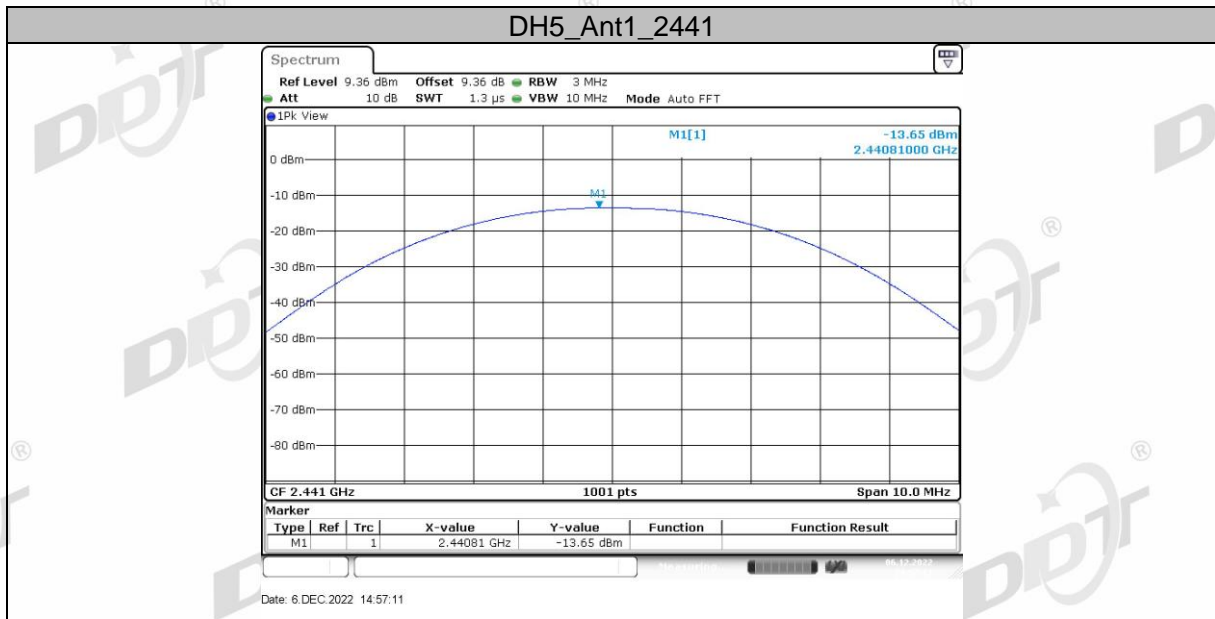

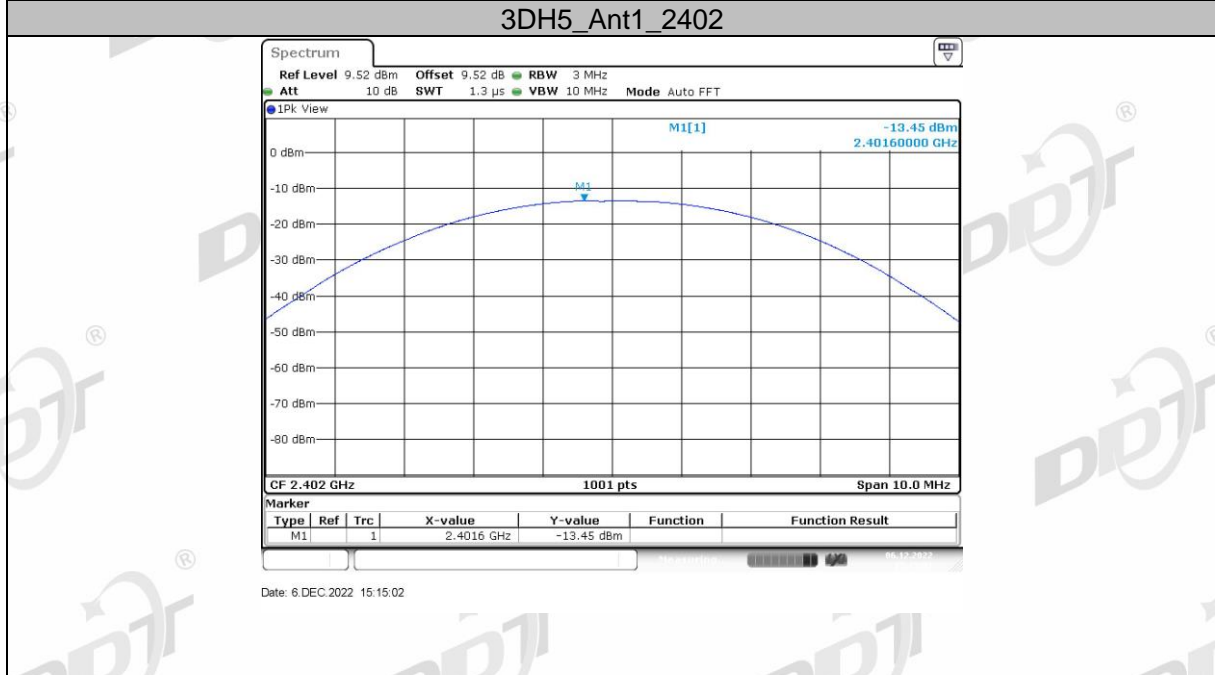
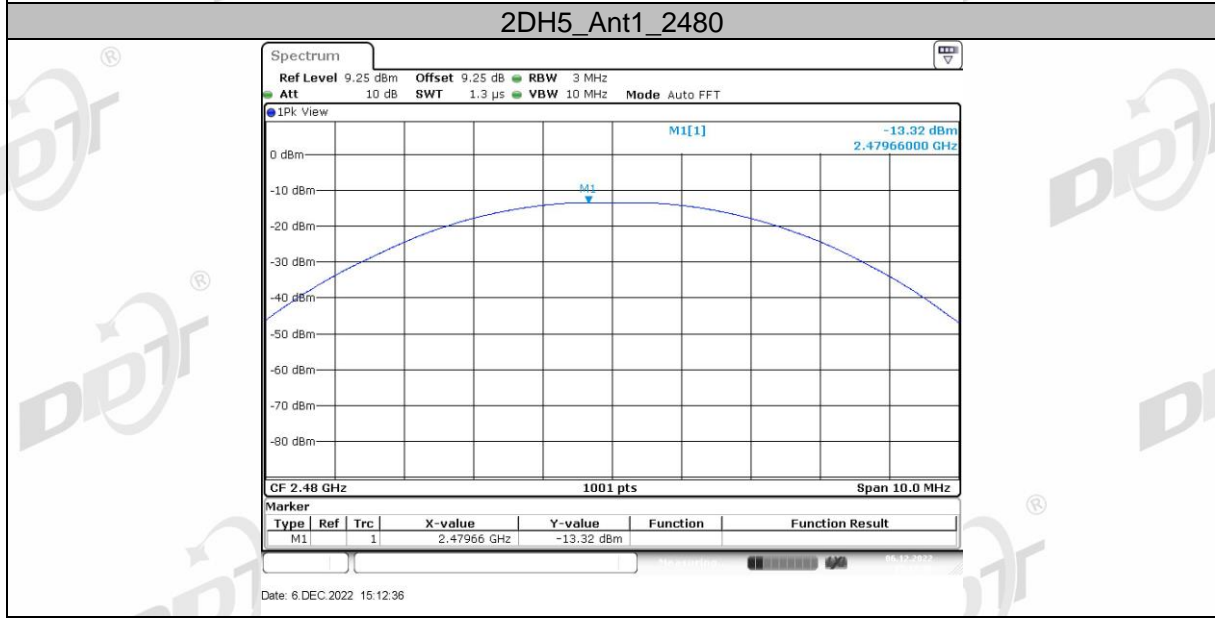
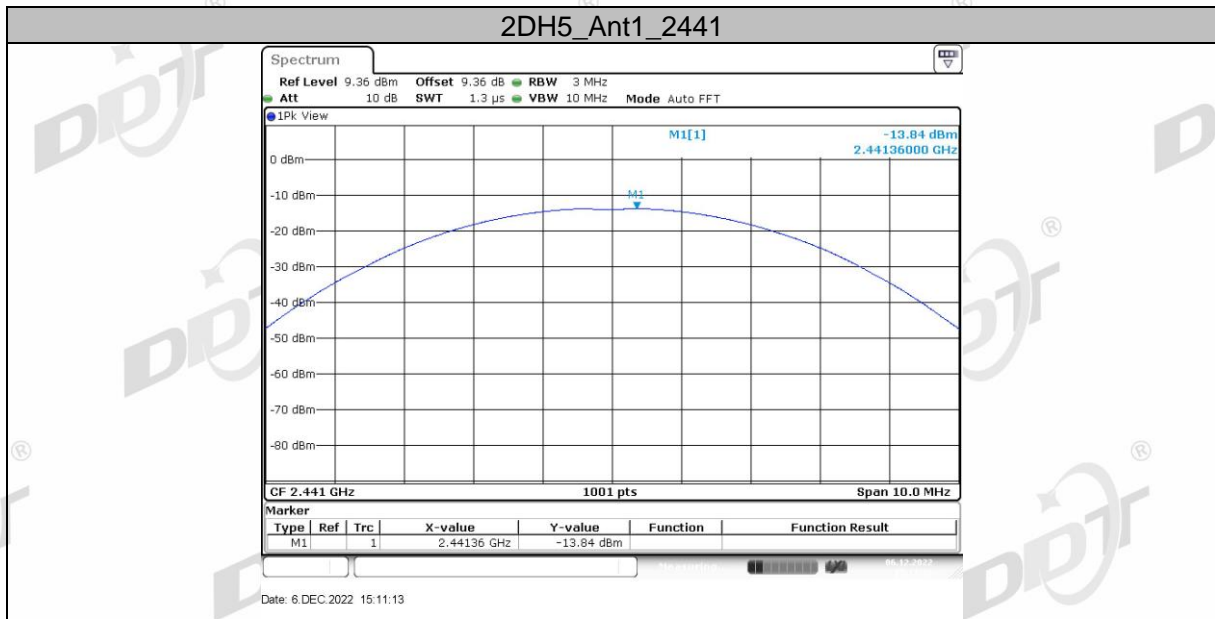

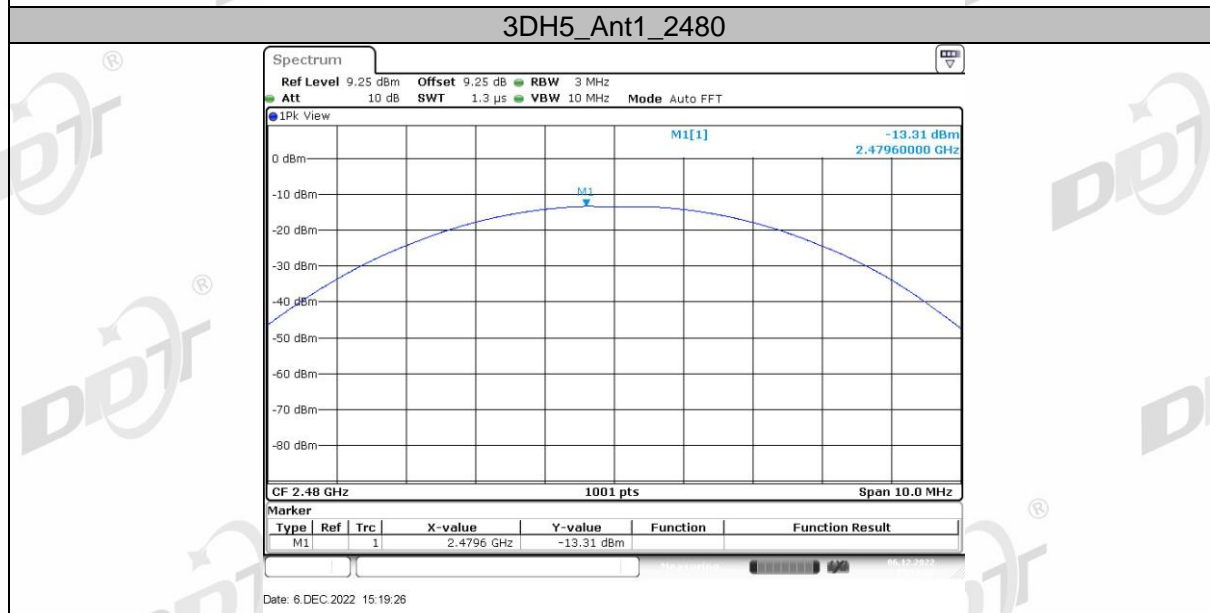
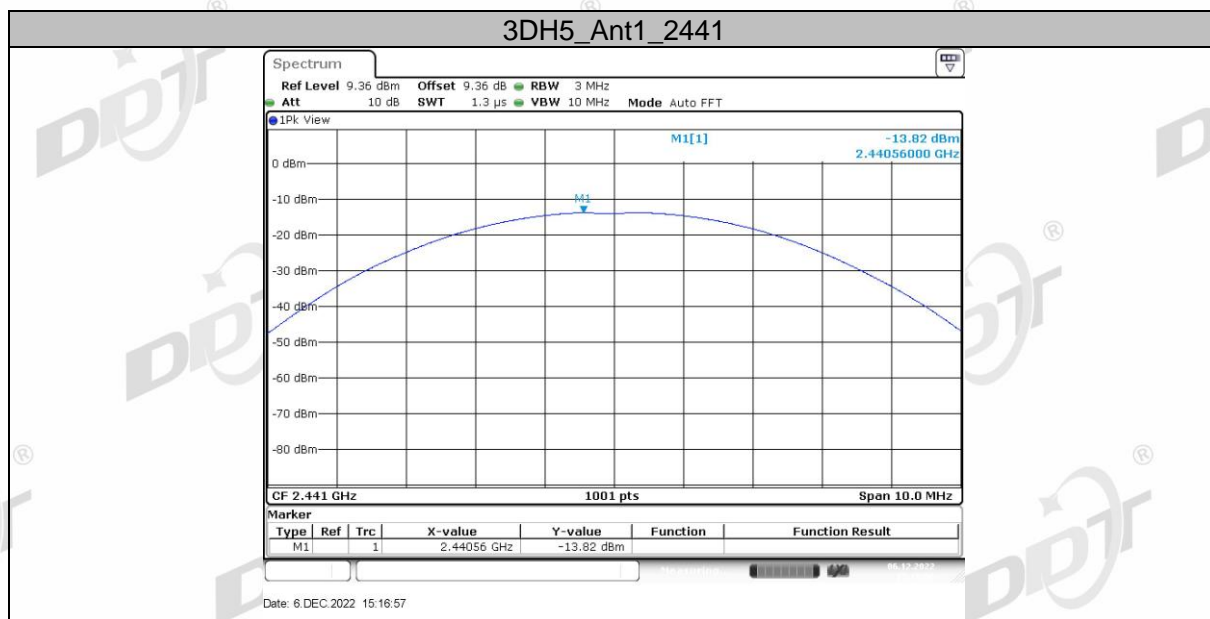

5. 20 dB Bandwidth and 99% Bandwidth

5.1. Block diagram of test setup

Same as section 4.1

5.2. Limits

Intentional radiators operating under the alternative provisions to the general emission limits, as contained in § 15.217 through 15.257 and in Subpart E of this part, must be designed to ensure that the 20 dB bandwidth of the emission, or whatever bandwidth may otherwise be specified in the specific rule section under which the equipment operates, is contained within the frequency band designated in the rule section under which the equipment is operated.

5.3. Test procedure

- (1) Connect EUT's antenna output to spectrum analyzer by RF cable.
- (2) The bandwidth of the fundamental frequency was measured by spectrum analyzer with 30 kHz RBW and 100 kHz VBW. The 20 dB bandwidth is defined as the total spectrum the power of which is higher than peak power minus 20 dB.

Note:

- 1.The attenuator loss was inputted into spectrum analyzer as amplitude offset.
- 2.The pathloss of external cable: 0.5dB (According to the manufacturer's claims).

5.4. Test result

Test Mode	Frequency (MHz)	20 dB bandwidth Result (MHz)	99% bandwidth Result (MHz)	Verdict
GFSK	2402	1.032	0.945	Pass
	2441	1.030	0.947	Pass
	2480	1.028	0.945	Pass
$\pi/4$ -DQPSK	2402	1.234	1.157	Pass
	2441	1.236	1.157	Pass
	2480	1.236	1.157	Pass
8DPSK	2402	1.254	1.157	Pass
	2441	1.254	1.157	Pass
	2480	1.252	1.157	Pass

5.5. Original test data

20 dB bandwidth:



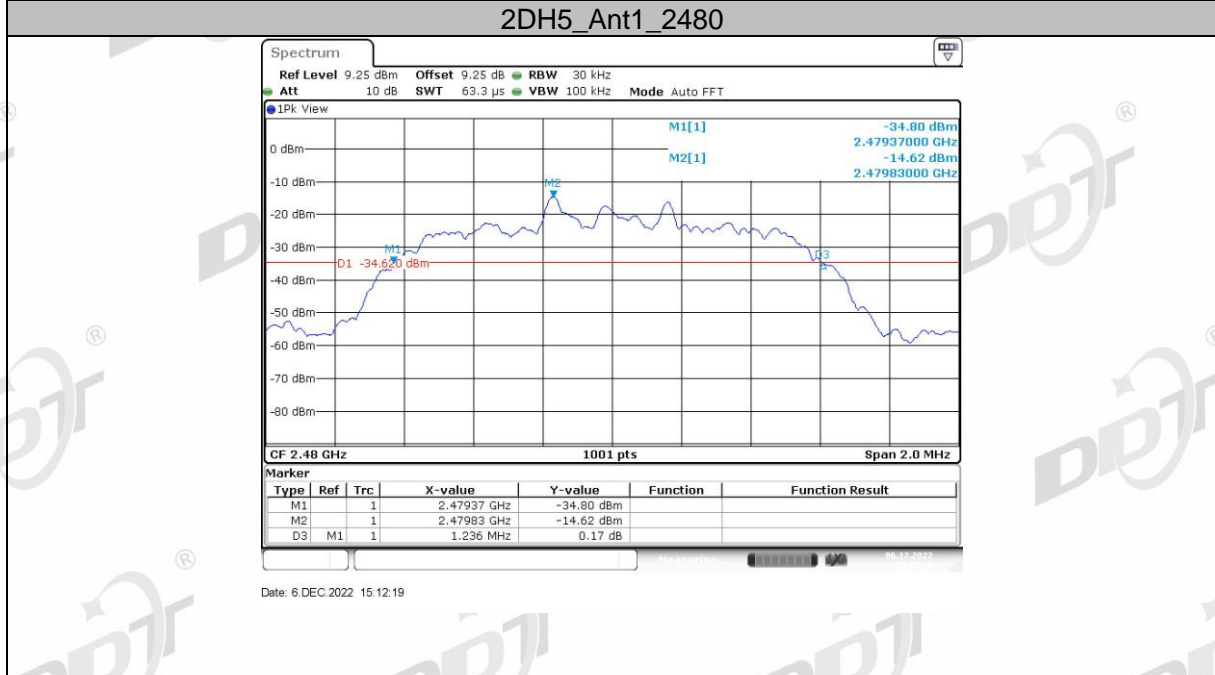
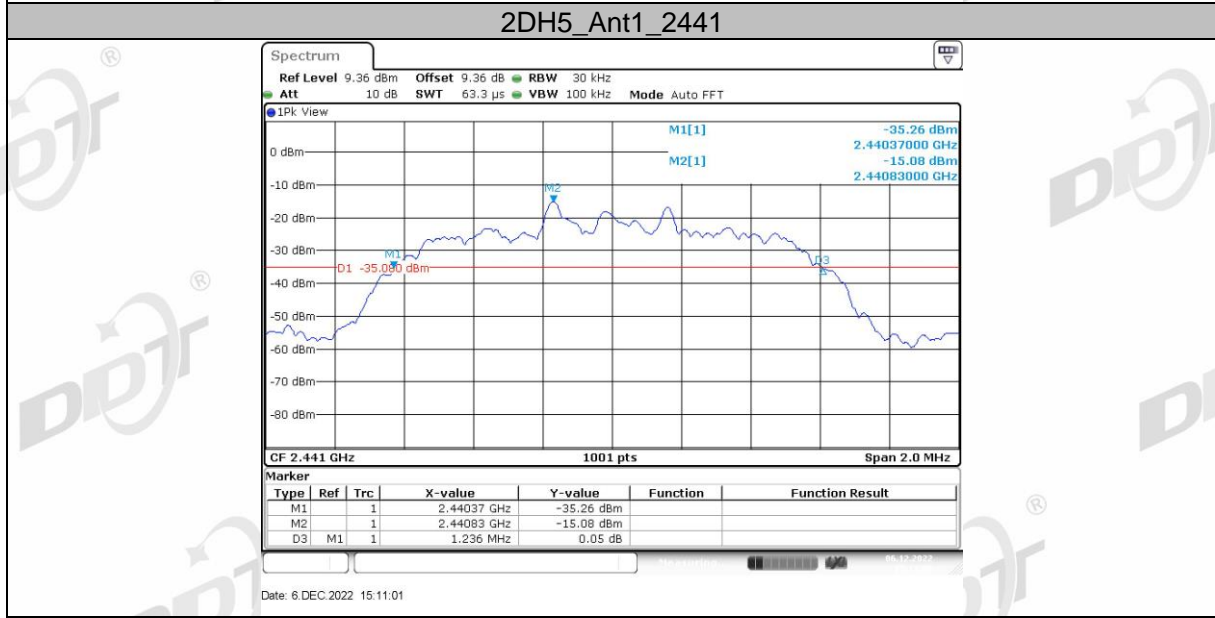
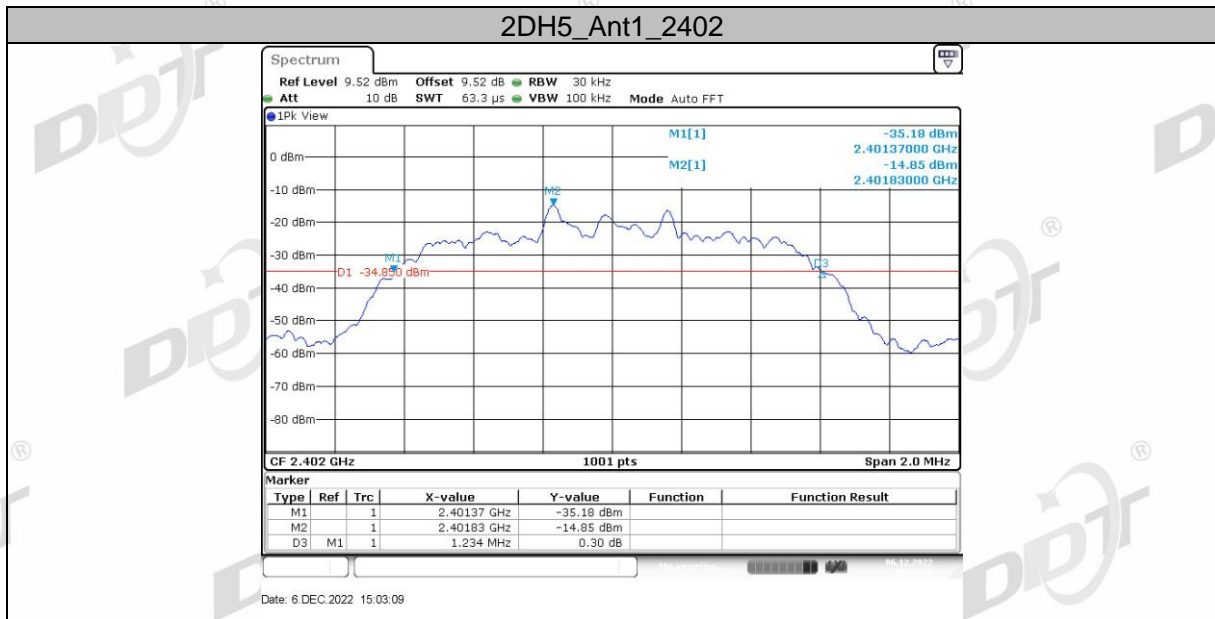

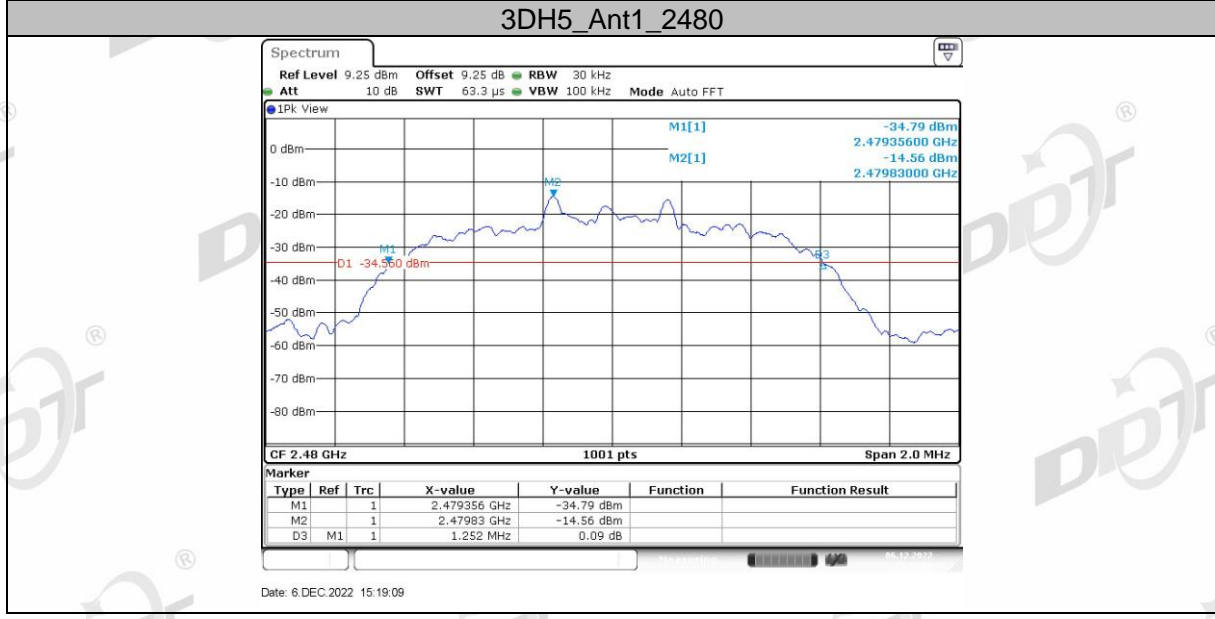
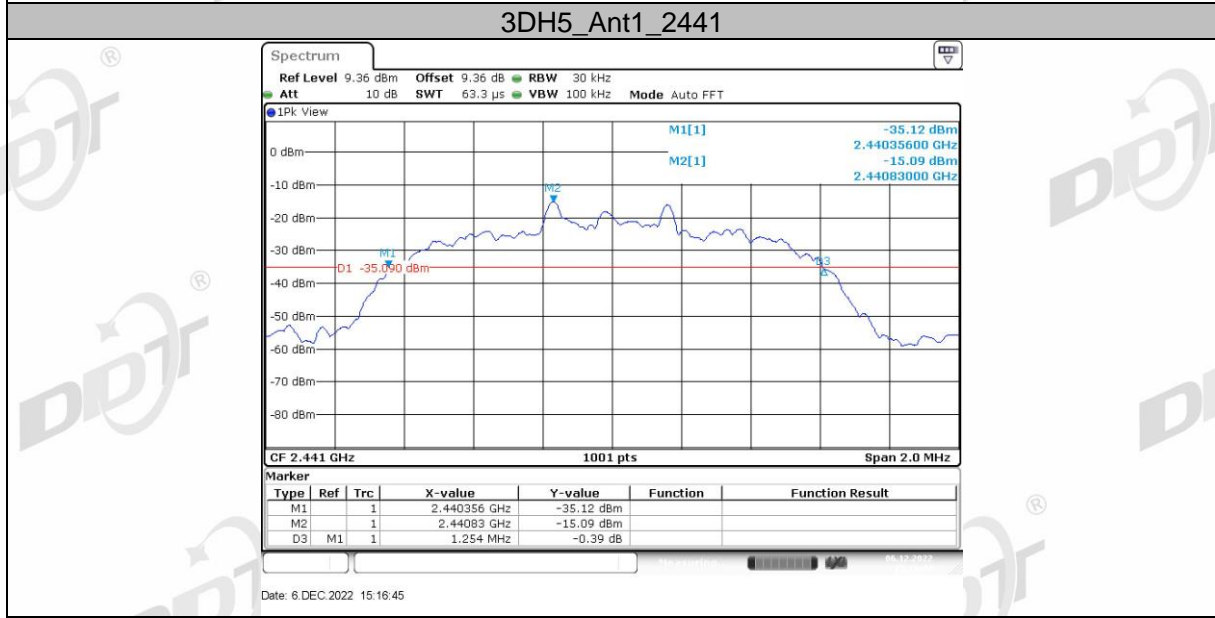
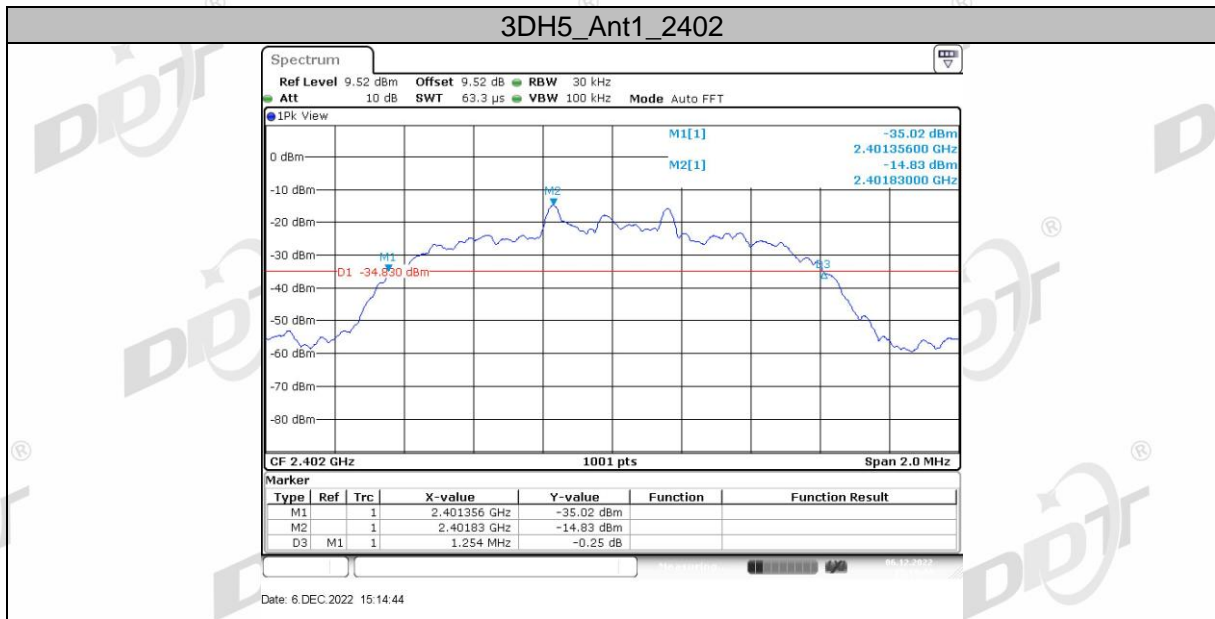

99% bandwidth:

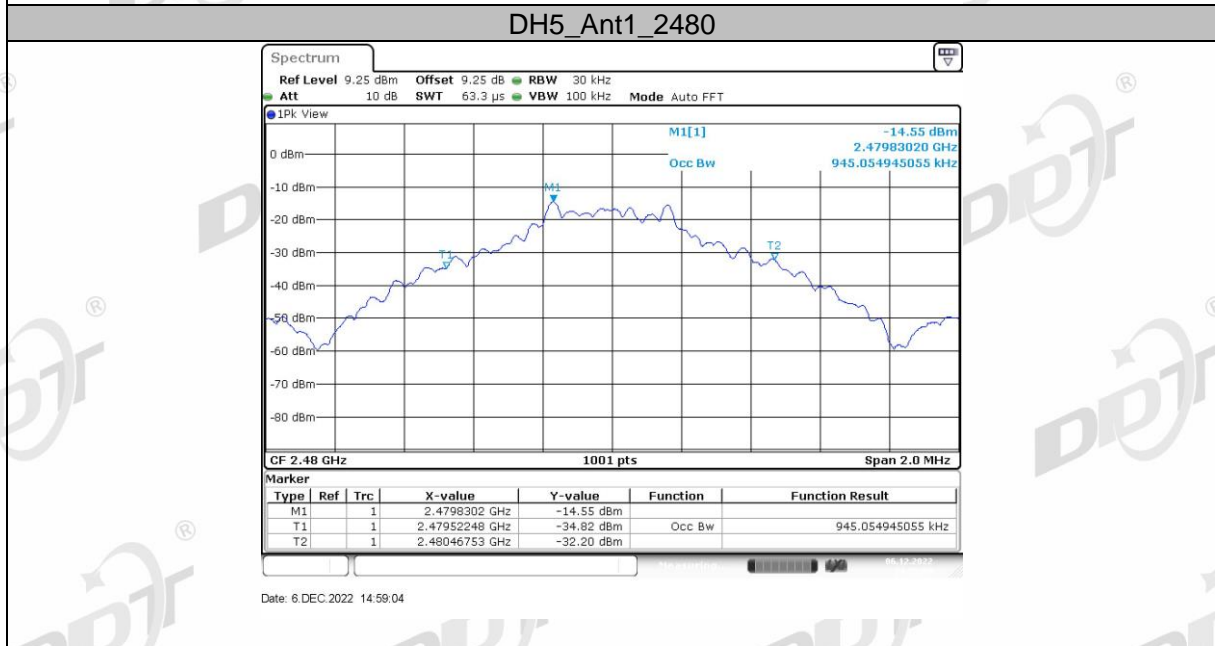
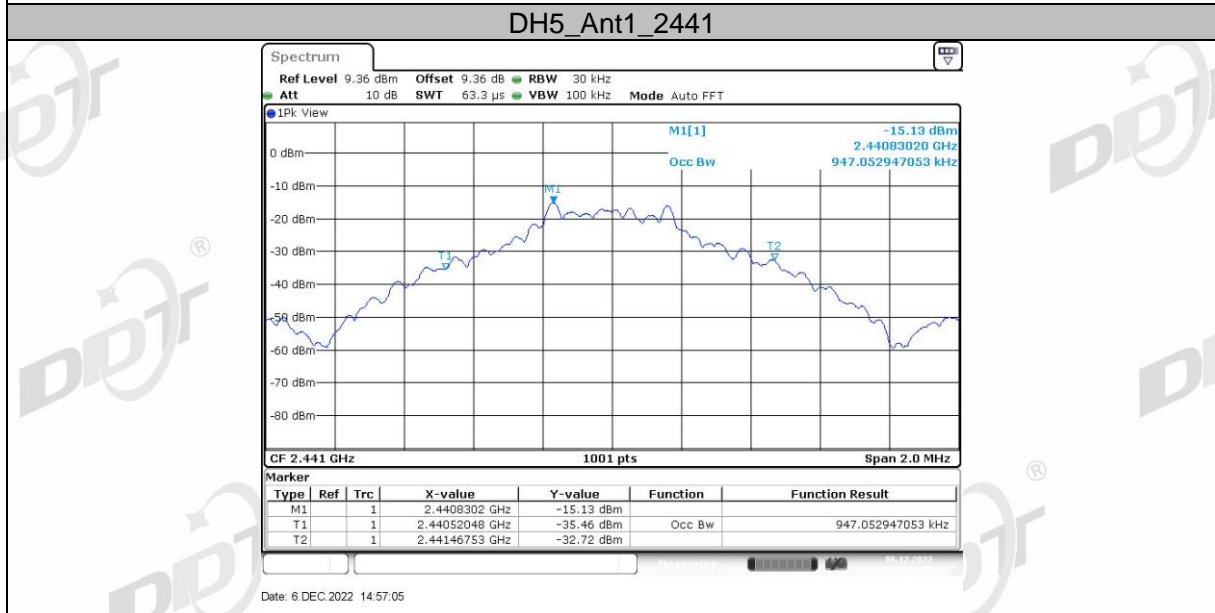
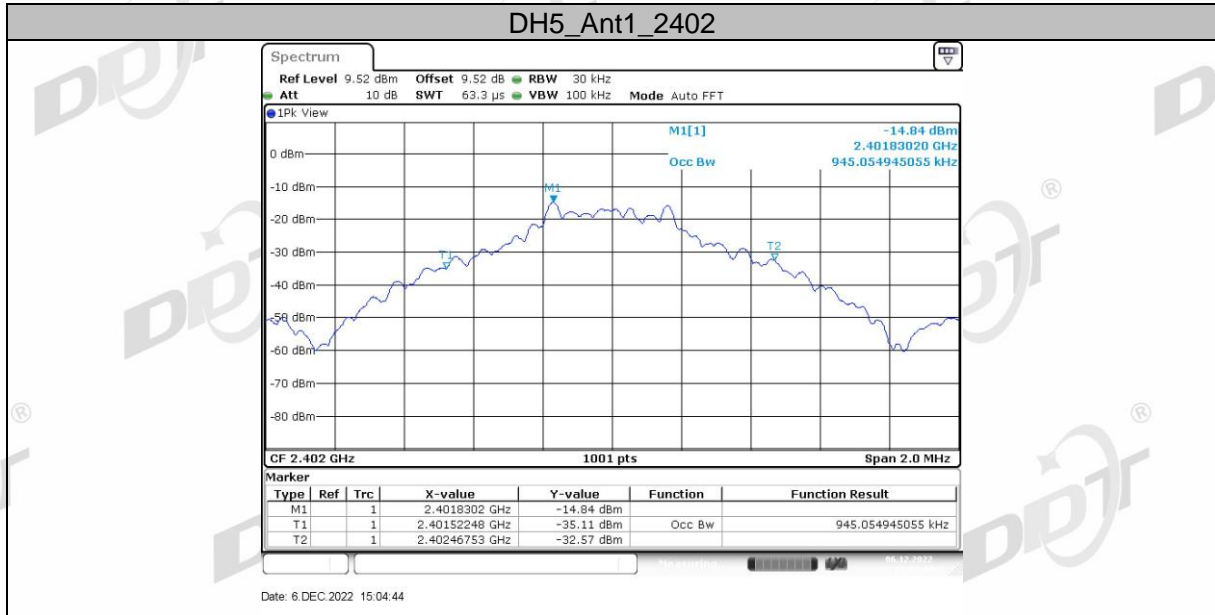

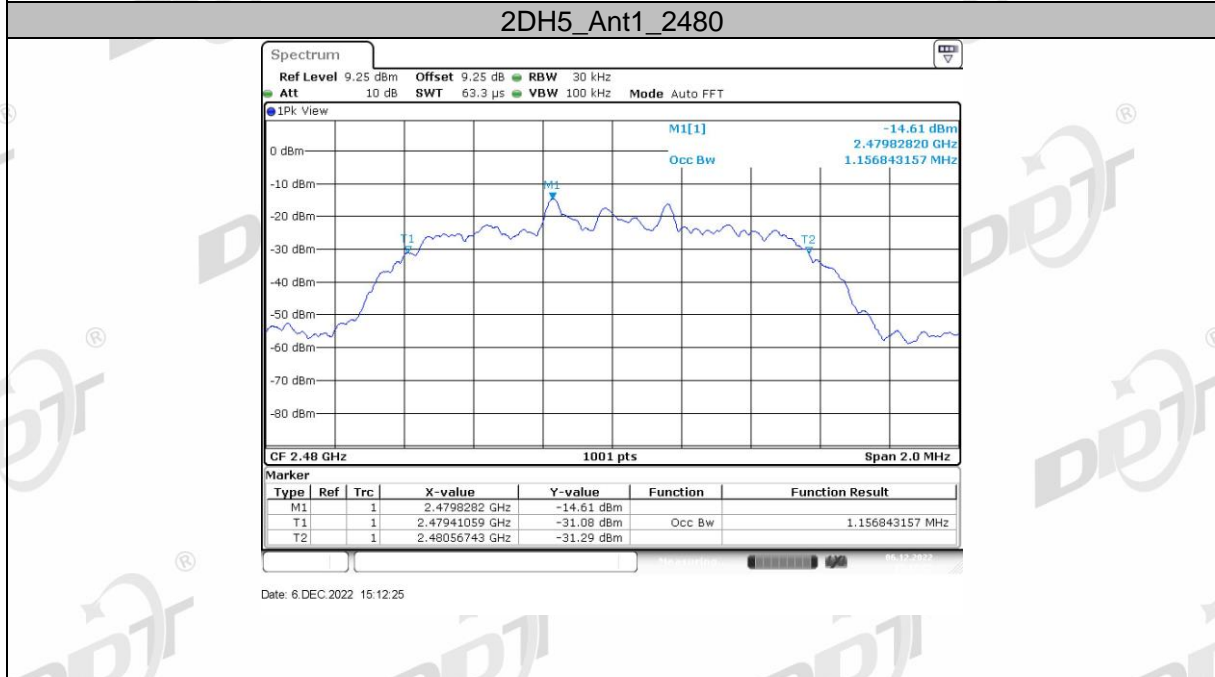
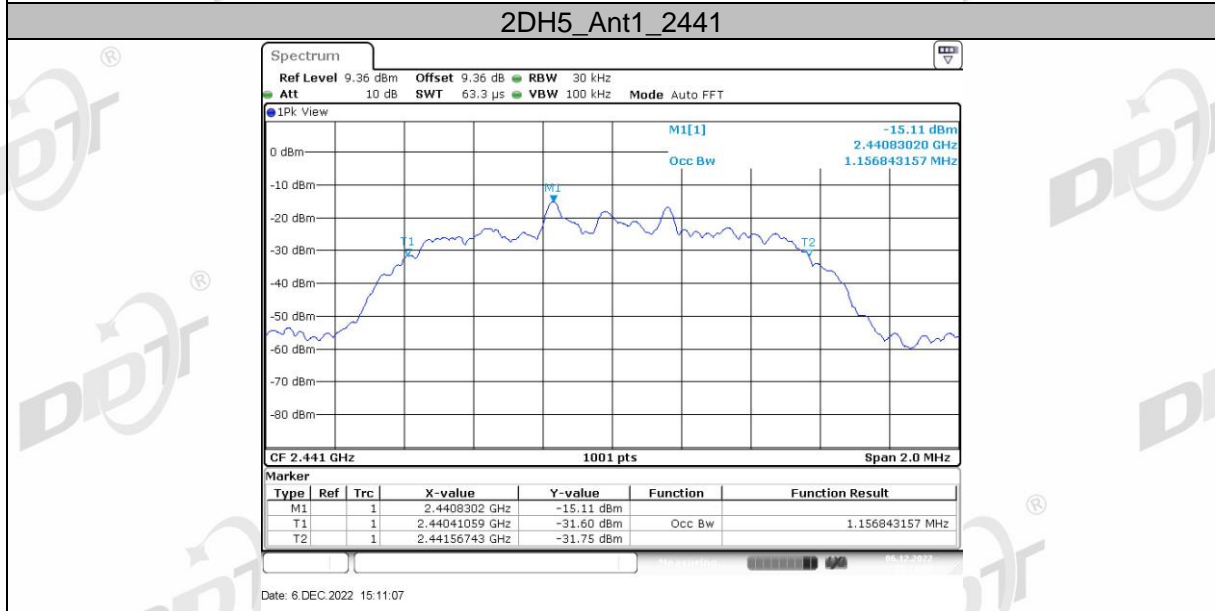
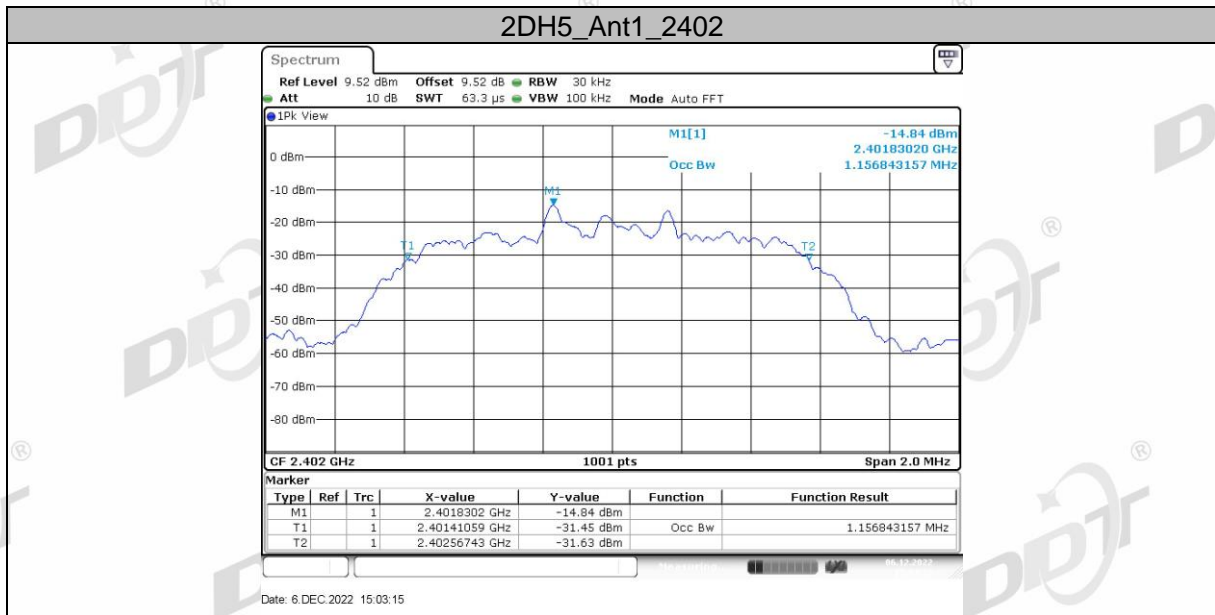

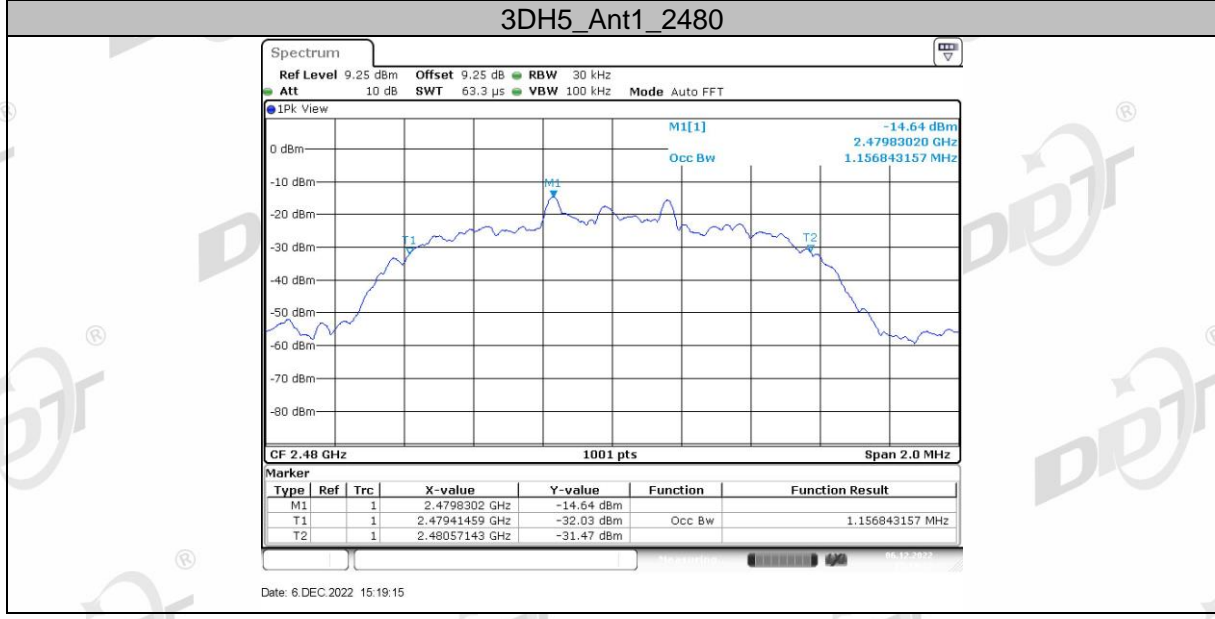
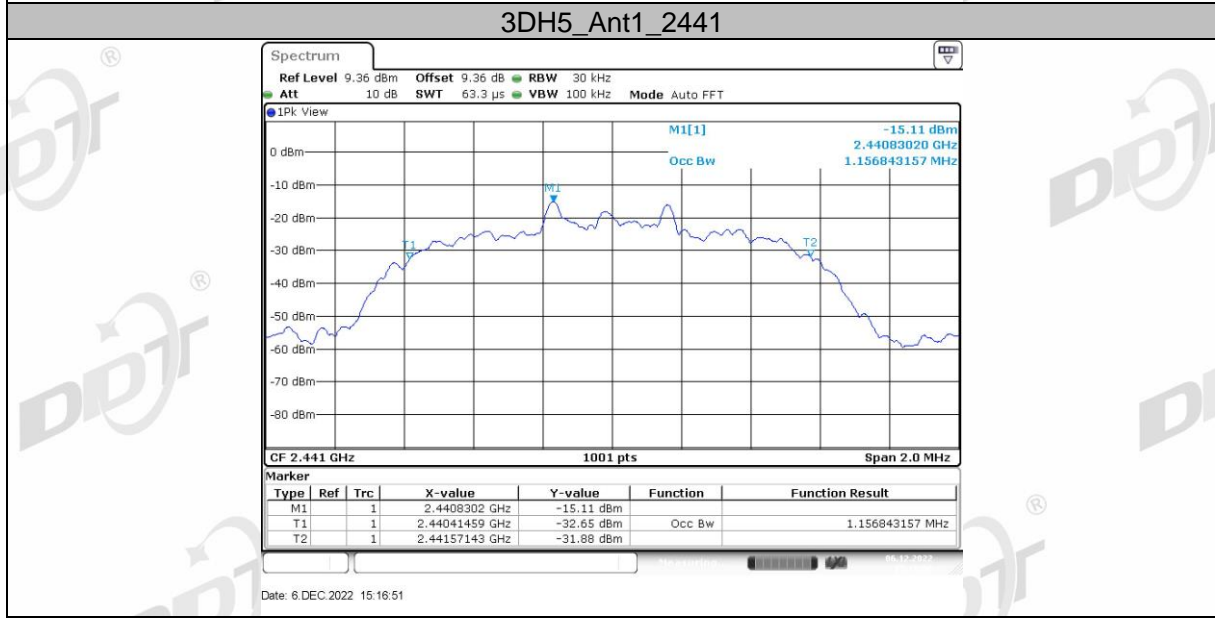
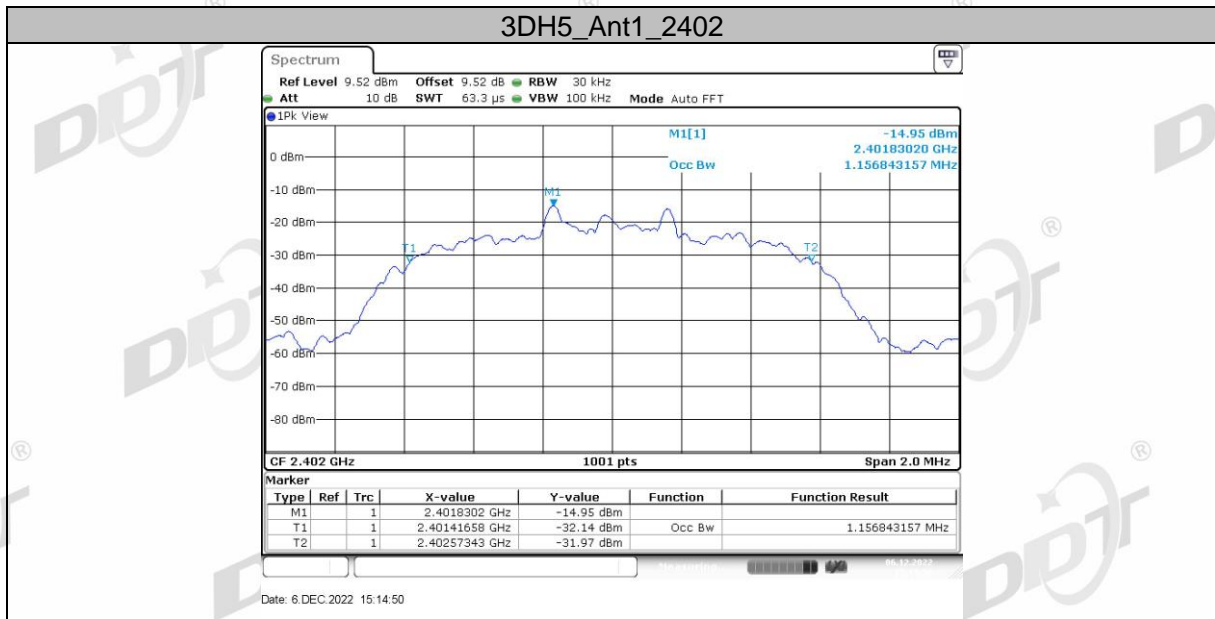

6. Carrier Frequency Separation

6.1. Block diagram of test setup

Same as section 4.1

6.2. Limits

Frequency hopping systems shall have hopping channel carrier frequencies separated by a minimum of 25 kHz or the 20 dB bandwidth of the hopping channel, whichever is greater.

Alternatively, frequency hopping systems operating in the 2400-2483.5 MHz band may have hopping channel carrier frequencies that are separated by 25 kHz or two-thirds of the 20 dB bandwidth of the hopping channel, whichever is greater, provided the systems operate with an output power no greater than 125 mW.

6.3. Test procedure

- (1) Connect EUT's antenna output to spectrum analyzer by RF cable.
- (2) The carrier frequency was measured by spectrum analyzer with 100 kHz RBW and 300 kHz VBW.

Note:

- 1.The attenuator loss was inputted into spectrum analyzer as amplitude offset.
- 2.The pathloss of external cable: 0.5dB (According to the manufacturer's claims).

6.4. Test result

Test Mode	Channel separation (MHz)	20dB bandwidth (MHz) (worst case)	Limit (MHz) 2/3 of 20dB bandwidth	Verdict
GFSK	1.000	1.032	≥0.688	Pass
$\pi/4$ -DQPSK	1.003	1.236	≥0.824	Pass
8DPSK	1.000	1.254	≥0.836	Pass

6.5. Original test data



7. Number of Hopping Channel

7.1. Block diagram of test setup

Same as section 4.1

7.2. Limits

Frequency hopping systems in the 2400-2483.5 MHz band shall use at least 15 channels.

7.3. Test procedure

- (1) Connect EUT's antenna output to spectrum analyzer by RF cable.
- (2) The number of hopping channels was measured by spectrum analyzer with 100 kHz RBW and 300 kHz VBW.

Note:

- 1.The attenuator loss was inputted into spectrum analyzer as amplitude offset.
- 2.The pathloss of external cable: 0.5dB (According to the manufacturer's claims).

7.4. Test result

Mode	Number of hopping channels	Limit	Verdict
GFSK	79	>15	Pass
$\pi/4$ -DQPSK	79	>15	Pass
8DPSK	79	>15	Pass

7.5. Original test data

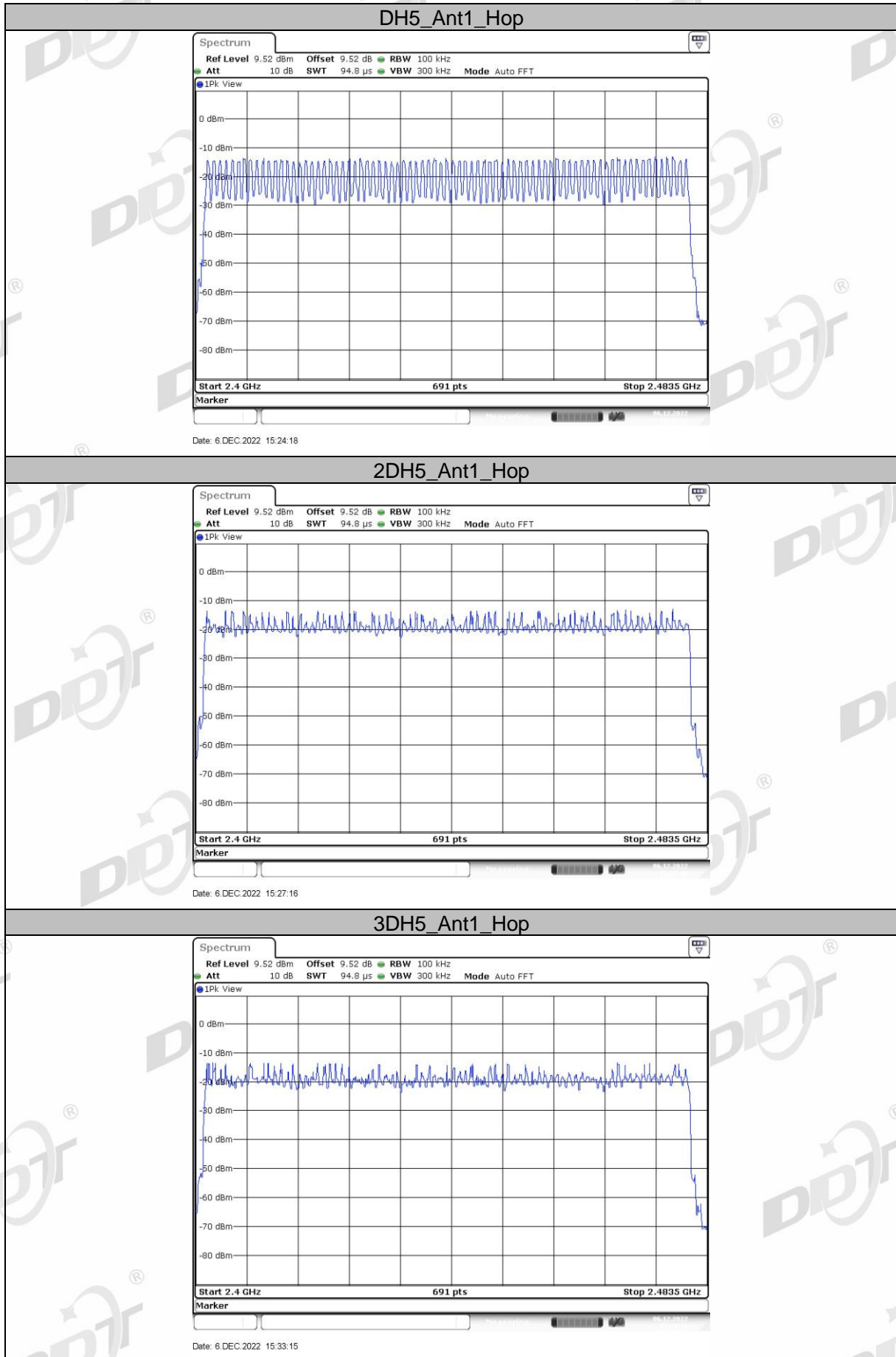

8. Dwell Time

8.1. Block diagram of test setup

Same as section 4.1

8.2. Limits

The average time of occupancy on any channel shall not be greater than 0.4 seconds within a period of 0.4 seconds multiplied by the number of hopping channels employed.

8.3. Test procedure

- (1) Connect EUT's antenna output to spectrum analyzer by RF cable.
- (2) The test period: $T = 0.4 \text{ Second/Channel} \times 79 \text{ Channel} = 31.6 \text{ s}$.
- (3) Measure the hopping number and on time of each pulse with spectrum analyzer in zero span set, and calculate dwell time with formula $\text{Dwell time} = \text{total hops} \times \text{pulse's on time}$.

Note:

- 1.The attenuator loss was inputted into spectrum analyzer as amplitude offset.
- 2.The pathloss of external cable: 0.5dB (According to the manufacturer's claims).

8.4. Test result

Mode	Dwell time (s)	Pulse's on time (ms)	Total hops	Limit	Verdict
DH1	0.068	0.370	183	<400ms	Pass
DH3	0.179	1.630	110	<400ms	Pass
DH5	0.232	2.870	81	<400ms	Pass
2DH1	0.068	0.370	185	<400ms	Pass
2DH3	0.173	1.620	107	<400ms	Pass
2DH5	0.222	2.880	77	<400ms	Pass
3DH1	0.068	0.370	183	<400ms	Pass
3DH3	0.177	1.620	109	<400ms	Pass
3DH5	0.221	2.870	77	<400ms	Pass

Note: Dwell time = total hops * pulse's on time.

8.5. Original test data

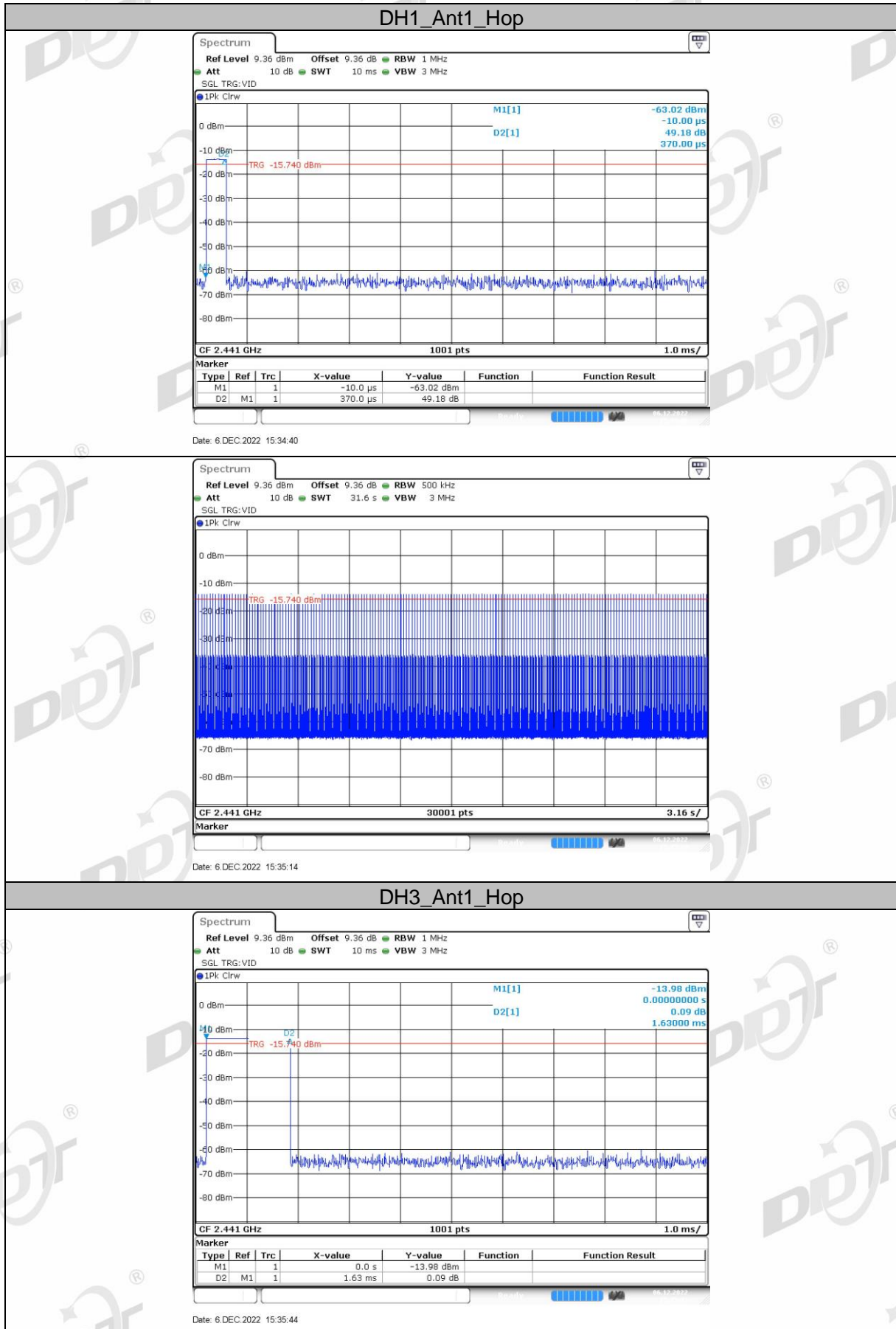

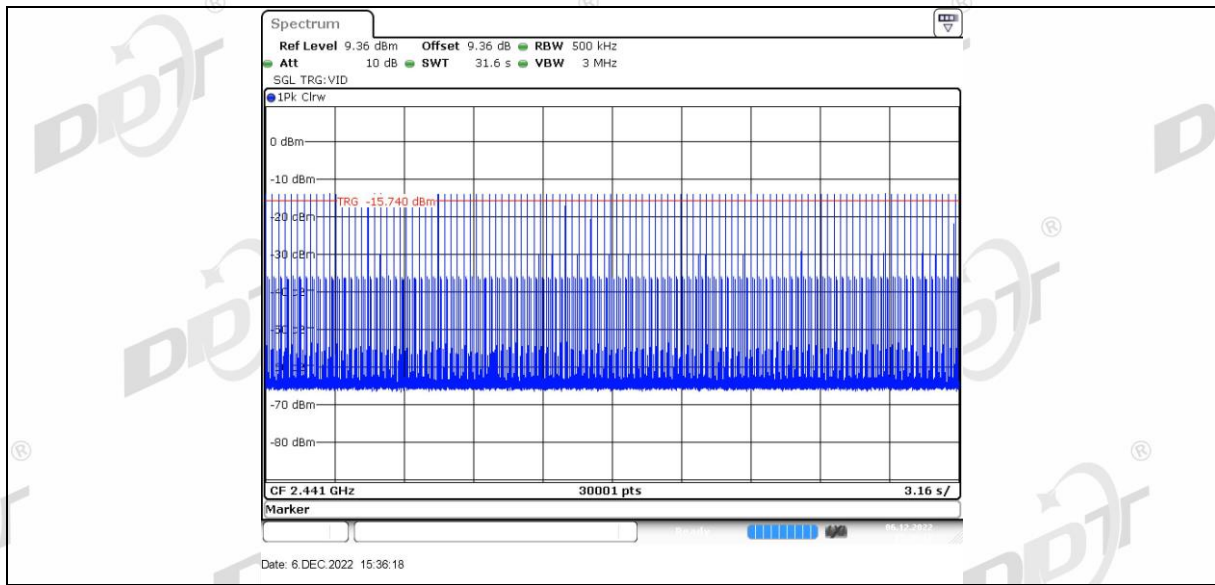

DH5_Ant1_Hop

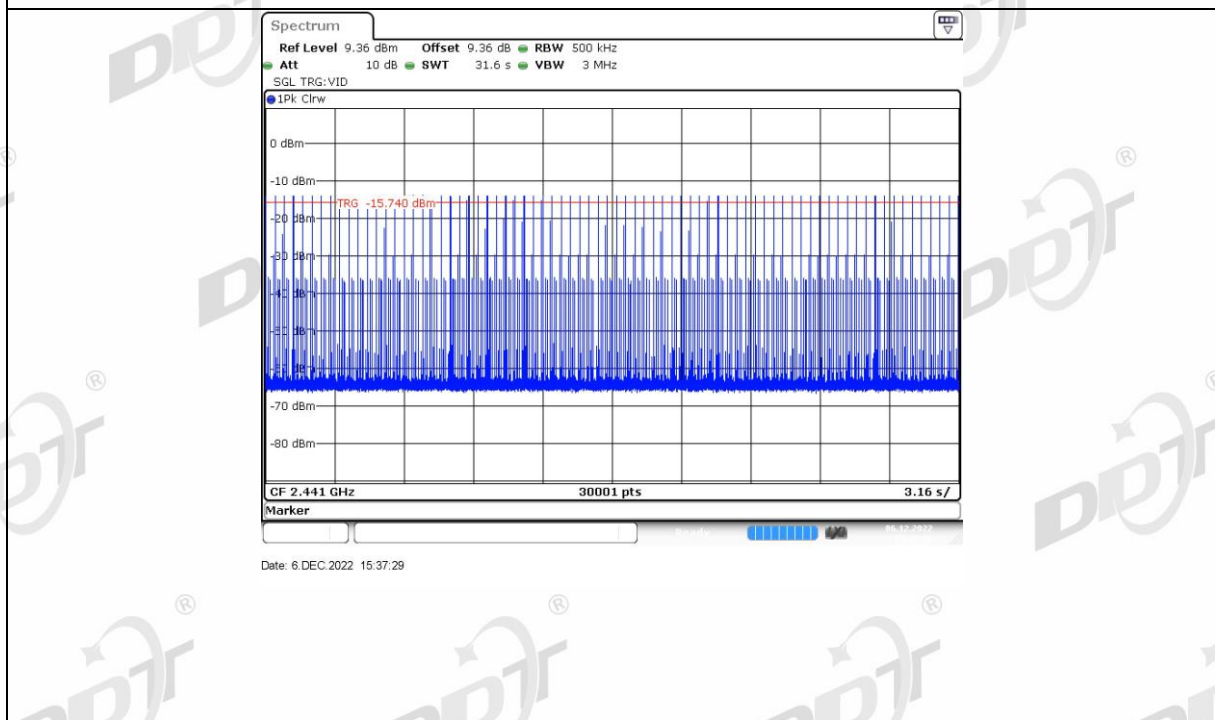
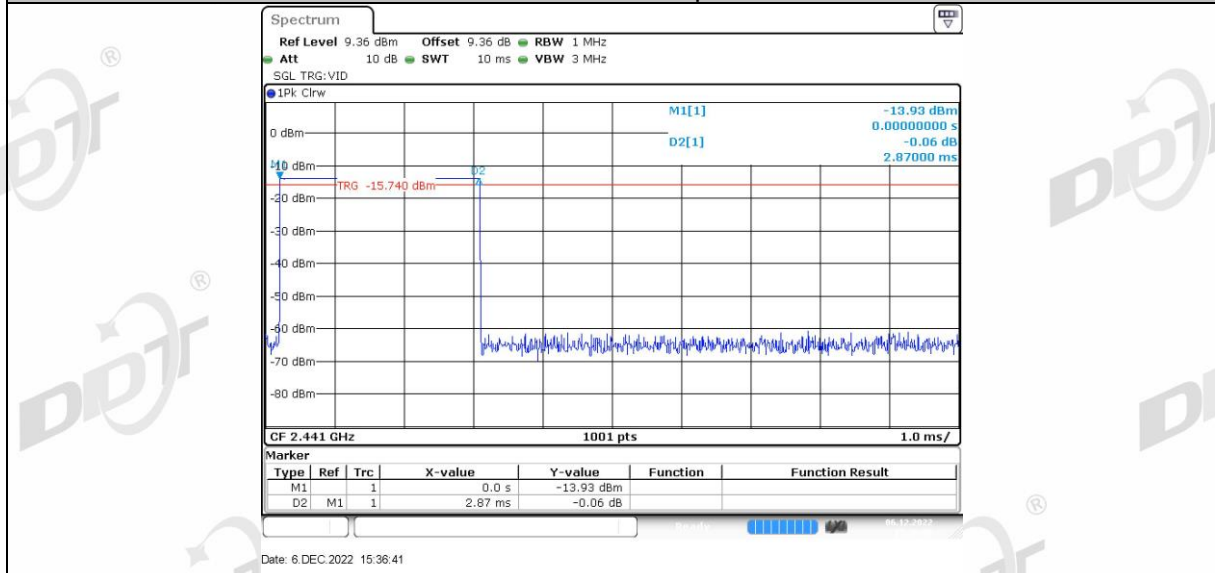

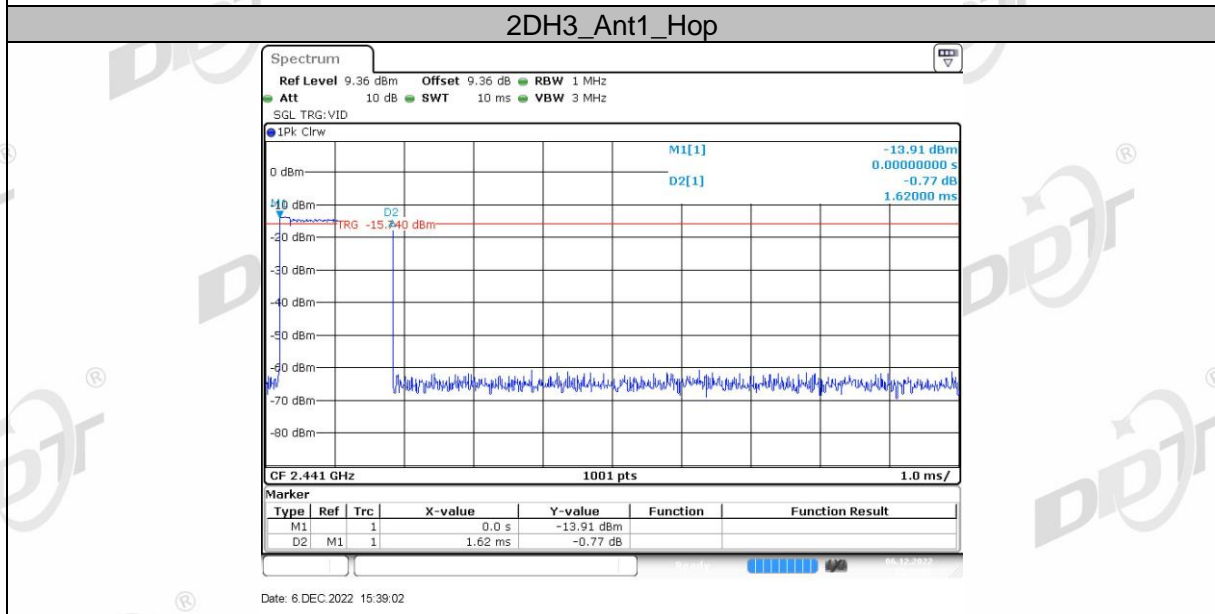
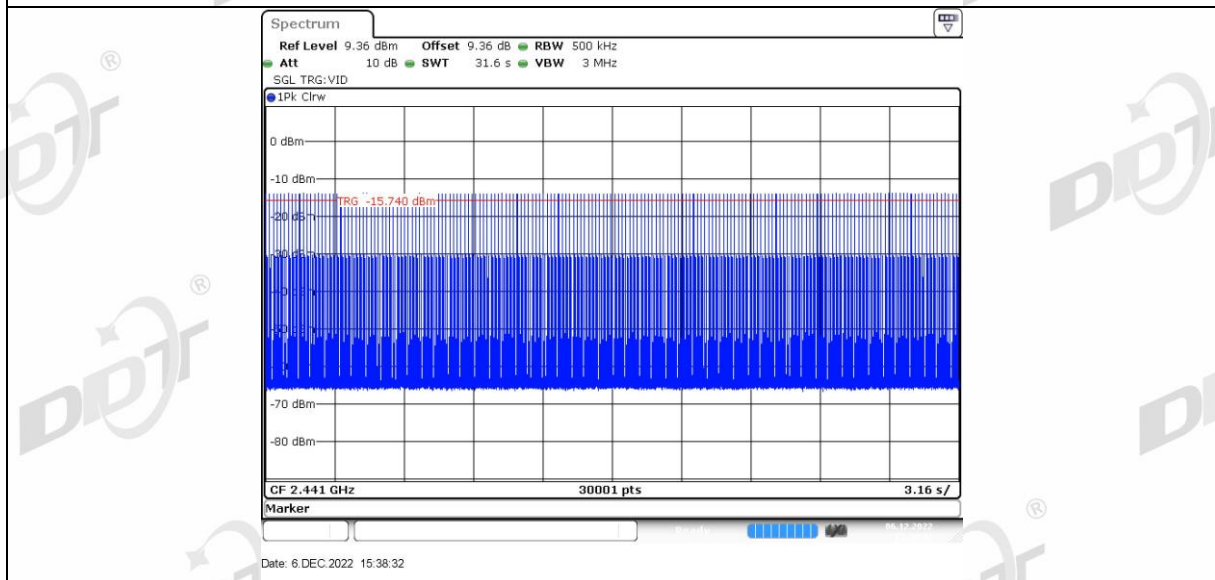
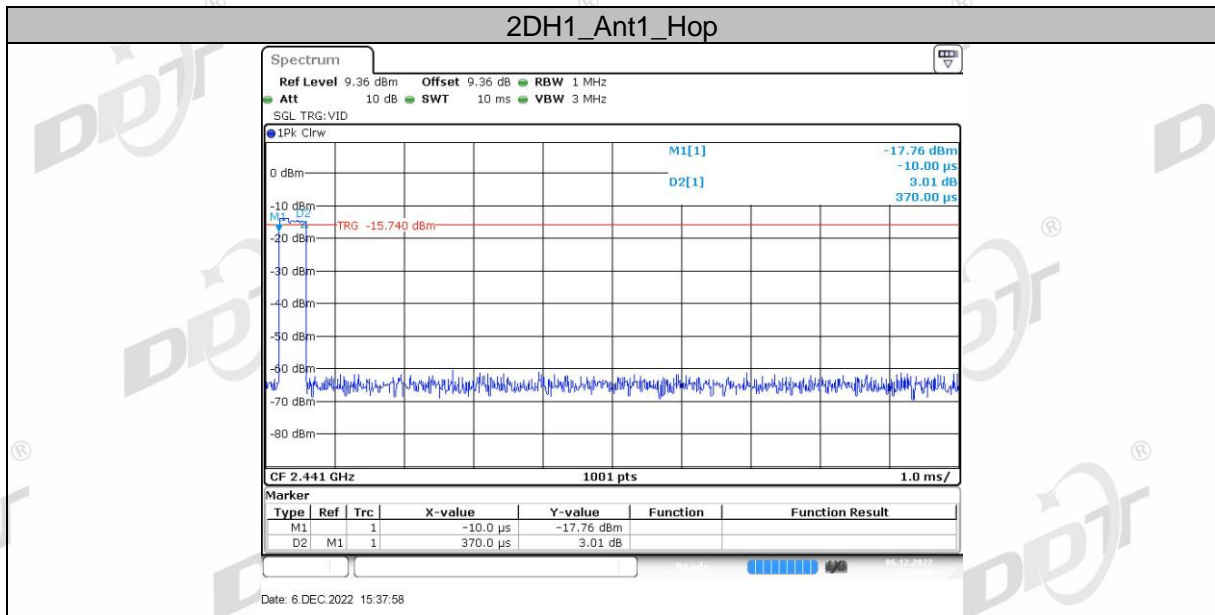

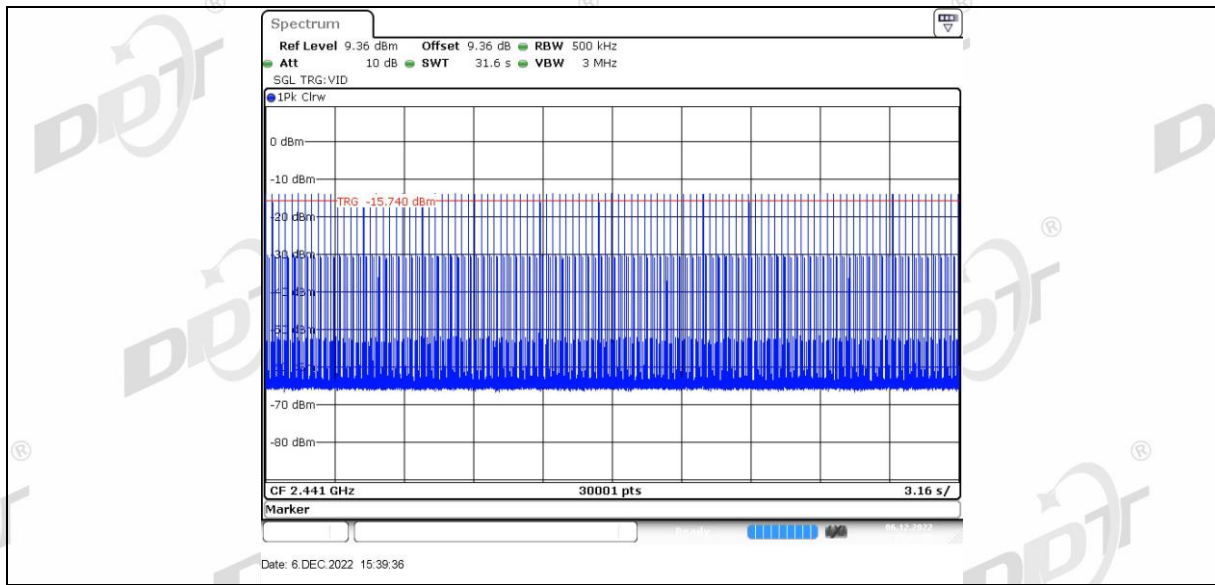

2DH5_Ant1_Hop

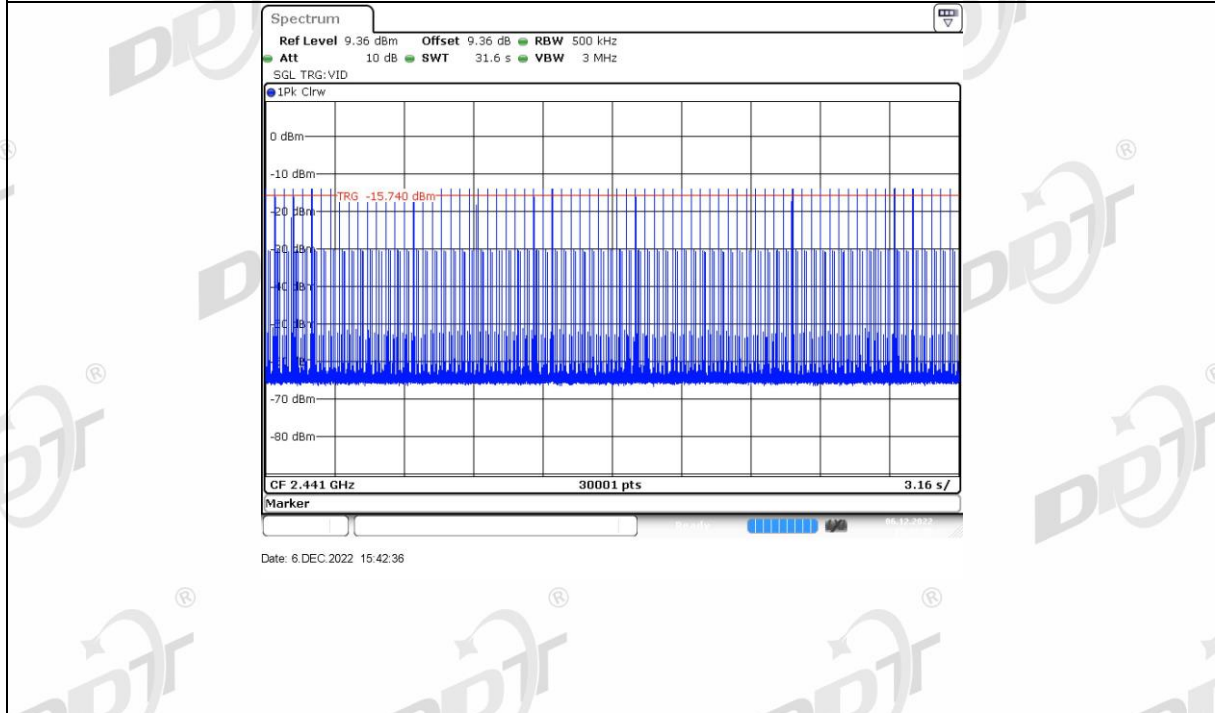
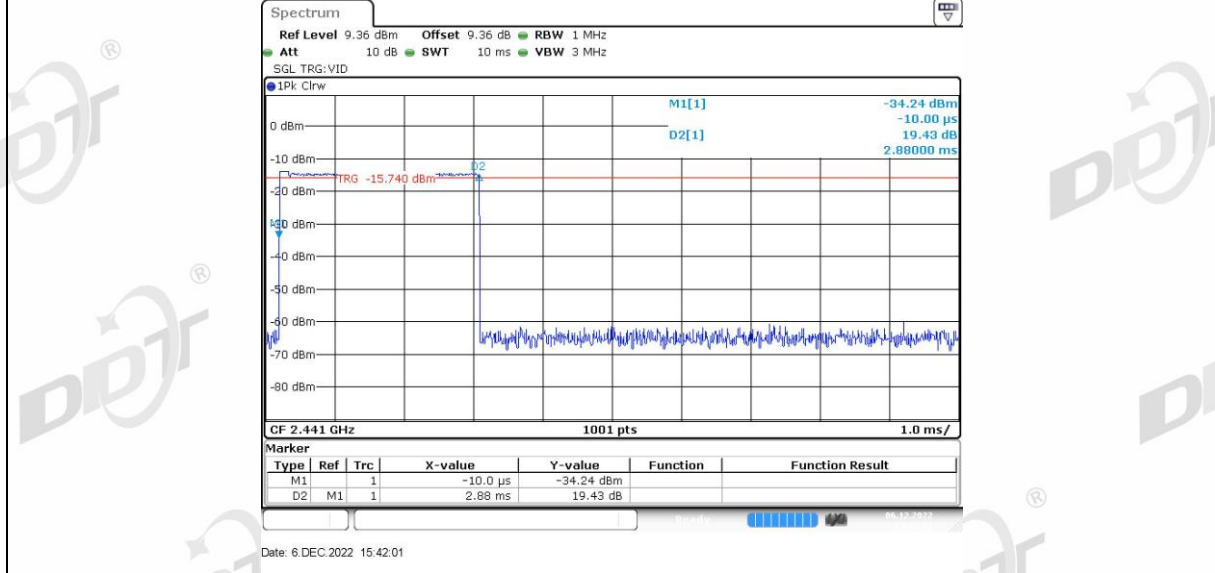

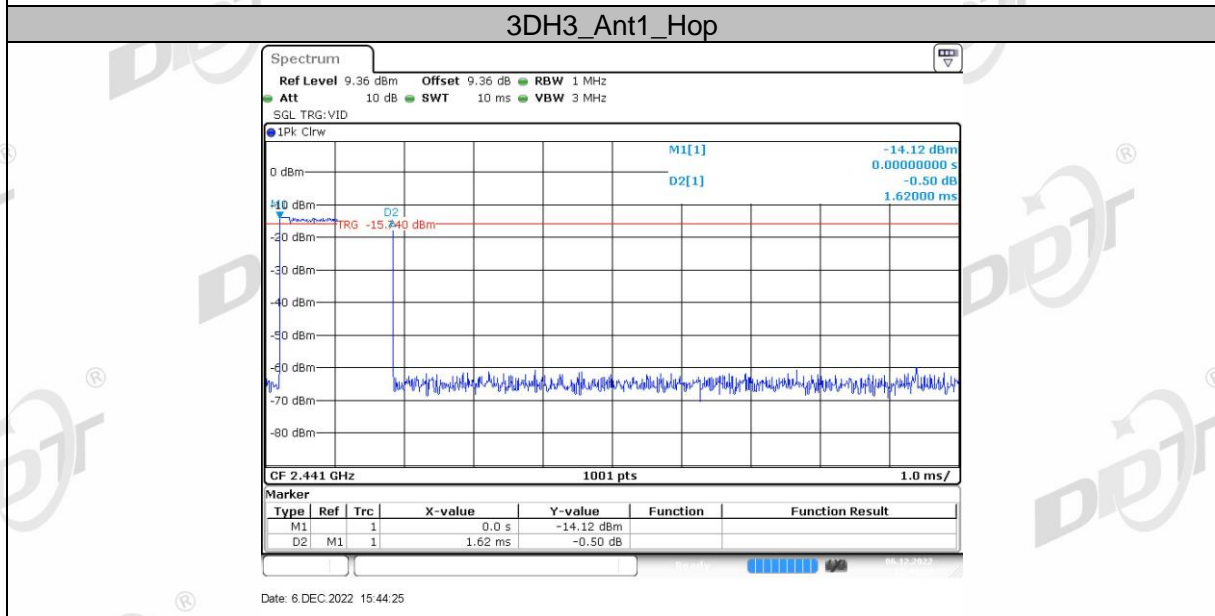
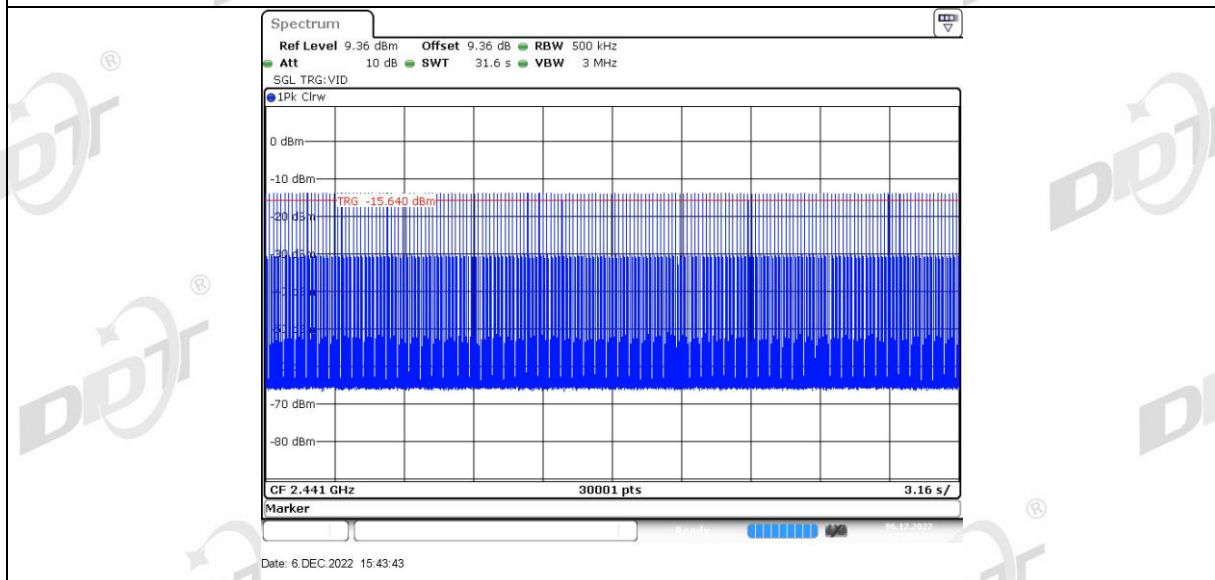
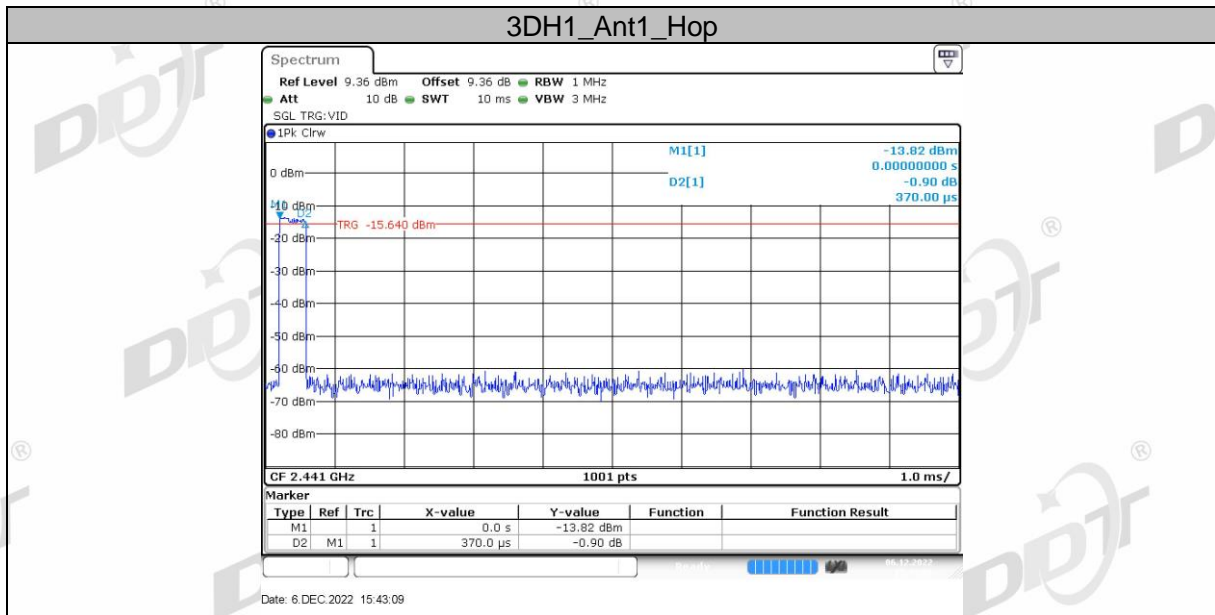

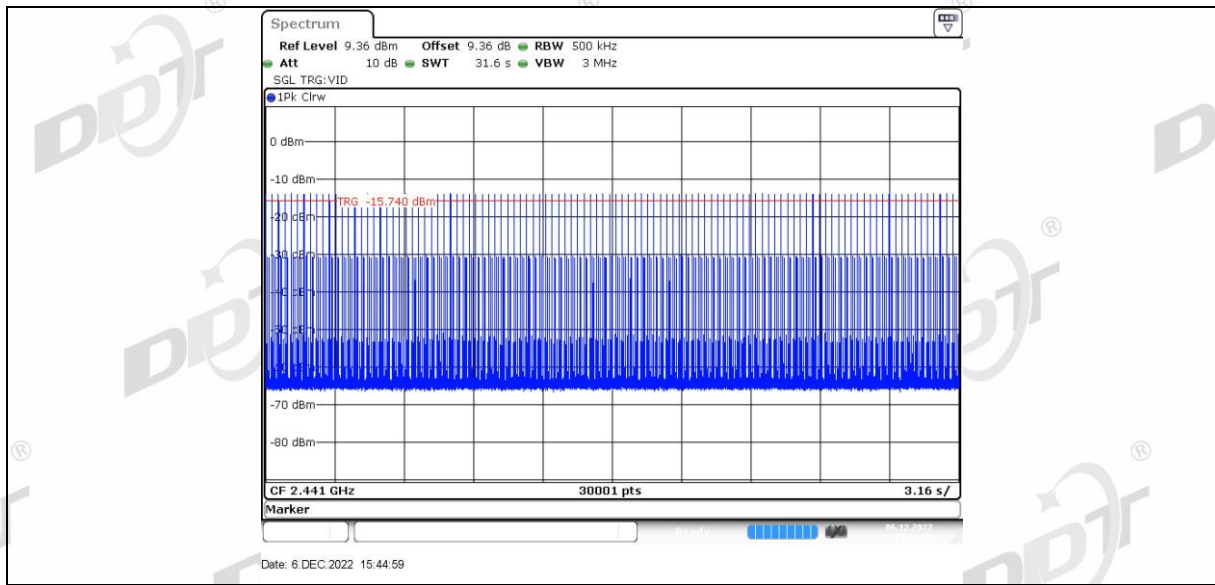

3DH5_Ant1_Hop

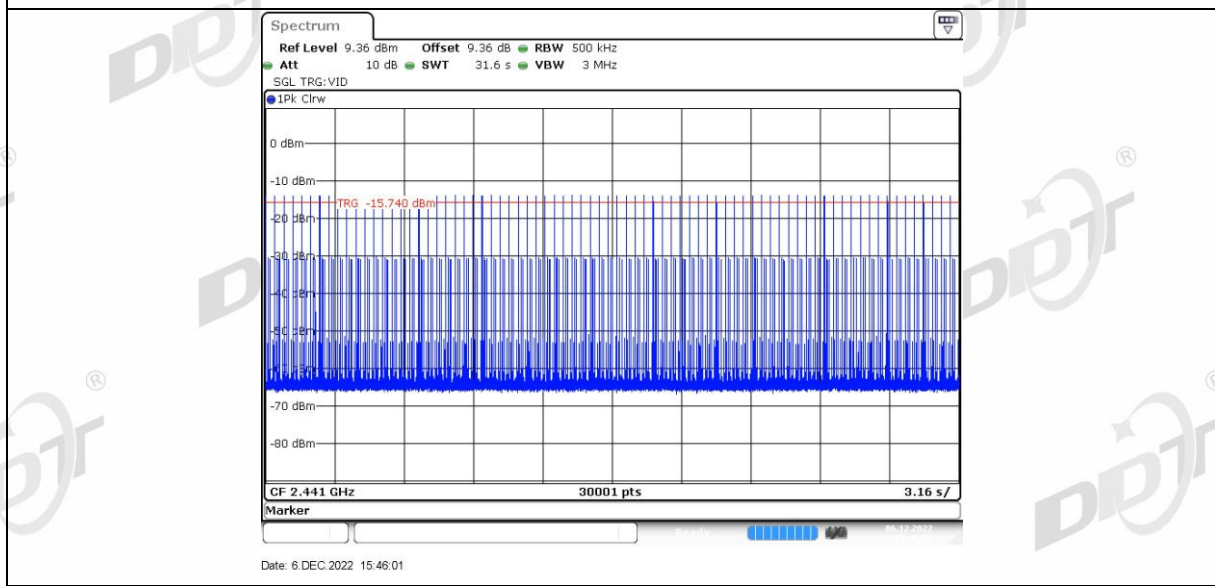
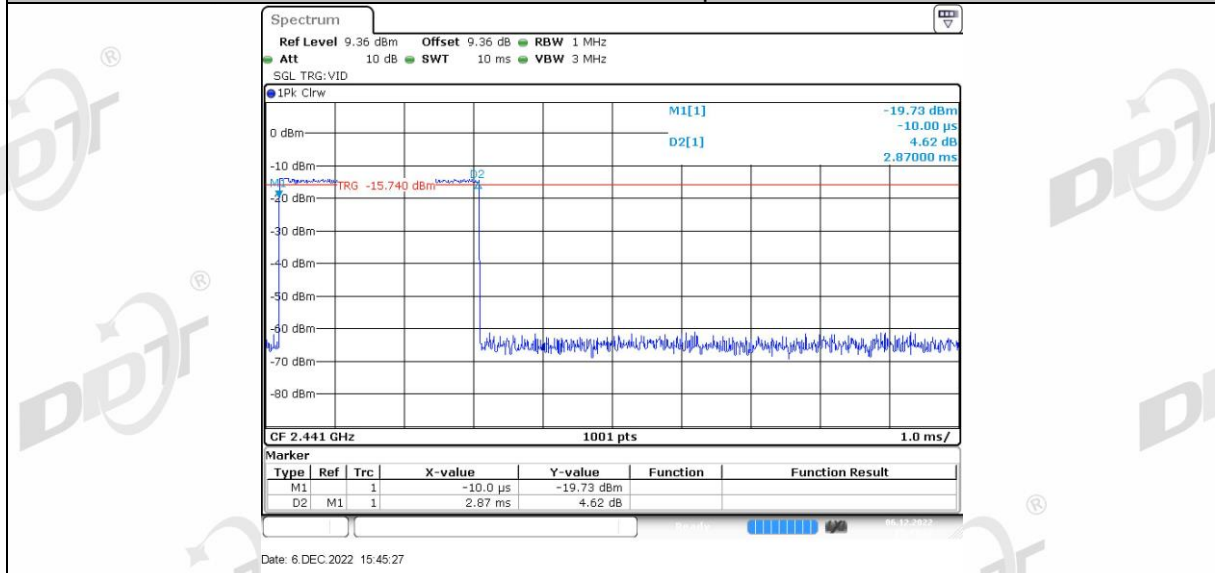

9. Band Edge Compliance (Conducted Method)

9.1. Block diagram of test setup

Same as section 4.1

9.2. Limit

All restriction band should comply with 15.209, other emission should be at least 20dB below the fundamental.

9.3. Test procedure

- (1) Connect EUT's antenna output to spectrum analyzer by RF cable.
- (2) Establish a reference level by using the following procedure:

RBW:	100 kHz
VBW:	300 kHz
Span	Encompass frequency range to be measured
Detector Mode:	Peak
Sweep time:	auto
Trace mode	Max hold

- (3) Allow the trace to stabilize, use the peak marker function to determine the maximum peak power level to establish the reference level.
- (4) Then mark the maximum amplitude of all unwanted emissions outside of the authorized frequency band.

Note:

- 1.The attenuator loss was inputted into spectrum analyzer as amplitude offset.
- 2.The pathloss of external cable: 0.5dB (According to the manufacturer's claims).

9.4. Test result

Mode	Frequency (MHz)	Verdict
GFSK	Hopping off 2402	Pass
	Hopping off 2480	Pass
	Hopping on	Pass
$\pi/4$ -DQPSK	Hopping off 2402	Pass
	Hopping off 2480	Pass
	Hopping on	Pass
8DPSK	Hopping off 2402	Pass
	Hopping off 2480	Pass
	Hopping on	Pass

9.5. Original test data

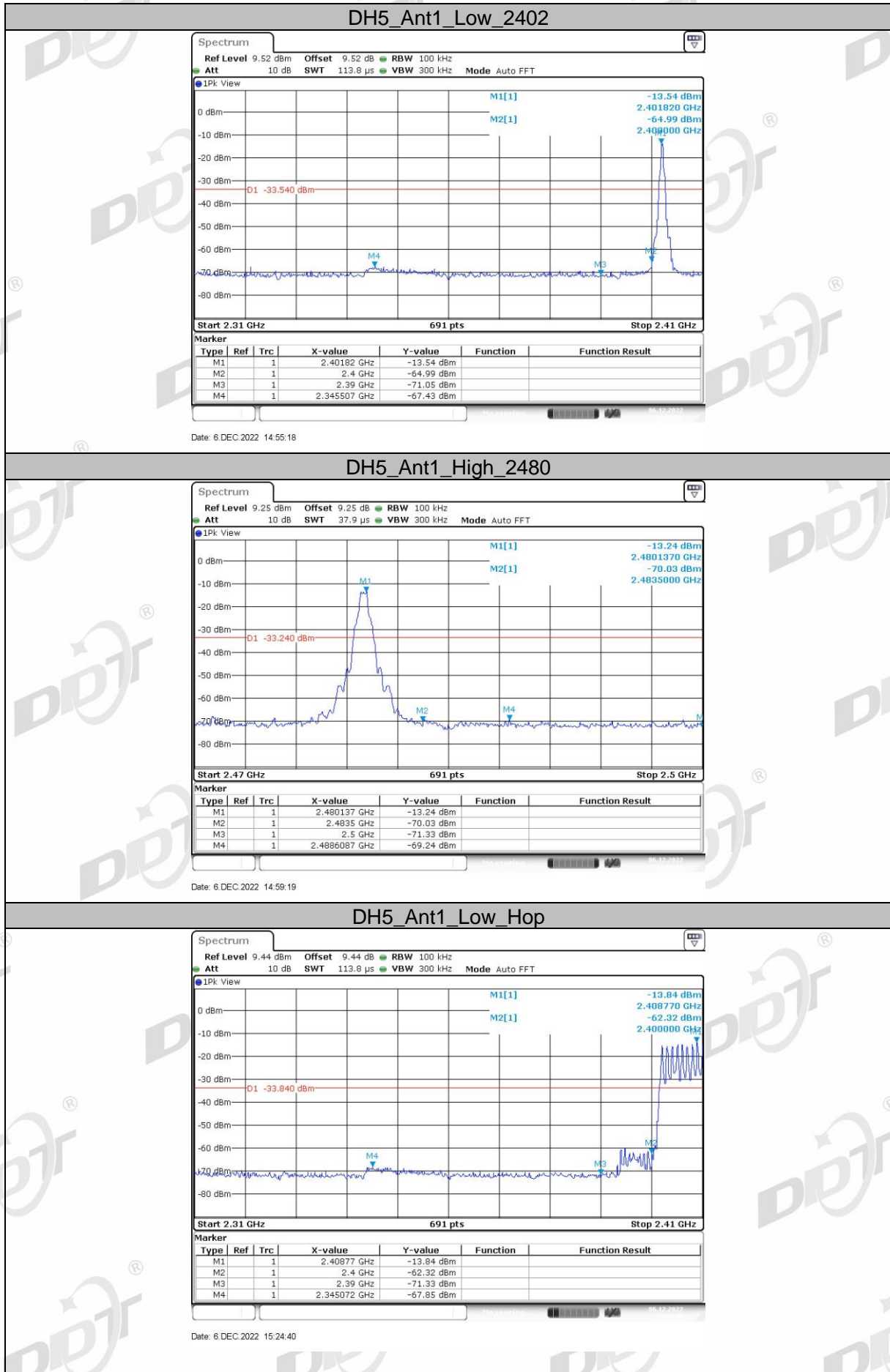

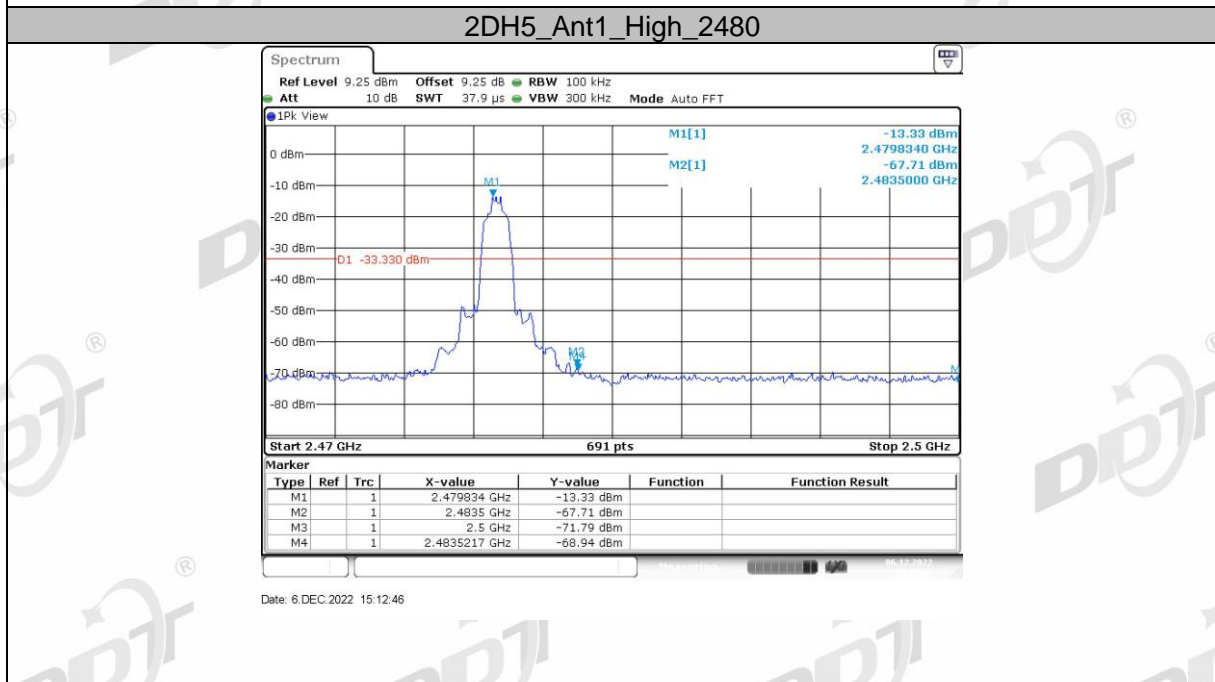
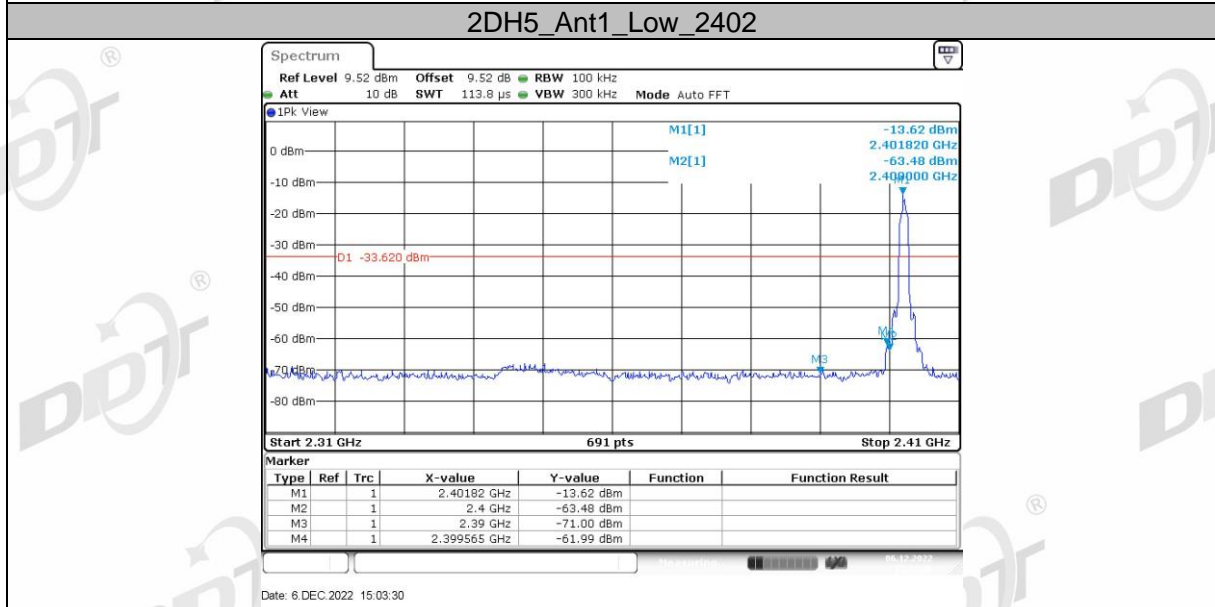
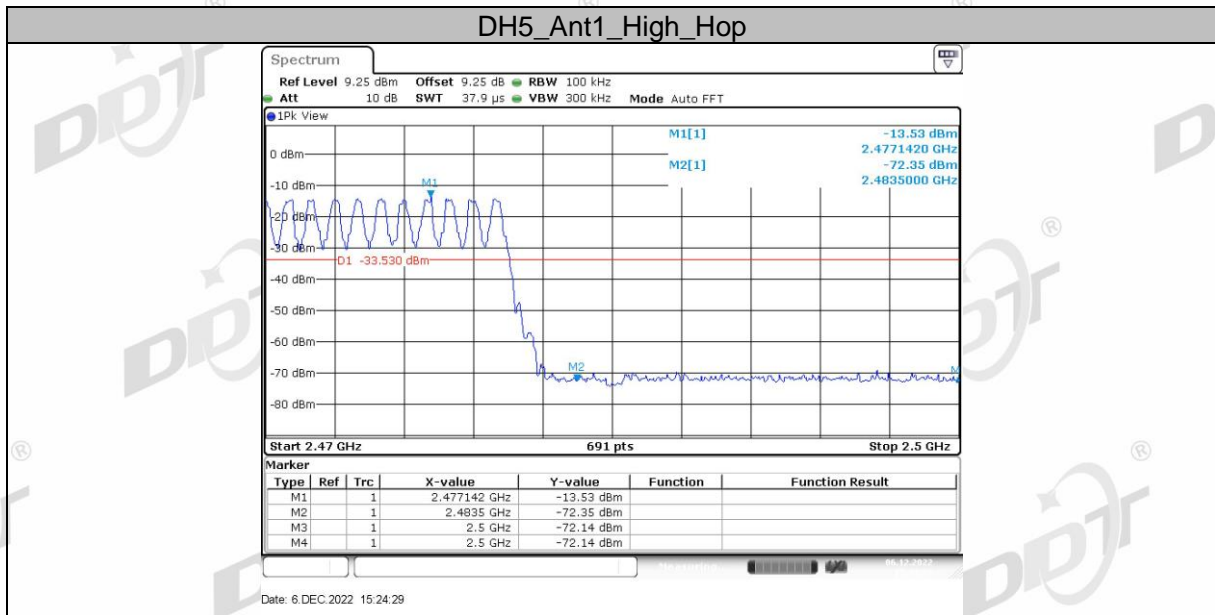

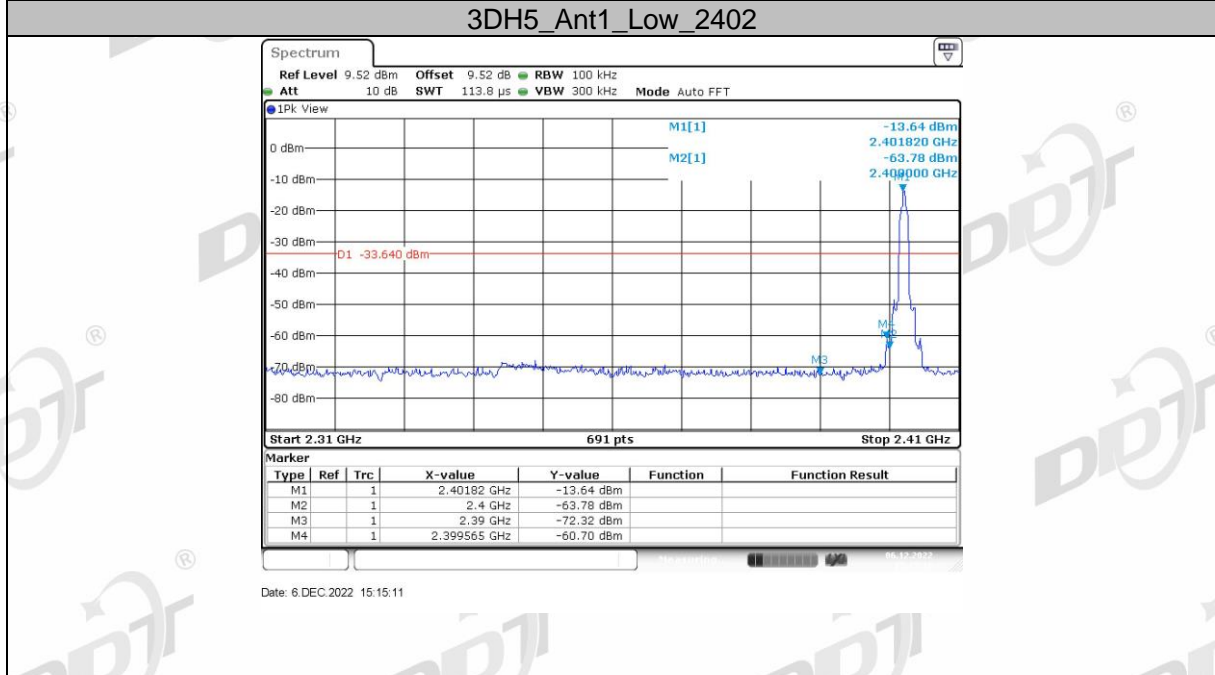
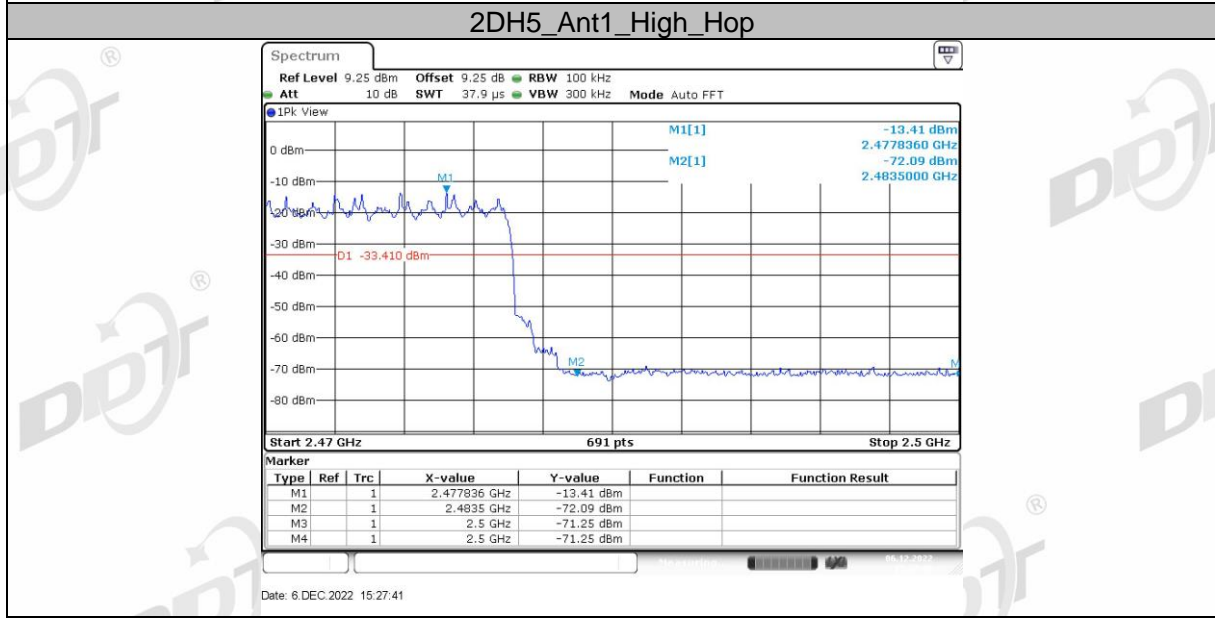
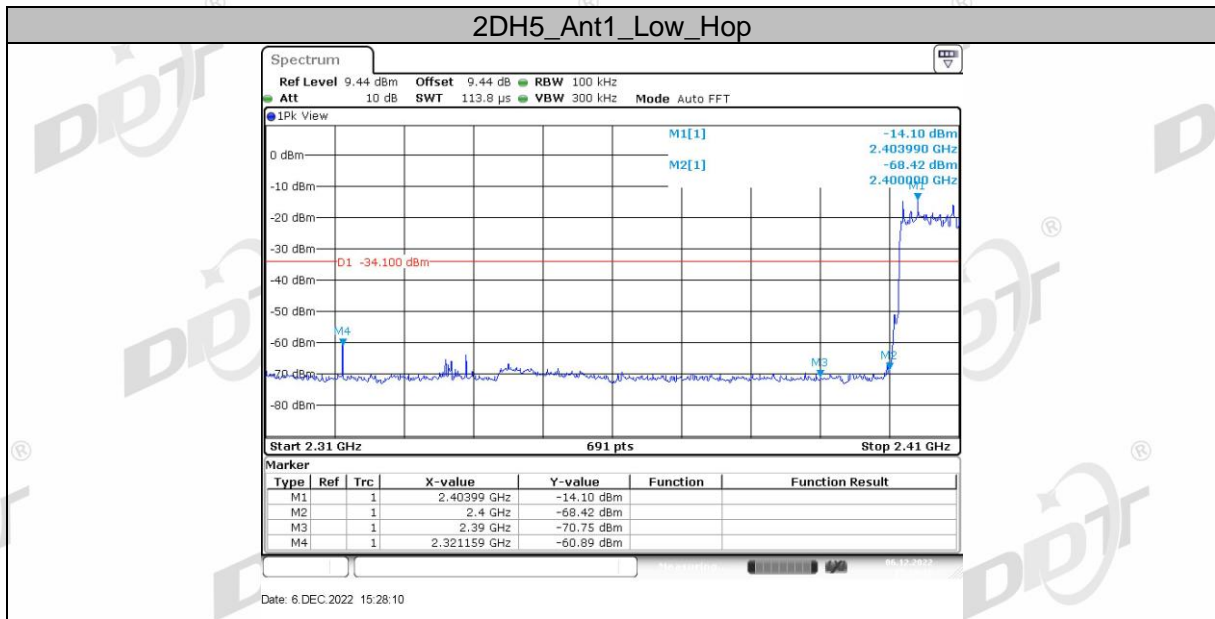

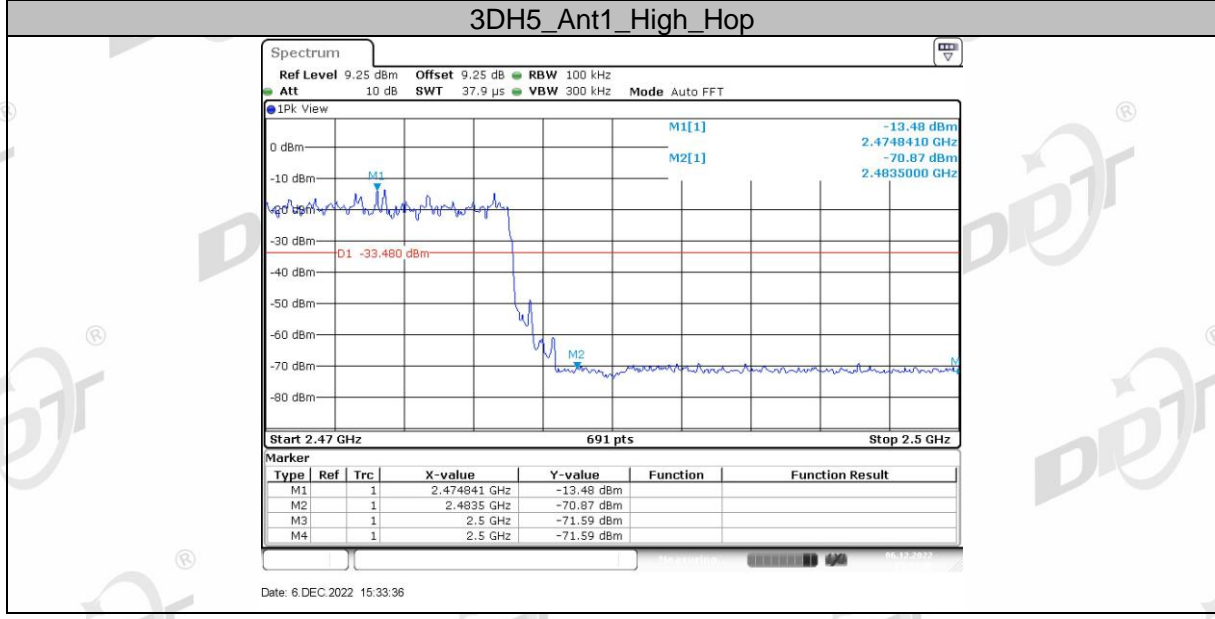
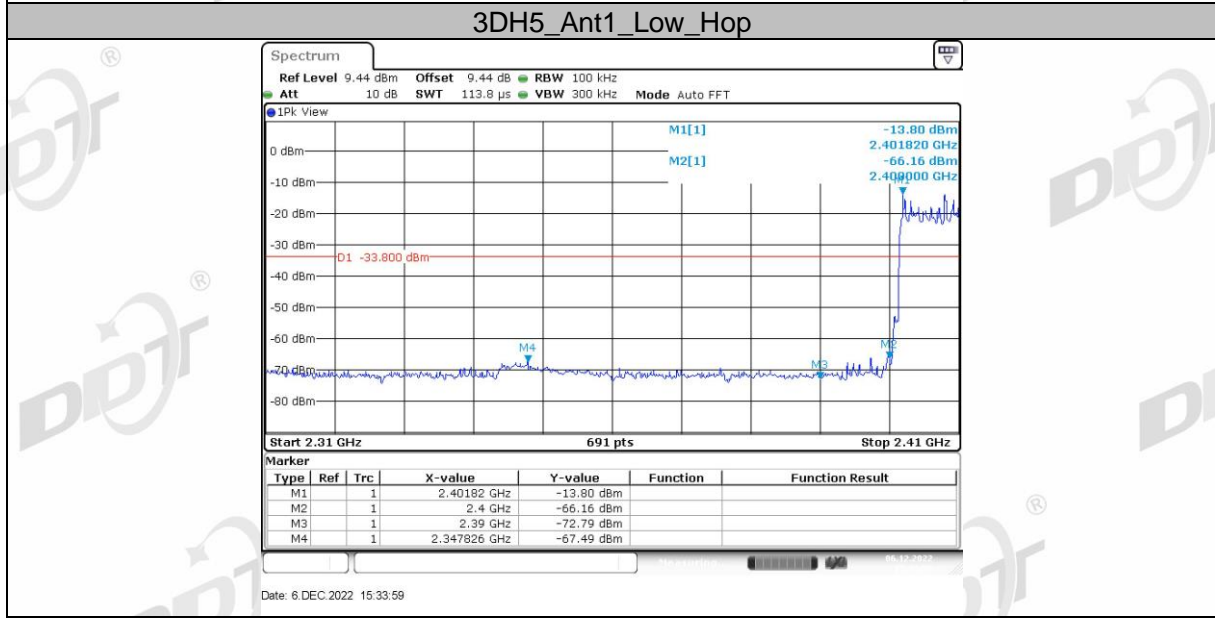
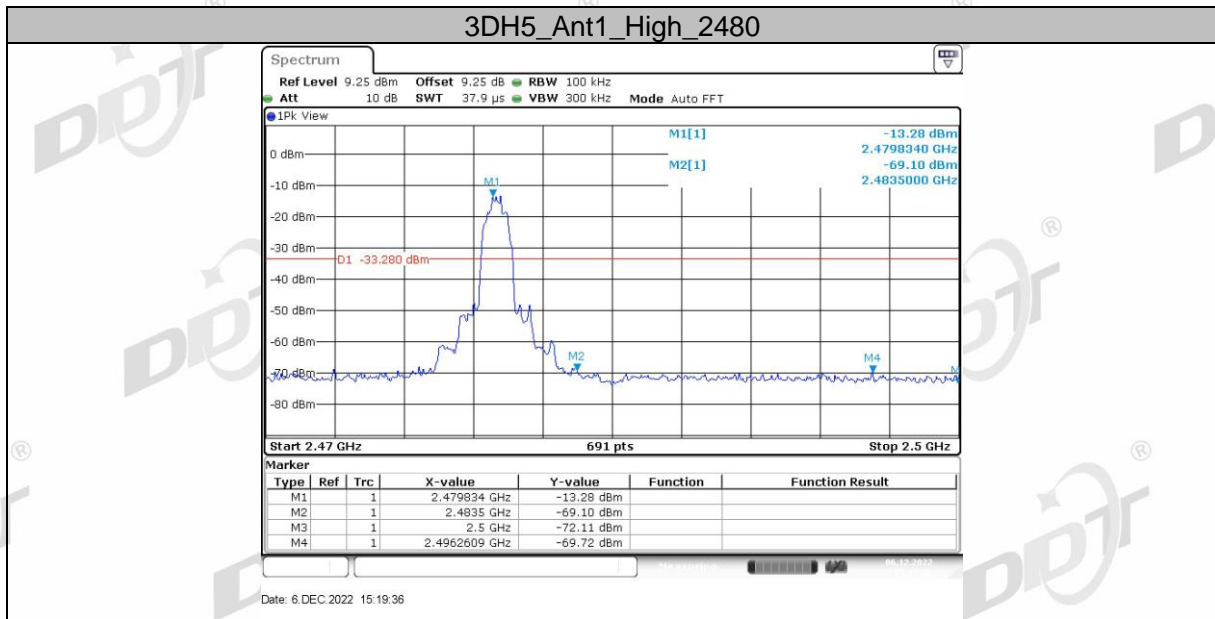

10. Radiated Emission

10.1. Block diagram of test setup

In 3 m Anechoic Chamber, test setup diagram for 9 kHz - 30 MHz:

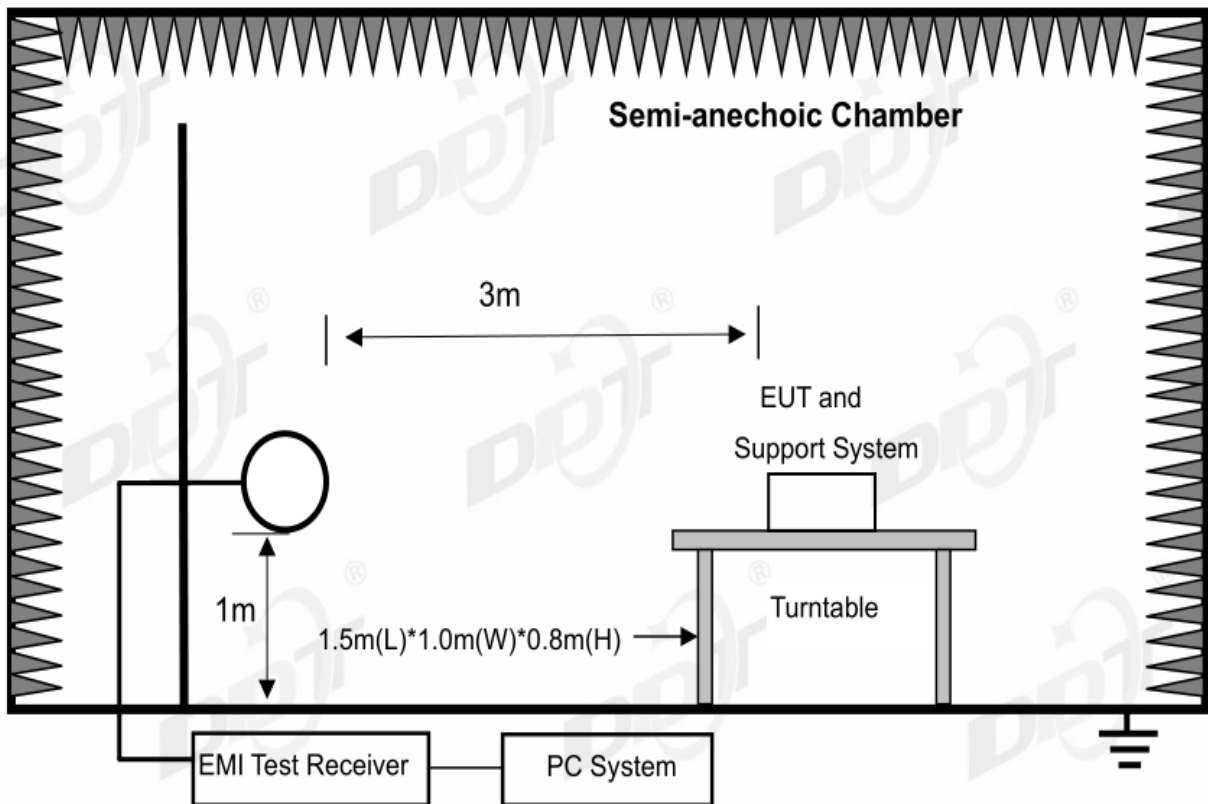

In 3 m Anechoic Chamber, test setup diagram for 30 MHz - 1 GHz:

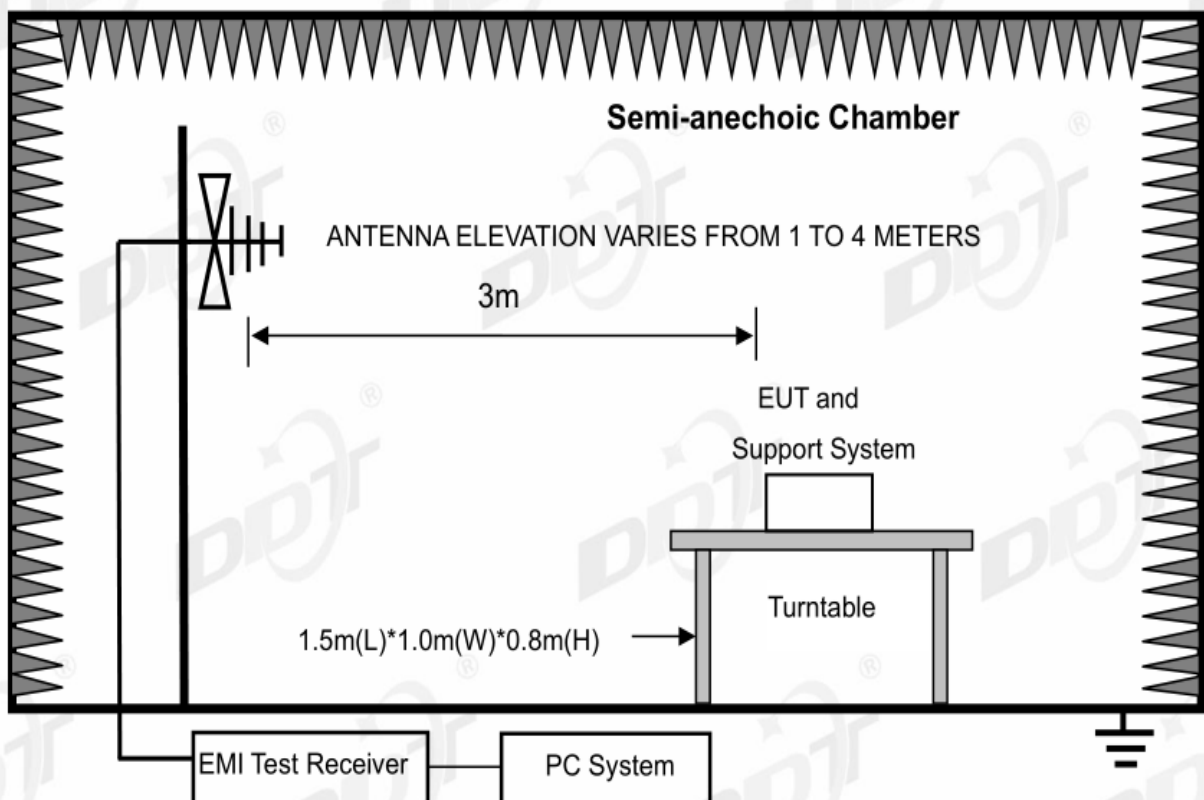

In 3 m Anechoic Chamber, test setup diagram for frequency above 1 GHz:

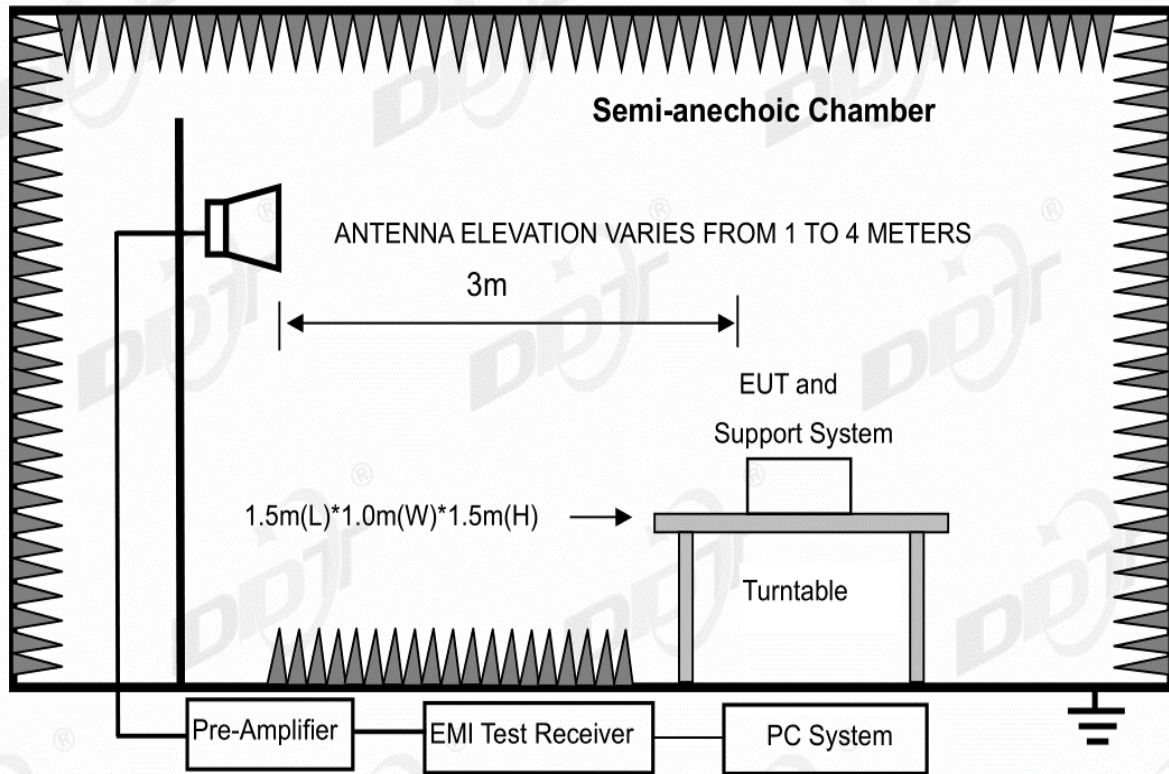

Note: For harmonic emissions test an appropriate high pass filter was inserted in the input port of AMP.

10.2. Limit

(1) FCC 15.205 Restricted frequency band

MHz	MHz	MHz	GHz
0.090-0.110	16.42-16.423	399.9-410	4.5-5.15
¹ 0.495-0.505	16.69475-16.69525	608-614	5.35-5.46
2.1735-2.1905	16.80425-16.80475	960-1240	7.25-7.75
4.125-4.128	25.5-25.67	1300-1427	8.025-8.5
4.1772&4.17775	37.5-38.25	1435-1626.5	9.0-9.2
4.2072&4.20775	73-74.6	1645.5-1646.5	9.3-9.5
6.215-6.218	74.8-75.2	1660-1710	10.6-12.7
6.26775-6.26825	108-121.94	1718.8-1722.2	13.25-13.4
6.31175-6.31225	123-138	2200-2300	14.47-14.5
8.291-8.294	149.9-150.05	2310-2390	15.35-16.2
8.362-8.366	156.52475-156.52525	2483.5-2500	17.7-21.4
8.37625-8.38675	156.7-156.9	2690-2900	22.01-23.12
8.41425-8.41475	162.0125-167.17	3260-3267	23.6-24.0
12.29-12.293	167.72-173.2	3332-3339	31.2-31.8
12.51975-12.52025	240-285	3345.8-3358	36.43-36.5
12.57675-12.57725	322-335.4	3600-4400	(²)
13.36-13.41			

¹Until February 1, 1999, this restricted band shall be 0.490-0.510 MHz.

²Above 38.6