



**CENTRE OF TESTING SERVICE
INTERNATIONAL**

OPERATE ACCORDING TO ISO/IEC 17025

FCC ID TEST REPORT

TEST REPORT NUMBER : CGZ3100507-01560-O



CENTRE OF TESTING SERVICE CO., LTD.

Building F, Dachuang industrial park, No.379, Zhongshan Dadao,
Guangzhou, China.



TEST REPORT For FCC ID	
47 CFR PART 15 OCT, 2009	
Report Reference No.	CGZ3100507-01560-O
Date of issue	26 May 2010
Testing Laboratory Name	CETRE OF TESTING SERVICE CO., LTD
Address	Building F, Dachuang industrial park, No.379, Zhongshan Dadao, Guangzhou, China.
Testing location/ procedure	Full application of Harmonised standards <input checked="" type="checkbox"/> Partial application of Harmonised standards <input type="checkbox"/> Other standard testing method <input type="checkbox"/>
Applicant's name	QOMO HiteVision, LLC.
Address	28265 Beck Road, Suite C1, Wixom, MI 48393, USA
Test specification	
Standard	47 CFR PART 15 OCT, 2009
Test Report Form No.	CTSEMC-1.0
TRF Originator	CENTRE OF TESTING SERVICE CO., LTD
Master TRF	Dated 2009-01
CENTRE OF TESTING SERVICE CO., LTD. All rights reserved.	
This publication may be reproduced in whole or in part for non-commercial purposes as long as the CENTRE OF TESTING SERVICE CO., LTD is acknowledged as copyright owner and source of the material. CENTRE OF TESTING SERVICE CO., LTD takes no responsibility for and will not assume liability for damages resulting from the reader's interpretation of the reproduced material due to its placement and context.	
Test item description	QClick
Trade Mark	QOMO
Manufacturer	QOMO HiteVision, LLC.
Model/Type reference	QRF600, QRF6XX, QRF300, QRF3XX, QRF600-R, QRF300-R
Ratings	DC 5V
Operating Frequency	2404.1 ~ 2480.0MHz ISM Band
Result	Positive

Compiled by:

QuTY Liu / File administrators

Supervised by:

Jackson Zhang / Technique principal

Approved by:

Kevin Liang / Manager

opyright of this report is owned by Centre of Testing Service and may not be reproduced other than in full except with the written approval of the issuing Company.

CENTRE OF TESTING SERVICE CO., LTD.

Building F, Dachuang industrial park, No.379, Zhongshan Dadao, Guangzhou, China

Tel: +86-20-85543113 (32 lines)

Fax: +86-20-38780406

Complaint line: +86-20-85533471

E-mail: cts@cts-lab.com.cn

See Reverse For Terms And Conditions of Service



FCC ID -- TEST REPORT

Test Report No. : CGZ3100507-01560-O	<u>26 May 2010</u> Date of issue
----------------------------------------------------	-------------------------------------

Type / Model.....	QRF600, QRF6XX, QRF300, QRF3XX, QRF600-R, QRF300-R
EUT.....	QClick
Applicant.....	QOMO HiteVision, LLC.
Address.....	28265 Beck Road, Suite C1, Wixom, MI 48393, USA
Telephone.....	+1-866-990-7666
Fax.....	+1-248-281-1999
Contact.....	Weihua Li
Manufacturer.....	QOMO HiteVision, LLC.
Address.....	28265 Beck Road, Suite C1, Wixom, MI 48393, USA
Telephone.....	+1-866-990-7666
Fax.....	+1-248-281-1999
Contact.....	Weihua Li
Test report holder.....	QOMO HiteVision, LLC.
Address.....	28265 Beck Road, Suite C1, Wixom, MI 48393, USA
Telephone.....	+1-866-990-7666
Fax.....	+1-248-281-1999
Contact.....	Weihua Li

Test Result according to the standards on page 3: Positive

The test report merely corresponds to the test sample.
 It is not permitted to copy extracts of these test result without the written permission of the test laboratory.

copyright of this report is owned by Centre of Testing Service and may not be reproduced other than in full except with the written approval of the issuing Company.



TABLE OF CONTENTS

<u>Description</u>	<u>Page</u>
1 TEST STANDARDS.....	5
2 SUMMARY	5
2.1 GENERAL REMARKS.....	5
2.2 FINAL ASSESSMENT	5
3 EQUIPMENT UNDER TEST	5
3.1 POWER SUPPLY SYSTEM UTILISED	5
3.2 SHORT DESCRIPTION OF THE EQUIPMENT UNDER TEST (EUT)	5
3.3 EUT OPERATION MODE	5
3.4 EUT CONFIGURATION	6
4 TEST ENVIRONMENT	8
4.1 ADDRESS OF THE TEST LABORATORY	8
4.2 TEST FACILITY	8
4.3 ENVIRONMENTAL CONDITIONS	8
4.4 DEFINITIONS OF SYMBOLS USED IN THIS TEST REPORT	8
4.5 STATEMENT OF THE MEASUREMENT UNCERTAINTY	8
4.6 MEASUREMENT UNCERTAINTY.....	9
5 SUMMARY OF STANDARDS AND RESULTS	9
5.1.DESCRPTION OF STANDARDS AND RESULTS	9
6 POWER LINE CONDUCTED EMISSION TEST.....	10
6.1.TEST EQUIPMENT.....	10
6.2.BLOCK DIAGRAM OF TEST SETUP	10
6.3.POWER LINE CONDUCTED EMISSION TEST LIMITS	11
6.4.CONFIGURATION OF EUT ON TEST	11
6.5. OPERATING CONDITION OF EUT.....	11
6.6.TEST PROCEDURE	11
6.7.POWER LINE CONDUCTED EMISSION TEST RESULTS.....	11
7 RADIATED DISTURBANCE (ELECTRIC FIELD).....	24
7.1.TEST EQUIPMENT.....	24
7.2.BLOCK DIAGRAM OF TEST SETUP	24
7.3.RADIATED EMISSION LIMIT STANDARD: FCC 15.249.....	25
7.4.EUT CONFIGURATION ON TEST	25
7.5.OPERATING CONDITION OF EUT.....	25
7.6.TEST PROCEDURE	26
7.7.RADIATED EMISSION TEST RESULTS	26

copyright of this report is owned by Centre of Testing Service and may not be reproduced other than in full except with the written approval of the issuing Company.

CENTRE OF TESTING SERVICE CO., LTD.

Building F, Dachuang industrial park, No.379, Zhongshan Dadao, Guangzhou, China

Tel: +86-20-85543113 (32 lines)

Fax: +86-20-38780406

Complaint line: +86-20-85533471

E-mail: cts@cts-lab.com.cn

See Reverse For Terms And Conditions of Service



8 BAND EDGE COMPLIANCE MEASUREMENT45

8.1.TEST EQUIPMENT.....45

8.2.TEST INFORMATION.....45

8.3.TEST RESULTS45

9 DEVIATION TO TEST SPECIFICATIONS.....50

copyright of this report is owned by Centre of Testing Service and may not be reproduced other than in full except with the written approval of the issuing Company.

CENTRE OF TESTING SERVICE CO., LTD.

Building F, Dachuang industrial park, No.379, Zhongshan Dadao, Guangzhou, China

Tel: +86-20-85543113 (32 lines)

Fax: +86-20-38780406

Complaint line: +86-20-85533471

E-mail: cts@cts-lab.com.cn

See Reverse For Terms And Conditions of Service



1 TEST STANDARDS

The tests were performed according to following standards:

- 47 CFR PART 15 July 10, 2008
- ANSI C63.4-2003

2 SUMMARY

2.1 GENERAL REMARKS

Date of receipt of test sample	31 August 2009
Testing commenced on	01 September 2009
Testing concluded on	11 September 2009

2.2 FINAL ASSESSMENT

The FCC requirements pertaining to the technical standards and tested operation modes are

- - fulfilled.
- **not** fulfilled.

The equipment under test

- - fulfils the FCC requirements cited on page 3.
- **does not** fulfil the FCC requirements cited on page 3.

3 EQUIPMENT UNDER TEST

3.1 Power supply system utilised

Power supply voltage : ■ DC 5V From USB port with PC AC 115V/60Hz

3.2 Short description of the Equipment under Test (EUT)

Number of tested samples: 1
Serial number: Prototype

3.3 EUT operation mode

The equipment under test was operated during the measurement under the following conditions:

- Standby
- - Test program (customer specific)

Operation mode 1: Channel 0 (2404.1MHz), Channel 24 (2440.0MHz), Channel 49 (2480.0MHz)

Note: X position of EUT is the worst case, so only these test results be recorded in the test report.

opyright of this report is owned by Centre of Testing Service and may not be reproduced other than in full except with the written approval of the issuing Company.

CENTRE OF TESTING SERVICE CO., LTD.

Building F, Dachuang industrial park, No.379, Zhongshan Dadao, Guangzhou, China

Tel: +86-20-85543113 (32 lines)

Fax: +86-20-38780406

Complaint line: +86-20-85533471

E-mail: cts@cts-lab.com.cn

See Reverse For Terms And Conditions of Service



3.4 EUT configuration

3.4.1. Description of configuration (EUT)

3.4.1.1. EUT Information

Description	:	QClick
Model Number	:	QRF600
Operation frequency	:	2404.1 ~ 2480.0MHz ISM Band
Radio Technology	:	MSK
Modulation Technology	:	MSK modulation
Antenna	:	Integral antenna, met requirement of FCC 15.203
Antenna Assembly Gain	:	0dBi (maximum)

Differences among these models

Product Name	Model Number	Enclose	Color	PCB Layout	Structure	Figure	Button	Component
QClick	QRF600	as sample	Black	as sample	as sample	as sample	as sample	as sample
QClick	QRF6XX	same as the sample	same as the sample	same as the sample	same as the sample	same as the sample	same as the sample	same as the sample
QClick	QRF60-R	same as the sample	same as the sample	same as the sample	same as the sample	same as the sample	same as the sample	same as the sample
QClick	QRF300	same as the sample	same as the sample	same as the sample	same as the sample	same as the sample	same as the sample	same as the sample
QClick	QRF3XX	same as the sample	same as the sample	same as the sample	same as the sample	same as the sample	same as the sample	same as the sample
QClick	QRF300-R	same as the sample	same as the sample	same as the sample	same as the sample	same as the sample	same as the sample	same as the sample

3.4.2. Tested Supporting System Details

3.4.1. Monitor

M/N	:	E7722-f
S/N	:	CN-02W486-64180-3B7-01MP
Manufacturer	:	DELL
D-Sub Cable	:	Shielded, Detachabled, 1.8m Add two cores
Power Cord	:	Unshielded, Detachabled, 1.8m , 3Pin
FCC ID	:	By DoC

opyright of this report is owned by Centre of Testing Service and may not be reproduced other than in full except with the written approval of the issuing Company.

CENTRE OF TESTING SERVICE CO., LTD.

Building F, Dachuang industrial park, No.379, Zhongshan Dadao, Guangzhou, China

Tel: +86-20-85543113 (32 lines)

Fax: +86-20-38780406

Complaint line: +86-20-85533471

E-mail: cts@cts-lab.com.cn

See Reverse For Terms And Conditions of Service



3.4.2. Personal Computer

M/N	:	DIMENSION 4600
S/N	:	CN-OTO486-42940-37M-00XB
Manufacturer	:	DELL
Power Cord	:	Unshielded, Detachabled, 1.8m , 3Pin
FCC ID	:	By DoC

3.4.3. Keyboard

M/N	:	SK-8110
S/N	:	CN-07N244-71616-37T-B293
Manufacturer	:	DELL
Data Cable	:	Shielded, Detachabled
FCC ID	:	By DoC

3.4.4. Mouse

M/N	:	M-UR69
S/N	:	LNA33029188
Manufacturer	:	DELL
Data Cable	:	Shielded, Detachabled, 1.8m
FCC ID	:	By DoC

3.4.5. Printer

M/N	:	IP1600
S/N	:	CGKGB50919
Manufacturer	:	Canon
Data Cable	:	Shielded, Detachabled, 1.8m. 2Pin
FCC ID	:	By DoC

3.4.6. Modem

M/N	:	MT800
S/N	:	421033
Manufacturer	:	HUAWEI
Data Cable	:	Shielded, Detachabled, 1.8m , 2Pin
FCC ID	:	By DoC

copyright of this report is owned by Centre of Testing Service and may not be reproduced other than in full except with the written approval of the issuing Company.

CENTRE OF TESTING SERVICE CO., LTD.

Building F, Dachuang industrial park, No.379, Zhongshan Dadao, Guangzhou, China

Tel: +86-20-85543113 (32 lines)

Fax: +86-20-38780406

Complaint line: +86-20-85533471

E-mail: cts@cts-lab.com.cn

See Reverse For Terms And Conditions of Service

4 TEST ENVIRONMENT

4.1 Address of the test laboratory

Building F, Dachuang industrial park, No.379, Zhongshan Dadao, Guangzhou, China

Tel: +86-20-85543113 (32 lines)

Fax: +86-20-38780406

4.2 Test facility

The test facility is recognized, certified, or accredited by the following organizations:

CNAS-Lab Code: L3394

CENTRE OF TESTING SERVICE CO., LTD has been assessed and proved to be in compliance with CNAS-CL01: 2006 Accreditation Criteria for Testing and Calibration Laboratories (identical to ISO/IEC 17025: 2005 General Requirements) for the Competence of Testing and Calibration Laboratories.

IC-Registration No.: 8374

The 3m Alternate Test Site of CENTRE OF TESTING SERVICE CO., LTD has been registered by Certification and Engineering Bureau of Industry Canada for the performance of radiated measurements with Registration No. 8374 on June 24, 2009 .

FCC-Registration No.: 971995

CENTRE OF TESTING SERVICE CO., LTD, EMC Laboratory has been registered and fully described in a report filed with the FCC (Federal Communications Commission). The acceptance letter from the FCC is maintained in our files. Registration No.791995, July 21, 2009.

4.3 Environmental conditions

During the measurement the environmental conditions were within the listed ranges:

Temperature:	15~35 ° C
Humidity:	25~75 %
Atmospheric pressure:	86~106 kPa

4.4 Definitions of symbols used in this test report

- - The black square indicates that the listed condition, standard or equipment is applicable for this report.
- - The empty square indicates that the listed condition, standard or equipment is **not** applicable for this report.

4.5 Statement of the measurement uncertainty

The data and results referenced in this document are true and accurate. The reader is cautioned that there may be errors within the calibration limits of the equipment and facilities. The measurement uncertainty was calculated for all measurements listed in this test report acc. to CISPR 16 - 4 "Specification for radio disturbance and immunity measuring apparatus and methods – Part 4: Uncertainty in EMC Measurements" and is documented in the CTS quality system acc. to DIN EN ISO/IEC 17025. Furthermore, component and process variability of devices similar to that tested may result in additional deviation. The manufacturer has the sole responsibility of continued compliance of the device.

Copyright of this report is owned by Centre of Testing Service and may not be reproduced other than in full except with the written approval of the issuing Company.

CENTRE OF TESTING SERVICE CO., LTD.

Building F, Dachuang industrial park, No.379, Zhongshan Dadao, Guangzhou, China

Tel: +86-20-85543113 (32 lines)

Fax: +86-20-38780406

Complaint line: +86-20-85533471

E-mail: cts@cts-lab.com.cn

See Reverse For Terms And Conditions of Service



4.6 Measurement Uncertainty

Test Item	Frequency Range	Uncertainty	Note
Conduction disturbance	150kHz~30MHz	±1.22dB	(1)
Power disturbance	30MHz~300MHz	±1.38dB	(1)
Radiation emission (3m)	30MHz~300MHz	±3.14dB	(1)
	300MHz~1000MHz	±3.18dB	(1)

(1).This uncertainty represents an expanded uncertainty expressed at approximately the 95% confidence level using a coverage factor of k=2.

5 Summary of standards and results

5.1.Description of Standards and Results

The EUT have been tested according to the applicable standards as referenced below.

EMISSION		
Description of Test Item	Standard	Results
Conducted Disturbance Emission Test	FCC Part 15 C: 15.207 ANSI C63.4-2009	PASS
Radiated Emission Test	FCC Part 15 C: 15.249 ANSI C63.4-2009	PASS
Band Edge Compliance Test	FCC Part 15 C: 15.249 ANSI C63.4-2009	PASS

N/A is an abbreviation for Not Applicable.

copyright of this report is owned by Centre of Testing Service and may not be reproduced other than in full except with the written approval of the issuing Company.

CENTRE OF TESTING SERVICE CO., LTD.

Building F, Dachuang industrial park, No.379, Zhongshan Dadao, Guangzhou, China

Tel: +86-20-85543113 (32 lines)

Fax: +86-20-38780406

Complaint line: +86-20-85533471

E-mail: cts@cts-lab.com.cn

See Reverse For Terms And Conditions of Service

6 Power line conducted Emission Test

6.1. Test Equipment

Conducted Disturbance					
Item	Test Equipment	Manufacturer	Model No.	Serial No.	Last Cal.
1	EMI Test Receiver	ROHDE & SCHWARZ	ESHS10	842884/012	2008/12
2	Artificial Mains	ROHDE & SCHWARZ	ESH3-Z5	832479/025	2008/12
3	Artificial Mains	ROHDE & SCHWARZ	ESH3-Z5	832479/026	2008/12
4	Pulse Limiter	ROHDE & SCHWARZ	ESHSZ2	100301	2008/12
5	EMI Test Software	ROHDE & SCHWARZ	ESK1	N/A	2008/12

6.2. Block Diagram of Test Setup

6.2.1 Block Diagram of connection between EUT and simulators

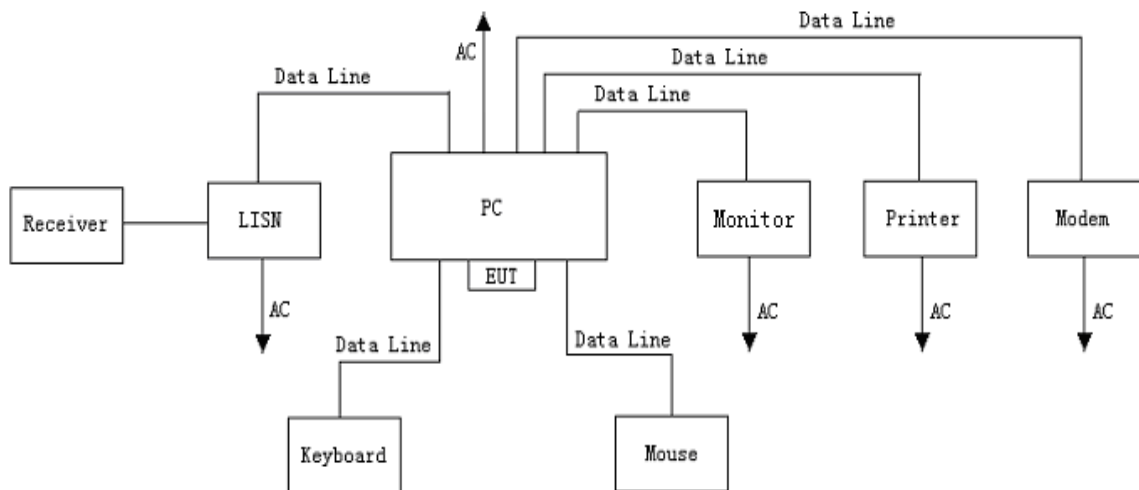

(EUT: Qclick)

Copyright of this report is owned by Centre of Testing Service and may not be reproduced other than in full except with the written approval of the issuing Company.

CENTRE OF TESTING SERVICE CO., LTD.

Building F, Dachuang industrial park, No.379, Zhongshan Dadao, Guangzhou, China

Tel: +86-20-85543113 (32 lines)

Fax: +86-20-38780406

Complaint line: +86-20-85533471

E-mail: cts@cts-lab.com.cn

See Reverse For Terms And Conditions of Service



6.3. Power Line Conducted Emission Test Limits

Frequency	Maximum RF Line Voltage	
	Quasi-Peak Level dB(μV)	Average Level dB(μV)
150kHz ~ 500kHz	66 ~ 56*	56 ~ 46*
500kHz ~ 5MHz	56	46
5MHz ~ 30MHz	60	50

Notes: 1. * Decreasing linearly with logarithm of frequency.
 2. The lower limit shall apply at the transition frequencies.

6.4. Configuration of EUT on Test

The following equipment are installed on Power Line Conducted Emission Test to meet the commission requirement and operating regulations in a manner which tends to maximize its emission characteristics in a normal application

6.5. Operating Condition of EUT

- 6.5.1. Setup the EUT and simulator as shown as Section 6.2.
- 6.5.2. Turn on the power of all equipment.
- 6.5.3. Let the EUT work in test mode (TX) and measurement it.

6.6. Test Procedure

The EUT Via PC Power connected to the power mains through a line impedance stabilization network (L.I.S.N.#2). This provides a 50 ohm coupling impedance for the EUT. Please refer the block diagram of the test setup and photographs. The other peripheral devices power cord connected to the power mains through a line impedance stabilization network (L.I.S.N.#1). Power on the PC and let it work normally, we use a keyboard test soft ware, let EUT working in test mode, then test it. Both sides of AC line are checked to find out the maximum conducted emission. In order to find the maximum emission levels, the relative positions of equipment and all of the interface cables shall be changed according to FCC Part 15C on Conducted Emission Test.

The bandwidth of test receiver (R & S ESHS 10) is set at 10kHz.

The frequency range from 150kHz to 30MHz is checked.

The test result are reported on Section 6.7.

6.7. Power Line Conducted Emission Test Results

PASSED

copyright of this report is owned by Centre of Testing Service and may not be reproduced other than in full except with the written approval of the issuing Company.



Channel:	0 (2404.1MHz)	Result:	<input checked="" type="checkbox"/> - passed
Test point	Va		<input type="checkbox"/> - not passed

EUT	QClick
Firm Name	QOMO HiteVision, LLC.
Operating Condition	DC 5V
Test Condition	Ambient Temperature: 25°C Humidity: 56%
Operator	Jackson
MODEL NO	QRF600, QRF6XX, QRF300, QRF3XX, QRF600-R, QRF300-R

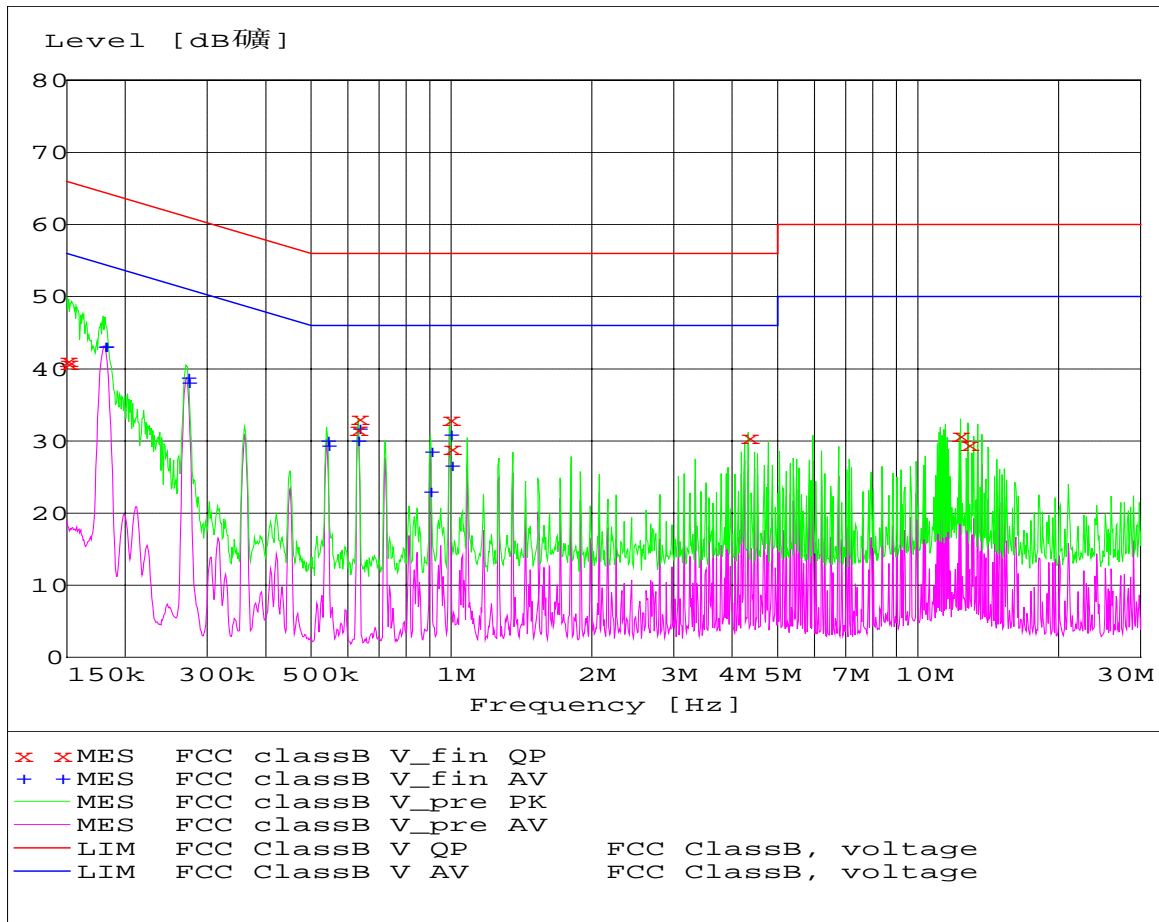

Copyright of this report is owned by Centre of Testing Service and may not be reproduced other than in full except with the written approval of the issuing Company.

CENTRE OF TESTING SERVICE CO., LTD.

Building F, Dachuang industrial park, No.379, Zhongshan Dadao, Guangzhou, China

Tel: +86-20-85543113 (32 lines)

Fax: +86-20-38780406

Complaint line: +86-20-85533471

E-mail: cts@cts-lab.com.cn

See Reverse For Terms And Conditions of Service



MEASUREMENT RESULT: "FCC classB V_fin QP"

Frequency MHz	Level dBµV	Transd dB	Limit dBµV	Margin dB	Line	PE
0.150000	41.20	10.2	66	24.8	Va	GND
0.150600	40.70	10.2	66	25.3	Va	GND
0.628765	31.60	10.1	56	24.4	Va	GND
0.631280	33.10	10.1	56	22.9	Va	GND
0.991142	33.00	10.1	56	23.0	Va	GND
0.995106	29.00	10.1	56	27.0	Va	GND
4.323915	30.60	10.1	56	25.5	Va	GND
12.256780	30.80	9.9	60	29.2	Va	GND
12.806994	29.50	9.9	60	30.5	Va	GND

MEASUREMENT RESULT: "FCC classB V_fin AV"

Frequency MHz	Level dBµV	Transd dB	Limit dBµV	Margin dB	Line	PE
0.180233	43.20	10.2	55	11.3	Va	GND
0.180954	43.10	10.2	54	11.3	Va	GND
0.270814	38.80	10.2	51	12.2	Va	GND
0.271897	38.10	10.2	51	13.0	Va	GND
0.540266	30.10	10.1	46	15.9	Va	GND
0.542427	29.40	10.1	46	16.6	Va	GND
0.628765	30.10	10.1	46	15.9	Va	GND
0.631280	31.70	10.1	46	14.3	Va	GND
0.897004	23.00	10.1	46	23.0	Va	GND
0.900592	28.50	10.1	46	17.5	Va	GND
0.991142	30.90	10.1	46	15.1	Va	GND
0.995106	26.70	10.1	46	19.3	Va	GND

copyright of this report is owned by Centre of Testing Service and may not be reproduced other than in full except with the written approval of the issuing Company.

CENTRE OF TESTING SERVICE CO., LTD.

Building F, Dachuang industrial park, No.379, Zhongshan Dadao, Guangzhou, China

Tel: +86-20-85543113 (32 lines)

Fax: +86-20-38780406

Complaint line: +86-20-85533471

E-mail: cts@cts-lab.com.cn

See Reverse For Terms And Conditions of Service



Channel:	0 (2404.1MHz)	Result:	<input checked="" type="checkbox"/> - passed
Test point	Vb		<input type="checkbox"/> - not passed

EUT	QClick
Firm Name	QOMO HiteVision, LLC.
Operating Condition	DC 5V
Test Condition	Ambient Temperature: 25°C Humidity: 56%
Operator	Jackson
MODEL NO	QRF600, QRF6XX, QRF300, QRF3XX, QRF600-R, QRF300-R

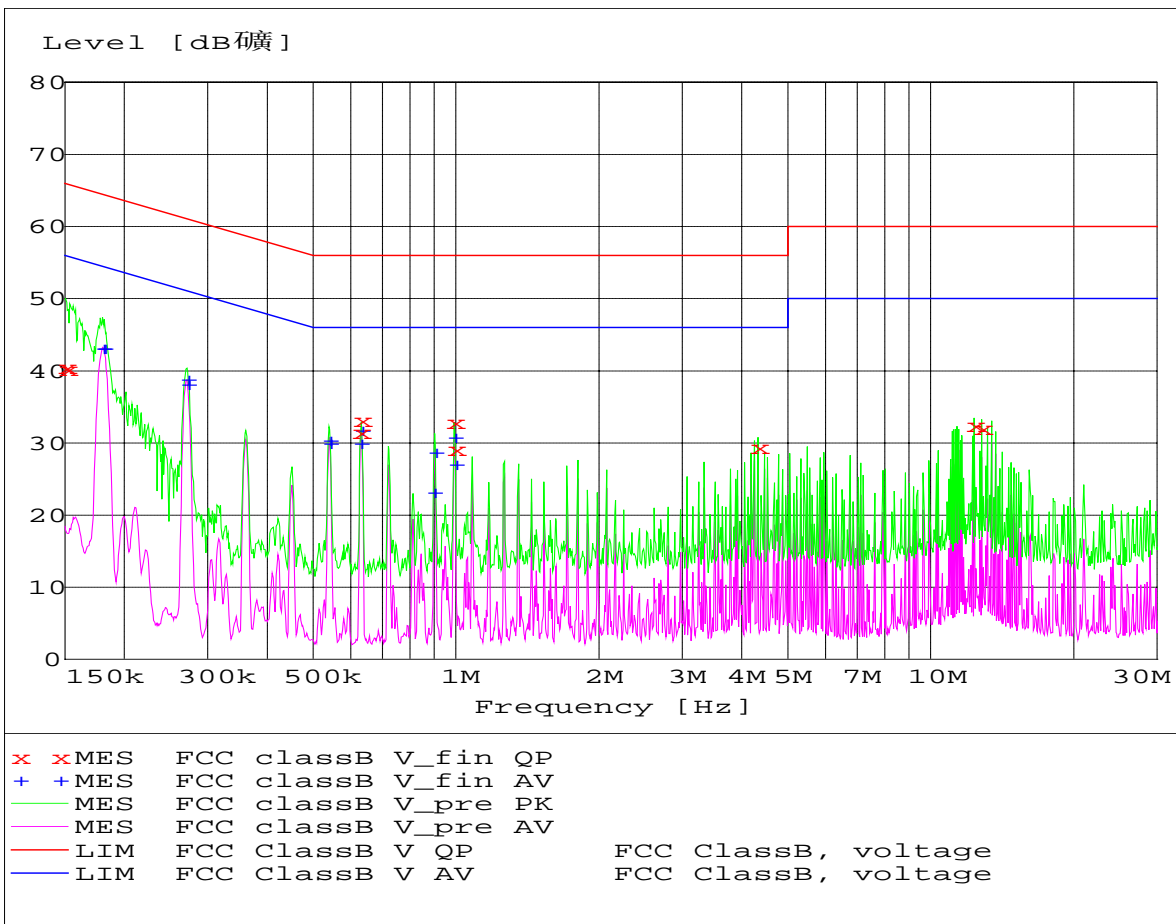

copyright of this report is owned by Centre of Testing Service and may not be reproduced other than in full except with the written approval of the issuing Company.

CENTRE OF TESTING SERVICE CO., LTD.

Building F, Dachuang industrial park, No.379, Zhongshan Dadao, Guangzhou, China

Tel: +86-20-85543113 (32 lines)

Fax: +86-20-38780406

Complaint line: +86-20-85533471

E-mail: cts@cts-lab.com.cn

See Reverse For Terms And Conditions of Service

MEASUREMENT RESULT: "FCC classB V_fin QP"

Frequency MHz	Level dB μ V	Transd dB	Limit dB μ V	Margin dB	Line	PE
0.150600	40.50	10.2	66	25.4	Vb	GND
0.151202	40.20	10.2	66	25.7	Vb	GND
0.628765	31.50	10.1	56	24.5	Vb	GND
0.631280	33.20	10.1	56	22.9	Vb	GND
0.991142	32.90	10.1	56	23.1	Vb	GND
0.995106	29.20	10.1	56	26.8	Vb	GND
4.323915	29.40	10.1	56	26.6	Vb	GND
12.355030	32.50	9.9	60	27.5	Vb	GND
12.806994	32.00	9.9	60	28.0	Vb	GND

MEASUREMENT RESULT: "FCC classB V_fin AV"

Frequency MHz	Level dB μ V	Transd dB	Limit dB μ V	Margin dB	Line	PE
0.180233	43.20	10.2	55	11.2	Vb	GND
0.180954	43.10	10.2	54	11.3	Vb	GND
0.270814	38.80	10.2	51	12.2	Vb	GND
0.271897	38.10	10.2	51	12.9	Vb	GND
0.540266	30.40	10.1	46	15.6	Vb	GND
0.542427	29.90	10.1	46	16.1	Vb	GND
0.628765	30.00	10.1	46	16.0	Vb	GND
0.631280	31.70	10.1	46	14.3	Vb	GND
0.897004	23.20	10.1	46	22.8	Vb	GND
0.900592	28.80	10.1	46	17.2	Vb	GND
0.991142	30.80	10.1	46	15.2	Vb	GND
0.995106	27.10	10.1	46	18.9	Vb	GND

copyright of this report is owned by Centre of Testing Service and may not be reproduced other than in full except with the written approval of the issuing Company.

CENTRE OF TESTING SERVICE CO., LTD.

Building F, Dachuang industrial park, No.379, Zhongshan Dadao, Guangzhou, China

Tel: +86-20-85543113 (32 lines)

Fax: +86-20-38780406

Complaint line: +86-20-85533471

E-mail: cts@cts-lab.com.cn

See Reverse For Terms And Conditions of Service



Channel:	24 (2440.0MHz)	Result:	■ - passed
Test point	Va		□ - not passed

EUT	QClick
Firm Name	QOMO HiteVision, LLC.
Operating Condition	DC 5V
Test Condition	Ambient Temperature: 25°C Humidity: 56%
Operator	Jackson
MODEL NO	QRF600, QRF6XX, QRF300, QRF3XX, QRF600-R, QRF300-R

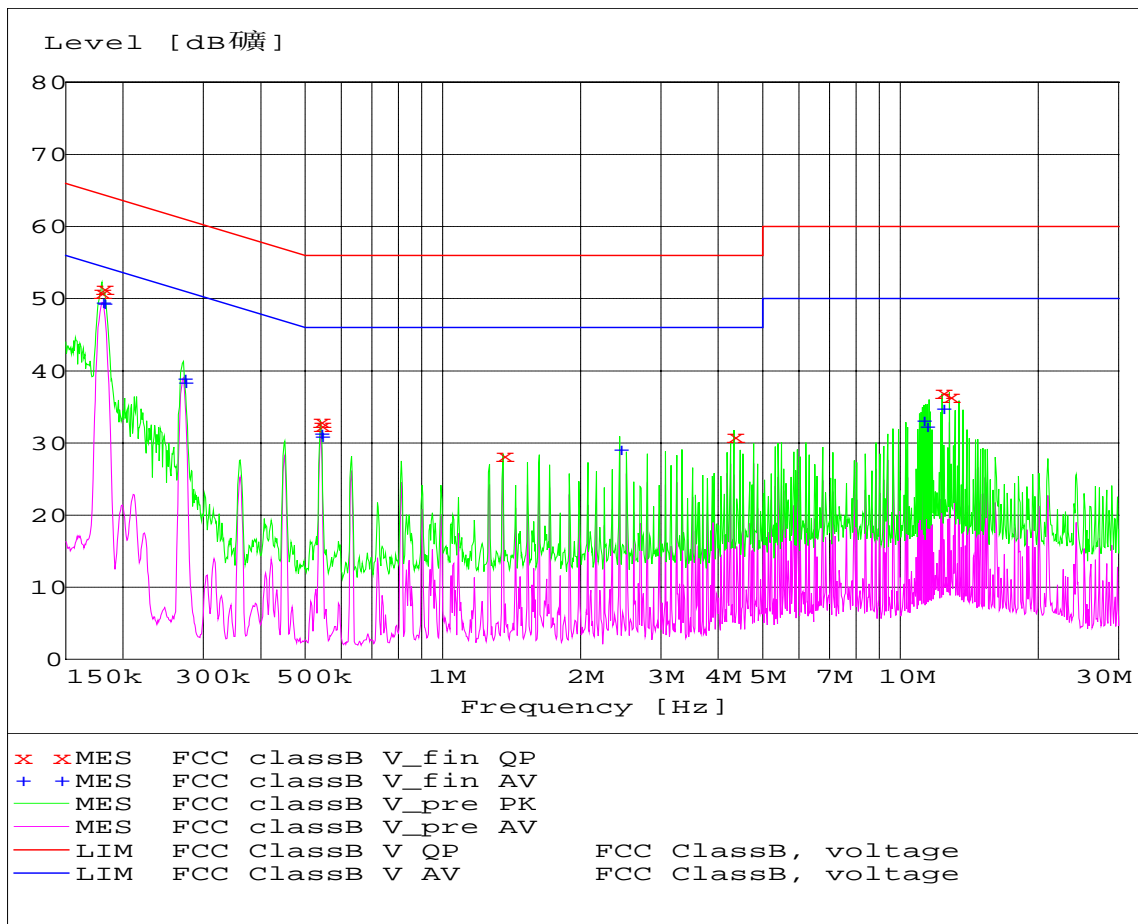

copyright of this report is owned by Centre of Testing Service and may not be reproduced other than in full except with the written approval of the issuing Company.

CENTRE OF TESTING SERVICE CO., LTD.

Building F, Dachuang industrial park, No.379, Zhongshan Dadao, Guangzhou, China

Tel: +86-20-85543113 (32 lines)

Fax: +86-20-38780406

Complaint line: +86-20-85533471

E-mail: cts@cts-lab.com.cn

See Reverse For Terms And Conditions of Service

MEASUREMENT RESULT: "FCC classB V_fin QP"

Frequency MHz	Level dB μ V	Transd dB	Limit dB μ V	Margin dB	Line	PE
0.178800	50.80	10.2	65	13.8	Va	GND
0.180954	51.40	10.2	64	13.0	Va	GND
0.540266	33.00	10.1	56	23.0	Va	GND
0.542427	32.50	10.1	56	23.5	Va	GND
1.353211	28.30	10.1	56	27.7	Va	GND
4.323915	31.00	10.1	56	25.0	Va	GND
12.355030	37.10	9.9	60	22.9	Va	GND
12.806994	36.40	9.9	60	23.6	Va	GND

MEASUREMENT RESULT: "FCC classB V_fin AV"

Frequency MHz	Level dB μ V	Transd dB	Limit dB μ V	Margin dB	Line	PE
0.180233	49.50	10.2	55	4.9	Va	GND
0.180954	49.40	10.2	54	5.0	Va	GND
0.270814	39.00	10.2	51	12.1	Va	GND
0.271897	38.40	10.2	51	12.7	Va	GND
0.540266	31.40	10.1	46	14.6	Va	GND
0.542427	30.90	10.1	46	15.1	Va	GND
2.433451	29.10	10.1	46	16.9	Va	GND
11.181520	33.20	9.9	50	16.8	Va	GND
11.361500	32.30	9.9	50	17.7	Va	GND
12.355030	34.80	9.9	50	15.2	Va	GND

copyright of this report is owned by Centre of Testing Service and may not be reproduced other than in full except with the written approval of the issuing Company.

CENTRE OF TESTING SERVICE CO., LTD.

Building F, Dachuang industrial park, No.379, Zhongshan Dadao, Guangzhou, China

Tel: +86-20-85543113 (32 lines)

Fax: +86-20-38780406

Complaint line: +86-20-85533471

E-mail: cts@cts-lab.com.cn

See Reverse For Terms And Conditions of Service



Channel:	24 (2440.0MHz)	Result:	<input checked="" type="checkbox"/> - passed
Test point	Vb		<input type="checkbox"/> - not passed

EUT	QClick
Firm Name	QOMO HiteVision, LLC.
Operating Condition	DC 5V
Test Condition	Ambient Temperature: 25°C Humidity: 56%
Operator	Jackson
MODEL NO	QRF600, QRF6XX, QRF300, QRF3XX, QRF600-R, QRF300-R

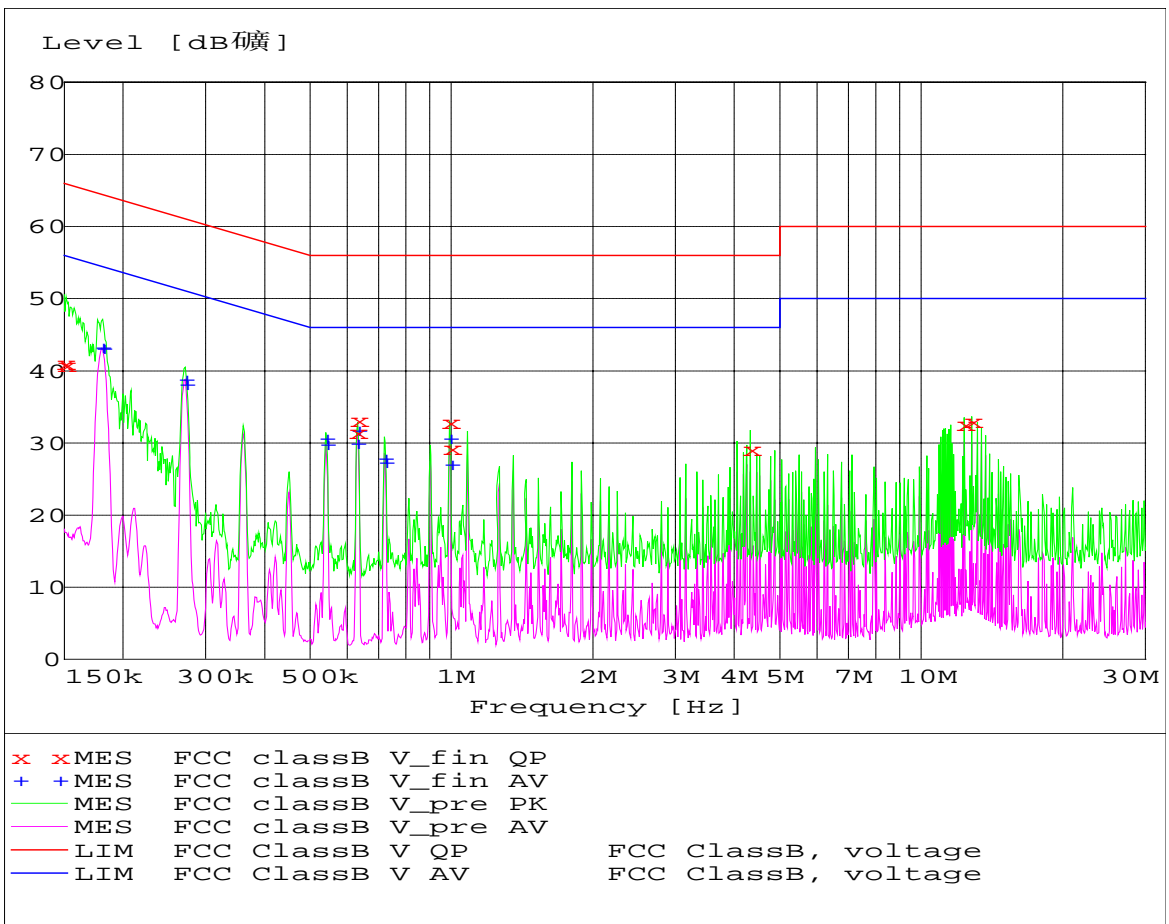

Copyright of this report is owned by Centre of Testing Service and may not be reproduced other than in full except with the written approval of the issuing Company.

CENTRE OF TESTING SERVICE CO., LTD.

Building F, Dachuang industrial park, No.379, Zhongshan Dadao, Guangzhou, China

Tel: +86-20-85543113 (32 lines)

Fax: +86-20-38780406

Complaint line: +86-20-85533471

E-mail: cts@cts-lab.com.cn

See Reverse For Terms And Conditions of Service

MEASUREMENT RESULT: "FCC classB V_fin QP"

Frequency MHz	Level dB μ V	Transd dB	Limit dB μ V	Margin dB	Line	PE
0.150000	41.10	10.2	66	24.9	Vb	GND
0.150600	40.80	10.2	66	25.1	Vb	GND
0.628765	31.50	10.1	56	24.5	Vb	GND
0.631280	33.20	10.1	56	22.9	Vb	GND
0.991142	32.90	10.1	56	23.1	Vb	GND
0.995106	29.30	10.1	56	26.7	Vb	GND
4.323915	29.10	10.1	56	26.9	Vb	GND
12.355030	32.60	9.9	60	27.4	Vb	GND
12.806994	33.00	9.9	60	27.0	Vb	GND

MEASUREMENT RESULT: "FCC classB V_fin AV"

Frequency MHz	Level dB μ V	Transd dB	Limit dB μ V	Margin dB	Line	PE
0.180233	43.30	10.2	55	11.2	Vb	GND
0.180954	43.10	10.2	54	11.3	Vb	GND
0.270814	38.80	10.2	51	12.3	Vb	GND
0.271897	38.10	10.2	51	12.9	Vb	GND
0.540266	30.70	10.1	46	15.3	Vb	GND
0.542427	29.80	10.1	46	16.2	Vb	GND
0.628765	30.00	10.1	46	16.0	Vb	GND
0.631280	31.70	10.1	46	14.3	Vb	GND
0.720177	27.90	10.1	46	18.1	Vb	GND
0.723058	27.30	10.1	46	18.7	Vb	GND
0.991142	30.70	10.1	46	15.3	Vb	GND
0.995106	27.00	10.1	46	19.0	Vb	GND

copyright of this report is owned by Centre of Testing Service and may not be reproduced other than in full except with the written approval of the issuing Company.

CENTRE OF TESTING SERVICE CO., LTD.

Building F, Dachuang industrial park, No.379, Zhongshan Dadao, Guangzhou, China

Tel: +86-20-85543113 (32 lines)

Fax: +86-20-38780406

Complaint line: +86-20-85533471

E-mail: cts@cts-lab.com.cn

See Reverse For Terms And Conditions of Service



Channel:	49 (2480.0MHz)	Result:	■ - passed
Test point	Va		□ - not passed

EUT	QClick
Firm Name	QOMO HiteVision, LLC.
Operating Condition	DC 5V
Test Condition	Ambient Temperature: 25°C Humidity: 56%
Operator	Jackson
MODEL NO	QRF600, QRF6XX, QRF300, QRF3XX, QRF600-R, QRF300-R

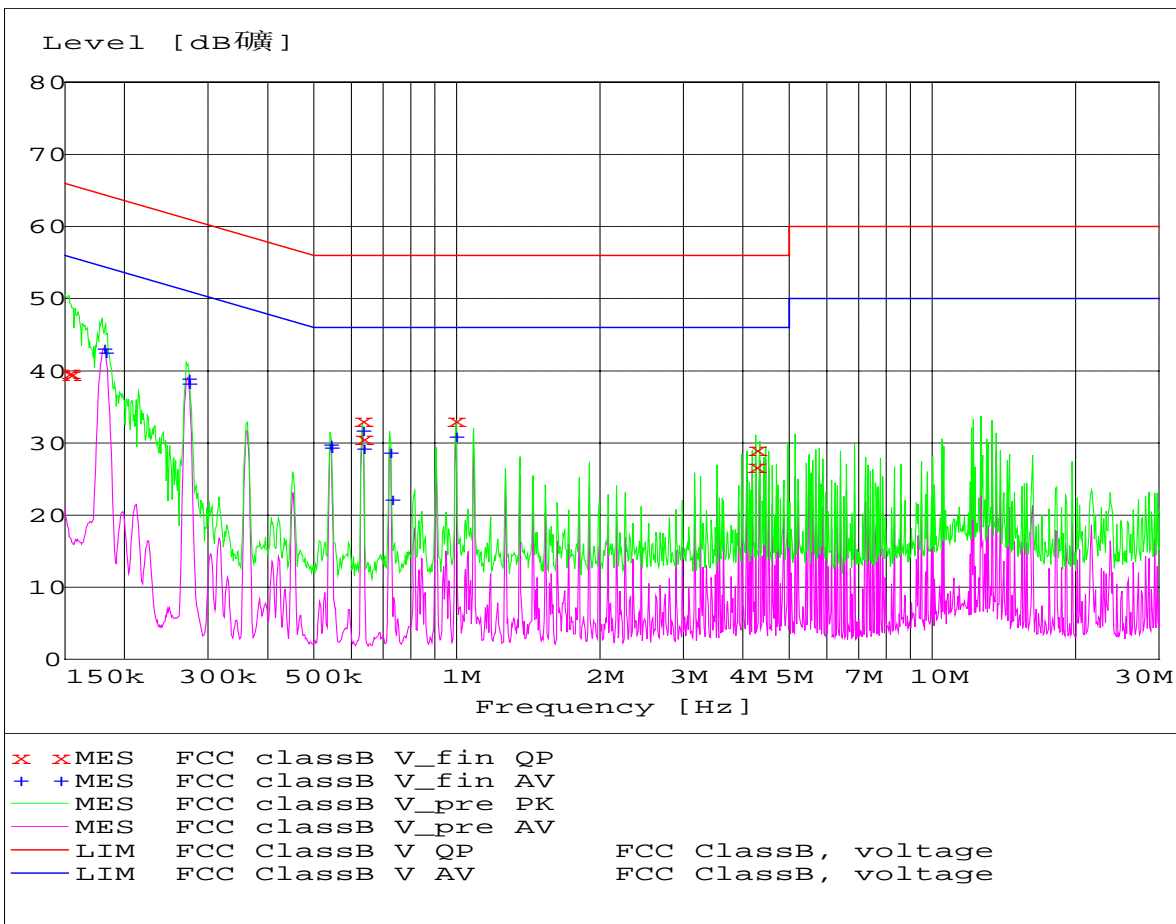

Copyright of this report is owned by Centre of Testing Service and may not be reproduced other than in full except with the written approval of the issuing Company.

CENTRE OF TESTING SERVICE CO., LTD.

Building F, Dachuang industrial park, No.379, Zhongshan Dadao, Guangzhou, China

Tel: +86-20-85543113 (32 lines)

Fax: +86-20-38780406

Complaint line: +86-20-85533471

E-mail: cts@cts-lab.com.cn

See Reverse For Terms And Conditions of Service

MEASUREMENT RESULT: "FCC classB V_fin QP"

Frequency MHz	Level dB μ V	Transd dB	Limit dB μ V	Margin dB	Line	PE
0.153017	39.80	10.2	66	26.1	Va	GND
0.153629	39.50	10.2	66	26.3	Va	GND
0.631285	33.20	10.1	56	22.8	Va	GND
0.633810	30.70	10.1	56	25.3	Va	GND
0.991139	33.10	10.1	56	22.9	Va	GND
4.238466	26.80	10.1	56	29.2	Va	GND
4.255420	29.10	10.1	56	26.9	Va	GND

MEASUREMENT RESULT: "FCC classB V_fin AV"

Frequency MHz	Level dB μ V	Transd dB	Limit dB μ V	Margin dB	Line	PE
0.180228	43.20	10.2	55	11.3	Va	GND
0.181673	42.50	10.2	54	11.9	Va	GND
0.270819	39.00	10.2	51	12.1	Va	GND
0.271902	38.30	10.2	51	12.8	Va	GND
0.540272	29.80	10.1	46	16.2	Va	GND
0.542434	29.40	10.1	46	16.6	Va	GND
0.631285	31.80	10.1	46	14.2	Va	GND
0.633810	29.30	10.1	46	16.7	Va	GND
0.720169	28.80	10.1	46	17.2	Va	GND
0.725942	22.20	10.1	46	23.8	Va	GND
0.991139	31.00	10.1	46	15.0	Va	GND

copyright of this report is owned by Centre of Testing Service and may not be reproduced other than in full except with the written approval of the issuing Company.

CENTRE OF TESTING SERVICE CO., LTD.

Building F, Dachuang industrial park, No.379, Zhongshan Dadao, Guangzhou, China

Tel: +86-20-85543113 (32 lines)

Fax: +86-20-38780406

Complaint line: +86-20-85533471

E-mail: cts@cts-lab.com.cn

See Reverse For Terms And Conditions of Service



Channel:	49 (2480.0MHz)	Result:	■ - passed
Test point	Vb		□ - not passed

EUT	QClick
Firm Name	QOMO HiteVision, LLC.
Operating Condition	DC 5V
Test Condition	Ambient Temperature: 25°C Humidity: 56%
Operator	Jackson
MODEL NO	QRF600, QRF6XX, QRF300, QRF3XX, QRF600-R, QRF300-R

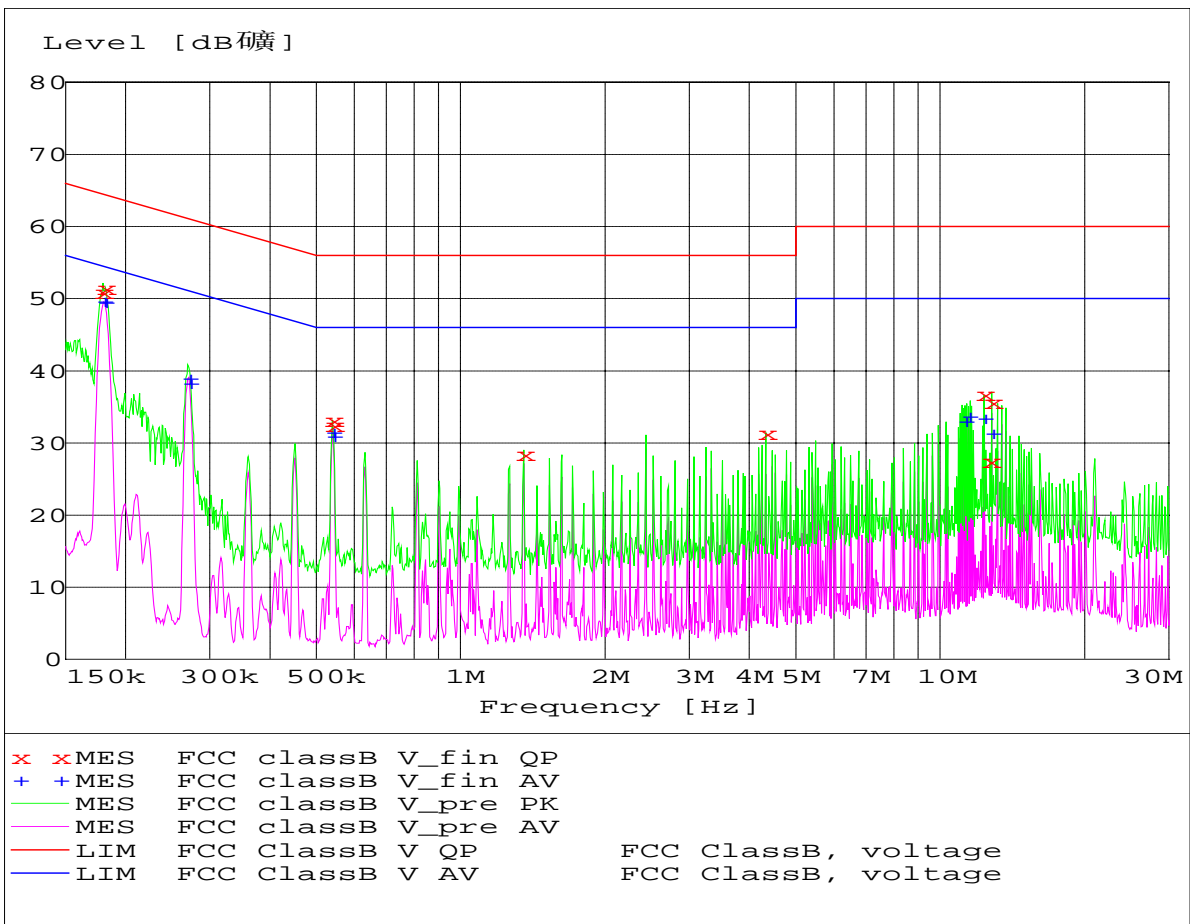

copyright of this report is owned by Centre of Testing Service and may not be reproduced other than in full except with the written approval of the issuing Company.

CENTRE OF TESTING SERVICE CO., LTD.

Building F, Dachuang industrial park, No.379, Zhongshan Dadao, Guangzhou, China

Tel: +86-20-85543113 (32 lines)

Fax: +86-20-38780406

Complaint line: +86-20-85533471

E-mail: cts@cts-lab.com.cn

See Reverse For Terms And Conditions of Service

MEASUREMENT RESULT: "FCC classB V_fin QP"

Frequency MHz	Level dB μ V	Transd dB	Limit dB μ V	Margin dB	Line	PE
0.178802	50.80	10.2	65	13.7	Vb	GND
0.180950	51.40	10.2	64	13.0	Vb	GND
0.540266	33.10	10.1	56	22.9	Vb	GND
0.542427	32.50	10.1	56	23.5	Vb	GND
1.353211	28.40	10.1	56	27.6	Vb	GND
4.323915	31.40	10.1	56	24.6	Vb	GND
12.355030	36.80	9.9	60	23.2	Vb	GND
12.705150	27.40	9.9	60	32.6	Vb	GND
12.806994	35.70	9.9	60	24.3	Vb	GND

MEASUREMENT RESULT: "FCC classB V_fin AV"

Frequency MHz	Level dB μ V	Transd dB	Limit dB μ V	Margin dB	Line	PE
0.180233	49.60	10.2	55	4.9	Vb	GND
0.180954	49.50	10.2	54	5.0	Vb	GND
0.270814	39.00	10.2	51	12.1	Vb	GND
0.271897	38.30	10.2	51	12.7	Vb	GND
0.540266	31.50	10.1	46	14.5	Vb	GND
0.542427	30.90	10.1	46	15.1	Vb	GND
11.271150	33.00	9.9	50	17.0	Vb	GND
11.452580	33.70	9.9	50	16.3	Vb	GND
12.355030	33.40	9.9	50	16.6	Vb	GND
12.806994	31.30	9.9	50	18.7	Vb	GND

copyright of this report is owned by Centre of Testing Service and may not be reproduced other than in full except with the written approval of the issuing Company.

CENTRE OF TESTING SERVICE CO., LTD.

Building F, Dachuang industrial park, No.379, Zhongshan Dadao, Guangzhou, China

Tel: +86-20-85543113 (32 lines)

Fax: +86-20-38780406

Complaint line: +86-20-85533471

E-mail: cts@cts-lab.com.cn

See Reverse For Terms And Conditions of Service

7 Radiated disturbance (electric field)

7.1. Test Equipment

Radiated disturbance (electric field)					
Item	Test Equipment	Manufacturer	Model No.	Serial No.	Last Cal.
1	EMI Test Receiver	ROHDE & SCHWARZ	ESCI	100868	2009/12
2	Biconical Antenna	ROHDE & SCHWARZ	HK116	100221	2009/12
3	Log per Antenna	ROHDE & SCHWARZ	HL223	100226	2009/12
4	Log per Antenna	ROHDE & SCHWARZ	HL050	100186	2009/12
5	Signal analyzer	ROHDE & SCHWARZ	FSIQ26	100311	2009/12

7.2. Block Diagram of Test Setup

7.2.1 Block Diagram of connection between EUT and simulators

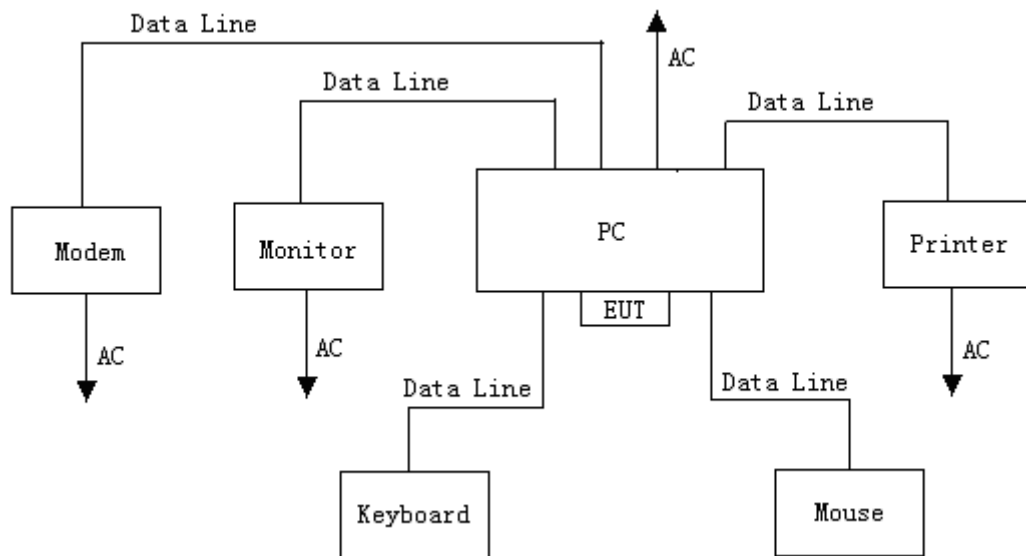

(EUT: Qclick)

Copyright of this report is owned by Centre of Testing Service and may not be reproduced other than in full except with the written approval of the issuing Company.

CENTRE OF TESTING SERVICE CO., LTD.

Building F, Dachuang industrial park, No.379, Zhongshan Dadao, Guangzhou, China

Tel: +86-20-85543113 (32 lines)

Fax: +86-20-38780406

Complaint line: +86-20-85533471

E-mail: cts@cts-lab.com.cn

See Reverse For Terms And Conditions of Service

7.2.2 Anechoic Chamber Setup Diagram

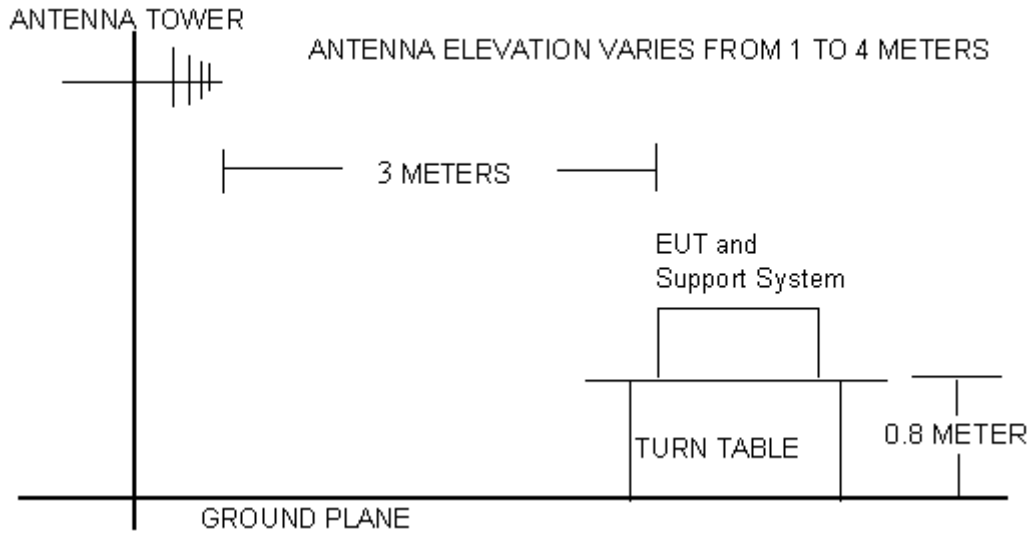

7.3. Radiated Emission Limit Standard: FCC 15.249

FREQUENCY MHz	DISTANCE Meters	FIELD STRENGTHS LIMIT	
		$\mu\text{V}/\text{m}$	$\text{dB}(\mu\text{V})/\text{m}$
30 ~ 88	3	100	40.0
88 ~ 216	3	150	43.5
216 ~ 960	3	200	46.0
960 ~ 1000	3	500	54.0
Local Oscillator:	3	114.0 $\text{dB}(\mu\text{V})/\text{m}$ (Peak) 94.0 $\text{dB}(\mu\text{V})/\text{m}$ (Average)	
Above 1000	3	Other: 74.0 $\text{dB}(\mu\text{V})/\text{m}$ (Peak) 54.0 $\text{dB}(\mu\text{V})/\text{m}$ (Average)	

Remark: (1) Emission level $\text{dB}\mu\text{V} = 20 \log$ Emission level $\mu\text{V}/\text{m}$
 (2) The smaller limit shall apply at the cross point between two frequency bands.
 (3) Distance is the distance in meters between the measuring instrument, antenna and the closest point of any part of the device or system.

7.4. EUT Configuration on Test

The following equipment are installed on Radiated Emission Test to meet the commission requirements and operating regulations in a manner which tends to maximize its emission characteristics in normal application.

7.5. Operating Condition of EUT

- 7.5.1. Setup the EUT and simulator as shown as Section 7.2.
- 7.5.2. Turn on the power of all equipment.
- 7.5.3. Let the EUT work in test mode (TX) and measurement it.

copyright of this report is owned by Centre of Testing Service and may not be reproduced other than in full except with the written approval of the issuing Company.



7.6. Test Procedure

The EUT and its simulators are placed on a turn table, which is 0.8 meter high above ground. The turn table can rotate 360 degrees to determine the position of the maximum emission level. The EUT is set 3 meters away from the receiving antenna, which is mounted on an antenna tower. The antenna can be moved up and down between 1 meter and 4 meters to find out the maximum emission level. Broadband antenna (calibrated bilog antenna) is used as receiving antenna. Both horizontal and vertical polarization of the antenna is set on Test. In order to find the maximum emission levels, all of the interface cables must be manipulated according to ANSI C63.4-2009 on radiated emission Test.

The frequency range from 30MHz to 1000MHz and above 1GHz. is investigated. Please see the following pages.

All measurements for radiated emissions within the restricted bands were performed using a Quasi-Peak detector with 120kHz RBW below 1GHz and a Peak and Average detector with 1MHz RBW above 1GHz,

All measurements for radiated emissions within the restricted bands were performed using a Quasi-Peak detector with 300kHz VBW below 1GHz and a Peak detector with 1MHz VBW above 1GHz, A average detector with 10Hz VBW above 1GHz

Radiated emission test for 18-26.5GHz is measured with peak detector, the RBW is 1MHz and VBW is 3MHz. The measure result complied average limit. So it also complied peak limit.

Pretest x, y, z position of EUT, final, select the worst case x position test and record the test results in the report.

The test modes (TX Mode) is tested in Anechoic Chamber and all the scanning waveforms are reported on section 7.7

7.7. Radiated Emission Test Results

PASSED

The frequency range from 30MHz to 230MHz, 230MHz to 1000MHz and above 1GHz. is investigated. Please see the following pages.



Channel:	0 (2404.1MHz)	Result:	<input checked="" type="checkbox"/> - passed
Test point:	Horizontal		<input type="checkbox"/> - not passed
Frequency range:	30-230MHz		

EUT	QClick
Firm Name	QOMO HiteVision, LLC.
Operating Condition	DC 5V
Test Condition	Ambient Temperature: 25°C Humidity: 56%
Operator	Jackson
MODEL NO	QRF600, QRF6XX, QRF300, QRF3XX, QRF600-R, QRF300-R

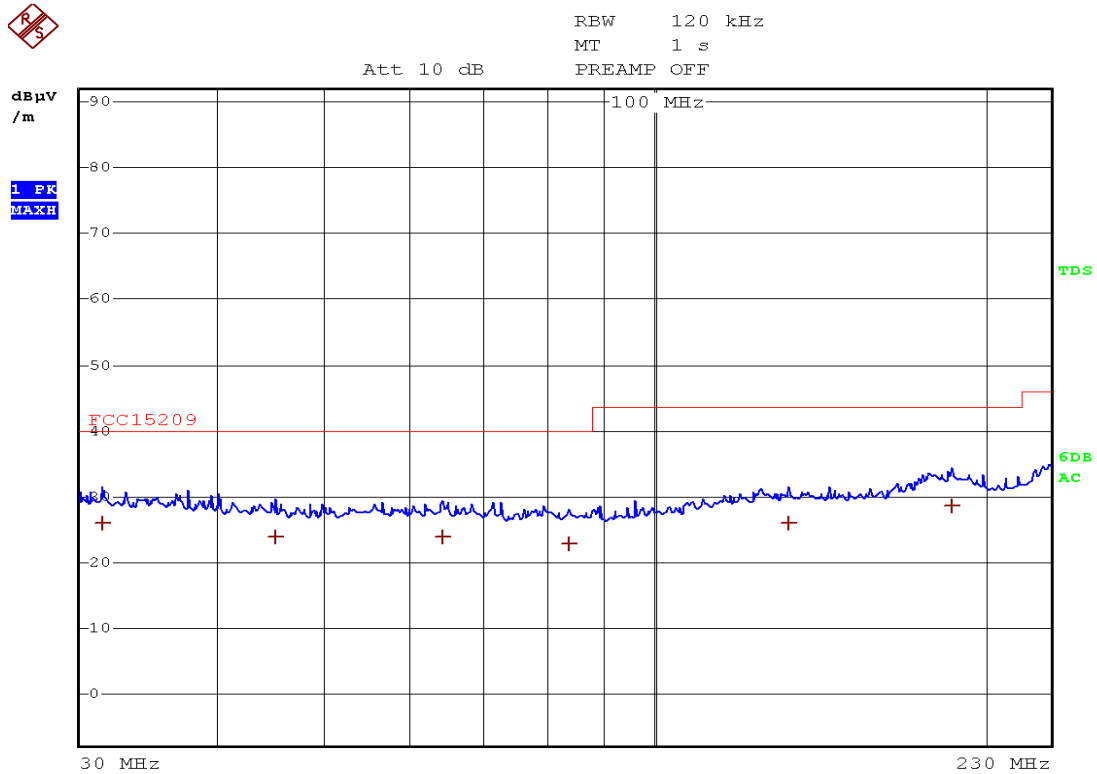

TRACE	FREQUENCY	LEVEL dBµV/m	DELTA LIMIT dB
Quasi Peak	31.52 MHz	25.96	-14.03
Quasi Peak	45.2 MHz	24.01	-15.98
Quasi Peak	64.28 MHz	24.00	-15.99
Quasi Peak	83.6 MHz	22.95	-17.04
Quasi Peak	132.88 MHz	25.86	-17.63
Quasi Peak	186.92 MHz	28.59	-14.90

Note: 1. Emission level=Read level + Factor
 2. Factor=Antenna factor + Cable loss

Copyright of this report is owned by Centre of Testing Service and may not be reproduced other than in full except with the written approval of the issuing Company.

CENTRE OF TESTING SERVICE CO., LTD.

Building F, Dachuang industrial park, No.379, Zhongshan Dadao, Guangzhou, China

Tel: +86-20-85543113 (32 lines)

Fax: +86-20-38780406

Complaint line: +86-20-85533471

E-mail: cts@cts-lab.com.cn

See Reverse For Terms And Conditions of Service



Channel:	0 (2404.1MHz)	Result:	<input checked="" type="checkbox"/> - passed
Test point:	Horizontal		<input type="checkbox"/> - not passed
Frequency range:	230-1000MHz		

EUT	QClick
Firm Name	QOMO HiteVision, LLC.
Operating Condition	DC 5V
Test Condition	Ambient Temperature: 25°C Humidity: 56%
Operator	Jackson
MODEL NO	QRF600, QRF6XX, QRF300, QRF3XX, QRF600-R, QRF300-R



RBW 120 kHz
MT 1 s
PREAMP OFF

Att 10 dB

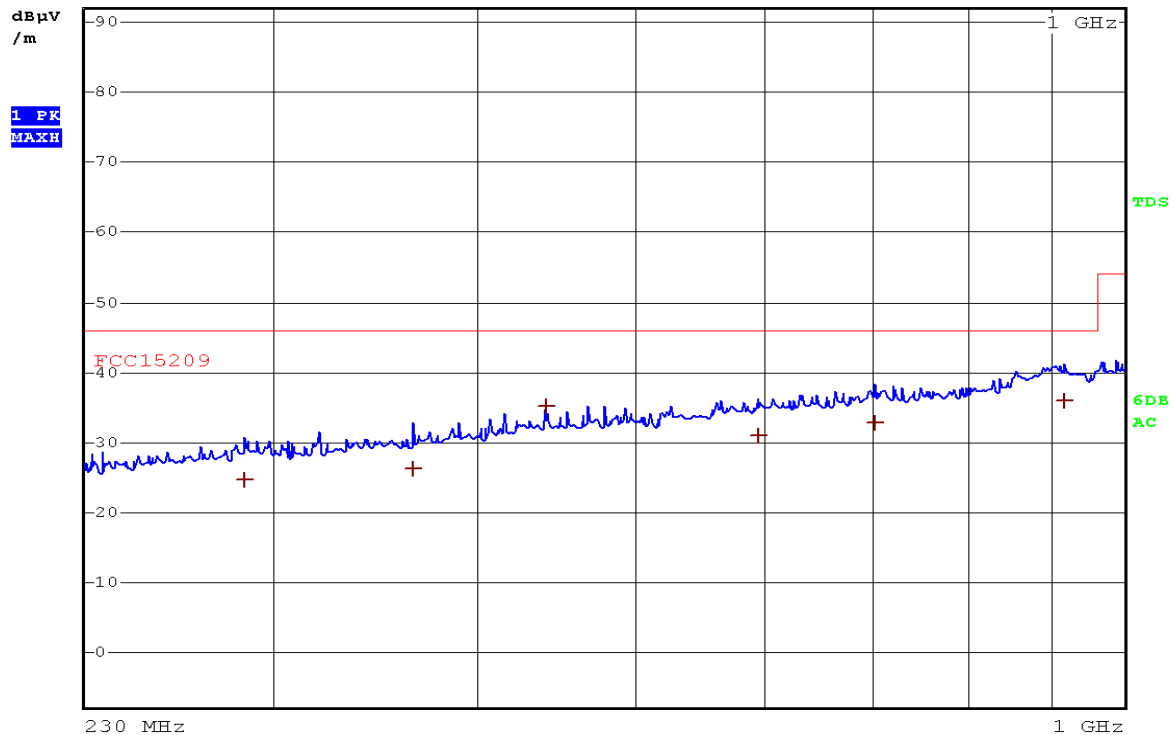

TRACE	FREQUENCY	LEVEL dBµV/m	DELTA LIMIT dB
Quasi Peak	288.8 MHz	24.75	-21.24
Quasi Peak	365.68 MHz	26.25	-19.74
Quasi Peak	442 MHz	35.19	-10.80
Quasi Peak	595.36 MHz	30.90	-15.09
Quasi Peak	702 MHz	32.77	-13.22
Quasi Peak	917.88 MHz	35.91	-10.08

Note: 1. Emission level=Read level + Factor
2. Factor=Antenna factor + Cable loss

Copyright of this report is owned by Centre of Testing Service and may not be reproduced other than in full except with the written approval of the issuing Company.

CENTRE OF TESTING SERVICE CO., LTD.

Building F, Dachuang industrial park, No.379, Zhongshan Dadao, Guangzhou, China

Tel: +86-20-85543113 (32 lines)

Fax: +86-20-38780406

Complaint line: +86-20-85533471

E-mail: cts@cts-lab.com.cn

See Reverse For Terms And Conditions of Service



Channel:	0 (2404.1MHz)	Result:	<input checked="" type="checkbox"/> - passed <input type="checkbox"/> - not passed
Test point:	Horizontal		
Frequency range:	1G-26.5GHz		

EUT	QClick
Firm Name	QOMO HiteVision, LLC.
Operating Condition	DC 5V
Test Condition	Ambient Temperature: 25°C Humidity: 56%
Operator	Jackson
MODEL NO	QRF600, QRF6XX, QRF300, QRF3XX, QRF600-R, QRF300-R

Frequency [MHz]	Result [dBμV]		Limit [dBμV]		Dlimit [dBμV]	
	Average	Peak	Average	Peak	Average	Peak
1837.4	45.0	53.5	54	74	9.0	20.5
2404.1	55.1	65.7	94	114	38.9	48.3
2971.2	44.6	52.7	54	74	9.4	20.3
7248.7	47.1	56.8	54	74	6.9	17.2
14984.5	41.0	50.0	54	74	13.0	24.0
17181.0	41.4	52.0	54	74	12.6	22.0
25247.1	43.1	53.4	54	74	10.9	20.6

Note: 1. Emission level=Read level + Factor
 2. Factor=Antenna factor + Cable loss

copyright of this report is owned by Centre of Testing Service and may not be reproduced other than in full except with the written approval of the issuing Company.

CENTRE OF TESTING SERVICE CO., LTD.

Building F, Dachuang industrial park, No.379, Zhongshan Dadao, Guangzhou, China

Tel: +86-20-85543113 (32 lines)

Fax: +86-20-38780406

Complaint line: +86-20-85533471

E-mail: cts@cts-lab.com.cn

See Reverse For Terms And Conditions of Service



Channel:	0 (2404.1MHz)	Result:	<input checked="" type="checkbox"/> - passed
Test point:	Vertical		<input type="checkbox"/> - not passed
Frequency range:	30-230MHz		

EUT	QClick
Firm Name	QOMO HiteVision, LLC.
Operating Condition	DC 5V
Test Condition	Ambient Temperature: 25°C Humidity: 56%
Operator	Jackson
MODEL NO	QRF600, QRF6XX, QRF300, QRF3XX, QRF600-R, QRF300-R

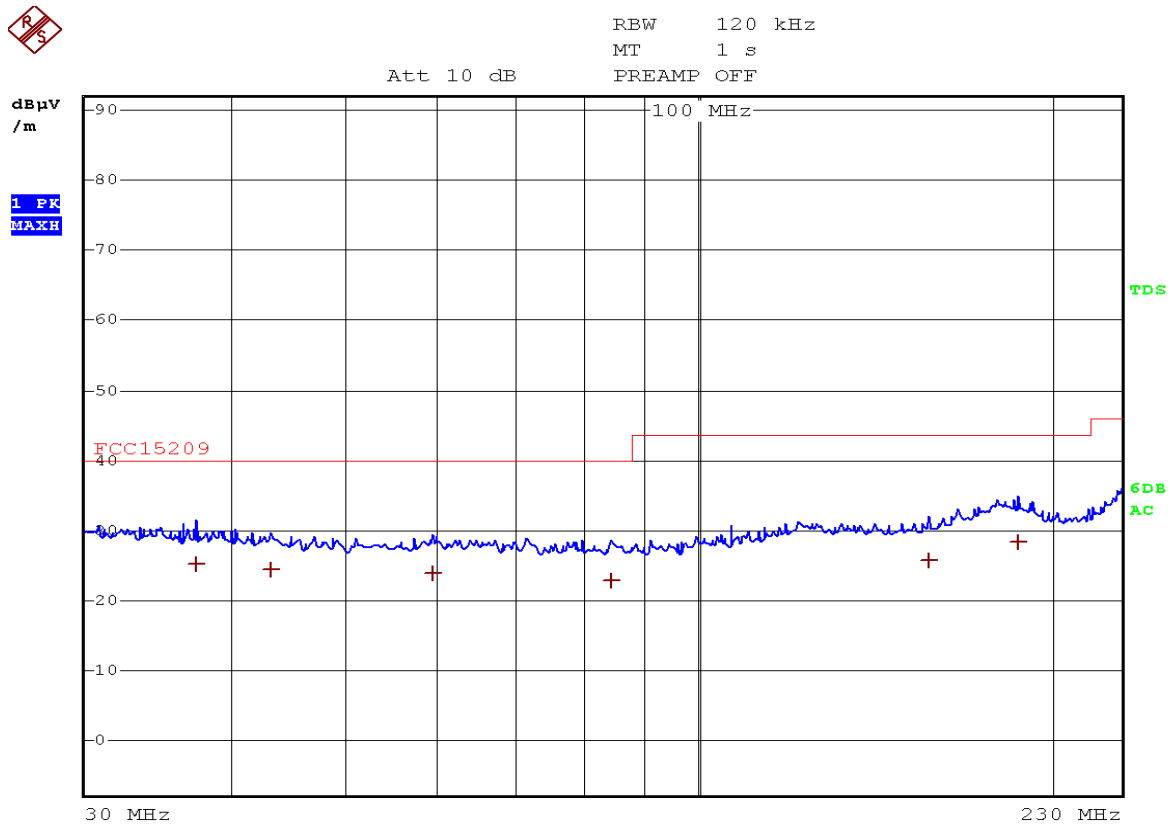

TRACE	FREQUENCY	LEVEL dBµV/m	DELTA LIMIT dB
Quasi Peak	37.4 MHz	25.26	-14.73
Quasi Peak	43.32 MHz	24.41	-15.58
Quasi Peak	59.52 MHz	23.97	-16.02
Quasi Peak	84.36 MHz	22.86	-17.13
Quasi Peak	157.72 MHz	25.74	-17.75
Quasi Peak	187.52 MHz	28.36	-15.13

Note: 1. Emission level=Read level + Factor
 2. Factor=Antenna factor + Cable loss

Copyright of this report is owned by Centre of Testing Service and may not be reproduced other than in full except with the written approval of the issuing Company.

CENTRE OF TESTING SERVICE CO., LTD.

Building F, Dachuang industrial park, No.379, Zhongshan Dadao, Guangzhou, China

Tel: +86-20-85543113 (32 lines)

Fax: +86-20-38780406

Complaint line: +86-20-85533471

E-mail: cts@cts-lab.com.cn

See Reverse For Terms And Conditions of Service



Channel:	0 (2404.1MHz)	Result:	<input checked="" type="checkbox"/> - passed
Test point:	Vertical		<input type="checkbox"/> - not passed
Frequency range:	230-1000MHz		

EUT	QClick
Firm Name	QOMO HiteVision, LLC.
Operating Condition	DC 5V
Test Condition	Ambient Temperature: 25°C Humidity: 56%
Operator	Jackson
MODEL NO	QRF600, QRF6XX, QRF300, QRF3XX, QRF600-R, QRF300-R

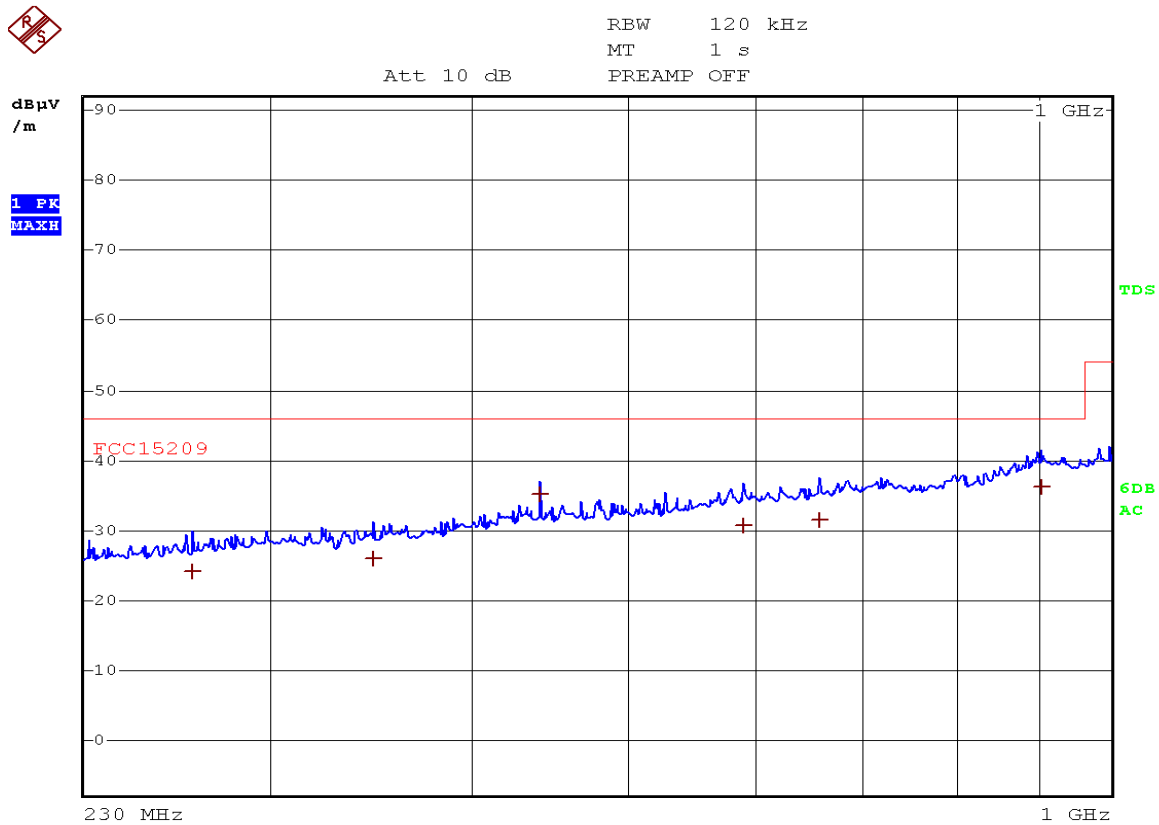

TRACE	FREQUENCY	LEVEL dBµV/m	DELTA LIMIT dB
Quasi Peak	269.08 MHz	24.18	-21.81
Quasi Peak	347.64 MHz	25.94	-20.05
Quasi Peak	442 MHz	35.20	-10.79
Quasi Peak	590.16 MHz	30.79	-15.20
Quasi Peak	658.56 MHz	31.48	-14.51
Quasi Peak	904.96 MHz	36.33	-9.66

Note: 1. Emission level=Read level + Factor
 2. Factor=Antenna factor + Cable loss

Copyright of this report is owned by Centre of Testing Service and may not be reproduced other than in full except with the written approval of the issuing Company.

CENTRE OF TESTING SERVICE CO., LTD.

Building F, Dachuang industrial park, No.379, Zhongshan Dadao, Guangzhou, China

Tel: +86-20-85543113 (32 lines)

Fax: +86-20-38780406

Complaint line: +86-20-85533471

E-mail: cts@cts-lab.com.cn

See Reverse For Terms And Conditions of Service



Channel:	0 (2404.1MHz)	Result:	<input checked="" type="checkbox"/> - passed <input type="checkbox"/> - not passed
Test point:	Vertical		
Frequency range:	1G-26.5GHz		

EUT	QClick
Firm Name	QOMO HiteVision, LLC.
Operating Condition	DC 5V
Test Condition	Ambient Temperature: 25°C Humidity: 56%
Operator	Jackson
MODEL NO	QRF600, QRF6XX, QRF300, QRF3XX, QRF600-R, QRF300-R

Frequency [MHz]	Result [dBμV]		Limit [dBμV]		Dlimit[dBμV]	
	Average	Peak	Average	Peak	Average	Peak
1834.5	45.0	53.1	54	74	9.0	20.9
2404.1	54.9	65.7	94	114	39.1	48.3
2985.4	44.7	52.2	54	74	9.3	21.8
7278.7	47.0	56.5	54	74	7.0	17.5
14987.7	41.0	50.4	54	74	13.0	23.6
17187.4	41.3	52.0	54	74	12.7	22.0
25245.1	43.2	53.9	54	74	10.8	20.1

Note: 1. Emission level=Read level + Factor
 2. Factor=Antenna factor + Cable loss

Copyright of this report is owned by Centre of Testing Service and may not be reproduced other than in full except with the written approval of the issuing Company.

CENTRE OF TESTING SERVICE CO., LTD.

Building F, Dachuang industrial park, No.379, Zhongshan Dadao, Guangzhou, China

Tel: +86-20-85543113 (32 lines)

Fax: +86-20-38780406

Complaint line: +86-20-85533471

E-mail: cts@cts-lab.com.cn

See Reverse For Terms And Conditions of Service



Channel:	24 (2440.0MHz)	Result:	<input checked="" type="checkbox"/> - passed
Test point:	Horizontal		<input type="checkbox"/> - not passed
Frequency range:	30-230MHz		

EUT	QClick
Firm Name	QOMO HiteVision, LLC.
Operating Condition	DC 5V
Test Condition	Ambient Temperature: 25°C Humidity: 56%
Operator	Jackson
MODEL NO	QRF600, QRF6XX, QRF300, QRF3XX, QRF600-R, QRF300-R



RBW 120 kHz

MT 100 μs

PREAMP OFF

Att 10 dB

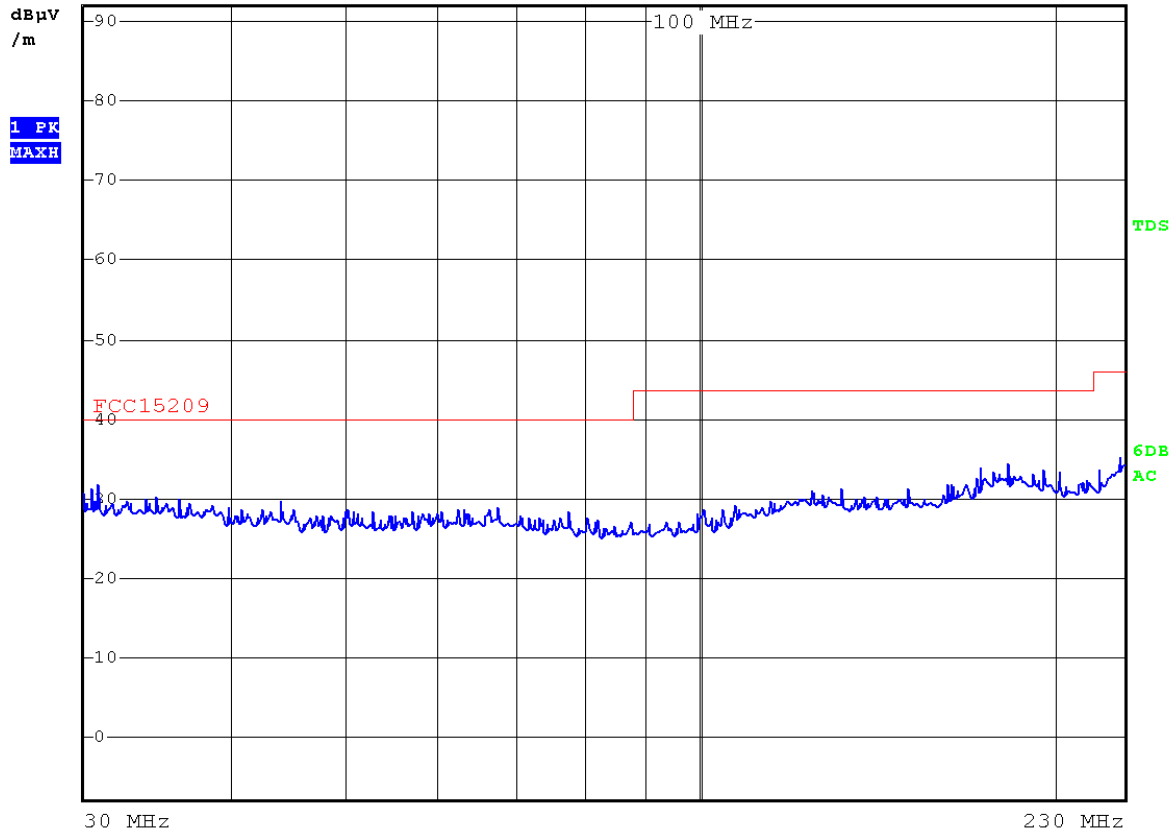

Copyright of this report is owned by Centre of Testing Service and may not be reproduced other than in full except with the written approval of the issuing Company.

CENTRE OF TESTING SERVICE CO., LTD.

Building F, Dachuang industrial park, No.379, Zhongshan Dadao, Guangzhou, China

Tel: +86-20-85543113 (32 lines)

Fax: +86-20-38780406

Complaint line: +86-20-85533471

E-mail: cts@cts-lab.com.cn

See Reverse For Terms And Conditions of Service



Channel:	24 (2440.0MHz)	Result:	<input checked="" type="checkbox"/> - passed
Test point:	Horizontal		<input type="checkbox"/> - not passed
Frequency range:	230-1000MHz		

EUT	QClick
Firm Name	QOMO HiteVision, LLC.
Operating Condition	DC 5V
Test Condition	Ambient Temperature: 25°C Humidity: 56%
Operator	Jackson
MODEL NO	QRF600, QRF6XX, QRF300, QRF3XX, QRF600-R, QRF300-R



RBW 120 kHz

MT 100 μ s

PREAMP OFF

Att 10 dB

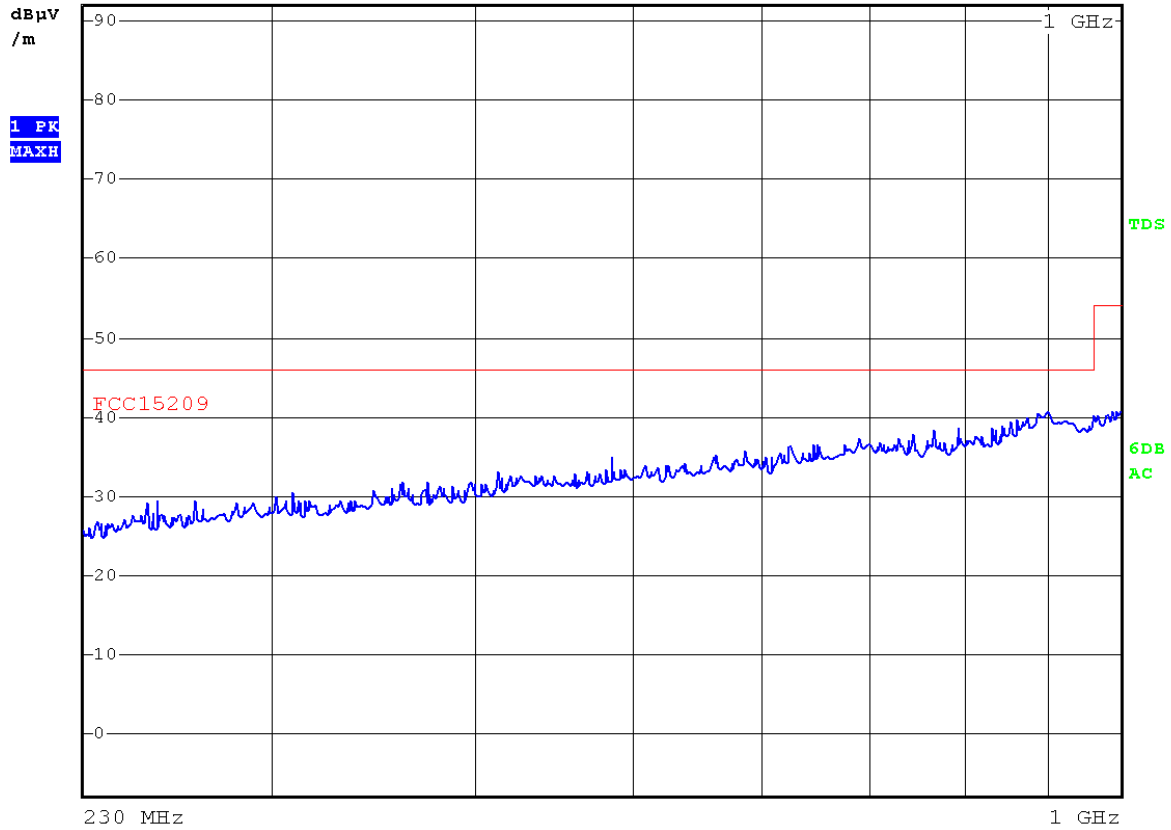

copyright of this report is owned by Centre of Testing Service and may not be reproduced other than in full except with the written approval of the issuing Company.

CENTRE OF TESTING SERVICE CO., LTD.

Building F, Dachuang industrial park, No.379, Zhongshan Dadao, Guangzhou, China

Tel: +86-20-85543113 (32 lines)

Fax: +86-20-38780406

Complaint line: +86-20-85533471

E-mail: cts@cts-lab.com.cn

See Reverse For Terms And Conditions of Service



Channel:	24 (2440.0MHz)	Result:	<input checked="" type="checkbox"/> – passed <input type="checkbox"/> – not passed
Test point:	Horizontal		
Frequency range:	1G-26.5GHz		

EUT	QClick
Firm Name	QOMO HiteVision, LLC.
Operating Condition	DC 5V
Test Condition	Ambient Temperature: 25°C Humidity: 56%
Operator	Jackson
MODEL NO	QRF600, QRF6XX, QRF300, QRF3XX, QRF600-R, QRF300-R

Frequency [MHz]	Result [dBμV]		Limit [dBμV]		Dlimit[dBμV]	
	Average	Peak	Average	Peak	Average	Peak
1837.8	45.1	53.2	54	74	8.9	20.8
2440.0	54.0	64.8	94	114	40.0	49.2
2984.4	44.7	52.2	54	74	9.7	21.8
7278.7	47.0	56.5	54	74	7.0	17.5
14987.7	41.0	50.4	54	74	13.0	23.6
17187.4	41.3	52.0	54	74	12.7	22.0
25245.2	43.2	53.9	54	74	10.8	20.1

Note: 1. Emission level=Read level + Factor
 2. Factor=Antenna factor + Cable loss

copyright of this report is owned by Centre of Testing Service and may not be reproduced other than in full except with the written approval of the issuing Company.

CENTRE OF TESTING SERVICE CO., LTD.

Building F, Dachuang industrial park, No.379, Zhongshan Dadao, Guangzhou, China

Tel: +86-20-85543113 (32 lines)

Fax: +86-20-38780406

Complaint line: +86-20-85533471

E-mail: cts@cts-lab.com.cn

See Reverse For Terms And Conditions of Service



Channel:	24 (2440.0MHz)	Result:	<input checked="" type="checkbox"/> - passed
Test point:	Vertical		<input type="checkbox"/> - not passed
Frequency range:	30-230MHz		

EUT	QClick
Firm Name	QOMO HiteVision, LLC.
Operating Condition	DC 5V
Test Condition	Ambient Temperature: 25°C Humidity: 56%
Operator	Jackson
MODEL NO	QRF600, QRF6XX, QRF300, QRF3XX, QRF600-R, QRF300-R



RBW 120 kHz
 MT 100 μs
 PREAMP OFF

Att 10 dB

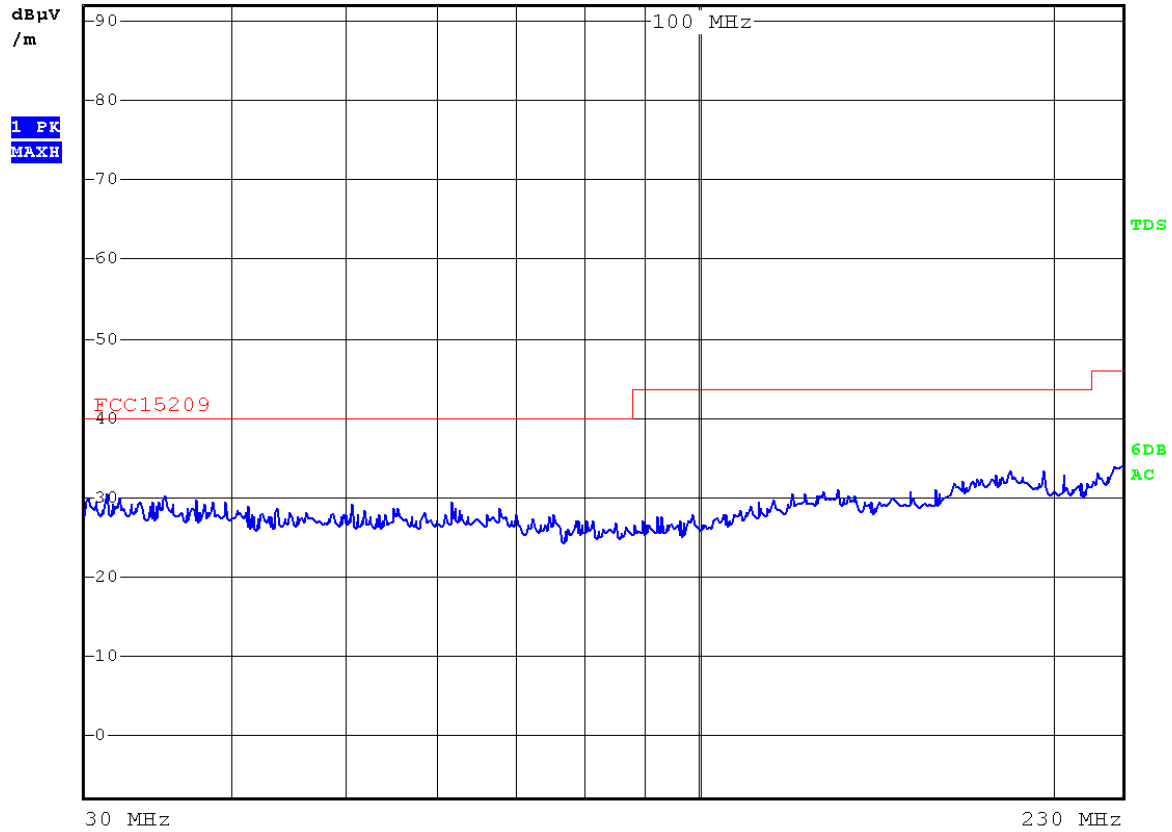

Copyright of this report is owned by Centre of Testing Service and may not be reproduced other than in full except with the written approval of the issuing Company.

CENTRE OF TESTING SERVICE CO., LTD.

Building F, Dachuang industrial park, No.379, Zhongshan Dadao, Guangzhou, China

Tel: +86-20-85543113 (32 lines)

Fax: +86-20-38780406

Complaint line: +86-20-85533471

E-mail: cts@cts-lab.com.cn

See Reverse For Terms And Conditions of Service



Channel:	24 (2440.0MHz)	Result:	<input checked="" type="checkbox"/> - passed
Test point:	Vertical		<input type="checkbox"/> - not passed
Frequency range:	230-1000MHz		

EUT	QClick
Firm Name	QOMO HiteVision, LLC.
Operating Condition	DC 5V
Test Condition	Ambient Temperature: 25°C Humidity: 56%
Operator	Jackson
MODEL NO	QRF600, QRF6XX, QRF300, QRF3XX, QRF600-R, QRF300-R



RBW 120 kHz

MT 100 μ s

PREAMP OFF

Att 10 dB

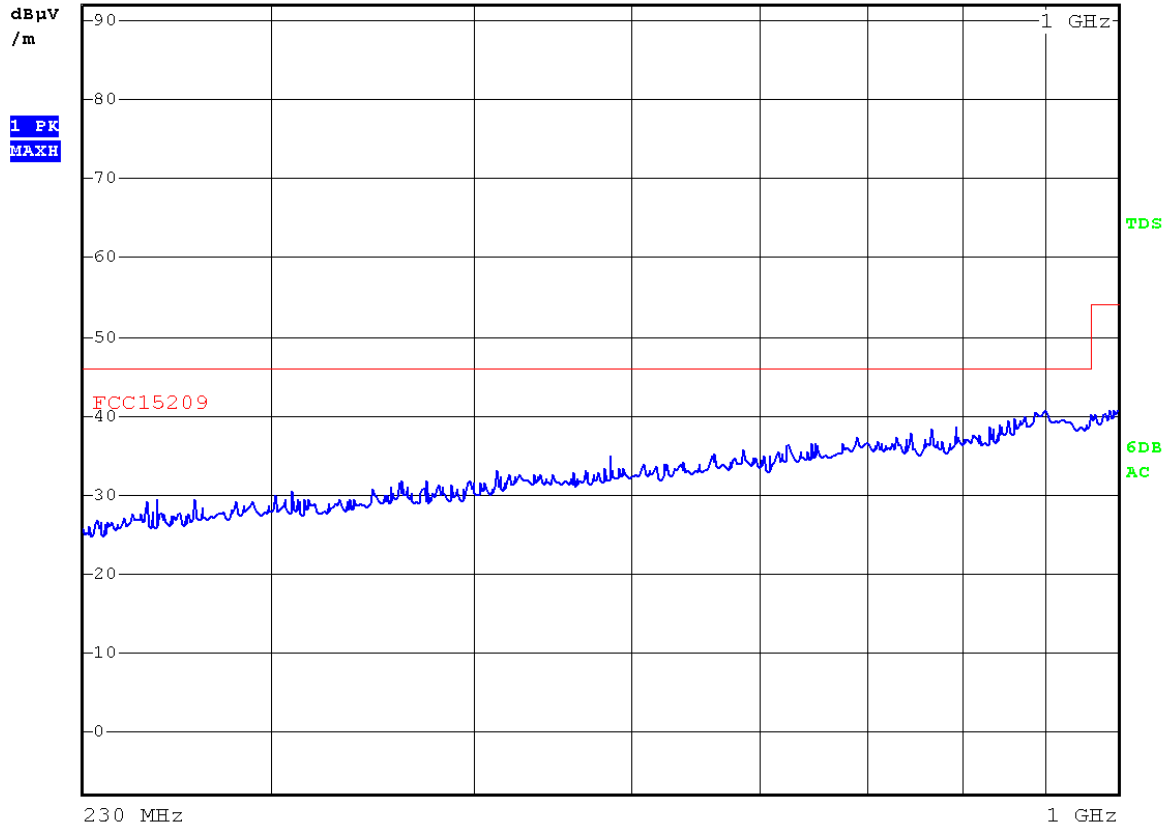

copyright of this report is owned by Centre of Testing Service and may not be reproduced other than in full except with the written approval of the issuing Company.

CENTRE OF TESTING SERVICE CO., LTD.

Building F, Dachuang industrial park, No.379, Zhongshan Dadao, Guangzhou, China

Tel: +86-20-85543113 (32 lines)

Fax: +86-20-38780406

Complaint line: +86-20-85533471

E-mail: cts@cts-lab.com.cn

See Reverse For Terms And Conditions of Service



Channel:	24 (2440.0MHz)	Result:	<input checked="" type="checkbox"/> – passed <input type="checkbox"/> – not passed
Test point:	Vertical		
Frequency range:	1G-26.5GHz		

EUT	QClick
Firm Name	QOMO HiteVision, LLC.
Operating Condition	DC 5V
Test Condition	Ambient Temperature: 25°C Humidity: 56%
Operator	Jackson
MODEL NO	QRF600, QRF6XX, QRF300, QRF3XX, QRF600-R, QRF300-R

Frequency [MHz]	Result [dBμV]		Limit [dBμV]		Dlimit [dBμV]	
	Average	Peak	Average	Peak	Average	Peak
1837.7	45.0	53.3	54	74	9.0	20.7
2440.0	54.0	64.9	94	114	40.0	49.1
2998.4	44.6	52.7	54	74	9.4	20.3
7278.7	47.1	56.8	54	74	6.9	17.2
14987.7	41.0	50.0	54	74	13.0	24.0
17187.4	41.4	52.0	54	74	12.6	22.0
25245.1	43.1	53.6	54	74	10.9	20.4

Note: 1. Emission level=Read level + Factor
 2. Factor=Antenna factor + Cable loss

copyright of this report is owned by Centre of Testing Service and may not be reproduced other than in full except with the written approval of the issuing Company.

CENTRE OF TESTING SERVICE CO., LTD.

Building F, Dachuang industrial park, No.379, Zhongshan Dadao, Guangzhou, China

Tel: +86-20-85543113 (32 lines)

Fax: +86-20-38780406

Complaint line: +86-20-85533471

E-mail: cts@cts-lab.com.cn

See Reverse For Terms And Conditions of Service



Channel:	49 (2480.0MHz)	Result:	<input checked="" type="checkbox"/> - passed
Test point:	Horizontal		<input type="checkbox"/> - not passed
Frequency range:	30-230MHz		

EUT	QClick
Firm Name	QOMO HiteVision, LLC.
Operating Condition	DC 5V
Test Condition	Ambient Temperature: 25°C Humidity: 56%
Operator	Jackson
MODEL NO	QRF600, QRF6XX, QRF300, QRF3XX, QRF600-R, QRF300-R



RBW 120 kHz
 MT 100 μs
 PREAMP OFF

Att 10 dB

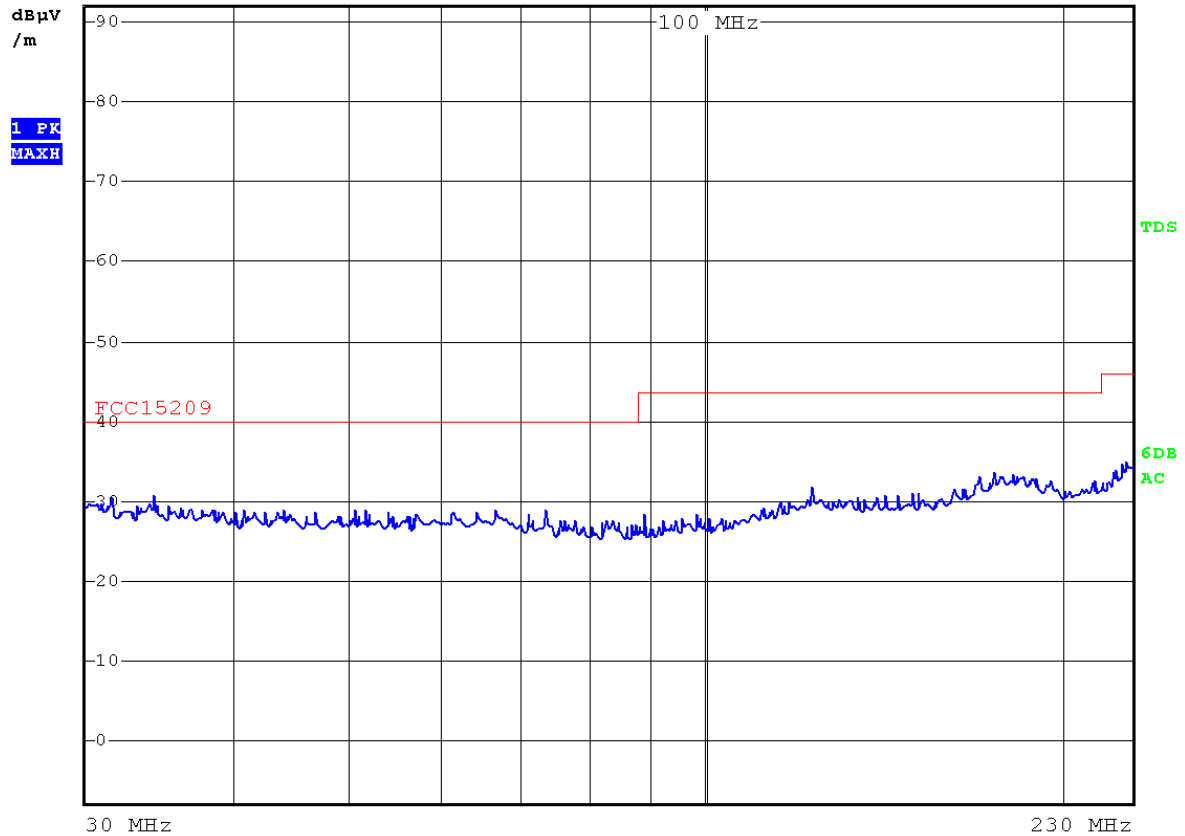

Copyright of this report is owned by Centre of Testing Service and may not be reproduced other than in full except with the written approval of the issuing Company.

CENTRE OF TESTING SERVICE CO., LTD.

Building F, Dachuang industrial park, No.379, Zhongshan Dadao, Guangzhou, China

Tel: +86-20-85543113 (32 lines)

Fax: +86-20-38780406

Complaint line: +86-20-85533471

E-mail: cts@cts-lab.com.cn

See Reverse For Terms And Conditions of Service



Channel:	49 (2480.0MHz)	Result:	<input checked="" type="checkbox"/> - passed
Test point:	Horizontal		<input type="checkbox"/> - not passed
Frequency range:	230-1000MHz		

EUT	QClick
Firm Name	QOMO HiteVision, LLC.
Operating Condition	DC 5V
Test Condition	Ambient Temperature: 25°C Humidity: 56%
Operator	Jackson
MODEL NO	QRF600, QRF6XX, QRF300, QRF3XX, QRF600-R, QRF300-R



RBW 120 kHz

MT 100 μs

PREAMP OFF

Att 10 dB

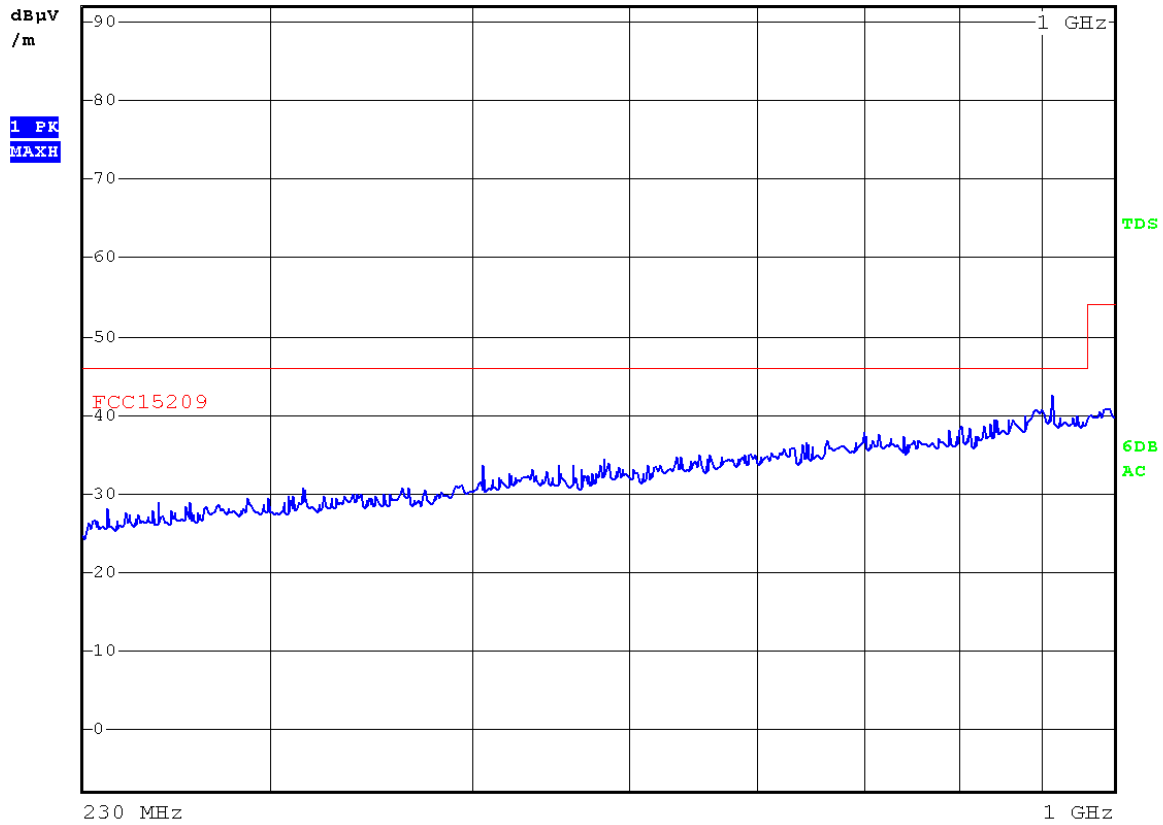

Copyright of this report is owned by Centre of Testing Service and may not be reproduced other than in full except with the written approval of the issuing Company.

CENTRE OF TESTING SERVICE CO., LTD.

Building F, Dachuang industrial park, No.379, Zhongshan Dadao, Guangzhou, China

Tel: +86-20-85543113 (32 lines)

Fax: +86-20-38780406

Complaint line: +86-20-85533471

E-mail: cts@cts-lab.com.cn

See Reverse For Terms And Conditions of Service



Channel:	49 (2480.0MHz)	Result:	<input checked="" type="checkbox"/> – passed <input type="checkbox"/> – not passed
Test point:	Horizontal		
Frequency range:	1G-26.5GHz		

EUT	QClick
Firm Name	QOMO HiteVision, LLC.
Operating Condition	DC 5V
Test Condition	Ambient Temperature: 25°C Humidity: 56%
Operator	Jackson
MODEL NO	QRF600, QRF6XX, QRF300, QRF3XX, QRF600-R, QRF300-R

Frequency [MHz]	Result [dBμV]		Limit [dBμV]		Dlimit[dBμV]	
	Average	Peak	Average	Peak	Average	Peak
1836.5	45.0	53.2	54	74	9.0	20.8
2480.0	51.0	61.7	94	114	43.0	52.3
2985.3	44.6	52.2	54	74	9.4	21.8
7275.7	47.0	56.5	54	74	7.0	17.5
14987.1	41.0	50.4	54	74	13.0	23.6
17187.8	41.3	52.0	54	74	12.7	22.0
25241.1	43.2	53.9	54	74	10.8	20.1

Note: 1. Emission level=Read level + Factor
 2. Factor=Antenna factor + Cable loss

copyright of this report is owned by Centre of Testing Service and may not be reproduced other than in full except with the written approval of the issuing Company.

CENTRE OF TESTING SERVICE CO., LTD.

Building F, Dachuang industrial park, No.379, Zhongshan Dadao, Guangzhou, China

Tel: +86-20-85543113 (32 lines)

Fax: +86-20-38780406

Complaint line: +86-20-85533471

E-mail: cts@cts-lab.com.cn

See Reverse For Terms And Conditions of Service



Channel:	49 (2480.0MHz)	Result:	<input checked="" type="checkbox"/> - passed
Test point:	Vertical		<input type="checkbox"/> - not passed
Frequency range:	30-230MHz		

EUT	QClick
Firm Name	QOMO HiteVision, LLC.
Operating Condition	DC 5V
Test Condition	Ambient Temperature: 25°C Humidity: 56%
Operator	Jackson
MODEL NO	QRF600, QRF6XX, QRF300, QRF3XX, QRF600-R, QRF300-R

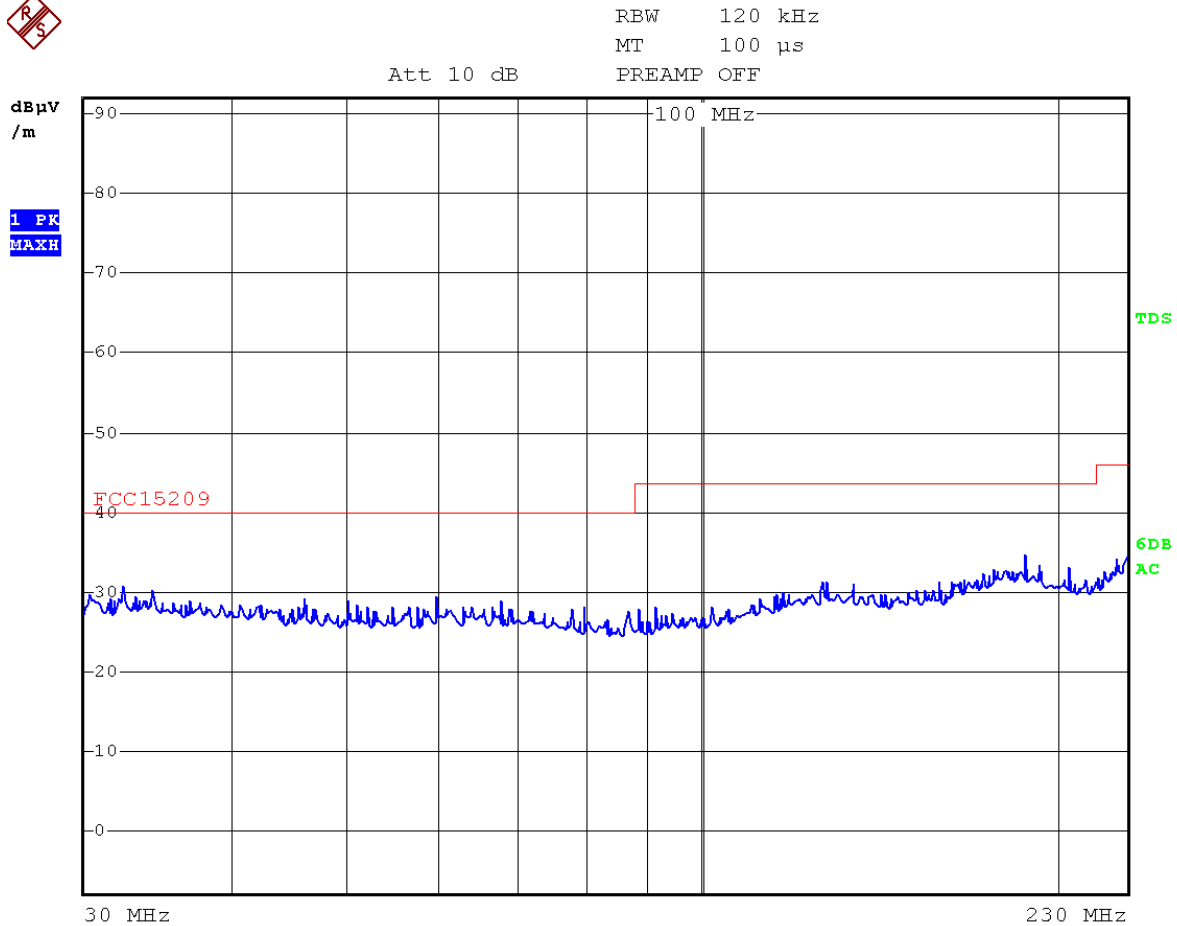

Copyright of this report is owned by Centre of Testing Service and may not be reproduced other than in full except with the written approval of the issuing Company.

CENTRE OF TESTING SERVICE CO., LTD.

Building F, Dachuang industrial park, No.379, Zhongshan Dadao, Guangzhou, China

Tel: +86-20-85543113 (32 lines)

Fax: +86-20-38780406

Complaint line: +86-20-85533471

E-mail: cts@cts-lab.com.cn

See Reverse For Terms And Conditions of Service



Channel:	49 (2480.0MHz)	Result:	<input checked="" type="checkbox"/> - passed
Test point:	Vertical		<input type="checkbox"/> - not passed
Frequency range:	230-1000MHz		

EUT	QClick
Firm Name	QOMO HiteVision, LLC.
Operating Condition	DC 5V
Test Condition	Ambient Temperature: 25°C Humidity: 56%
Operator	Jackson
MODEL NO	QRF600, QRF6XX, QRF300, QRF3XX, QRF600-R, QRF300-R



RBW 120 kHz

MT 100 μs

PREAMP OFF

Att 10 dB

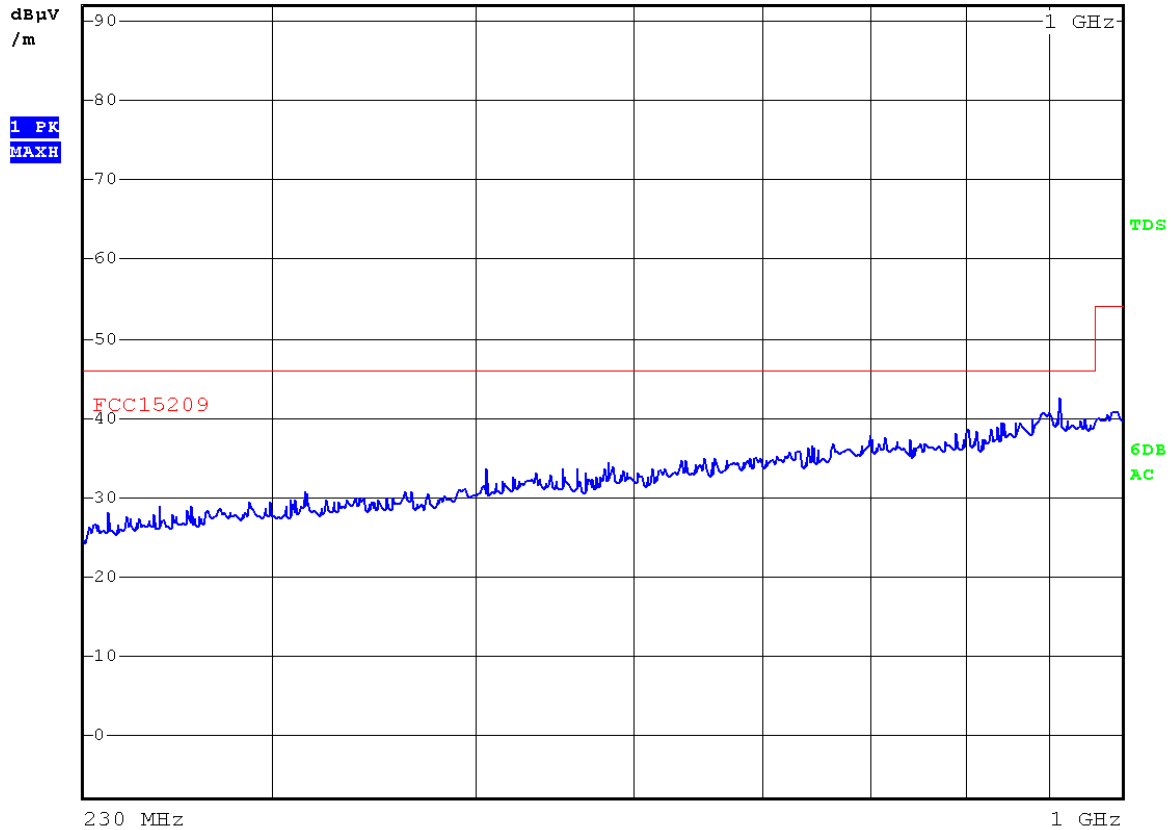

copyright of this report is owned by Centre of Testing Service and may not be reproduced other than in full except with the written approval of the issuing Company.

CENTRE OF TESTING SERVICE CO., LTD.

Building F, Dachuang industrial park, No.379, Zhongshan Dadao, Guangzhou, China

Tel: +86-20-85543113 (32 lines)

Fax: +86-20-38780406

Complaint line: +86-20-85533471

E-mail: cts@cts-lab.com.cn

See Reverse For Terms And Conditions of Service



Channel:	49 (2480.0MHz)	Result:	<input checked="" type="checkbox"/> - passed <input type="checkbox"/> - not passed
Test point:	Vertical		
Frequency range:	1G-26.5GHz		

EUT	QClick
Firm Name	QOMO HiteVision, LLC.
Operating Condition	DC 5V
Test Condition	Ambient Temperature: 25°C Humidity: 56%
Operator	Jackson
MODEL NO	QRF600, QRF6XX, QRF300, QRF3XX, QRF600-R, QRF300-R

Frequency [MHz]	Result [dBμV]		Limit [dBμV]		Dlimit[dBμV]	
	Average	Peak	Average	Peak	Average	Peak
1847.8	45.5	53.0	54	74	8.5	21.0
2480.0	51.0	61.1	94	114	43.0	52.9
2978.1	44.1	52.2	54	74	9.9	21.8
7245.7	47.0	56.1	54	74	7.0	17.9
14877.7	41.8	50.0	54	74	12.2	24.0
17787.4	41.3	53.6	54	74	12.7	20.4
25245.1	43.0	53.9	54	74	11.0	20.1

Note: 1. Emission level=Read level + Factor
 2. Factor=Antenna factor + Cable loss

copyright of this report is owned by Centre of Testing Service and may not be reproduced other than in full except with the written approval of the issuing Company.

CENTRE OF TESTING SERVICE CO., LTD.

Building F, Dachuang industrial park, No.379, Zhongshan Dadao, Guangzhou, China

Tel: +86-20-85543113 (32 lines)

Fax: +86-20-38780406

Complaint line: +86-20-85533471

E-mail: cts@cts-lab.com.cn

See Reverse For Terms And Conditions of Service

8 Band Edge Compliance Measurement

8.1. Test Equipment

Radiated disturbance (electric field)					
Item	Test Equipment	Manufacturer	Model No.	Serial No.	Last Cal.
1	EMI Test Receiver	ROHDE & SCHWARZ	ESCI	10868	2009/12
2	Log per Antenna	ROHDE & SCHWARZ	HL050	100186	2009/12
3	Signal analyzer	ROHDE & SCHWARZ	FSIQ26	100311	2009/12

8.2. Test Information

EUT:	QClick
M/N:	QRF600, QRF6XX, QRF300, QRF3XX, QRF600-R, QRF300-R
Test Date:	01 ~11 September 2009
Ambient Temperature:	24°C
Relative Humidity:	55%
Test standard:	FCC PART 15C: 15.249
Test mode:	Transmitting
Test Frequency:	Chennel 0(2404.1MHz) Chennel 49(2480.0MHz)
Test By:	Roy

8.3. Test Results

PASSED.

The testing data was attached in the next pages.



Channel:	0	Result:	<input checked="" type="checkbox"/> - passed
Test point:	Horizontal		<input type="checkbox"/> - not passed
Test Frequency:	2404.1MHz		

EUT	QClick
Firm Name	QOMO HiteVision, LLC.
Operating Condition	DC 5V
Test Condition	Ambient Temperature: 25°C Humidity: 56%
Operator	Jackson
MODEL NO	QRF600, QRF6XX, QRF300, QRF3XX, QRF600-R, QRF300-R

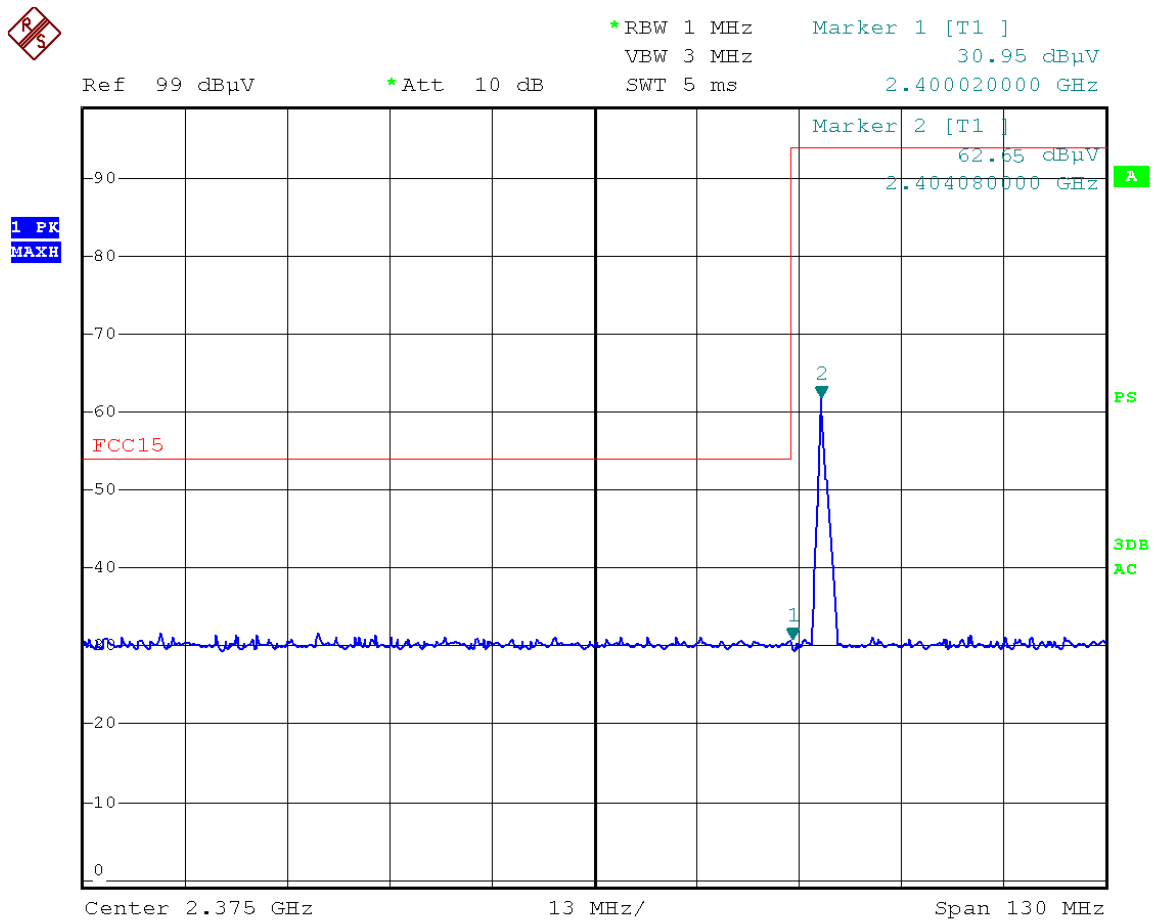

Copyright of this report is owned by Centre of Testing Service and may not be reproduced other than in full except with the written approval of the issuing Company.

CENTRE OF TESTING SERVICE CO., LTD.

Building F, Dachuang industrial park, No.379, Zhongshan Dadao, Guangzhou, China

Tel: +86-20-85543113 (32 lines)

Fax: +86-20-38780406

Complaint line: +86-20-85533471

E-mail: cts@cts-lab.com.cn

See Reverse For Terms And Conditions of Service



Channel:	0	Result:	<input checked="" type="checkbox"/> - passed
Test point:	Vertical		<input type="checkbox"/> - not passed
Test Frequency:	2404.1MHz		

EUT	QClick
Firm Name	QOMO HiteVision, LLC.
Operating Condition	DC 5V
Test Condition	Ambient Temperature: 25°C Humidity: 56%
Operator	Jackson
MODEL NO	QRF600, QRF6XX, QRF300, QRF3XX, QRF600-R, QRF300-R

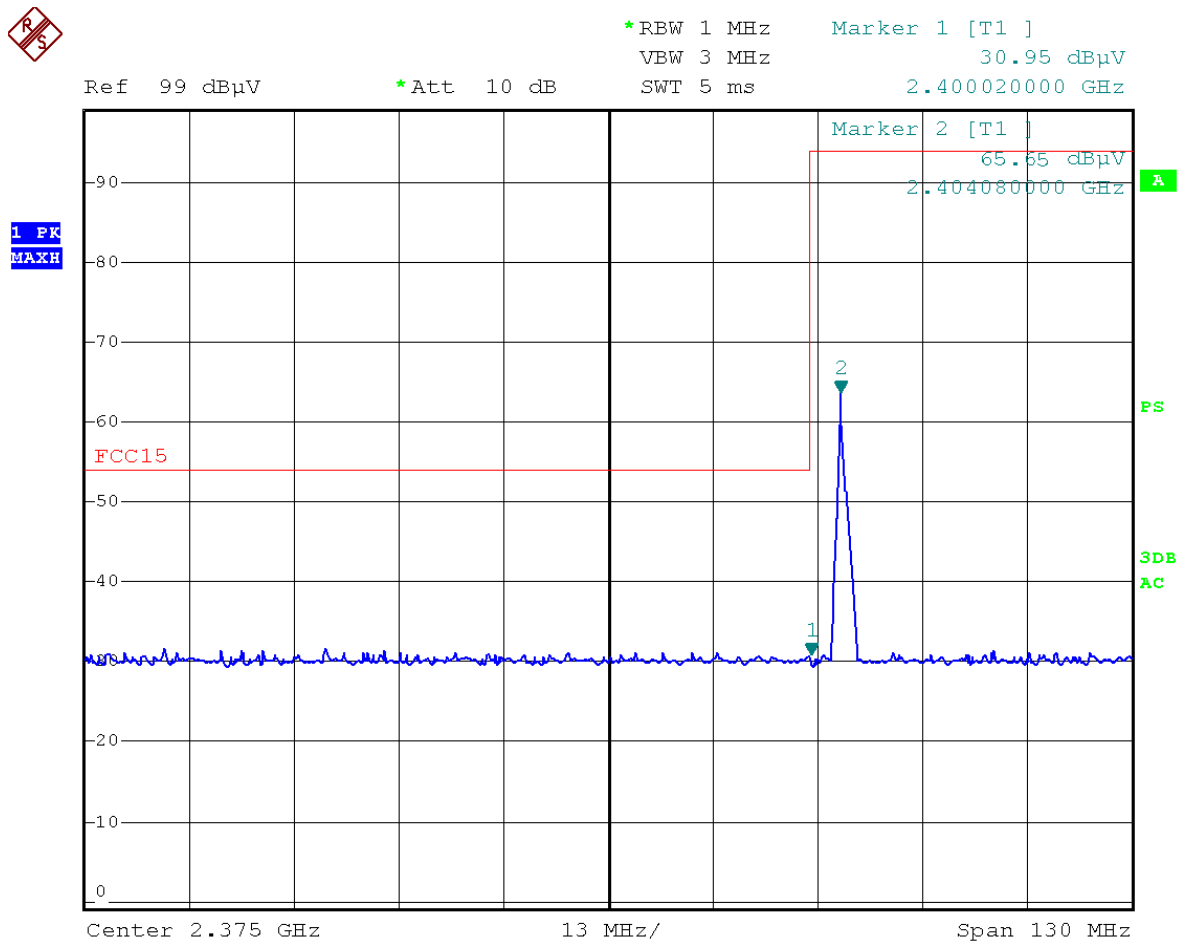

copyright of this report is owned by Centre of Testing Service and may not be reproduced other than in full except with the written approval of the issuing Company.

CENTRE OF TESTING SERVICE CO., LTD.

Building F, Dachuang industrial park, No.379, Zhongshan Dadao, Guangzhou, China

Tel: +86-20-85543113 (32 lines)

Fax: +86-20-38780406

Complaint line: +86-20-85533471

E-mail: cts@cts-lab.com.cn

See Reverse For Terms And Conditions of Service



Channel:	49	Result:	<input checked="" type="checkbox"/> - passed
Test point:	Horizontal		<input type="checkbox"/> - not passed
Test Frequency:	2480.0MHz		

EUT	QClick
Firm Name	QOMO HiteVision, LLC.
Operating Condition	DC 5V
Test Condition	Ambient Temperature: 25°C Humidity: 56%
Operator	Jackson
MODEL NO	QRF600, QRF6XX, QRF300, QRF3XX, QRF600-R, QRF300-R

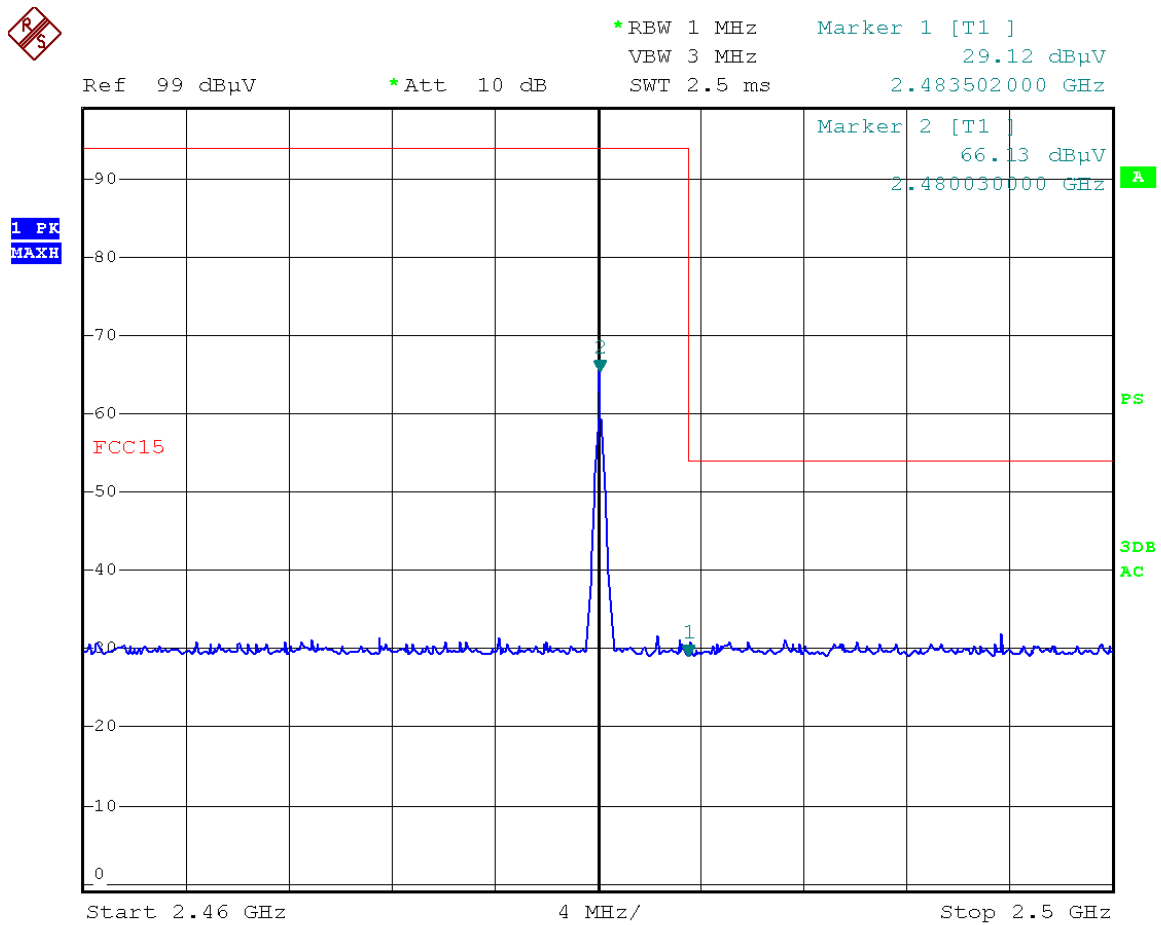

Copyright of this report is owned by Centre of Testing Service and may not be reproduced other than in full except with the written approval of the issuing Company.

CENTRE OF TESTING SERVICE CO., LTD.

Building F, Dachuang industrial park, No.379, Zhongshan Dadao, Guangzhou, China

Tel: +86-20-85543113 (32 lines)

Fax: +86-20-38780406

Complaint line: +86-20-85533471

E-mail: cts@cts-lab.com.cn

See Reverse For Terms And Conditions of Service



Channel:	49	Result:	<input checked="" type="checkbox"/> - passed
Test point:	Vertical		<input type="checkbox"/> - not passed
Test Frequency:	2480.0MHz		

EUT	QClick
Firm Name	QOMO HiteVision, LLC.
Operating Condition	DC 5V
Test Condition	Ambient Temperature: 25°C Humidity: 56%
Operator	Jackson
MODEL NO	QRF600, QRF6XX, QRF300, QRF3XX, QRF600-R, QRF300-R

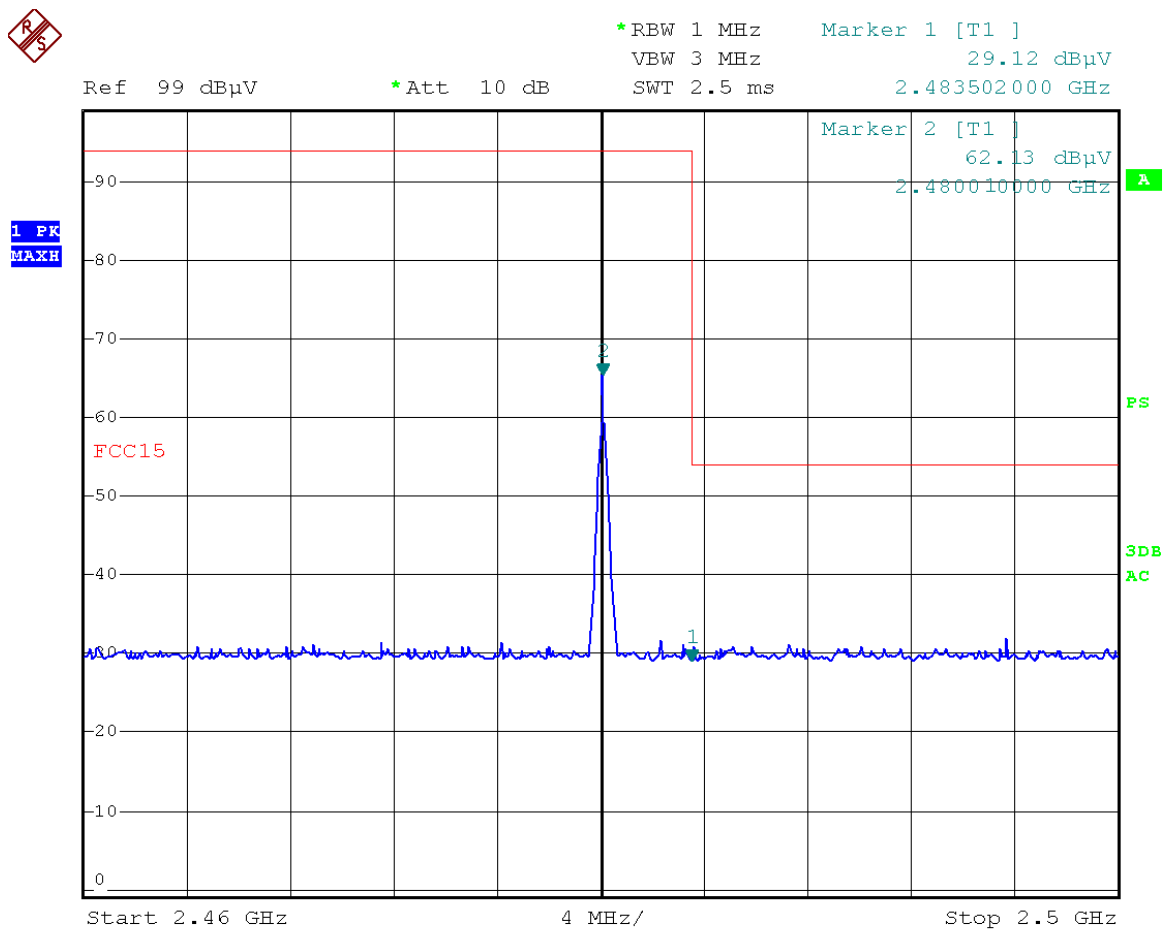

Copyright of this report is owned by Centre of Testing Service and may not be reproduced other than in full except with the written approval of the issuing Company.

CENTRE OF TESTING SERVICE CO., LTD.

Building F, Dachuang industrial park, No.379, Zhongshan Dadao, Guangzhou, China

Tel: +86-20-85543113 (32 lines)

Fax: +86-20-38780406

Complaint line: +86-20-85533471

E-mail: cts@cts-lab.com.cn

See Reverse For Terms And Conditions of Service



9 Deviation to test specifications

[NONE]

copyright of this report is owned by Centre of Testing Service and may not be reproduced other than in full except with the written approval of the issuing Company.

CENTRE OF TESTING SERVICE CO., LTD.

Building F, Dachuang industrial park, No.379, Zhongshan Dadao, Guangzhou, China

Tel: +86-20-85543113 (32 lines)

Fax: +86-20-38780406

Complaint line: +86-20-85533471

E-mail: cts@cts-lab.com.cn

See Reverse For Terms And Conditions of Service